

## ➔ Handbook for Agrohydrology (NRI)

 **(introduction...)**

 **Acknowledgments**

 **Summary**

**Chapter 1: Introduction**

 **1.1 The role of hydrology in agriculture**

 **1.2 Summary**

 **1.3 Project planning and practical problems**

**Chapter 2: Measurement of runoff**

 **(introduction...)**

 **2.1 Estimates of runoff**

 **2.2 Collecting runoff data**

 **2.3 Water level recording instruments**

 **Equipment costs**

 **Appendix A: Measurement of runoff**

**Chapter 3: Erosion and sedimentation data**

 **(introduction...)**

 **3.1 Soil erosion**

 **3.2 Field measurement of sediments (eroded material)**

 **3.3 Laboratory analysis**

 **Equipment costs**

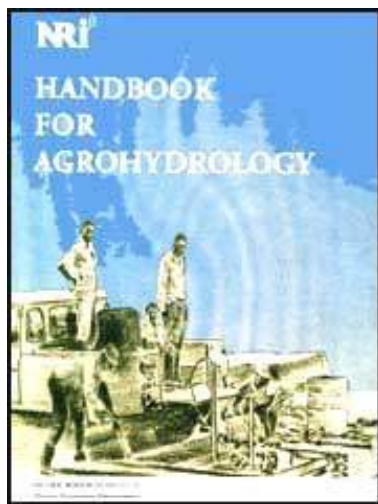
 **Appendix B: Erosion and sedimentation data**

- **Chapter 4: Rainfall and other meteorological data**
  - 📄 **4.1 Rainfall**
  - 📄 **4.2 Other meteorological data**
  - 📄 **Equipment costs**
- **Chapter 5: Soils and soil moisture data**
  - 📄 **(introduction...)**
  - 📄 **5.1. Soil classification and soil textures**
  - 📄 **5.2. Soil moisture**
  - 📄 **5.3 Infiltration**
  - 📄 **Equipment costs**
  - 📄 **Appendix C: Soils and soil moisture**
- **Chapter 6: Catchment characteristics**
  - 📄 **(introduction...)**
  - 📄 **6.1 Natural vegetation**
  - 📄 **6.2 Interception**
  - 📄 **6.3 Catchment size, slope and topography**
  - 📄 **6.4 Field orientation**
  - 📄 **6.5 Antecedent soil moisture conditions**
  - 📄 **6.6 Other catchment influences**
  - 📄 **Equipment costs**
- **Chapter 7: Water harvesting and field structures**
  - 📄 **7.1 Water harvesting**
  - 📄 **7.2 The design of bunds, channels and other field**

## structures

- 📄 **7.3 Surveys, marking out in the field and construction**
- 📄 **Equipment costs**
- 📄 **Appendix D1: Bund dimensions for various areas, slopes and soil types**
- ☐ **Chapter 8: Data analysis**
  - 📄 **(introduction...)**
  - 📄 **8.1 Statistical methods and data analysis**
  - 📄 **8.2 Non-statistical analysis of agrohydrological data**
  - 📄 **Appendix E: Data analysis**

[Home](#) > [ar](#).[cn](#).[de](#).[en](#).[es](#).[fr](#).[id](#).[it](#).[ph](#).[po](#).[ru](#).[sw](#)



## 📖 Handbook for Agrohydrology (NRI)

- ➔ 📄 **(introduction...)**
- 📄 **Acknowledgments**
- 📄 **Summary**
- ☐ **Chapter 1: Introduction**
- ☐ **Chapter 2: Measurement of runoff**
- ☐ **Chapter 3: Erosion and sedimentation data**
- ☐ **Chapter 4: Rainfall and other meteorological data**
- ☐ **Chapter 5: Soils and soil moisture data**
- ☐ **Chapter 6: Catchment characteristics**
- ☐ **Chapter 7: Water harvesting and field structures**

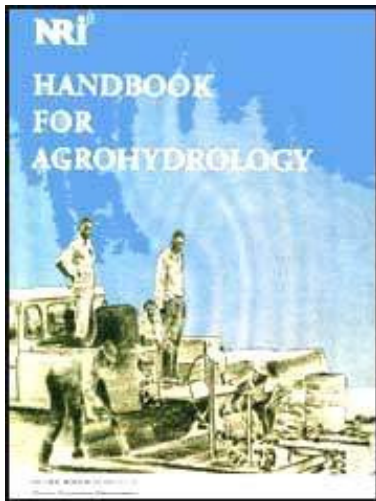
## □ Chapter 8: Data analysis

**S. Miller**






**NRI  
NATURAL RESOURCES INSTITUTE  
Overseas Development Administration**



[Home](#) > [ar](#).[cn](#).[de](#).[en](#).[es](#).[fr](#).[id](#).[it](#).[ph](#).[po](#).[ru](#).[sw](#)



### Handbook for Agrohydrology (NRI)

- ➔ □ Chapter 7: Water harvesting and field structures
  -  7.1 Water harvesting
  -  7.2 The design of bunds, channels and other field structures
  -  7.3 Surveys, marking out in the field and construction
  -  Equipment costs
  -  Appendix D1: Bund dimensions for various areas, slopes and soil types

**Handbook for Agrohydrology (NRI)**

**Chapter 7: Water harvesting and field structures**

**7.1 Water harvesting**

## **Background**

**The use of water harvesting for crops and the design and construction of channels, ridges and bunds are discussed in this chapter. Other applications such as the collection of water for domestic and animal watering are widespread and may be more easily achieved, but are peripheral to the coverage of this book. As well as providing supplementary water for an established crop, efficient water harvesting systems may allow an early start to the season in areas where farmers cultivate land away from their main residence and where they are dependent upon a supply of domestic water obtained from rainfall. Similarly, water harvesting can be used to promote early cultivation where farmers plant in soils with high bulk densities and soil wetness promotes easy ploughing and a moisture store for germination.**

**A convenient classification of water harvesting systems has in the past been regarded as somewhat problematic, a situation that may have more to do with the relative newness and dispersed nature of research into these methods of supplementing water availability, than with any inherent difficulty. This section on water harvesting covers three types of system that are classified on the basis of the scale of water movement and catchment size. As these two factors are the most important influences in determining the design, construction and the operation of the systems, this seems logical. It is inevitable that systems of one classification will grade into another and too much emphasis should not be laid on a strict adherence to the categorisation presented here or elsewhere, since all are to a greater or lesser extent arbitrary. Similarly there is no intent to enter into confusing discussions of water harvesting terminology, most of which is also arbitrary, though it is recognised that a clear and agreed definition of terms would be beneficial.**

**The importance of water harvesting lies in whether it can be used to improve**

**agriculture or not. The categories used in this chapter are:**

**Micro systems - very small scale methods of concentrating runoff over very small distances, perhaps less than one metre, but which involve the construction or use of a catchment and which are not methods of encouraging in situ infiltration.**

**Meso systems - systems that redistribute runoff usually over metres or tens of metres, but which always use runoff gathered within the area of normal field boundaries.**

**Macro systems - systems that use runoff from outside normal field boundaries.**

**Water control and harvesting systems that provide supplementary water for crops have been used in widely different areas of the world, perhaps since 2,500 BC or earlier. This guide does not present an analysis or description of these systems because they are unimportant, but because documentation is more complete elsewhere than could be achieved here. These systems were used in the past in the Middle East, North Africa, India and other areas which are now regarded as under- or undeveloped. In many instances it appears that water harvesting provided a vital economic basis for the existence of the societies that practiced it, though these societies no longer exist in their past form and water harvesting has been largely abandoned. Water harvesting, of several different kinds from large to small scale, is currently practiced in areas of the developed world, such as the USA and Australia, but in forms that are inappropriate for the economic and social conditions that prevail in under-developed countries which, arguably, are in greater need of increased agricultural production. The financial and technological inputs to water**

**harvesting in developed countries are impossible for poor countries to match. This chapter concentrates on methods of harvesting water that do not exclude poorer areas of the world.**

### **7.1.1 Considerations for the Implementation of Water Harvesting**

**In many respects, successful water harvesting is a very complex mix of climate, soils, technology, social organisation and economic factors. Some of these are listed below, with plus and minus aspects, so that an unquestioning credulity will not be automatically assumed toward this form of farm practice. Under many circumstances successful water harvesting is very difficult to achieve.**

<b>Factor</b>	<b>Aspect</b>	
Climate:	Encourages water conservation and useful concentration around plants	May only operate effectively during large storms when it is not needed
	Replenishes soil moisture reserve after periods of drought	Rainfall is unpredictable and totally uncontrollable
Soils:	Helps reduce erosion and soil loss	Induces erosion by runoff concentration
	Increases soil moisture, plant growth	Increases leaching in
	already nutrient	
	organic material and	
	biological activity	
	poor soils. It can cause	
	destruction and	

	water logging.	
Crops and	Encourages crop and other vegetation	Water harvesting catchments work least
Natural vegetation:	growth and thereby provides favourable microclimatic conditions, grazing, fuel .	efficiently when covered by the vegetation that they encourage
Human activity:	Can provide, food, water and money for poor farmers	Restricts other activities, demands labour, fertiliser and time

**There is little doubt that in some circumstances water harvesting can improve crop performance, but whether this improvement is widely attainable or, in some cases a priority, is another matter. In the general sense, it is useful to recognise that the technology of particular water harvesting systems cannot be applied haphazardly, many depend upon the physical constraints of availability of suitable materials at a precise locality and it is important to recognise that every system, to function properly, must be designed for the field upon which it is to work. An attention to detail is essential.**

## **Rainfall**

**On the whole, the tropical and sub-tropical semi-arid regions are those expected to benefit most from water harvesting. They have generally low rainfall totals and long periods of drought. The supplementation of water for crops appears to be an obvious advantage.**

**Long term values of annual average rainfall have been proposed as a pointer to areas that should benefit from water harvesting, but actually such values are of little**



**use. Rainfall in semi-arid areas is highly erratic and notoriously unpredictable. Large coefficients of variation exist for annual rainfall and the intensity-duration relations of individual storms. In many regions, for example Southern Africa, the start of rains is associated with complex weather systems entering from oceanic areas, and in this instance bimodal distributions of rain within the season are determined by the interaction of such systems with the Inter Tropical Convergence Zone. False starts and early closes to the rainfall season are common. In contrast, the start of the rainy season in West Africa is more reliably predictable.**

**Although relatively long term records of daily rainfall are available in such regions, the variability of rainfall distribution inevitably results in difficulties of prediction when the analysis of data is undertaken. High levels of spatial variability are also a problem. The fact that over many seasons an averaging effect occurs and totals for locations within a region may be similar, is of no comfort to a farmer who experiences such a dramatic shortfall of rain that crops fail. It is important to remember that farmers draw readily from experience and a negative experience with a water harvesting system that fails to work because of an unfortunate period of weather, may kill any interest for good.**

**The spatial and temporal variability of rainfall make the accurate assessment of water harvesting systems difficult to achieve from the results of short term projects. They make the prediction of extreme rainfall events difficult and demand that structures should be capable of dealing with large variations in the level of runoff. A level of over-design may be preferable, despite the extra cost. These estimates of extreme rainfall are translated to extreme runoff events, but runoff has a highly localised character; between regions, areas, fields and even within fields. The usefulness of any additional water supplied by this runoff will also vary according to**

**regional climatic conditions; for instance whether rain falls in summer or winter.**

## **Topography and Soils**

**Land form and topography are strong influences on the success of water harvesting. They influence, by interaction with other factors, the proportion of runoff that will occur from a given rainfall. They determine the manner in which overland flow collects, how it is distributed, the size and density of stream channels and thereby runoff velocities and peak flows. Although steep slopes give more runoff, other things being equal, the velocity of runoff increases (and in this sense the opportunity for infiltration decreases) by only the square root of slope. Increases of slope in low slope areas have a proportionally greater effect than similar increases in areas that have high slopes. The effects of microtopographic slopes is very important and was discussed in chapter 6.**

**Steeper slopes necessitate greater earth working to provide storage, but more water is retained over a smaller area. With structural limitations imposed by the nature of bunds and ridges, the horizontal distance between them is shorter on land with high slopes. Problems of channel erosion and over-topping with the subsequent destruction of bunds and ridges is a greater problem in areas of high slope. A more technical discussion of these matters is given in section 7.2, with recommended slope/area/bund lengths provided in Appendix D1.**

**Soil Me also exerts influence over water harvesting. Soil textural properties will determine rainfall infiltration and runoff production. Soil textures also control the structural capabilities of bunds (see section 7.2). Soil depth and soil texture will determine the extent of the soil moisture reserve; the amount of water that soils can retain for crop use. There is sufficient evidence that infiltration in very sandy soils is**

**extreme and that any water added simply passes beyond the rooting zone of crops by downward percolation. The soil nutrient status will control crop yield, should the limiting factor of water availability be overcome. Leaching and subsequent nutrient loss, in the commonly poor soils of arid and semi-arid regions, can pose a serious problem that is exacerbated by the addition of harvested water. Waterlogging, in reality a combination of poor gas exchange conditions and nutrient leaching, has been seen to adversely affect crop growth even in medium textured soils. A considerable amount of work has been undertaken to solve the problems of soil crusting in the semi-arid tropics. Crusting acts as an inhibitor of seed germination and as a promoter of runoff. However, soil crusting appears to be as much a function of tillage practice as of inherent soil characteristics. Soils that are tilled to a modest extent, such as those used for subsistence agriculture, are much less likely to suffer than those which are well worked on commercial farms or the research station. In some cases where enhanced runoff is desired, crusting has been regarded as beneficial.**

## **Vegetation**

**Vegetation cover is an extremely important factor in determining the runoff efficiency of a catchment, though authors attribute very different efficiencies to different covers and vegetation cover thresholds. Vegetation cover slows runoff velocities, encourages infiltration and inhibits soil erosion. On the other hand vegetation intercepts rainfall leading to its subsequent re-evaporation. Vegetation cover, retained on shedding areas to reduce soil erosion can be a serious problem, providing a vigorous seed bank for weeds and promoting the incursion into the crop area of invasive species. Once established, weed species that are difficult to eradicate will incur increased expenditure and difficulty for the farmer.**

## **Agricultural and Social Influences**

**Although in many respects these two factors cannot be regarded as separate, some agricultural practices may be looked at from the technical viewpoint only. The different water harvesting systems described below are aimed at specific crops. Some are most suitable for tree production, which depending on the locality, may be fodder trees, fuel or fruit trees. Some systems may provide grazing for stock while others are most suited to arable agriculture. Crop types will depend upon climate and tradition, though the traditional crops of semi-arid areas are millet, sorghum and (to a lesser extent) maize.**

**Improved husbandry is necessary to exploit any advantage of increased water supply. The careful timing of planting is essential to exploit optimum conditions of soil moisture. This care may take different forms in different localities; dry planting to await predictable rains, planting after a certain date or a combination of planting after a certain date when sufficient rain has fallen, in other areas.**

**Weeding is particularly important at the early stages after germination, to avoid excessive competition. However, the amount and quality of weeding will depend upon the manner in which crops are sown. Weeding is much easier and more effective in row-planted crops, but this practice is by no means universal and in some regions may traditionally be undertaken only by farmers with access to draught power. Thus certain farmers may be at a great advantage compared to others and a socio-economic factor may play an important part in what appears to be a straightforwardly agricultural problem.**

**Plant population densities, in general, are reduced by the constraints of water harvesting technologies. In dry years this is an advantage, but in wetter years the**

**full potential yield may not be realised and may limit the popularity of water harvesting. The tillering capacities of crop varieties can be adapted to take advantage of improved soil moisture conditions, or setbacks of the main growth due to exceptionally dry periods. Sorghum is especially suited to water harvesting since it can withstand both temporary inundation and drought. Inter or relay-cropping, whereby short maturity crops are introduced to take advantage of exceptionally good conditions are an important bonus that water harvesting systems can provide. Integrated systems, which promote the cropping of annual and perennial species, trees etc. may be suitable, but as yet have not been extensively tested.**

**Social and economic factors may be the most important constraints to the successful adoption of water harvesting systems, but integration of these systems into population groups may provide the basis of long term acceptance and benefit. In Malawi, soil conservation has a long history of practice and this provides the foundation of water control and harvesting, for many reasons. It has been promoted by an active extension group, but benefits for the farmers have been accrued by their own exertions. Some of the main reasons for the development of control and harvesting systems in Malawi can be summarised as follows:**

**Land slopes are high in much of the country and many years of trial and error have developed systems of water harvesting that are often individually tailored to a farmer's land out of sheer necessity. Such technologies are essential to conserve soil and water in these circumstances. In many areas the production of food crops for domestic consumption and the local market is crucial in a country of low economic development; the production of cash crops is a possibility while other sources of income are very few. Farmers live on or close to their land, in many areas soils are relatively deep and fertile and have a high water holding capacity. The**

**addition of organic matter does not involve high costs of transportation and mulching with residues is frequently observed. Markets are widespread and transportation distances and costs are low. Produce is of high intrinsic value (maize, fruit, vegetables).**

**Botswana, with its erratic and marginal rainfall, widespread cultivation at the subsistence level and low rural incomes appears to be a very suitable area for the implementation of water harvesting schemes. In these respects it is a relatively typical sub-Saharan, semi-arid agricultural setting. However, various social and economic circumstances mitigate against any increased input to agriculture. Distances are long and therefore transport costs are very high. There are few markets other than the government purchasing agency in the capital, Gaborone, and the main crop is low value sorghum, with some millet. Soils are generally nutritionally poor and thin. Research has shown that manure spread at less than 10 tonnes per hectare is of little value and its transport is costly. Rainfall is highly erratic.**

**In Botswana, the traditional organisation of family life necessitates the need for three homes. A winter season village home is occupied while the fields are bare fallowed. At the beginning of the wet season, the male component of the family take the cattle (the traditional source of wealth) to the drier west, once ploughing has been completed. The female members travel to the arable land once it is thought that enough rain has fallen to permit ploughing. They stay there throughout the growing season to farm. The distances between these localities may be hundreds of kilometres.**

**Such physical and social circumstances do not lend themselves to the development of a more intensive agriculture based on a ready supply of water made available by**

**water harvesting. The risks are high, the inputs great, the rewards are low and the social status of arable agriculture is negligible. Within the fastest growing economy in Africa, the opportunities exist for a farmer to earn more in cash in one month on a building site than in a good year on the land. Money is more attractive than sorghum. Botswana is by no means typical of sub-Saharan Africa, despite its annual average rainfall of about 500 mm, but serves as a good example of the strong influence that socio-economic factors can have on the suitability of water harvesting systems in agriculture.**

### **Examples in the Text**

**Many texts on water harvesting systems concentrate on their construction and land form aspects and there is a dearth of agronomic and soil moisture data to assess the value, the total or partial success or failure of these systems, beyond the fact that they can actually be built. The underlying expectation that prompts the use of water harvesting is that a lack of available water for crops is the crucial factor that limits yield. The situation is rarely so straightforward. This is particularly true in arid and semi arid regions where labour and financial inputs can only be small, because returns are low. The rainfall regimes of these regions are notoriously unpredictable. Moreover, the availability of water for crops may be severely limited during dry periods within a season that has a more than average rainfall. The rainfall of one season may be too low to grow crops, whereas the next season may be so wet that soils are badly leached and crops are physically destroyed by the surfeit.**

**For this reason, research into an example system from each category of water harvesting is described at the end of each section. These examples give comprehensive field data on rainfall, runoff, soils, slopes, crop yields and, when available, soil moisture. The number of examples is limited by the availability of**

**comprehensive information. However, this information is provided so that a personal assessment of typical systems can be made, bearing in mind that the successful capture and delivery of water to a designated area is only the first stage in growing crops. Apart from the obvious facts that systems need to work and be economic in construction, they need also to provide an environment within which plants can be easily sown, germinate and develop. They must also be viable from the farmer's point of view, so the difficulties experienced in the operation of these examples are also discussed.**

### **7.1.2 Micro Water Harvesting Techniques**

**Almost all farmers practice these techniques, each time they plough. They plant crops in furrows surrounded by plough ridges that direct any runoff down the slope of the ridge sides towards the crop. Even farmers who broadcast seed and then plough achieve, effectively, the same result. Farmers who plough on the contour do this most effectively of all.**

#### **a. Tied Ridge and Furrow (TRF) System**

**Tied ridge and furrow systems encourage runoff by increasing the size of the ridges and extending the catchment area adjacent to crops. An attempt is also made to give advantageous degrees of slope to the ridge side. The runoff that is collected within the furrow is then retained by a smaller secondary ridge that is placed at right angles to the primary ridges and "ties" them together. Thus the dual action of encouraging runoff while overcoming its redistribution by local microtopography is achieved.**

### **Construction**



**The construction of the ridges may be by hand labour or tractor and ridger, depending on the availability and cost of either alternative. The ridges may be constructed with indifference to the contour in low slope areas, but where slopes are greater than 2%, they are constructed as close as possible to the contour. A frequently-used ridge to ridge spacing is 1.5 m, with ridges built to 0.75m or so. The ties are hand-dug with a mattock or similar implement to 30-50 cm height, spaced according to the gradient, though distances of between 5 and 10 m are commonly used. Such microcatchments are extremely effective in retaining all the runoff of storms of 75 mm or so, and dimensions can be changed to suit particular circumstances.**

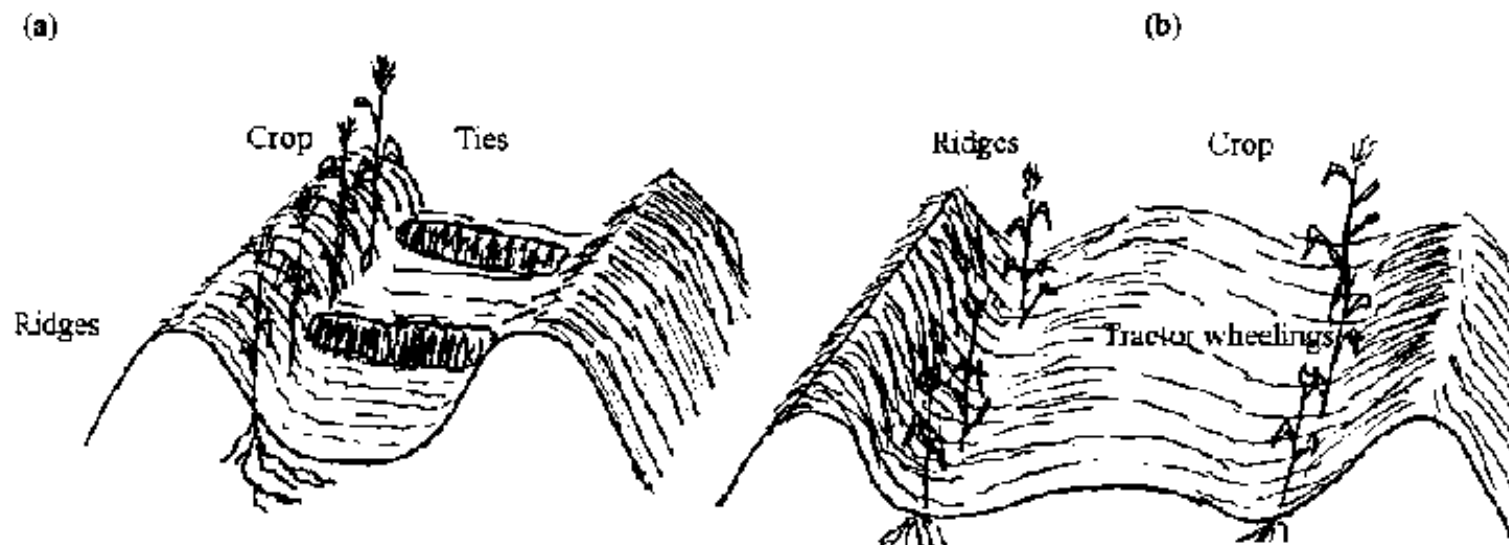
**The practical considerations of dimensions are important. When built by tractor, the spacing should be such that the tractor wheels run along the tops of the ridges during subsequent passes, to compact them and thereby improve runoff shedding, while avoiding compaction of the furrow and lower portions of the ridges where the crops will be sown. In most cases a ridger designed for the purpose is used to easily achieve the desired ridge height, rather than, say, a mouldboard plough.**

**Planting may be done in the furrow, or just above the bottom of the side of the ridges. The latter is frequently recommended because during ridge construction, top soil is removed and planting in the bottom of the furrow may be into subsoil. In addition, planting in the side of the ridge avoids any danger of waterlogging, especially during early stages of development, while allowing the crop root zone to develop adjacent to the area of enhanced soil moisture. However, soil compaction may arise during the ridging process, with attendant difficulties in the early stages of germination.**

**Modified systems of the basic TRF system have been used. An example is the wide**

**ridge bed which places ridges at 1.5 - 2.0 m apart, with a flat bed between. The tractor wheelings are located at the base, not the top of these ridges. The central portion of the bed is planted with two crop rows. This system exploits the water harvesting and retention aspects of the TRF system to a lesser extent, but exploits the advantage of having the crop planted into top soil, while still benefiting from concentrated runoff at the root zone. In both systems, runoff usually travels very short distances.**

**Figures 7.1 (a), (b) show the TRF and wide bed systems, respectively.**



**Figure 7.1: (a) Tied Ridge and Furrow (b) Wide Ridge Bed**

**It is important to recognise that TRF systems provide a lower planting density than traditional ploughing methods. This is advantageous where water is short and crops must share it, but the natural consequence is a low per unit area compared to many traditional systems, when conditions are good. As TRFs also represent a significant economic input for the farmer, it may be important to grow higher profit crops**

**(maize instead of millet or sorghum, for example), at least in part, to recoup some of this increased expenditure.**

**Modifications to orthodox bunds have led to the development of the "W" shaped catchment (in section) formed by alternating wide and narrow ridges, the former acting as shedding areas, the latter being used as the planting area. Inter-ridge distances are dependent upon wheel spacing. Planting densities maybe reduced in this, as other systems, but plants are lifted above the area of greatest saturation.**

### **Tied Ridge and Furrow Example:**

**The following example from Botswana, is cited in detail for several reasons. The most important is access to comprehensive data over two seasons at several sites. The second reason is that Botswana represents some of the most marginal agricultural land in any semi-arid region, with poor soils and a low and erratic rainfall. Agriculture is exclusively subsistence farming. TRF systems that were adopted came from reasonably successful trials in Zimbabwe (see below) and Malawi, where experimentation on vertisols and medium textured soils had shown not only that the system was excellent at retaining water, but also gave increased yields.**

### **Example 1. Botswana:**

Location:	SE Botswana, approximately 24° 30 S, 26° 00' E.
Rainfall:	AAR approximately 500 mm, but variable between 200 and 900 mm
Soils:	Loamy sand/ Sandy loam
Slopes:	0.5 - 2.0 %, marked microrelief up to 1.0 m above general field level

## Season 1: Rainfall, 692 mm for total season.

### Method

2 × 75 m strips were ploughed on.. On one a TRF was installed, on the other flat bed planting was done for comparison. These strips were aligned to cross the marked microtopography. Crop was sorghum (var. Segalane) in both cases.

### Results: Crop and Yields

The TRF crop failed to germinate and was replanted with maize (Kalahari Early Pearl) and thinned to 0.2 m (3300 plants ha<sup>-1</sup>). Growth / yield monitoring was therefore limited to within the strip, comparing performance of higher areas with and without ties, low areas with and without ties and a small flat bed transect planted at the same time as the TRF maize.

Within Transect Dry matter (kg m <sup>-1</sup> row)			Ridges + ties	Ridges - ties	Flat Bed
Total		No plants ha <sup>-1</sup>	29750	29932	56167
(a) Dry matter			(se 602)	(se 588)	(se 1253)
+ ties	0.61	No cobs ha <sup>-1</sup>	28544	27309	42833
- ties	0.49		(se 770)	(se 752)	(se 1602)
(b) Cob		Cob dry matter	1.80	1.36	2.25
Dry matter		(Mg ha <sup>-1</sup> )	(se 0.07)	(se 0.06)	(se 0.14)
+ tie	0.27	Cobs (pl <sup>-1</sup> )	0.97	0.92	0.77
- ties	0.20	Cob dry matter			
		(g pl <sup>-1</sup> )	61.3	45.9	40.5
		Total dry matter			
		(g pl <sup>-1</sup> )	137.6	109.2	109.7

**Table 7.1: TRF Maize production (areas + and - ties) and TRF versus Flat Row**

## **Planting**

**Comparisons showed that for high areas with ties, dry matter was greater than areas with no ties. The same was true for cob production, though the crop did not reach maturity.**

**Plants in TRF were more vigorous overall.**

**Comparisons with the small flat bed transect maize show that one of the main problems of TRF (and other water conservation systems) is that inherently low crop densities limit yield. Data are provided in Table 7. 1.**

### **Soil Moisture**

**Tensiometers were emplaced below the TRF system to monitor soil moisture behaviour.**

**Figures 7.2 (a ) to (d) show soil profile data at the end of the season (April) after rainfalls of 26 mm (24 th) and 16 mm (26 th). The effective rooting depth was 250 cm below ridge and furrow by 21st April, prior to rainfall. The infiltrated wetting front after the rain had reached 170 cm under the furrow 6 days later, whereas under the ridge it had not attained 70 cm by then. Lateral redistribution of wetting enable it to reach 130 cm by 11th May. The driest part of the soil surface was the side of the ridge, which may be regarded as expected, compared to the furrow and the flat ridge top.**

**This observation has important implications for planting in this position, which is preferred for reasons explained in the text above, and is consistent with difficulties encountered in early establishment of the crop.**

## **Season 2:**

**Rainfall, Site 1 505 mm for the whole season**

**Sites 2 and 3 657 mm for the whole season**

## **Method**

**Ridges were made or re-made at three sites as for the previous year and the comparison between TRF and traditional flat bed planting continued. Both sorghum and maize were planted, but replanting at site 3 was necessary 2 months later because of poor establishment and at site I 10 weeks after original planting because of destruction by a violent storm. A deep-ripping comparison was also carried out within the TRF sorghum treatment to assess the value of increased water percolation.**

## **Results**

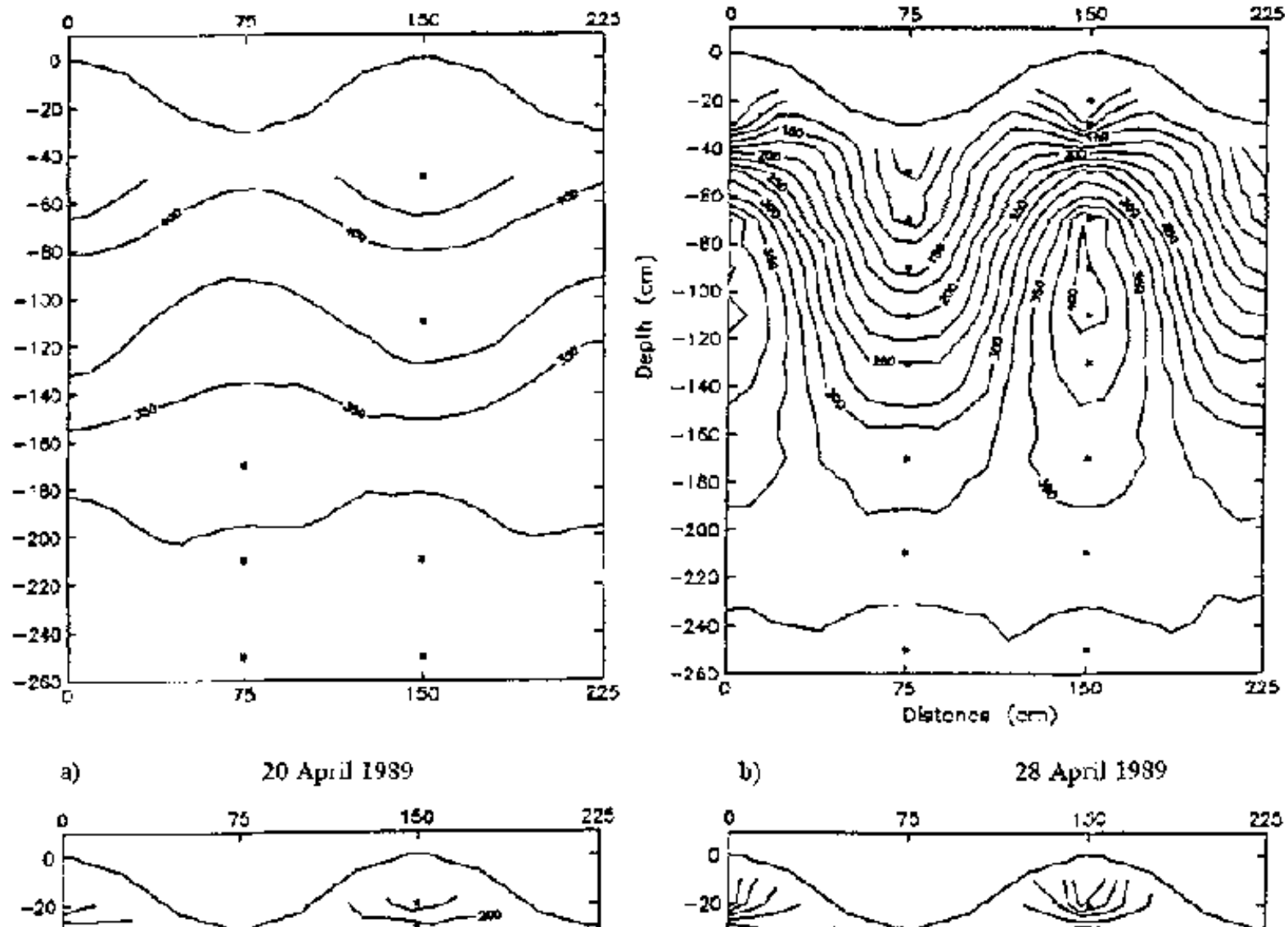
**With the exception of the ripped plots, the sorghum results are not presented because of late planting/poor grain filling. Analyses are compared within sites only.**

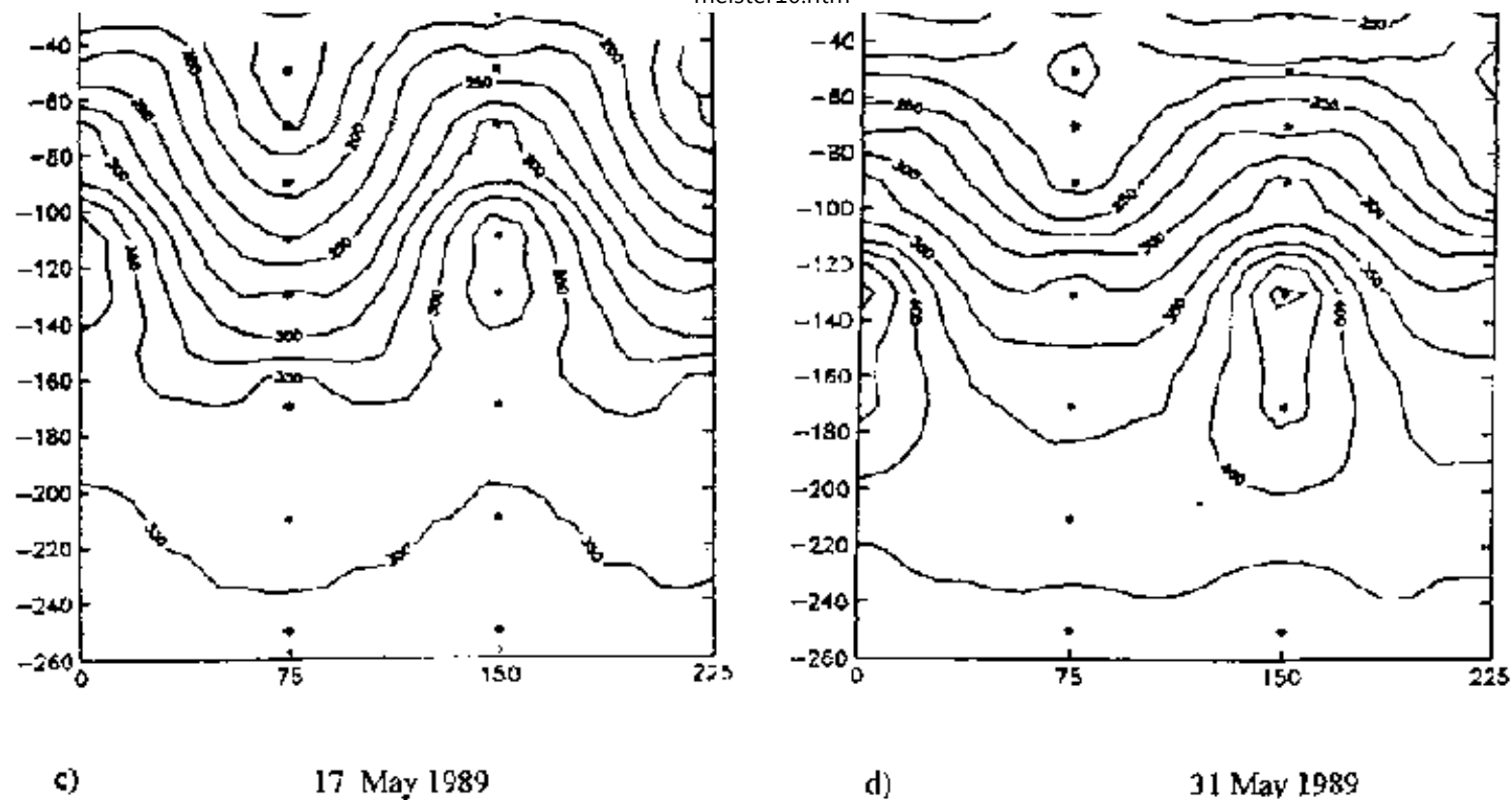
**Tillage was seen to make no significant difference to grain yield at any site although yields were greater for flat bed than TRF at sites I and 2. The reverse was true at site 3.**

**Total dry matter was significantly less for TRF at sites I and 2, no significance at 3, the trend was TRF flat bed.**

**Population densities confuse the issue (flat bed has a  $\times 2$  difference in row spacing**

from TRF) at sites 1 and 2, though the better performance of TRF at site 3 seemed due to better growth in individual plants as densities were similar. Growth monitoring indicated that TRF plants suffered a setback to early development, but recovered later. No significant difference found between the ripped and non-ripped rows. Table 7.2 gives components of yield.





**Figures 7.2 (a) to (d) Contours of Hydraulic Head Beneath Tied Ridges and Furrows After 42 mm Rain**



	Site 1		Site 2		Site 3	
	FBP	TRF	FBP	TRF	FBP	TRF
Plant popn. density (pl ha <sup>-1</sup> )	37132	* 25503	32833	ns 27360	30228	* 20625
No Cobs (ha <sup>-1</sup> )	31115	* 22520	29115	ns 25777	11180	ns 5857
Grain weight (Mg ha <sup>-1</sup> )	1.60	ns 1.24	0.69	ns 1.06	0.25	ns 0.06
Total dry matter (Mg ha <sup>-1</sup> )	3.58	** 2.47	1.46	ns 1.91	1.62	* 0.57
Harvest Index	0.43	ns 0.49	0.46	* 0.56	0.14	ns 0.57

\* 95% and \*\* 99% significant

**Table 7.2: Components of Yield for Maize at All Sites, TRF and Flat Bed Planting**

**Root studies showed that there were no statistically significant differences in root development between treatments, but several trends could be seen. Generally there were more roots at depth in the flat beds than TRF.**

**TRF roots tended to be concentrated near the soil surface and especially below the furrow, rather than below the plant perhaps due to ridge compaction and the greater availability of water in the furrow area.**

### **Conclusions for Both Seasons**

**In a total of 18 trials, TRF did not out-perform the traditional flat bed systems on the basis of yield, but it is important to note that during the period of trials, rainfall was greater than the average annual rainfall (AAR) and no "dry" season was experienced.**

**The system proved very effective at preventing runoff, but difficulties in crop establishment and development were found consistently, despite evidence of improved soil water availability.**

**Evidence showed clearly that the mechanical and construction aspects of this kind of water harvesting are not difficult to apply, but their successful application does not guarantee improved crop yield.**

**It is important to bear in mind that there are complex soil/crop/water relations inherent in water harvesting systems and it should not be assumed that they will work, simply because they prevent runoff and concentrate it in the crop root zone.**

**In general, the system was not popular with farmers who disliked its intensive, high input nature. The results of this work should be compared with that from Zimbabwe, below, which is in marked contrast.**

## **Example 2. Zimbabwe**

**The trials of TRF in Botswana were stimulated by the relative success of its application by the Agricultural Research Station at Chiredzi in low veldt Zimbabwe. Work in the period 1983-85 had found good results from TRF systems at various sites with high clay content soils. Results were not so good on lighter soils, as for the Botswana example above, and soil infertility and poorer water holding capacities were suspected. The results of later research, for the period 1986-1991, are summarised below.**

## **Methods**

**Three land forms, TRF at 1.0 and 1.5 m spacing, and 1.0 spacing on the flat and three levels of fertility were used. Sorghum, maize and cotton were the crops.**

**1 986-87 Fertility levels were zero; 8 t ha<sup>-1</sup> manure + 50 kg ha<sup>-1</sup> N; 8 t ha<sup>-1</sup> manure + 200 kg ha<sup>-1</sup> 8:14:7 NPK.**

**1987/88 to 1989/90**

**Fertility levels were zero; 100 kg ha<sup>-1</sup> NPK + 50 kg ha<sup>-1</sup> N top dressing; 200 kg ha<sup>-1</sup> + 50 kg ha<sup>-1</sup> top dressing.**

**These levels are referred to as low, medium and high.**

**1990/91**

**Fertility levels were increased to 4:**

**zero; 25, 50, and 75 kg ha<sup>-1</sup> + 150 kg ha<sup>-1</sup> NPK. These levels are referred to as 1, 2, 3 and 4.**

**Planting was done after at least 15 mm of rain, plants were thinned to 22,000 ha<sup>-1</sup> (maize) and 44,000 ha<sup>-1</sup> (sorghum).**

## **Results**

**In all seasons there were significant differences in yield between TRF and flat bed at most sites.**

**These differences were greater in years of low or poorly distributed rainfall.**

**The 1.0 m spacing TRF performed better than the 1.5 m, and this was attributed to a**

**greater loss of top soil in 1.5 m ridge construction.**

**The trend was for increased yield with increased fertility. This trend was stronger for maize than sorghum.**

**Poor rainfall distributions sometimes reduced the advantage of fertiliser applications.**

**A summary of results is given in Tables 7.3 and 7.4.**

1986-87 System	Site 1	Site 2	1987-88	Site 1	Site 2	Site 3
Flat	1387	1103		1224	1991	780
TRF 1.0 m	1677	1440		1119	2007	1150
TRF 1.5 m	1681	1425		914	1585	1045
se	85.9	62.8		137.5	181.0	99.1
Sig	P < 0.05	P < 0.05		ns	ns	P < 0.05
Fertility						
Low	1472	1005		955	1023	857
Medium	1632	1300		956	1795	867
High	1640	1667		1346	2765	1250
se	156.3	183.4		236.0	169.8	153.9
Sig	ns	P < 0.05		ns	P < 0.05	ns

**Table 7.3: Effects of System and Fertility 1986-87 and 1987-88, Grain Yield (kg ha<sup>-1</sup>) of Sorghum**

1988-89 System	Site 2	Site 4	1989-90	Site 2	Site 4	1990-91	Site 2	Site 5
Flat	1211	1010	2002	1131	784	583		
TRF 1.0 m	1651	1870	1377	2456	858	552		
TRF 1.5 m	1071	1635	1272	1976	681	525		
se	85.5	135.0	110.6	148.9	47.3	105.6		
Sig	P < 0.05	P < 0.05	ns	ns	P < 0.05	ns		
Fertility								
Low	1108	1395	1146	1618	515	473		
Medium	1271	1432	1389	2178	1087	701		
High	1553	1688	1243	2539	626	755		
Sig	P < 0.05	ns	ns	P < 0.05	P < 0.05	ns		

**Table 7.4: Effects of System and Fertility, 1988-89, 1989-90 and 1990-91 Grain Yield (kg ha<sup>-1</sup>), Maize**

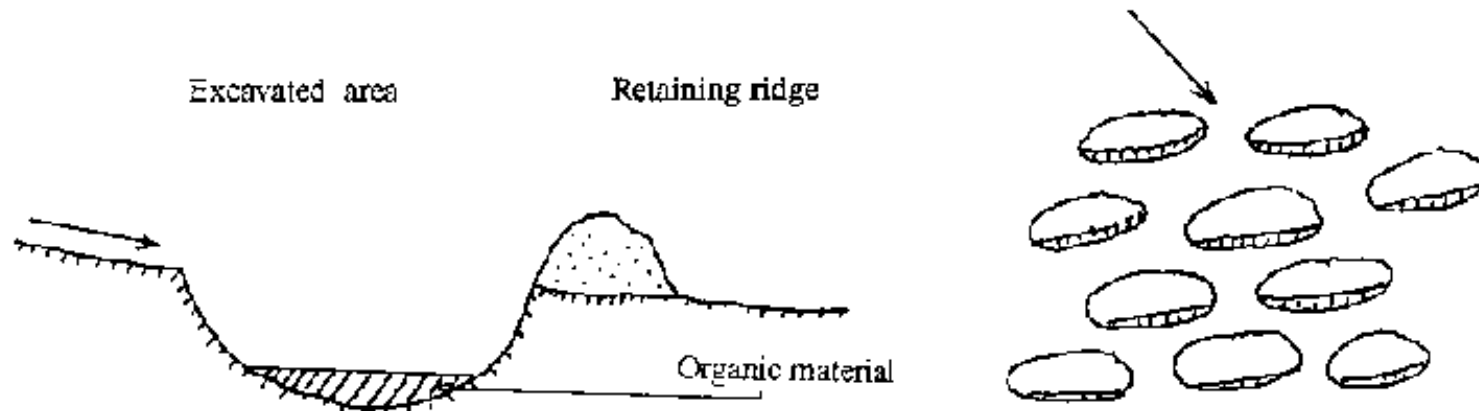
### 7.1.3 Meso Water Harvesting Techniques

**These systems are constructed and operate within the field and do not receive important amounts of water from outside.**

#### a. Zay

**"Zay" are shallow pits dug into the soil, usually about 25 cm in diameter and 10 cm or so deep. Soil fertility and structure are enhanced by placing organic matter, usually grass and/or manure, mixed with earth into the pits. Termite activity commonly reduces the organic material to a state whereby it can be readily exploited by crops and an improvement in infiltration may be achieved due to their burrowing activity. The remaining earth is used to construct a small bund around the pit on the down slope side. They are staggered about 1m apart. This is a revived**

**technique practiced in Burkina Faso to rehabilitate degraded land and is used in conjunction with stone bunds which reduce runoff velocities. Sorghum and millet are the usual crops. The labour input is large.**



**Figure 7.3: "Zay"**

### **b. Contour Bunds or Ridges**

**Contour bunds are used to prevent runoff and soil erosion and supplement soil moisture for crops, often, though not exclusively, in high slope areas. Where water retention is of primary importance, ties are used to prevent any loss of water by lateral flow. In cases where erosion control is more important and where increased soil moisture is a bonus, the ridges are constructed with a slight gradient (usually about 0.5%) to allow controlled drainage and render runoff velocities non-erosive. Ridges can be broken to provide drainage and thereby, rudimentary water control.**

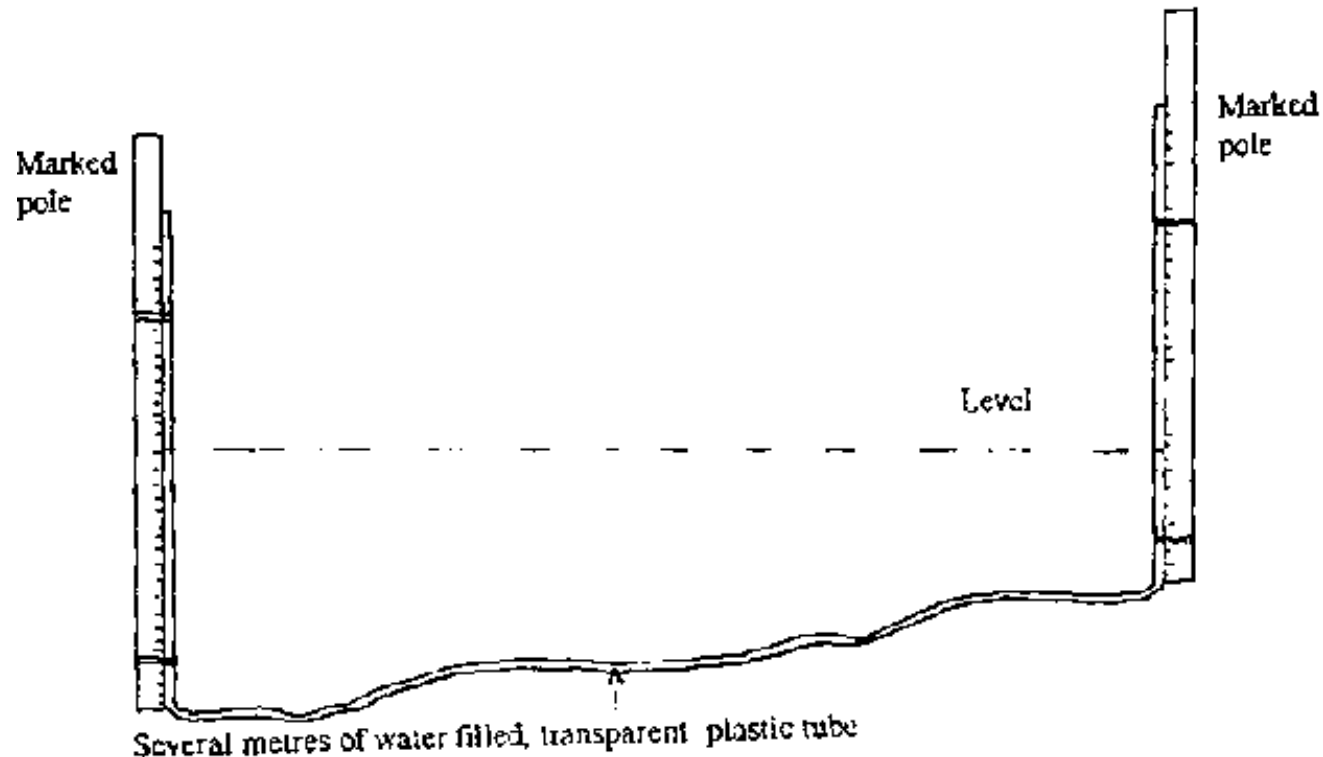
**The size and spacing of the bunds is dependent upon land slope, the practical limitations on bund height and the desired area of control. Construction may be by manual or mechanical means and the soil is excavated up slope of the bund which is under construction. Excessive depth of extraction must be avoided or the loss of top**

**soil suffers. Water naturally accumulates adjacent to the bund, where the top soil is removed. In areas that suffer from inundation, the crop is planted on the side of the ridges to overcome temporary waterlogging**

**Bund construction is widespread in Malawi, especially in the Highlands region, where it is used to control runoff from high slopes and reduce soil erosion; individual farmers modify the system according to their own particular needs. It is rarely observed in the Lower Shire Valley area where slopes are generally 1% or less. In the Baringo District of Kenya, contour bunds are not completely tied, but have small bunds that extend up slope, to reduce water loss.**

**One of the main problems with the implementation of contour bunds is the presence of microtopography which can lead to complex arrangements being necessary. Although a compromise can be reached by increasing the bund height at low lying locations, the natural tendency for runoff to collect in these areas increases the risk of over-topping, though it does allow for a simpler alignment of ridges. Once over-topping occurs, serious erosion can take place and the increased runoff volume imposes a threat to all down slope areas.**

**Figure 7.4 shows a simple plastic tube level that is easy and cheap to manufacture. It is now extensively used for the laying out of the contour system**



**Figure 7.4: Plastic Tube Levelling Instrument**

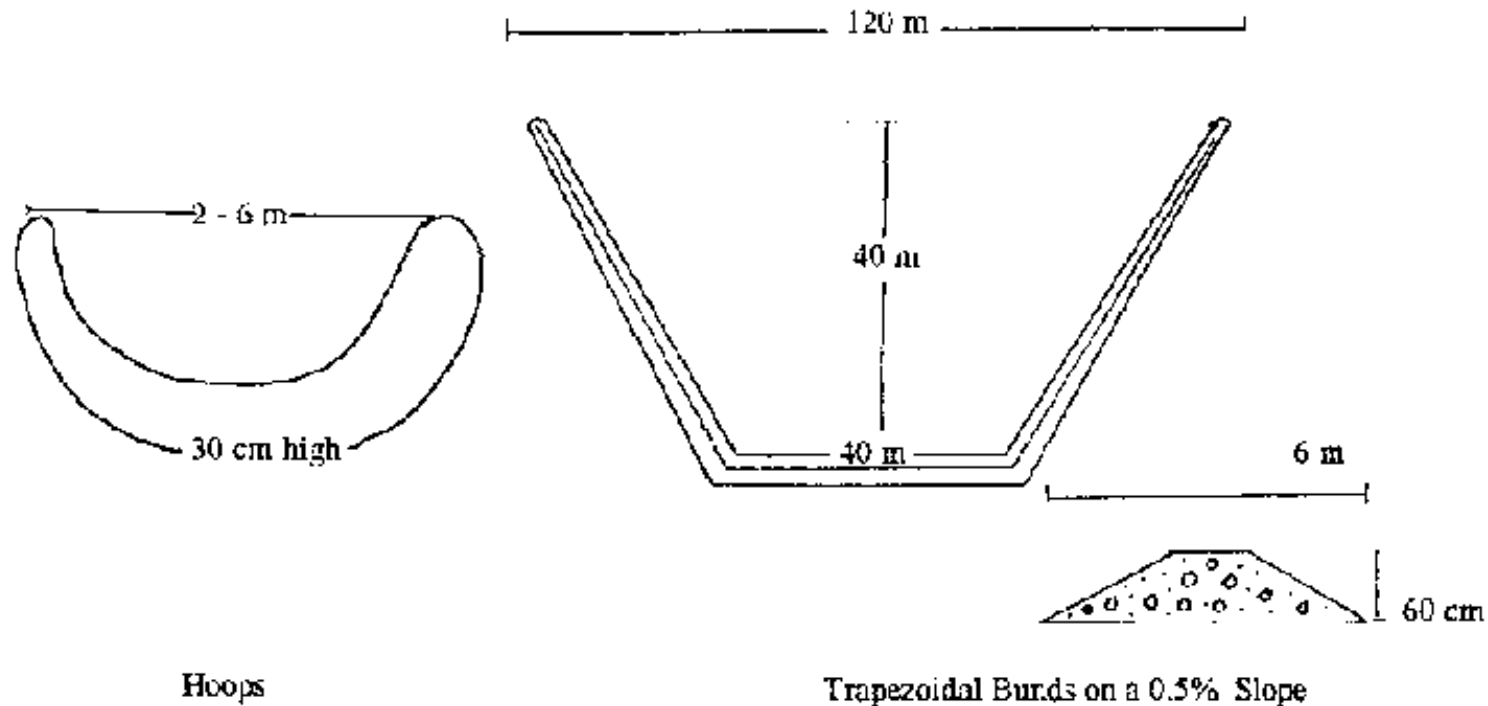
### **c. Hoops (Demi-lunes) and Trapezoidal Bunds**

**Like Zay, the hoop system could be considered a macro or off-field measure, as external runoff may enter it, but probably most water is captured from local runoff. The harvesting structures are crescent shaped bunds that enclose an arable area, though in Kenya they are used for land rehabilitation and fodder production.**

**Construction may be undertaken with the dug furrow that provides the bund material excavated downslope, thereby retaining all topsoil within the hoops. In other instances the furrow is dug on the inside of the hoop, thus increasing water storage. Material moved is in the order of 35 - 50 m<sup>3</sup> for each hoop, depending on**



## size and slope.



Hoops

Trapezoidal Bunds on a 0.5% Slope

### Figure 7.5: Hoops and Trapezoidal Bunds

Usually, the semicircular bunds, about 30 cm high, are between 2 to 10 metres across and may be placed in lines or staggered to manipulate the catchment to crop area ratio. These ratios are usually estimated as between 4:1 to 12:1, depending on hoop density. Adequate distance is left for surplus runoff to pass between the hoops. The open arms of the crescents face up slope. They are reportedly liable to breakage with large runoff events, though this may be avoided by reducing the catchment area.

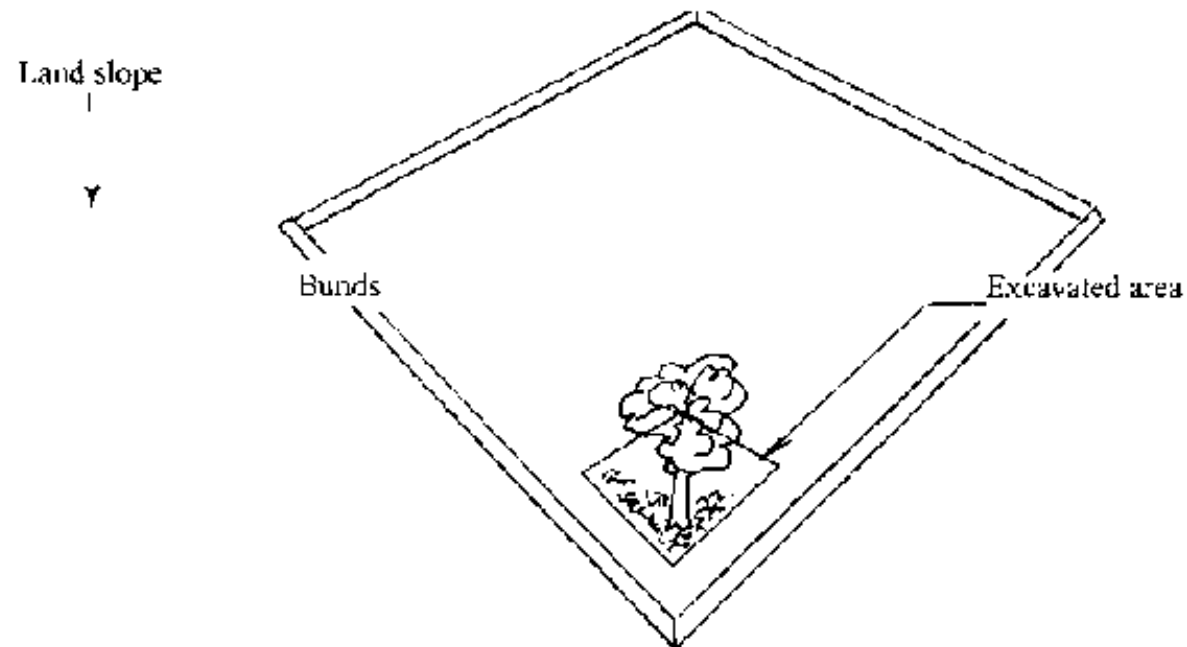
Trapezoidal bunds, as used in the Turkana District of Kenya are very similar in the manner of operation to hoops and demi-lunes, but are of a larger construction,

**though scale depends largely upon land slopes. The main bunds may be 60 cm high and 6 m in width, the tapered arm tips 120 m apart and 40 from the main basal bund. The main bund has a freeboard of about 30 - 40 cm, with the enclosed area filled with runoff when sited on low slopes. Construction is estimated to involve the movement of about 400 m<sup>3</sup> of soil on a 1% slope.**

#### **d. Diamond Shaped Basins**

**This system is often regarded as a micro catchment system. It consists of diamond shaped microcatchments oriented with one corner up slope. The opposite corner is excavated to form an area of water concentration, where the crop is planted. The crops are usually trees grown for fruit/nuts (Israel) or animal fodder (Kenya) which are situated in the down slope, excavated corner.**

**In some cases, V shaped catchments are used, thus saving labour and allowing the inflow of water from external sources. Dimensions vary, but sides 5 - 10 m long are usually constructed, depending on local rainfall conditions. Some research has been undertaken in The Negev Desert on optimal shapes and densities of implementation, but the diamond/V system remains most common.**



**Figure 7.6: Diamond Shaped Catchments**

### **e. Strip Tillage**

**Strip tillage is used for erosion control, in conjunction with vegetation cover manipulation and grassed bunds in some countries, though the advantages of strip tillage as a water harvesting system have been mooted.**

**Strip tillage is another contour system and in some respects is similar to the contour bund system described above. With strip tillage crops are planted in strips along the contour, downslope of a shedding area. Labour inputs are reduced, because ridges are not constructed. The natural land slope is used to shed runoff and strips may be made as wide as it thought suitable, no top soil is removed from the planting zone, so that the problems associated with this activity are avoided. Shedding strip to crop ratios of 1:1, 1:2 or 1:4 are typical, with a cropped strip of 5**

**m. As such, strip tillage represents a medium input system with no need for special equipment, but requires more management than most traditional systems. It is a system that is also open to manipulation on a seasonal basis, whereby fast growing crops can be planted on the shedding areas, should a season provide adequate rainfall.**

## **Strip Tillage Example: Botswana**

**Location: SE Botswana 24° 30' S, 26° 00' E**

**Soils: Loamy sands/Sandy Loams**

**Slope: 2 - 3%**

**Work was initially undertaken in farmers' fields on a randomised block basis, but it was quickly realised that strip orientation relative to the overall land slope and microtopography could not be achieved precisely enough to regulate surface flow. Two further approaches were made to study the system:**

- 1. Strip catchments on the crop station using bounded plots.**
- 2. A final experiment looked at runoff redistribution within crop areas from shedding strips.**

### **1. Bounded Plots**

**1989-90 and 1990-91**

#### **Method**

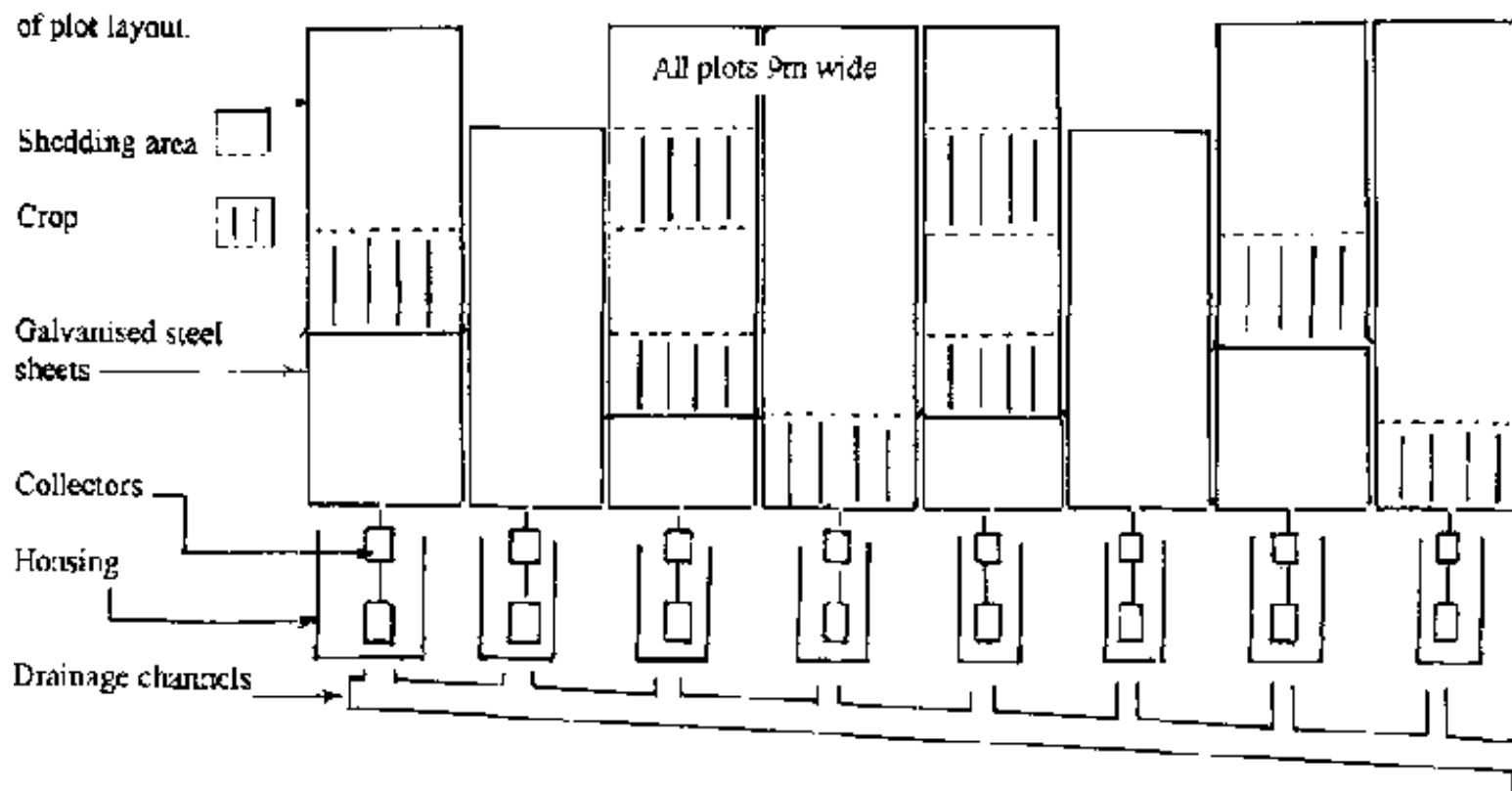
**Runoff:**

**Runoff was measured from 2 replicates of 5 m, 10 m, 20 m shedding areas. Two 20 m shedding areas with 5 m crop strips were also used to measure runoff through the crop. Multi-slot dividers were used.**

**For the 1990-9 season, two replicates of 5 m strip with 5 m crop and 10 m strip with crop, were added to the runoff experiment.**

**Agronomy:**

**Two replicates of 5 m strip with 5 m crop and 10 m strip with 5 m crop were planted separately from the runoff experiment. and the 20 m strip with 5 m crop were also monitored for crop performance. Figure 7.3 shows the details of plot layout.**



**Figure 7.7 Layout of Strip Tillage Shedding Catchments**

**A dead furrow, the natural consequence of ploughing was placed at the top of the crop to act as a sink for runoff and the shedding strips were kept weed-free throughout the season. In both seasons fertiliser (2:3:2) was added at rate of 400 kg ha<sup>-1</sup>, to overcome any spatial differences in soil fertility. Six rows, 0.75 m apart were hand-dug and planted with sorghum beginning 0.5 m from the dead furrow. The central 4 rows were harvested when the crop was mature. Runoff was measured on duplicate plots. Control plots with no runoff were added to the experiment during the 1990-91 season.**

## **Results**

**Table 7.5 gives the mean runoff values for the two seasons.**

	5m	10 m	20 m	5 m + 5 m crop	10 m + 5 m crop	20 m + 5m crop
1989-90						
	21	13	14	--	--	6
Rainfall (mm)	374	397	397	--	--	397
1990-91						
	16	14	13	13	11	8
Rainfall (mm)	273	433	314	456	456	575

**Table 7.5: Mean Runoff from Strip Tillage Shedding areas (% of rainfall)**

**The smallest runoff strips were the most efficient, but volumes were small. On average, the cultivated areas gained the following percentages of seasonal rainfall: 5 m + 3%; 10 m + 3 %; 20 m+ 7%. The effect of individual rainfall/runoff events may be more illustrative of the usefulness of the runoff supplements than seasonal averages. When these are studied, the following points can be noted:**

**Only the 20 m strips contributed large individual volumes to the crops equal to between 10 and 45 mm or about 2 to 10 days' water lost to evapotranspiration, during the summer growing season.**

**Almost half the runoff passed through the crop strip and a "cascade" effect could, potentially, result. The construction of bunds down slope of the crops would be advantageous.**

Variable	1989-90				1990-91			
	Control	5 m	Treatment 10 m	20 m	Control	5 m	Treatment 10 m	20 m
Plant popn. (pl ha <sup>-1</sup> )	--	47371	42508	42092	45202	46662	50213	48438
Grain weight (Mg ha <sup>-1</sup> )	--	2.46	2.24	2.60	2.06	1.88	1.99	2.06
Total dry matter (Mg ha <sup>-1</sup> )	--	5.35	5.45	5.37	4.36	4.07	4.38	4.06

**Table 7.6: Components of Yield for Final harvest**

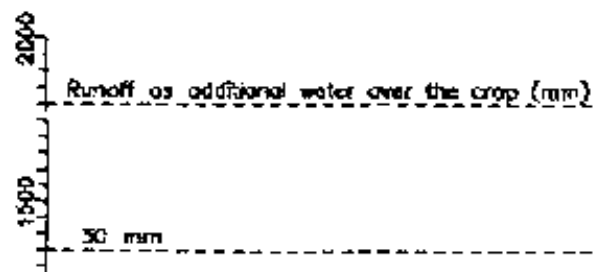
**The even redistribution of runoff to the crop was difficult to achieve.**

**A large labour input was necessary to keep the strips weed-free and maintain runoff efficiency. Despite differences in received water, analysis of variance showed no significant differences in any component of crop yield, on a planted unit area basis in either season.**

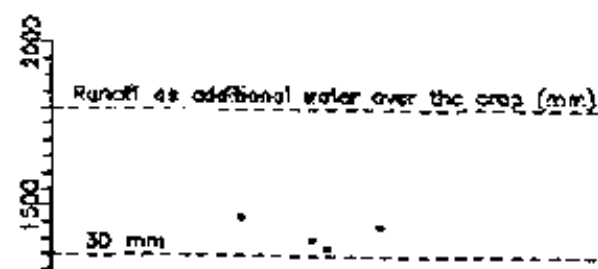
**Water did not appear to be limiting in either season, though yields seemed to be smaller in the wetter 1990-91 season.**

**Figures 7.8 (a) to (d) show rainfall against runoff on an individual event basis.**

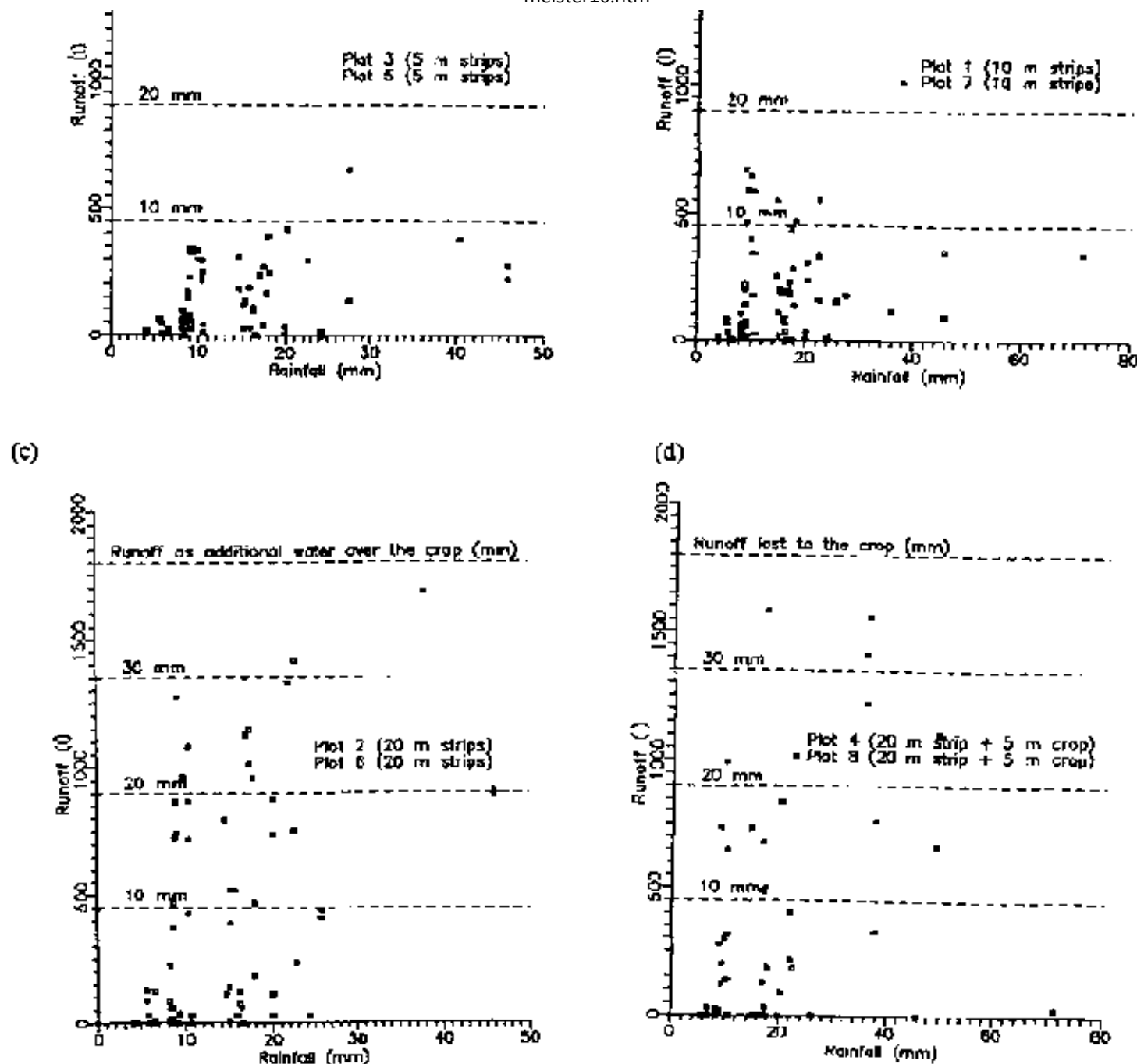
(a)



(b)







**Figures 7.8 (a) to (d) Rainfall versus Runoff on an Event Basis, Strip Tillage 1989-90**

## **and 1990-91**

**Edge effects were seen in 1989-90 (dry) where the marginal rows gave significantly more yield.**

**When yields on a field basis were considered, a great difference was seen between the performance of the three crop to strip ratios. Results showed that the 5m strips would need to double yields to equal those of the non-runon control, the 10 m × 3 and the 20 m × 5. This seems to be a serious disadvantage, especially in favourable rainfall years, of many water harvesting systems which inevitably control overall field population densities.**

### **2. Redistribution of Runoff on Crop Areas**

**The distribution of harvested runoff is an important issue for all but the smallest systems. Runoff flows along channels and collects in low areas, its natural inclination is not to redistribute itself evenly for the benefit of crops. This can lead to problems of uneven crop growth, differential waterlogging and nutrient leaching.**

#### **Method**

**Ten planted, 10 × 5 m experimental plots were installed with different-sized runoff strips placed up slope to provide runoff. The runoff areas were 0, 10, 25, 50 and 100 m<sup>2</sup>, covered with plastic to ensure maximum shedding. Fertiliser (2:3:2) was applied at 400 kg ha<sup>-1</sup> and 20 rows of maize were sown 0.5 m apart. Crops were harvested before maturity because of lodging due to infestations of ants in the first season and because of late sowing in the second season.**

**Rainfall for the two seasons was about 10% below and 10% above average respectively: 1989-90 - 449 mm and 1990-91 - 572 mm.**

## **Results**

**No significant differences were seen between plots for any season . But a trend of inverse production of dry matter with runoff area was seen. Physical damage and yellowing was seen on areas with the greatest runoff. Stunted and yellow plants were seen closest to the runoff areas. Growth distributions supported the hypothesis that too much water damaged plants. Plants recovered noticeably during dry spells.**

### **7.1.4 Macro Water Harvesting Techniques**

**Off field-water harvesting systems have one great potential advantage over smaller systems: they are capable of exploiting much larger amounts of runoff by utilising much greater catchment to crop area ratios. This does have a concomitant problem: larger flows require more secure control, because their destructive capabilities are considerable.**

**Bund, channel and dam structures form the major components of such systems which fall into two general categories: runoff collection from broad, flat catchments by the intervention of stone or earth bunds, and the utilisation of water from ephemeral stream channels. In some cases, hybrids may evolve.**

#### **a. Runoff Collection from Broad Flat Catchments**

**The interception of what is essentially sheet overland flow necessitates the**

**construction of large bunds, which concentrate runoff to an area of cultivation. These structures are usually aligned for the most part, on the contour.**

### **b. Stone Contour Bunds and Lines**

**As currently practiced in Burkina Faso and Niger, stone bunds are discontinuous lines of stones, piled to extend perhaps 10 - 20 m, with a height of about 30 cm and laid in a trench to aid stability. Their action is to reduce runoff velocity by means of their permeability rather than to block the flow of runoff. This reduction in velocity encourages infiltration, reduces erosion and increases the deposition of suspended material. Unlike earth bunds, they allow the passage of water and are not so easily washed away. Given suitable material they are easy to construct and need no special equipment but a simple levelling tube. Farmers may depend on mechanised transportation of the material to site. Their location is usually on low slope areas in cultivated fields or on highly degraded land under rehabilitation. They are often used in conjunction with zay.**

**Rock dams are a logical development of stone bunds and are used in stream channels, often where soil erosion is a problem. The extremities of the dams extend beyond the channel on to the surrounding land to prevent lateral erosion, giving an overall length of 50 - 300 metres. The gully part of the dam may be well over 1 m in height, but the extensions are usually lower, with a width of 2 - 4 m. The down slope side of the bund is usually built to a 1:2 gradient (vertical:horizontal) while the up slope side is 2:1, giving stability to the structure. The largest stones are used on the outside and the inner portion of the bund is infilled with smaller grade material.**

**The collection of soil debris up slope of the dam can be considerable and crop yields**

**of 1.9 t ha<sup>-1</sup> upslope of the dam have been reported, though the areal extent of such yields is not declared. The main technical considerations in addition to the gradients of construction and the use of larger stones for the outer casing, are laying the foundations in a trench .**

### **c. External Runoff with Enclosed Crop Areas**

**The collection of runoff from external sources, in a way similar to trapezoidal and hoop systems can be used to exploit large external catchments and to water more extensive areas of crop. Diversionary bunds are built diagonally to the contour, to collect runoff from an up slope area. This runoff is directed by the bunds to the crop area. It is usual to enclose this area with bunds, to prevent the loss of the harvested water. Examples of this general type are the " Caag" and "Gwen" systems of Somalia and the "Teras" of Sudan.**

**The redistribution of water within the cultivated area may be achieved by ridges and furrows, but in cases where runoff volumes are large, internal bunds and spillways are used. The bunds retain the water up slope until the first section of the crop area is filled, when the spillway freeboard level is attained the runoff passes over to the next section. Eventually the whole of the cultivated area is filled and any surplus water is allowed to drain via spillways positioned in the most down-slope enclosing bund.**

**Bunds are made of earth, sometimes with stone cores and the spillways and adjacent areas are made with stone or cement blocks to prevent erosion. Catchment and crop areas may be defined to suit the locality and farming practice.**

**An example of this general system is given below.**

## **Off-field Water Harvesting Example: Botswana**

**Location: SE Botswana, 24° 30 S, 26° 00 E**

**Soils: Loamy sands/sandy loams**

**Slope: 0.5 - 1.5%**

**Off-field water harvesting involves the collection of runoff from a source external to the field under cultivation, the control and direction of this runoff and its subsequent redistribution over the crop area.**

**During the season 1986/87, an off-field water harvesting system was installed at Kgapamadi, approximately 15 km north of Gaborone by the International Sorghum and Millet Collaborative Research Program (INTSORMIL). The main aims of the research were to establish whether yield improvements could be obtained by increasing soil moisture availability and to estimate the reliability of receiving agronomically useful runoff.**

### **Method**

**The water harvesting system consisted of a 0.5 m high earth bund that intercepted runoff from a shallow natural drainage channel and conducted it to a runon area of approximately 0.5 ha, enclosed by 0.3 m earth bunds. Spillways in the bunds determined flooding depth and allowed controlled drainage of excess runoff. Bunds were built by a tractor-drawn ridger and manual labour. Soils in the runon area were classified as Chromic Luvisol with an argillic B horizon. Sand, silt and clay contents were 75, 11 and 14%, respectively in the top 40 cm; and 70, 9 and 21%**

**between 40 and 150 cm. The average soil water holding capacity was 12%, by volume and soil depth exceeded 150 cm. Figure 7.9 shows a plan of the water harvesting field, channels and bund structures and immediate surroundings.**

**Agronomic data were collected for the seasons 1986-7, 1987-88 and 1988-89. Runoff was measured by a different project for the 1988/89, 1989/90 and 1990/91 seasons by 0.90 m H-flume and water level recorder. Daily rainfall and intensity data were also collected. Because the overlap of hydrological and agronomic/soil moisture data is limited to one season, they are treated, to a large extent, separately.**

## **Hydrology**

**Table 7.7 gives runoff intercepted and measured by the flume, which are the maximum Bows available for water harvesting. However, it is unlikely that these flows could be transferred to the runon area without some small losses due to infiltration in the transmission channel.**

**The potential amounts of additional soil moisture provided by the runon were very large in most cases. Four, two and six events for each season respectively, were measured as large enough to more than fill the soil profile. The timing of these runoff events is also important; in each season runon volumes were sufficient at the beginning of the season (October and November) for flooding to be practiced by the farmer. Having a deeply wetted soil profile in early season has been shown to be highly advantageous.**

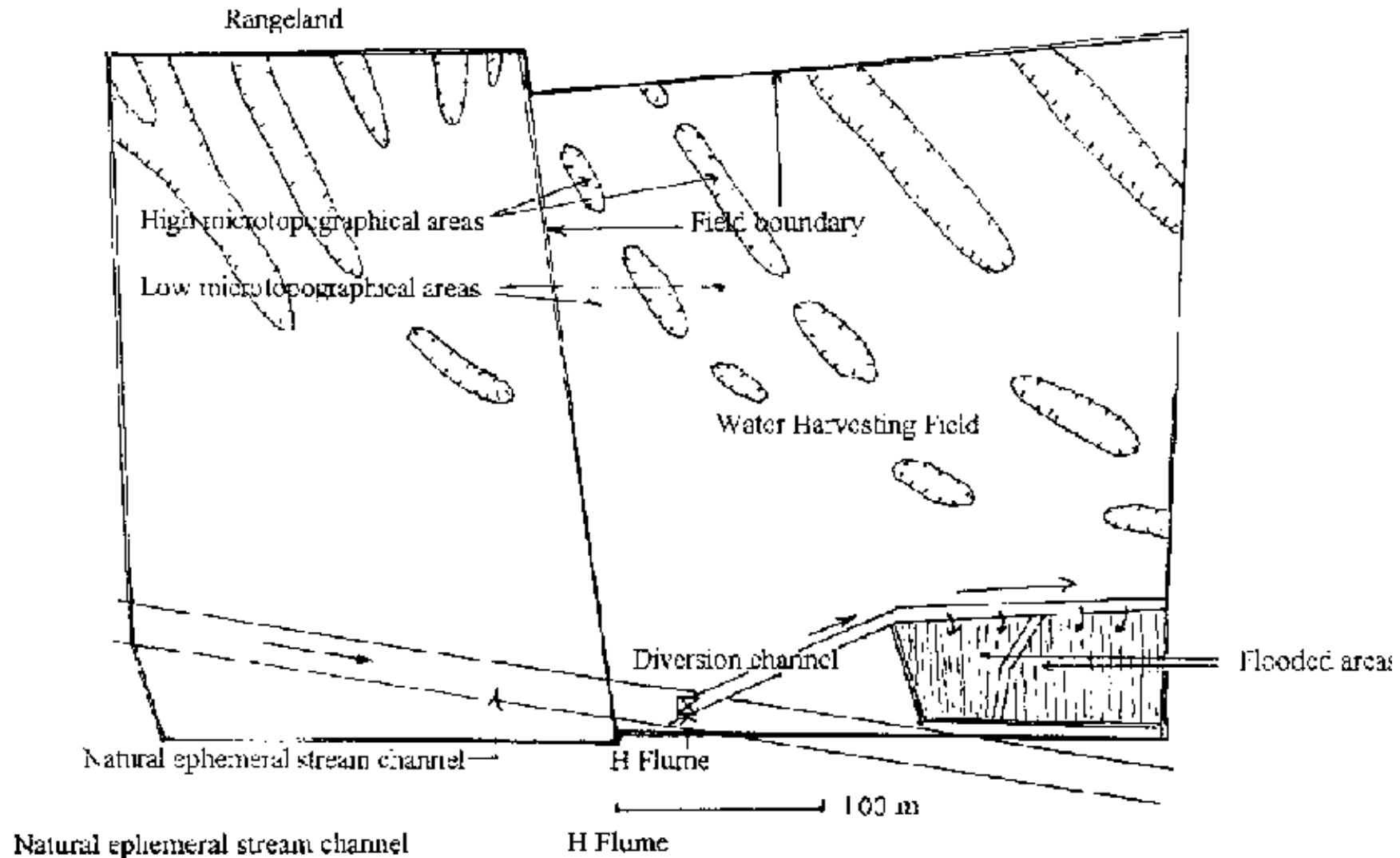
**On average, rainfall in the range 10-15 mm was sufficient to give some runoff, though it was clear that larger rainfalls (>20 mm) were needed to produce useful**

**runoff amounts. The likelihood of receiving one 20 mm daily rain was calculated from historical rainfall data to be 82% during November-December, 90% during December-January and during grain-fill, 94%.**

**The precise area of the catchment was difficult to calculate as the smallest scale maps available only provided 15m contour intervals, which indicated an area of about 400 ha. From field observations this was felt to be a gross overestimate. The use of 1:7,000 air photos indicated a catchment between 40 and 100 ha, with a variable contributing area, depending on storm size.**

**Overall percent runoff was low only a few percent, sometimes less, of storm rainfall.**





**Figure 7.9: Off Field Water Harvesting Scheme**

Date	Rainfall (mm)	Runoff (m3)	Runoff (mm)	Date	Rainfall (mm)	Runoff (m3)	Runoff (mm)
24.01.89	19.6	54		13.04.90	17.8	10	2
		11					
15.02.89	48.4	1108	222	22.12.90	12.8	24	5
22+23.02.89	54.6	2028	4006	25.11.90	49.6	4004*	801
26.03.89	18.8	26	5	02.01.91	16.6	86	17
15.04.89	13.2	4	1	05.01.91	15.0	8	2
27.04.89	18.2	950	190	07.01.91	22.2	263	53
29.04.89	29.2	1344	267	07+08.01.91	8.0	230	46
06.1.89	31.0	273	55	17.01.91	23.2	579	116
25.11.89	35.0	1649	330	25.01.91	34.0	565	113
27.11.89	12.6	165	33	09.02.91	27.2	3487	697
08+09.12.89	28.6	745	149	15.03.91	56.0	895	179
22.12.89	19.2	8	2	16.03.91	9.8	43	9
13.03.90	19.6	9	2	17.03.91	15.2	1479	296

\* unmeasured losses due to burst bunds. \*\* runoff in mm if spread over the crop area

**Table 7.7: Runoff Received by the Water Harvesting Scheme, 1988-89 to 1990-91**

## Agronomy

The agronomy experiments were undertaken in co-operation with the farmer and cultivation consisted of mouldboard ploughing after harvest and before planting. Sorghum variety "Segaolane", (Sorghum bicolour (L) Moech) was planted 5 Nov. 1986, 7 Dec. 1987 and 2 Nov. 1988 (replanted 3 Jan.), in the runoff area. Control plots were planted on the same days in the field, except for 1986, when it was planted 23 days later. All plots were weeded and birdscaring was employed as necessary. At maturity, sorghum plants were harvested, counted and threshed with grain weights adjusted to 12.5% moisture. Fertiliser effects were evaluated each season. During 1986-87 two fertiliser experiments were established after emergence in a low area where crop growth was poor. In separate experiments sorghum and maize (*Zea mays*, var. "Kalahari Early Pearl") were grown at 0 and 83

**kg ha<sup>-1</sup>, in a 2x2 factorial replicated three times. Single row plots 10 m long were used.**

**In 1987-88 in the runon area, a combination of 10 t manure ha<sup>-1</sup> and 30 kg P ha<sup>-1</sup> was applied to a single 700 m<sup>2</sup> area. Yield was measured on six 20 m<sup>2</sup> plots in the fertilised area and three 40 m<sup>2</sup> plots in the unfertilised area. Two 40 m<sup>2</sup> plots in the field were used as controls. In 1988-89 an experiment was conducted with two treatments, no fertiliser and a compound supplying 45 kg N, 30 kg P and 15 kg K ha<sup>-1</sup>. Three replicates were made in the runon area, two on the field. The fertiliser was broadcast onto 250 m<sup>2</sup> plots immediately prior to sowing. Table 7.8 gives details of the size and number of experimental plots.**

Season	Runon area		Field	
	No. plots	Plot size (m <sup>2</sup> )	No. plots	Plot size (m <sup>2</sup> )
1986/87	5 <sup>*</sup>	50	2	76
1987/88	9 <sup>#</sup>	20	4	40
1988/89	8	220	7	35

\* includes fertiliser plot which had an area of 120 m<sup>2</sup>. # six fertilised plots and three control plots  
Information on flooding dates is given in Figures 7.10 to 7.12.

**Table 7.8: Number and Size of Plots, Runon Area and Traditionally Managed Area**

## Results

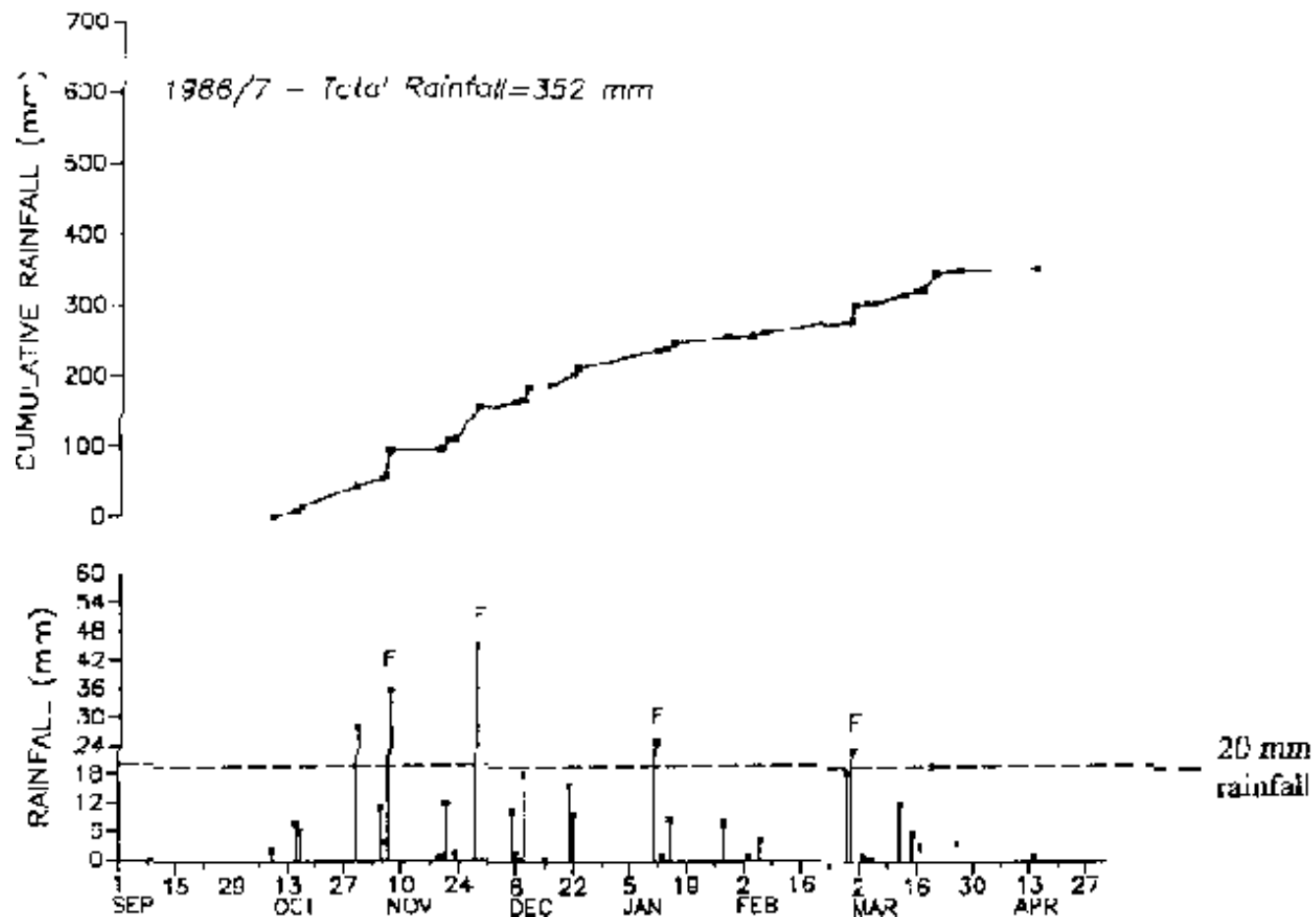
**Sorghum grain yield was greater in the runon area for the seasons 1986-87 and 1987-88 (Table 7.9). Rainfall was 36% below the long term average in the first season and 11% above in the second, but it was poorly distributed in both seasons. During 1986-87 (Fig. 7.10) only 48 mm fell between 46 and 103 days after planting**

**(22 Dec. to 26 Feb.) and in 1987-88 (Fig 7.11) only 13 mm was received between 16 and 63 days after planting (23 Dec. to 8 Feb.). The 2 Nov. planting of the 1988-89 season was replanted on 3 Jan. and the lack of yield differences probably reflects favourable rainfall (Fig. 7.12) and weather conditions after replanting.**

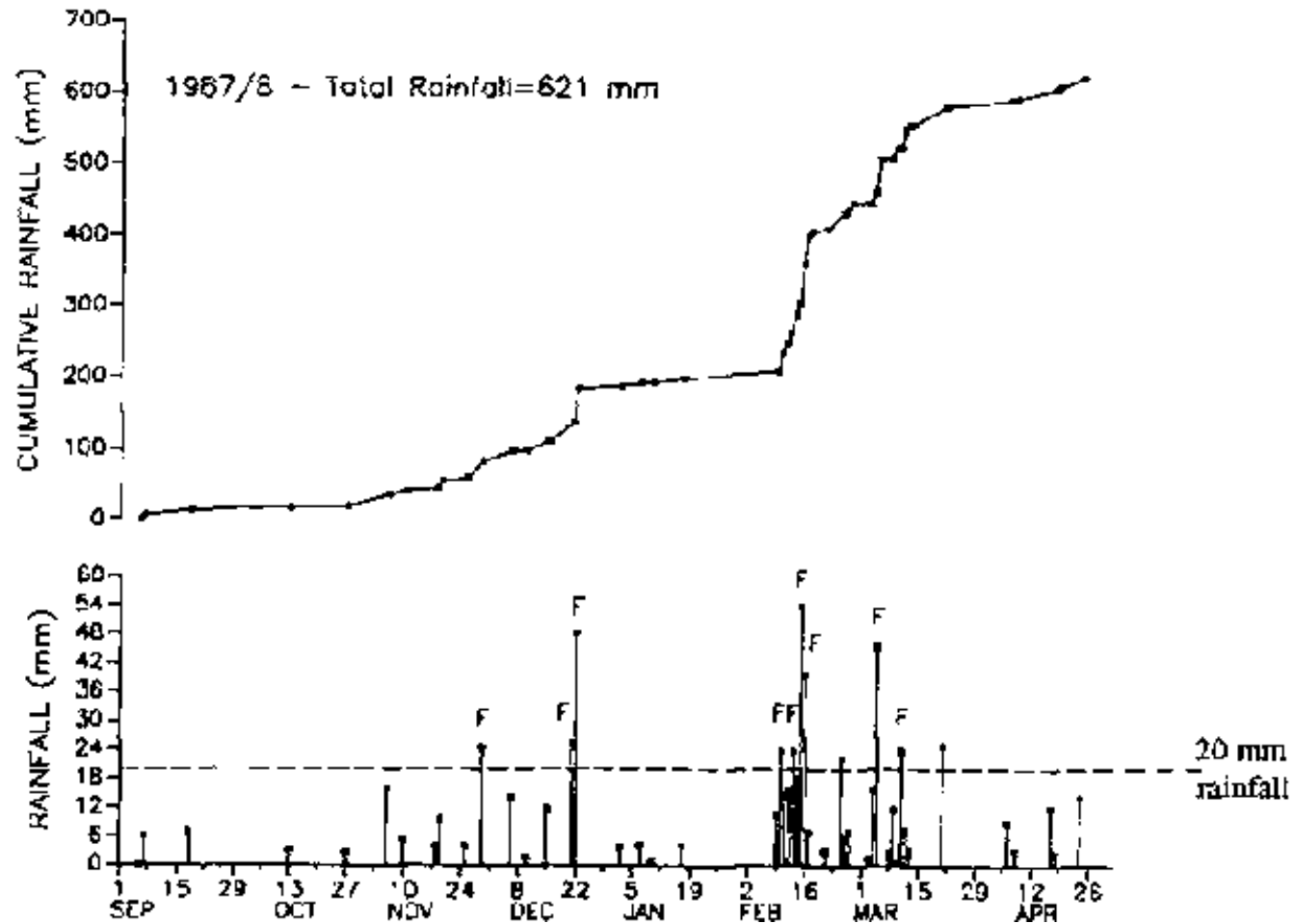
Plots	Yield (t ha <sup>-1</sup> )		
	1986/87	1987/88	1988/89
Control (field)	0.40	0.83	1.20
Runon area:			
without fertiliser	0.50	1.80	1.20
with fertiliser	0.78	2.20	-

**Table 7.9: Sorghum Grain Yield in Runon and Control Plots**

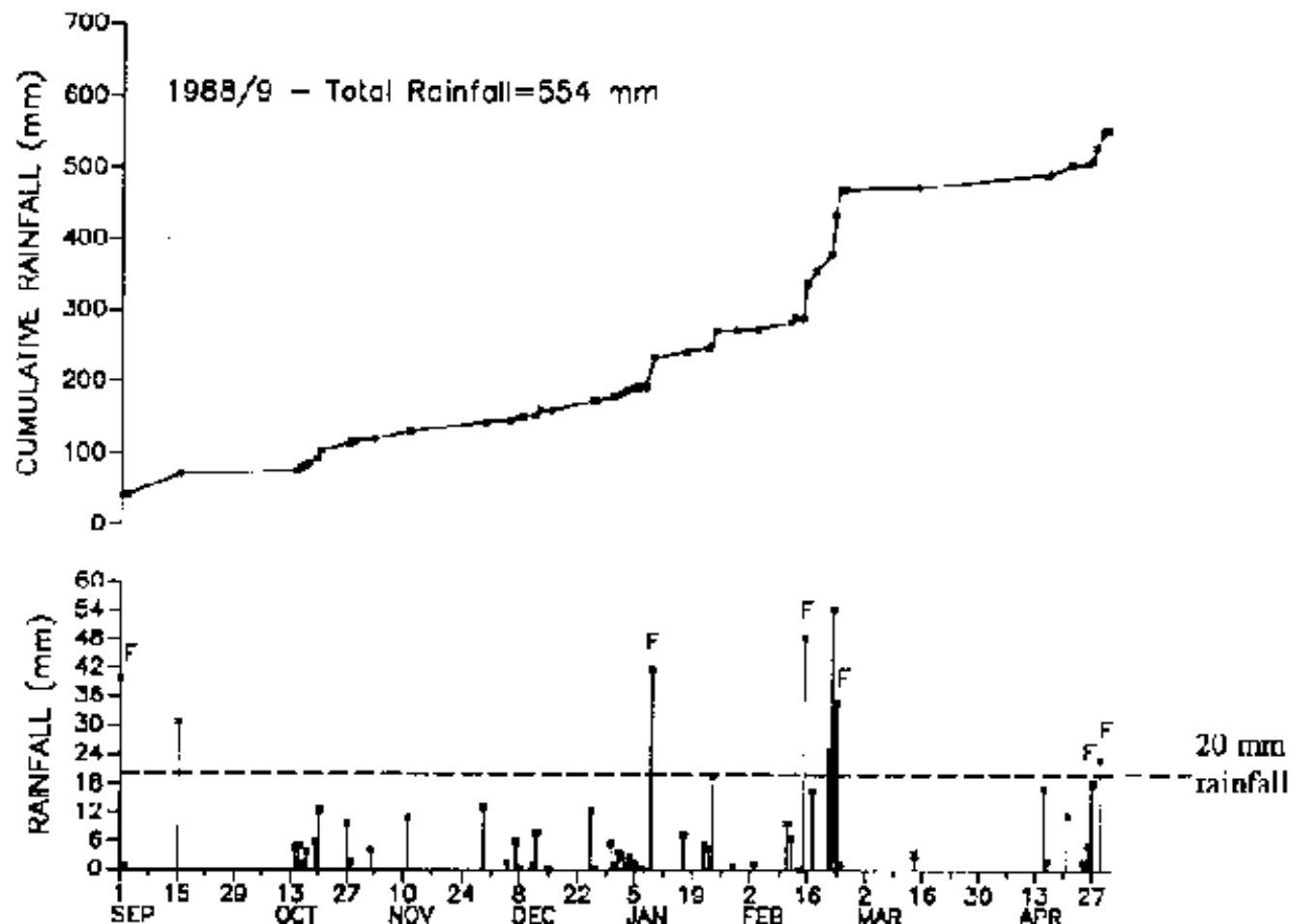
**In 1987-88 and 1988-89, soil moisture was monitored to 150 cm at 20 cm intervals by neutron probe and because of the effects of runoff redistribution by microtopography, the access tubes were placed 5 m apart at low, middle and high areas, in both control and runon areas. Soil moisture levels measured during 1987-88 illustrate the differences between the field and runon areas (Fig. 7.9). Sorghum used more water in the runon area than in the control during the 44 day intra-seasonal drought and this was associated with greater root depth and mass. In the runon area, for 1986-87, P fertiliser significantly increased yields ( $P < 0.05$ ), but N did not. In 1987-88, P combined with manure and water harvesting gave the highest yields. No comparable results were obtained for 1988-89 because of stalk borer infestation.**



**Figure 7.10: Rainfall 1986 -87 Season (F indicates water harvesting flood dates)**



**Figure 7.11: Rainfall 1987-88 Season**



**Figure 7.12: Rainfall 1988-89 Season**

**The off-field water harvesting system proved in general to be successful. Problems of up-slope runoff, not associated with the ephemeral stream exploited for water harvesting, occurred. Protective bunds 30 cm high proved inadequate because of microtopography, but despite the high level labour inputs, the farmer was convinced that the system was economically viable.**

**Feasibility and Practical Considerations for Off-Field Water Harvesting Using the**

## **Botswana Example**

**A wide range of factors must be taken into account in the location, design and operation of off-field water harvesting systems, which will ultimately determine their success or failure. In many respects off-field water harvesting is more complex, but potentially more rewarding than on-field harvesting, because much larger volumes of water are available. The main practical aspects of off-field water harvesting are discussed below, in the light of experience with the scheme described above.**

### **Location and Opportunities**

**Several important observations were made using a simple non-stereoscopic survey of air photographs of the area around the water harvesting scheme and practical knowledge of how the system worked:**

- An aerial survey of 250 km<sup>2</sup> around Gaborone showed that in SE Botswana, the shallow ephemeral water courses such as that used for the water harvesting system described above were common and that at least in theory, considerable opportunities existed for the adoption of such schemes.**
- The number of farmers that could use water harvesting systems was limited to those with fields located in a suitable position, usually low-lying in the landscape. The majority of fields were not located in valley bottoms and for the farmers of these fields, water harvesting of this kind is not an option, though the exploitation of up slope runoff could be possible.**
- However, many fields share the potential for the use of runoff and while**



**this is not a problem at present, the unregulated use (and possibly disposal) of runoff may bring different farmers into conflict with one another. The water rights aspect of the interception and use of runoff in Botswana, are at present not clear. Legislation covering water harvesting rights on agricultural land is non-existent.**

- In parts of the area with steeper slopes and larger catchments, water courses were seen to be incised. In such circumstances, considerable difficulty could be encountered in obtaining runoff, as the channels were 1-2 m deep and overall land slopes were shallow.**
- In many cases diversion bunds or channels would need to be outside the farmer's field if the stream were to be exploited. They could be placed on common land in some instances.**

**Design Problems of successfully harvesting water can be illustrated by the scheme described above, even though this was a favoured location.**

- The area flooded was limited to 0.5 - 1 ha, of a total field area of about 5 ha. Most of the field was at a higher elevation than the channel and runoff could not be directed onto it. To increase the floodable area to 2 or 3 ha, using a channel slope of 0.5%, the take-off point for collected runoff would be 200 m outside the farmer's field. This limitation is one that will be met at many sites.**
- The design of the water harvesting system was very simple. The diversion ridge was not difficult to make, though access to mechanical draught power was necessary and the farmer had to acquire the rudimentary skills of bund**

## **and channel alignment.**

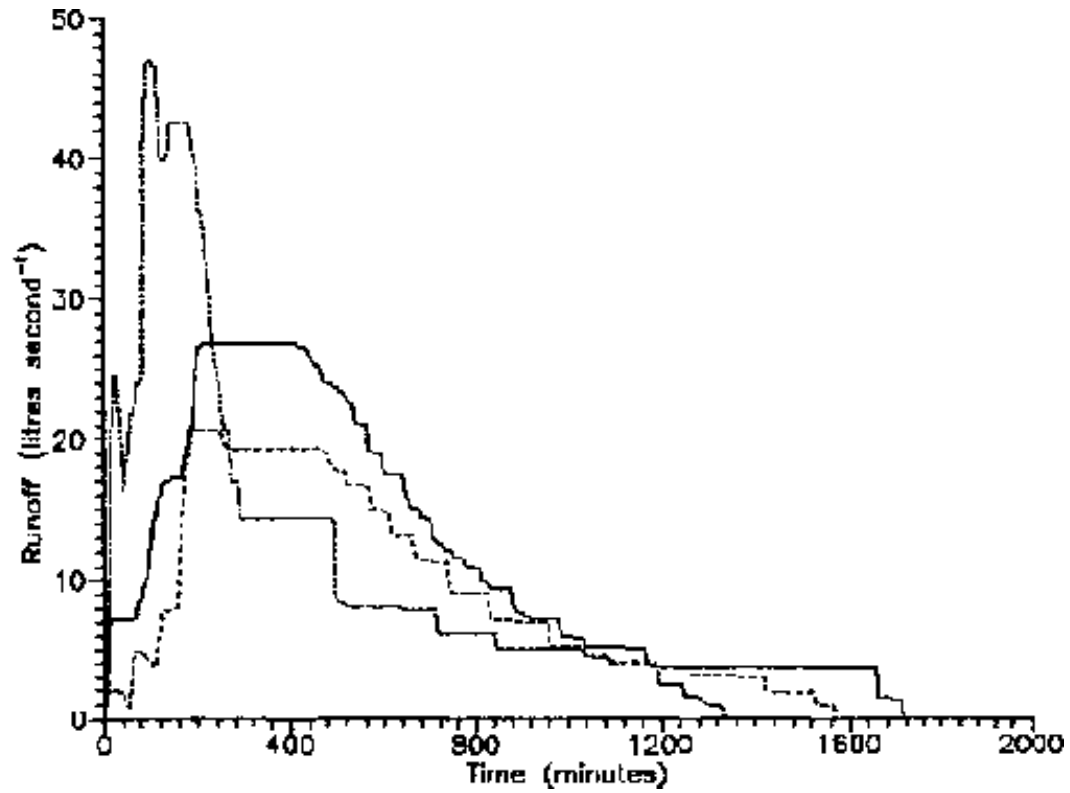
- The exact design of each system would need to be individually prepared.**
- Early preparation for the onset of the rains and the maintenance of structures throughout the wet season were necessary.**

## **Operation**

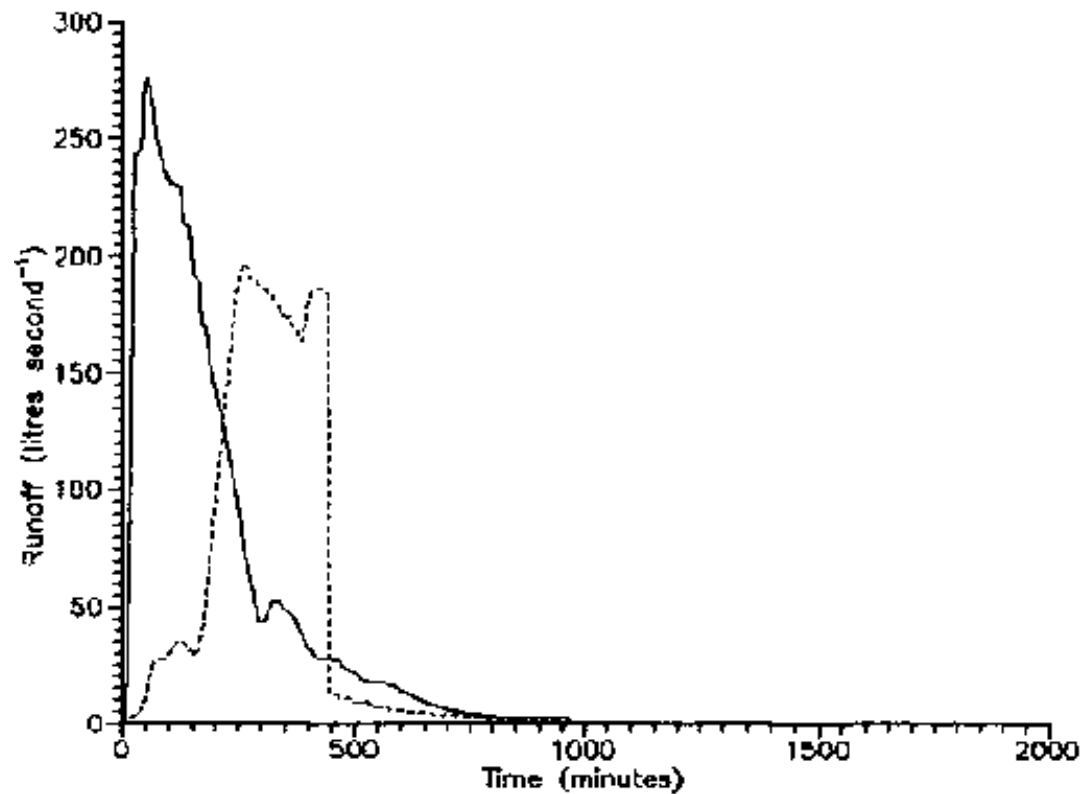
**In the example above, runoff was introduced into the runon area simply by breaking a section of the bund and allowing water to flow in. When the farmer regarded the runon as adequate, the breach was repaired. No mechanical devices were used (for example sluice gates), but the presence of the farmer was essential.**

**A study of 15 hydrographs of the larger runoff events for 1988-89 to 1990-91 gives a good idea as to the time of day (or night) that large storms take place and the time-distribution of flow, which together dictate the farmer's opportunity to avail him/herself of the runoff. Figure 7.13 shows example hydrographs with low peak flows (less than  $50 \text{ l s}^{-1}$ ). Low peak flows are more manageable and present a reduced risk of channel and bund erosion, but more of the runoff must be harvested to provide an adequate supply of water for crops.**

**Note that the total period of flow is similar in all three cases (about 24 hours) despite the differences in peak flows. Note that the duration of high flows are also similar (about 6 hours for the period when flow is greater than half the maximum peak). These durations are important from the viewpoint of opportunities for the farmer to operate the system.**



**Figure 7.13: Water Harvesting Scheme: Low Peak Runoff Hydrographs**



**Figure 7.14: Water harvesting Scheme: High Peak Flow Runoff Hydrographs**

**Figure 7.14 shows the hydrographs with high peak flows (greater than  $200 \text{ l s}^{-1}$ ). Note that the overall duration of flow is similar to the low peak hydrographs, as are the durations of maximum flow. The recession curves are somewhat steeper.**

**Of the 15 events, 5 started in the morning, from 03:00 to 10:00 (3 of which occurred between 3 and 4 am.) and 10 started between 15:00 to 23:00 (3 between 9 and 11 pm). This poses some difficulty for farmers who have to be aware of heavy rain, assess that runoff is sufficient, operate the harvesting system and estimate when adequate runoff has been collected, in the dark. The development of a more automated system, perhaps with sluice gates is indicated. Spillways were tested,**

**but did not work well.**

**The average duration of flow was 20 hours, the longest duration 40 hours and the shortest 7.5 hours. These periods appear to give adequate time for the farmer to undertake the necessary action to harvest water. However, because the catchment area is small, the flows peak rapidly (average time 3 hours) and the hydrograph recessions contain only about half of the total flow volume. A farmer who does not act promptly will only have access to a rapidly decreasing supply of runoff. Experience has shown that protection from other sources of up slope runoff is important. The largest runoff event which occurred for the 1990-91 season (from rainfall of 49.6 mm on 25.11.90) caused substantial damage to the field and crop. Runon from up slope sources washed away much of the crop and several contour bunds. Runoff in the channel was sufficient to cause erosion (removal of soil to a depth of about 30 - 40 cm), such that the channel bed was lower than the area usually flooded.**

**The balance between using harvested water and preventing the damage from runoff, is difficult to achieve. The system of flood prevention that was used, field perimeter bunds about 30 cm high, was not adequate to prevent runon when heavy rain occurred. Runoff tended to concentrate in low microtopographical areas. However, the farmer was convinced of the value of water harvesting. Field observations showed that an increased water supply to crops can cause yellowing and poor growth. The reason for this appeared to be the leaching of nutrients from relatively infertile soils. The agronomy experiments showed greatly increased yield with manure and fertiliser applications. Traditional applications of fertiliser in Botswana are very low, indeed many farmers do not use them. When water availability is not a limiting factor, soil fertility can be.**

**It is advantageous that soils in low-lying areas where water harvesting can be practiced, tend to be heavier than usual. Soils must be deep to retain the water as soil moisture. Sandy textured soils not only have problems of poor nutrient status, but also allow the deep drainage of runoff, with little benefit for the crop. Successful crop growth early in the season can pose difficulties. Crops can attract pests simply by being the only crops in the area. Successful farming will demand increased management, labour and money to protect crops from stalk borer, aphids and birds.**

**Weed growth is enhanced by favourable growing conditions and more time and labour will be needed to control it. Unfortunately, row planting is not commonly practiced in Botswana, broadcast crops are more usual. Row planting, when practiced competently, gives better controlled planting densities, more even crop stands and facilitates weeding. Access to planters, draught power and the development of row planting skills would greatly enhance the farmer's ability to exploit harvested water and increase crop yield.**

## **Conclusions**

**The implementation of water harvesting techniques for increased and sustained crop production on a national scale will need a range of favourable preconditions for success. They are listed below, in an approximate order of priority:**

- 1. Farmer enthusiasm and commitment.**
- 2. A suitable socio-economic background, especially a profitable market (be that increased food security or an increased cash income).**
- 3. A co-operative communal framework.**

- 4. A favourable soils environment.**
- 5. Access to basic draught power and operating skills.**
- 6. Simple but efficient agrohydrological designs**
- 7. Access to fertilisers and pest control**
- 8. Competent and effective research and extension planning.**

## **7.2 The design of bunds, channels and other field structures**

**The success of water harvesting schemes and the productive marriage of hydrology and agriculture depend on the identification of suitable systems for the regional or national social-economic-farming environment and the correct application of known engineering principles in the field. In this section aspects of the latter are covered.**

**Badly-designed and implemented systems cause more problems than they solve, interfering with natural drainage, promoting soil erosion and causing the destruction of crops. On land that has been developed already, it is useful to assume that all structures; roads, drains and field boundaries have been laid out with a total disregard for topography and drainage, because this will usually be the case. They should also be regarded as moveable. Catchments are natural features that are constituted of smaller subcatchments; fields are some of their components. In planning water harvesting and water conservation over large areas it essential to recognize the varying scales of catchment areas and their hierarchy. Field layouts aim to create artificial subdivisions of natural catchments into smaller units. A number of points should be considered:**

- **All layouts should effectively reduce erosion.**
- **Any redirection and discharge of water should not cause erosion elsewhere.**
- **Concentrations of water should be kept as small and travel as slowly as possible.**
- **As far as possible, water should be allowed to follow its natural route.**
- **Access roads and tracks should be planned as an integral part of any large layout.**
- **Structures should interfere as little as possible with natural drainage and farm operation.**
- **Future development should be borne in mind.**

**In general, it is sensible to first describe agricultural constructions at the small scale, adjacent to the crops that are being grown. Large structures, which are planned to deal with large, exceptional flows, can be described thereafter. There are two main types of structure which operate in different ways.**

**Contour Structures:** are aligned parallel to a master ridge on the contour. They are designed to divide the catchment into smaller subcatchments and maximize infiltration. They do not aid in the discharge of runoff and may be tied to ensure that this control is effective. The greatest danger to these structures is that they fill and over-top.

**Graded Structures:** may be ridges or drains that are aligned at a slight slope and help in the discharge of runoff at low, non-erosive velocities. They prevent runoff from taking the shortest and fastest route downslope. Generally they are used in association with natural waterways.

### **7.2.1 Channels and Waterways**



## **a. General Design Considerations**

**The design of channels that conduct water at non-erosive velocities is a common feature of agrohydrological practice and involves the basic channel hydraulic formula  $Q = Va$ , discussed in the section on stream gauging. Manning's formula is commonly used to determine channel design and several factors need to be considered:**

**Channel Size: larger channels carry more water than small channels, on the same slope.**

**Channel Shape: channels of the same cross-sectional area, but of different shapes will carry different amounts of water. Friction reduces velocity, so designs usually aim at reducing frictional resistance. The unit used to measure the effect of shape is the Hydraulic Radius of the channel (R):**

**$R = a/w$  where (7.1)**

**R is the hydraulic radius**

**a is the cross-sectional area of flow and**

**w is the wetted perimeter of the channel**

**Generally, the smaller the value of R, the lower the velocity of flow. Channel**

**Gradient: as the bed gradient increases, so does velocity. Channel Roughness: channel roughness is a factor that determines frictional resistance.**

**Manning's open channel formula is:**

$$v = R^{0.667} s^{0.5} / n \text{ where (7.2)}$$

**s is the slope of the channel (m m<sup>-1</sup>)**

**n is the roughness coefficient (dimensionless)**

**R is the hydraulic radius (m) and v is velocity of flow (m s<sup>-1</sup>)**

## **Design Velocity**

**The design velocity will depend upon the erodibility of the channel lining. Channels may be lined with earth, vegetation or artificial materials. Generally, vegetation, especially grass cover, is recommended for waterways to restrict velocity and to prevent erosion. High retardance species are recommended for use wherever they are available. However, it is difficult to compare the effect of different vegetation types. Vegetation varies from region to region and although much work has been done in countries such as the USA on retardance classifications according to plant species, these plant species may not be present in other areas. Grass and vegetation types may be divided into the following groups or classes of retardance, as presented in Table 7. 10.**

Class B (high)			Class C			Class D (low)		
Vegetation	Condition	Height (cm)	Vegetation	Condition	Height (cm)	Vegetation	Condition	Height (cm)
Alfalfa	good	30	Bermuda			Bermuda		
Bermuda			grass	good	15	grass	good, cut	5
grass	good	30	Kentucky			Lespedeza	good, cut	5
Lespedeza	poor		Bluegrass	good	15 - 30	Paspalum	good, cut	5
Tall fescue	good		Grass mixture	good	15 - 25	Star grass	good, cut	5
Wheat	mature		Fescue, mown			Cynodon		
Paspalum	good	30	Paspalum	good	15	dactylon	good, cut	5
Star grass	good	30	Star grass	good	15	Other		
Cynodon			Cynodon			grasses	good	5
dactylon	good	30	dactylon	good				
Other			Other grasses	good	15			
grasses		30						

Values of Manning's 'n'

0.020 - 0.060                      0.030 - 0.085                      0.040 - 0.150

**Table 7.10: Retardance Classes for Vegetation**

**Note: condition and vegetation height are important factors in influencing retardance, as can be seen from Table 7.10 and although "good" conditions are tabulated, in real life the extents and conditions of cover are often "poor". In this case a value of Manning's 'n' = 0.040 is commonly used for vegetated channels.**

**It is also important to note that flow depth has a strong influence on retardance. With medium-height grass vegetation, Low flow (depth of water 10 cm) values of 'n' will be in the approximate range 0.20 to 0.50 whereas Intermediate flow (depth sufficient to just submerge vegetation) values will be around 0.30. However, when the vegetation is completely submerged, values of 'n' drop rapidly to the range 0.030 to 0.040. Bare channels have permissible velocities according to soil texture, though the encroachment of vegetation is common. Table 7.11 gives examples of**

## permissible velocities for unvegetated channels.

Material	Mean velocity (m s <sup>-1</sup> )	
Very light pure sand	0.23 to 0.30	These velocities are not permitted for bank channels but may be used in designs for example storm drains, where the lining material is stable.
Light loose sand	0.30 to 0.45	
Coarse sand or light sandy soil	0.45 to 0.60	
Average sandy soil	0.60 to 0.76	
Sandy loam,	0.76 to 0.83	
Sandy clay loam, sandy clay	0.83 to 1.15	
Stiff clay soil, gravelly soil	1.20 to 1.50 *	
Coarse gravel	1.5 to 1.82 *	
Conglomerates, soft rock, shale, cemented gravel, tough hard pan	1.82 to 2.43 *	

**Table 7.11: Permissible Velocities for Earth Channels**

**Permissible velocities for soil types with medium and very good grass cover are given in Table 7.12**

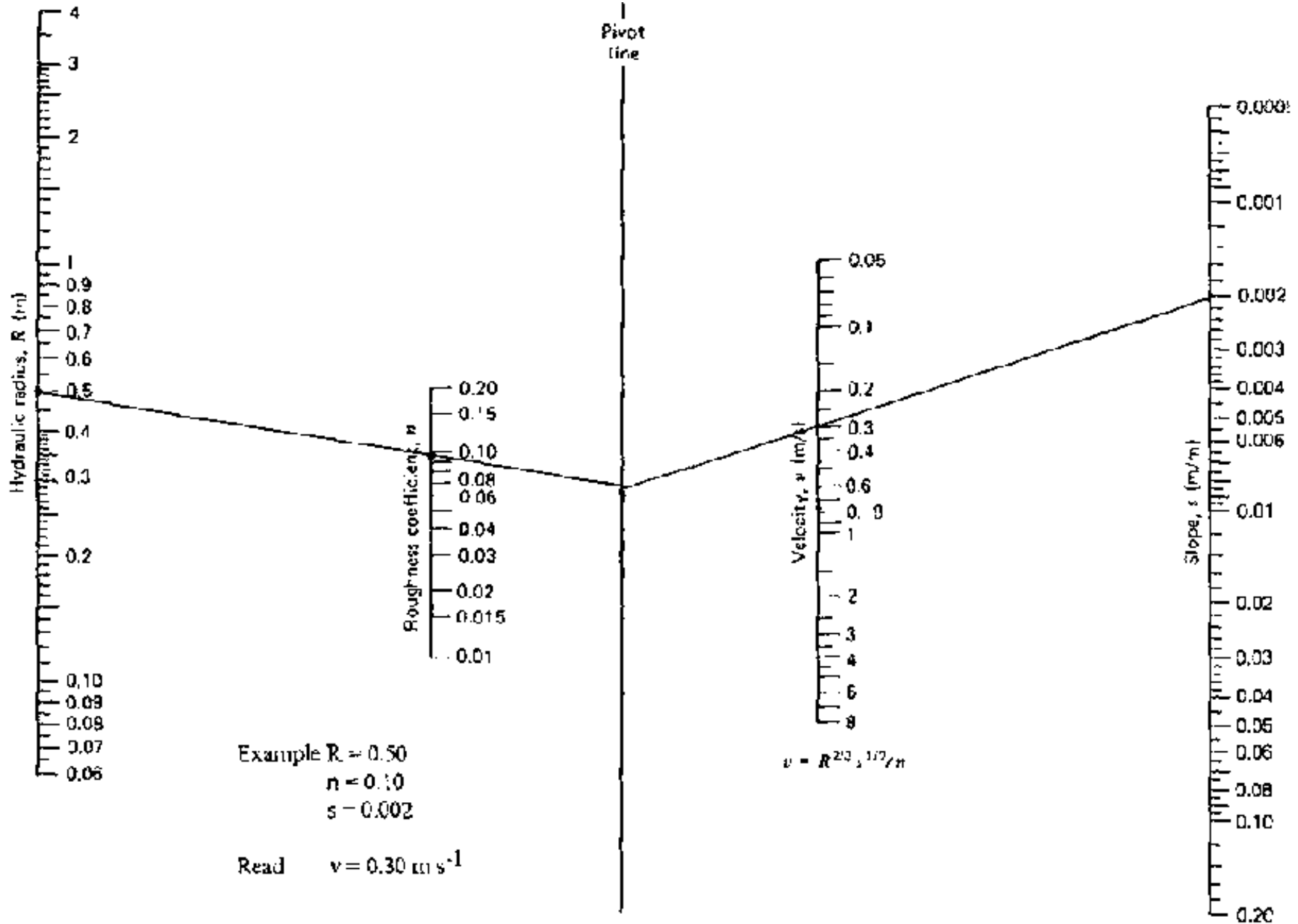
Material	Medium grass cover	Very good grass cover
Very light silty sand	0.75	1.50
Light loose sand	0.90	1.50
Coarse sand	1.25	1.70
Sandy soil	1.50	2.00
Firm clay loam	1.70	2.30
Stiff clay or gravelly soil	1.80	2.50
Shale hardpan and soft rock	2.10	good cover unlikely

**Table 7.12: Permissible Velocities ( in m s<sup>-1</sup>) for Channels with Grass Cover**

Condition / Material	n	Natural Channels	n
Concrete	0.013	Clean, straight, full stage, no pools	0.029
Hard clay and glazed brick	0.014	As above with weeds and stones	0.035
Concrete pipe	0.015	Winding with pools and shallows	0.039
Dressed stone, brick	0.016	As above at low stages	0.047
Rubble	0.017	Winding, pools, shallows, weeds and stones	0.052
Smooth earth	0.018	Sluggish, weedy with deep pools	0.065
Corrugated metal pipes	0.023	Very weedy and sluggish	0.112
<b>Dug Earth Channels:</b>			
		<b>n</b>	
Uniform cross-section, regular, no vegetation, fine sedimentary soils		0.016	
As above with sandy clay and clay		0.018	
Small variations in cross-section, fairly regular, little vegetation, sandy loam and sandy clay loam, new channels		0.025* (* normally used for earth channel design)	
Irregular with rough banks, or vegetation, rocks		0.030	
Eroded irregular channels		0.030	

**Table 7.13: Approximate Values of Manning's 'n' for Various Channel Conditions and Materials**

**Calculations of flow velocity from Manning's formula necessitate the estimation of the roughness coefficient 'n'. Table 7. 13 gives values of 'n' for various channel conditions and the various artificial materials that may be used to line water ways, as well as values of 'n' for dug earth channels: The calculations of velocity can be made from formula 7.1, or nomograph, Figure 7.15, may be used to read off velocity values.**



**Figure 7.15: Nomograph for use with Manning's Equation**

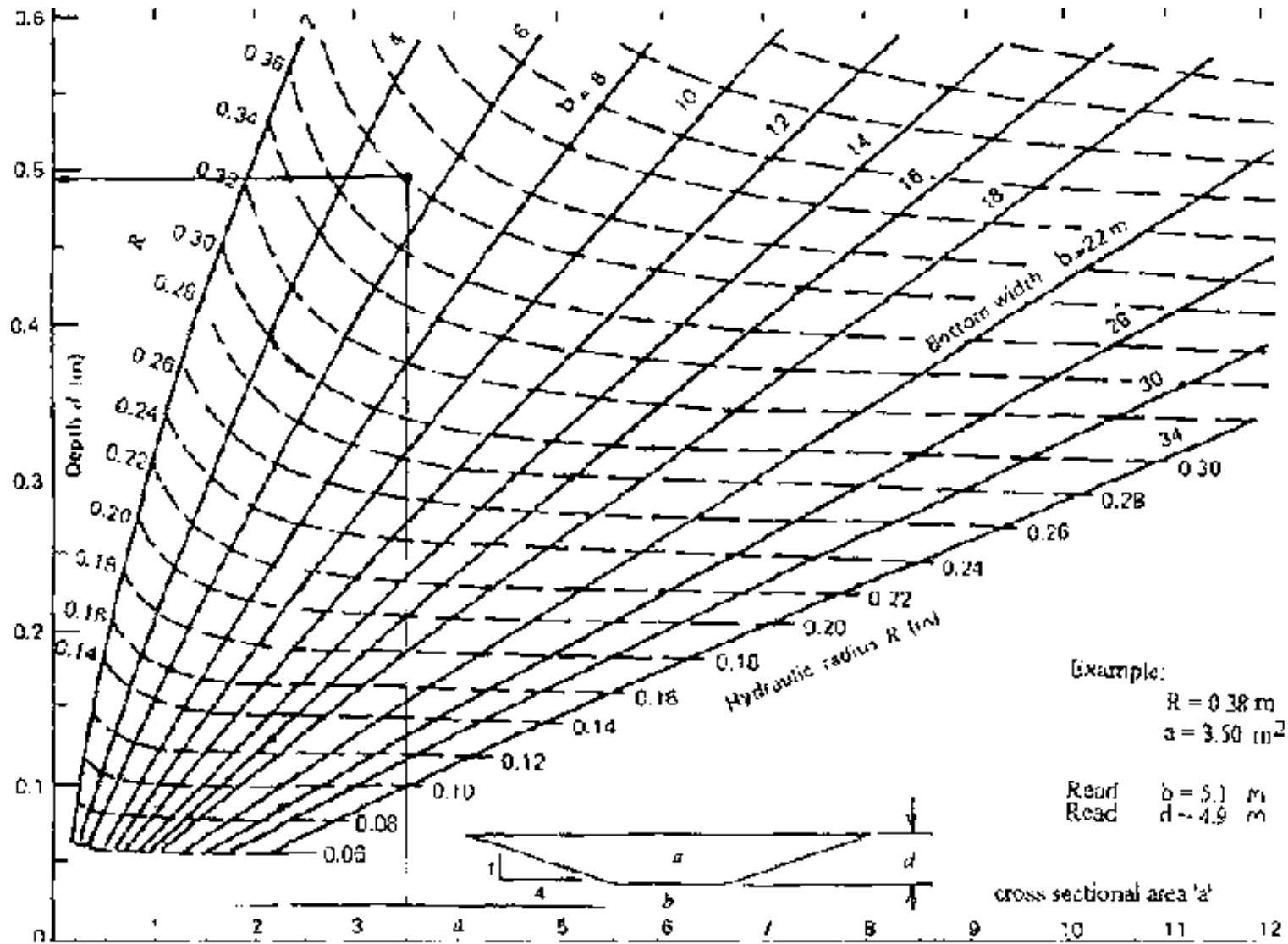
**Designs should be made to account for the lowest level of retardance that is likely**

**to be encountered in the rainfall season, according to changes in vegetation growth.**

## **Design Section**

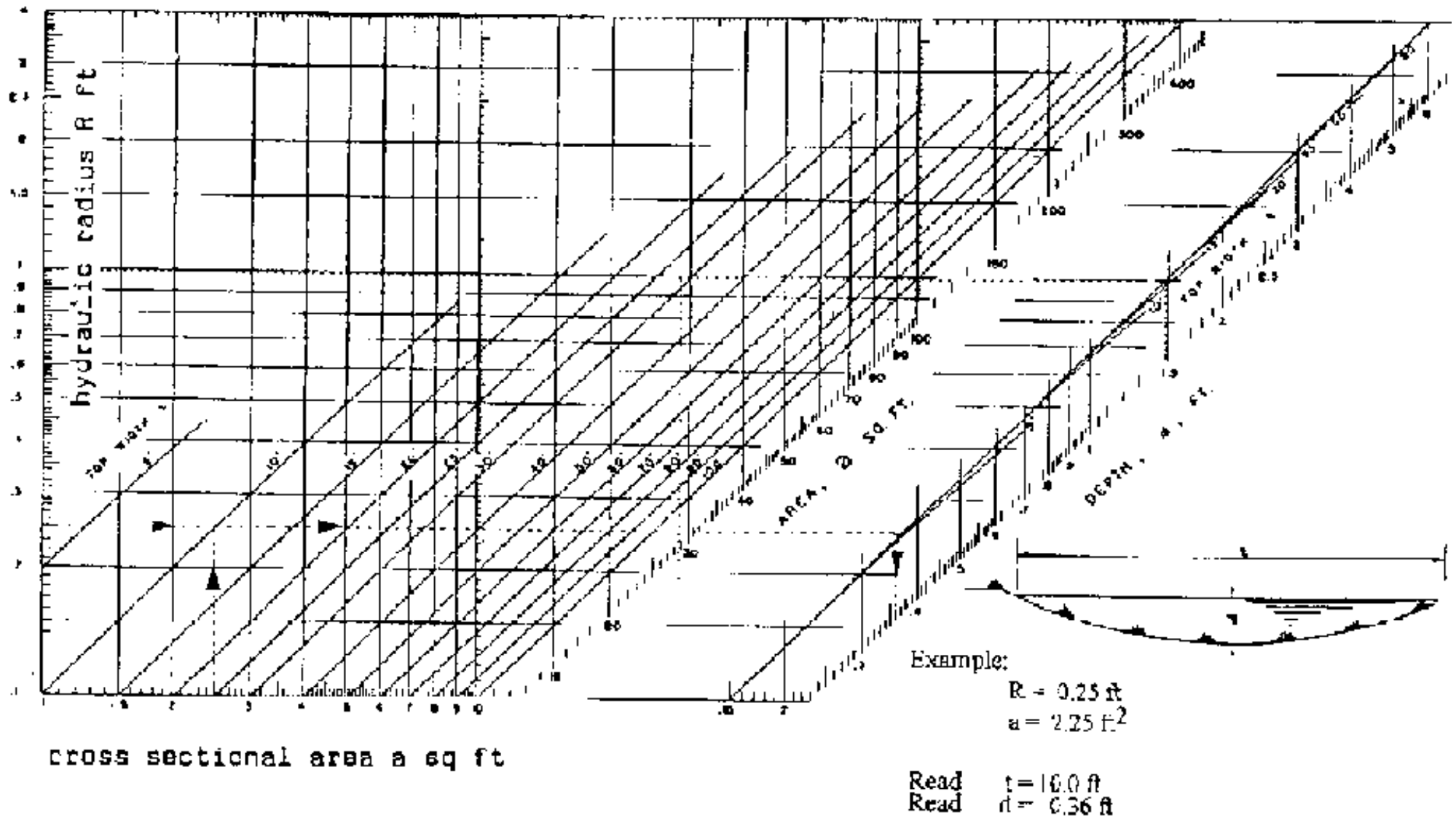
**Most commonly, channel cross-sections are parabolic or trapezoidal. Triangular sections should be avoided unless they are on very low slopes ( $< 2\%$ ) and are well grassed, as they concentrate flow and may cause erosion.**

**Over time, natural channels tend to a parabolic cross-section and trapezoidal channels, by the natural processes of sedimentation' tend to this form also. As a result, their capacity will decrease. It is useful to remember that if tractors and similar equipment are to cross the channel, then the slope of the sides should not be greater than 1:4, to allow access. Figures 7.16 and 7.17 give the details of hydraulic radii (R) and cross sectional area of Trapezoidal and Parabolic channels, according to their dimensions.**



**Figure 7.16: Trapezoidal Channels (Metric dimensions)**





**Figure 7.17: Parabolic Channels (Imperial dimensions)**

**Channel Slope**

**Flow velocities increase as slopes become steeper, and the danger of scouring and**

**destructive erosion becomes more likely. It is important to recognize that to reduce erosion on steeper slopes, channels can be made wider and shallower to spread the flow and thereby increase the effective retardance of the lining. On shallow slopes channels can be made deeper and narrower with less risk, and narrow channels have the advantage of occupying less land.**

## **b. Methodology of Channel Design**

**The procedure for determining the design of channels at any location point is as follows:**

- Determine the maximum discharge from the procedures in Chapter 2. Remember that the important factor is peak design flow .**
- Estimate the channel roughness ( 'n' ) from the details given in Tables 7.10 and 7.13 above. Remember that values of 0.0025 and 0.04 are usually used for earth channels and poor cover grassed channels, respectively.**
- Calculate the actual gradient in  $\text{m m}^{-1}$  or set a design gradient that will be used in construction.**
- Select from Tables 7.11 or 7.12 above, the maximum permissible velocity for the channel design.**
- Find the hydraulic radius from Manning's formula (7.2) or from the nomograph, Figure 7. 15.**
- Calculate the cross-sectional area for the maximum estimated or design**

## **peak flow / velocity**

- Using the cross-sectional area and hydraulic radius, find the top width and depth.**
- Add the freeboard.**
- Assess whether the channel design dimensions are acceptable in the proposed location.**

**Gradient, channel roughness and velocity are open to variation if the dimensions are unsuitable. Various components of Manning's formula can be found according to which are known and which are not.**

**Controlled and Uncontrolled Gradients Two sets of circumstances will occur with regard to gradients:**

- 1. Where gradients can be controlled, i.e. selected more or less at will, the velocity, lining and shape dimensions can be used to determine the appropriate gradient.**
- 2. Where gradients are uncontrolled, for example natural streams following a course at right angles to the contours and which it is wise to utilise, the gradient is pre-determined and therefore termed "uncontrolled". In these circumstances it is necessary to determine the velocity according to the channel lining that is present. If time and resources allow, the type of lining can be imposed to select a preferred velocity. Velocity is used with peak flow to determine cross-sectional area, the shape and dimensions of the channel.**

**It is useful to remember that increases in the permissible velocity of a channel can be achieved by lining with vegetation, increasing the vegetation cover or using artificial lining materials. Grass cover for channels has the advantage that it often already exists in natural waterways. In this case it is best to calculate channel width and estimated peak flow with and without cover and if possible, to extend and improve this cover. Grass is cheaper to install and maintain than an artificial surface.**

## **Design for Catchments**

**To aid correct design, catchments should be divided into subcatchments. Where the outflow of each subcatchment joins the main stream, the peak flows (known from previous data or calculated from the methods described in chapter 2) should be added together to determine the ever-increasing flow volume. Estimates of channel design should then be carried out at each point. The lowest value of permissible velocity for each section of channel should be taken as the greatest permitted value for that section.**

**Select and specify the points at which along the channel, the cross-section is to be designed, taking into account the subcatchment dispositions and:**

- For all points determine the maximum runoff for these points.**
- Select and specify the lining.**
- Determine the most erodable soil type.**
- Measure the slope of the channel bed segments that include these points.**
- Determine the permissible velocity for the slope/roughness/vegetation.**
- Determine the channel dimensions according to velocity, slope and runoff.**

**Any increase in dimensions, above and beyond the increase due to drainage from the increased area of catchment (for example a drop in velocity and therefore capacity), should be allowed for.**

## Example Design

**An example pro-forma sheet for the design of channels is given below:**

### PRO-FORMA 1 DESIGN OF GRASSED CHANNEL ON UNCONTROLLED GRADIENT

#### 1. Background

Type of structure ..waterway..... Location .....Gabane..... Date...15.03.93.....  
 Designer .....P. Thlabiwa..... Notes ... field drainage outlet, probably poor management.....

#### 2. Details of Site

Vegetation .....cynodon dact. 1 yr..... Cover condition .....poor..... Manning's n ....0.04..... 'n'  
 Lightest soil type ...s/clay loam..... Maximum channel bed slope ...6%.....  
 Permissible velocity ..... v..... 1.8...ms<sup>-1</sup>..... 'v'

3. Calculate runoff peak (e.g. use Rational Method) q .....2.1..... m<sup>3</sup> s<sup>-1</sup>..... 'q'

#### 4. Calculate channel dimensions

a. If condition is "poor" ( n= 0.04), select for permissible velocity (see table 7.11) and determine channel dimensions for maximum slope.

Design top width of flow (t) .....7.5 m..... 't'  
 Design depth of flow (d) .....0.21 m..... 'd'

Note: if the flow 'q' is more than 6 m<sup>3</sup> s<sup>-1</sup>, consider limiting catchment area and/or improving cover.

b. If cover is better or worse than "poor"

Calculate absolute slope (S<sub>a</sub>) e.g. 5 % = 0.05 .....m m<sup>-1</sup>..... 'S<sub>a</sub>'  
 Determine Hydraulic radius (R) .....m..... 'R'  
 Calculate cross-sectional area of flow (a= q / v) .....m<sup>2</sup>..... 'a'

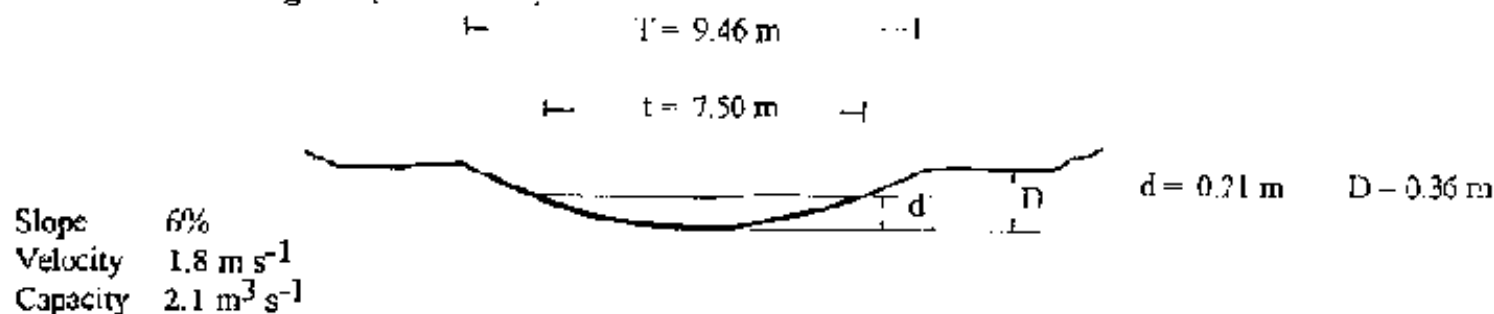
Use figure 7.17 to find:

Design top width of flow (t)	... m	't'
Depth of flow (d)	... m	'd'

#### 5. Add freeboard

Freeboard (depth $f_d$ )	... 0.15 m	' $f_d$ '
Construction depth ( $D = d + f_d$ )	.. 0.21 + 0.15 m .. 0.36 m	'D'
Use values of 't', 'd' and 'D' in (Key 38b) to determine Construction width (T)	... 9.46 m	'T'

#### 6. Construction diagram (not to scale)



**Figure 7.18: Example Channel Construction Pro-forma Sheet**

## Establishment and Maintenance of Vegetation

The value of establishing good conditions of growth in vegetated waterways should be recognised and undertaken where it will mean the effective control of erosive velocities. Fertility should be improved with available nutrients and any seed mixtures should include quick-growing annuals as well as hardy perennials for permanent protection. Any material that can be used to stabilise the soil while plants grow ( such as mulches), will be of value.

Channels are depressions frequently filled with water and as such often retain good vegetation during the early dry season. The use of waterways for excessive grazing

**and stock routes, as well as tracks should be severely discouraged. Care should be exercised when equipment crosses waterways and runoff discharge from terraces and bunds can do serious damage if not properly sited and controlled.**

**Vegetation should be mown or carefully grazed to stimulate root growth. Repairs should be made when necessary and velocities controlled to allow the addition of nutrients by sedimentation without the smothering of growth. Revegetation is an important and useful process.**

### **7.2.2 Storm Drains**

**Storm drains form an important part of the overall control of water in a farm system. They may be used to prevent damaging inundations of runoff or may safely relocate runoff from large rain storms, by controlling gradients and velocities to prevent erosive flows.**

**Storm drains are usually lined with unprotected soil, thus reducing the permissible velocities of water. Their controlled (i.e. selected) gradients allow flexibility in design. In some cases, where low slope arable land meets a steep upslope area, very steep channel gradients may be necessary in the alignment.**

**The general method for the design of storm drains is as follows:**

- Design either for the same dimensions throughout the channel length, or in sections and subcatchments and increasing flow as discussed earlier. The latter choice may take several iterations of design before the most appropriate is found and will depend to a large extent on locality and a balance of cost.**

- **Estimate flow for the design storm, for example a 10 year return; calculate the flow from the methods in chapter 2.**
- **Determine the maximum permissible velocity for the most erodable soil in the channel (or channel section).**
- **Choose the most suitable gradient for the location and purpose of the drain.**
- **Calculate the design depth; construction depth (design depth + a freeboard of minimum 50 cm), design width and construction width (design width + width of freeboard).**

**Note that each storm drain should be designed for individual circumstances, but if drains merge, then the section by section approach to design must be followed.**

**Example Design An example pro-forma sheet for the design of storm drains is given below (Figure 7.19).**

### **7.2.3 Bunds**

**Bunds are ridges built within a field to allow, and control, the flow of draining water. They are placed with shallow gradients just off the contour and their locations need to be surveyed. Usually the vertical distance between bunds will be kept constant though the horizontal distance between them will vary with the slope of the land. In some special and rare cases of uniform slope, parallel bunds may be used. The vertical distance between bunds and the within-field spacing (which determine the amount of runoff to be controlled), will be calculated according to slope and soil texture, and will be determined before the bunds are designed.**



## Bunds can be:

- a. **Narrow-based or Ridge bunds** - which are formed by hand and are narrower in both channel and ridge than
- b. **Broad-based bunds** - which are made by whatever machinery (animal or engine powered) is available.

**In form the two types have the basic size relations:**

Ridge bunds	bank width (b) = 0.75 freeboard (f) = 45 cm	
Broad-based freeboard	bank width (b) = 0.95 t(f) = 30 cm	where t = the channel width in metres.

### PRO-FORMA 2 DESIGN OF STORM DRAINS

#### 1. Background

Type of structure ..storm drain..... Location **Kopong**..... Date..25.01.93.....  
 Designer .....P. Thlabiwa..... Notes..Below outlet of field drainage...Selected gradient **1 in 500**.

#### 2. Details of Site

Earth waterway Manning's n (normally) ... **0.0225**..... 'n'  
 Lightest soil type ..s/clay loam.....  
 Permissible velocity v. **1.0**...m s<sup>-1</sup>..... 'v'

3. Calculate runoff q..... **1.3**.....m<sup>3</sup> s<sup>-1</sup>..... 'q'

#### 4. Calculate channel dimensions

a. If runoff expected to be less than 0.6 m<sup>3</sup> s<sup>-1</sup>

(see Keys 42a -h and determine maximum permissible velocity or calculate in full as in b. below)

Width and Depth (if Gradient fixed)  
 or Width and Gradient (if Depth fixed)

or width and gradient (if Depth fixed)  
 or Depth and Gradient (if Width fixed)

Gradient (G)	... m m <sup>-1</sup>	'G'
Design top width of flow	.....m	't'
Design depth of flow	.....m	'd'

**b. If runoff expected to be greater than 0.6 m<sup>3</sup> s<sup>-1</sup>**

Calculate absolute slope (S <sub>a</sub> ) e.g. 5 % = 1/5/100	0.002	'a'
Determine Hydraulic radius (R)	0.34m	'R'
Calculate cross-sectional area of flow (a = q / v)	1.2..m	'a'
Use Figure 7.17 to find		
Design top width of flow (t)	3.36.m	't'
Depth of flow (d)	0.55.m	'd'

**5. Add bank width and height to calculate overall dimensions**

Calculate chosen bank width

Ridge bunds b = 0.75 x t

Broad-based b = 0.95 x t

Storm drains b = 1.15 x t

3.19 m

'b'

Width (w) = bank width (b) + channel width (t)

3.36 m + 3.19 m

=

6.55 m

'w'

Freeboard = minimum bank height before settlement of soil (settled freeboard = 33%)

Check 'f'

Ridge bunds standard 0.60 m

Broad-based minimum 0.40 m

Storm drains minimum 0.52 m

D = bank height (f) - channel depth (d)

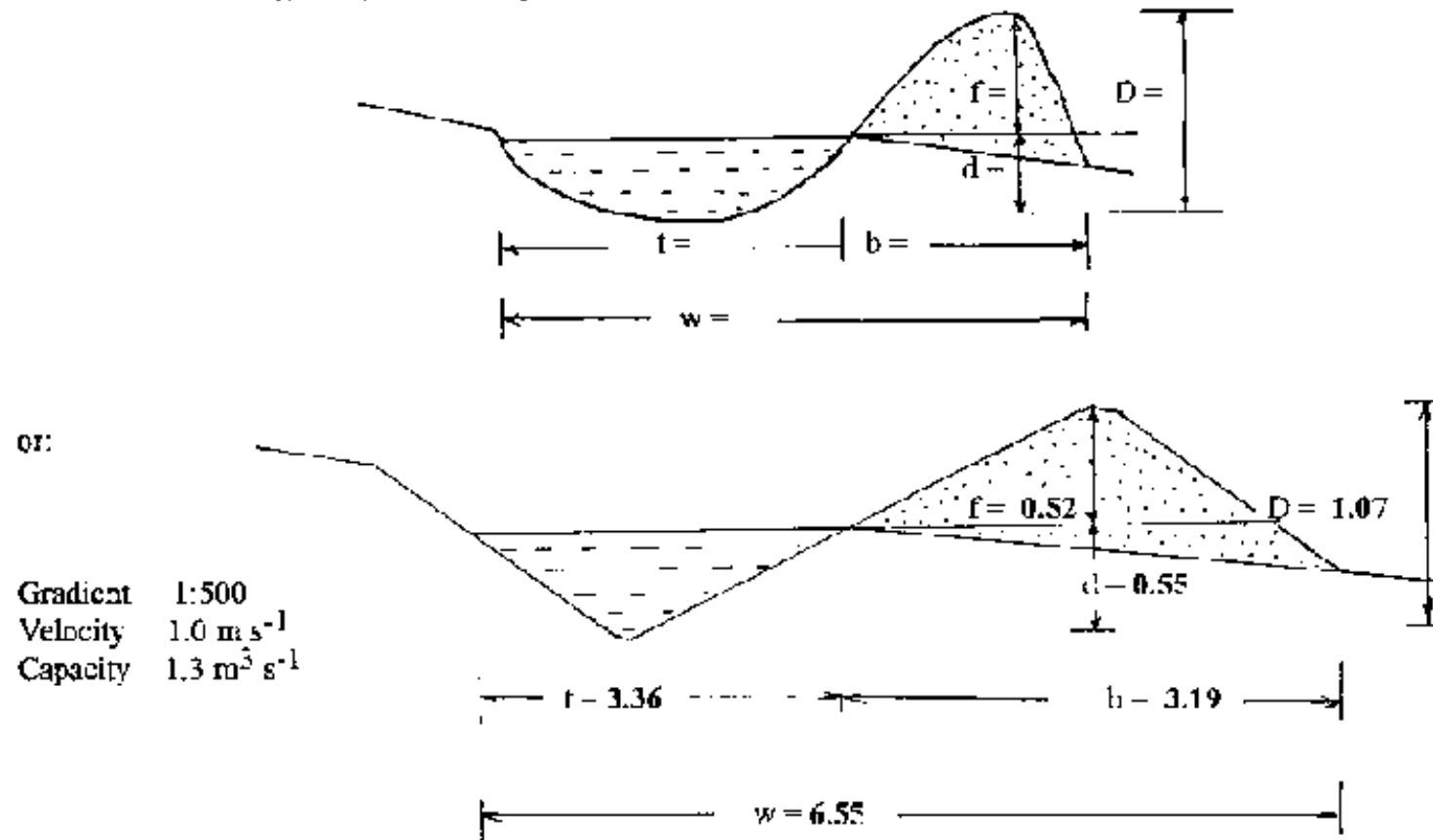
0.52 m + 0.55 m

=

1.07 m

**Figure**

## 6. Construction diagram (not to scale)



**Figure 7.19: Example Pro-forma Sheet for Storm Drain Construction**

**The relative merits of narrow and broad-based bunds are listed below in Table 7.14**

Ridge bunds		Broad-based	
Advantages	Disadvantages	Advantages	Disadvantages
<ul style="list-style-type: none"> <li>- Relatively che</li> <li>- Easy to make by hand</li> <li>- Can be used on all slopes and those that are &lt; 12%</li> </ul>	<ul style="list-style-type: none"> <li>- Cannot be crossed by machinery</li> <li>- Bank cannot be used as a road</li> <li>- Bank unsuitable for planting over</li> <li>- Maximum practical size about 1.5m channel with 20 - 25 cm high bank</li> </ul>	<ul style="list-style-type: none"> <li>- Can be crossed by machinery</li> <li>- Bank can form a road</li> <li>- Bank can be planted over</li> <li>- Large capacity channels possible</li> <li>- Each bund serves a larger unit area</li> </ul>	<ul style="list-style-type: none"> <li>- Relatively expensive and cannot be made by hand</li> <li>- Construction not feasible on slopes that are &lt; 12 %</li> </ul>
The maximum accuracy of shaping is by hand		The maximum accuracy of shaping by grader	

The use of normal farm machinery will necessitate final shaping by hand

**Table 7.14: Advantages and Disadvantages of Bund Types**

**Appendix D 1 gives diagrams that can be used to calculate bund lengths for different catchment areas and slopes.**

### **General Method of Design**

**In many respects, this procedure is similar to that for earth channels, though in general bund designs cannot vary so widely as those of channels.**

**- It is assumed that all bunds in a field catchment will be of the same design as the largest bund, which will have the largest catchment area.**

**- Use the longest bund and the average distance from its neighbour, to calculate the catchment area.**

- **Calculate the runoff peak from this area for (as a realistic example) the I in 10 year storm.**
- **Determine the lightest and most erodable soil type and select the maximum permissible velocity.**
- **Use the surveyed, design gradient of the field layout.**
- **Using the table in Appendix D 2 with the appropriate velocity, gradient and capacity select the suitable width and depth of bund channel.**
- **If machinery is expected to cross the bund a wide, shallow broad-based design will be needed.**
- **Add the freeboard.**

## **Example Design**

**An example pro-forma sheet for the design of bunds on a controlled gradient is given below:**

**PRO-FORMA 3 BUND ON CONTROLLED GRADIENT, CULTIVATED LAND**

**1. Background**

Type of structure **..bund** ..... Location **Kopong**..... Date **02.04.93** .....

Designer **.....P. Thlabiwa**..... Notes **..Broad based required... Selected gradient 1 in 250.**

**2. Details of Site**

Average field slope ( $S_{av}$ )	$S_{av}$ ... %	' $S_{av}$ '
Maximum field slope ( $S_{max}$ )	$S_{max}$ <b>8</b> .. %	' $S_{max}$ '
Minimum field slope ( $S_{min}$ )	$S_{min}$ <b>5</b> .. %	' $S_{min}$ '

Lightest soil texture in field **.....s/clay loam**

Maximum bund length ( $B_1$ ) **..... 305 m** ..... ' $B_1$ '

**3. Calculate runoff**

Lightest soil texture, +  $S_{min}$  +  $B_1$  and determine

Maximum bund catchment area ( $A_b$ ) **..... 0.89... ha** ..... ' $A_b$ '

Determine maximum expected peak runoff ( $q$ )  
using  $S_{max}$  **..... 0.2 ...m<sup>3</sup> s<sup>-1</sup>** ..... ' $q$ '

**4. Calculate channel dimensions**

Specify maximum permissible velocity ( $v$ ) **..... 0.76 ... m s<sup>-1</sup>** ..... ' $v$ '

Find channel Width, Depth, Gradient

Gradient ( $G$ ) **..... 1 in 250** ..... ' $G$ '

Design top width of flow **..... 1.83.....m** ..... ' $w$ '

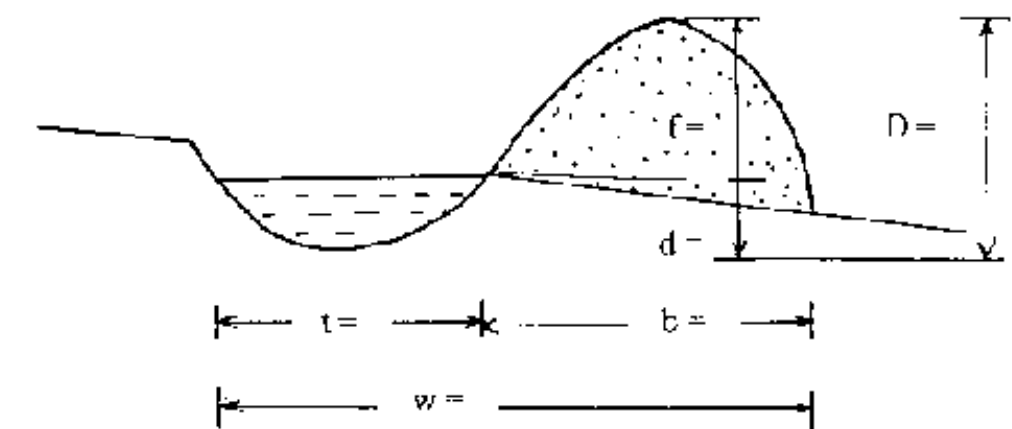
Design depth of flow **..... 0.21... m** ..... ' $d$ '

### Figure

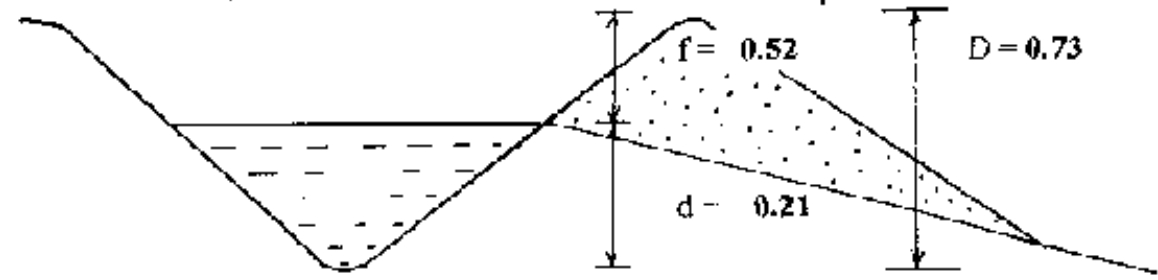
**5. Add bank width and height to calculate overall dimensions**  
Calculate chosen bank width

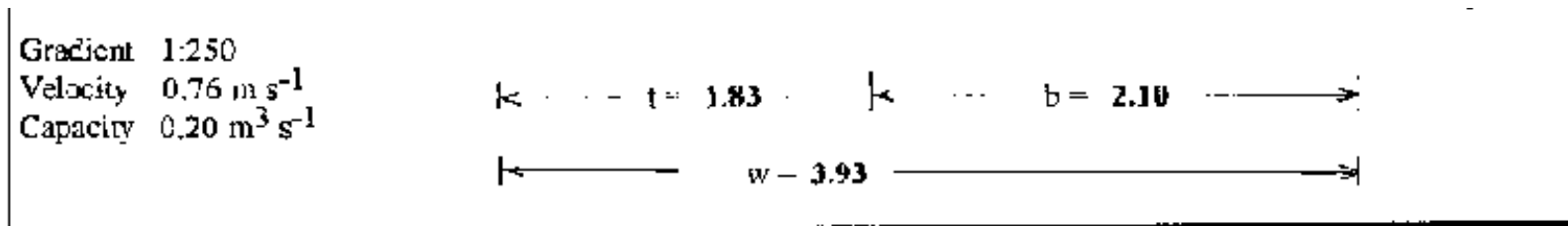
Ridge bunds	$b = 0.75 \times t$		
Broad-based	$b = 0.95 \times t$		
Storm drains	$b = 1.15 \times t$	..2.10 m	'b'
Width (w) = bank width (b) + channel width (t)		..1.83 m + ..2.10 m	3.93 m 'w'
Freeboard = minimum bank height before settlement of soil (settled freeboard 33%)			
Check 'f'			
Ridge bunds	standard	0.60 m	
Broad-based	minimum	0.40 m	
Storm drains	minimum	0.52 m	'f'
D = bank height (f) + channel depth (d)		0.52 m + 0.21 m	0.73 m 'D'

6. Construction diagram (not to scale)



or:

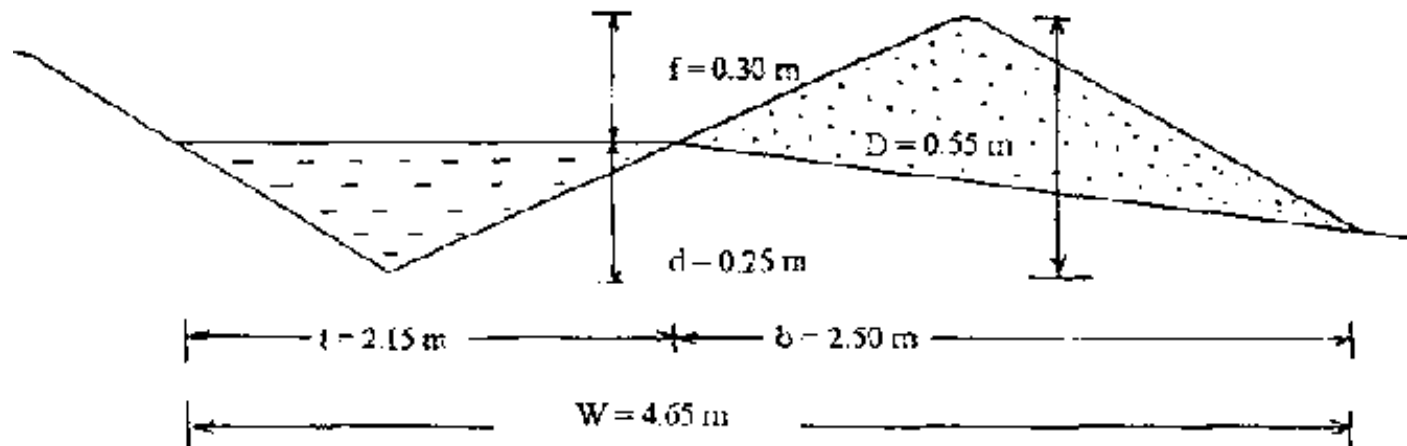




**Figure 7.20: Example Pro forma for Bund Construction**

## Standard Gradients and Standard Bund Design

Sometimes, standard gradients are used for field layouts. The maximum permissible velocity is found from the soil texture, the gradient is known and the design is calculated to carry maximum runoff. In other cases, it is more convenient to specify a standard bund design for all situations, this is especially so when only standard farm machinery is available. A standard bund design is shown below in Figure 7.21



**Figure 7.21: Example of Standard Bund Design**

In Figure 7.21 the bund is capable of carrying  $0.09 \text{ m}^3 \text{ s}^{-1}$  at a gradient of 1:1000 or  $0.25 \text{ m}^3 \text{ s}^{-1}$  at a gradient of 1:200. If runoff is expected to exceed this capacity, the



**gradient may be made steeper, to increase the velocity to that which is the maximum permissible; or the vertical intervals between the bund may be decreased to reduce the catchment area (and thereby the volume and peak flow of runoff). Alternatively, more waterways can be interpolated, thus reducing bund length.**

## **Parallel Bunds**

**In some cases parallel bunds can reduce management inputs, but there are difficulties and in general parallel bunds are not recommended. Slopes must be shallow and free from microtopography; inter-bund distances must be reduced and the suitability of each bund must be assessed individually in the field. Velocities must be restricted and on the whole the process is time-consuming and complex.**

## **7.2.4 Roads**

**Roads fall into two main categories:**

**Crest roads:**

**In this case, rainwater sheds to both sides of the camber of the roadbed and will travel away from either side in response, thus ensuring that the road does not lie wet.**

- The minimum width of a cambered road should be 1.5 m either side of the centre line (total 3 m).**
- Shallow V shaped side drains should be planned and the material used to add to the construction of the road.**

**- Mitre drains should lead off from the side drains at frequent intervals and especially at low points. The gradient used should be 1 in 50, with the head turned upslope to intercept any road side drainage.**

**- Wheel ruts may prevent lateral drainage from the road where it is on a gradient. Gentle depressions across the road at locations of the mitre drains.**

### **Cross-Slope Roads:**

**Where possible these roads should be integrated with the bund layout of land, by selecting particular broad based bunds and developing them as road lines. Such roads are developed to the extent to allow one-way traffic.**

**In areas without bund layouts, roads should be designed in the same way, but with sufficient up slope channel capacity to ensure that over topping does not occur.**

### **7.3 Surveys, marking out in the field and construction**

**The detailed methodology of surveying and the use of survey equipment is a large area of study and it is assumed for the purposes of this section that a rudimentary knowledge of maps and levelling equipment has already been acquired. If not, it is recommended that project staff consult texts that deal with surveying to familiarize themselves with basic procedures.**

#### **Marking Out**

**Marking out in the field should be as accurate as possible, to ensure that the designs operate as planned. Survey equipment is used to mark out from the large to small scale, in a sequence such as the one below.**

## **Water ways: the boundaries of fields and catchments**

### **Crests**

#### **Storm drains**

#### **Bunds: the boundaries of bund catchments**

#### **Marker and master rows: the guides for row and micro catchment construction**

#### **Other required features**

**When the exact positioning of these features is known, the dimensions of bunds, water ways, etc. can then be pegged.**

### **Equipment**

#### **Dumpy/quickset level and recording book**

#### **Levelling staff**

#### **Ranging rods**

#### **Chains and arrows**

#### **Compass and record book**

#### **20 m + strong string**

#### **Pegs**

## **Conventional symbols**

### **Centre of crest**

### **First/ last peg of graded line**

### **Intermediate peg**



blue	water ways
yellow	survey stations
red + yellow	bunds of storm drains

### **7.3.1 Methods of Marking Out**

#### **Field catchments**

**The natural topography of an area is the first to receive consideration for the survey of field catchments, because natural features define the field catchments into which all other subsequent catchments are integrated.**

- Main crests then subsidiaries are marked out.**
- Natural waterways are marked, first main channels then subsidiaries.**
- Where field and stream catchments coincide, the bund lengths should be acceptable, where this is not the case and bunds are too long, the catchments must be subdivided by roads and artificial water ways to form smaller field catchments.**
- Where suitable condition exist, details should be transferred on to the ground from aerial photographs (use transparent film) upon which the planned layout is set, otherwise the area must be levelled. In many cases an intermediate situation will exist.**

#### **Crests**

**Crests are the lines of maximum elevation and are the next features to be marked. Access roads to undeveloped areas should follow these crests as much as possible.**

- Crests are marked on the plan layout (use transparent film) in increments along the approximate alignment, noting any levelled points.**
- Along the approximate crest line on the ground, level at right angles at 10 m intervals to determine the true crest and peg.**
- Proceed forward 50 m and repeat with guide pegs between levelled positions as necessary.**
- An office plot is drawn, smoothing the outline and the final line is transferred to the ground and is best cut, to overcome problems of disappearing pegs.**

## **Drainage lines**

**The same method is followed, to establish the lowest points between crests. Often drainage is obvious on photographs and the ground.**

- Peg the centre line of obvious channels by eye.**
- Level if the channel is indistinct and peg the centre line.**
- If the starting point of the channel is clear, swing the levelling staff down stream on the string, the highest reading gives the lowest point.**
- If the channel is not obvious from the photograph use this method so long**

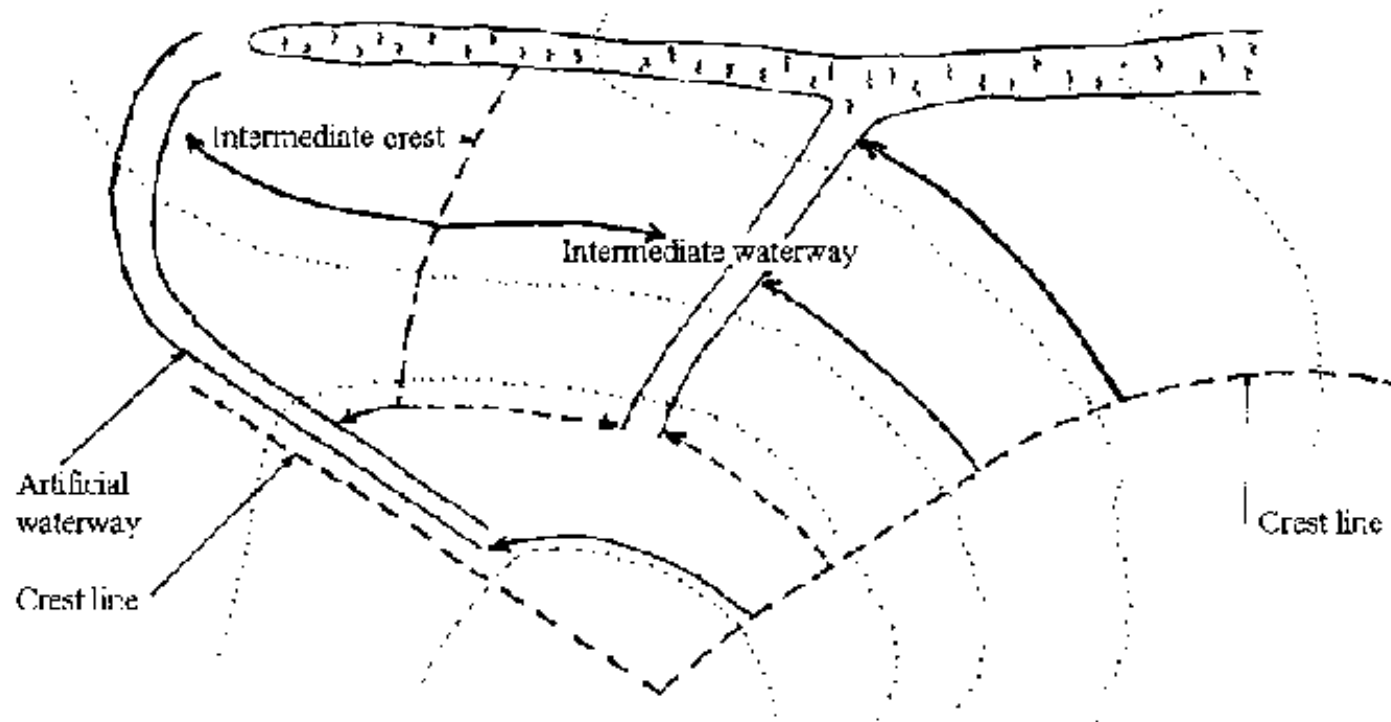
**as a start point is available.**

- **If not, a grid survey must be undertaken and the channel defined.**
- **Natural water ways may have to be extended up slope to ensure that they intercept drainage from all the proposed bunded areas.**

### **Subdivision of catchments with roads and waterways**

**Decide from field, map and/or photographs, where the longest contour line lies, from crest to channel.**

- **Calculate the maximum desired bund length from bund design (length should not exceed 400 m on light soils or 500m on heavier soils) and if the length is excessive, divide it by 3, to allow an alternating arrangement of crest and water ways.**
- **Locate new crests and water ways at the third intervals (see Figure 7.22 below).**
- **Extend intermediate roads and artificial waterways to meet the natural features. There must always be a water way between two crest roads.**
- **Water way widths are then marked according to design specifications, with pegs.**
- **Where designs join, a gradual, smooth transition must be planned.**



**Figure 7.22: Subdivision of Excessive Bund Lengths with Roads and Waterways**

## **Bund Catchments**

**Once catchment and field areas have been defined, they are subdivided into smaller artificial areas by graded bunds.**

**The design of bunds has been discussed and guidelines to appropriate bund lengths and banded areas are given in Appendix D1. Bunds can be set out according to vertical height or horizontal distance between them. In the case of maximum permissible vertical height, this relates to; slope and the danger of increased velocity and soil type and the associated danger of erosion. The steeper the slope and/or more erodable the soil, the closer bunds are set together .**

**The general formula for the determination of the Vertical Interval, the maximum permissible height between bunds, is:**

$$\mathbf{VI = S + f / 6.5 \text{ where (7.3)}}$$

**VI is in metres**

**S = Slope in %**

**f is a factor related to soil and bund type and for the following different conditions has a value of:**

Sand, Loamy sand, sandy loam	f = 4
Sandy clay loam, Clay loam, Sandy clay	f = 5
Clay, Heavy clay	f = 6

**Subtract (-) 1 from 'f' for fine "rained sands, limited permeability above 1m, soil crusting, row crops steeper than 3%. But the minimum value of f = 3.**

**Add (+) 1 to 'f' for well drained soils, tillage that encourages infiltration and reduces surface detention. But the maximum value of f= 7.**

**For Narrow-based bunds controlling peak flows of up to  $0.23 \text{ m s}^{-1}$ , f is 3 or 4. For Broad-based bunds f can be from 3 to 7.**

**VI increases with increasing slope, but decreases with the erodibility of soils. Where high annual rainfall and/or poor agricultural practice are encountered, VI should be reduced to 0.8 of the calculated value, and to 0.6 of the calculated value if a parallel**



**bund system is used.**

**The general formula for the Horizontal Distance is**

$$\text{HD} = \text{VI} \times 100 / \% \text{ Slope (7.4)}$$

**For all practical purposes the horizontal distance as measured on the field (i.e. up or down the slope) and the actual horizontal distance can be taken as equal. HD is not usually used for spacing the bunds, but is needed to calculate the catchment area up slope of the bunds, and subsequently for the calculation of runoff and for channel design purposes.**

**Percent slope:**

**The measure of % slope to determine VI can be taken as the average slope of the bund catchment found by continuous measurement while pegging out. This accounts well for variations of slope if these are frequent on a field and leads to bunds varying continuously in HD. Alternatively, on a relatively uniform field the minimum slope can be used to find the VI. This means that on parts of the field with higher slopes, the density of bunds is actually greater than is needed for conservation, but time is saved in pegging and measuring.**

**Field Layouts of Bunds**

**The critical factor is to ensure that velocities of drainage do not cause erosion, and the following must often be considered:**

- 1. The best line for a bund must be defined so that obstructions (e.g. termite hills) do not interfere.**

**2. Where a pre-determined gradient (e.g. 1:250) has been selected, calculations of design must ensure that velocities do not exceed permitted velocities for the soil type.**

**3. If a standard bund shape has been selected, the gradient alone can be used to determine safe volumes and velocities for the soil.**

**4. A particular depth and gradient can be selected at the maximum velocity of the soil type, and channel width is then adjusted to account for expected flow.**

**Generally, gradients for within-field bunds vary between 1:250 and 1:1000. Obviously the lower gradients are more suitable for lighter soils. Catchment areas do not usually exceed 1.5 ha on sandy soils and 3.0 ha on clay soils and channels are not usually more than 3 m wide and 0.30 m deep.**

### **Pegging Bund Lines**

**The pegging of bund lines is outlined below, even though such field survey practices are generally beyond the scope of this book. It is included here for two main reasons. First, it is likely to be encountered very frequently and second, it provides a good example of the general practice without entering into the details of field surveying. The method is as follows:**

- Peg from the highest point so that if pegging is interrupted, runoff from upslope will do no damage.**
- Inter-peg distances are 15 m on uniform land, 7.5 m on uneven land, so use**

**string of these lengths.**

- **Locate the start point by measuring the average slope from the high point (or previous bund line) then calculate the VI to the next start point.**
- **This is recorded and added to the high point (or previous bund line) reading to give the new desired reading.**
- **Move the staff down the crest of field edge until the desired reading is found.**
- **This position is then pegged as the new start point.**
- **If the HD is pre-determined then it is simple to measure or convert to VI for the particular slope.**
- **Check the slope at various points below each bund line and remember that the slope refers to the catchment that will drain to the next bund down.**
- **Peg at desired or standard gradients.**

**Remember to check the grade and direction of flow before construction.**

- **Increase the grade by 0.6% over the first 15 m near the crest and waterway to help intercept any roadside or channel runoff.**
- **Normally peg from crest to waterway except for storm drains (the reverse procedure), where bunds must end opposite at waterways for cross access and around obstructions.**

- **Draw pegging diagram with grades, lengths etc.**

## **Obstructions**

**In some areas obstructions will be found. In such cases the bunds should be placed at least 3 m away from termite hills, for instance, to avoid tight kinks in the line. It may be necessary to try a different grade to avoid the obstruction, pegging back from the 3 m distant location until the original peg line is met, but care should be taken. In some cases, excavation of the obstruction will be possible. It must be stressed that termite hills are very common in some areas and must be incorporated carefully to avoid bund failure.**

**When the lines are complete, kinks can be smoothed by moving low pegs uphill (NOT high pegs downslope). At least two consecutive pegs must remain in place undisturbed between moved pegs.**

**As soon as possible, the pegging lines should be ground-marked by hand or shallow disc cut. Any soil should be thrown downhill, so not to interfere with construction.**

**Contour Ridges Ploughed ridges and furrows are commonly used to prevent runoff and improve infiltration. Marker rows are first set out:**

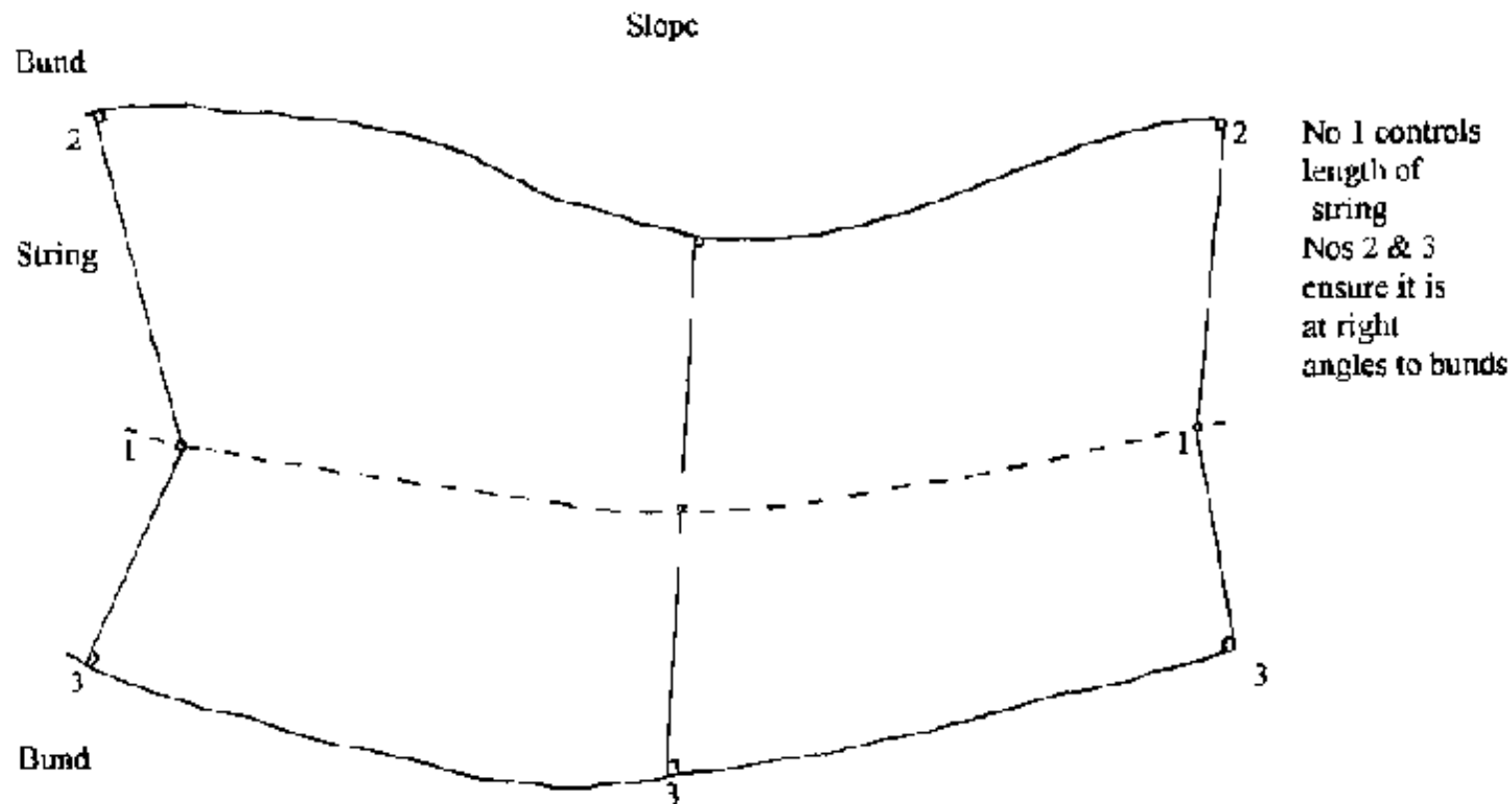
- **Using a level, mark contour lines every 20 -30 m down the slope.**
- **Peg at 15 m or less**
- **Do not peg across drainage lines.**

## **Master Rows and Microcatchments**

**Master rows are used to ensure that ridges have gradients no less than that of the main bund that determines their location.**

**Alternatively, they can be used to restrict runoff when cross-tied. A master row is pegged out between bunds either parallel to the upper bund where bunds converge or parallel to the lower bund where they diverge. Figure 7.23 shows how master rows are positioned in relation to bunds. Note that during pegging the string used to determine pegging positions is kept at right angles to both bunds.**

**Where a master row runs into a lower bund, move at right angles to the master row and start a new row at the upper bund. Ground mark the row. Microcatchments are made by cross-tying at the construction stage, to no more than two thirds of the ridge height. When pegging is complete, it is essential to draw a field diagram. This allows the farmer to assess accurately the area of land under cultivation, it provides construction details of waterways etc. and shows how much land is lost to obstructions, roads, bunds and other non-cultivated areas.**



**Figure 7.23: Pegging a Master Row**

### 7.3.2 Construction

**It is essential that the construction of water conservation structures proceeds in the correct sequence. In the case of simple water harvesting structures, such as Zay and Demi-lunes, construction is straightforward, but it is becoming increasingly recognised that to be successful, water harvesting schemes must be viewed as features integral to the landscape.**

**The overall control of runoff and its safe redistribution and disposal are also critical in preventing destructive water movement. This will quickly become self-evident in**

**areas where extensive water control by conservation structures is attempted.**

## **Waterways, Drains and Bunds**

**These are constructed according to permissible velocities and unless the design grass cover has been achieved, erosion will take place when runoff occurs. For this reason waterways must be constructed one or two seasons before other works. Careful planning is needed to integrate this time scale into project activities.**

**Subsoil exposure can be a serious problem. Grass cover will not be encouraged and every effort must be made to improve condition for vegetation growth. This can be done by spreading back top soil, including mulches, manure or fertiliser. Where possible, the creeping species of the waterway are best replaced by grasses with a bunching habit at the edge to restrict spreading onto the field. Water when necessary, if possible.**

**Waterways should never be used as roads or serious erosion will take place. Grazing should be controlled to encourage spreading growth.**

**The danger of obstructing the drainage from bunds into a waterway must be recognised, especially where the sides of a waterway are used by vehicles. This will lead to dangerous over-topping of the bunds and render the waterway useless, and must be avoided at all times.**

**Storm drains are constructed after waterways have been stabilised with vegetation and before bunds have been made.**

**Bunds are only constructed after waterways and storm drains, and construction**

**starts at the top of the field, working downwards. If they are not, the drainage they cause worsens a difficult situation. It may be very important to explain this to farmers, who often see bunds as the total solution to water control.**

## **Costs and Equipment**

**The equipment with which construction is undertaken will depend upon the locality, the economic status of the farmers and the inputs from the project and other external sources. The most appropriate equipment must be determined carefully according to local circumstances and the ability of farmers to sustain the inputs once project support has been removed.**

**Frequently, the costs involved in the construction of water harvesting and conservation systems are difficult to quantify. The data on costs are very approximate. Often labour costs are not accurately accounted and the cost of long term maintenance is not considered. Moreover, both costs and benefits are highly variable locally, for instance some farmers weed thoroughly and do not regard such inputs as being anything "extra", whereas other farmers do. Byproducts of farm production such as stover and residue grazing may not be accounted for, nor even exploited.**

**The financial costs of water harvesting structures in particular can be highly variable, perhaps from US\$ 50 - US\$ 1000 per hectare. Where mechanised transport is used to import rocks for bunds, and where tractors and bulldozers are used to move earth, costs are always very high compared to small hand made structures. However, the mechanised systems may allow water control over a larger area and permit a more fully integrated approach to water harvesting. This can bring benefits in erosion control at the large scale, but these benefits may not be recognised or**



**accounted for.**

## **Hand Construction:**

**Hand tools and manual labour will limit the size of structures that can be built and the scale of activities. However, the advantages of cost and sustainability should not be overlooked. Hand tools can provide a flexibility of operation that is not attainable by machinery and both ridge-based and broad-based bunds are best finished by hand. In many cases this equipment will be the most suitable and the control of such labour does not impose any serious technical difficulties, beyond limitations of scale.**

## **Ploughs:**

**Figure 7.24 shows the construction of a waterway by disc plough. The plough should be correctly set. Once the soil is pulverised it should be allowed to settle, encouraged by water (or rain) if possible. An increase in tractor speed will increase bank height. More discs are best suited to large straight structures, fewer discs for bunds. Other ploughs can be used.**

## **Other Machinery:**

**Blades: only powerful machinery can move soil with a blade and the use of such equipment is rarely warranted, except for large structures.**

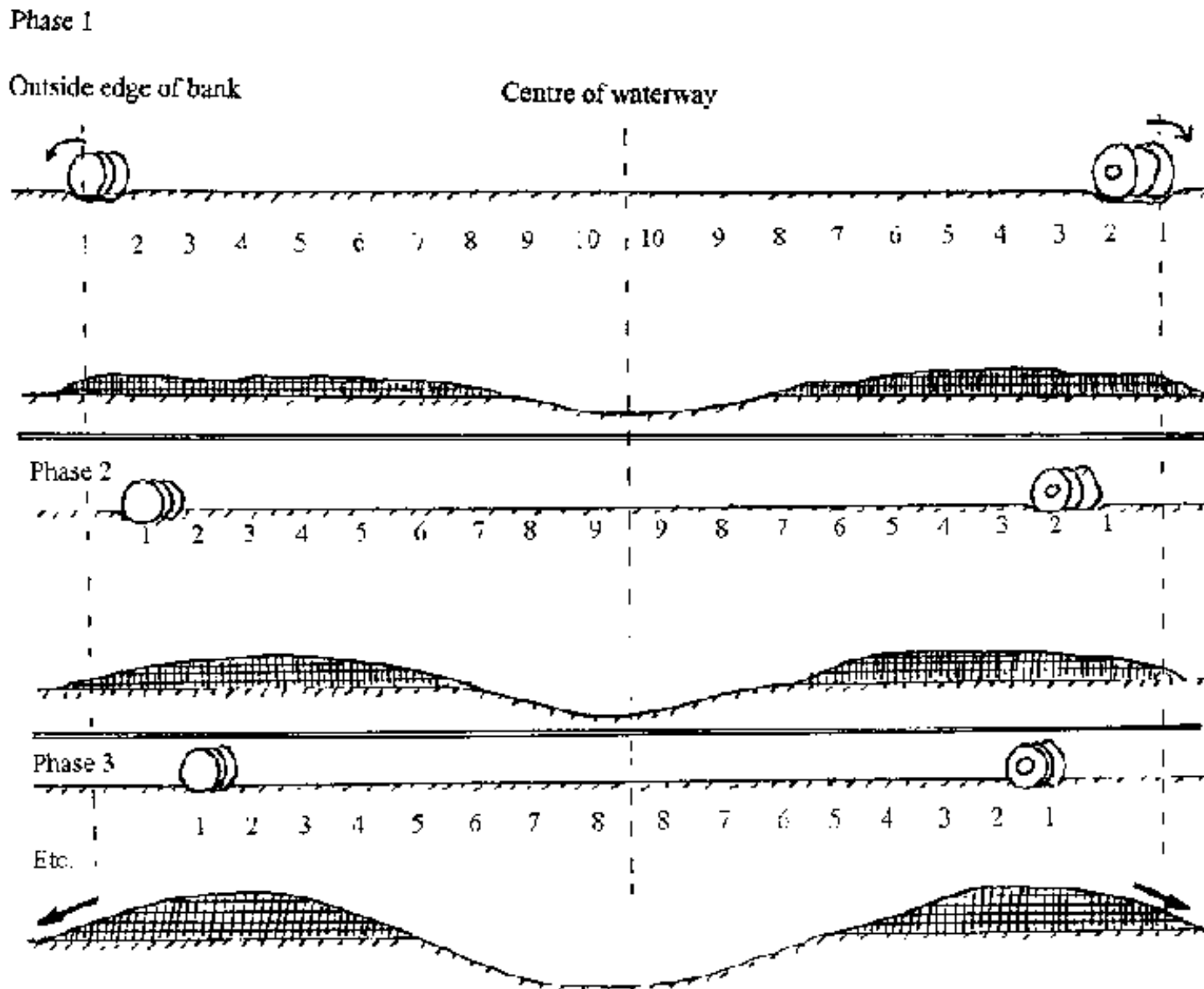
**Scoops: animal drawn scoops can be very useful for bund construction, after soil has been loosened by ploughing. Alternatively scoops can be moved by tractor.**

**Various ridgers, trenchers and ridge tying units have been developed to suit local**

**needs.**

**Figure 7.25 shows the construction of bunds using a disc plough.**

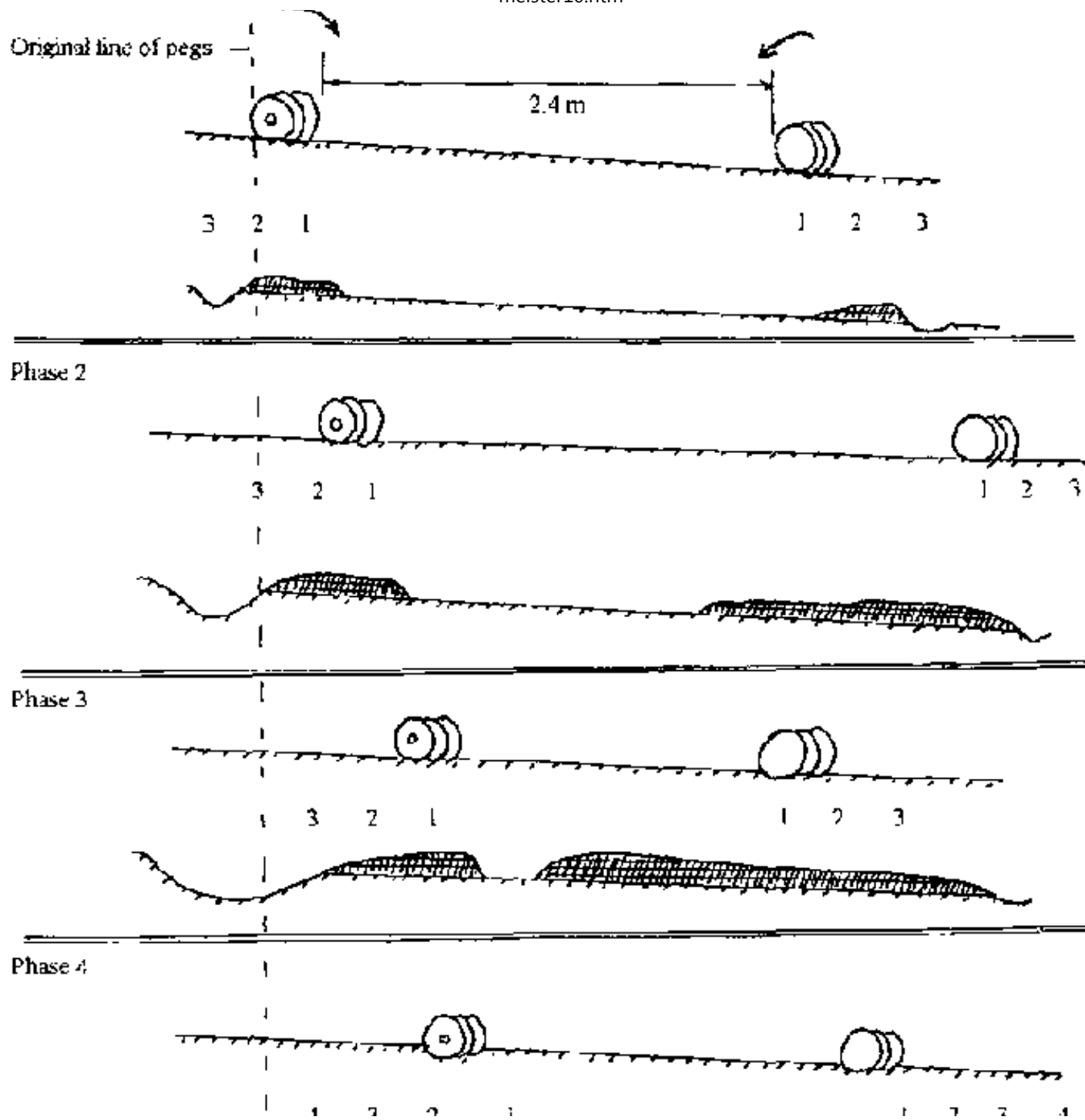
**Numbers indicate position of equipment for each round. Apply water after each two phases, continue until required section is achieved. Final section is smoothed with a blade terracer or by hand.**



**Figure 7.24: Construction of Waterway with Disc Plough**

**Numbers indicate position of equipment at each round**

Phase 1





**Figure 7.25: Using a Disc Plough to Construct Bunds**

## Equipment costs

**All costs of locally made equipment are approximate. The costs of raw materials and especially labour are highly variable from country to country, but a good idea of cost magnitude can be gained from the figures quoted below. The costs of manufactured equipment are based on 1993 prices. Shipping costs, agents' fees and fluctuations in exchange rate cannot be taken into account.**

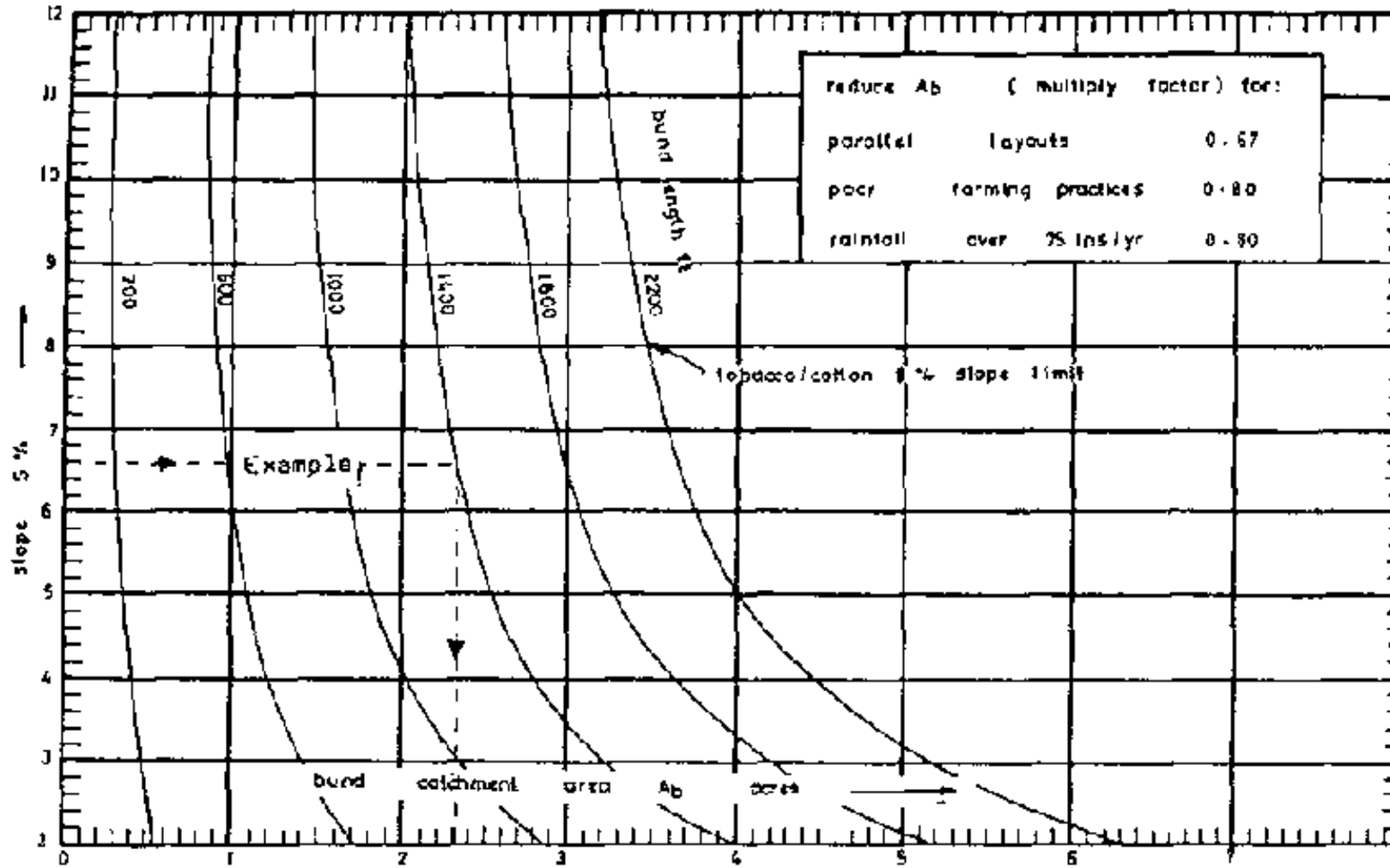
<b>Item US</b>	<b>Quantity</b>	<b>Typical Approximate Cost in \$</b>
Abney level complete	1	200 -300
Automatic level complete	1	600 -800
Levelling staff	5 m	50 -100

## Appendix D1: Bund dimensions for various areas, slopes and soil types

**Bund Length - Catchment Area versus Slope SAND  $V.I = \% S + 3 / 2$  (VI in feet)**

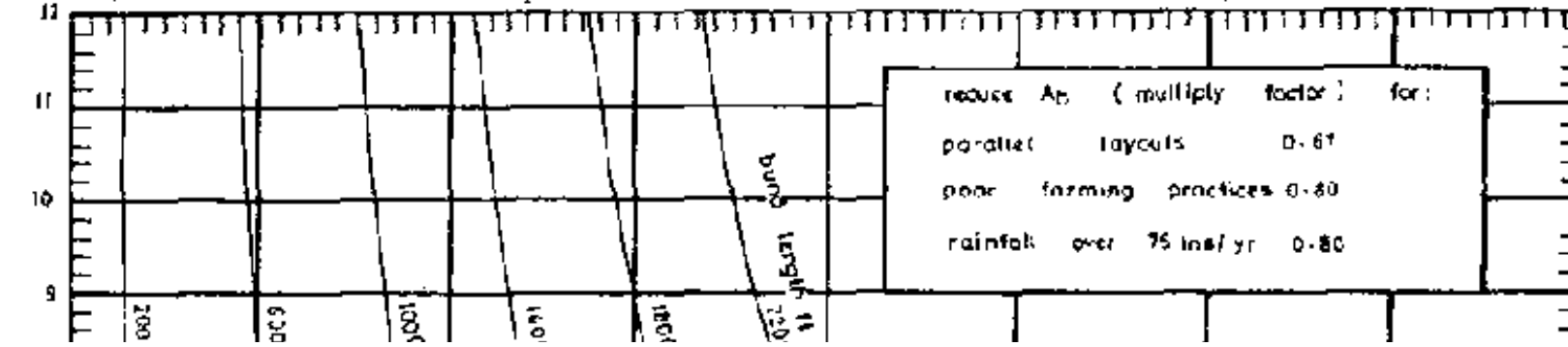
**Note: 1 metre 3.281 feet**

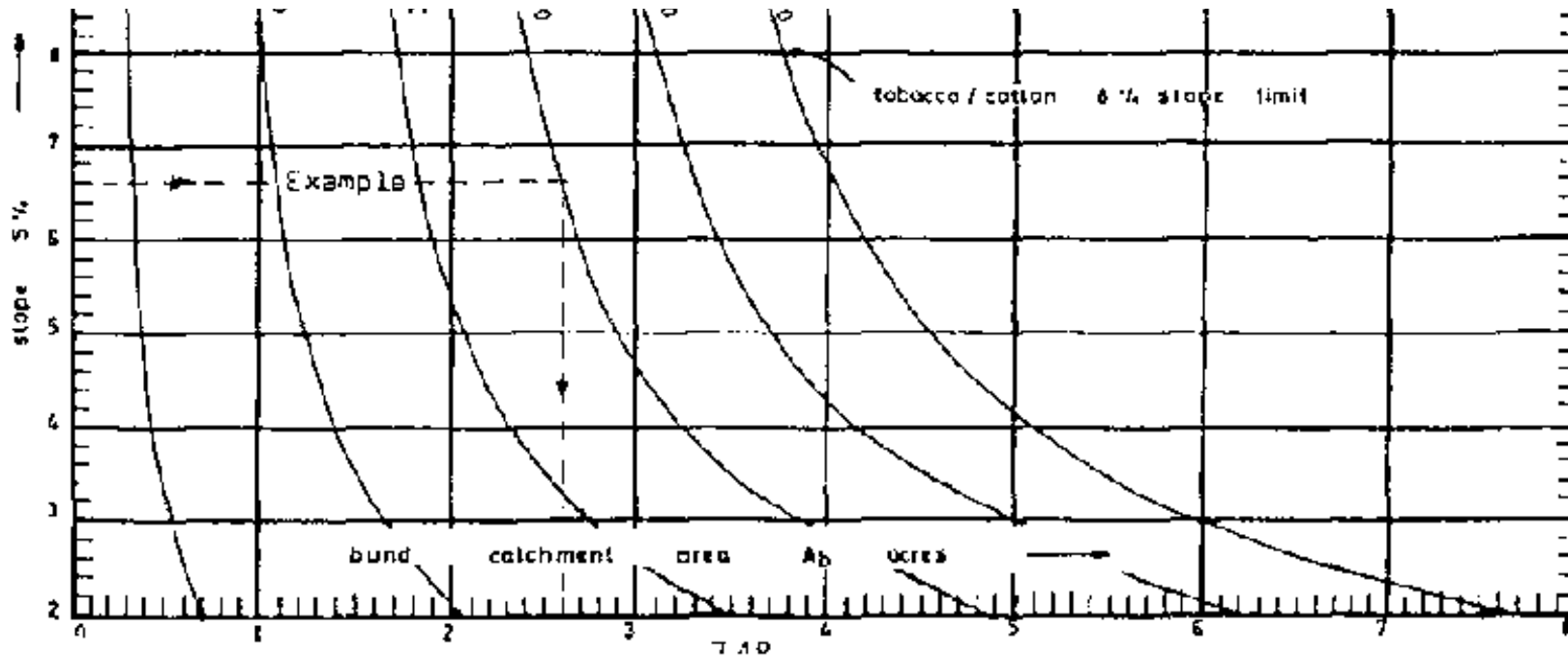
**1 hectare 2.47 acres**



Bund Length - Catchment Area versus Slope

LOAMY SAND  $V.I = \% S + 4 / 2$  (VI in feet)

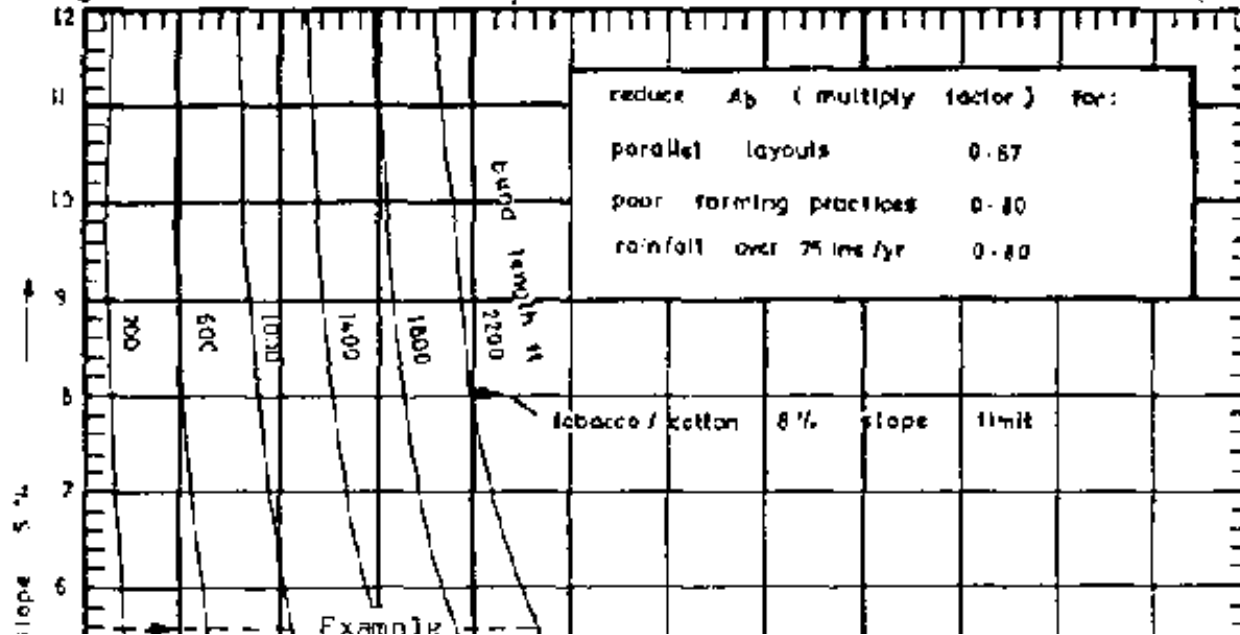


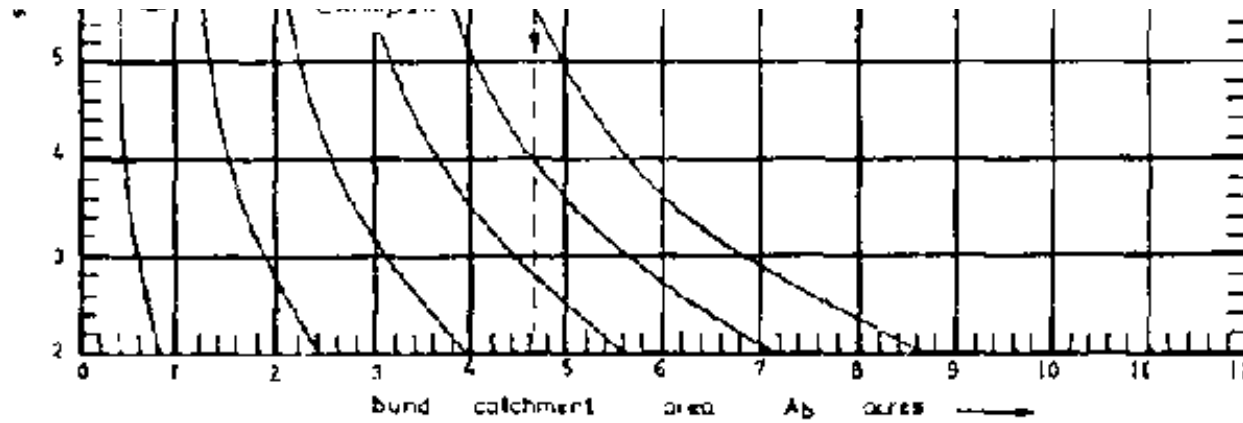


Figure

Bund Length - Catchment Area versus Slope

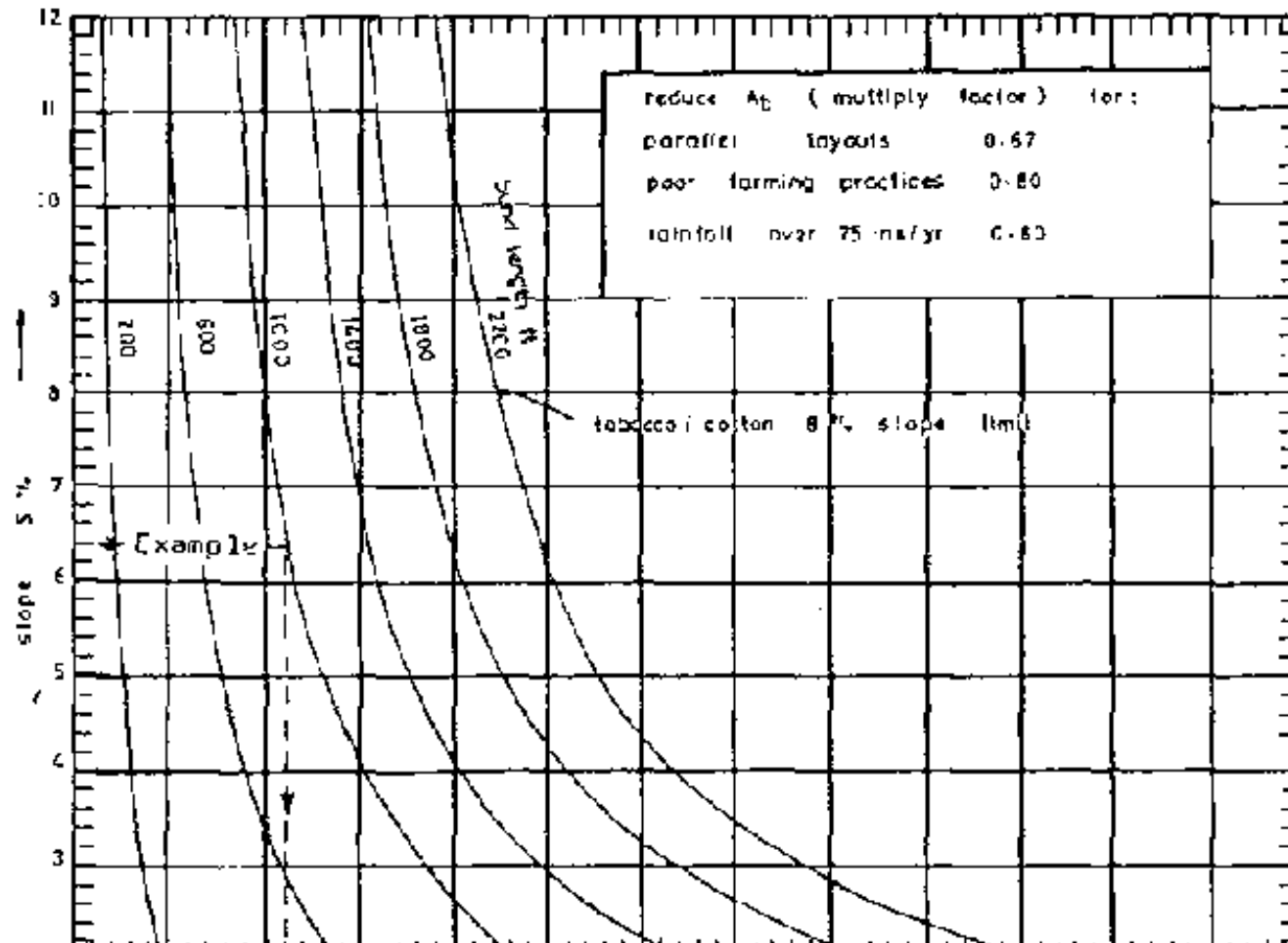
SANDY LOAM  $V_L = \% S + S/2$  ( $V_L$  in feet)



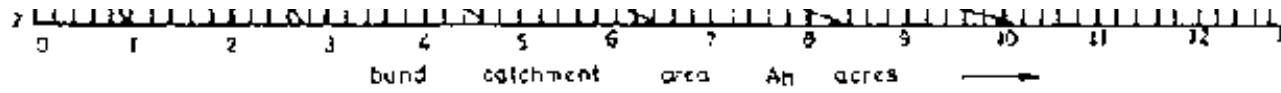


Bund Length - Catchment Area versus Slope

SANDY CLAY LOAM  $V.I \approx \% S + 6/2$  (VI in feet)



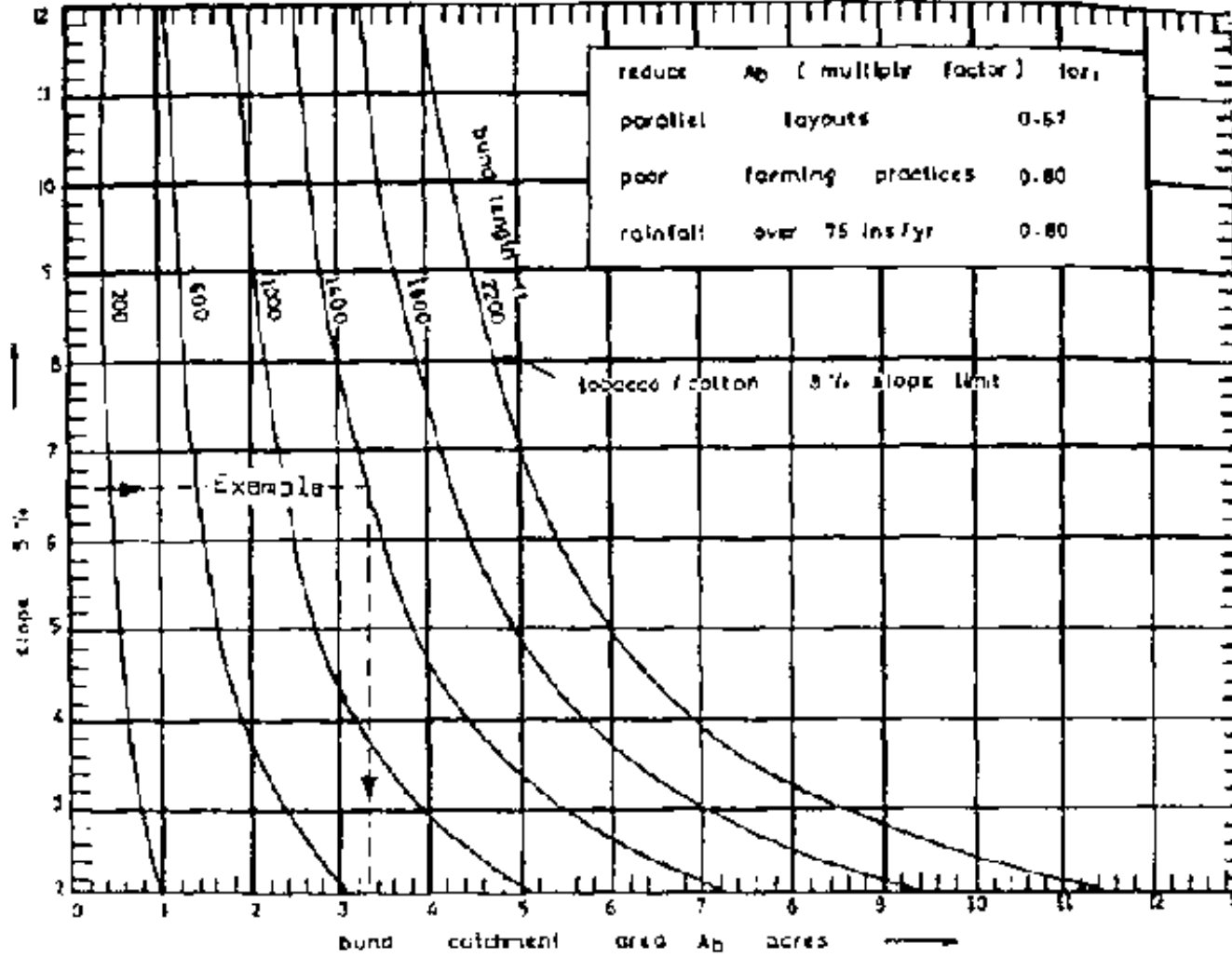




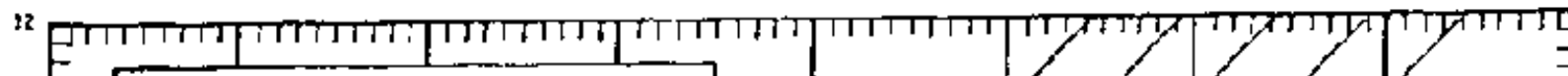
Figure

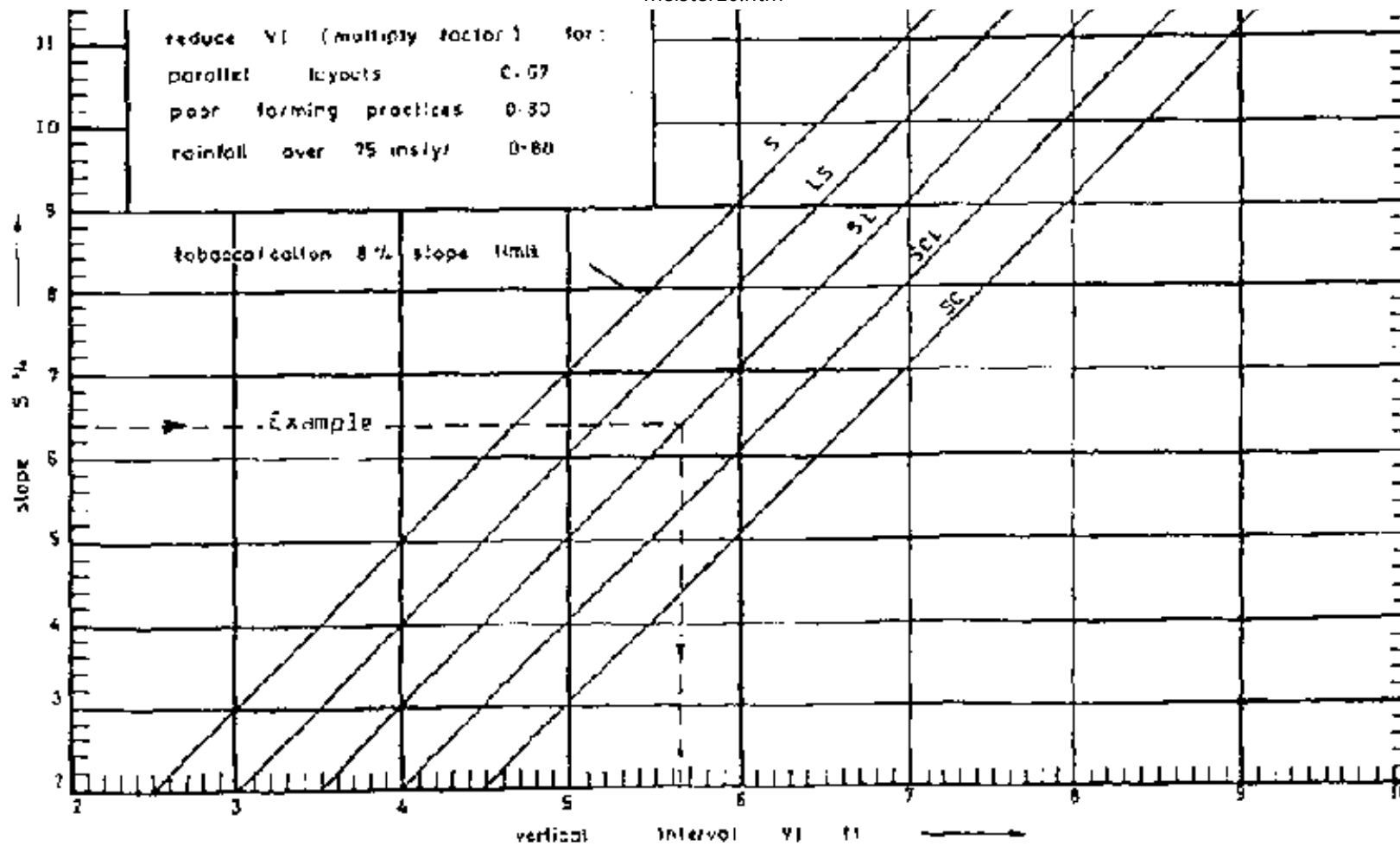
Bund Length - Catchment Area versus Slope

SANDY CLAY  $VI = \%S + 7/2$  (VI in feet)

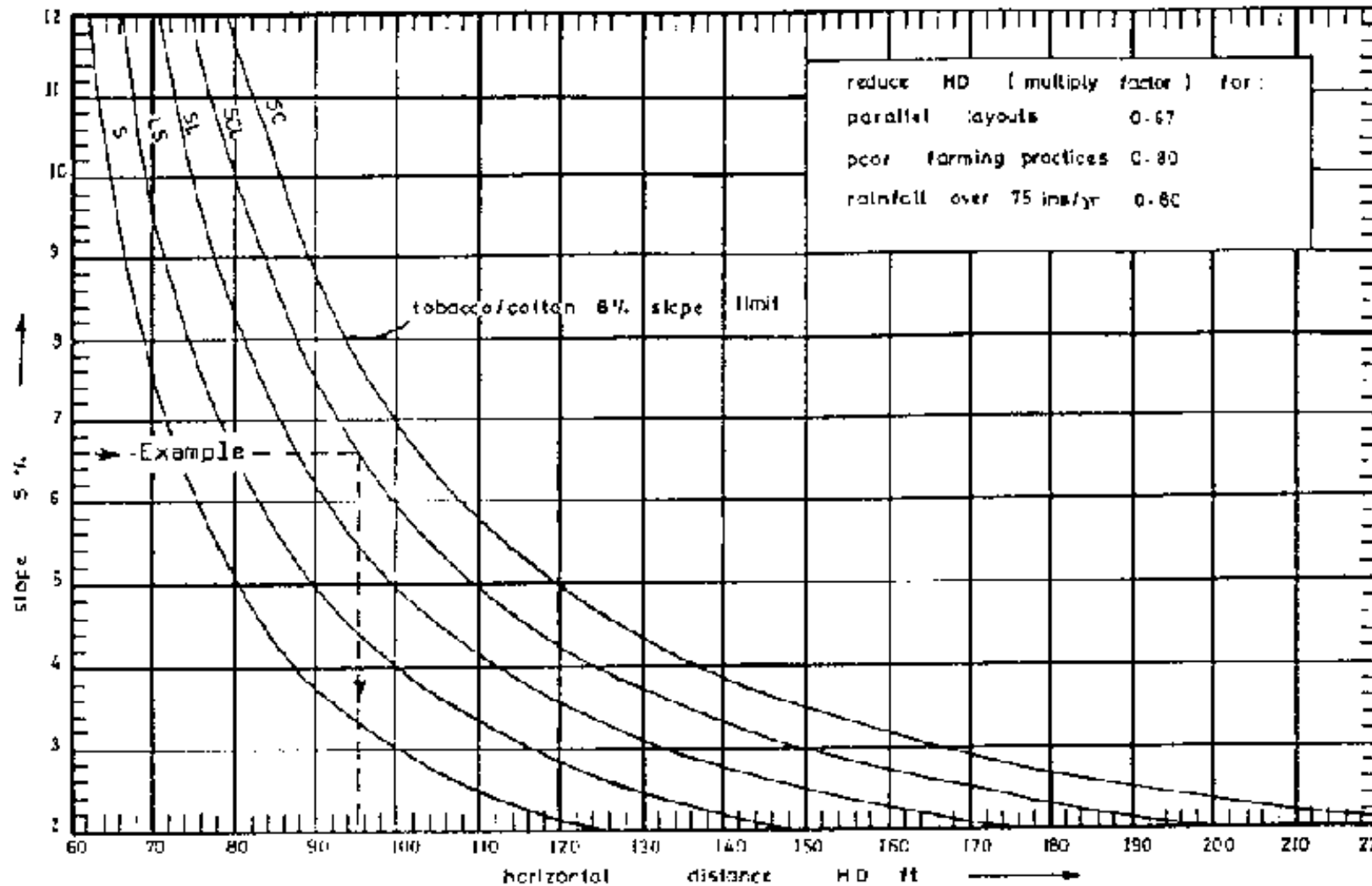


Bund Spacing - Vertical Interval versus Slope (feet)





Figure



**Bund Spacing - Horizontal Distance versus Slope (feet)**

**Conversion Factors:**

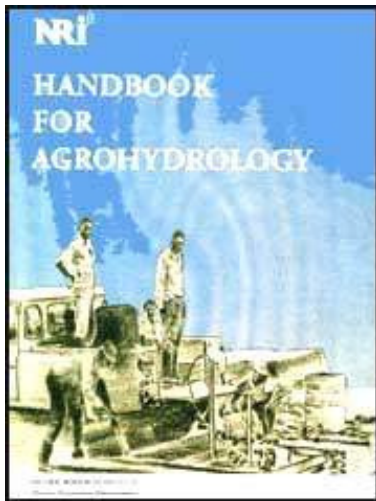
**1 foot 0.3048 metre**

**1 inch 2.540 centimetre**

**1 acre 0.4047 hectare**



[Home](#) > [ar.cn.de.en.es.fr.id.it.ph.po.ru.sw](#)



## Handbook for Agrohydrology (NRI)

### Chapter 8: Data analysis

 *(introduction...)*

 **8.1 Statistical methods and data analysis**

 **8.2 Non-statistical analysis of agrohydrological data**

 **Appendix E: Data analysis**

## **Handbook for Agrohydrology (NRI)**

### **Chapter 8: Data analysis**

**Although runoff information is most important to the hydrologist, it cannot be treated in isolation and many of the methods of analysis used on runoff data are commonly applied to other types of information. The analysis of all data is extremely important because it can be used to understand why and how processes happen, though many statistical methods ignore the understanding of behaviour and focus upon probabilities, fitting data to particular distribution patterns, the form of which can be defined. Knowledge of both the processes that take place and**

**statistical methods used to predict hydrological behaviour should be sought. A knowledge of statistics is essential in data analysis, and in this chapter a deliberate attempt has been made to include a comprehensive explanation of statistical methods while at the same time avoiding over-detailed statistical theory. The intention is to help in the selection of the correct techniques of analysis and explain how they are used.**

**The desire to understand the complex inter-relation of hydrological processes and, later, the temptation to ignore this complexity for statistical methods has led to three main approaches to the study and treatment of hydrological data.**

**Deterministic Hydrology: assumes that certain influences determine the passage of rain to its ultimate destination, and that the physical environment is responsible for the presence and level of importance of these influences. No concept of probability is involved, although where deterministic models are used, their accuracy is defined by statistical parameters.**

**Probabilistic Analysis: defines the chance of particular values of data occurring. It is independent of time and sequences of events do not carry any significance.**

**Stochastic Methods: recognise that probability plays a large part in the nature of hydrological data, but also that the sequence of the data also carries significant information. In many instances, this type of analysis may be regarded as a combination of the two other methods.**

**Hydrological data are stochastic in reality, but it is easier to deal with them, mathematically at least, if they are regarded as probabilistic or deterministic.**

**Stochastic data represent a time series that may be viewed in discrete periods or**

**continuously. The daily, monthly or yearly flow hydrographs are good examples.**

**An understanding of hydrological processes enables a pattern to be fitted to runoff events that have numerical values. This pattern-fitting is used to predict hydrological behaviour and is often referred to as "modelling", though the term is often over-used; a simple regression that states that 20 mm of rainfall on a given catchment will produce 100 m<sup>3</sup> of runoff under particular conditions will often be referred to as a statistical "model".**

**It is not surprising that hydrological analyses and models have become progressively complex. The attempt to derive models that can be generalised for use in many geographical regions, yet at the same time give accurate results, demands complexity, but could be regarded as self-defeating. In addition, many hydrological data must be analysed in a manner that cannot be regarded as "modelling" in any mathematical sense. These analyses are essentially the treatment of data to provide further information or to render basic data into more useful forms.**

**It is important however, to evaluate carefully the needs that are required for a particular project. The simple treatment of hydrological information, collected in the area for which results will be applied, can be far more useful to agricultural development than complex, imported models generalised from parochial results.**

**For many projects the cost of data collection (both in money and time) and the duration of records will impose severe limitations on the analysis of data and the development of models. For example, the simple linear regression of daily rainfall against runoff not only provides a causal relation, the accuracy of which can be quantified, but in the context of long-term daily rainfall records (which are usually available in most countries) can give an acceptable probability basis upon which to**

**plan field layouts and runoff control. The data collected from many projects may not be adequate to allow a more sophisticated treatment. The following chapter concentrates on the important analyses that should be considered when agrohydrological information is being studied.**

**This chapter is subdivided into two main sections:**

## **8.1 Statistical Methods and Data Analysis**

**This section deals with the statistical methods that are essential techniques in the analysis of data and provides examples of particular statistical methods to ensure that the general forms of analyses which are described, are fully understood. The data under study and which is used to provide examples are hydrological data. However, these statistical methods are applied to other information, most commonly rainfall information.**

## **8.2 Non-Statistical Analysis of Data**

**This section discusses methods by which data that are not amenable to statistical treatment are prepared and studied; often these treatments are concerned with changing basic information into a more useful form. Sections on the analysis of hydrological, rainfall and meteorological, evapotranspiration and sedimentation data are included.**

### **8.1 Statistical methods and data analysis**

**There are several kinds of hydrological data that may be collected. The quality of these data will be determined by various errors.**

**Random Errors:** cannot be avoided, though good practice keeps them to a minimum. They are assumed to have a statistically normal distribution, that is that there are as many low values as high values distributed around the mean, and that there are more values close to the mean than at the high and low value extremes.

**Systematic Errors:** usually show an increasing or decreasing trend, for example reduced water depth measurements due to the progressive stretching of a measuring cable.

**Non-homogeneity:** is not an error as such, but effects the values of time series data in a progressive way. It may be due to changes in catchment characteristics; for example progressive de-forestation, causing a trend of increased runoff.

The term "population" is often used in statistical analysis and is used to describe the variable values that are under consideration, the sample population may be regarded as a selected group of those values that are used.

### **8.1.1 Elementary Statistical Properties**

#### **Mean, Median and Mode**

The arithmetic mean is a widely understood idea. It is easily calculated and is the usual method of describing the "central tendency" of a group of data. With distributions that have a small sample of very high or very low values, the mean may be greatly influenced by these values and may not accurately reflect the central tendency of the data, a situation often found with runoff and rainfall data which often have a few, very high values.



**The median value is that which falls exactly in the middle of a range of values and not is affected by the weighting of a few extremely small or large values. Hydrological data often takes this type of distribution and therefore the median is frequently used.**

**The mode is the value in a group of data that occurs most frequently and used in extreme value asymptotic functions.**

### **Standard Deviation and Coefficient of Variance**

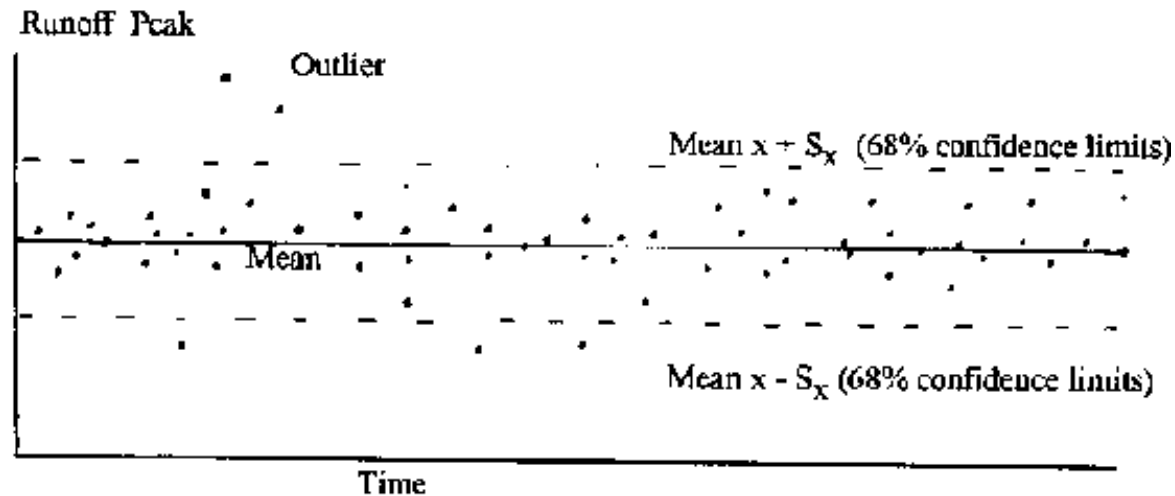
**The standard deviation is a measure of dispersion of values of a variable "x" around the mean value. It is the square root of the mean-squared deviation of individual measurements from their mean and is defined by the equation for unbiased standard deviation, which is preferred:**

**xxxxxxxxxxxxxxxx(8.1)**

**where  $\bar{x}$  = mean of x**

**It may be regarded in a non-statistical sense as the "average" value of dispersion of values from the mean.**

**Figure 8.1 below shows a set of time series data with the arithmetic mean and standard deviations. One standard deviation + and - the mean represent the 68% level confidence limits.**



**Figure 8.1: Elementary Statistics of Time Series Data**

**The standard deviation is denoted by  $d$ . The standard deviation of a sampling distribution is the standard error. The standard error of the mean =**

**xxxxxxxxxxxxx(8.2)**

**and standard error of the standard deviation is =**

**xxxxxxxxxxxxx(8.3)**

**The variance is the square of the standard deviation. The coefficient of variation is a dimensionless measure of the dispersion around the mean and is defined by:**

**Std dev,  $-S_x/$**

**xxxxxxxxxxxxx(8.4)**

**Statistical computer programs and many electronic calculators give these parameters as a matter of course, though they may be calculated manually if necessary.**

## **Skewness**

**The lack of symmetry of a distribution around the mean is called skewness. The skewness of the population is defined as:**

**xxxxxxxxxxxxxxxx(8.5)**

**The unbiased estimate of skewness from the sample is given by:**

**xxxxxxxxxxxxxxxx(8.6)**

### **8.1.2 Correlation Analysis**

**Correlation analysis measures the association of one variable with another; and is often used to define associations between several variables. The table that defines these relations is called a correlation matrix and is a standard part of the output of statistical analysis computer packages. The variation of both (or all) variables is not fixed by the observer nor by control and unlike regression analysis, correlation does not pre-suppose a causal relation between the variables. Because no inference of causality is present, correlation does not allow the prediction of values of one variable from another (as does regression), by the use of a formula that describes**

**the correlation. However, correlation defines association and has a practical application; it is used to select variables that are suitable for multiple regression analysis.**

**For example, it may be required to obtain an equation by multiple regression (using previously collected data) that will predict runoff amount, given that values for rainfall amount and catchment physical characteristics are available. Table 8.1 illustrates this. A number of variables, obtained from catchments in Belize, Central America, were used in multiple correlation analysis were used in this example.**

AREA	AREA	RSMD	STRFQ	GRFPN	SPFPN	AMSSL	SOS	BSL	MSLE
AREA	1.000								
RSMD	-.912	1.000							
STRFQ	-.580	.627	1.000						
GRFPN	.203	.083	-.311	1.000					
SPFPN	.129	.158	-.297	.995	1.000				
AMSSL	-.933	.852	.748	-.415	-.355	1.000			
SOS	-.489	.607	.961	-.105	-.094	.605	1.000		
BSL	-.752	.742	.962	-.412	.358	.895	.875	1.000	
MSLE	.905	-.712	-.654	.580	.524	-.939	-.483	-.825	1.000

**Table 8.1: Correlation Matrix of Hydrological Variables**

**It can be seen that pairs of variables such as catchment area (AREA) and mainstream length (MSLE); stream frequency (STRFQ) and the soil/slope index**

**(SOS); Average main stream slope (AMSSL) and basin slope (BSL), are highly correlated. In regression, variables used as "independent" variables should be independent of each other and should not be significantly correlated. It is not appropriate to use highly correlated variables, such as those in the example pairs, together in the same regression analysis. The inclusion of correlated variables does very little to improve the quality of the resulting equation.**

**The numerical value that describes relations between variables is the "correlation coefficient", 'r' and relates to the sample data. Correlations can be positive or negative. As the number in the sample becomes large the distribution of the standardised variable "t" can be used to test the significance of the correlation (Student's "t" test).**

degrees of freedom	0.05 (95%)	0.01 (99%)	0.001 (99.9%)
1	0.9 <sup>2</sup> 692	0.9 <sup>3</sup> 877	0.9 <sup>5</sup> 877
2	0.9500	0.9 <sup>2</sup> 000	0.9 <sup>3</sup> 000
3	0.878	0.9587	0.9 <sup>2</sup> 114
4	0.811	0.9172	0.9741
5	0.754	0.875	0.9509
6	0.707	0.834	0.9249
7	0.666	0.798	0.898
8	0.632	0.765	0.872
9	0.602	0.735	0.847
10	0.576	0.708	0.823
11	0.553	0.684	0.801
12	0.532	0.661	0.780
13	0.514	0.641	0.760
14	0.497	0.623	0.742
15	0.482	0.606	0.725
16	0.468	0.590	0.709
17	0.456	0.575	0.693
18	0.444	0.561	0.678
19	0.433	0.549	0.665
20	0.423	0.537	0.652
25	0.381	0.487	0.597
30	0.349	0.449	0.554
35	0.325	0.418	0.519
40	0.304	0.393	0.490
45	0.288	0.372	0.465
50	0.273	0.354	0.443
50	0.250	0.325	0.408
70	0.232	0.302	0.380
80	0.217	0.283	0.357
90	0.205	0.267	0.338
100	0.195	0.254	0.321

**Table 8.2: gives data for testing the significance of correlation between variables. They may also be used for testing significance in regression analysis.**

## **Correlation Significance Examples:**

**a. SOS (soils/slope index) and STRFQ (stream frequency in terms of number of streams per square kilometre) have: a correlation coefficient,  $r = 0.961$ ,  $n$ , the number of data points (or "sample size") = 15 degrees of freedom (d.f) =  $n - 2 = 13$**

**From Table 8.2, variables with a correlation coefficient greater than 0.760 are significantly correlated to the 99.9% level (0.001) and these variables would not be suitable for simultaneous inclusion in regression analysis. Indeed, even a significance level of 90% (0.1) would justify their mutual exclusion.**

**b. SPFN (floodplain area) and RSMD (a soil moisture deficit index) have:  $r = 0.158$ ,  $n = 15$ ,  $d.f = 13$**

**From Table 8.2, the relation is not nearly significant even at the 0.1 (90.0% ) level and these variables would be suitable for simultaneous inclusion in regression analysis. Standard textbooks on statistics provide a more detailed background on the "t" distribution and limiting conditions for its use.**

degrees of freedom	0.05 (95%)	0.01 (99%)	0.001 (99.9%)
1	0.92692	0.93877	0.95877
2	0.9500	0.92000	0.93000
3	0.878	0.9587	0.92114
4	0.811	0.9172	0.9741
5	0.754	0.875	0.9509
6	0.707	0.834	0.9249
7	0.666	0.798	0.898
8	0.632	0.765	0.872
9	0.602	0.735	0.847
10	0.576	0.708	0.823
11	0.553	0.684	0.801
12	0.532	0.661	0.780
13	0.514	0.641	0.760
14	0.497	0.623	0.742
15	0.482	0.606	0.725
16	0.468	0.590	0.709
17	0.456	0.575	0.693
18	0.444	0.561	0.678
19	0.433	0.549	0.665
20	0.423	0.537	0.652
25	0.381	0.487	0.597
30	0.349	0.449	0.554
35	0.325	0.418	0.519
40	0.304	0.393	0.490
45	0.288	0.372	0.465
50	0.273	0.354	0.443
50	0.250	0.325	0.408
70	0.232	0.302	0.380
80	0.217	0.283	0.357
90	0.205	0.267	0.338
100	0.195	0.254	0.321

**Table 8.2: Table for Testing the Significance of the Correlation Coefficient 'r'**



### **8.1.3 Regression Analysis**

#### **Methods Usually Adopted to Estimate Flow Volumes**

##### **a Simple Regression**

**Regression analysis is a widely used method to derive formulae that define the relation between two variables and unlike correlation analysis, admits this relation to be causal. Very many of the predictive or relation equations found in the literature and that link hydrological parameters are in fact regression equations.**

**Regression analysis is often seen as a simple x-y graph, but with distributions of real data, it is rare that all the data points fit exactly on the line of best fit drawn through them. An even balance of points on, above and below the line is sought, with the line drawn to minimise the dispersion of points around the line. The method of "least squares" is used to draw such lines, and although regression and the least square for each point can be calculated manually, computer programs that provide a best fit in this way are so common that manual calculation is almost obsolete. A standard textbook on statistical techniques will provide examples of these manual computations, if desired.**

**The values of the independent variable are plotted on the x axis (in this case rainfall) while the values of the dependent variable (runoff) are plotted on the y axis. The initial step is to plot a scatter diagram of values of y on x. This gives a visual idea of whether a significant relation between the two variables may exist, but does not define it. Statistical computer packages (and sometimes graphics packages also) are widely available to plot scatter diagrams and undertake regression. They will also provide numerical values for equation 8.1, evaluate the**

**significance of the relation and quantify residuals (the errors in the fit of the regression line) and confidence limits. The form of the equation of simple regression is:**

$$y = a + b(x) \text{ where (8.7)}$$

**y = runoff**

**x = rainfall**

**a = intercept value**

**b = gradient of the graph (a and b are known as regression coefficients)**

**The selection of variables for regression is based on a reasonable assumption that a variation of the independent variable will cause a variation in the dependent variable. A good example is the relation between rainfall and runoff; it is most important in the runoff process and the starting point for most runoff analyses. Figures 8.2 (a) and (b) show examples of linear regression using daily rainfall and runoff values from two rangeland runoff plots of 0.4 ha extent. The details of the relations are given.**

(a) $y = 1.0497x - 6.30$	(b) $y = 0.1266x + 1.16$
$n = 44$	$n = 10$
$R^2 = 0.83$	$R^2 = 0.34$
$P < 0.001$	$P > 0.05$

**The relation is significant to the 99.9% level**

**The relation is not significant to the 95% level**

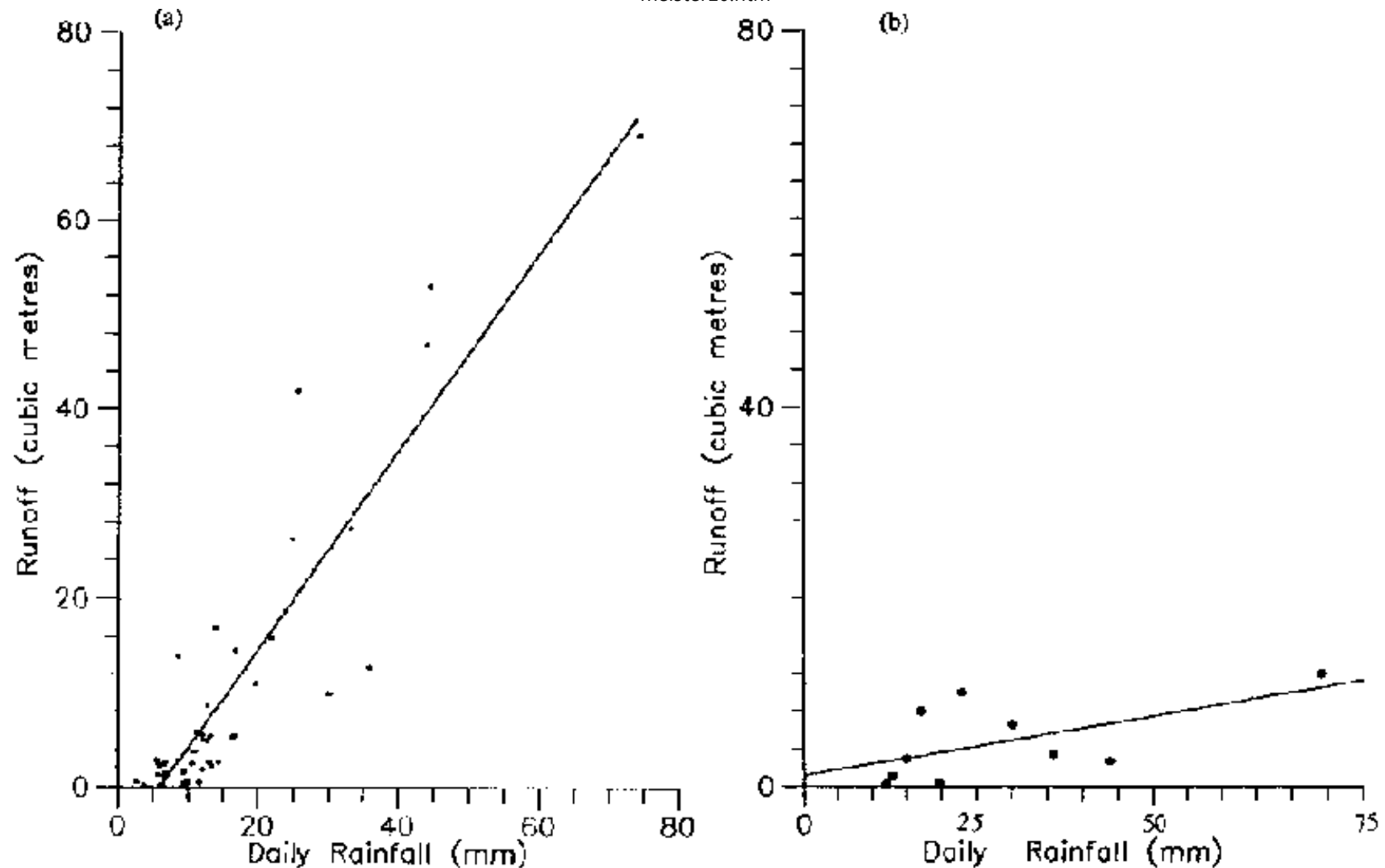
**In the case of graph (a), a significant linear relation may be assumed from the distribution of the data points. When the regression analysis is complete this significance is verified to the 99.9% level. This indicates that there is a less than a one in one thousand chance that the distribution of these data points is due to chance and indicates a strong causal relation between the amount of rainfall and the amount of runoff. The value of  $R^2$  (the coefficient of determination) indicates that the variation in rainfall explains 83% of the variation in runoff.**

**No definition of the influence of other catchment factors which determine the amount of runoff from a plot such as this (soil texture, slope, vegetation cover etc.) can be made, other than that, combined, they account for the remaining 17% of variation.**

**The distribution of data points in graph (b) may appear to show a significant relation, but the value of  $R^2$  is 0.34 and testing shows that this is not significant to the 99.9% level, nor even to the 95% level. There is more than a one in twenty chance that the relation is explained by chance, rather than the influence of rainfall amount on runoff amount. The selection of significance levels is one of subjective choice. As a hypothetical example, the relation of graph (b) may be significant at the 50% level, but this admits that chance is as likely as not to be responsible for the apparent relation. In general, the 95% level is the lowest accepted, though the convenience of the 68% level of confidence being equal to the mean + / - one standard deviation results in its occasional use.**

**The availability of data for analysis is an important consideration in experimental planning and the collection of data. Analyses with very few data points need very high values of  $R^2$  to assure significance, since the number of degrees of freedom**

**(d.f.) are =  $n - 2$  and with few data, values of d.f. are very small. Graph 8.2 (b) has only 10 - 28 degrees of freedom and its  $R^2$  would need to be 0.87 to give  $P < 0.001$  (99.9%), whereas graph (a) with 42 degrees of freedom would only need an  $R^2$  of 0.48 or so. Where runoff data are expected to be sparse, for example in arid and semi-arid climates, a single runoff plot that typifies one kind of environment will not be adequate to provide a sufficient number of data for useful analysis, unless it is monitored for many seasons. The data for graph (b) represents the collection of information over three seasons; runoff was rare, some data were lost and the dataset of 10 values is really inadequate for use in regression analysis.**



**Figures 8.2 (a) and (b) Regression of Daily Rainfall Versus Runoff**

**A shortfall of data for large rainfall/runoff events is a particular problem. Such events are naturally infrequent, but are usually of great interest. If the influence of rainfall on runoff is the case under study, there is strong justification for the use of many replicate plots of the same soil, slope, vegetation cover, etc., that are located together and which experience the same rainfall. The data from such replicates**

**could be combined into one dataset and used as though they came from one plot.**

**The independent variable under study (in this case rainfall amount) should be allowed to range as widely as possible, while the values of all other influences (for example catchment size, slope and vegetation cover) should be kept under tight control. This approach requires extensive replication and the cost of construction, instrumentation and monitoring must be balanced against the increase of data that is achieved. The input to collect sufficient data during a project's time, may exclude experimentation in other areas of interest.**

**Data from catchments that are only generally similar may also be combined so that the range of physical circumstances to which the equations can be applied may be widened, but the accuracy of such equations in predicting the response of the dependent variable will be lessened. Simple linear regression can be undertaken between many factors, though most combinations are likely to involve runoff as the dependent variable.**

### **Goodness of fit**

**The Chi-square goodness of fit test can be used to decide whether a line fitted by one method of fitting is more accurate than that of another method; for example whether the least squares technique is more accurate than fitting a regression line by eye, or whether one theoretical statistical distribution gives a closer fit than another.**

**The Chi-square parameter is defined as**

## **XXXXXXXXXXXXXXXXXXXX(8.8)**

**Where two different methods of fitting are used, the method with the lowest value of  $\chi^2$  shows lowest dispersion of points around the line drawn and is the most suitable. The use of this test between different regression fits is not so important because of increased computerisation. However, it is widely used to decide whether one statistical distribution (for example Pearson Type III) fits the data better than another (for example the Normal distribution).**

**For instance, if a Pearson Type III distribution has a  $\chi^2$  value of 4.56 and a Normal distribution has a  $\chi^2$  value of 5.04 for rainfall data, the differences of fit are smallest for the Pearson distribution and it is to be preferred. Moreover, given that the degrees of freedom for the data 'v' ( $=n - 1$ ) is 10, then neither of the distributions can be rejected at the 0.05 (95%) level,  $\alpha$ , because the critical  $\chi^2$  value for  $v = 10$ ,  $\alpha = 0.05$  is 18.31 and the  $\chi^2$  values for both distributions are less than this critical value. Critical values of  $\chi^2$  for various v and  $\alpha$  can be obtained from statistical tables in Appendix E.**

### **Confidence Limits**

**As discussed above, the value of the results obtained from regression can be qualified by testing for the significance of the relation; the higher the significance, the stronger the relation and the more useful the equation will be to predict future runoff amounts. Confidence limits define the range of probable values of any estimate made from a regression equation, and as stated previously, those most commonly used are the 95% confidence limits. These limits are positioned above**

**and below the regression line (+ and - ) and diverge as the values of x (or more correctly  $[x - \text{mean } x]$  ) increase and are therefore parabolic, but symmetrical above and below the regression line. Where a log transformation of data has been applied, (see below) the confidence limits will not be symmetrically distributed around the regression line. For example, a hypothetical logarithmic regression equation may give the value of runoff 'y' for rainfall 'x' to be in the range,  $y = 135.6 \text{ m}^3 + 6.8, - 5.3 \text{ m}^3$ . Thus the value of y will lie in the range 142.4 to 130.3  $\text{m}^3$ , with a confidence of 95%.**

**Confidence limits for a range of y values (sometimes called control curves) may be calculated manually by the use of a range of x values, but this is an unduly laborious process when large datasets are being analysed. Standard statistical packages usually include confidence limit plotting as a basic feature, though the quality of graphical output varies a lot.**

**The importance of confidence limits, and also the importance of adequate detail can be seen from Figure 8.3. The logarithmic regression of rainfall against runoff for this graph (in log10 form) is  $P < 0.001$  and therefore highly significant. However, the dispersion of points around the mean is relatively large and the 95 % confidence limits are therefore widely spread. The details of the relation of this graph are:**

$$n = 41$$

$$\log (a) = -3.26, (se = 0.68)$$

$$b = 2.09, (se = 0.28)$$

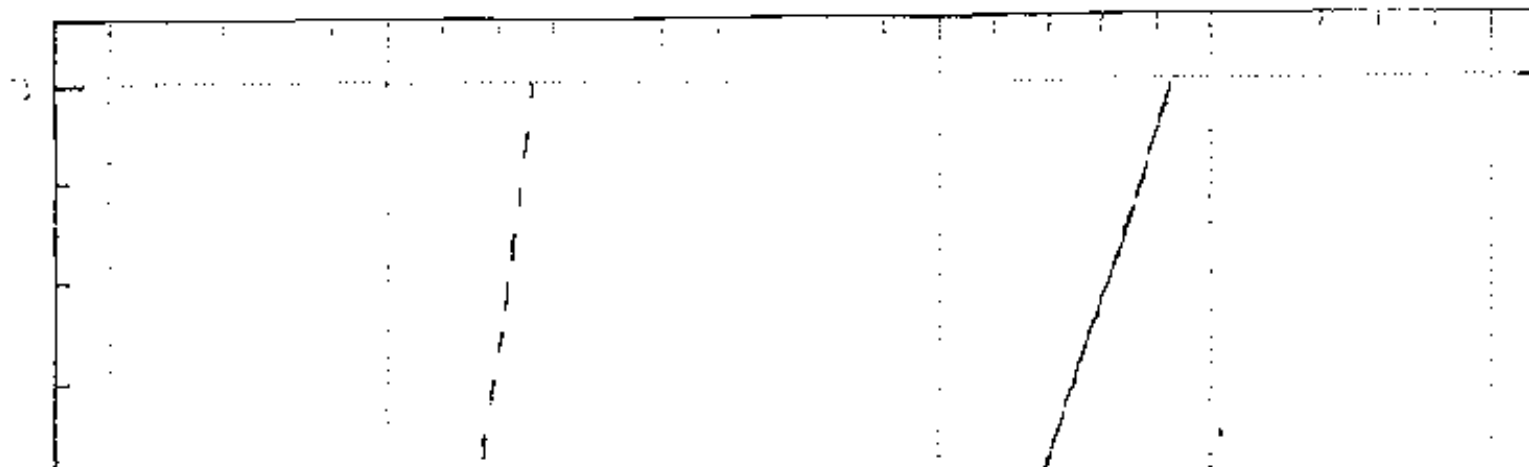
$$R_2 = 0.59$$

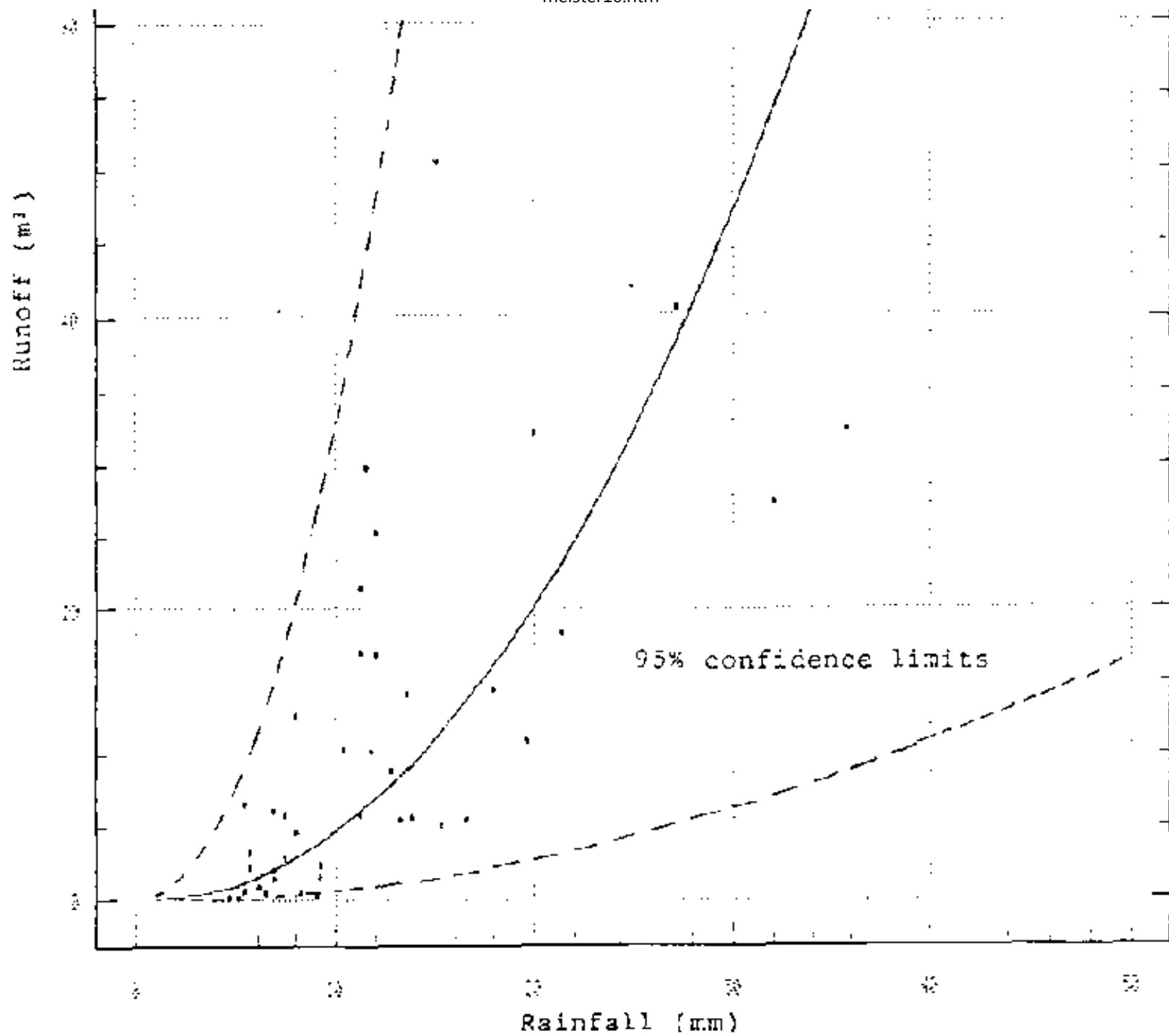
**The relation is significant to the 99.9% level.**



**The catchment from which these data were obtained was located at a site in SE Botswana with a resident gauge reader/observer, but only 41 data points could be used for the analysis out of a total of 45. Four data points were lost due to equipment malfunction and silting of the flume, though it is unlikely that 4 extra values of rainfall and runoff would have improved the regression greatly. The main reason for the small dataset, collected over three years, was the semi-arid climate of the region which resulted in infrequent rainfall and an average of only 15 runoff events each year. As can be seen from the graph, it would be foolish to estimate runoff from rainstorms greater than 20 mm or so, because the confidence limits are so wide and only six plotted points represent rainfall equal to or greater than 20 mm. However, if interest lay in low rainfall/runoff values, the analysis would be satisfactory and the removal of the higher values would improve the relation of a re-plotted regression and more reliable estimates of low flows could be obtained.**

**Usually the interpolation or extrapolation of high runoff values that are of interest, however. It must be stressed that in this case the problem lies not with the analysis, but with the limited amount of available information. Serious consideration must be given to experimental planning, so that adequate data are collected.**





## Figure 8.3: Regression of Rainfall versus Runoff with 95% Confidence Limits

### Transformations of Data for Regression

Hydrological data frequently do not exhibit a linear form when plotted, and it is common practice to transform the data before regression is attempted, so as to arrive at linearity. Also, transformation may stabilise variance of the data and render the points along the regression line more homogeneous. A number of transformations are available, but by far the most common is the transformation of the data to the logarithms of the values before regression, such that the equation of the relation becomes:

$$y = ax^b, \text{ that is } \log(y) = \log(a) + b [\log(x)] \quad (8.10)$$

**y is = antilog log(y)**

Research has shown that other modifications of variables (for example the use of (Rainfall) <sup>2</sup> versus runoff) can give improved results in obtaining a descriptive equation.

Isolated data points that conform very poorly to an otherwise good linear relation (these points are called "outliers") can be removed from the analysis if an obvious reason for their inaccuracy can be detected. For instance, errors that commonly cause such outliers may be silting of the flume, inaccurate gauging of a river, a change in the rating curve that has not been corrected or allowed for, or the incorrect setting of a water level recorder. It is important to refer to the original source of information (field data sheets for example) to identify errors, or gather explanatory notes on unusual occurrences.

## **b. Multiple Linear Regression**

**It is useful that regression can predict a response in dependent variable  $y$ , from the changes in a number of independent variables. For example runoff amount may be estimated from the values of rainfall, land slope, soil texture, soil moisture, etc., by the use of a single equation. The form of the equation for linear multiple regression is:**

$$y = a + b_1x_1 + b_2x_2 + \dots + b_kx_k \text{ where (8.11)}$$

**$x_1, \dots, x_k$  represent the different independent variables.**

**Values are entered into the statistical database for the dependent variable  $y$  and independent variables  $x_1, x_2, \dots, x_k$ .**

**The independent variables should not be significantly cross-correlated. The quality of the total regression is described by the coefficient of multiple determination,  $R^2$  (the square root of  $R^2$  is the multiple correlation coefficient) and values of the standard error of prediction are often given by computer packages. Degrees of freedom for testing for significance of the regression are calculated by using  $(n - k) - 1$ , where  $n$  is the sample size and  $k$  is the number of  $x$  independent variables.**

**It is important to recognise that for each  $x$  variable that is added to the regression equation, a degree of freedom is lost. Where the number of data are small, the addition of independent variables can actually be counter-productive, especially if a variable does not improve the quality of regression to any great extent. The transformation of data, for example to a logarithmic base, is also a common**

**preparation for multiple regression analysis. The methods of prediction of values of y is similar to that of simple regression.**

**Typical computer printout information is shown below using examples from the variables in Table 8.1, the correlation matrix.**

**Dependent variable, Runoff,**

$$y = 2.69 \times 10^{-4} + \text{Area}^{3.698} + \text{Soil Moisture}^{46.029} + \text{Stream Frequency}^{-7.441}$$

**$R^2$  of the equation is 0.893**

**Standard error of the estimate of the equation is 0.383, the standard error of the coefficients are, respectively, 1.024, 11.784 and 1.777 with 95% confidence limits of - 83 to + 483.**

**The data of the equation were transformed to  $\log_{10}$  before regression and runoff is in  $\text{m}^3$ .**

**Regression analysis is most usually adopted for the prediction of runoff amounts or volumes. Theoretical distributions are most commonly used to estimate peak flows and such distributions are described below.**

#### **8.1.4 Statistical Probability Distributions**

**These distributions are adopted to estimate flows, their probabilities and return periods. The return period of a flow is the reciprocal of its probability. In particular, knowledge of peak flows is essential in the successful planning of water harvesting**

**and field systems and in this context it is the size and frequency distribution of peak flows that are often of paramount importance. The return periods and sizes of flows involved will be determined according to the aims of a project, but most analyses must overcome the almost universal difficulty of working with short periods of data. For example, studies show that 80% of estimates of the 100 year flood, based on records of 20 years, are overestimates. Fortunately, planning for such long return periods is rare in agrohydrology and many techniques of analysis have been developed with the problems of short records in mind.**

**The analyses applied to predicting flow data are primarily statistical. Two basic questions can be asked with regard to risk and design:**

- What is the probability ( $p$ ) of a flow  $Q$  being exceeded during the design life  $L$ ?**
- What is the flow  $Q$  which has a selected probability ( $p$ ) of being exceeded during the design life  $L$ ?**

**The study of probabilities attempts to answer these two questions.**

## **Probability Paper**

**Before looking at the various distributions that can be applied to runoff data, it is important to consider the manner in which these distributions are actually plotted as graphs.**

**Probability paper is used to plot, manually, cumulative probability ( $x$  axis) against a variable ( $y$  axis) and is designed so that the data will fall on a straight line, if it actually conforms to the selected distribution. Different types of distributions**

**require different types of paper and such a plot is used as a convenient guide to the interpolation and extrapolation of variables, probabilities and return periods.**

**In the distributions discussed below Extreme Value Type I and normal distributions are plotted on Gumbell - Powell paper (y axis rectangular, x axis Type b; EV III plotted on Weibull / log. extremal paper (y axis log, x axis Type I) and log-normal distributions are plotted on log-normal paper (y axis log, x axis normal probability).**

**Where probability paper is not available, the probability scales can be constructed from the equation:**

**$x = \text{mean} + K \times \text{standard deviation}$ , (8.12)**

**The value of K with corresponding return period  $T_r$  can be obtained from the tables provided below, with the discussion on different distributions (note log-normal Pearson Type III with skew = 0). A rectangular scale of K is drawn and the corresponding value of T is transferred to the x axis of the paper. The probability value p is the reciprocal of  $T_r$ . The plotting positions according to Weibull or Gringorten are use for EV1 and normal distributions. Weibull is most commonly used for the annual maximum series.**

**It is likely that the data points will not fit exactly on a straight line and a line of best fit may be fined by eye or regression analysis (the method of least squares).**

**There is an obvious advantages in the interpolation and extrapolation of probabilities, where runoff data are found to conform to theoretical statistical distributions and any flow can be described by the parameters of the distribution. Many distributions have been studied to discover any such conformity. Hydrological**

**data is usually highly skewed and not evenly distributed about the mean; rather there are usually very many small values and a few, very large values. This has generally precluded the successful use of the Normal distribution, as data in this type are distributed uniformly around the mean. The use of the Log-normal distribution has been widespread in the past, because when transformed, the logs of peak flow magnitudes are commonly seen to be normally distributed. The Log-normal distribution is a special case of the Pearson Type III distribution, described below, with skew equal to zero.**

**It is not surprising that no particular distribution is universally appropriate for the fitting of hydrological data, though the log-Pearson Type III and the Gumbel Type I (EV1) distributions have been adopted for flood study in the USA and UK, respectively. These two distributions are discussed below with worked examples, though the details of the statistical theory is only given in outline.**

**Most frequency functions can be generalised to the form:  $X =$**

**$\bar{x} + K \text{sd } x$ ; where (8.13)**

**$X$  is a flood of a specified probability**

**$\bar{x}$  is the mean of the flood series**

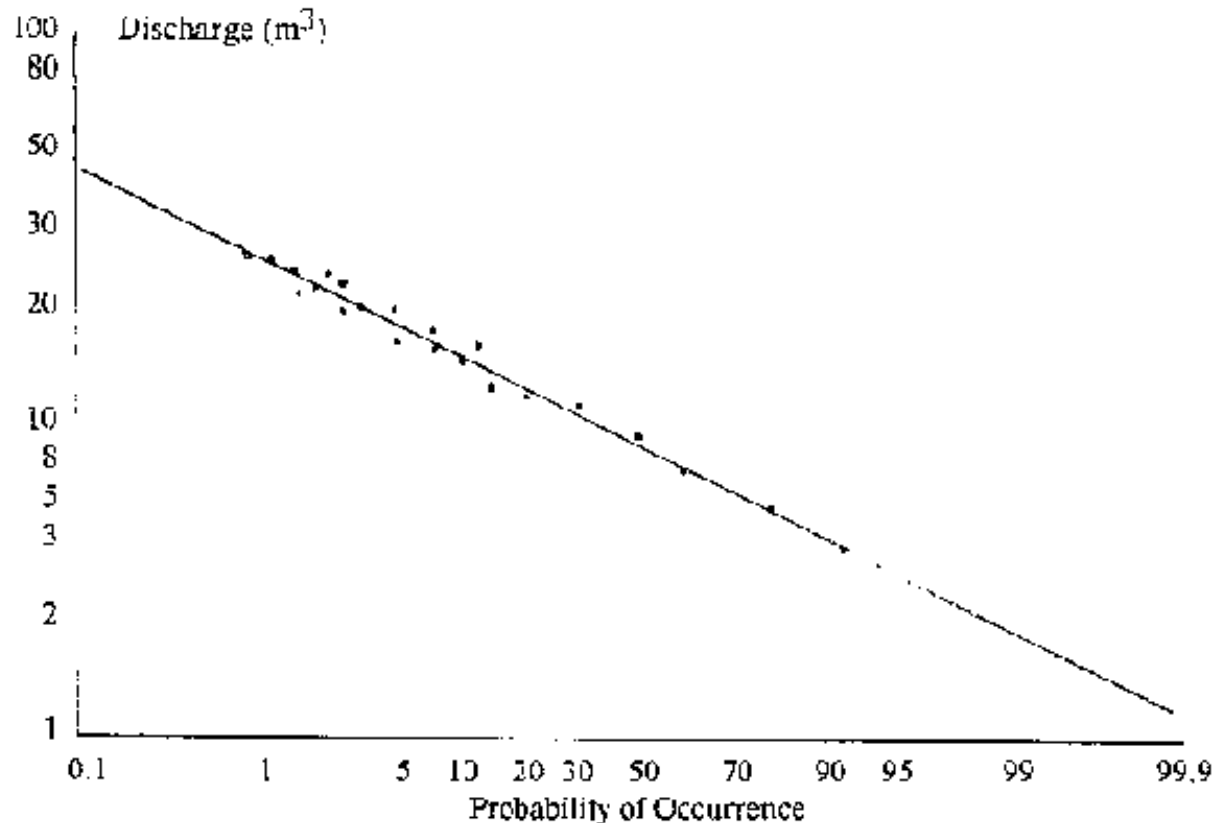
**$\text{sd } x$  is the standard deviation of the series and**

**$K$  is a frequency factor defined for each specific distribution and is a function of the probability of  $X$**

### **a. Log-normal Distribution**



**This distribution has been used historically, as a suitable distribution for flood flows. It is a transformed normal distribution with the variate data transformed to logarithmic values.**



**Figure 8.3: Log Normal Plotted on Probability Paper**

**The probability density is given by:**

**xxxxxxxxxxxxxxxxxxxxx where (8.14)**

**$y = \ln x,$**

**m is the mean =  $e^{my} + dy^2/2$**

**d is std dev. =  $m(e^{dy^2} - 1) 0.5$**

**M is the median =  $e^{my}$**

**$C_V$  is coefficient of variation =  $(e^{dy^2} - 1)0.5$**

**$C_S$  is the coefficient of skewness =  $3C_V + C_V^3$**

**When data are plotted on log-probability paper, a straight line occurs only for one value of  $C_S$  ( 1.139). Curved plots of data indicate the need to modify  $C_S$ . Figure 8.3 shows a plot of discharge versus probability. To widen the opportunity for fitting data to a defined distribution, more complex treatments of data have also been studied.**

### **b. Log-Pearson Type III Distribution**

**This one of a series of distributions. The data are converted to logarithms and the mean is computed using equation 8.15 as a basis:**

**Mean**

**xxxxxxxxxxxxxxxxxxxx (8.15)**

**The standard deviation is given by**

**(8.16)**

**end the skew coefficient by**

**(8.17)**

**The value of X for any probability level is computed from  $\log x = \log x + K \cdot s d \log x$ .**

**(8.18)**

Skew coefficient G	Recurrence interval in years and Percent chance ( )					
	2 (50)	5 (20)	10 (10)	25 (4)	50 (2)	100 (1)
3.0	-0.396	0.420	1.180	2.278	3.152	4.051
2.8	-0.384	0.460	1.210	2.275	4.114	3.973
2.6	-0.368	0.499	1.238	2.267	3.071	3.889
2.4	-0.351	0.537	1.262	2.256	3.023	3.800
2.2	-0.330	0.574	1.284	2.240	2.970	3.705
2.0	-0.307	0.609	1.302	2.219	2.912	3.605
1.8	-0.282	0.643	1.318	2.193	2.848	3.499
1.6	-0.254	0.675	1.329	2.163	2.780	3.388
1.4	-0.225	0.705	1.337	2.128	2.706	3.271
1.2	-0.195	0.732	1.340	2.087	2.626	4.149
1.0	-0.164	0.758	1.340	2.043	2.542	3.022
0.8	-0.132	0.780	1.336	1.993	2.453	2.891
0.6	-0.099	0.800	1.328	1.939	2.359	2.755
0.4	-0.066	0.816	1.317	1.880	2.261	2.615
0.2	-0.033	0.830	1.301	1.818	2.159	2.472
0.0	0.0	0.842	1.282	1.751	2.054	2.326
-0.2	0.033	0.850	1.258	1.680	1.945	2.178
-0.4	0.066	0.855	1.231	1.606	1.834	2.029
-0.6	0.099	0.857	1.200	1.528	1.720	1.880
-0.8	0.132	0.856	1.166	1.448	1.606	1.733
-1.0	0.164	0.852	1.128	1.366	1.492	1.588
-1.2	0.195	0.844	1.086	1.282	1.379	1.449
-1.4	0.225	0.832	1.041	1.198	1.270	1.318
-1.6	0.254	0.817	0.994	1.116	1.166	1.197
-1.8	0.282	0.799	0.945	1.035	1.069	1.087
-2.0	0.307	0.777	0.895	0.959	0.980	0.990
-2.2	0.330	0.752	0.844	0.888	0.900	0.905
-2.4	0.351	0.725	0.795	0.823	0.830	0.832
-2.6	0.368	0.696	0.747	0.764	0.768	0.769
-2.8	0.384	0.666	0.702	0.712	0.714	0.714
-3.0	0.396	0.636	0.660	0.666	0.666	0.667

**Table 8.3: Values of K for the log-Pearson Type III Distribution**

**The Pearson Type III is a skew distribution, bounded on the left like many hydrological distributions. The skew parameter allows flexibility in fitting it to datasets and when the skew is 0, it is identical to the semi-log distributions used commonly in the past for hydrological analysis. Table 8.3 gives values for K for the log-Pearson Type III distribution which are used in the calculations of the worked example.**

### **c. Gumbel (Extreme Value) Type I Distribution**

**The EV1 distribution, like the Pearson Type III, is one of a family of distributions, and its form parameter is equal to zero. As is explained in the Flood Studies Report (NERC, 1975), the distribution of maximum values selected from a data set approaches a limiting form when the size of the data set increases. If the initial distributions within the dataset are exponential (see Peaks Over Thresholds, below), the Type I distribution results. The form of the distribution is given by:**

$$p = 1 - e^{-e^{-y}} \text{ where (8.19)}$$

**p is the probability of a given peak being equalled or exceeded, e is the base of natural logs and y is a reduced (i.e. standardised) variate, a function of probability. Thus**

**x =**

$$+ (0.7997y - 0.45) \text{ sd } x \text{ (8.20)}$$

**In this case, the term in brackets in equation (8.20) is equal to the Pearson term K, that is the frequency factor  $K(T_r)$  is equal to  $-0.45 + 0.779y$  ( $T_r$ ).**

**Table 8.4 gives terms of the Gumbel distribution, for the calculation of flow probabilities.**

Return period in years. $T_T$	Probability, p (% chance $p \times 100$ )	Reduced variate, y	K of $T_T$
2	0.50	0.37	-0.17
5	0.20	1.50	0.72
10	0.10	2.25	1.31
20	0.05	2.97	1.87
25	0.04	0.32	2.04
50	0.02	3.90	2.59
100	0.01	4.60	3.14
1000	0.001	6.91	4.94

*Source:* Flood Studies Report, UK Natural Environmental Research Council, 1975.

**Table 8.4: Gumbel Type 1 (EV 1) Distribution**

## Worked Examples

### Pearson Type III Distribution:

**A hypothetical set of log peak flow (=log q), annual maxima data from a small agricultural catchment when analysed, give the following values. Find the 5 and 25 year return period peak flows:**

**Mean of the logs of q,**

**= 3.087**

**(not log of the mean)**

**Standard deviation  
of the logs of q,  $sd \log q = 0.981$**

**Skewness coefficient  $G = 0.0390$**

**The 5 and 25 year peak flow ( $q_5$ ) is found by the following procedure:  
From Table 8.3,  $K_5 = 0.855$  and  $K_{25} = 1.610$**

**Therefore from equation 8.18,  $\log q_5 = 3.087 + (0.981 \times 0.855) = 3.926$**

**$q_5 = \text{antilog } 3.926 = 8,429 \text{ l s}^{-1} (8.4 \text{ m}^3 \text{ s}^{-1})$**

**From equation 8.15,  $\log q^{25} = 3.087 + (0.981 \times 1.610) = 4.666$**

**$q_{25} = \text{antilog } 4.666 = 46,388 \text{ l s}^{-1} (46.9 \text{ m}^3 \text{ s}^{-1})$**

**Gumbel (EV 1) Distribution**

**A set of hypothetical annual maxima data from a field catchment give the following values. Find the 10 and 100 year peak flows:**

**Mean peak flow,  $q = 1,234 \text{ l s}^{-1}$**

**Standard deviation  $q = 434 \text{ l s}^{-1}$**

**From Table 8.4,  $K_{10} = 1.31$  and  $K_{100} = 3.14$**

**Therefore from equation 8.20  $q_{10} = 1,234 + (1.31 \times 434) = 18031 \text{ l s}^{-1}$**

**and  $q_{100} = 1,234 + (3.14 \times 434) = 2597 \text{ l s}^{-1}$**

### **8.1.5 Extreme Value Series**

**It has been found that in many cases, the whole set of data of hydrological events in a water year (that is the beginning of the wet or dry period of one year to the same time the next) need not necessarily be used in analysis. The largest or smallest values in a particular time period may be analysed instead, and often this time period is selected so that one flow per year is used; the Annual Series. The annual series is called the Annual Maximum Series where the largest flows are used or the Annual Minimum Series when lowest flows are analysed. As the time period increases, the data become less inter-dependent. In regions with discrete seasonal variations of flood, time periods of a few months may render the data independent and the annual maximum series is widely used.**

**Where a base level of flow is selected so that only floods which exceed this base are used for analysis, the data are said to form a Partial Duration Series. This type of series will be discussed below, but there is really little difference between it and the annual maximum series, except that the high level of the base in the latter excludes all flows but the greatest each year.**

#### **Annual Maximum Series (AMS)**

**The annual maximum series is a special case of the extreme value series and for return periods of 5 years or more it is often suitable, though the design of structures and the nature of a project will also influence whether the annual maximum series should be chosen. For instance a dam or bridge may not only be affected by the largest flood, but also by the second largest and other flows associated with a flood period. The annual maximum series takes no account of these other runoff events and therefore may not be suitable for use. Alternatively, a culvert may be washed**



**away by the one large flow, but can easily and cheaply be repaired and the AMS may provide a suitable method of analysis. The annual minimum series may be used where low flows are under consideration.**

**In Table 8.5 the AMS is used to illustrate the estimation of size and probability of peak flows. The difficulties of small datasets may be acute when using the AMS, as only the single largest annual (or seasonal) peak is used in the ranking. The data may also be plotted on a log-probability graph with peak flow values on the log., y, axis. The form of the data is a straight line and this renders the extrapolation of higher return period flows, relatively simple.**

**The Flood Studies Report (1975) is a major work on flood probability analysis and recommends the following, alternative relations for the probability and return period terms in Table 8.5:**

$$p = (m - 0.44) / (n + 0.12) \text{ and } T_r = (n + 0.12) / (m - 0.44) \quad (8.21), (8.22)$$

**These relations define "plotting positions" where  $p$  is the probability,  $m$  the rank of the flow,  $n$  the total number of items in the rank and  $T_r$  is the return period in years. Several such plotting position formulae have been tested (the examples shown in Table 8.5 are according to Weibull) and used. Those in equations 8.21 and 8.22, known as Gringorton's formulae, attribute longer return periods to higher floods in the series.**

**The difficulty experienced in using many methods to extrapolate from short spans of data is due to the estimation of the tail of the distribution from values not included in this tail. The annual maximum series is especially vulnerable to error since it discards most of the available data. The use of theoretical distributions, in particular**

**when used in conjunction with partial duration series, are attempts to overcome these problems, though ultimately long periods of records are the best basis for probability estimates.**

Peak flow $m^3$	Order no. $m$	Probability $p^*$ $m / (n + 1)$ (%)	Recurrence interval $T_T^*$ $(n + 1) / m$ (years)
150	1	4.8	21.0
148	2	9.5	10.5
140	3	14.3	7.0
132	4	19.0	5.3
130	5	23.8	4.2
128	6	28.5	3.5
117	7	33.3	3.0
116	8	38.1	2.6
105	9	42.9	2.3
101	10	47.6	2.1
89	11	52.3	1.9
78	12	57.1	1.8
76	13	61.9	1.6
65	14	66.7	1.5
62	15	71.4	1.4
60	16	76.2	1.3
57	17	81.0	1.2
50	18	85.7	1.2
49	19	90.5	1.1
47	20	95.2	1.0

\* Where  $n$  is the number of years of record and  $m$  is the rank of the item the array

**Table 8.5: Annual Maximum Peak Flows**

### 8.1.6 The Problems of Short Records and Partial (Duration) Series

**A partial series is made of all peak flows that exceed a selected threshold, the AMS**

**being one particular case. In other instances, a number (usually from about two to five runoff events each year) are included, so that a larger range of data is selected from periods of short records. For this reason the partial series may also be known as the Peaks Over Threshold (POT) model. Although considerations have been made as to whether the exceedences should occur within a water year or a season, these considerations are less vital than the type of distribution of flood magnitudes, which influences the estimation of high return periods for given flows.**

**Several models have been studied, but the simplest is presented here. It assumes a random distribution of exceedences in any year or season and an exponential distribution of the magnitudes of these exceedences. These assumptions combine to give a Gumbel Type 1 distribution.**

**The problems of short records and the need to estimate flood flows for relatively small return periods is the situation usually faced by agrohydrological projects. The Flood Studies Report investigated the use of partial (duration) series to overcome the problem of short records and the work that it reports is of value, though the use of partial data is relatively well known.**

#### **a. Annual Exceedence Series (AES)**

**This series is a particular type of partial duration series, where the dataset is obtained by setting the level above which flows are included is such that the number of flows is equal to the number of years record. In real terms this means that some years will provide more than one flow, while some years will provide none at all. In this way, the occurrence of several high flows in one year will be taken into account, unlike the annual maximum series. The relations between these two series (and indeed the annual maximum and partial duration series in general)**

are discussed below. In the example above on the suitability of series selection and the destruction of bridges, dams and culverts, the place of the annual exceedence series can be seen.

## b. Peaks Over Threshold Model

For very short return periods ( $T_r$ ), values obtained from the annual maximum series and the POT model differ appreciably, when longer periods are considered, they are very similar. However, the basic question as to which is the most suitable method of estimation to use, is still open to question. For example, the annual maximum series, by limiting exceedences to one peak per year, may actually bias the sampling distributions by not taking into account, say the second or third largest flood on record. On the other hand, the POT model is often seen to work better for small return periods when only one exceedence a year is used. For longer return periods, a greater number of exceedences a year seem more suitable. Below is a list of ratios of return periods for the POT and annual maximum series:

POT	versus	ANMAX	POT	versus	ANMAX
0.50		1.16	5		5.52
1.00		1.58	10		10.50
1.45		2.00	50		50.50
2.00		2.54	100		100.50

**Table 8.6: Return Period ( $T_r$ ) POT versus Annual Maximum Series Return Period (years):**

The simplest manner in which to abstract the data from the full set is to decide upon a number of flows per season to be analysed which exceed an (as yet) unknown threshold and from the relations given below, calculate the threshold.

**The formula that gives return period flow is:**

$$Q(T) = q_0 + B (\ln \$ + \ln T) \quad (8.23)$$

**Q = the peak flow of return period T**

**q<sub>0</sub> = the threshold value**

**B = the gradient of the distribution**

**\$ = the number of exceedences**

**The sample size is noted as M, the minimum flow of the sample is q<sub>min</sub>, and the mean is q.**

**The linking equations of the parameters are:**

$$q_0 = q_{\min} - (B/M) \quad \text{and} \quad (8.24)$$

$$B = M (q - q_{\min}) / (M - 1) \quad (8.25)$$

**The sampling variance, var. QT is given by:**

$$\text{var. QT} = B^2/N [(1 - \ln \$ - \ln T)^2 / N\$ - 1] + (\ln \$ + \ln T)^2 \quad \text{where} \quad (8.26)$$

**N = the number of years of record. The procedure for using the POT model is shown below, by worked example.**

**Worked Example of the POT Model**

**As stated earlier, the assumption is made that the magnitudes of the peaks are distributed exponentially, however in some instances this may not be the case,**

**therefore the first step in approaching the use of the POT model is to verify this exponential assumption. The data in Table 8.7 were obtained from a 4,000 m<sup>2</sup> rangeland runoff plot with a land slope of about 2%, sandy loam soil and a vegetation cover in the range 55-65%. It is important to note that no major changes in the catchment characteristics took place during the period of record.**

**From the total set of peak flow data, a number of the highest flows are selected, such that M, the total number of peaks selected = \$ (exceedences per year) × N (the number of years of data). For this example \$ = 3 and \$ = 5 exceedences per year were used to illustrate by result, any variation due to the use of different exceedences. They were abstracted from data collected over only 3 years.**

**Thus, a total of 9 and 15 peaks were used in each case, though there is no statistical evidence to suggest that a better result is obtained from using a larger numbers of exceedences. It is important to note that like the annual exceedence series, no regard is given to whether or not the peaks occur in any particular year, it could be possible, but unlikely, that all data were drawn from the same year.**

**The values of the reduced variate y are calculated from:**

**xxxxxxxxxxxxxxxxxxxx (8.27)**

**such that when N, the number of years from which the data are drawn = 5, then:**

**$y_1 = 1/5 = 0.200$ ;  $y_2 = 1/5 + 1/4 = 0.450$ ..... $y_5 = 1/5 + 1/4 + 1/3 + 1/2 + 1/1 = 2.283$ , etc.**

\$ 3, N 3, M 9			\$ 5, N 3, M 15		
Rank	Peak flow Q	Reduced variate y	Rank	Peak flow Q	Reduced variate y
1	53.4	2.829	1	53.4	3.318
2	48.1	1.829	2	48.1	2.318
3	39.8	1.329	3	39.8	1.818
4	39.4	0.996	4	39.4	1.485
5	38.7	0.746	5	38.7	1.235
6	34.3	0.546	6	34.3	1.035
7	32.5	0.378	7	32.5	0.868
8	30.7	0.236	8	30.7	0.725
9	29.9	0.111	9	29.9	0.600
			10	28.3	0.489
			11	26.9	0.389
			12	26.3	0.298
			13	24.1	0.215
			14	23.0	0.138
			15	21.8	0.067
$q$	= 38.53			33.15	
$q_{min}$	= 29.90			21.80	

**Table 8.7: Data for POT Model, Exceedences 3 and 5 per Year**

The peak flows in litres per second and variate y are plotted as in Figure 8.4, both distributions appear closely exponential.

The calculation of Q10 and Q25 peak flows for \$ 3 and \$ 5 are shown below.

For \$ 3 and using equation 8.25	For \$ 5 and using equation 8.25.
$B = 9 (38.53 - 29.90) / 8 = 10.83$	$B = 15 (33.15 - 21.80) / 14 = 12.16$
Using equation 8.24,	Using equation 8.21,
$q_n = 299 - (1083/9) = 28.70$	$q_n = 21.80 - (12.16/15) = 20.99$

**Using equation 8.23, the 10 and 25 year peak flows are:**

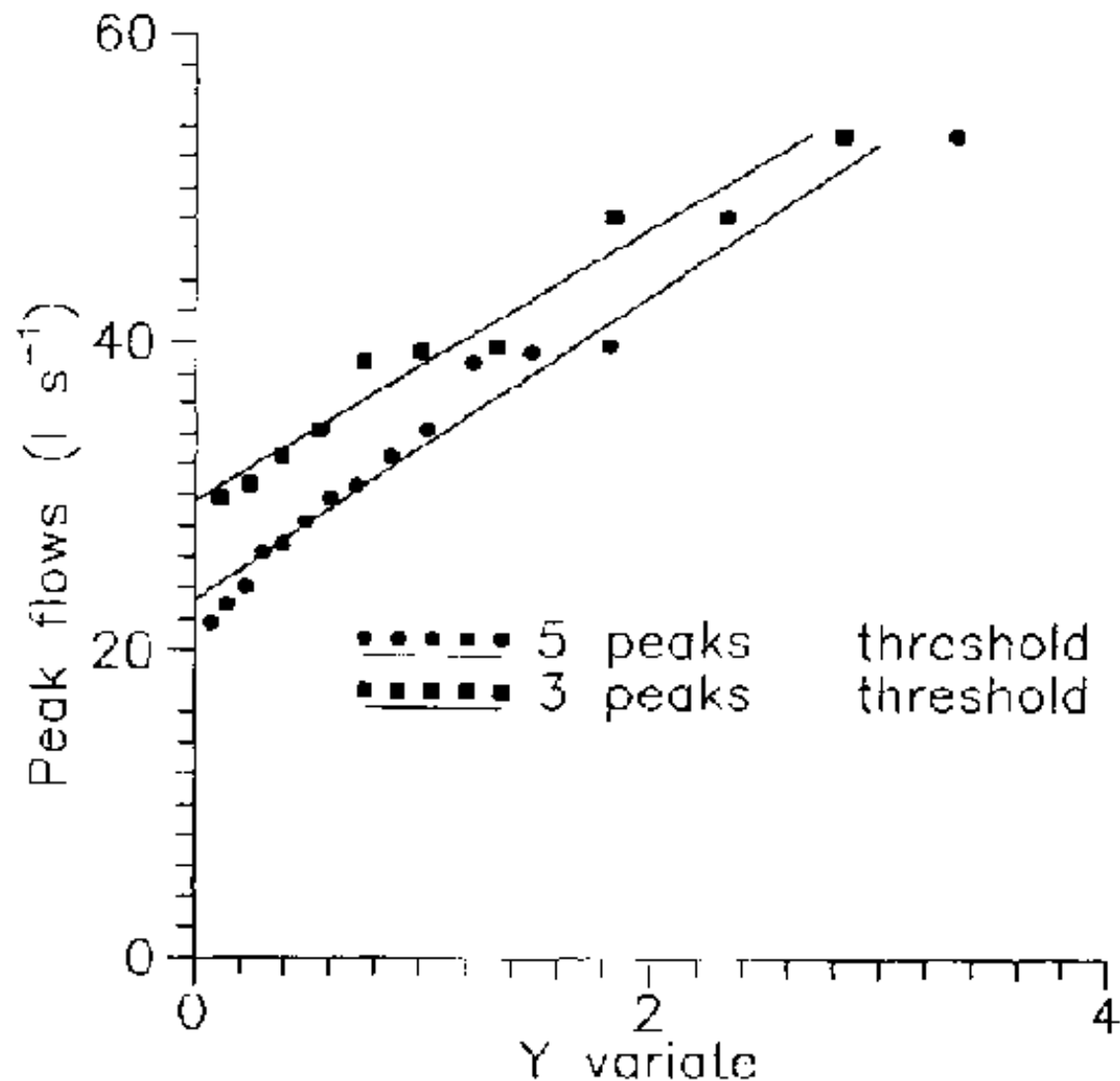
$$Q_{10} = 28.70 + 10.83 (\ln 3 + \ln 10) = 65.5 \text{ l/s}$$

$$Q_{10} = 21.80 + 12.16 (\ln 5 + \ln 10) = 69.4 \text{ l/s}$$

$$Q_{25} = 28.70 + 10.83 (\ln 3 + \ln 25) = 75.5 \text{ l/s}$$

$$Q_{25} = 21.80 + 12.16 (\ln 5 + \ln 25) = 80.5 \text{ l/s}$$





**Figure 8.4: Plot of Peak Flow  $Q$  versus Reduced Variate  $y$**

## Stochastic Analysis

**The term "stochastic" is frequently met with in hydrology and although the term is used in statistics to define the data as being governed by the laws of chance (synonymous with terms such as "random" or "probabilistic") in hydrology**

**"stochastic" refers to time series that are partially random and may be regarded as a treatment of data halfway between probability analysis and deterministic modelling.**

**Although the occurrence of events is regarded as being random, the order in which the events occur is regarded as carrying significance, unlike probability analysis which is concerned only with size and number of events. Stochastic hydrology is useful for design and decision-making in hydrology, since it is assumed that although future runoff events are not known, they will have the same statistical properties as historical records. Stochastic methods tend to deal with cycles of events and the generation of possible future flows. It is assumed that the statistical properties of runoff do not change with time. Two approaches are used; either data are aggregated from monthly data and combined to give annual results or seasonal/annual data are disaggregated to provide monthly flow values.**

**The general form of the stochastic modelling equation on a monthly basis is:**

$$X_{i+1} = X_{j+1} + B_j (X_1 - X_j) + T_i S_{j+1} (1 - R_j^2)^{0.5} \text{ where}$$

$X_{i+1}, X_i$  = generated flows during the  $(i+1)^{\text{th}}$  and  $i^{\text{th}}$  months

$X_{j+1}, X_j$  = mean flows during the  $(j+1)^{\text{th}}$  and  $j^{\text{th}}$  months

$B_j$  = least squares regression coefficient based on  $B_j = R_j S_{j+1} / S_j$

$T_i$  = normal random variate with mean zero and variance one

$S_{j+1}, S_j$  = standard deviations of flow during the  $(j+1)^{\text{th}}$  and  $j^{\text{th}}$  months

$R_j$  = correlation coefficient between  $j^{\text{th}}$  and  $(j+1)^{\text{th}}$  months

**Although stochastic analysis is especially widely used in generating long sets of records from shorter periods, the amount of information needed for such complex analysis is nevertheless considerable. Annual flow volumes, or even monthly results are often of little value to water harvesting and agrohydrology in arid and semi-arid areas, though stochastic analysis is often used when reservoir inflows are under study.**

## **8.2 Non-statistical analysis of agrohydrological data**

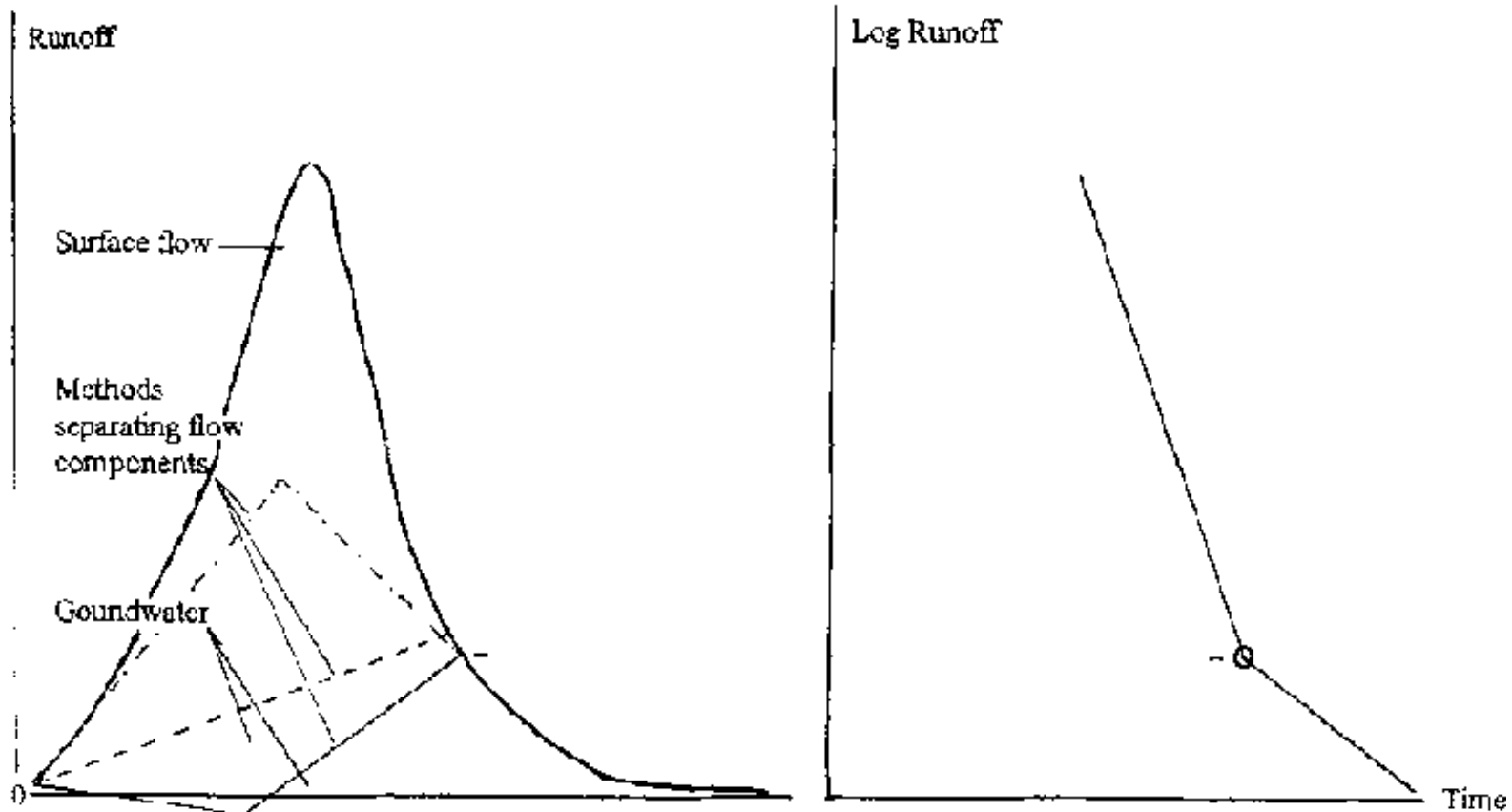
### **8.2.1 Runoff Analysis**

#### **The Runoff hydrograph**

**In humid regions, runoff is composed of contributions from groundwater and, when it rains heavily, surface flow. Groundwater enters the stream channel when the water table adjacent to a stream is at a higher elevation than the surface of the stream and a slow, but continual seepage occurs. In arid and semi-arid areas, where the ground water table is usually very deep, the opportunity for seepage is rare and stream flow is usually the concentration of runoff coming directly from the land surface. In some cases however, even in relatively arid areas, sufficient water from the high stages of river flow may enter riparian deposits and be released slowly from this temporary storage to extend river discharge beyond that supported by direct, surface contributions. In the case of small runoff plots and field sized catchments, where stream channels are not found, runoff is composed only of surface flow.**

**Where ground water and surface flow are combined, their separation by use of the flow hydrograph is a routine, but important step in analysis. Where there is no**

**groundwater contribution, the whole flow volume is attributed to surface flow. A great deal of research has been undertaken to define different hydrograph types and what they represent in terms of the runoff process, rainfall, the variability of source areas, etc. Figure 8.5 shows a simple diagrammatic representation of a runoff event, the flow hydrograph, and defines its components. Alternative methods of separating ground water and surface flow are shown, though to some extent each is arbitrary. If the hydrograph is plotted with a logarithmic y axis, the curve usually breaks into three sections, each section represented by a straight line component of the whole. Conventionally, these are regarded as the contributions from groundwater, interflow (sub-surface but not deep) and surface flow, though this probably is a rather simplified view of true conditions.**



**Figure 8.5: The Flow Hydrograph and Its Components**

## **Unit Hydrographs**

**Despite the variation in runoff due to the complexity of catchment characteristics and rainfall amounts, intensities and distributions, the Unit Hydrograph method of synthesising runoff hydrographs for particular rainfall amounts is widely used. By constructing a basic runoff hydrograph from a known and conveniently selected rainfall amount, runoff hydrographs can be synthesised for any rainfall amount. The method is not appropriate for small runoff plots or very small catchments less than about 2 hectares in area.**

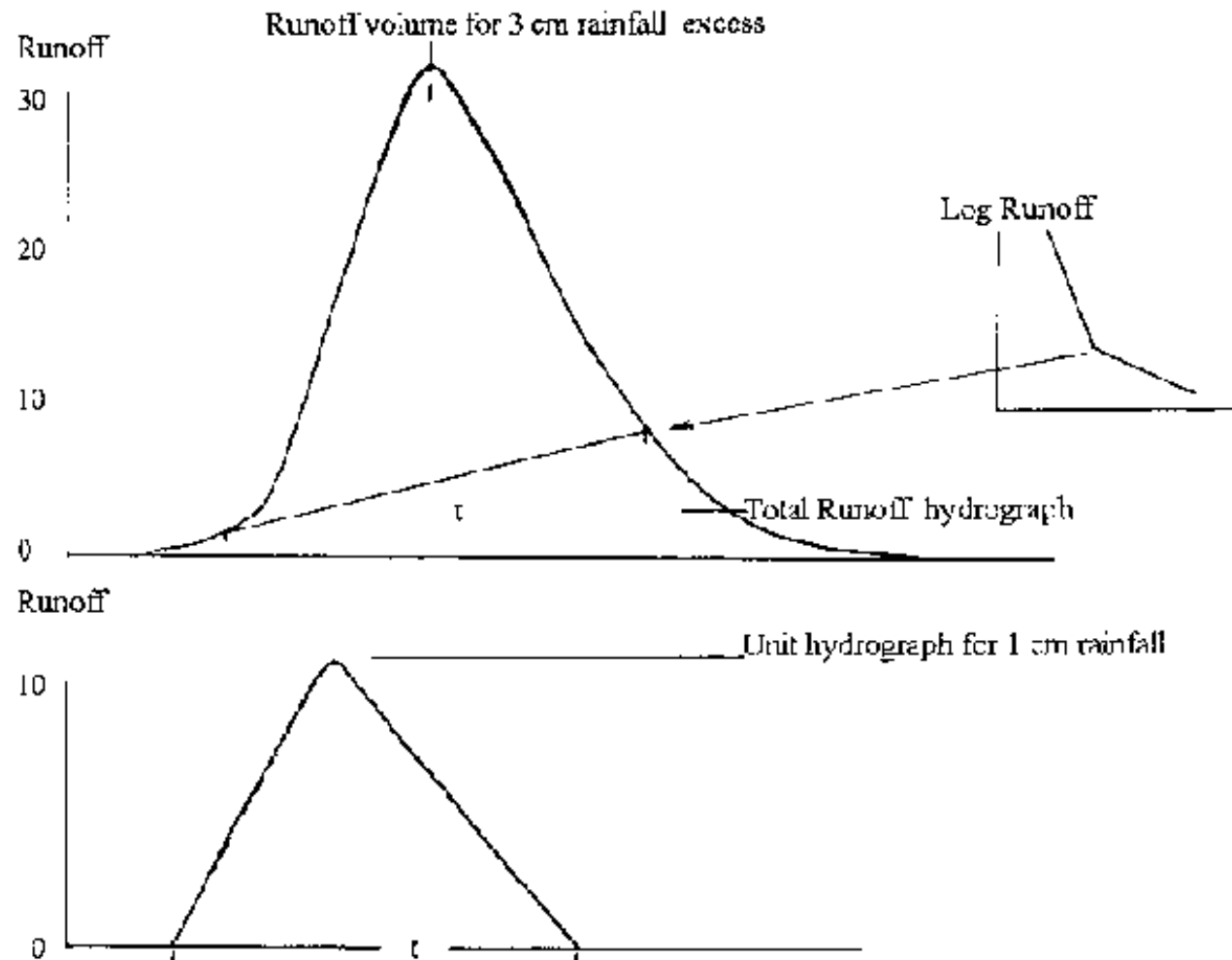
**The unit hydrograph is defined as the surface runoff hydrograph generated from a unit depth of rainfall distributed over the catchment area, occurring during a specified period of time. The most suitable period of time will depend on the typical flow duration and size of catchment. The unit hydrograph is best obtained from a storm of reasonably uniform intensity (and therefore usually of short duration), desired duration and large volume. A single storm peak is preferred, but is not essential. The unit hydrograph ceases to be applicable when the catchment area is so large that it is not covered by a single storm, and in such circumstances the catchment must be divided into subcatchments that are treated separately.**

**Usually several unit hydrographs are obtained from a number of storms and combined, to "average" the effect of different rainfall patterns.**

**Figures 8.6 and 8.7 illustrate the method of unit hydrograph separation from a single storm. The first step is to separate the base flow component from direct (surface) runoff. The volume of direct runoff is calculated, for example in  $m^3$  and then converted into runoff depth, i.e. the depth of runoff if the volume were to be spread evenly over the catchment, for example in cm. The ordinates of the direct flow hydrograph are divided by this runoff depth, which then defines the unit hydrograph for 1 cm of direct runoff.**

**The average unit hydrograph, which gives a more generalised hydrograph shape and size, is drawn as an interpolation to conform to the overall shapes of several individual unit hydrographs, using the average peak flow and average time to peak as guides to the outline of the graph. It should not be surprising that the unit hydrograph may not show precise linearity when used to construct flows for a wide range of volumes, since the recession of flow depends, to some extent, on peak flow. However, estimates of flow can be good, and the unit hydrograph can be**

regarded as the typical hydrographic form of a particular catchment. Figure 8.8 shows the use of the unit hydrograph in construction of the hydrograph from a complex rainstorm.



**Figures 8.6 and 8.7 Derivation of a Unit Hydrograph**

**Conversions to other unit hydrograph duration periods can be made, where these are integral multiples of the basic unit hydrograph, by simple superimposition of a**

## **series of the unit hydrographs.**

**Where time periods are not whole multiples of the unit hydrograph time period, S-hydrograph techniques can be used. These techniques provide a flexible method of obtaining a wide range of hydrographs for different durations, but they are complex and time-consuming. Although they are in widespread use and are important in the understanding of orthodox river behaviour, they are marginal to agrohydrological research and water harvesting applications. The selection of a unit hydrograph that will allow a convenient permutation of durations is not usually difficult to achieve. Most textbooks on hydrology cover the subject in detail. An Instantaneous Unit Hydrograph, which is independent of duration, can also be derived.**

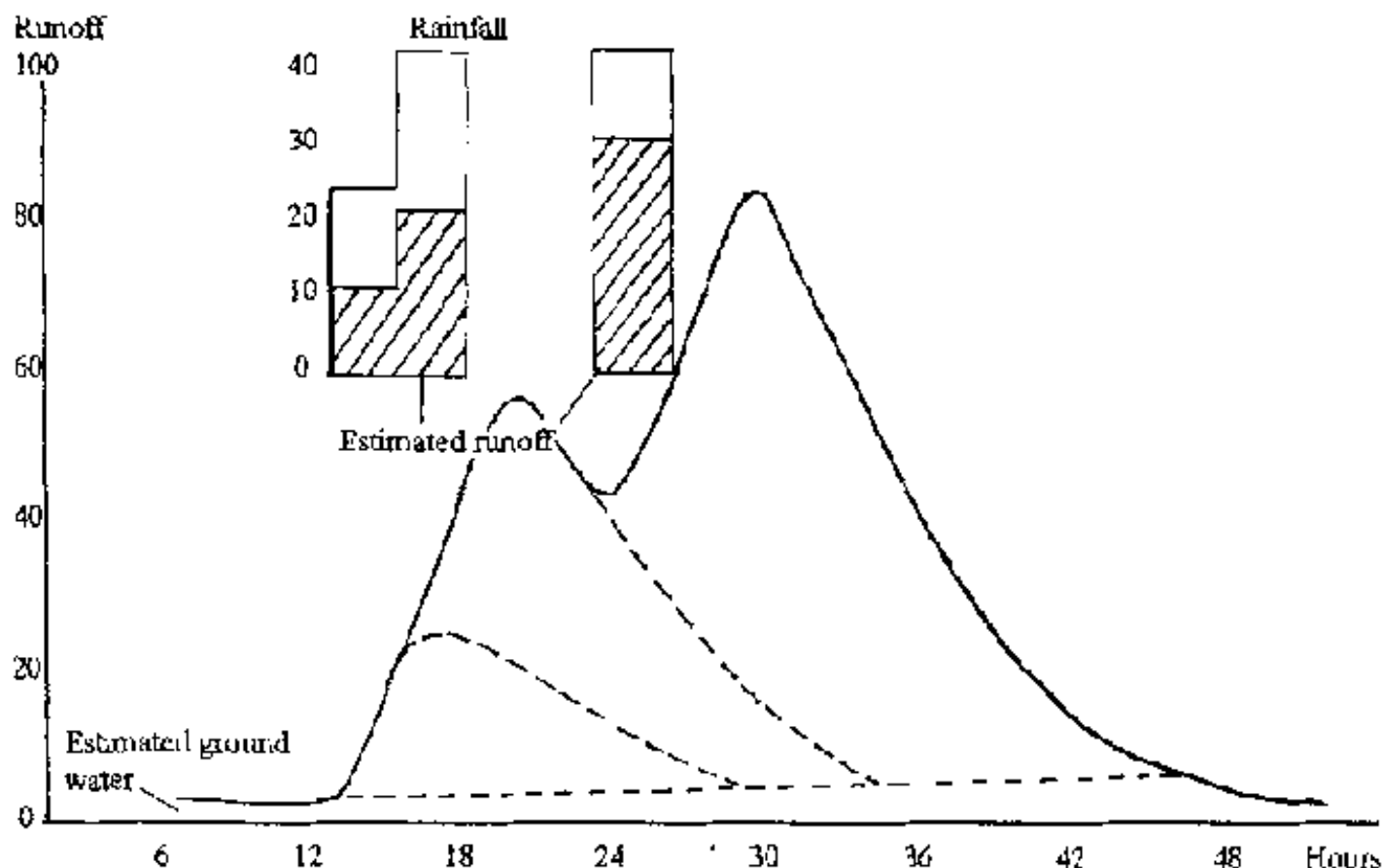
**Various empirical formulae have been developed to enable a Synthetic Unit Hydrograph to be defined. These have related catchment characteristics to hydrograph form, but the application of these empirical formulae to define a synthetic unit hydrograph tends to be of limited value. If unit hydrographs are desired for ungauged streams, it is preferable to obtain them by the use of flow data from adjacent catchments. The theoretical bases of these variations of unit hydrograph theory may be addressed by reference to a standard hydrological textbook such as the Handbook of Applied Hydrology; see chapter 1.**

**A flow hydrograph provides two especially important values: the runoff volume and the peak flow, but in most cases interest will also be taken in the duration of the rising and falling limbs; the time after rainfall starts that runoff**

**begins and the overall duration of flow. For the practice of water harvesting these characteristics of flow have practical implications and are important in understanding when peak flows have passed; when flow diversions should be made;**



**whether a recession flow will continue or rapidly decline, whether all flow is direct or whether sub-surface contributions can be relied upon to deliver further opportunities to supplement the water availability to crops.**



**Figure 8.8: Construction of a Flow Hydrograph using the Unit Hydrograph**

**The construction of water harvesting and field systems assumes that sufficient quantities of runoff water will be available to be moved safely to crops, using well designed structures that can control and manipulate specified peak flows. The study of runoff volume data in agrohydrology anticipates these activities by trying to**

**answer two main questions. The first and most important is, will the amount of runoff that can be collected be agriculturally useful? The agricultural dimension is very important and "useful" will be determined by geographical location and agricultural practice; crop type and climate. However, the clear presentation of simple hydrological analyses will allow this question to be answered according to the conditions that prevail in a particular locality.**

**The second question, which factors most control the production of runoff and how? is concerned with an understanding of the runoff process. The quantification of the relationships between the components of these physical processes is important, so that predictions of future behaviour can be made. The analysis of rainfall and catchment information is essential to the study of runoff volumes.**

### **8.2.2 Rainfall Analysis**

**The analysis of rainfall information may use the statistical distributions and probability procedures that have been discussed previously in this chapter. Regression analysis is important in understanding how rainfall amounts and intensities affect the production of runoff. These characteristics of rainfall may also be used in multiple regression in association with other influential factors. In addition, treatment of basic rainfall data to render them useful for a variety of applications is an important stage of analysis. The analysis of rainfall information concerns two types of data; those obtained from a single point and those extrapolated or interpolated from a number of points to estimate rainfall over an area. These data may involve a single event or may be directed at the study of how precipitation changes with time.**

### **General Characteristics of Rainfall**

**Arid and semi arid regions, where water harvesting is likely to be practiced, tend to experience great spatial variability of rainfall; rainfall intensities also tend to be highest during the first half of a storm. It has been found that the characteristics of rainfall in these areas is essentially independent of locality and may be similar in widely different geographical regions. The standard deviation from the long term mean in such areas is very high, the average annual rainfall varying between by perhaps 35% to 200% of the mean, compared to temperate climates where standard deviations are more typically only 10 - 20%.**

## **Missing Data and the Adjustment of Records**

### **Individual Data Points**

**Missing point rainfall data are not uncommon and may be estimated in three ways, each of which use information that is taken from stations close to that which has no record. The three alternative methods of estimation are:**

**Averaging the same daily values from three adjacent stations; Estimating from an isohyetal reconstruction of the missing day's rainfall Using a weighted ratio.**

**In the first case, the simple arithmetic average may not provide an accurate result where, for example, topographic variation is great and where rainfall values are influenced by such variation. However, if the annual rainfall totals of the adjacent stations are within 10 % of the station with missing data, this method is regarded as suitable.**

**An isohyetal estimate of a station's missing rainfall is easy to achieve where an adequate density of stations allows it and where the spatial variability of rainfall is**

**low. Knowledge of local conditions can provide added accuracy to such estimates and the technique of isohyetal construction is described below.**

**In some areas, the spatial variability of rainfall and/or an insufficient number of rainfall stations may preclude the production of an isohyetal map, in which case the latter of the three options is to be preferred. The missing value may be obtained from an equation linking the rainfall experienced by adjacent stations:**

$$D_m \text{ (missing daily rainfall)} = 0.333 [D_1 (A_{n_m}/ A_{n_1}) + D_2 (A_{n_m}/ A_{n_2}) + D_3 (A_{n_m}/ A_{n_3})] \text{ (8.28)}$$

**where:**

**D is the daily rainfall**

**A<sub>n</sub> is the annual total rainfall**

**the subscripts 1, 2, and 3 refer to the adjacent stations and m to the station with missing daily data.**

### **Adjustment of records**

**The change in location or exposure of a raingauge can effect long-term records. The Double Mass Curve technique may be used to correct such defective records, by the comparison of data from the queried station with those from adjacent gauges. Two important considerations should be taken into account; that records from at least ten stations are needed by which to make a comparison; and the longer and more homogeneous the records of these stations, the more successful the correction.**

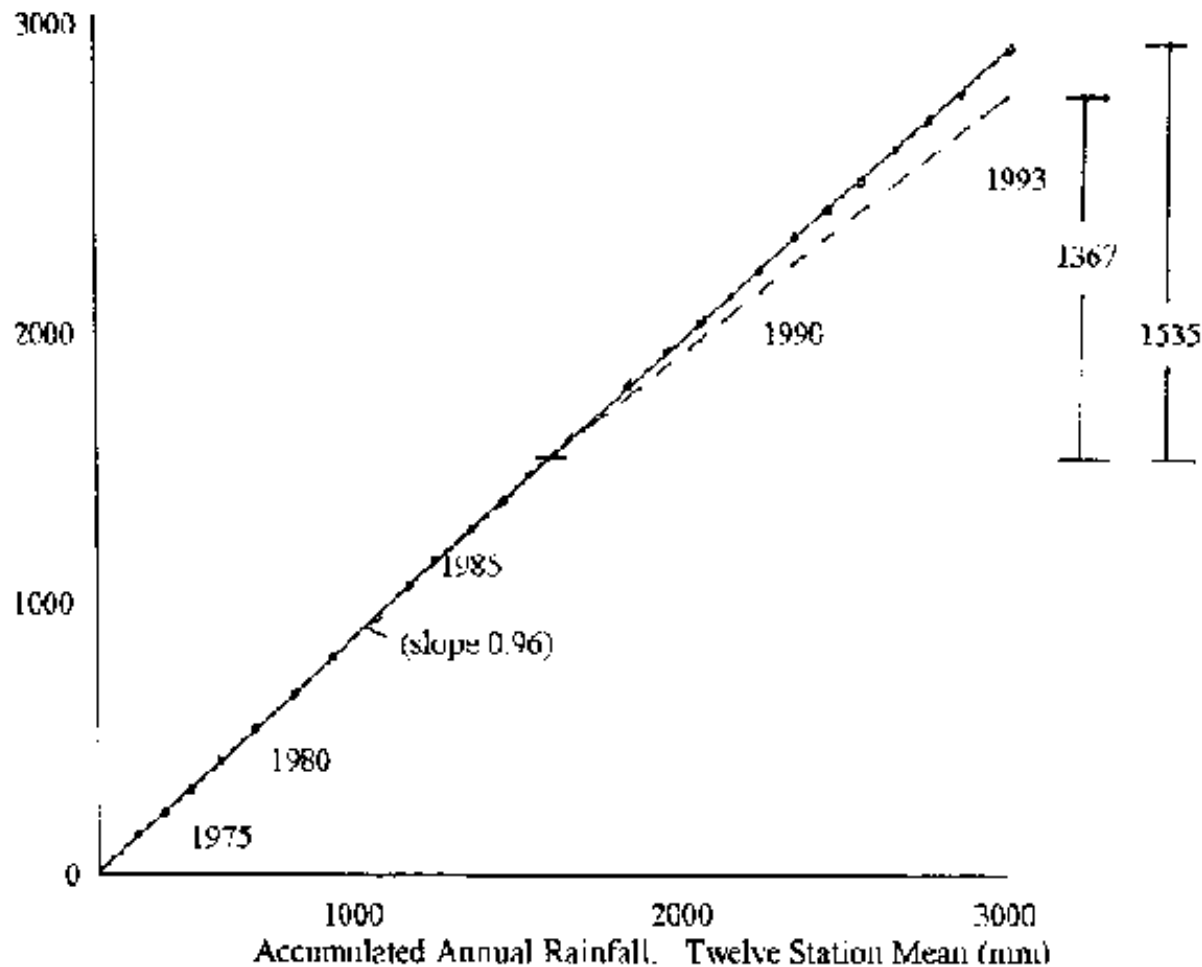
**In the case of example Figure 8.9, the values of the queried station must be**

**corrected downwards by a factor of  $1357/1535 = 0.89$ , after 1987.**

**Maximum accuracy is gained by the comparison of double mass data within the base stations' dataset and the elimination from the set of any that show large changes of slope. Minor differences can be ignored, or more than one parallel slope line can be used to account for true differences. The method is not recommended for daily or individual storm values.**

**This method is frequently used in the same way to compare and correct the flow records of stream gauging stations.**

**Accumulated Annual Rainfall of Queried Station (mm)**



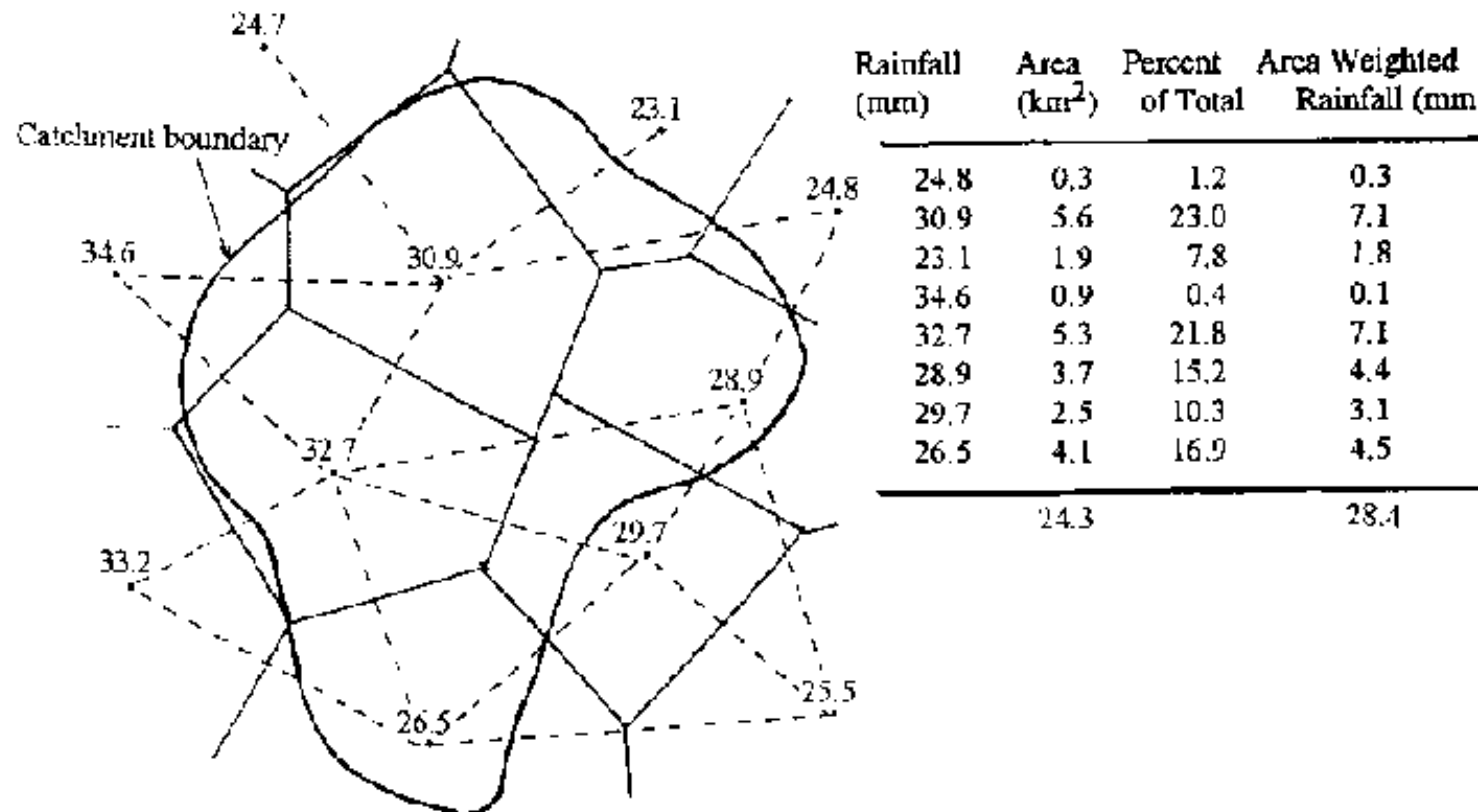
**Figure 8.9: Double Mass Comparison of Rainfall**

### Rainfall Depth Over Areas from Point Measurements

The point measurement of rainfall at a site is usually adequate to describe rainfall on an area basis when small catchments and runoff plots are used, though the high spatial variability of some locations can be extreme. As catchment area increases, especially in those regions with a large inherent spatial variation of rainfall, it

**becomes increasingly important to convert rainfall data collected at several points into a rainfall depth over the area.**

**Several methods can be used to extend rainfall depths at points to areas. The arithmetic mean of several stations can be used, but this usually encounters limitations of spatial distribution and does not weight any variation in network densities. The Thiessen Polygon and isohyetal methods are the two commonly used alternatives to the arithmetic mean and are described below. The Thiessen Polygon method assumes that values of rainfall amounts at a point can be extended half way to the next station. Polygons are constructed around each station and the area of each polygon is then used to weight the rainfall value at the centre of each . The geometrical construction of this method is illustrated in Figure 8.10 as is the area-based weighting applied to the value of rainfall at each station.**



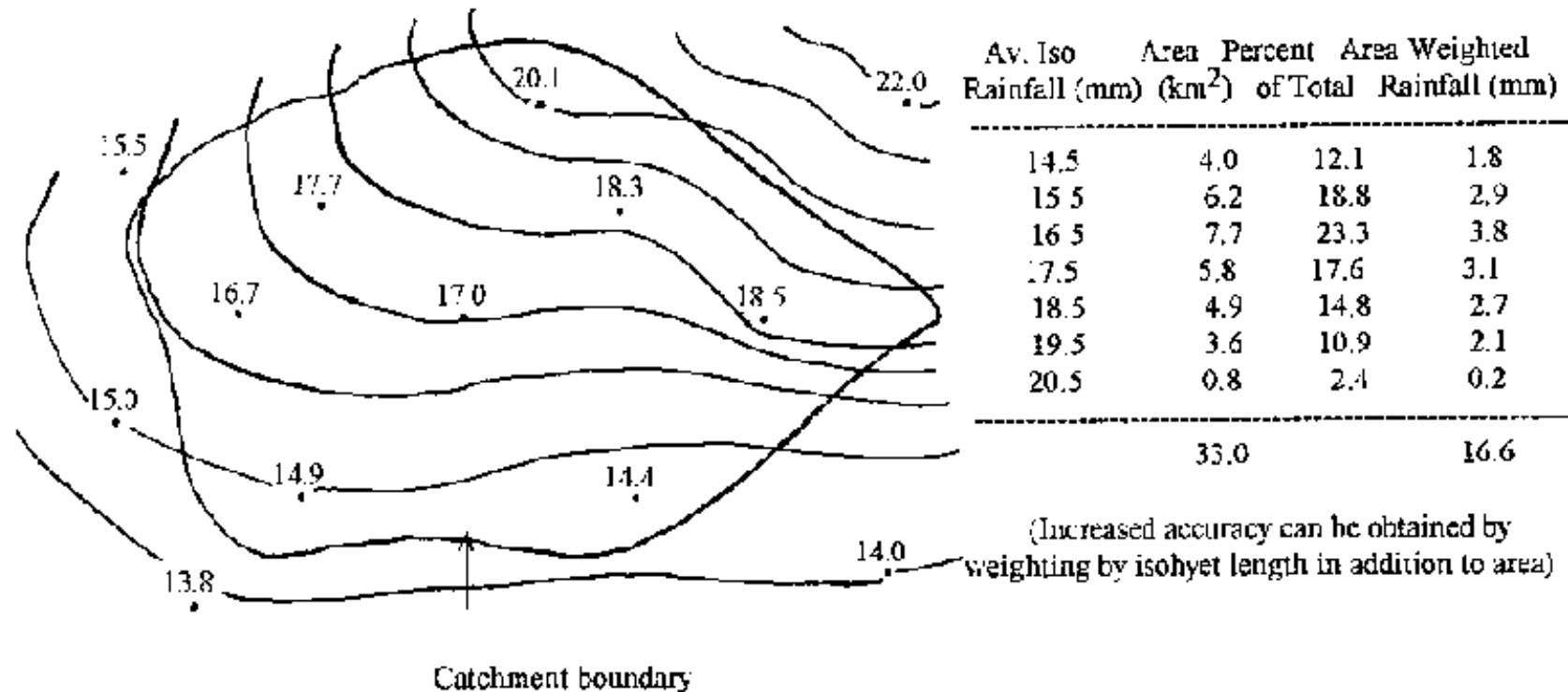
**Figure 8.10: Thiessen Polygon Method to Calculate Rainfall Over an Area (Daily Rainfall)**

**One disadvantage of this method is that the polygons must be re drawn each time data from a station is missing, or if a station is removed from the network. Figure 8.11 illustrates the method of isohyetal construction.**

**The Isohyetal Method uses station data to construct isohyets of equal rainfall. Interpolations between station values are made according to knowledge of topography and climatic regime. The average rainfall depth is then calculated by adding the incremental volume between adjacent pairs of isohyets weighted by area as in Figure 8.11. This method has the advantage that calculations are made**



according to knowledge of the climate and topography of a catchment. Unlike the Thiessen method which relies solely on geometric construction, variation in rainfall amount will reflect changes in altitude and proximity to other meteorological influences.



Catchment boundary

**Figure 8.11: Isohyetal Method**

## Depth -Area -Duration Analysis

DAD analysis is used to determine the greatest precipitation over different areas and for different durations. Regional and seasonal comparisons can be made, though the analysis is only applied to storms that are expected to approach maximum values. Several centres within a storm may have the greatest DAD values and these

**can be compared to identify the greatest for various selected areas and durations. The procedure is often used, but is relatively complex and will be of limited value in many water harvesting situations unless large catchments are under study. The procedure is therefore outlined briefly. Depth-area-duration data may be available from local Meteorological services.**

**Conversion of the 24 hour ("daily") rainfall to a time period more suitable to hydrological purposes is needed, often the 6 hour rainfall amount, so that aggregation into various time periods of, for example, 6, 12, 18, 24 hours, etc., is possible. Comprehensive recorded rainfall data for the storm are needed. Mass curves of rainfall are drawn (accumulated rainfall versus time). Several total storm depth area curves are then prepared by dividing the total storm rainfall map into major centres, where there are more than one, and determining the total size of the area and the average rainfall depth within the area which is enclosed by successive isohyets around each centre.**

**A time breakdown is then needed for these depth-area curves by weighting the rainfall of each station by the ratio of its Thiessen area within the isohyets, to the total area within the isohyets. A time distribution of the total storm rainfall within each isohyet is found. Values are plotted as area versus total rainfall, with different lines for different durations. Smaller areas receive largest rainfall amounts for a given duration, and rainfall amounts generally increase with duration, but regional differences can be very great.**

### **Areal Reduction Factor (ARF)**

**Rainfall depth tends to decrease as area increases. In many instances, this reduction cannot be assessed by the use of a comprehensive network of raingauges, because**

**such a network does not exist. A simple factor that can be applied to point rainfall for a specified duration and return period, and which converts point rainfall to areal rainfall is called an areal reduction factor (ARF). Research has shown that such a factor, for a specified area and duration, does not vary greatly with return period and this aspect can be ignored for practical purposes.**

**A simple ARF can be obtained by selecting the maximum areal rainfall event for a catchment. The rainfalls ( $R_1$ ) at each station are noted. In some cases these will be the same as the maximum annual rainfall event ( $R_2$  for a specified or desired duration,  $D$ ), but in others they will not. The ratios of  $R_1/R_2$  are noted and mapped for each year and an areal mean of  $R_1/R_2$  is found. The mean of a number of years' means is then calculated and this gives the ARF for a known area  $A$  and duration  $D$ .**

**In many cases, comprehensive rainfall records will not be available to allow areal estimates of the mean ARF by mapping, but the method is adaptable to the circumstances most commonly found in developing countries: medium term (> 10 years) daily rainfall records from a limited number of stations. In general it is better to analyse local data in a simple way than import relations obtained from other world regions. A straightforward adaptation of the method described above, to obtain an ARF, is illustrated below by an example. The data originally used for the adaptation came from Belize, in Central America.**

**The 1 day rainfall with a 5 year return period was selected as desirable for the following reasons: the 1 day rainfall is commonly available, it is suitable for use since the 1 day and runoff-producing storm rainfall are often very similar, and they can be regressed and their precise relation determined; the 5 year return period is one widely applicable to farm practice, though the 10 year return could also be**

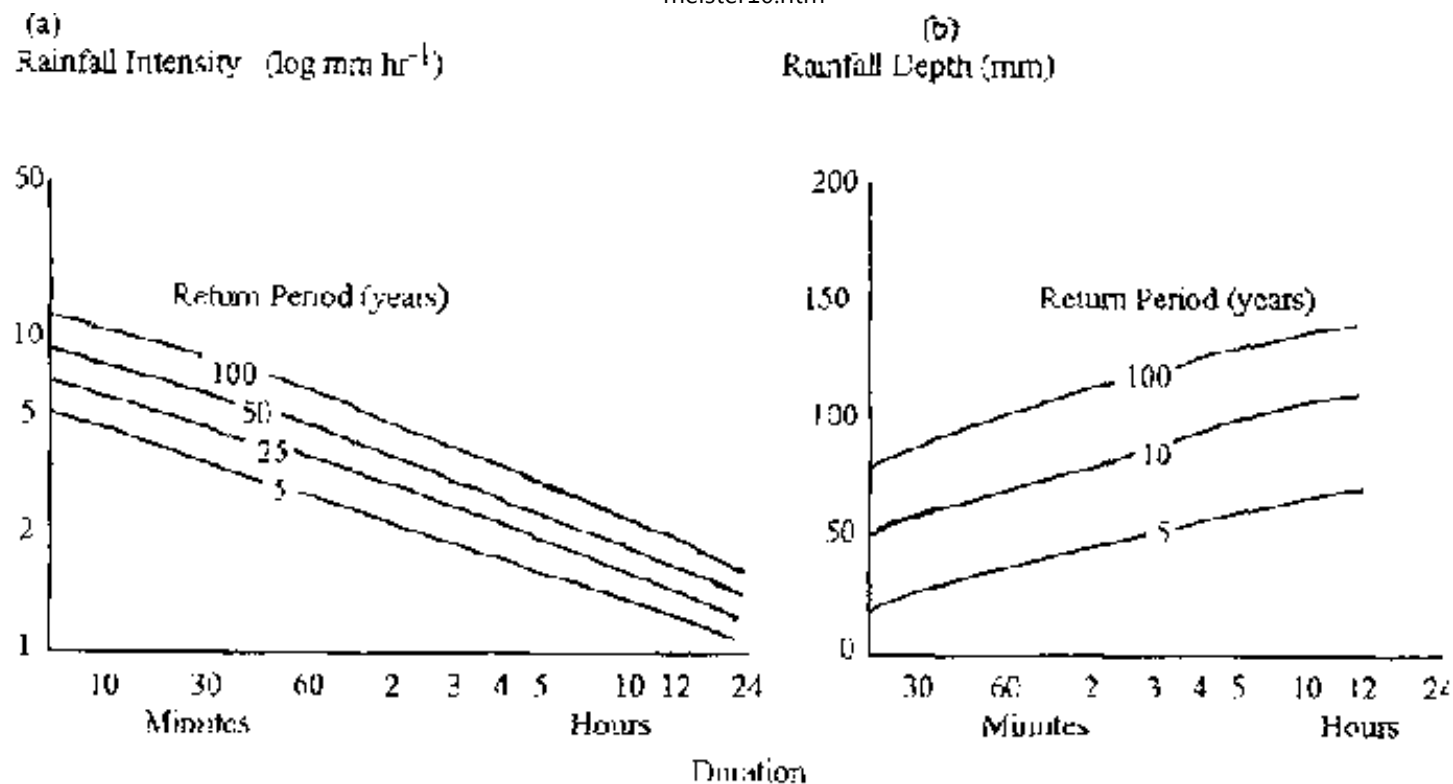
**justified. Eleven rainfall stations (maximum station data 22 years) were used in the analysis, over an area of approximately 2000 km<sup>2</sup>.**

**According to their long term average annual rainfall, the rainfall stations were divided into three groups, each located within one of three AAR bands of 1400 - 2000 mm, 2000 - 2800 mm and > 2800 mm per year. This information was obtained from isohyetal maps. The R<sub>1</sub> and R<sub>2</sub> values were listed for each station and year, and the ratios of R<sub>1</sub>/R<sub>2</sub> were obtained. The arithmetical average of the ratios was then calculated for each station. The overall average ARF for each rainfall band was then obtained from the stations within it, by weighting according to the length of station records.**

**The area-reduced, 1 day 5 year point rainfall for each station was then found by listing daily rainfall in an annual maximum series and applying the appropriate band ARF. These then gave an average, area reduced value of the 1 day, 5 year rainfall for the catchments under study, the contribution from each station being weighted according to area as defined by the Thiesson method. Where a catchment was composed of areas lying within different isohyetal bands, the different ARFs were applied, also by weighting in proportion to area.**

### **Rainfall Depth and Intensity - Frequency Relations**

**Where sufficient records exist, the relations between rainfall intensity or total rainfall amount, duration and return period are often established, for use in practical applications concerning runoff, such as the theoretical calculation of peak flow values. One of two methods are usually applied, but reasonably long-term intensity gauge records are needed for both.**



**Figures 8.12 (a) and (b) Rainfall Intensity-Duration and Depth-Duration Frequency Graphs**

**In the first method a particular time interval is selected for convenience; the 5, 10 or 15 minute interval is often used, and the maximum depths and mean intensities are calculated for this time interval. Generally, mean intensities will be highly variable within the time period and will become less hydrologically significant as the time period increases. In the second method, the highest rainfall intensity for any duration is the criterion for interpretation. Rainfall depth by segments of the intensity trace are classified to determine hydrological response. Typical relations for return period intensity and duration for a particular station are illustrated in Figures 8.12 (a) and (b). Locations with similar relations may be mapped where**

**there is sufficient information.**

## **Theoretical Distributions**

**Rainfall data may be analysed according to the methods which apply theoretical statistical (usually Extreme Value) distributions to the data, as discussed in section 8.1 using runoff data. Return periods and probabilities for different rainfall amounts can be obtained. The Pearson Type III distribution (with varying skewness coefficients) has been found to fit semi-arid data to a satisfactory extent in many cases. The validity of different distributions may be compared or tested using the Chi-square test, described in section 8.1.**

**Unlike temperate climates which usually have a normal distribution, rainfall distributions in semi arid regions tend to be positively skewed, that is they have many more rainfalls smaller than the mean, than greater than the mean. The mode is less than the value exceeded in 50% of years (the median) and the mode and median are less than the mean. The mean is of limited use in describing the central tendency of data in these areas and the mode is often used as the statistic to describe the most frequently experienced conditions best. Associated with the skewness of such data is the difficulty in obtaining estimates of mean rainfall without large errors, especially from short records.**

**The annual maximum series and partial duration series are also used to evaluate extreme rainfalls and their probabilities by ranking and the imposition of selected thresholds.**

**Alternatively, the probability of daily rainfall amounts may be studied by grouping rainfall according to amount, for example rainfalls greater than 1 mm, 5 mm, 100**

mm etc. and calculating their probabilities. Table 8.8 below gives an example.

-Station	Rainfall Depth Class (mm)								
	>0	>1	>5	>10	>15	>25	>40	>60	>100
MS 1	103	98	56	23	15	8	2	-	-
MS 2	145	109	76	45	20	14	8	2	1
MS 3	225	209	174	98	35	20	10	4	2
MS 4	153	111	87	20	16	7	1	0	0
MS 5	134	100	65	34	6	1	-	-	-
Total	760	627	458	220	92	50	21	6	3
Mean	152	125	92	44	18	10	4	1.2	0.6
Probability	1.00	0.825	0.603	0.289	0.121	0.066	0.028	0.008	0.004

**Table 8.8: Probability Distribution of Daily Rainfall Occurrences**

**Bi-modal distributions of rainfall (two main peaks in the rainfall season) are also often evident, due to different meteorological conditions that prevail. In these circumstances it may be necessary to study rainfall statistics on a short period basis, so that the parent population of rainfall events accounts for this bi-modality.**

### **8.2.3 Evaporation and Evapotranspiration**

**The use of evaporation and evapotranspiration data is important to runoff and agricultural studies. The rate at which runoff is produced will often depend on the existing wetness of the soil, which in turn is highly inversely correlated to evaporation and evapotranspiration losses. Plant growth is intimately bound to soil moisture availability and the stage and rate of crop growth will be affected as well as be influenced by evapotranspiration**

#### **8.2.3.1 Free Surface Evaporation**

**Evaporation is most commonly measured for agricultural purposes using evaporation pans (chapter 4) and the US.**

**Weather Bureau 'A' pan is now the world international reference pan type. Although other pan designs are met with, most organisations use 'A' pans and methods of estimating evaporation in the following section concern this type of pan.**

**The evaporation ( $E_0$ ) from a free surface is impossible to measure when surface areas are very large; however coefficients which quantify the relations between evaporation losses from 'A' pan data and water bodies have been arrived at. These vary according to location and seasonal and short-term changes in weather. They can be used to obtain evaporation estimates from streams and other water bodies. For example if 'A' pan losses are 2 mm day<sup>-1</sup> and the evaporation coefficient is 0.70, the daily free surface evaporation from a distribution channel 2 km long and 5 m wide will be:**

$$\text{fdse} = E_0 = 2000 \times 5 \times 0.002 \times 0.70 = 14 \text{ m}^3 \text{ day}^{-1}$$

**Losses from seepage, percolation etc., are not accounted for. In a similar way, reservoir storage losses can be estimated, usually by using monthly values of the pan coefficient.**

**The measurement of climatic variables is essential in establishing pan coefficients, and in most countries some information on these coefficients will be available. Temperature, wind speed and duration, barometric pressure and the nature of the container all effect evaporation measurements to various degrees. Table 8.9 gives some examples of long-term annual 'A' pan coefficients and examples of seasonal**



## variation at Khartoum (Sudan) and Lake Hefner (USA).

Location	Period	Class 'A' Coeff	Location	Period	Class 'A' Coeff.								
<b>Australia</b>													
Lake Albacutya	annual	0.79	Sudan										
Lake Hindmarsh	annual	0.74	Khartoum	annual	0.65								
Lake Pamamaroo	annual	0.66											
<b>India</b>													
Poona	annual	0.69	U.K.										
			London	annual	0.70								
<b>Israel</b>													
Lod Airport	annual	0.74	USA										
			Davis Calif.	annual	0.72								
			Denver Col.	annual	0.67								
	Year	J	F	M	A	M	J	J	A	S	O	N	D
Khartoum	1960	0.68	0.60	0.65	0.62	0.64	0.67	0.62	0.65	0.69	0.69	0.64	0.61
Lake Hefner	1951	0.76	0.13	0.51	0.39	0.52	0.65	0.64	0.72	-	-	-	-

**Table 8.9: Example 'A' Pan Coefficients**

### Empirical Formulae

Many empirical formulae have been developed to estimate evaporation, based on Dalton's Law; the basic driving mechanism of these equations is the difference in vapour pressure between water and the atmosphere. The greatest problem with empirical formulae is the difficulty in measuring the components of the equations in a manner that can be related realistically to the dynamic processes that lead to evaporation.

Dalton's equation is  $E = C ( e_s - e_d )$  where (8.29)

**E** is the rate of evaporation

**C is a constant**

**$e_s$  is saturated vapour pressure at the temperature of the water surface in mm of Hg.**

**$e_d$  is actual vapour pressure of the air ( $e_s \times$  relative humidity) in mm of Hg.**

**The constant C in equation 8.29 has been described as:**

$$C = (0.44 + 0.073 W) (1.465 - 0.00073p) \text{ where (8.30)}$$

**W is wind speed in  $\text{km hr}^{-1}$  at 0.15 m**

**p is atmospheric pressure in mm of Hg at  $0^\circ\text{C}$ .**

**E is in  $\text{mm day}^{-1}$  and reservoir evaporation =  $E \times 0.77$**

**Alternatively, the constant C for shallow ponds and evaporation pans has been evaluated as:**

$$C = 15 + 0.93 W \text{ (8.31)}$$

**and for small lakes and reservoirs as:**

$$C = 11 + 0.68W \text{ (8.32)}$$

**with W as for equation 8.30.**

**The Water Balance method of estimating evaporation from reservoirs, compares changes in storage with a balance of known in flow and out flow. This method appears to be simple, but seepage losses are extremely difficult to calculate or measure accurately. Precipitation onto the reservoir can also be a complicating**

**factor. Energy Balance methods are analogous to water in flow and out flow, balancing all the energy components in the evaporation process. However, although they have been tested more rigorously in recent years, difficulties still remain with instrumentation and their use is not widespread.**

## **Evaporation from Soil Surfaces**

**The evaporation of water from soil surfaces is a more complex process than that from a free water surface. Although during periods of saturation, these processes may be very similar, saturated conditions rarely last for long and the evaporation rate drops rapidly as soil moisture levels decrease; evaporation from soils at less than field capacity may even be regarded as generally unimportant. Soil evaporation losses are defined by free energy and the free energy required by plants to take water at wilting point is less than 0.1% more than at saturation. In addition, evaporation from soils depends on the nature of the soil; its texture, chemistry, organic content, vegetation cover and depth. The losses from soils and vegetation are usually combined and treated as one process, termed evapotranspiration, though in regions where vegetation cover approaches zero or plants become dormant at certain seasons of the year, it may be desirable to monitor evaporative losses of soil moisture.**

### **8.2.3.2 Evapotranspiration**

**Transpiration is the process whereby plants lose water from their leaf stomata and is essentially the same as evaporation, though not from a free water surface. Losses are proportional to the diameter of the stomata, but not their area, as is true for a perforated membrane. The rate of transpiration is essentially governed by the difference between vapour pressure under the stomata and that of the atmosphere,**

**the number of stomata per unit area being variable with species and climatic conditions. Evapotranspiration ( $E_t$ ), sometimes called 'consumptive use', is the evaporation of water from all sources combined. The term 'potential evapotranspiration' ( $E_p$ ) defines conditions where water availability is in no way limiting. 'Actual evapotranspiration' ( $E_a$ ) attempts to define realistic conditions, whereby rates fluctuate according to the availability of water and changes in climatic conditions.**

### **Evaporation Pans**

**Because the soil water availability conditions that allow potential evapotranspiration are not often met with, empirical studies have attempted to relate 'A' pan evaporation values to actual evapotranspiration values. Such relations should be used with caution, though most experimental data show them in the form:**

$$\text{Crop (Actual) Evapotranspiration } E_a = k E_0 \text{ (Pan Evaporation.) (8.33)}$$

**where  $k$  is a coefficient according to crop and stage of growing season.**

**Table 8.10 gives values of  $k$  for a variety of crops during different stages of growth. Values take some account of incomplete shading, but crop density, soil variability, wind profile etc., can make significant differences and values should be only regarded as a guide.**

Crop Type	Stage of growing season (% of total)										
	0	10	20	30	40	50	60	70	80	90	100
Alfalfa	0.55	0.60	0.70	0.80	0.90	0.95	0.95	0.95	0.90	0.80	0.65
Beans	0.20	0.30	0.40	0.65	0.85	0.90	0.90	0.80	0.60	0.35	0.20
Citrus	0.50	0.45	0.45	0.45	0.45	0.45	0.50	0.55	0.60	0.55	0.50
Maize	0.20	0.30	0.50	0.65	0.80	0.90	0.90	0.85	0.75	0.60	0.50
Cotton	0.10	0.20	0.40	0.55	0.75	0.90	0.90	0.85	0.75	0.55	0.35
Sorghum	0.20	0.35	0.55	0.75	0.85	0.90	0.85	0.70	0.60	0.35	0.15
Groundnuts	0.15	0.25	0.35	0.45	0.55	0.60	0.65	0.65	0.60	0.45	0.30
Rice	0.80	0.95	1.05	1.15	1.20	1.30	1.30	0.12	1.10	0.95	0.50

**Table 8.10: Coefficient k to be Multiplied by 'A' Pan Evaporation to give Actual Evapotranspiration**

## Empirical Formulae

A wide range of empirical formulae have been developed to calculate evapotranspiration. The most commonly used are discussed below.

### a. Blaney-Criddle Equation

This relatively simple equation estimates consumptive use when water availability is not a limiting factor. Like many of the empirical equations for evapotranspiration it is most suitable for conditions immediately after rainfall, irrigated conditions or as a climatic descriptor:

Monthly  $E_p$  (in inches) =  $kF$  where (8.34)

$F = (t \times p) / 100$

$k$  is the annual, seasonal or monthly consumptive use coefficient (for different crops)

$p$  is the monthly % of daytime hours of the year, occurring during the period

**t is the mean monthly temperature in °F**

**The greatest difficulty in applying the equation is the determination of the crop factor 'k', which varies not only with crop type, but also with climate and growing season. Examples are given below in Table 8.11, which relate to specified crop growing season lengths.**

Crop type	k Coastal	k Arid	Crop type	k Coastal	k Arid
Citrus	0.50	0.65	Maize	0.75	0.85
Beans	0.60	0.70	Small grains	0.75	0.85
Cotton	0.60	0.65	Grass	0.75	0.85
Sorghum	0.70	0.85	Rice	1.00	1.20

**Table 8.11: Crop Coefficients (k) for the Blaney- Criddle Equation**

**Table 8.12 gives daytime hours percentages for various latitudes.**

Latitude in °												
North	J	F	M	A	M	J	J	A	S	O	N	D
60	4.67	5.65	8.08	9.65	11.74	12.39	12.31	10.70	8.57	6.98	5.04	4.22
50	5.98	6.20	8.24	9.24	10.68	10.91	10.99	10.00	8.46	7.45	6.10	5.63
40	6.76	6.72	8.33	8.95	10.02	10.08	10.22	9.54	8.39	7.75	6.72	6.52
35	7.05	6.88	8.35	8.83	9.76	9.77	9.93	9.37	8.36	7.87	6.97	6.86
30	7.30	7.03	8.38	8.72	9.53	9.49	9.67	9.22	8.33	7.99	7.19	7.15
25	7.53	7.14	8.39	8.61	9.33	9.23	9.45	9.09	8.52	8.09	7.40	7.42
20	7.74	7.25	8.41	8.52	9.15	9.00	9.25	8.96	8.30	8.18	7.58	7.66
15	7.94	7.36	8.43	8.44	8.98	8.80	9.05	8.83	8.28	8.26	7.75	7.88
10	8.13	7.47	8.45	8.37	8.81	8.60	8.85	8.71	8.25	8.34	7.91	8.10
0	8.50	7.66	8.49	8.21	8.50	8.22	8.50	8.49	8.21	8.50	8.22	8.50
South												
10	8.86	7.87	8.53	8.09	8.18	7.86	8.14	8.27	8.17	8.62	8.53	8.88
20	9.24	8.09	8.57	7.94	7.85	7.43	7.76	8.03	8.13	8.76	8.87	9.33
30	9.70	8.53	8.62	7.73	7.45	6.96	7.31	7.76	8.07	8.97	9.24	9.85
40	10.27	8.63	8.67	7.49	6.97	6.37	6.76	7.41	8.02	9.21	9.71	10.49

**Table 8.12: Daytime Hours Percentages ( 100 p) for the Blaney-Criddle Equation**

### Thornthwaite Equation

**This equation is based on an exponential relation between monthly mean temperature and mean monthly consumptive use, based on experience gained in the central and eastern states of the USA. It is widely-applied, but tends to be less satisfactory in regions that undergo frequent short-term changes in temperature and relative humidity.**

**Monthly  $E_p$  in mm =  $16(10t/I)^a$  where (8.35)**

**t is the mean monthly temperature °C**

**I is a temperature efficiency index (and is equal to the sum of 12 monthly values of the heat index 'i' which = (t/5)**

**1514 for each month of the year and where t is the mean monthly temperature in ° C).**

**a is a cubic function of the annual heat index ' I ', which can be obtained from Table 8.13 or from**

$$a = 6.75 \times 10^{-7} I^3 - 7.71 \times 10^{-5} I^2 + 1.792 \times 10^{-2} I + 0.49239 \quad (8.36)$$

I	a	I	a
10	0.664	50	1.280
15	0.753	55	1.356
20	0.825	60	1.435
25	0.902	70	1.600
30	0.978	75	1.687
35	1.054	80	1.778
40	1.128	85	1.873
45	1.203	90	1.973

**Table 8.13: Values of 'a' in the Thornthwaite Equation**

**It is necessary to adjust the calculated rates of evapotranspiration, because monthly durations are not equal and the number of hours of evaporation in a day will vary with latitude and season. The adjustment factors are given in Table 8.14.**



Latitude in °	J	F	M	A	M	J	J	A	S	O	N	D
0	1.04	0.94	1.04	1.01	1.04	1.01	1.04	1.04	1.01	1.04	1.01	1.04
10	1.00	0.91	1.03	1.03	1.08	1.06	1.08	1.07	1.02	1.02	0.98	0.99
20	0.95	0.90	1.03	1.05	1.13	1.11	1.14	1.11	1.02	1.00	0.93	0.94
30	0.90	0.87	1.03	1.08	1.18	1.17	1.20	1.14	1.03	0.98	0.89	0.88
35	0.87	0.85	1.03	1.09	1.21	1.21	1.23	1.16	1.03	0.97	0.86	0.85
40	0.84	0.83	1.03	1.11	1.24	1.25	1.27	1.18	1.04	0.96	0.83	0.81
45	0.80	0.81	1.02	1.13	1.28	1.29	1.31	1.21	1.04	0.94	0.79	0.75
50	0.74	0.78	1.02	1.15	1.33	1.36	1.37	1.25	1.06	0.92	0.76	0.70

**Table 8.14: Adjustment Factors for Thornthwaite Values of  $E_p$**

## Penman Equation

**Penman's equation is the most complete theoretical approach to estimating potential evapotranspiration. The collection of data for many of the meteorological variables described in chapter 4 is directly attributable to the application of this equation. The equation is probably the most widely used empirical formula and shows that the consumptive use of water is inseparable from the level of incoming solar energy. In effect, the Penman equation is a combination of a measure of the drying power of the air and an estimate of available net radiation.**

**Penman's Equation is of the general form:**

$$E_p \text{ in mm day}^{-1} = [D / d (R_n) + E_a] / [(D_e/d) + 1] \text{ where (8.37)}$$

**D is the slope of the saturated vapour pressure curve / temperature curve at mean air temperature in mm Hg °C<sup>-1</sup>**

**$R_n$  is the net solar radiation [ $R_i (1 - r) - R_b$ ] where**

**$R_i$  is the radiation reaching the earth's surface in  $\text{cals cm}^{-2} \text{ min}^{-1}$  and is  $= R_s (a + bn / N)$  where**

**$R_s$  is incoming radiation in terms of mm of water evaporated  $\text{day}^{-1}$ , 'a' and 'b' are latitude constants**

**N is the maximum possible duration of bright sunshine in hours, at the location**

**r is the reflectance (albedo) of the surface which is a ratio of reflected radiation / incident radiation**

**$R_b$  is the long wave back radiation**

**d is the psychrometric constant,  $0.49 \text{ mm Hg } ^\circ \text{C}^{-1}$  or  $0.66 \text{ mb } ^\circ \text{C}^{-1}$**

**$E_a$  is the mass transfer (Dalton's equation component) and is  $= f(u) (e_s - e)$  where**

**$f(u)$  is a function of wind speed in  $\text{m s}^{-1}$**

**$e_s$  is the saturated vapour pressure at air temperature at the evaporating surface in millibars**

**e is the vapour pressure of the atmosphere above in millibars**

**Penman's equation has been modified for various conditions and locations of**

**latitude, with different values for the various numerical factors included in the equation. The example of Penman's modified equation below is given with constants according to a geographical location in the central USA, with constants and variables for °C, potential evapotranspiration is in mm day<sup>-1</sup>.**

$$E_p = \frac{D}{D + d} [R_s (1-r) (0.22 + 0.55(n/N)) - \frac{D}{D + d} [d T_a^4 (0.56 - 0.091 e_d^{1/2}) (0.10 + 0.90(n/N))] + \frac{d}{D + d} [(0.175 + 0.0035 u) (e_a - e_d)]] \quad (8.38)$$

**(This equation is in wide use elsewhere, with only minor modifications of the numerical constants given above.) where,**

**$E_p$ ,  $d$ ,  $D$ ,  $r$  and  $N$  are as above in equation 8.37**

**$n$  is the actual number of sunshine hours recorded**

**$R_s$  is radiation at the top of the atmosphere and relates to time of year and latitude**

**$d$  is the Stefan-Boltzman constant,  $2.01 \times 10^9$**

**$T_a^4$  is black body radiation at mean air temperature (= mean daily air temperature + 273 °K in mm of evaporation)**

**$u$  is the wind run at 2m in km day<sup>-1</sup>**

**$e_a$  is saturation vapour pressure at mean daily temperature (millibars)**

**$e_d$  is mean vapour pressure (millibars)**

**Table 8.15 Coefficients a and b**

Latitude (° N and S)	a	b
54	0.21	0.55
36	0.23	0.53
24	0.28	0.49
13	0.26	0.50
3	0.26	0.44

**Table 8.16 Typical Albedo Rates**

Surface	Albedo
Close growing crops	0.15-0.25
Bare land surfaces	0.05 - 0.45
Forest	0.15
Water	0.05

**(The Tables of the Smithsonian Institute provide a comprehensive guide to albedo rates)**

**Care should be taken that variables and constants are those appropriate for measurements in ° C or ° F when applying versions of the equation that may have been developed locally. Tabulated values for the components of Penman's equation**

are available to assist calculation and are given below. They are used with an illustrative example of Penman calculations.

$^{\circ}\text{K}$	$^{\circ}\text{C}$	$\sigma T_a^4$
273	0	11.22
278	5	12.06
283	10	12.25
288	15	14.88
293	20	14.88
298	25	15.92
303	30	17.02
308	35	18.17
313	40	19.38

**Table 8.17: Values of  $\sigma T_a^4$  for Different Temperatures**

$^{\circ}\text{C}$	$\Delta/\Delta + \gamma$	$\epsilon/\Delta + \gamma$
1	0.417	0.583
5	0.478	0.522
10	0.552	0.448
15	0.621	0.379
20	0.682	0.318
25	0.735	0.265
30	0.781	0.219
35	0.819	0.181
40	0.851	0.149

**Table 8.18: Values of  $D/D + d$  and  $d/D + d$  for Different Temperatures**

**Table 8.19 gives values of  $R_s$  for different latitudes.**

**Table 8.20 gives values of possible sunshine hours for different months and latitudes.**

**Figure 8.13 gives saturation vapour pressure for temperature values °C and °K.**

Latitude in °	J	F	M	A	M	J	J	A	S	O	N	D
<b>North</b>												
70		1.1	4.3	9.1	13.6	17.0	15.8	11.4	6.8	2.4	0.1	
60	1.3	3.5	6.8	11.1	14.6	16.5	15.7	12.7	8.5	4.7	1.9	0.9
50	3.6	5.9	9.1	12.7	15.4	16.7	16.1	13.9	10.5	7.1	4.3	3.0
40	6.0	8.3	11.0	13.9	15.9	16.7	16.3	14.8	12.2	9.3	6.7	5.5
30	8.5	10.5	12.7	14.8	16.0	16.5	16.2	15.3	13.5	11.3	9.1	7.9
20	10.8	12.3	13.9	15.2	15.7	15.8	15.7	15.3	14.4	12.9	11.2	10.3
10	12.8	13.9	14.8	15.2	15.0	14.8	14.8	15.0	14.9	14.1	13.1	12.4
0	14.5	15.0	15.2	14.7	13.9	13.4	13.5	14.2	14.9	15.0	14.6	14.3
10	15.8	15.7	15.1	13.8	12.4	11.6	11.9	13.0	14.4	15.3	15.7	15.8
20	16.8	16.0	14.6	12.5	10.7	9.6	10.0	11.5	13.5	15.3	16.4	16.9
30	17.3	15.8	13.6	10.8	8.7	7.4	7.8	9.6	12.1	14.8	16.7	17.6
40	17.3	15.2	12.2	8.8	6.4	5.1	5.6	7.5	10.5	13.8	16.5	17.8
50	17.1	14.1	10.5	6.6	4.1	2.8	3.3	5.2	8.5	12.5	16.0	17.8
60	16.6	12.7	8.4	4.3	1.9	0.8	1.2	2.9	6.2	10.7	15.2	17.5
70	16.5	11.2	6.1	1.9	0.1			0.8	3.	8.8	14.5	18.1
<b>South</b>												

**Table 8.19: Values of  $R_S$  for Different Latitudes in  $\text{mm day}^{-1}$**

**Mid Monthly Radiation on a Horizontal Surface in  $\text{mm of Water Day}^{-1}$  Evaporated**

Latitude °	J	F	M	A	M	J	J	A	S	O	N	D
<b>North</b>												
50	0.74	0.78	1.02	1.15	1.33	1.36	1.37	1.25	1.06	0.92	0.76	0.70
45	0.80	0.81	1.02	1.13	1.28	1.29	1.31	1.21	1.04	0.94	0.79	0.75
40	0.84	0.83	1.03	1.11	1.24	1.23	1.27	1.18	1.04	0.96	0.83	0.81
35	0.87	0.85	1.03	1.09	1.21	1.21	1.23	1.16	1.03	0.97	0.86	0.85
30	0.90	0.87	1.03	1.08	1.18	1.17	1.20	1.14	1.03	0.98	0.89	0.88
25	0.93	0.89	1.03	1.06	1.15	1.14	1.17	1.12	1.02	0.99	0.91	0.91
20	0.95	0.90	1.03	1.05	1.12	1.11	1.14	1.11	1.02	1.00	0.93	0.94
15	0.97	0.91	1.03	1.04	1.11	1.08	1.12	1.08	1.02	1.01	0.95	0.97
10	1.00	0.91	1.03	1.03	1.08	1.06	1.08	1.07	1.02	1.02	0.98	0.99
5	1.02	0.93	1.03	1.02	1.06	1.03	1.06	1.05	1.01	1.03	0.99	1.02
0	1.04	0.94	1.03	1.01	1.04	1.01	1.04	1.04	1.01	1.04	1.01	1.04
5	1.06	0.95	1.04	1.00	1.02	0.99	1.02	1.03	1.00	1.05	1.03	1.06
10	1.08	0.97	1.05	0.99	1.01	0.96	1.00	1.01	1.00	1.05	1.05	1.10
15	1.12	0.98	1.05	0.98	0.98	0.94	0.97	1.00	1.00	1.07	1.07	1.12
20	1.14	1.00	1.05	0.97	0.96	0.91	0.95	0.99	1.00	1.08	1.09	1.15
25	1.17	1.01	1.05	0.96	0.94	0.88	0.93	0.98	1.00	1.10	1.11	1.18
30	1.20	1.03	1.06	0.95	0.92	0.85	0.90	0.96	1.00	1.12	1.14	1.21
35	1.23	1.04	1.06	0.94	0.89	0.82	0.87	0.94	1.00	1.13	1.17	1.25
40	1.27	1.06	1.07	0.93	0.86	0.78	0.84	0.92	1.00	1.15	1.20	1.29
45	1.31	1.09	1.07	0.92	0.83	0.73	0.79	0.90	1.00	1.17	1.24	1.34
50	1.37	1.12	1.08	0.89	0.77	0.67	0.74	0.88	0.99	1.19	1.29	1.41
<b>South</b>												

**Table 8.20: Mean Possible Sunshine, N**

**To calculate maximum duration of sunlight for any month multiply  $12 \times 30 \times$  coefficient**

**Local variations of Penman's equation are often developed after a comprehensive study of local climatic variables. The example below is for the semi arid and arid conditions found in southern Africa, the value of x being 0.5 for open surface evaporation and 1.0 for evapotranspiration.**

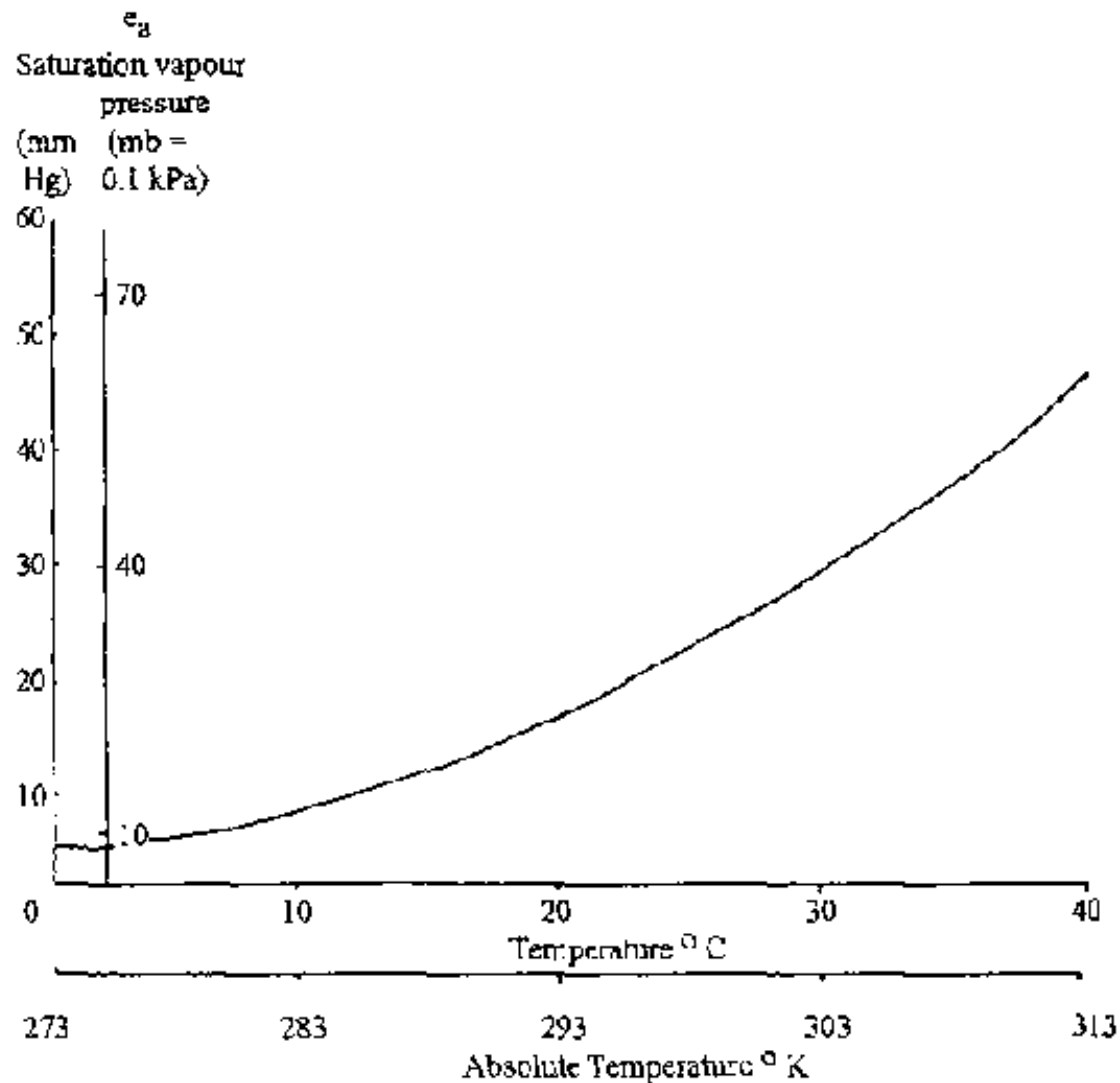
$$E_p = \frac{D}{D + d} [R_s(1-r) (0.25 + 0.50 (n/N))] - \frac{D}{D + d} [d T_a^4 (0.32 - 0.42e_d) (0.30 + 0.70 (n/N))] + \frac{d}{D + d} [(x + 0.0062 u) (e_a - e_d)] \quad (8.39)$$

**In this equation it is interesting to note that the term  $(0.32 - 0.42e_d)^{1/2}$  is always negative, thereby adding to the calculated evapotranspiration obtained from the overall formula.**

**Penman's equation was developed for estimates of  $E_p$  from short grass under humid conditions. These conditions are frequently not met with, though they may be simulated by the presence of wet soil after rain, shallow water bodies or irrigated conditions.**

**In arid and semi arid areas, localised variations in crop cover may lead to areas of crops being surrounded by hotter, drier conditions, and is sometimes referred to as the "oasis effect". In these circumstances more energy is available for evapotranspiration than indicated by measured incoming solar radiation, leading to increased and widely different localised rates of evapotranspiration.**





**Figure 8.13: Saturation Vapour Pressure with Temperature**

**A worked example of a Penman calculation is given below:**

**Worked Example**

**Substituting into equation 8.38:**

$$E_p = 0.753 [14.6 (0.75) (0.22 + 0.55 (0.65))] - 0.753 [16.34 (0.56 - 0.09 (4.77)) (0.10 + 0.90 (0.65))] + 0.247 [(0.175 + 0.0035 (125) (35.0 - 22.75))] = 0.753 [6.324] - 0.753 [1.463] + 0.247 [5.534] = 5.03 \text{ mm day}^{-1}$$

In addition to the difficulty of equating consumptive use to actual crop use, a difficulty shared with all empirical ED equations, one particular problem with Penman's equation is the requirement of data for a wide range of measured variables. Some work has been undertaken to relate, through regression analysis, the major components of Penman's equation with values of  $E_p$  calculated from the full equation. For example  $R_s$  which is tabulated and  $u$  the windrun which is easily measured, versus  $E_p$  could be used. Ten day mean values of evapotranspiration are often used rather than daily values and  $E_p$  does not vary greatly between locations with similar prevailing weather conditions.

Location: latitude 20° S Month: March		
Data:	From	Value
1. Air temp (°C)	measured	27.0
2. Relative humidity (%)	"	65.0
3. Sunshine (n/N)	"	"
and Table 8.20	0.65	
4. Windrun at 2m, $u$ , ( $\text{km day}^{-1}$ )	measured	125.0
5. Radiation, $R_s$ , ( $\text{mm day}^{-1}$ )	Table 8.19	14.6
6. Reflection coefficient, $r_s$	Table 8.16	0.25
7. $(1 - r)$		0.75
8. $\sigma T_a^4$	Table 8.17	16.34
9. Sat. vap. press. at air temp, $e_a$	Figure 8.13	35.0
10. Mean vap. press, $e_d$	item 2 x $e_a$	22.75
11. $\sqrt{e_d}$		4.19
12. $\gamma/\Delta + \gamma$	Table 8.18	0.753
13. $\gamma/\Delta + \Delta$	Table 8.18	0.247

## Table

**In basin resources studies the problems of localised variation is not great, but in cases where localised values of actual evapotranspiration are needed, the situation is often more difficult. For example the response by plants to reduced water availability may lower actual rates of evapotranspiration from more than 60% of potential to 10% or less. The problems involved in the application of empirical formulae to estimate actual water losses by evapotranspiration go a long way to explain the continued measurement of these losses by lysimetry and other field methods.**

**The FAO is currently undertaking a review of methods for the calculation of evapotranspiration and is expected soon to pronounce on the methods it regards as most appropriate.**

### **8.2.4 Sedimentation Data Analysis**

**The most common analysis of sedimentation data is a regression relation against runoff, often called a sediment-rating curve. The sedimentation factor may be sedimentation concentration,  $C_s$  or sediment load,  $Q_s$ . Such a relation may be applied to long term flow records and produces a sediment-duration curve. The best fits are given by plotting log 10 discharge against log 10 sedimentation and the best correlations are obtained by using load rather than concentration as the sediment factor. The form of the equation is:**

$$Q_s = aQ^b$$

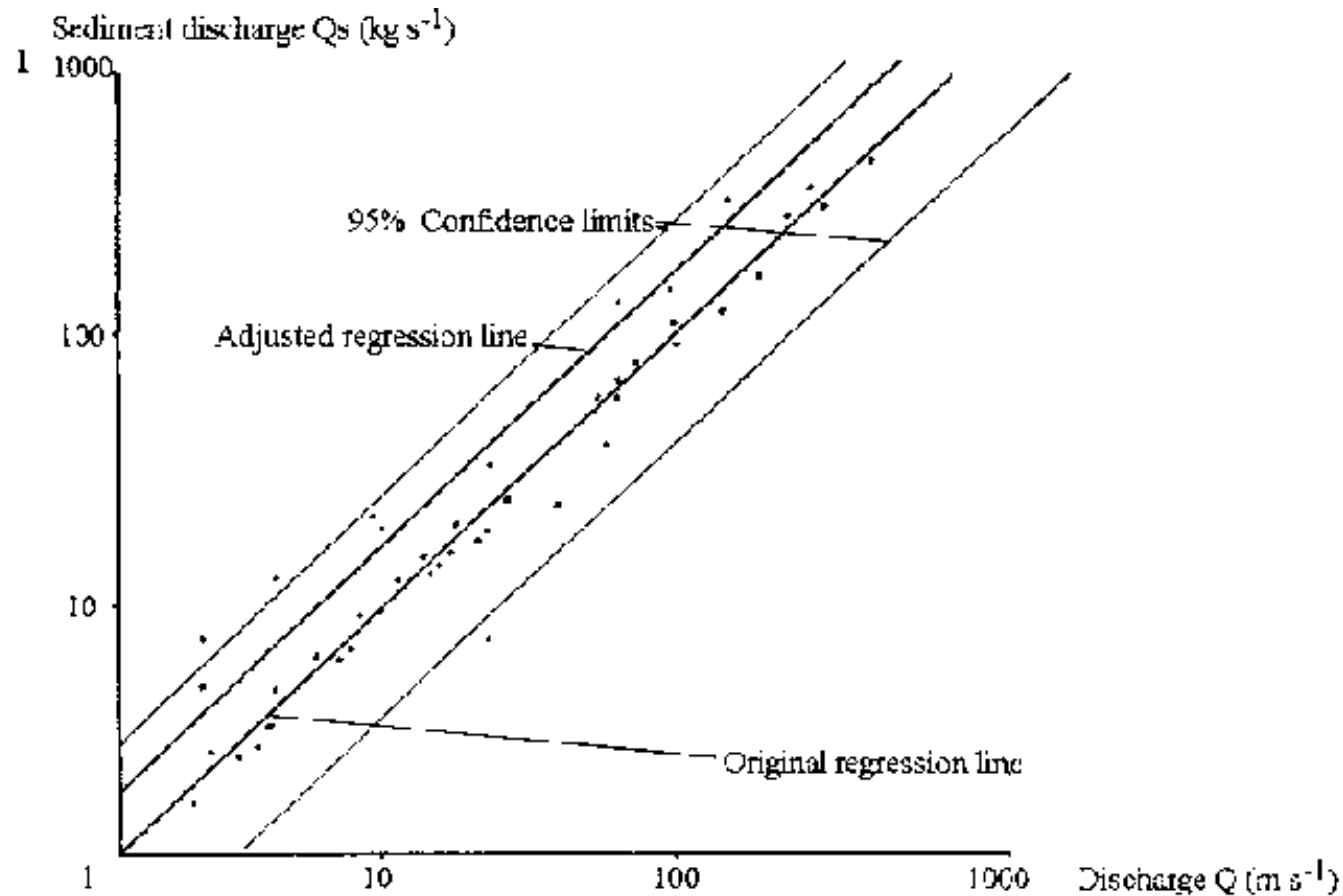
$$\text{thus } \log Q_s = b (\log Q) + \log a \quad (8.33)$$

**The coefficient a has no particular range of values but is related to width of the channel in the form, the sediment per unit width of channel given by  $q_s = a Q^b / W$ .**

**The coefficient b however, has a lower limit, where  $b = 1$  the concentration is constant and independent of Q, where  $b > 1$  the concentration increases with Q. In practice, b is often from 1.4 to 2.8. The scatter of data is often wide, perhaps representing an order of magnitude at the 90% confidence limits. This may be due to random errors of sampling, laboratory procedure or the fact that the quantity of sediment in transport is related to many other physical variables than discharge alone. Figure 8.14 shows a graph of log  $Q_s$  against log discharge Q.**

**In such a case, the regression line of the log values is often ignored, or rather replaced by a second regression line. This second regression is positioned to pass through the means of the actual values of  $Q_s$  and Q, rather than the means of the log values. The line is drawn parallel to the original line, but now passes through the arithmetic values of the means, and through the mean  $Q_s$  - mean Q intercept. This produces a weighted estimate of  $Q_s$  for given Q and tends to reduce the large errors otherwise found.**

**Sample sediment concentration may be plotted in a similar way, with concentration x discharge giving the data points for Figure 8.14. It should be remembered that sediment estimates based on such relations are subject to errors in the relation and the uncertainty as to whether the relation can be applied to other periods of measurement.**



**Figure 8.14: Sediment Discharge against River Flow**

## Extrapolation

The extrapolation of such relations is difficult, because the value of the coefficient,  $b$ , falls with higher discharge levels and the relation is in reality non-linear on log-log plotting. Studies have shown that the sediment carrying capacity of discharge decreases with increased discharge after the concentration has reached  $100 \text{ kg m}^{-3}$ . The physical basis of this observation is not clear. Methods of extrapolation are available according to absolute rates of sedimentation, but these may be extremely

**involved, using combinations of water level and grain size groups, a range of water level/discharge relations, a topographic survey of a test reach of the river, water temperature etc.**

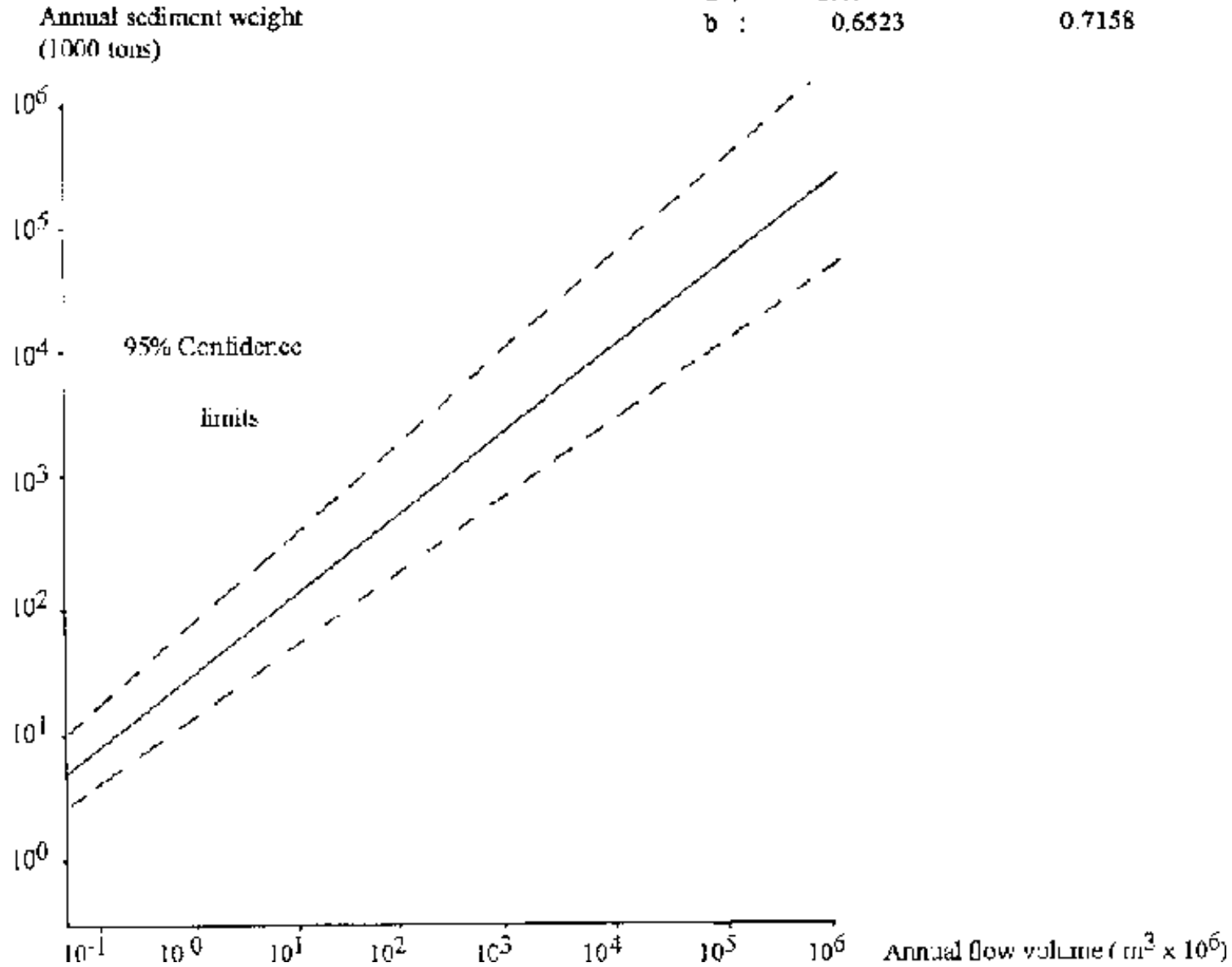
**The FAO paper 37, "Arid Zone Hydrology" gives full details of the procedure (the Einstein method) which is not relevant to the scope of this handbook. It is however, the only method recommended by the FAO for the theoretical determination of sediment load and the augmentation of empirical information. In the same chapter, this paper also outlines other methods that can be used to estimate the silting of dams by sedimentary deposition.**

**First approximations of total sedimentation according to volume of discharge have been developed as regression for semi arid and arid regions, and while these cannot be used for design purposes, they have proven useful in generalising the order of sediment load, see Figure 8.15.**

**The development of regression relations is likely, as for other such relations, to be limited by geographical locality, soils, hydrological and climatic regimes etc., and the translocation of formulae from one area or even stream to another is likely to be unsuitable for any purpose other than approximate estimation.**

**In Figure 8.15, the form of the regression is  $V_s = aV^b$ , the coefficient values are:**

	short grass/scrub,	scrub and desert
a :	19.0	58.0
b :	0.6523	0.7158



**Figure 8.15: Sediment from Short Grassland and Scrub**

## Appendix E: Data analysis

## Appendix E1: Critical values of the chi-square distribution

v	$\alpha$									
	.995	.99	.98	.975	.95	.90	.80	.75	.70	.50
1	.00435	.02157	.04623	.07982	.10393	.1518	.2642	.302	.348	.45
2	.0100	.0201	.0404	.0506	.103	.211	.446	.575	.713	1.38
3	.0717	.115	.185	.216	.352	.584	1.005	1.213	1.424	2.36
4	.207	.297	.429	.484	.711	1.064	1.649	1.923	2.195	3.35
5	.412	.554	.752	.831	1.145	1.610	2.343	2.675	3.000	4.35
6	.676	.872	1.134	1.237	1.635	2.204	3.070	3.455	3.828	5.34
7	.989	1.239	1.564	1.690	2.167	2.833	3.822	4.255	4.671	6.34
8	1.344	1.646	2.032	2.180	2.733	3.490	4.594	5.071	5.527	7.34
9	1.735	2.088	2.512	2.700	3.325	4.168	5.350	5.899	6.393	8.34
10	2.156	2.558	3.059	3.247	3.940	4.862	6.179	6.737	7.267	9.34
11	2.603	3.053	3.609	3.815	4.575	5.578	6.989	7.584	8.148	10.34
12	3.074	3.571	4.178	4.404	5.226	6.304	7.807	8.438	9.034	11.34
13	3.565	4.107	4.765	5.009	5.893	7.042	8.634	9.299	9.926	12.34
14	4.075	4.660	5.368	5.629	6.571	7.790	9.467	10.165	10.821	13.34
15	4.601	5.229	5.985	6.262	7.261	8.547	10.307	11.036	11.721	14.34
16	5.142	5.812	6.614	6.908	7.962	9.312	11.152	11.912	12.624	15.34
17	5.697	6.408	7.255	7.564	8.672	10.085	12.002	12.792	13.531	16.34
18	6.265	7.015	7.906	8.231	9.390	10.865	12.857	13.675	14.440	17.34
19	6.844	7.633	8.567	8.907	10.117	11.651	13.716	14.562	15.352	18.34
20	7.434	8.260	9.237	9.591	10.851	12.445	14.578	15.452	16.266	19.34
21	8.034	8.897	9.915	10.283	11.591	13.240	15.445	16.344	17.182	20.34
22	8.643	9.542	10.600	10.982	12.338	14.041	16.314	17.240	18.101	21.34
23	9.260	10.196	11.293	11.688	13.091	14.848	17.187	18.137	19.021	22.34
24	9.886	10.856	11.992	12.401	13.848	15.659	18.062	19.037	19.943	23.34
25	10.520	11.524	12.697	13.120	14.611	16.473	18.940	19.939	20.867	24.34
26	11.160	12.198	13.409	13.844	15.379	17.292	19.820	20.843	21.792	25.34
27	11.808	12.879	14.125	14.573	16.151	18.114	20.703	21.749	22.719	26.34
28	12.461	13.565	14.847	15.308	16.928	18.939	21.588	22.657	23.647	27.34
29	13.121	14.256	15.574	16.047	17.708	19.768	22.475	23.567	24.577	28.34
30	13.787	14.953	16.306	16.791	18.493	20.599	23.364	24.478	25.508	29.34

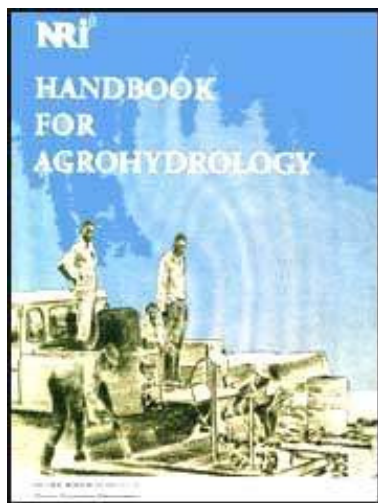
Figure



	.30	.25	.20	.10	.05	.025	.02	.01	.005	.001
1	1.074	1.323	1.642	2.706	3.841	5.024	5.412	6.613	7.879	10.827
2	2.408	2.773	3.219	4.605	5.991	7.375	7.824	9.210	10.597	13.815
3	3.665	4.088	4.642	6.251	7.815	9.245	9.837	11.245	12.838	16.268
4	4.878	5.385	5.989	7.779	9.488	11.142	11.668	13.277	14.860	18.465
5	6.064	6.625	7.289	9.236	11.070	12.822	13.388	15.086	16.750	20.517
6	7.231	7.841	8.558	10.645	12.592	14.449	15.033	16.812	18.548	22.457
7	8.383	9.037	9.803	12.017	14.067	16.012	16.622	18.475	20.278	24.322
8	9.524	10.219	11.030	13.352	15.507	17.522	18.168	20.090	21.953	26.125
9	10.656	11.389	12.242	14.654	16.919	19.022	19.679	21.666	23.589	27.877
10	11.781	12.549	13.442	15.927	18.207	20.482	21.161	23.209	25.188	29.588
11	12.899	13.701	14.631	17.275	19.675	21.920	22.613	24.725	26.757	31.264
12	14.011	14.845	15.812	18.549	21.026	23.277	24.054	26.217	28.300	32.909
13	15.119	15.984	16.985	19.812	22.262	24.726	25.472	27.688	29.819	34.528
14	16.222	17.117	18.151	21.054	23.685	26.119	26.872	29.141	31.319	36.123
15	17.322	18.245	19.311	22.207	24.996	27.488	28.239	30.578	32.801	37.697
16	18.418	19.369	20.463	23.342	26.296	28.845	29.633	32.000	34.267	39.252
17	19.511	20.489	21.615	24.769	27.587	30.191	30.995	33.409	35.718	40.790
18	20.601	21.605	22.760	25.989	28.869	31.526	32.346	34.805	37.156	42.312
19	21.689	22.718	23.900	27.204	30.144	32.822	33.687	36.191	38.582	43.820
20	22.775	23.828	25.028	28.412	31.410	34.170	35.020	37.566	39.997	45.315
21	23.858	24.935	26.171	29.615	32.671	35.479	36.343	38.932	41.401	46.797
22	24.939	26.039	27.201	30.813	33.914	36.781	37.659	40.289	42.796	48.268
23	26.018	27.141	28.429	32.007	35.172	38.076	38.968	41.638	44.181	49.728
24	27.096	28.241	29.553	33.196	36.415	39.364	40.270	42.980	45.558	51.179
25	28.172	29.339	30.673	34.382	37.632	40.646	41.566	44.314	46.928	52.620
26	29.246	30.434	31.793	35.563	38.885	41.923	42.856	45.642	48.290	54.052
27	30.319	31.528	32.912	36.741	40.113	43.194	44.140	46.963	49.643	55.476
28	31.291	32.620	34.027	37.916	41.337	44.461	45.419	48.278	50.993	56.893
29	32.461	33.711	35.139	39.087	42.557	45.722	46.693	49.588	52.336	58.302
30	33.530	34.800	36.250	40.256	43.773	46.979	47.962	50.892	53.672	59.703

Figure





## Handbook for Agrohydrology (NRI)

 *(introduction...)*

  **Acknowledgments**

 **Summary**

**Chapter 1: Introduction**

**Chapter 2: Measurement of runoff**

**Chapter 3: Erosion and sedimentation data**

**Chapter 4: Rainfall and other meteorological data**

**Chapter 5: Soils and soil moisture data**

**Chapter 6: Catchment characteristics**

**Chapter 7: Water harvesting and field structures**

**Chapter 8: Data analysis**

## **Acknowledgments**

**The role of the Overseas Development Administration (UK), in funding the production of this Handbook through the Natural Resources Institute is gratefully acknowledged. Particular thanks are owed to David Jackson of the NRI Land and Water Development Section's Agronomy and Cropping Systems Research Programme and Stephen Walker of NRI. The ODA-NRI / SADCC Land and Water Management Development Project based in Botswana (1987-92), provided much of the field data and practical experience on water harvesting research that are presented herein. ELK International Ltd gave permission for the reproduction of**

**figures 2.42 4.1, 4.11 and 4.13. The United States Department of Agriculture gave permission for reproduction of its material.**

**© Crown copyright  
1994**

**The Natural Resources Institute (NRI) is an internationally recognized centre of expertise on the natural resources sector in developing countries. It forms an integral part of the British Government's overseas aid programme. Its principal aim is to alleviate poverty and hardship in developing countries by increasing the productivity of their renewable natural resources. NRI's main fields of expertise are resource assessment and farming systems, integrated pest management, food sciences and crop utilization.**

**NRI carries out research and surveys; develops pilot-scale plant, machinery and processes; identifies, prepares, manages and executes projects; provides advice and training; and publishes scientific and development material.**

**Short extracts of material from this publication may be reproduced in any non-advertising, non-profit-making context provided that the source is acknowledged as follows:**

**Miller, J. (1994) Handbool for Agrohydrology. Chatham, UK: Natural Resources Institute.**

**Permission for commercial reproduction should, however, be sought from the Head, Publishing and Publicity Services, Natural Resources Institute, Central Avenue, Chatham Maritime, Kent ME4 4TB, United Kingdom.**

**Printed by Hobbs the Printers of Southampton**

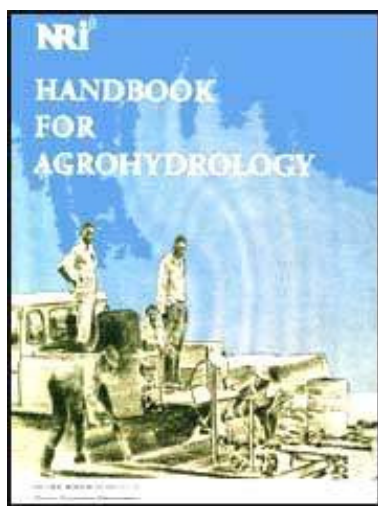
**Price £30.00**

**No charge is made for single copies of this publication sent to governmental and educational establishments, research institutions and non-profit-making organizations working in countries eligible for British Government aid. Free copies cannot normally be addressed to individuals by name, but only under their official titles. When ordering please quote WR3.**

**Natural Resources Institute  
ISBN: 0-85954-389-7**



[Home](#) > [ar](#).[cn](#).[de](#).[en](#).[es](#).[fr](#).[id](#).[it](#).[ph](#).[po](#).[ru](#).[sw](#)



 **Handbook for Agrohydrology (NRI)**

 **(introduction...)**

 **Acknowledgments**

  **Summary**

**Chapter 1: Introduction**

**Chapter 2: Measurement of runoff**

**Chapter 3: Erosion and sedimentation data**

**Chapter 4: Rainfall and other meteorological data**

**Chapter 5: Soils and soil moisture data**



- Chapter 6: Catchment characteristics**
- Chapter 7: Water harvesting and field structures**
- Chapter 8: Data analysis**

## Summary

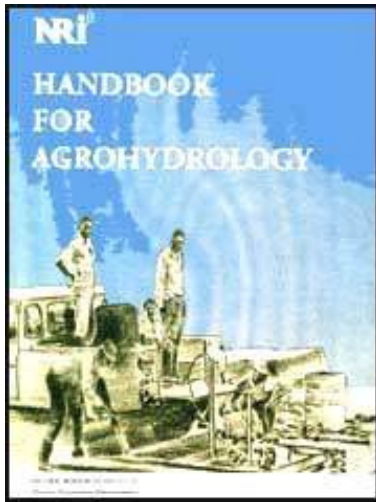
**This handbook provides detailed information on the practical aspects of hydrological research in agriculture. It has been written not only for hydrologists, but also field scientists for whom hydrology lies outside their particular specialisation.**

**Theoretical methods for the estimation of flow peaks and volumes are evaluated. Techniques for the measurement of runoff and its associated meteorological variables are presented with details on equipment and circumstances of suitability, selection, manufacture and operation. Soil erosion and sedimentary processes are discussed in terms of both field data collection and the use of empirical formulae. Alternative field and laboratory methods of measuring soil moisture are described.**

**Water harvesting techniques are discussed in the context of increasing catchment size, peak flows and runoff volumes, and the field data from research trials are given for each main category of water harvesting technique. The planning, design and construction of the field structures that are essential in water harvesting research and practice: bunds, ridges and waterways, are also discussed.**

**Methods of the analysis of hydro-meteorological data are described, illustrating both statistical and non-statistical techniques.**





## Handbook for Agrohydrology (NRI)

### Chapter 1: Introduction

 **1.1 The role of hydrology in agriculture**

 **1.2 Summary**

 **1.3 Project planning and practical problems**

## **Handbook for Agrohydrology (NRI)**

### **Chapter 1: Introduction**

#### **1.1 The role of hydrology in agriculture**

**Agrohydrology can be regarded as the study of hydrological processes and the collection of hydrological data, aimed at increasing the efficiency of crop production, largely by providing beneficial soil moisture conditions. However, the influences on the production of runoff and the ways that runoff affects the environment within which crops grow are very diverse and agrohydrological study, of necessity, also includes the collection of information on climate, soils, vegetation and topography. Rainfall amount and its spatial and temporal distributions determine the quantity of water that reaches the land's surface. Temperature and humidity, the type, amount and distribution of vegetation cover determine what proportion of this water re-**

**evaporates. Vegetation, soil conditions and topography determine how much water infiltrates into the soil, how much runs off the land's surface and where it goes. It is the interaction of these complex processes and the volumes of runoff that these processes produce that form the core research of agrohydrology.**

**Hydrological practice has been developed to its greatest extent and sophistication in the provision of water resources from large catchments, usually for industrial and domestic consumption. Historically, hydrological practice has had a limited role to play in agriculture even where large-scale irrigation schemes have been undertaken, because civil or agricultural engineering expertise has usually taken a dominant place in such circumstances. But with the increasing interest in improving poorly developed and more marginal regions of agricultural activity, where large capital investment is uneconomic, a thorough understanding of the hydrological conditions that prevail has become essential. This understanding is particularly important where agriculture is a subsistence activity, or where water harvesting is proposed to improve agricultural production. Knowledge of the hydrological environment is necessary to determine whether or not opportunities to create optimal soil moisture conditions exist, and how these opportunities can be exploited.**

**Also, the understanding of the hydrological environment links together with other important environmental issues: the removal of natural vegetation, soil erosion, flooding, drought. The influence of hydrological conditions on farming practice and farming systems is substantial, and in the case of water harvesting, the availability, timing and volume of surface runoff will be critical to success or failure.**

**The actual techniques and methods that are used to collect information for agrohydrological study are, in general, very similar to those used in more orthodox hydrological field practice and the transfer of technology is not a problem, but there**

**are some differences. These differences may be summarised as follows:**

- the catchments from which runoff is measured are usually smaller.**
- runoff peaks and volumes are also usually small. This often necessitates the modification of otherwise standard equipment.**
- often, studies concentrate upon the particular conditions under which runoff is produced and particular conditions may even be imposed upon a catchment. The use of "natural" catchments is not common.**
- it is often necessary to study many replicates of catchment types.**
- particular conditions of climate (especially rainfall) and catchment may have only a very localised extent.**
- a close connection with farming practice will be desired.**
- historical hydrological (and sometimes other) data will be limited.**
- methods of analysis of data are identical, but the shortness of records often imposes severe constraints.**

**The aim of this guide is to show which hydrological factors are important and how they can be measured, so that any opportunity for improving the water supply to crops can be taken. The core interest of the guide is runoff, the surface flow of water and the rainfall and catchment conditions that cause it.**

## **1.2 Summary**



**This book is directed at agricultural projects whose staff do not have the specialised skills of the hydrologist and at hydrologists whose experience in the agricultural field is limited. It is aimed especially at those working in developing countries, where resources will be limited and where it is essential to put the right equipment in the right place, in the right way. Projects usually have a very short life-span compared to the time it takes to collect a comprehensive set of data and a season that does not yield information that can improve the quality of future decisions is, effectively, a season lost.**

### **The Contents of this Handbook**

**A deliberate attempt has been made to bridge the gap that is so commonly found between textbooks and guides to field practice. It is often the case that textbooks discuss in detail the theory of hydrology, but give little or no explanation of how this theory is applied to hydrological work. The material may make sense in isolation, but it often cannot be translated into real field activity. For obvious reasons the authors of texts do not select limited data of dubious quality for illustrative examples, but this is exactly the kind of data that are found frequently when work is undertaken at the project level. Similarly, practical guides often leave the reader with no accurate background to the theoretical basis upon which their research is founded. When research moves away from its theoretical basis, to accommodate the realities of everyday life, it is important to know exactly where it stands and whether or not the links with sound theory have been stretched too far.**

**There are three main components to this handbook. These are chapters 2, 7 and 8 which cover Runoff and its measurement, Water Harvesting and Field Structures, and Data Analysis, respectively. The other chapters are important, but these three cover the fundamental aspects of agrohydrology. Equipment used for the collection**

**of data is essential to the successful acquisition of agrohydrological knowledge. Its manufacture, installation and maintenance are covered in depth. A breakdown of the main topics of each chapter is given below.**

## **Breakdown of Chapters 2 - 8**

### **Chapter 2: Measurement of Runoff**

- **theoretical estimates to help in the selection of appropriate equipment**
- **hydrometrics/ runoff controls, both natural and artificial**
- **measurement of hydrological variables**
- **equipment descriptions**
- **equipment manufacture? installation and maintenance**

### **Chapter 3: Sedimentation Data Collection**

- **soil erosion and methods of estimation**
- **total sediment and suspended sediment measurement**
- **equipment**
- **laboratory analysis of water and soil samples**

### **Chapter 4: Rainfall and Meteorological Data Collection**

- **equipment descriptions for all major meteorological variables**
- **installation and maintenance**
- **siting and operation**
- **raingauge networks**

### **Chapter 5: Soils and Soil Moisture**

- **soil classification**
- **soil textures**

- **methods of determining soil moisture**
- **infiltration**
- **equipment**

### **Chapter 6: Catchment Characteristics**

- **natural vegetation**
- **catchment size, land slope, topography**
- **field orientation**
- **geology and other influences**

### **Chapter 7: Water Harvesting and Structures**

- **types of on and off field systems**
- **results from research examples of these systems**
- **design criteria. channels and waterways**
- **practical aspects of laying out fields/ agricultural engineering**

### **Chapter 8: Analysis of Data**

- **runoff data, non-statistical analysis**
- **statistical analysis, theoretical distributions of data**
- **rainfall and other meteorological data**
- **rainfall intensity**
- **rainfall/runoff relations**
- **evaporation and evapotranspiration**

### **Bibliography**

**The list of books and papers given below has been limited to those which bear directly on the text of this handbook and most of them should not be difficult to**

**obtain. The range of reference material on hydrology and agrohydrology is extremely comprehensive but it is recognised that some field workers may find difficulty in obtaining such material. Some of the references below are orthodox textbooks that deal largely with theory, while others are field manuals or research papers that report experience at first hand. It is hoped that this mixture of theory and practice will provide a good basis from which research can be undertaken? while at the same time allowing researchers to follow their own preference toward particular reference material.**

**A generalised computer program for the solution of the Penman equation for evapotranspiration. Chidley, T R E and Pike, J G, 1970.  
Journal of Hydrology 10 (1970): 75-89**

**A rapid method of computing areal rainfall. Chidley, T R E and Keys, K M, 1970.  
Journal of Hydrology 12 (1970): 15-24**

**Agrometeorological crop monitoring and forecasting' FAO Plant Production and Protection paper 17, 1979  
FAO, Rome**

**Applications of remote sensing to hydrology, S T Miller, 1986  
PhD Thesis, University of Aston, Birmingham, UK**

**Annual floods and the partial duration series. Langbein W, 1949  
Transactions of the American Geophysical Union, 30: 878-881**

**Arid zone hydrology. FAO Irrigation and Drainage Paper 37, 1981  
FAO Rome**

**Climate of Botswana, part II Elements of climate. Bhalotra, Y P R, 1984  
Department of Meteorological Services, Gaborone, Botswana**

**Effect of slope and plant cover on runoff, soil loss and water use efficiency of natural veldt. Snyman, H A and Van Rensburg, H A, 1986. Journal Grassland Society of South Africa 3,4: 153-158**

**Field manual for research in agricultural hydrology, 1979  
USDA Agriculture Handbook 224. Washington DC, USA**

**FAO Soils Bulletin no. 1(), Physical and chemical methods of soil and water analysis  
1970.  
FAO Rome**

**Flood studies report, 1975 Natural Environment Research Council, UK**

**Field directors handbook, Oxfam 1985  
Oxford University Press, Oxford. UK**

**Handbook of applied hydrology, 1964. Ven Te Chow (Editor in chief) McGraw-Hill,  
New York**

**Hydraulics of runoff from developed surfaces. Izzard, C F, 1946 Proceedings of the  
High Resolution Board, 26: 129-150**

**Hydrology for engineers, 1985. R K Linsley, M A Kohler and J L H Paulhus McGraw-  
Hill, New York**

**Hydrology for soil and water conservation in the coastal regions of North Africa**

**United States Department of Agriculture Soil Conservation Service, 1974.  
Washington DC, USA**

**Instructions and tables for computing potential evapotranspiration and the water balance. Thornthwaite, C W and Mather, J R, 1957. Drexel Institute of Technology, Publications in Climatology Vol X, No 3.**

**Irrigation principles and practices, 1962. O W Israelson and V E Hansen John Wiley and Sons, New York**

**Land husbandry manual, 1977 Ministry of Agriculture & Natural Resources, Lilongwe, Malawi**

**Land and water management project ODA/SACCAR. Annual Reports, 1989 - 1992  
Natural Resources Institute, Chatham, UK**

**Land and water management project. Hydrology final report, Miller S T, 1994  
Natural Resources Institute, Chatham, UK**

**Measurement and prediction of actual evaporation from sparse dryland crops,  
Wallace, J S, Gash, J H C, McNeil, D D, Sivakumar, M V K. 1986. Report on project  
149. Institute of Hydrology, Wallingford, Oxfordshire, UK**

**Meteorological observers handbook 805, 1969  
HMSO, UK**

**Microtopography and agriculture in semi-arid Botswana 1. Soil variability, Miller S T,  
Brinn, P J, Fry G J and Harris D, 1994. Agricultural Water Management (in press)**

**Prediction of variation in grassland growth in semi-arid induced grassland. Dye, P J, 1983. PhD Thesis, University of Witwatersrand, Republic of South Africa**

**Predicting rainfall erosion Losses, 1978  
United States Department of Agriculture report 537**

**Principles of hydrology, Ward, R C. McGraw-Hill Ltd, 1975  
London, UK**

**Probability and statistics in hydrology, V Yevjevich  
Water Resources Publication, 1972  
Fort Collins Colorado**

**Probability and statistics for engineers and scientists. Walpole, R E and Myers, R D  
Collier Macmillan, 1985, New York, USA**

**Rainfall-induced runoff computed for fallow fields, Hauser, V L, Hiler, E A, 1974. Soil  
and Water Division Paper 73:2520, ASAE.**

**Remote sensing and image interpretation, 1979. TM Lillesand and R W Kiefer Wiley  
and Sons, New York**

**Soil conservation, Elwell, H A  
College Press, 1986. Harare, Zimbabwe**

**Soil water balance in the Sudano-Sahelian Zone. IAHS Publications, 1991 Institute  
Of Hydrology, Wallingford, Oxfordshire UK**

**Soil and Water Conservation Engineering. G O Schwarb, R K Frevert, T W Edminster,**

**K K Barnes Wiley and Sons 1981, New York**

**Stochastic considerations in optimal design of a microcatchment layout of runoff water harvesting, Oron. G and Enthoven, G. 1987. Water Resources Research 23:7:1131-1138**

**The quantification of runoff and factors influencing its production, Miller, S T and Veenendaal, E M, 1990. Proceedings of the Land and Water Management Research Programme Scientific Workshop, Gaborone, Botswana**

**Three years experience with an on-farm macro-catchment water harvesting system in Botswana Carter. D C and Miller ST 1991. Agricultural Water Management 19 (1991) 191 -203**

**Time domain reflectometry in soil science: theory, operation and use. Robinson, D, 1993. Institute of Hydrology, Wallingford, Oxfordshire, UK**

**User's handbook for the Institute of Hydrology's neutron probe system, 1981. Institute of Hydrology, Wallingford, Oxfordshire, UK**

**Vegetation management guidelines for increasing yields in a semi-arid region: an Arizona case study, Fogel M M, Report of the School of Renewable Natural Resources, University of Arizona, Tucson, USA**

**Water harvesting for plant production. Reij, C, Mulder, P, Begmann, L, 1988. World Bank Technical Paper 91. Washington DC, USA**

**Equipment Cost Lists**



**At the end of each chapter, there is a list of basic equipment and 1993 prices in US \$. The cost of scientific equipment is often surprisingly high and although these prices may soon be out of date they provide a useful basis for early planning until current prices can be obtained, a process which can take weeks or even months. Below are the names and addresses of a number of UK manufacturers and suppliers of scientific equipment. This should be of use when researching equipment prices and availability.**

**Note that inclusion in this list does not confer an' recommendation by NRI**

<b>Company</b>	<b>Address</b>	<b>Equipment</b>
Casella London Ltd	Regent House, Wolsley Road, Kempston, Bedford MK42 7JY England. (Fax: 0234 841490)	Meteorology
ELK International Ltd	Eastman Way, Hemel Hampstead Herts. HP2 7HB, UK. (Fax: UK + 0442 252474)	Hydrology Soils Agronomy Laboratory
	Mon Plaisir 25, Postbus 373 4879 AK Etten-Leur, Nederland. (Fax: 01608 33181)	Meteorology
	Schonbergstrasse 47? D-7302 Ostfildern 4, Deutschland (Fax: 0711 457 09 51)	

Small Sons & Co Ltd	Unit 1, St. Andrews road, Glasgow G41 IPP. U (Telex: 041 429 4429)	Hydrology Groundwater
Vector Instruments	115 Marsh road, Rhyl, Clwyd LL18 2AB. UK. (Fax: UK + 0745 344206)	Wind monitoring
Delta T Devices Ltd	128 Low road, Burwell, Cambridge CB5 OEJ. UK (Fax: UK + 638 743155)	Agronomy Meteorology Loggers & Software
Valeport Ltd	Unit 7, Townstal Industrial Estate, Dartmouth, Devon TQ6 9LX. UK (Fax: UK + 0803 834320)	Hydrology
Soil Instruments Ltd	Bell lane, Uckfield, East Sussex, TN22 1QL. UK (Fax: UK + 0825 761740)	Soils and Geotechnical
Didcot Instrument Co Ltd	Unit 14, Thames view Industrial Park, Abingdon, Oxon, OX 3UJ. UK (Fax: UK + 0235 522345)	Meteorology Soils & Neutron Probe

## Appendices to Chapters

**For ease of reference and where appendices are appropriate, the material is placed at the end of each relevant chapter and the sequential page numbering of the chapter is continued. The page numbers of the appendices are listed in the Contents section.**

## **Computer Models**

**A very short list of "off the shelf" models and database systems, that can be used for catchment and agricultural flow simulations is given below. There are great difficulties in providing such a list: very many research institutes, university departments and private companies have developed or are developing models based on some or all of the physical processes involved in rainfall/ surface flow/ soil moisture/ crop/ natural vegetation/ groundwater recharge, etc., to determine various water balances. Some of these models will be relevant only to specific research purposes, while others will be intended for general release, to be used in many different circumstances. To keep track of all of these developments is an impossible task. It is recommended therefore, that enquiries for details of models for field projects should be directed to the funding organisations of such projects. These organisations will be in a good position to contact research organisations and national institutes for details and may indeed be funding the development of water balance models themselves. Local organisations (Water Authorities, Ministries of Agriculture, etc.) may also be able to provide useful information on any models that have been developed or modified for use under local conditions. The following models and databases are presented because they are (mostly) in widespread use, and they have been used and tested for some years. The programs are not suitable for use with small runoff plot data, but are designed to be used with a p.c. Enquiries need only be directed to one organisation, the Institute of Hydrology, Wallingford,**

## **OX10 8BB, UK.**

**"HYDATA" is a hydrological database and integrated analysis system, best suited for catchment purposes. Currently it is used in 15 overseas countries. It stores station data (location, name etc.), stage and rating equation data, flows, rainfall and meteorological information. It has been developed to be compatible with the WHO's meteorological database, CLICOM via a transfer utility "HYCOM". Analysis gives comparison plots (eg double mass curves) or time series (eg hydrographs), flow duration and low flow information. Current price £5,000.**

**"HYFAP" is a frequency analysis and modelling package developed for use with extreme event information (eg annual maximum flows) for the prediction of magnitudes and return periods. Various distributions and fitting methods (see chapter 8) are available. Data can be transferred directly from HYDATA using an optional utility package "HYDOUT". Current price £495.**

**"HYRRROM" is a relatively simple conceptual, deterministic rainfall/runoff model. Rainfall is routed through an interception and soil store, with evaporation and transpiration deducted. Runoff is given after losses to groundwater are accounted for, though groundwater contributions are added after a time delay. The model can be manually calibrated. It is compatible with HYDATA. Current price £825.**

**"Micro-LOW FLOWS" is a modelling program that incorporates the findings of the Natural Environment Research Council's Low Flow Study. Catchment characteristics are used to provide mean, 95 percentile and mean annual minimum flows; low flow frequency and flow duration curves. Current price £1100.**

**"Micro-FSR" is a software package for estimating design flood flows and probable**

**maximum precipitation, using statistical modelling techniques (see chapter 8).  
Current price £995.**

**"SWIPS" is a soil moisture quality control, processing database for data from neutron probes, capacitance probes and tensiometers, and is run under Windows 3.1 operating software. Current price not available.**

**\* For updates of packages and prices contact IOH. Bona fide research organisations/projects can purchase at large discounts.**

### **1.3 Project planning and practical problems**

**This handbook assumes that work is being undertaken in developing countries and usually, though perhaps not always, will be implemented through a project with a finite lifetime. It is important to consider briefly, the manner in which projects are formulated and evaluated. Project staff should be aware of how and why projects have been devised and funded, and understand the work that has gone into developing the project proposals. Their own experience may be invaluable for future proposals for project development.**

**Projects have a finite life, but should seek to attain their goals and leave behind continuing benefits that come from the successful integration of new developments; technical, economic and perhaps social. Technical staff have important contributions to make in these areas, to both current activity and future planning, but it would be naive to believe that technical improvement and social benefits are the only aims of funding agencies. Policy and administrative considerations are often paramount and it is essential that technical assessments should be thorough and realistic.**

## **Proposals and Planning for Projects**

**Project proposals are the first tangible evidence of possible future activity. They collect together ideas generated by the previous work and experience of individuals and organisations and will pass through many different stages of development before final acceptance or rejection. Because of this, project proposals may develop over a long period of time and it is important that their relevance is continually assessed. It is also advantageous, and in the case of most projects essential, that in addition to technical and logistical enquiry, the specialist skills of sociologists and economists be applied at the earliest stage of any proposals, to define the possible consequences of implementation. It is also important to remember that each funding agency will have its own individual character and particular spheres of interest and experience.**

**A list of basic conditions that project proposals should fulfil is given below. These address the structural and material content of proposals and do not consider any of the important social issues that can undermine the success of any technically feasible project. Project proposals should take into account:**

### **Clearly defined aims and objectives**

**These should explain precisely the long and short term goals that the project seeks. They should be agreed upon and documented prior to any implementation. In some cases they may be limited to the stages of technical implementation and their results, in other cases it may be necessary to include the socio-economic effects that are expected and the development of the activities of the project, in the light of these effects.**

## **Institutional framework**

**This will identify the interested parties and clarify the position that the project occupies between them. The responsibilities of the organisations involved and the financial, staffing and logistical support that a project receives, should be explained in detail.**

### **Lines of communication between Project, Donor, Recipient Organisation and Participants**

**These are often complex, but vital to the success of a project. Misunderstandings may lead to a lack of amicable cooperation. They provide essential conduits for reporting, review procedures and information, and keep everyone involved aware of the progress of work and need for revision.**

### **Reporting Procedures**

**Strong lines of communication are useless without defined reporting procedures. If these are well established within project proposals, it is not easy to neglect them, even when a project is running and day to day tasks have a more immediate attraction.**

### **Evaluations and Reviews, both internal and external**

**Project proposals (and activities) are not immutable and a flexible approach is essential. Conditions change continually and it is not possible to design, implement and complete a project without considering improvement as experience is gained. Review procedures are important to ensure that sensible assessments of progress**

**are made and to initiate discussions on alternative courses that may be followed. Both internal and external reviews should be timetabled, with at least one major review allocated to a project at the most suitable stage of development. The difficulty here is to balance the timing; it should be neither too late to be of use, nor be too premature to review sufficient material. Short term reviews, perhaps annual internal reviews, can be made available and help in selecting appropriate timing, but much will depend on the nature of the project and its duration. The nature of the review bodies should be stated, as should to whom they will report and their constituent members.**

## **Funding**

**Funding may sometimes be contentious, sometimes easily agreed upon. In terms of project success, it is often the distribution of funding that causes problems rather than (within reason) the amount. It is usually most convenient for funding agencies to disburse an evenly spread level of funding. This allows consistent administrative procedures and easier future budget planning, but it is rarely appropriate for the efficient running of projects. Project capital investment expenditure is relatively high at first, gradually decreasing over the project life. Conversely, funds for employing local staff, equipment repair, vehicle maintenance and fieldwork will become greater as the project grows. Funds for training tend to peak during the mid and final term when staff have sufficient experience to require enhanced expertise and suitable courses have been identified. Problems can arise not only from the varied levels of funding needed in each case, but also because each may be obtained from different areas of fiscal responsibility within the funding organisation. It is clearly to everyone's advantage to assess realistic levels of funding in detail, relate them to the stages of the project's life and identify remedial procedures, should**



**these be necessary. The responsibilities of all organisations concerned with supporting the project, should be clearly stated.**

## **Long-term Obligations**

**The project proposals should place the role of the project clearly within the framework of past activity and where long term obligations are planned, agreements on these should not be postponed nor over looked. The manner in which the results of the project fit into the social and institutional framework of the host country and whether or not they can be maintained, should be assessed. Projects usually become self funding over a timetabled period, but it is easy to overestimate local sources of support where attention is distracted from problems of future funding by the overall appeal of the project.**

## **Format**

**Project proposals should be clear and concise, but comprehensive. Different funding agencies use different formats of presentation and it is sensible to adopt these formats as early as possible. The process of preparation is sufficiently time consuming without additional unnecessary delays, especially where projects have a defined season of implementation.**

## **Basic Questions**

**There are several basic questions that have to be asked when a project proposal is being developed. The list below is not necessarily exhaustive.**

**a. What are the genuine needs to be served ?**

- b. Can they and have they been identified ?**
- c. What objectives can the project actually achieve ?**
- d. Are the technologies appropriate and economically feasible?**
- e. What constraints, technical, social and economic are to be overcome ?**
- f. What are the long term implications ?**

**When these questions are answered it is important to present the basis of each answer and provide a summary of the research material. For example the answer to questions 'a' and 'b' may be based on extensive questionnaires; government economic or agricultural statistics; discussions with research organisations or workers already in the field. Questions 'c', 'd' and 'e' demand recourse to previous experience from other projects, noting advances made and failures due to identifiable causes. Sensible answers to question 'f' show that the long term development of a project has been well thought through. They indicate a familiarity with the host country and recipients and an understanding of what can and cannot reasonably be expected. Negative answers do not necessarily prove that a project is totally unsuitable, the long term implications may be simply too optimistic. Modification of the proposals may overcome any long term difficulties that come to light.**

## **Background Information**

**The type of information needed will obviously be determined by the kind of project that is proposed. Consideration should be given the following:**

- a. National, regional and socio-economic information.**

**In general, bi-partite projects will have fewer problems in obtaining this**

**information than ones involving various groups. However, such information is not always easy to get; it may even not be available, it may be seriously outdated and governments are sometimes reluctant to give it. Previous reviews and surveys provide a good indication of the width and availability of researchable material.**

**b. Previous, current and future projects.**

**These can often be a very valuable source of information, in addition to background research, technical data and research conclusions may be available. Learning from previous mistakes is an opportunity to be taken. Areas of cooperation can be explored, sometimes to the general benefit of all, but these areas should be clearly decided upon and defined.**

**c. Host government policies.**

**It is essential that projects be concordant to the policies of the host government. Any that are not are bound to fail and any long terms benefits will be lost. The opportunity to gain familiarity with organisations and individuals within government should be taken to the full.**

## **Reporting and Evaluation**

**Reporting on project achievements should be undertaken in a systematic manner. Agreed arrangements should be made, which specify the details of reporting methods:**

**- From whom / to whom**

- **How often and at what length**
- **Whether technical or financial or both**

### **Evaluations should include:**

- **Against what objectives any achievements should be assessed**
- **Details of the use of funds**
- **What dissemination of information has been undertaken**
- **Technical evaluations**

### **Project Support**

**Project support can take many forms and should come from both inside and outside government. It may be through the cooperation with complementary projects which saves costs and provides a wider range of inputs. It may take the form of organised seminars and discussions which give a wider audience to the aims and achievements of project work. It may include the dissemination of information through government departments. The involvement of local institutions and experts is beneficial to both project and participants. Where a considerable financial burden may fall on participants (for example travel fares and housing of conference delegates), it is important that the responsibility for these costs to be identified and budgeted for.**

### **Training**

**One of the greatest benefits a project can leave behind is well trained staff There are however several conditions to this statement that must be given serious thought:**

- The correct type of staff must selected and the level of suitable training must be clearly identified. This may be vocational or institutional. If the latter, the correct course must be sought and places obtained. A careful timetable is necessary.**
- Host government obligations. Funding may be the responsibility of the project or government, or both. It may not be to the advantage of host governments to pay for training for local project staff who later return expecting an enhanced position and better career prospects. The details of such matters should be settled well before training is arranged.**
- The training must be appropriate for re-deployment when the project is finished. Any training must be in the long term interests of the host government, especially where counterpart staff are concerned.**
- Project obligations. It should be ascertained that the project budget provides funding for training, as some may not.**
- International Centres. Some international centres will sponsor candidates for training, but early enquiries should be made, because such sponsorship is eagerly sought.**

## **Practical Problems**

**The collection of good quality field data is frequently very difficult and many problems will be peculiar to individual projects. However, the two most general but almost universal problems that must be faced by research and field staff are:**

- **Collecting adequate information during the limited lifetime of a project**
- **Balancing resources between the amount and quality of data that can be collected.**

**These are problems that face almost every project as a whole and a cooperative effort is needed from all staff to overcome them, but below is a discussion of common difficulties that will probably be encountered by individual field workers in the attempt to obtain good data.**

**Limited Project resources: Projects in developing countries often succumb to the temptation of over-stretching their resources. In areas where little data is available and there is much to collect, the relative merits of few sites with intensive data collection and many sites collecting fewer data, must be carefully weighed.**

**Difficult access to sites: This is especially true of wet seasons when bad roads often become impassable. In such situations sites cannot be visited, equipment repaired, conditions observed nor site staff consulted. Sites should be carefully selected so as not to impose an intolerable burden on the data-collection routine.**

**Restrictions on transport to cover sufficient sites: The availability of transport and the means by which it is kept in good repair often pose some of the most serious logistic/resource problems that projects face in developing countries. Roads are usually bad, vehicle maintenance standards low and shortages of spare parts common. There is an understandable temptation for vehicles to be put to non-project uses in countries with rudimentary public transport facilities. This situation is not helped by the status which is conferred upon drivers, where the private ownership of vehicles is a great luxury.**

**Hostile physical environment:** Equipment has a hard life. Rough and inexperienced handling, transportation in difficult conditions often leads to early breakdown. High humidity and large ranges of both seasonal and diurnal temperatures frequently take their toll. Given the difficulties of repair and replacement, equipment should be treated carefully and be well maintained. An adequate provision of spare parts should be made.

**Inappropriate equipment:** Very often equipment must be ordered from overseas. It is essential that the correct equipment be selected in the first instance. Replacement may be impossible or may take many months.

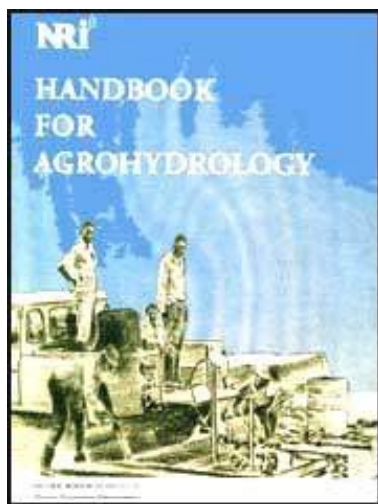
**Inexperienced staff:** It must be recognised that educational and training levels in developing countries are commonly lower than those in developed countries. This puts a great responsibility on professional project members to give as wide a range of relevant training as possible to technicians and field staff. Ideally, initial planning should place training as a core component of project activities, but this is by no means always so and in some instances research budgets actually preclude the use of project funds for training purposes. Initial project proposals should seriously consider the role of training in the future of any project. There is little more dispiriting to all concerned than a project which leaves no continuing activity behind at the end of its life.

**Under-motivated staff:** It may seem to project professionals working abroad, that local staff do not always give what they can toward the success of a project. When this is true, it is usually for very good reasons. Local staff almost always have very poor pay and conditions compared to expatriates. Often they are seconded from other areas of activity, sometimes on a temporary basis, with little hope of an enhanced career or improved personal prospects. They are often not trained nor

**aware of the opportunities that a project may offer. In developing countries, as in developed countries, technical personnel are undervalued in general; an administrative post in a ministry is far more likely to lead to promotion than supervising a field team. It is essential that local technical and field staff are shown that the success of any project lies very much in their hands. Without reliable, accurate information collected at the correct time, projects in the area of agrohydrology are little more than an exercise in redistributing a given amount of money.**

**These difficulties can never be totally overcome, but the careful selection, siting, installation and maintenance of equipment allied with good staff training can keep damage and disappointment to a minimum.**

[Home](#) > [ar.cn.de.en.es.fr.id.it.ph.po.ru.sw](#)



## Handbook for Agrohydrology (NRI)

### Chapter 2: Measurement of runoff

 *(introduction...)*

 **2.1 Estimates of runoff**

 **2.2 Collecting runoff data**

 **2.3 Water level recording instruments**

 **Equipment costs**

 **Appendix A: Measurement of runoff**



# **Handbook for Agrohydrology (NRI)**

## **Chapter 2: Measurement of runoff**

### **Background**

**"Runoff" is the term usually employed to distinguish the flow of water running off the land's surface during and shortly after rainfall, from the longer term flow of groundwater to rivers. This distinction is achieved by the analysis of flow data from perennial streams and rivers in humid climates, but in many agrohydrological and water harvesting situations, groundwater contributions are not present and all flow is runoff. This will almost certainly be the case in arid and semi-arid climates.**

**The collection of runoff data is very site and purpose-specific, both in terms of the kind of information that will be required and the manner in which it is best obtained. Runoff events are less frequent than rainfall events, in all climates. In areas of low rainfall, where agrohydrological and water harvesting projects are usually located, the number of runoff events may be fewer than ten per season. This compounds the unhelpful fact that problems with equipment and installations are not encountered until runoff occurs. If these problems are not rectified quickly, a large proportion of a season's data can be easily lost. Moreover, both equipment and experimental designs have to cope with a large range of runoff volumes and peak flows, so careful planning and a quick response to unexpected situations are very important in the success of collecting comprehensive, accurate information.**

**In planning runoff experiments it is important to have a clear idea of the object of research. For example:**

**1. In some regions, there may be no existing hydrological data. In this case it may be most suitable to spread project resources thinly and to collect information on as many different hydrological factors, at as many sites as possible. The replication of experiments will be limited and the development of hydrological models using these data will probably not be possible. A careful selection of off-station sites will be needed; adequate field staff and vehicles should be available and routine visiting schedules should be drawn. Site observers may be necessary and a greater proportion of automatic equipment will be needed. But a great number of varied circumstances will be documented and the data should be suitable for input into existing models. The information will be especially useful for projects that are following on and the research may provide insight into areas of hydrological behaviour not previously observed.**

**2. In other instances a much narrower focus may be desired. The development of hydrological models may be a priority and a large number of replicated experiments will be needed so that the data are amenable to statistical verification. It may be important to work cooperatively with existing projects, to extend the range of project activities and it may not be possible to undertake research in many environments.**

**Some projects will have a more practical applications bias and research may be combined with farmer participation and the implementation of farming systems. The overall objectives of any project will determine the financial commitment that is placed on the measurement of runoff, but it is assumed for the purpose of this guide that in the field of agricultural hydrology, runoff measurement is of primary importance.**

## **2.1 Estimates of runoff**

**Estimates of runoff are made for two reasons:**

- 1. They are essential guides in the decision of which system of runoff measurement to use, either volumetric or continuous. After this decision has been made, these estimates must be used to determine the size and capacity (peak flow and flow volume) of the equipment.**
- 2. If the measurement of runoff is not to be undertaken, then calculations must be made to estimate the design specifications of bunds, channels etc. that are to be used in the mechanics of water harvesting and field layouts.**

### **2.1.1 Estimates Based on Previous Data**

**A project may be fortunate in succeeding previous work that has already undertaken runoff measurement. These data can provide a good starting point for the selection of appropriate equipment. For example "Will a 100 litre collection tank be large enough to collect runoff from a 50 m<sup>2</sup> plot when previous data show that a 50 litre tank was large enough for a 20 m<sup>2</sup> plot?". The answer in this case would probably be "Yes", but caution must be exercised. Comparisons of catchment size, land use, slope and rainfall must be made to ensure that these data can be used for the purpose of installation design. Generally, if a project is succeeding another it is likely that most of the physical conditions under which the new project will operate will be similar and catchment size may be the primary concern in estimating flow peaks and volumes. Catchment size is by no means the main influence on runoff amount, however.**

**Consider Table 2.1 below, data from a strip tillage experiment undertaken in semi-arid SE Botswana. All physical conditions for the plots, including rainfall for each season, were identical. In both seasons the smallest plots produced most runoff (both seasonal and event by event) and the conclusion may be drawn that catchment size exerts an influence on runoff, though this influence appears to be relatively small and is unlikely to cause serious problems in estimating probable runoff proportions, volumes or peak flows, by a simple ratio of previous to proposed catchments areas. The complete set of rainfall/runoff data relating to these plots is given in chapter 7, section 7.1.**

**Other research has shown that for small plots, runoff proportions (percentages, sometimes called "runoff efficiencies") tend to be larger for small catchments until the distance of flow is about 80 m. Thereafter it is assumed that runoff proportions remain the same for catchments with the same conditions.**

Size Ratio	1	2	4	Average Runoff %
Plot Area	42 m <sup>2</sup>	87 m <sup>2</sup>	177 m <sup>2</sup>	All Plots
Runoff				
Season 1	21	13	14	16
Season 2	13	11	8	11

**Table 2.1: Runoff Proportion (%) versus Catchment Size (average of 2 replicates)**

**Other factors can be much more influential than catchment size. In the example above, the variation in runoff from catchments of the same size due to differences in rainfall between the seasons was as great as that due to plot size. It must be remembered that data from previous work may have been collected during historical periods with greater or lesser rainfall amounts and/or intensities than those of a new project, even though the location of the data collection site is the same.**

**Variations in other catchment physical conditions, such as vegetation and crop cover, the level of which are determined by yet other environmental circumstances (especially rainfall and human activity), may also be important. The data in Table 2.2 shows runoff from the same-sized plots at the same site for three different rainfall seasons, each plot has a different kind and density of vegetation cover. The data are from a rangeland area of SE Botswana.**

	Bare plots	Grassy Plots	Small Tree	Large Tree	Rainfall (mm)
Season 1	41	6	1	1	236
Season 2	38	30	11	6	486
Season 3	29	10	1	1	719

**Table 2.2: Variation of Seasonal Runoff (%) with Vegetation Cover**

**Note that not only does vegetation cover type and extent determine runoff, but once again the difference in seasonal rainfall exerts a strong influence. In this case the season with most rainfall produced least runoff from all plots. This kind of comparison shows the influence of different, variable conditions on runoff.**

**The difficulties in estimating future runoff from past data are best overcome by a statistical analysis of the information: changes in catchment condition or rainfall pattern which affect runoff amount will be present in the data and will be accounted for.**

**The main design criterion of hydrological equipment is whether or not this equipment will cope with the largest individual runoff event in any given number of seasons. In experimental and equipment design, it is the balance struck between the cost of the over-design of equipment and the possibility of equipment failure during large storms, that is particularly important. A probability must be assigned to the occurrence of the particular design flow or peak that is selected. This can be done**

**by several statistical methods the simplest of which is the annual maximum series, outlined below:**

### **a. Theoretical Distributions**

**Runoff data are often matched to statistical distributions with known forms. Extrapolation can be made relatively simple where a good adherence to a statistical distribution can be found, but hydrological data may not conform, or different distributions may be more suitable in different geographical regions.**

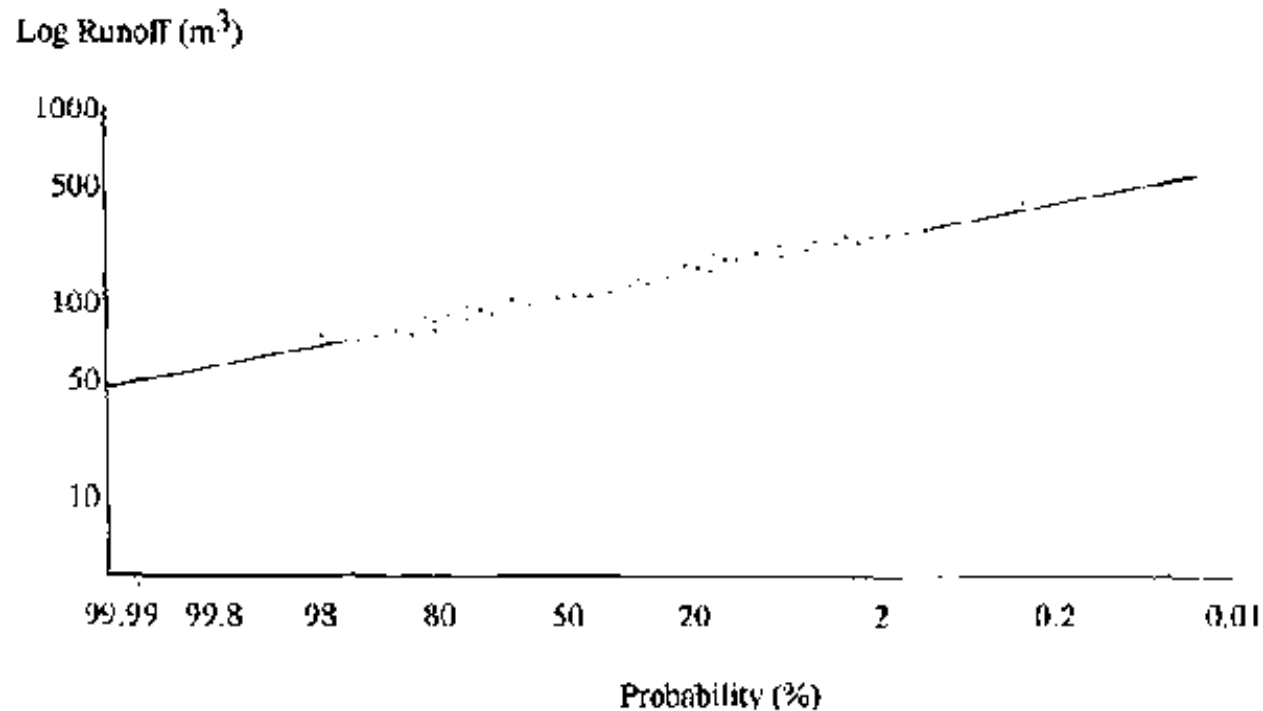
### **b. Partial Duration Series Methods**

**These methods do not evaluate the bulk of the data, but use a number of flows for each season that are greater than a selected runoff threshold. The pattern of these values is determined and linked to a statistical distribution from which flows of a specified return period can be extrapolated. The use of these methods is suitable when the number of seasons for which data have been collected is small, perhaps only 10 or less.**

## **Annual Maximum Series**

**This method, which is a particular kind of partial duration series, selects the largest event of each year or season, tabulates them in order of magnitude and from this list derives a flow peak with a probability of occurrence and return period. To extrapolate for large events, the data may be plotted as in Figure 2.1 below on log-normal probability paper. This is a very simple and straightforward method, its main limitation is that it requires a large number of years' data to be useful, as it selects**

**only the greatest flow from any season.**



**Figure 2.1: Annual Maximum Series, Runoff versus Probability**

**These methods of estimation of design flows are discussed in detail in Chapter 8, Data Analysis.**

### **2.1.2 Theoretical Estimates of Flow**

**A great deal of research has been undertaken to develop hydrological models that can predict runoff peak flows and volumes. The majority, however, are not suited to general use. Sometimes they are too complex but most frequently they are limited by the geographical localities and hydrological conditions within which the data were collected. Many models are regression models and their value is difficult to**

**assess outside their own particular circumstances.**

**Presented here are five models that can be used to predict peak flows and three models that are suitable to estimate runoff volumes. They are suitable for use with a wide range of catchment sizes and conditions. These methods of estimation have certain drawbacks: they can be relatively inaccurate because they make simplifying assumptions. They demand the availability of some primary data such as catchment physical characteristics and rainfall. However, they have been used for some time in a variety of environments with success and are based on measurements from a great number of catchments, with a wide range of physical characteristics.**

### **2.1.2.1 Peak Flows**

**Peak flows determine the design specifications of structures such as bunds, channels, bridges and dams. Peak flows also determine the capacity of the control sections of flow-through measurement systems and the collection pipes and transfer conduits of volumetric collection vessels. Some estimate of peak flows must be made before the design of these systems can be completed.**

**Design peak flows are linked to particular return periods, such as the maximum flow in 5, 10, 25, etc. years and design specifications are a balance between economic cost and the prevention of failure of the structure. Where no serious damage will result, for example on field bunds, a low return period ( say 5 or 10 years ) can be used. The 10 year return period is commonly used for agricultural purposes . Where serious damage or the loss of life is involved, then designs for large return periods, perhaps 50 or 100 years, are necessary. The return period most appropriate to the objectives of the project should be decided upon.**





$$q = 0.0028 C i_r A \text{ where (2.1 )}$$

**q = peak flow in  $m^3 s^{-1}$**

**C = the runoff coefficient**

**$i_r$  = maximum rainfall intensity in  $mm h^{-1}$  for the desired return period and the "time of concentration" of the catchment,  $T_C$ .**

**A = area of the watershed in hectares (1 ha = 10,000  $m^2$ )**

**The rainfall intensity is assumed to be uniform for the period and over the whole catchment for a time at least as great as the time of concentration of runoff, ( $T_C$ ).**

### **Values of Coefficient C**

**The value of C is the ratio of the peak runoff rate to the rainfall intensity and is dimensionless. It represents the proportion of rainfall that becomes runoff and is determined, to a large extent, by catchment conditions. Work by the US Soil Conservation Service has enabled the influence of many of these conditions to be expressed in various values of C. Examples of these C values are given in Tables 2. 3 for the USA (temperate region' 700-1000 mm average annual rainfall) and 2. 4 below for Malawi in central southern Africa (sub-tropical region' average annual rainfall variable. from  $< 400$  mm to  $> 1000$  mm). Different hydrological conditions according to soil groups are accounted for.**

Coefficient C for rainfall rates 25, 100 and 200 mm h<sup>-1</sup>

Cover and Condition	Soil Group A			Soil Group B			Soil Group C			Soil Group D		
	25	100	200	25	100	200	25	100	200	25	100	200
Row crop poor	.56	.58	.59	.63	.65	.66	.69	.71	.62	.71	.73	.74
Row crop good	.40	.48	.53	.47	.56	.62	.51	.61	.68	.54	.64	.72
Small grain poor	.33	.33	.33	.38	.38	.38	.42	.42	.42	.44	.44	.44
Small grain good	.15	.18	.18	.18	.18	.22	.20	.23	.24	.21	.24	.26
Meadow rotation good	.25	.29	.29	.29	.36	.39	.33	.41	.44	.34	.42	.46
Pasture permanent good	.01	.11	.15	.02	.17	.23	.02	.21	.28	.03	.22	.30
Woodland mature good	.01	.05	.07	.02	.10	.15	.03	.13	.19	.03	.14	.21

- Soil Groups:
- A. Lowest runoff potential. Deep sands and permeable loess
  - B. Moderately low runoff potential. Soils less deep than A, but as a whole above average infiltration after thorough wetting.
  - C. Moderately high runoff potential. Shallow soils and those with clays and colloids. Below average infiltration after wetting.
  - D. Highest runoff potential. Includes mostly clays with high swelling potential and soils with nearly impermeable horizons near the surface.

Source: US SCS National Engineering Handbook, Hydrology, USDA ARS

### Table 2.3: Coefficient C values for USA

Values of coefficient 'C' for Malawi are given in Table 2.4:

Cover and condition	Gentle slopes 0 to 5%		Medium slopes 6 to 12%		Steep slopes 12 to 20%	
	-----Degree of protection-----					
	Good	Poor	Good	Poor	Good	Poor
Rocky areas & saturated soils.		.56		.70		.80
Cultivated land poor crop cover.		.44		.60		.72
Poor crop cover & tied ridges.		.42		.55		.65
Mature crops good cover.		.36		.50		.60
Mature crops with poor cover & immature crops with good cover & tied ridges	.28		.40			.48
Grassland good cover forest poor cover & rain < 1000 mm yr. <sup>-1</sup>	.26		.35			.42
Forest moderate cover rain 1000 - 1250 mm yr. <sup>-1</sup>	.19		.30			.47
Mature crops, good cover, tied ridges	.15		.20		.24	
Forest, good cover & rain >1250 mm yr. <sup>-1</sup>	.14		.18		.21	
Poor cover crops:	Cotton, Tobacco in all circumstances					
Good cover crops:	Cereals, Rootcrops, Groundnuts, Coffee, Tea if well managed.					

Source: Land Husbandry Manual, Ministry of Agriculture and Natural Resources, Malawi.

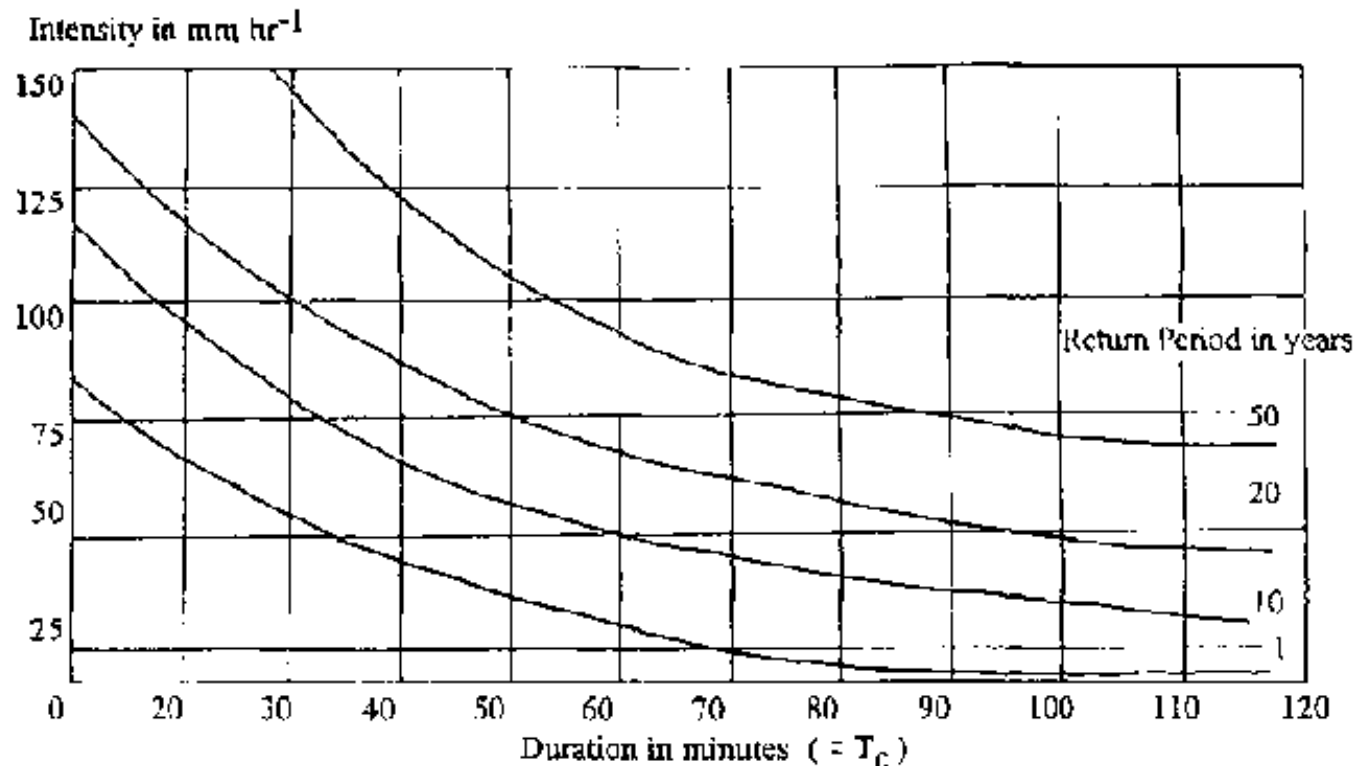
**Table 2.4: Coefficient C values (Malawi)**

## Rainfall intensity, $i_r$

**The rainfall intensity value used in the Rational Method is selected according to the desired return period for the design of the structure under study. The duration of the rainfall intensity is, for the purpose of the Method, said to be equal to the time of concentration of the runoff,  $T_C$ .**

**A graph or set of graphs can be drawn, to determine the maximum rainfall intensity for a particular return period and a particular rainfall duration (equal to  $T_C$  for the purposes of the Method). Such graphs demand the availability of many years of data, as they represent the line of best fit through a group of data points drawn from a wide range of rainfalls and their intensity measurements. Extensive records are especially necessary for long duration-intensity periods, which are not experienced frequently. Obviously, the climates of geographical regions will vary and even local differences can be great where a country shows a marked variety of topographic form. Areas of uniform rainfall characteristics should be provided with unique sets of rainfall intensity graphs. Figure 2.3 shows the manner in which these graphs are drawn.**

**A simple alternative way to calculate the return period of the maximum rainfall intensity for a specific duration, where data are too sparse to plot graphical relations, is shown below in Table 2.5 using 10 years' hypothetical example data. Where extrapolation is concerned, it should be remembered that the accuracy of estimation is related to the quantity of available data and the length of record. Note that in Figure 2.3, the lines defining  $T_C$ /Intensity relations are lines of best fit obtained from many storm data.**



**Figure 2.3: Example Graphs of Return Period, Intensity and Duration (which =  $T_c$ )**

**Example return periods used widely for different structures are: Field structures, 5-10 years; Gully control and Small farm dams, 20 years; Large farm dams, 50 years.**

**List the data as follows (duration in mins, intensity in  $\text{mm h}^{-1}$ , m is order number of the item in the array). The rainfall intensity is the maximum intensity recorded that season or year, for the particular duration. The return period, in descending order of magnitude, of the rainfall intensity in years -  $(n+1)/m$ , where n is the number of years of record. Note that in the example Table 2.5 below, the exact values for the 5 and 10 year returns must be interpolated from the table and the values are given in bold type. Although the relation between intensity and duration is in fact curvilinear,**

**linear interpolation does not lead to important inaccuracies. Making the time steps between the durations smaller, increases accuracy.**

m	Rainfall Intensity Duration				Return Period 10 years					
	10 mins	30 mins	60 mins	120 mins						
	Maximum Intensities in $\text{mm hr}^{-1}$				$(n+1)/m$					
1	85.0	75.0	58.0	20.0	11.0					
2	74.0	82.8	63.0	72.6	46.0	56.0	18.0	19.6	6.0	10.0
3	70.0	72.0	60.0	62.0	43.0	44.5	17.0	17.5	4.0	5.0
4	69.0		58.0		39.0		14.0		3.5	
5	67.0		54.0		37.0		13.0		3.0	
6	66.0		49.0		34.0		10.0		2.7	
7	64.0		47.0		29.0		8.0		2.4	
8	55.0		42.0		28.0		7.0		2.3	
9	53.0		40.0		26.0		6.0		2.1	
10	50.0		37.0		22.0		4.0		2.0	

**Table 2.5: Annual Maximum Series (Hypothetical Example Data.)**

**Intensities for the same return period increase with shorter duration (and  $T_C$ ). It is also clear from the example above, that long records of data are necessary to obtain rainfall intensity values associated with long return periods as well as long durations and this may be a limiting factor with work in developing countries where records are frequently short. Great care must be exercised in using data that are imported from other regions, if local data are not available.**

### **Time of concentration, $T_C$**

**The time of concentration ( $T_C$ ) is the time by which water from most distant parts of the catchment has reached the outlet. The following formula has been developed to**

**estimate  $T_C$ , with example values given in Table 2.6.**

$$T_C = 0.0195 L^{0.77} S^{-0.385} \text{ where (2.2)}$$

$T_C$  is in minutes

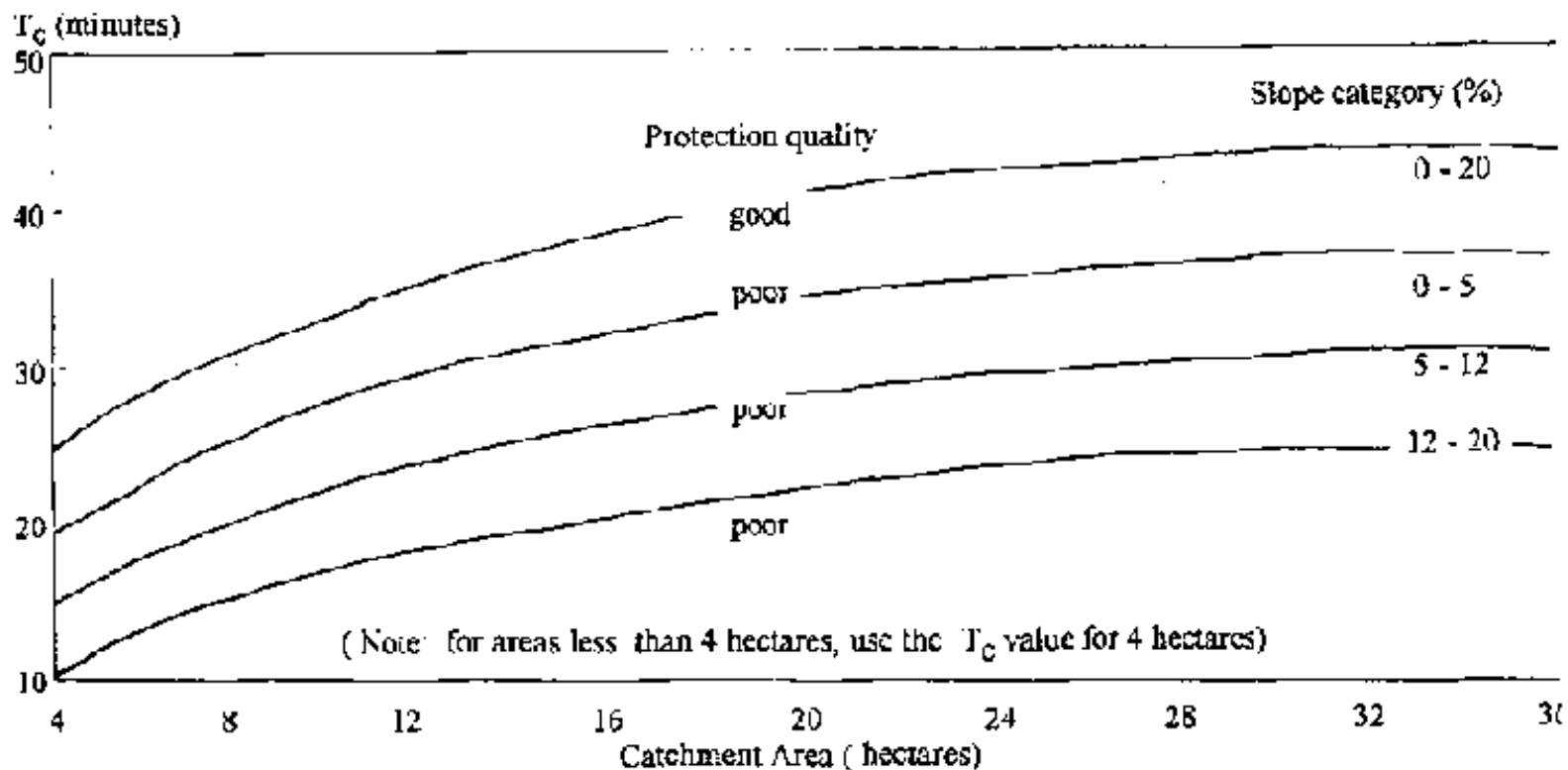
$L$  the maximum length of the catchment in m, and  $S$  = slope of the catchment in  $m m^{-1}$  over the total length  $L$

Maximum length of flow (m)	Time of concentration (minutes)					
	Catchment slope (%)					
	0.05	0.1	0.5	1.0	2.0	5.0
100	13	10	5	4	3	2
300	29	23	12	9	7	5
500	44	33	18	14	11	7
1000	74	57	31	23	18	13
1500	102	78	42	32	25	17
2000	127	97	52	40	31	22
3000	173	133	71	55	42	29
5000	257	196	106	81	62	44

**Table 2.6: Values of  $T_C$  using Formula 2.2**

**The time of concentration, when calculated from equation 2.2 or obtained from Table 2.6, can be used to obtain the desired maximum rainfall intensity, depending on return period.**

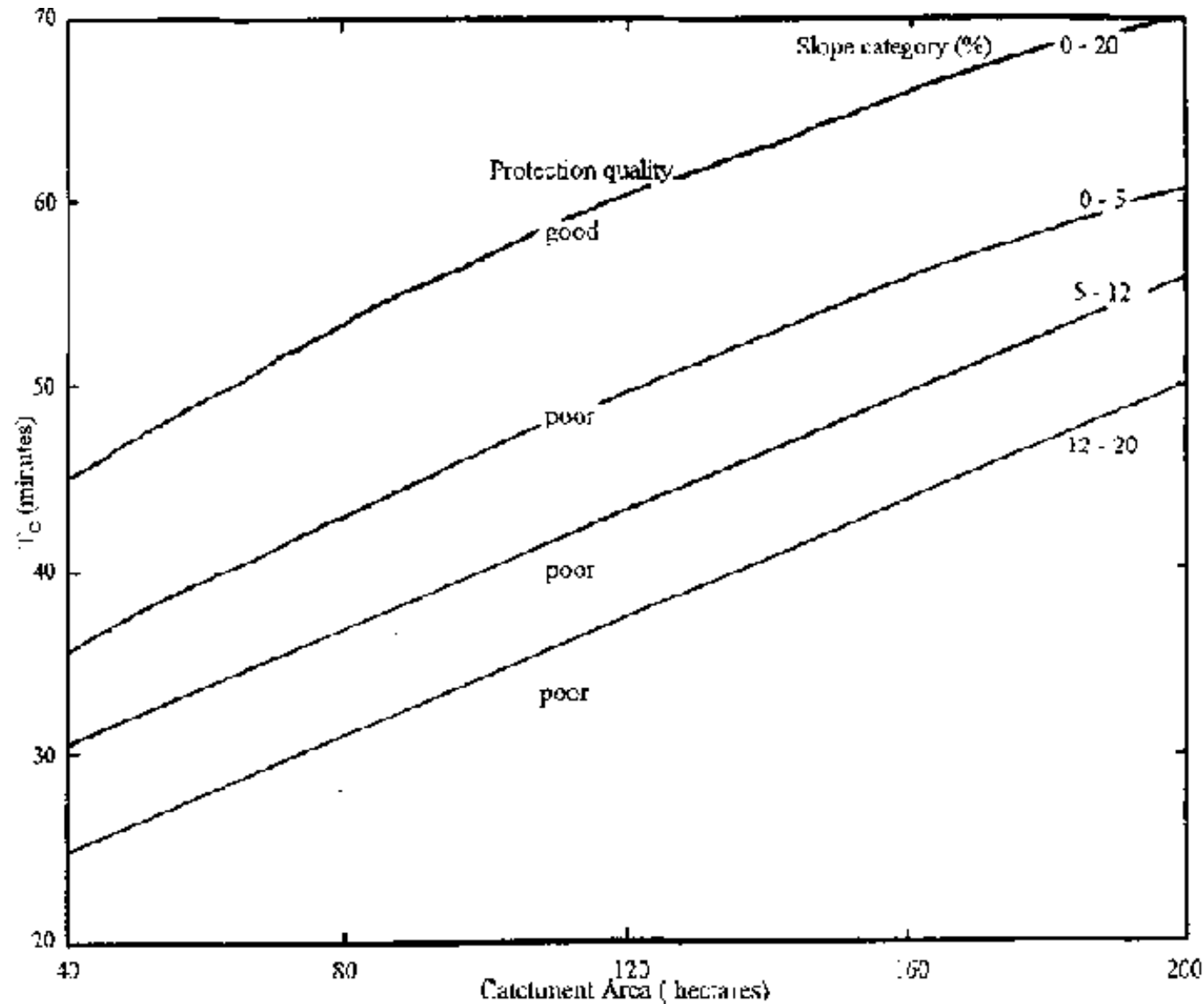




**Figure 2.4: Time of Concentration,  $T_c$ , for Catchment Areas 0 - 36 Hectares**

Equation 2.2 is not universally accepted and alternatively, the time of concentration can be found by dividing the measured length of flow by the estimated flow velocity. Manning's formula can be used to estimate flow velocities, although the estimation of flow velocity using Manning's formula can be a complex matter for large catchments where changes in channel form, size, slope and roughness can vary greatly and where the evaluation of these characteristics may be difficult. Figures 2.4 (above) and 2.5 (below) give values of  $T_c$  for a range of catchment areas, slope categories and qualities of protection. In all cases, it is important to calculate runoff peaks for the catchment conditions most likely to produce them, so that maximum peak flows are estimated: for example before cultivated land has been ploughed and

**before dense natural vegetation has regrown on non cultivated areas.**



**Figure 2.5: Time of Concentration,  $T_c$ , for Catchment Areas 40 - 200 Hectares**  
**Source: Land Husbandry Manual, Ministry of Agriculture and Natural Resources, Malawi**

## Worked Example

**A catchment of 15 ha is composed of 5 ha of permanent pasture (Soil Group B) and 10 ha of row crop in poor condition (Soil Group C). What peak flow is to be expected from a 1 in 5 year storm? The maximum flow length is 610 m, with a gradient of 2%.**

**From Table 2.6 or equation 2.2,  $T_c = 12$  minutes**

**From Table 2.5 (hypothetical illustration), Rainfall intensity  $73.0 \text{ mm h}^{-1}$**

**Runoff coefficient C for permanent pasture (Group B, 5 ha ) = 0.14**

**Runoff coefficient C for poor row crop (Group C, 10 ha) = 0.71 therefore weighted value of C for whole water shed - 0.52 substituting in equation 2.1:**

$$q = 0.0028 \times 0.52 \times 73.0 \times 15 = 1.6 \text{ m}^3 \text{ s}^{-1}$$

### b. Cook's Method

**Developed by the USCS, this method essentially provides a simpler and more generalised, but similar approach to the estimation of peak flows to the Rational Method. Catchment size and conditions are accounted for. Table 2.7 gives catchment condition details.**

Conditions	Extreme peaks (100)	High peaks (75)	Normal peaks (50)	Low peaks (25)
Relief	(40) Steep and rugged slopes > 30%	(30) Hilly land slopes 10 - 30%	(20) Rolling slopes 5 - 10%	(10) Flat land slopes 0 - 5%
Soil infiltration	(20) No effective soil with negligible infiltration	(15) Slow to take water clays, low infiltration	(10) Normal deep loam infiltration good	(5) Deep sand takes up water rapidly
Vegetation cover	(20) No effective cover	(15) Poor natural cover < 10% or clean crops	(10) Fair cover grass or wood. Not > 50% clean cultivation	(5) Good to excellent cover 90% grass or wood or equivalent
Surface storage	(20) Negligible ponds or marshes	(15) Low, no ponds, well defined drainage	(10) Normal, lakes, ponds < 20% considerable depression storage	(5) High surface depression storage, drainage not well defined

**Table 2.7: Values ( ) for Catchment Conditions Cook's method**

Catchment conditions are assessed and the numerical values assigned to each are added together. For example, if conditions are those in the right column of Table 2.7, a total value of 25 would be found and peak flows could be expected to be low, the exact size depending on catchment area. The conditions of a particular catchment will probably be found to be listed in different columns, but the relief condition is most heavily weighted and, in general, the four columns list conditions that describe "type" catchments. It was found generally that for African conditions, surface storage had little effect and a different set of values for catchment conditions were determined, as presented in Table 2.8. Soil type and drainage conditions were found to be especially important.

Relief/ Slope: Very flat - gentle	5	Cover: Heavy grass	10	Soil type/	Deep well grained	10
Moderate	10	Scrub	15	Drainage	Deep moderate	20
Rolling	15	Cultivated	20		Shallow impermeable	30
Hilly-steep	20	Bare	25		Hard clay/rock/	
Mountainous	25				Impermeable/ waterlogged	50

**Table 2.8: Catchment Condition Values for African Conditions**

**When a total of catchment condition values is made, the peak flow is estimated using Table 2.9, below.**

Total Value	25	30	35	40	45	50	55	60	65	70	75	80
Area (ha)												
5	0.2	0.3	0.4	0.5	0.7	0.9	1.1	1.3	1.5	1.7	1.9	2.1
10	0.3	0.5	0.7	0.9	1.1	1.4	1.7	2.0	2.4	2.8	3.2	3.7
15	0.5	0.8	1.1	1.4	1.7	2.0	2.4	2.9	3.4	4.0	4.6	5.2
20	0.6	1.0	1.4	1.8	2.2	2.7	3.2	3.8	4.4	5.1	5.8	6.5
30	0.8	1.3	1.8	2.3	2.9	3.6	4.4	5.3	6.3	7.3	8.4	9.5
40	1.1	1.5	2.1	2.8	3.5	4.5	5.5	6.6	7.8	9.1	10.5	12.1
50	1.2	1.8	2.5	3.5	4.6	5.8	7.1	8.5	10.0	15.6	13.3	15.1
100	1.8	3.2	4.7	6.4	8.3	10.4	12.7	15.4	18.2	21.2	24.5	28.0
200	2.8	5.5	8.4	11.7	15.3	19.1	23.3	28.0	33.1	38.5	45.0	52.5
300	4.2	7.0	10.5	14.7	19.6	25.2	31.5	38.5	46.2	54.6	63.7	73.5
400	5.6	10.0	14.4	19.4	25.6	33.6	42.2	51.0	60.0	69.3	79.5	90.0
500	7.0	11.0	17.0	23.5	31.0	40.5	51.0	62.0	73.0	84.0	95.0	106.5

**Table 2.9: Peaks Flows (m<sup>3</sup> s<sup>-1</sup>) According to Catchment Condition Total Values and Area Using 10 Year Probability High Intensities for Tropical Storms**

### c. TRRL (UK Transport and Road Research Laboratory) Model

**Work in East Africa, by the UK Transport and Road Research Laboratory has led to a model designed to overcome two serious problems associated with data in many**

**developing countries: that rainfall/runoff correlations can only be developed using large amounts of data and that extremes in the data are rare. The US SCS method was found not to give acceptable results for East African conditions.**

**The concept of a "contributing area" (CA) is used to avoid the use of a uniform coefficient throughout the catchment. Early rain fills the initial retention (Y) and runoff at this stage is zero. A lag time (K) was incorporated to account for routing on larger catchments. Total Runoff Volume was found to be defined by:**

$$Q = (P - Y) C_A \cdot A \cdot 10^3 \text{ (m}^3 \text{ s}^{-1}\text{) where (2.3)}$$

**P = storm rainfall (mm) during time period equal to base time of the hydrograph.**

**Y = initial retention (mm)**

**C<sub>A</sub> = contributing area coefficient**

**A = catchment area (km<sup>2</sup>)**

**The average flow Q<sub>M</sub> is given by:**

$$Q_M = 0.93 \cdot Q / 3600 \cdot T_B \text{ where (2.4)}$$

**T<sub>B</sub> is the hydrograph base time (hours)**

**Initial Retention (Y)**

**A value of 5 mm for Y was found to be appropriate for arid and semi-arid conditions.**

**A value of 0 mm for Y was found to be appropriate for wet zone areas.**

**Contributing Area (C<sub>A</sub>)**

**Soil type, slope, land use and catchment wetness were found to be the most influential factors in determining catchment contributing area. The design value is of the form:**

$$C_A = C_S C_W C_L \text{ where (2.5)}$$

**$C_S$  = a standard value of contributing area coefficient for grassed catchment at field capacity.**

**$C_W$  = catchment wetness factor**

**$C_L$  = land use factor**

**Lag Time (K)**

**Lag time was found only to have a relation with vegetation cover.**

**Base time of the hydrograph ( $T_B$ )**

**Simulation studies showed that  $T_B$  could be found from the equation:**

$$T_B = T_p + 2.3 K + T_A \text{ where (2.6)}$$

$$T_A = 0.028L / Q_M^{0.25} S^{0.5} \text{ where (2.7)}$$

**L = main stream length (km)**

**$Q_M$  = average flow during base time ( $m^3 s^{-1}$ )**

**S = average mainstream slope**

**K = lag time**

## $T_p$ = rainfall time

The value of QM can be estimated, through a trial and error iteration of equation 2.6, with  $T_A$  initially being zero. Below are the tables necessary to estimate the various runoff factors.

Catchment slope	Soil Type		
	Well Drained	Slightly Impeded	Impeded Drainage
Very flat < 1.0%		0.15	0.30
Moderate 1-4%	0.09	0.38	0.40
Rolling 4-10%	0.10	0.45	0.50
Hilly 10-20%	0.11	0.50	
Mountainous > 20%	0.12		

**Table 2.10: Standard Contributing Area Coefficients,  $C_S$  (wet zone areas, short grass cover)**

Rainfall zone	Catchment wetness factor	
	Perennial streams	Ephemeral streams
Wet zone	1.0	1.0
Semi-arid zone	1.0	1.0
Dry zone	0.75	0.50

**Table 2.11: Catchment Wetness Factor,  $C_W$**

The table (2.13) gives rainfall time ( $T_p$ ) for East African 10 year storms as a guide. The values for the localities under study can be obtained from local data if available.



Largely bare soil	1.50	Arid	0.1
Grass cover	1.00	Semi-arid scrub (large bare patches)	0.3
Dense vegetation	0.50	Poor pasture	0.5
Sand filled valley	0.50	Good pasture	1.5
Swamp filled valley	0.33	Cultivated land (to river bank)	3.0
		Papyrus swamp in valley bottom	20.0

**Table 2.12 Land use factors,  $C_L$  Catchment Lag times, K**

Zone	Index 'n'	Rainfall time, $T_p$ (hrs)
Inland zone	0.96	0.75
Coastal zone	0.76	4.00
Kenya - Aberdare - Uluogari zone	0.85	2.00

**Table 2.13 Rainfall time,  $T_p$ , for East African 10 year storms**

### Procedural steps for calculation

- Measure catchment area, land slope and channel slope.
- Establish catchment type and from Table 2.12 Lag time K.
- Establish soil type and using land slope, estimate standard contributing area coefficient,  $C_s$ . from Table 2.10.
- Establish antecedent rainfall zone and catchment wetness factor,  $C_W$ , from Table 2.11.
- Use Table 2.12 to estimate land use factor,  $C_L$ .

- Calculate contributing area coefficient by:  $C_A = C_S \cdot C_W \cdot C_L$
- Find initial retention  $Y$  (0 or 5 mm).
- Using Table 2.13 or local data find rainfall time,  $T_p$ .
- Calculate design storm rainfall to be allowed for during time interval  $T_B$  hours ( $P$  mm).
- Runoff volume is given by:  
 $Q = C_A \cdot (P - Y) \cdot A \cdot 10^3 \text{ (m}^3\text{)}.$
- Average flow is given by:  
 $Q_M = 0.93 Q / 3600 \cdot T_B$
- Recalculate base time using  
 $T_B = T_p + 2.3 K + T_A$  where  $T_A = 0.028 L / Q_M^{0.25} S^{0.5}$
- Repeat steps 6 to 9, until  $Q_M$  is within 5% of previous estimate.
- Design peak flow,  $Q_p$  is given by:  
 $Q_p = F \cdot Q_M$  where the peak flood factor,  $F$  is 2.8 when  $K < 0.5$  hour and 2.3 when  $K$  is  $> 1.0$  hour.

### Worked Example

**What is the 10 year peak flow of a catchment with the following details? Area 5 km<sup>2</sup>; Land slope 3%; Channel slope 1%; Channel length 2 km; Soils with slightly**

## impeded drainage; Good pasture. 10 year daily point rainfall of 80 mm.

From Table 2.12, Lag time K	= 1.5 hrs
From Table 2.10 Standard contributing area coefficient $C_S$	= 0.38
From Table 2.11, Catchment wetness factor $C_W$	= 0.5 (dry zone ephemeral)
From Table 2.12, Land use factor $C_L$	= 1.0
Therefore. design $C_A = 0.38 \cdot 0.5 \cdot 1.0$	= 0.19
Initial retention Y	= 0 mm
From Table 2.13, $T_p$	= 0.75 hrs
Using equation 2.6 with $T_A = 0$	
$T_B = 0.75 + 2.3 \cdot 1.5$	= 2.59 hrs

**Rainfall during base time is given by**

$$R_{TB} = T_B/24 (2.33/ T_B + 0.33 )^n \cdot R^{10/24}$$

where  $R^{10/24} = 10$  year daily rainfall  
and  $n = 0.96$  (Table 2.13)

$$\text{Therefore } R_{2.59} = (2.59/24 \cdot 24.33/ 2.92)^{0.96} \cdot 80 = 72.2 \text{ mm}$$

**An areal reduction factor is used to take account of the fact that rainfall depths are smaller over catchment areas than they are at spot measurement points.**

**The Areal Reduction Factor (ARF) was found to be =  $1 - (0.04 \cdot T_B^{-0.33} \cdot A^{0.55})$  which for the value of A and  $T_B = 0.93$ , thus:**

Average rainfall P	= $72.2 \cdot 0.93$	
	= 67.5 mm.	
The Runoff volume $Q = C_A (P - Y) \cdot A \cdot 10^3$	= $0.19 (67.5 - 0) \cdot 5 \cdot 10^3$	= $64.13 \times 10.3 \text{ m}^3$ .
$Q_M = 0.93 \cdot Q / 3600 \cdot T_B$	= $6.40 \text{ m}^3 \text{ s}^{-1}$	
First iteration of $T_A = 0.028 \text{ L} / Q_M^{0.25} \text{ s}^{0.5}$	= 0.04 hrs	

**The value of  $T_A$  (very small) indicates that no re-calculations of  $T_B$ , the Rainfall time and  $Q_M$  are necessary.**

**Therefore the design flood is:**

**$Q_p = F \cdot Q_p$  where the flood factor F is 2.3 (as K is > 1 hour).**

**Therefore the Peak Bow  $Q_p - 2.3 \cdot 6.4 = 14.72 \text{ m}^3 \text{ s}^{-1}$**

#### **d. US Soil Conservation Service Method**

**This method is founded on the rainfa/runoff relation for the triangular hydrograph illustrated below in Figure 2.6. It is important to note that the method is used to calculate the peak flow of a known runoff event volume or to calculate the peak flow for an expected or desired runoff event volume. A specific discharge must be designed for. Knowledge of rainfall intensity is not needed. Peak flow is defined by:**

$$q = 0.0021QA/T_p \text{ where (2.8)}$$

**q = runoff rate (peak flow) in  $m^3 s^{-1}$**

**Q = runoff volume in mm depth (the area under the hydrograph)**

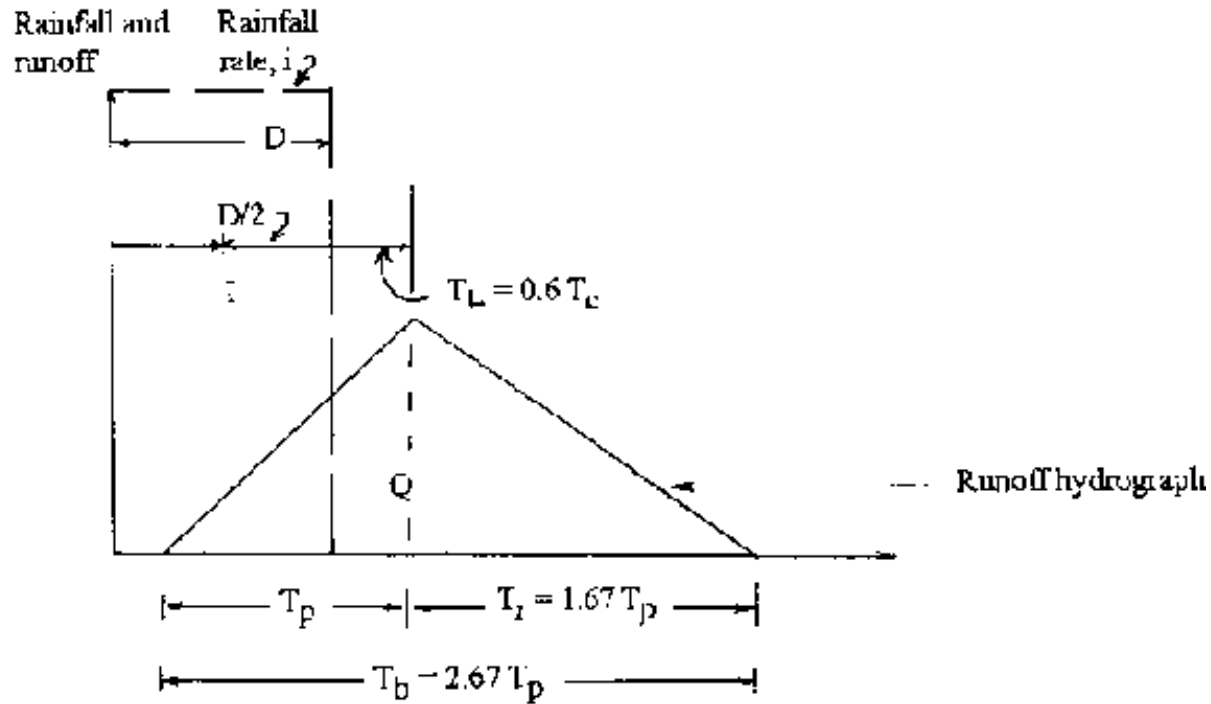
**A = area of water shed in ha**

**$T_p$  = time to peak in hours, defined by:**

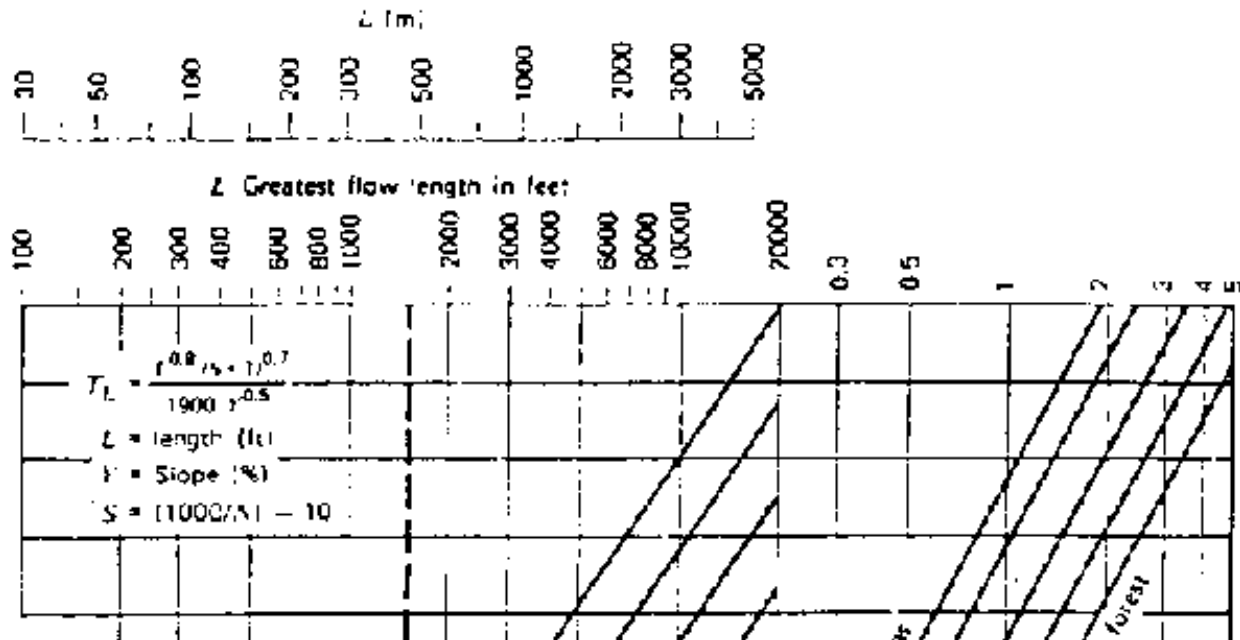
$$T_p = D/2 + T_L \text{ where (2.9)}$$

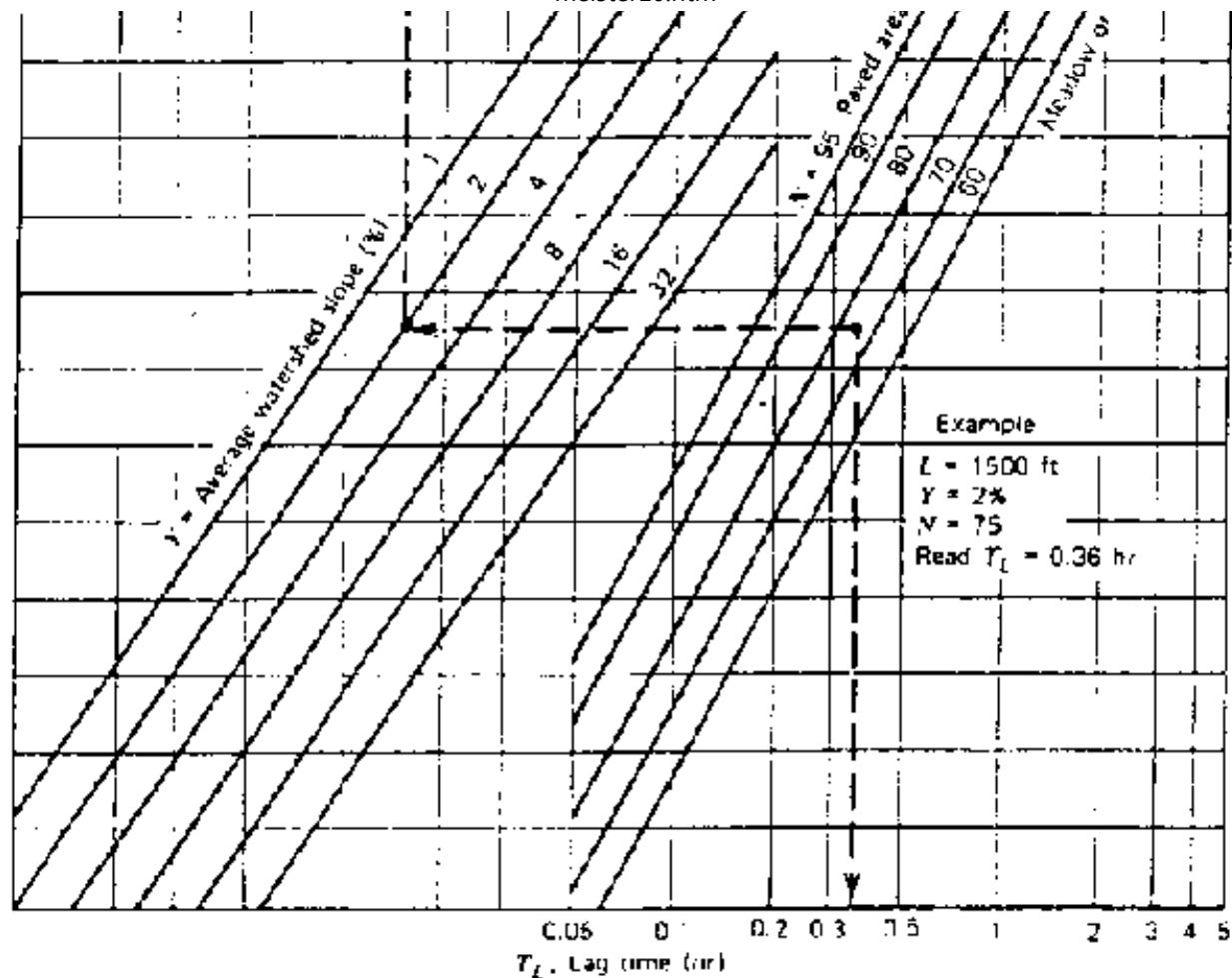
**D = duration of excess rainfall**

**$T_L$  = tune of lag, which is an approximation of the mean travel time and can be obtained from the nomograph below, Figure 2.7. Alternatively, Time of lag =  $0.6 \times$  Time of concentration which is the longest travel time of the runoff (not the time to peak as in the Rational Method).**



**Figure 2.6: The US SCS Triangular Hydrograph**





**Figure 2.7: Lag Time and Time of Concentration, US SCS Method**

**Source: US SCS Hydrology, National Engineering Handbook, 1972**

**Worked Example Determine the peak flow from a 10 ha catchment with a 0.5 hour storm that produced a runoff volume of 7 mm . Time of lag is 0.1 hours.**

**Substituting in equation 2.9,  
Time to peak,  $T_p = 0.5/2 + 0.2 \cdot 0.35$  hours**

**Peak Bow,  $q = 0.0021 \times 7 \times 10 / 0.35 = 0.42 \text{ m}^3 \text{ s}^{-1}$  or  $420 \text{ l s}^{-1}$**

### **e. Izzard's Method**

**The previous techniques have been developed to estimate runoff rates from catchments ranging in size from a few hectares to several hundred hectares. However, agrohydrological experiments frequently make use of very small runoff plots only tens of square metres in area. This is for two reasons. First, they are easy to replicate and many such plots can be placed in a small area to study a range of catchment conditions. Second, they can be used conveniently to look at interventions that work on a small scale and which are intended to be installed within the boundaries of individual fields. In these circumstances, a method developed to estimate runoff from sheet flow and limited channel flow may be more appropriate. Izzard made extensive experiments with flows from various surfaces, over relatively small areas. He found that the overland flow hydrograph could be drawn as a composite of the two dimensionless curves illustrated by Figure 2.8 and peak flow is found when  $q/q_e = 0.97$  and  $t/t_e = 1.0$ . and is given by**

**$q_e$ , the flow at equilibrium =  $iL / 3.6 \times 10^6$  whereh (2.10)**

**$i$  = rainfall rate in  $\text{mm hr}^{-1}$  and  $L$  = length of flow surface (in m) for a portion of the flow surface that is 1 metre wide.**

**For the purposes of calculating only the peak flow, it is not necessary to enter into the relations between the other runoff parameters which allow the construction of the overland flow hydrograph and the calculation of total flow volume. This is discussed below in the section on runoff volumes.**



**Peak flow,  $q_p$  in  $\text{m}^3 \text{s}^{-1} = 0.97 (i L / 3.6 \times 10^6)$**

### **Worked example**

**What is the peak flow of runoff from a 25 m wide strip catchment length 10 m, as the result of a rainfall with a maximum intensity of  $60 \text{ mm hr}^{-1}$ ?**

**Using formula 2.10, Peak flow  $0.97 \times 60 \times 10 \times 25 \times 1000 / 3.6 \times 10^6 = 4.0 \text{ l s}^{-1}$ .**

### **2.1.2.2 Runoff Volumes**

**It is necessary to estimate the size of likely runoff volumes as accurately as possible, as they will determine whether volumetric or continuous data collection methods must be used. If the former is selected, these estimates will ensure that the design of collection tank size is suitable. Tanks that are too small will be over-filled, data will be lost during large runoff events. This will be a great set-back because obtaining information about large runoff volumes and the probabilities associated with them is critical for agricultural planning purposes. The over-design of collection tanks incurs unnecessary expense and can lead to difficulties of installation.**

**For water harvesting schemes, it is necessary to estimate the size of runoff volumes that catchments are likely to shed. Over-estimation of runoff volumes can lead to serious under-supplies of supplementary water, whereas volumes much larger than those expected can result in flooding and the physical destruction of crops and structures. It is important to stress once more, however, that the methods for calculating runoff volumes shown below, can only provide estimates.**

## **a. US Soil Conservation Service Method**

**This method is applied to small agricultural watersheds and was developed from many years of data obtained in the United States, though it has been used successfully in other regions. The Method is based on the relations between rainfall amount and direct runoff. These relations are defined by a series of curvilinear graphs which are called "Curves". Each curve represents the relation between rainfall and runoff for a set of hydrological conditions and each is given a "Curve Number", from 0 to 100. The equation governing the relations between rainfall and runoff is:**

$$Q = (P - 0.2S)^2 / P + 0.85S \text{ where (2.11)}$$

**Q = direct surface runoff depth in mm**

**P = storm rainfall in mm**

**S = the maximum potential difference between rainfall and runoff in mm, starting at the time the storm begins.**

**The parameter S is essentially composed of losses from runoff to interception, infiltration, etc.**

**The US SCS calculates S by:**

$$S = (25,400 / N) - 254 \text{ where (2.12)}$$

**N is the "Curve Number", from 0 to 100. Curve Number 100 assumes total runoff from the rainfall and therefore S = 0 and P = Q.**

**Values of curve numbers for different hydrological and agricultural conditions are given in Tables 2.14 and 2.15. Note that the values for these tables are separated on the basis of antecedent soil moisture condition, that is the state of "wetness" of soils prior to rainfall. The basic assumption for this separation is that wet soils shed a higher proportion of rainfall as runoff than dry soils and therefore the same soil will have a higher curve number when wet, than when dry.**

Land Use	Treatment	Condition	Soil Group			
			A	B	C	D
Fallow Row crops	straight		77	86	91	94
	row	poor	72	81	88	91
	straight	good	67	78	85	89
	row	poor	70	79	84	88
	straight	good	65	75	82	86
	row	poor	66	74	80	82
Small grain	contoured	good	62	71	78	81
	contoured	poor	65	76	84	88
	terraced	good	63	75	83	87
	terraced	poor	63	74	82	85
	straight	good	61	73	81	84
	row	poor	61	72	79	82
Close seeded legume or rotation meadow	straight	good	59	70	78	81
	row	poor	66	77	85	89
	contoured	good	58	72	81	85
	contoured	poor	64	75	83	85
	terraced	good	55	69	78	83
	terraced	poor	63	73	80	83
Pasture or Range	straight	good	51	67	76	80
	row	poor	68	79	86	89
	straight	fair	49	69	79	84
	row	good	39	61	74	80
	contoured	poor	47	67	81	88
	contoured	fair	25	59	75	83
Permanent meadow	terraced	good	6	35	70	79
		poor	30	58	71	78
		fair	45	66	77	83
woods		poor	36	60	73	79
	contoured	good	25	55	70	77
Farmsteads	contoured		59	74	82	86
Roads	contoured		74	84	90	92

**Table 2.14: Curve Numbers for Soils and Catchment Condition, Antecedent Soil**

## Moisture Condition II

Conversion Values for Conditions I and III, from Condition II

Curve No for Condition II	Factor for Condition I	Factor for Condition III
10	0.40	2.22
20	0.45	1.85
30	0.50	1.67
40	0.55	1.50
50	0.62	1.40
60	0.67	1.30
70	0.73	1.21
80	0.79	1.14
90	0.87	1.07
100	1.00	1.00

**Table 2.15: Curve Numbers for Soils and Catchment Condition.**

**Local conditions, especially rates of evapotranspiration, should be considered to assess whether the categorisation of antecedent soil moisture conditions I to II should be modified. For example, soils in a region with summer rain and a summer growing season may fall within category 1, despite a previous 5-day rainfall of 40 mm. Similar soils with a winter growing season and the same antecedent rainfall could fall into category III.**

**One difficulty in using the US SCS method is the derivation of the value the rainfall parameter P. This parameter is usually defined as a specific return period storm of a known duration, for example "the 12 hour rainfall with a return period of 50 years", expressed in mm. Rainfall P is calculated from a relatively complex linear relation with several rainfall duration and return period factors. In the US, these data are easily available and can be obtained from published maps and although regional**

**variations in the relations defining the rainfall intensity parameter exist to cover climatic variation, there are serious difficulties in transferring this kind of information to other geographical areas. In developing countries it is unlikely that such comprehensive data will be available. Even if they were, the work involved in converting raw data into a series of useful tables, graphs or maps would be beyond the scope of most projects where all that is sought is an estimate of runoff.**

**As an alternative, long-term daily rainfall is usually available even in countries with only basic meteorological information. The 24 hour rainfall is a frequently-used value and in these circumstances, it is best to use a simple estimate of rainfall that can be obtained from a listing of annual maxima, such as shown in Table 2.5. For example the 10year return daily (assume it to be the 24 hour) rain could be used in equation 2.11 to calculate runoff. Relations between daily and other period rainfall can be established by regression analysis where records exist. When available, local records should be used even if they are less amenable to sophisticated treatment**

Soil Condition	Previous 5 day rainfall (mm)	
	Dormant Season	Growing Season
I Soil dry from lower plastic limit to wilting point	< 13	< 36
II Average value	13 -28	36-53
III Heavy rainfall or light rainfall and low temperatures	> 28	> 53

**Table 2.16: Antecedent Soil Conditions**

## Worked example

**Given that the 25 year return rainfall is 85 mm, calculate the total runoff volume from a catchment of 46 ha, of which 13 ha are poor pasture (soil group A), 25 ha are contoured under small grain crops with poor treatment (soil group C) and the remaining 8 ha are fallow (soil group B). Antecedent soil moisture condition 1.**

Subarea A (ha)	Soil Group	Land Use	Curve No. N	N×A
25	A	Pasture, poor condition	68	1700
13	C	Small grain, poor condition	63	819
8	B	Fallow	86	688
			Total N×A =	3207

**Therefore the weighted curve number =  $3207 / 46 = 69.7$**

**From  $S = (25,400 / 69.7) - 254 = 110$  mm**

**From equation 2.11  $Q = (85 - 0.2 \times 110)^2 / 85 + (0.8 \times 110) = 22.9$  mm over the catchment (1mm on 1 ha =  $10 \text{ m}^3$ )**

**The total runoff,  $Q = 22.9 \times 10 \times 46 = 10,534 \text{ m}^3$**

### **b. TRRL Model**

**Reference to this model is made for an alternative method of calculating runoff volume later in this chapter.**

### **c. Izzard's method**

**The use of work by Izzard for the calculation of peak flows was discussed earlier, in the relevant section. The results can also be used to calculate flow hydrographs and volumes and is especially useful for small runoff plot calculations.**

**Izzard found that the time to equilibrium,  $t_e = 2 V_e / 60 q_e$  where (2.13)**

**$t_e$  is the time to which flow is 97% of the supply rate and  $V_e$  is the volume of water in detention at equilibrium. The volume  $V_e$  in cubic metres was found to be:**

$$V_e = kL^{1.33} i^{0.33} / 288, \text{ where (2.14)}$$

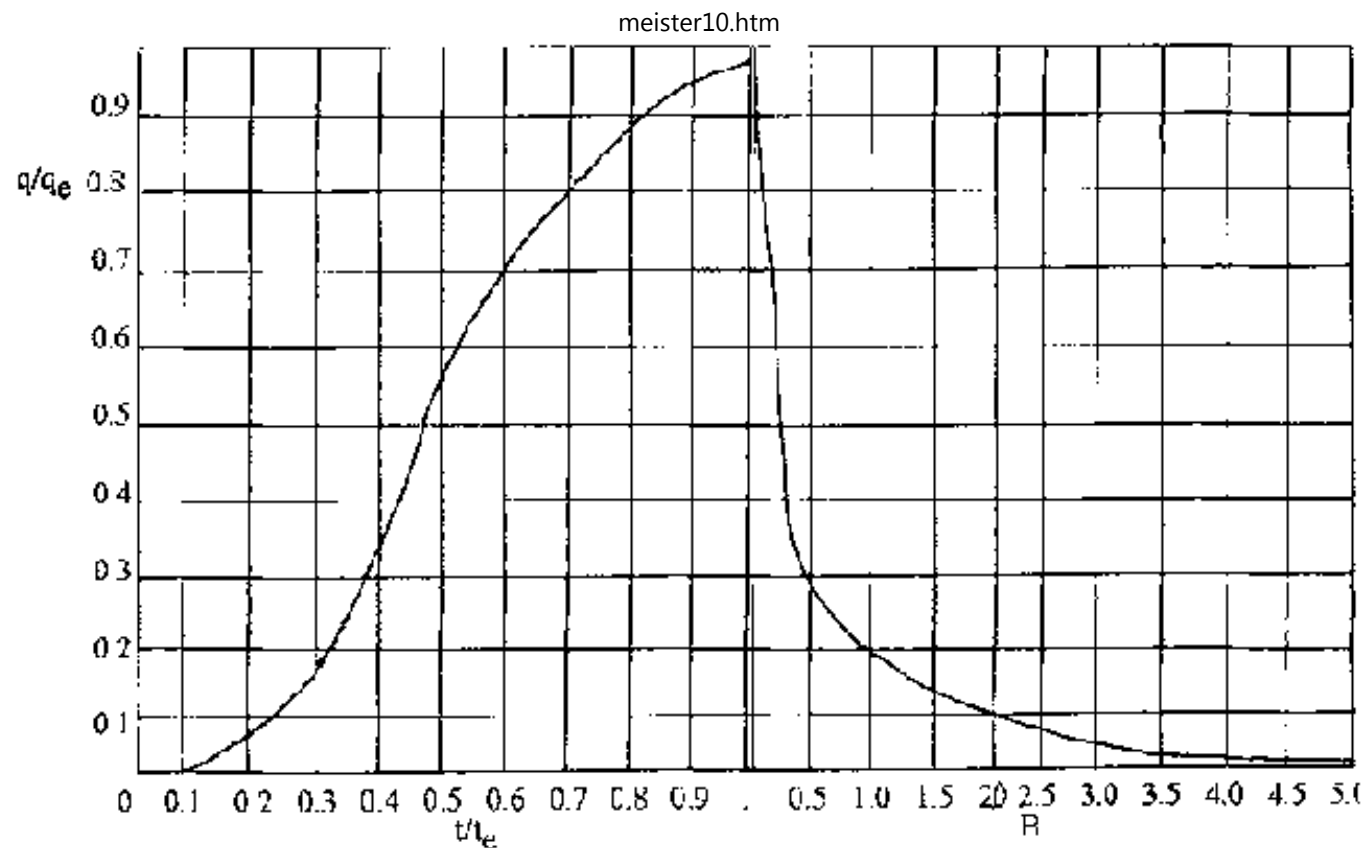
**$i$  is in mm hr<sup>-1</sup> and  $L$ , the length of the strip is in m.  $k$  was found experimentally to be given by:**

$$k = 2.76 \times 10^{-5} i + c / s^{0.33} \text{ where (2.15)}$$

**$s$  is the slope of the surface and  $c$  is given in Table 2.17.**

$$\text{The average depth over the strip is } = V_e / L = kq_e^{0.33} \text{ (2.16)}$$





**Figure 2.8: The Dimensionless Hydrograph according to Izzard**

Very smooth asphalt pavement	0.0070
Tar and sand pavement	0.0075
Concrete	0.0120
Closely clipped sod	0.0460
Dense bluegrass turf	0.0600

**Table 2.17: give values of the surface retardance coefficient  $c$  for various surfaces.**

**Table 2.17 Surface Retardance ' $c$ '**

**Note that for low slopes and small rainfall intensities, the value of  $c$  is relatively important.**

## Procedure to calculate runoff volume

- Values of  $t_e$  and  $q_e$  can be calculated from equations 2.13 and 2.10, respectively.
- With  $t_e$  and  $q_e$  known, the plot of the rising limb of the overland flow hydrograph, plotted as  $q$  (volume) against  $t$  (minutes) can be found from Figure 2.8.
- The recession curve of the hydrograph can be plotted using the factor  $B$  which is:

$$B = 60q_e t_a / V_O \text{ where (2.17)}$$

$V_O$  is the detention volume given by equations 2.15 and 2.16, taking  $i = 0$  and  $t_a$  is any time after the end of rain.

- When the hydrograph is drawn, the runoff volume is the area under the hydrograph.

## 2.2 Collecting runoff data

### 2.2.1 Volumetric data

#### Simple Tanks

#### Complex Tank Systems

##### Multislot Dividers

##### Multipipe Dividers

## **Rotary Dividers**

### **2.2.2 Continuous Systems**

#### **2.2.2.1 Natural Controls for Runoff Measurement**

##### **Rating Curves**

##### **Methods of Flow Measurement**

**Velocity Area Method**

**Float Gauging**

**Chemical Gauging**

##### **Stream Flow Networks**

#### **2.2.2.2. Artificial Controls for Runoff Measurement**

##### **Flumes**

**HS, HL and H Flumes**

**Parshall Flumes**

##### **Weirs**

**V-notch Weirs**

**Triangular Weirs**

##### **Culverts and Existing Structures**

**Methods to calculate the runoff that is likely from various rain storms on catchments of various sizes and with a range of conditions have been discussed. The following chapter describes the equipment that is needed to measure runoff using these systems. There are two main types:**

## **Volumetric equipment**

### **Continuous or Through-flow equipment**

**A theoretical estimation of runoff peaks and volumes will enable the choice between these two methods to be made, as choice is determined essentially by the size of runoff volumes. Other considerations such as the risk of sedimentation, debris in the flow, site and cost also play a part in the decision, but the amount of water to be measured is by far the most important criterion. In general, the two methods of data collection are used in the following circumstances and have the concomitant advantages and disadvantages that are outlined below. After considering these advantages and disadvantages and after estimating the size of flows that are likely, the most suitable method of measurement should be clear. If doubt remains between the suitability of using simple or complex volumetric measurement systems, further discussion is presented in section 2.2.1.**

## **Volumetric Data Collection Methods**

### **Advantages:**

- Can be used easily to measure small volumes of runoff.**
- The most basic equipment is a simple tank, although more complex systems**

**will be described later, whereby a small, known proportion of the flow is collected and the total is found multiplying the collected flow according to this proportion.**

- This equipment is relatively cheap.**
- It can be manufactured locally and is relatively simple to use.**
- Lends itself to the easy replication of experiments.**

### **Disadvantages:**

- The main limit on the equipment is the physical size, in particular the depth of the collection vessel, the top of which must be installed at a lower elevation than the runoff area.**
- It also has the disadvantage of only collecting "lump sum" runoff volumes and gives no other hydrological information. This limits the usefulness of the data.**
- No idea of the varying contributions within complex storms is available.**
- No information on runoff duration can be found, nor how much rain fell before runoff started.**
- The equipment must be well-serviced and be emptied (of sediment as well as water) after every runoff event. It is therefore not a good system for field station runoff measurements, because runoff may not be suspected and an arduous and often fruitless visiting schedule would be necessary to cover all eventualities on a routine basis.**
- There is the risk of over-filling of the tanks which can result in the loss of**

**accurate data, though a limited number of experiments with very small vessels can be used successfully, if a reliable field observer is engaged at the site.**

## **Continuous Data Collection Methods**

**These can be undertaken in many different ways, depending on the physical properties of the flow and characteristics of the site, but the basis of measuring the runoff remains the same for all. Runoff is channeled to flow through a "control" section. This control section may be artificially constructed and as such, will have pre-determined hydraulic properties. Alternatively, a suitable section of a natural channel may be used, though the hydraulic properties of a natural channel must be determined by measurement. In either case, the volume of water passing at any time is found by measuring only the height of water in the channel (the "stage" of the flow). The measurement of stage is effected by the use a water level recorder (WLR) which records changing flow stages over a desired period. Integration of the various stage heights over the period of record gives the total flow.**

### **Advantages:**

- These methods also give information on flow durations, peak flows and on when runoff started in relation to rainfall.**
- WLRs can hold the data relating to many runoff events.**
- The equipment can be left unattended for months if necessary and is well-suited for use at remote field sites.**

- **The disruption of routine visiting schedules is not a serious problem.**
- **There is no limit to the flow volumes that can be measured, if the control section is large enough to pass the runoff.**

### **Disadvantages:**

- **The greatest restriction on the use of this method is the cost of the water level recorders (similar to that of recording rain gauges) and, in common with any complex machinery, the possibility of malfunction. Artificial control sections can be designed to be built locally, for an outlay similar to that of volumetric collection tanks.**

## **2.2.1 Collection of Volumetric Data**

### **Simple Tanks**

**Simple tanks are used to collect runoff from the very smallest catchments. It is important to put into perspective the size of plot for which simple tanks are suitable:**

### **Example**

**For every 1 mm of rainfall that is shed per 1 m<sup>2</sup> of catchment, the collection tank will receive 1 litre of runoff. A 1 in 10 year storm is an appropriate return period for which to design.**

- **A 100 mm storm (assumed to be a 1 in 10 year rainfall) over a 1 m<sup>2</sup> plot with a runoff efficiency of 50 % ( for example a sandy loam soil, with a slope**

**of 2%, relatively bare of vegetation ) would give 50 litres of runoff.**

- Over a 10 m<sup>2</sup> (1 m × 10 m) plot runoff would be 500 litres**
- Over a 100 m<sup>2</sup> (10 m × 10m) plot runoff would be 5000 litres.**

**A tank built to contain 5000 litres would need to have dimensions greater than 2.5m × 2.0m × 1.0 m, (an adequate freeboard is always essential), about equal to the capacity of 25 large oil drums. This is too big for easy manufacture, installation and replication. Even to contain the runoff from the 10 m<sup>2</sup> plot, the tank would have to be greater than 1.0 m × 1.0 m × 0.5 m. Alternative complex tank systems can be designed to collect runoff amounts of this order of magnitude, and these systems are discussed later. It is reasonably obvious, therefore, that even though most runoff events will be much smaller than the example above, simple tanks should not be used on plots larger than a few square metres. The importance of measuring extreme event runoff volumes, to ensure the widest range of data for analysis, cannot be over emphasized.**

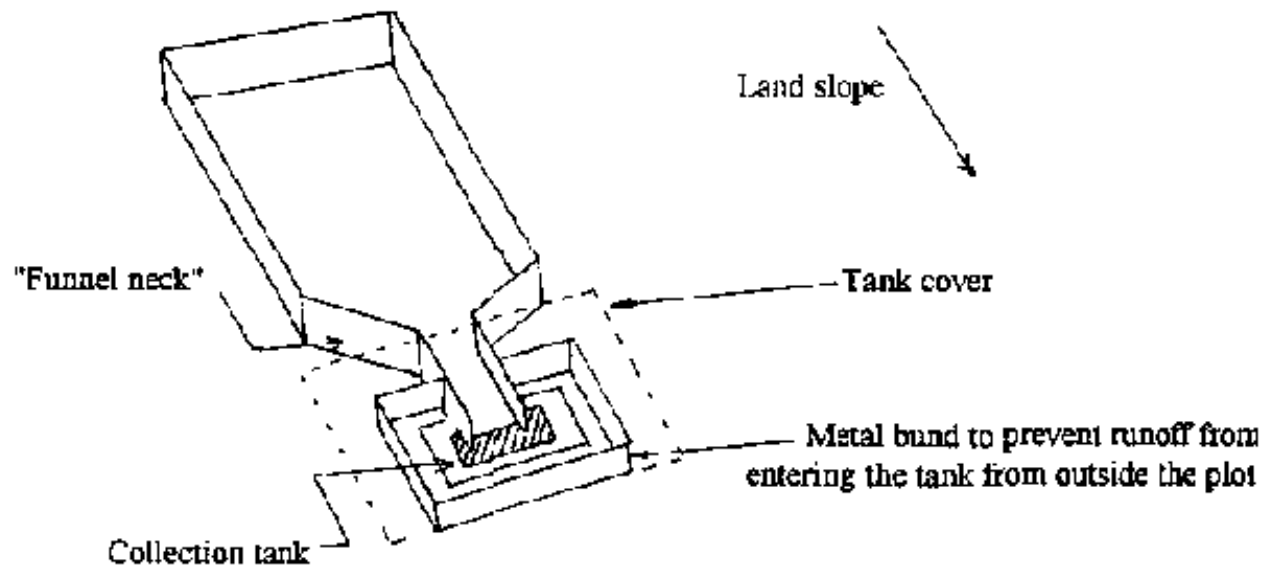
## **Design**

**On the whole, the design of simple tanks is not a difficult task. The dimensions should be appropriate to the size of the estimated maximum runoff volume. Remember that an adequate freeboard is necessary. Generally it is best to have the tanks made specially, as the modification of containers used previously for other purposes may be as expensive and can lead to compromises in design.**

**An example simple tank and plot layout is illustrated below in Figure 2.9.**



## Galvanized steel plot boundaries, about 15 -20 cm above ground



**Figure 2.9: Typical Design of Simple Runoff Tank and Plot Layout**

### Features to note are:

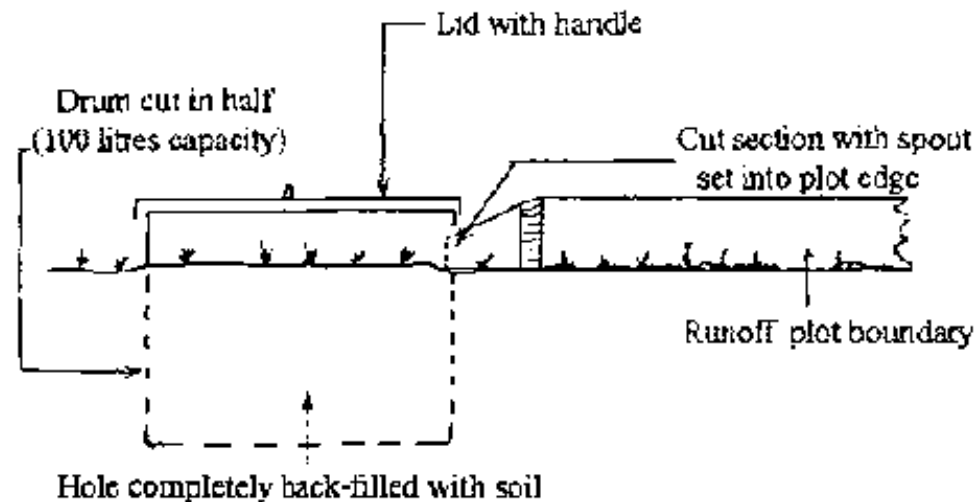
- **Light gauge galvanized steel boundaries, about 15 cm high to avoid rain shadow. These can be easily bent into shape and be knocked into the ground or, if soils are very hard, dug in. Any seam or joint that is not sealed should have its outer edge pointing downslope to prevent the entry of outside runoff.**
- **"Funnel" neck to direct flow into tank. This should be large enough to allow unrestricted peak flow into the tank. It should not be liable to blockage by debris; a wire mesh may be fitted.**
- **Tank cover to prevent rainfall entering tank directly and prevent animals**

## **interfering with collected runoff.**

- The tank should be made of inexpensive mild sheet steel, painted against rust.**
- Welding destroys zinc protection at seams, if galvanised steel is used.**
- Plastic containers usually have a short life, due to rotting by UV light.**

**One suitable alternative to the specially manufactured tank is the ubiquitous large oil drum (usually about 40 imperial gallons or a little more than 200 litres). These can be cut to size along a horizontal axis to give 2 × 100 litre containers with some freeboard. These tanks are generally too deep to allow easy installation as a whole unit (deep soils would be needed and emptying a deep container is awkward) and their horizontal installation is very inconvenient.**

**A section must be cut to allow a funnel arrangement to enter the tank and lids need to be manufactured as separate items. Oil drums are often prized objects in developing countries, put to many varied uses and their cost or scarcity may make them unsuitable. A typical installation is shown below in Figure 2.10.**



**Figure 2.10: Modified oil drum as 100 litre collection tank**

## Installation

**The tank, of whatever type, must be sunk into the ground, therefore ensure that depth is the smallest dimension where possible and completely fill in the whole of the excavated area to avoid water collecting around the tank and disturbing it by flotation or subsidence. Settlement of the soil may take some time. Ensure that animals cannot remove the lid to drink from the water. Regard theft (and possibly vandalism) as a serious threat in field locations.**

**Cementing the tank into the ground should be avoided as it is likely that the tank will have to be removed on occasions for a thorough cleaning and possibly repair. Easy removal is especially important if the installation is in a farmer's field where pre- and post-ploughing runoff data may be required and removal will be necessary. The tank's presence could prevent correct ploughing. The plot boundaries should not cast a serious rain shadow and should be tapped into the ground or eased in with a spade. The galvanized sheeting recommended can be re-used over many**

**seasons and is cheap and easy to work with. In all respects metal sheeting is superior to earth-dug bunds for small plots. During and after installation, ensure that the minimum disturbance is made to the catchment. In particular ensure that digging etc. does not impede or encourage runoff flow into the tank. Remember that surface flow on small catchments is very shallow, perhaps less than 1 cm deep and even very small surface features, inadvertently produced, can affect runoff. If installed at a field site, a permanent reader will probably be necessary.**

## **Measurement**

**Carelessness while measuring the amount of runoff that has been collected can lead to as inaccurate results as careless installation of the equipment. A standard data sheet should be drawn up, such as the one below. A separate sheet per site is recommended for each visit. Each individual tank should be clearly numbered where several tanks are installed together. A record of the capacity of the tanks is essential to check against spurious measurement. The tanks can be emptied by scooping out the water using a small measuring vessel. This is preferable to having to remove the tank when measurement is made. The quickest and most reliable way to read the tanks is to have 2 × 20 litre (marked with 1 or 2 litre graduations) and 2 × 5 litre containers (marked in 0.5 litre graduations) available. The runoff is scooped out in a marked vessel (2- 3 litres capacity is the most manageable) and poured into one of the 20 litre containers. When this is full, it is noted on the sheet. This tank is emptied while the other is filled. When most of the runoff is emptied, the 5 litre vessels are used. Unless runoff amounts are very small, results to the nearest 0.2 litre are adequate. Care is needed during the process. Sediment is likely to be present.**

**Dip-stick measurement of runoff is difficult since accurate leveling of the tank is**

necessary during installation and the tank may later re-settle or be disturbed. Graduations marked on the tank are an unsatisfactory method of measurement, they become erased or covered with mud, etc. Emptying the tanks carefully is surprisingly time-consuming and an adequate period should allowed, especially where groups of many tanks are involved. It is best that at least two people should undertake the task together and three is to be preferred, one concerned only with the recording of data.

Date	24. 07, 92	Start time read	09:32
Station	San Ignacio	Group	2
Rainfall	27.6 mm	Time read	09.27

---

Tank Set No.	Size	No. full measuring vessels			Total Litres
		20 litres	5 litres	1 litre	
1	/		/	/	<u>21.5</u>
2	/	/	/	/	<u>52.5</u>
3	/	/	/	/	<u>28.5</u>
	etc.	etc.	etc.	etc.	

---

Reader Johnson

**Figure 2.11: Collection tank data sheet example**

## Complex Tank Systems

The examples of possible runoff amounts, given in the previous section on simple tanks, indicate that small tanks can only be used on runoff plots of about 10 m or even less. For larger catchments, that for one reason or another are not fitted with

**flow-through measuring devices, a more complex system of collection tanks is needed.**

## **Design**

**The basic arrangement of these systems is to install a first tank which collects initial runoff. When this tank is full, further runoff entering the tank causes overflow into a second tank. However, only a small, known proportion of this overflow runoff is passed into the second tank, most of the runoff is allowed to run to waste. Such systems can deal with runoff from catchment areas with an upper limit (depending on storm size and catchment conditions) of about 100 to 200 m<sup>2</sup>, though this will be determined by the character of the individual site. There are two main types of complex tank systems:**

**Multi-slot dividers and Rotating slot dividers.**

**The major limitations are:**

### **- Tank size**

**The manufacture and installation of tanks with capacities of several hundred litres can be difficult. Generally, they are made of heavy-gauge galvanized or mild steel sheet to retain some rigidity and are therefore quite expensive to manufacture and unwieldy to install. Because of their size and the fact that they lie one behind the other, downslope, considerable earth-moving may be necessary, especially where land slopes are low. Shed-like constructions may be needed to prevent rain from entering the tanks and flow channels. Dug earth channels behind the installation are necessary to remove the waste water during rainfall/runoff and to prevent the**

**ponding of water which may otherwise enter the tanks and confuse measurement. These channels are also essential to remove the water as the tanks are emptied, which requires the use of a small pump. Pumps of about 0.1 horse power combine sufficient power with precision of control. The tanks should be protected from accidental runoff from areas around the installation. Installations for rotary dividers are considerably smaller than those of multi-slot dividers.**

**The tanks cannot be considered portable in any sense of the word and a permanent location is required for their use. It is important therefore that very careful consideration is given to site suitability from the viewpoints of installation and experimental objectives. In particular, problems can occur in areas of low slope (< 2%) where back-up ponding and drainage difficulties can be severe.**

#### **- Number of tanks**

**If small tanks are preferred, a greater number must be used for each installation and this number is limited by accuracy, as well as the space that they occupy. The first tank in line measures all runoff, conventionally the second tank measures 1/10 th of the overflow and a third tank would usually do the same (though these proportions can be altered to suit individual needs). Thus by the third tank, only 1% of the real runoff amount is actually being collected. If the tanks are not well-manufactured and properly installed, every 1 litre inaccurately measured will affect the calculated volume by 100 litres. If yet another tank were added to increase the catchment area from which runoff was collected, then each litre measured would represent 1000 litres (1 m<sup>3</sup>) of runoff. Small inaccuracies of collection or measurement would lead to seriously flawed data. Although the difficulties of tank size can be overcome by making the tanks smaller, three tanks in line is probably the sensible limit. The problems of accuracy can be overcome by calibration (see**

**below), but some inaccuracies in measurement and accidental spillages must be accepted as a fact of life.**

**Rotating slot dividers do not suffer from exactly the same limitations as multislot dividers, since the division of runoff into various proportions is only undertaken once. However, high quality design and manufacture is essential and any flaw in the mechanism may prevent operation. Peak flow estimates by calculation should be made to ensure that all inlets/outlets can cope with the flow.**

#### **a. Multislot Divider**

**Runoff draining from a collection gutter (which should be covered with a wire trash screen ) on the downslope side of the plot flows into a conveyance channel or pipe to the first tank. Heavy sediment will settle here. When this tank is full, 10% (for example) of the excess is passed through a vertical slot and drops down into the second tank. Various sizes and numbers of slots can be used, according to need, examples of approximate slot sizes and capacities are given below in Table 2.18.**

**The remaining portion of the runoff continues along the channel to be discharged as waste, or to further tanks where a similar proportion is retained for measurement. The tanks and slot plate should be made of suitable galvanized steel sheet with welded, water-tight seams. Slots should be made in the plate as accurately as possible and all angles should be 90°. However, sophisticated workshop facilities may not be available and equipment may have to be transported under difficult conditions to a field site. Thus, while it is important to construct the dividing system with care, it is necessary to calibrate the equipment after installation, to correct for any inaccuracies of manufacture.**

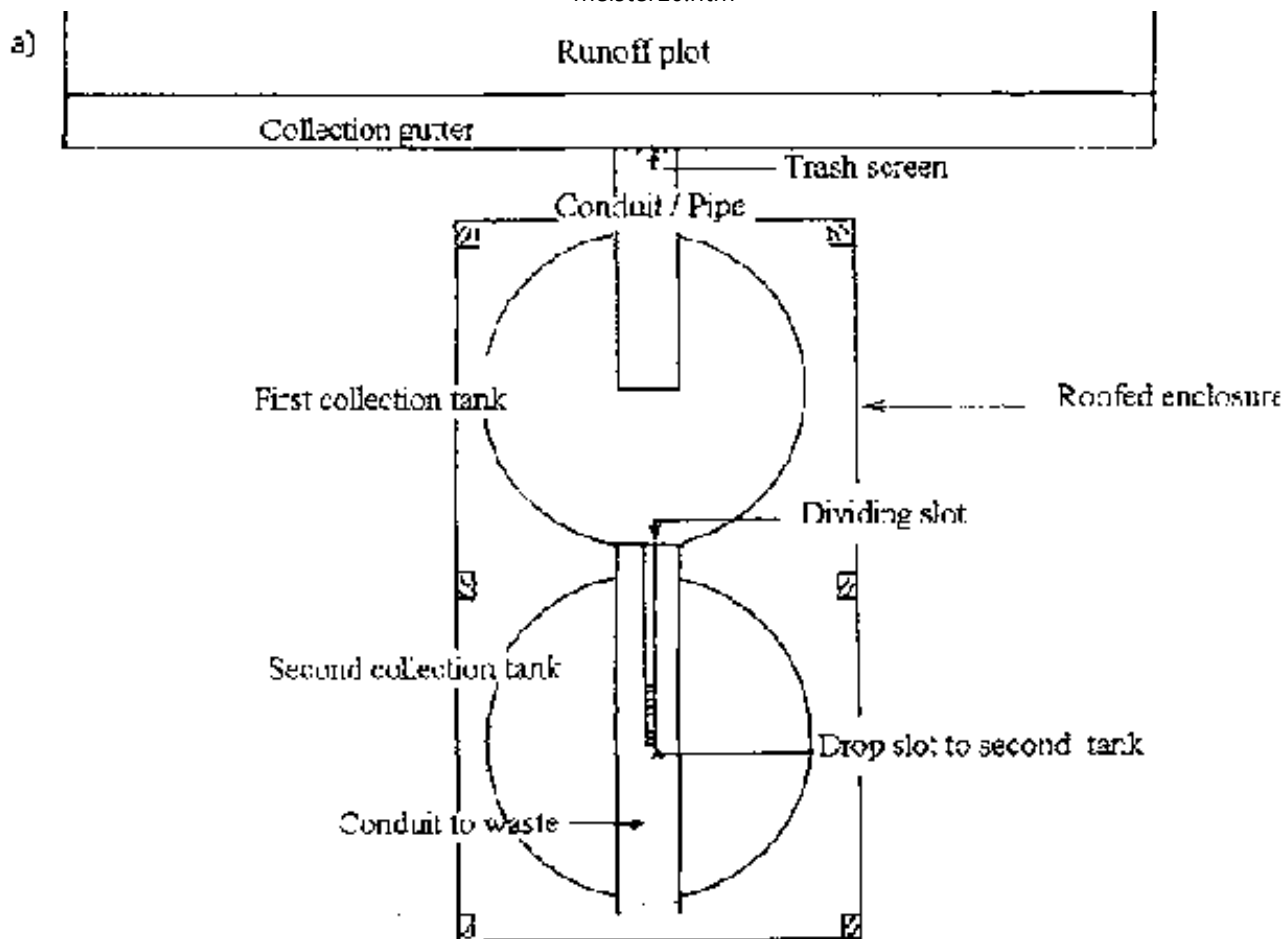


meister10.htm

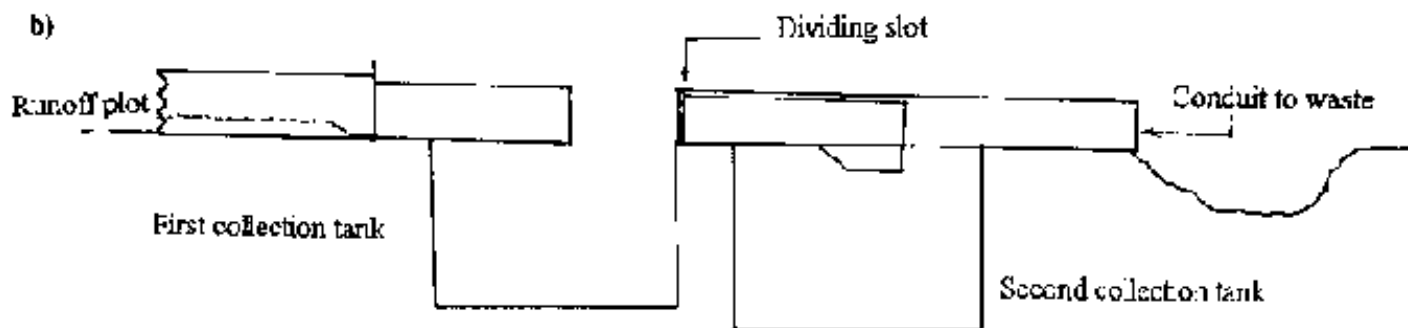
No. Slots	Width (mm)	Height (mm)	Max. Capacity ( $l\ s^{-1}$ )
3	13	100	2.5
5	13	100	4.3
7	13	100	6.0
9	13	100	7.7
3	25	150	9.4
5	25	150	15.7
7	25	150	21.9
7	25	200	34.2
9	25	200	42.7
11	25	200	54.0
11	25	300	97.0
13	25	300	114.0

**Table 2.18: Approximate Number, Dimensions and Capacities of Divider Slots**

**Figure 2.12: shows a typical arrangement for a multislot dividing system. Construction details are given in Appendix**



**Figure 2.12: Multislot Divider System a) Plan b) Side Elevation**



**Figure 2.12 continued**

**Where the materials and workshop facilities are not available to manufacture a multislot system, a cheap alternative "multi-pipe" divider can easily be made, so long as basic welding equipment is obtainable. The system uses 200 litre oil drums, sheet steel and neoprene pipes. Calibration, as described later in this section, is essential for this system.**

**A metal box, with a handled lid, is welded from cut pieces of steel plate. On one side, a rectangular section, approximately 15 cm square, is cut out to accept an intake gutter. Ten 5 cm. stub pipes are welded over 5 cm. holes cut into the opposite side of the box to the intake, to form spouts. A 200 l drum (usually 90 - 100 cm high), is cut into two portions, the first 60 cm and the second 30 cm high or thereabouts. One 5 cm hole is cut into the side of the larger piece of drum, leaving a freeboard of 5 - 10 cm. A short metal stub pipe is welded on to the hole to form an intake. On the opposite side of the drum ten 2.5 cm spouts are fitted radially in the same way, at a slightly lower level than the intake. A 2.5 cm intake pipe is fitted on the smaller piece of drum. The box, large section of drum and small section of drum are fitted together with the neoprene pipes. All containers should have lids to prevent direct rainfall from entering them. The nine spouts that are not connected act as waste drains. The containers should be leveled when installed.**

**Figure 2.13 below shows how the containers are fitted together. All dimensions of containers and pipes are approximate and can be altered to suit locally available materials. The number of pipes can be selected according to need.**

## **Installation**

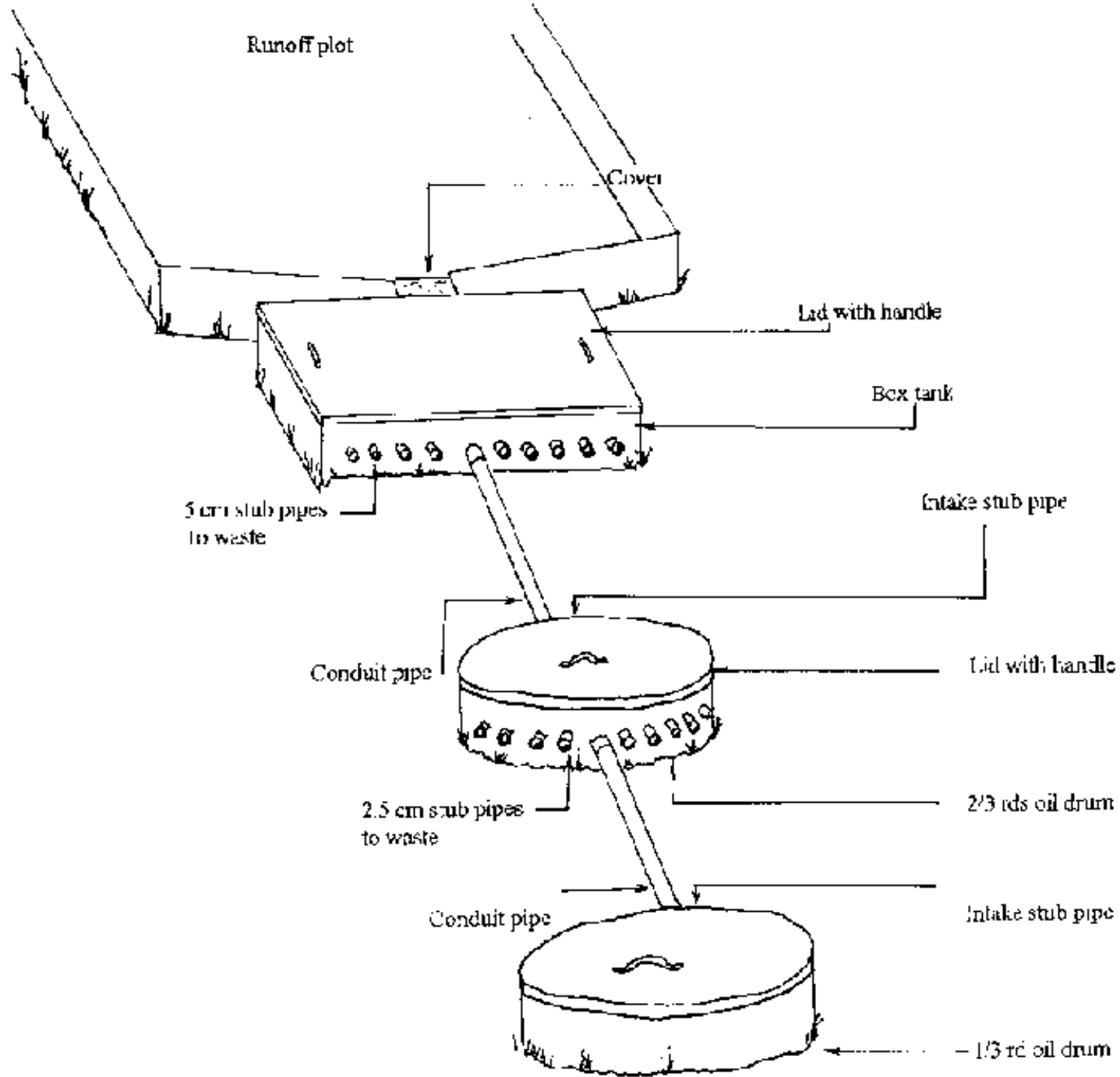
**The installation of a system requires care more than expertise.**

**Large tank sets (Figures 2.13, 2.16 and 2.17) must have the site completely prepared by earth-moving if necessary, beforehand. All the tanks in the series should be carefully placed into their excavations and the conduits fitted. They should be leveled and completely assembled together before being set in concrete, where appropriate. All conduits should be leveled.**

**Where lowering of the tanks may be necessary later, for instance if the surface of the plot is expected to erode as part of the experimental intention, tanks should not be concreted in but placed on durable stands, the elevation of which can be reduced. Multi-pipe systems are best in such circumstances, because they are smaller. Great care should be taken not to distort the dividing system on installation. The system should be protected from rain and runoff as soon as possible, where open tanks are used.**

**The free flow of water, with no ponding, from all tanks in the series should be ensured. Calibration should not be attempted until the concrete is set, or the tanks are secured to their stands. Procedures for the small tank system are essentially the same, but less labour will be required and alterations to the site can be made during installation.**

**The detailed procedures of calibration are given below.**



## Figure 2.13 Multipipe Divider System

### Calibration

**Calibration is straightforward, though the large tanks will need several oil drums of water.**

- Ensure the tanks are firmly set in the ground and all the components are secure.**
- Ensure the outlets are as level as possible**
- Ensure the whole system is clear of debris.**
- Ensure all seals are water tight**
- Fill the first tank with water until it overflows to a small degree into the second tank.**
- Ensure there is no ponding between the tanks.**
- Remove any water from the second tank**
- Using an accurately graduated vessel ( for example 10 litres), pour water carefully into the (primed) first tank.**
- Record the amount poured.**
- This should be repeated until an easily recoverable quantity of water can be**

**removed from the second tank. The waste water from the first tank can be ignored, but ensure that it flows away from the site easily.**

- Measure the water recovered from the second tank.**
- Repeat the process but start by filling tank 2 and measuring from tank 3**

**The calibration factor of the tanks, or more correctly the dividing system is then the ratio: Water Poured / Water Recovered.**

**For example:**

**Tank 2**

**275.0 litres / 25.6 litres,**

**Calibration Factor (C.F.) = 10.74**

**Tank 3**

**109.0 litres / 11.2**

**Initial Calibration Factor = 9.73**

**Actual Calibration Factor- CF Tank 2 × CF Tank 3, therefore = 10.74 × 9.73 = 104.50**

**All quantities runoff measured from the second tank should be multiplied by the calibration factor to calculate the true runoff volume. A mean value should be obtained from a number of calibrations undertaken for each tank. For a series of three tanks, the same procedure is followed. The total runoff from rainfall represented by the portions actually collected in all the tanks would be (for the examples given above):**

**Runoff from tank 1 × Calibration Factor ( = 1.0) + Runoff from tank 2 × Calibration**

**Factor (= 10.74) + Runoff from tank 3 × Calibration Factor (=104.5).**

**Routine data collection sheets for a multiple tank should be prepared in a manner similar to Figure 2.14:**

Date...01.9.92.....		Station...Agric. Res. Centre.....		Group...2.....	Tank set.....A.....		
Rainfall.....33.2 mm.....		Time started.....12.09.....		Time read.....12:06.....		Time finished.....13.25.....	
<hr/>							
Tank	Size & No. full measuring vessels						
Set ...A....							
No.	20 litres	5 litres	1 litres	0.5 litres	Total Litres	Calibration Factor	Calibrated Litres
1	X11111 11111	X11111 11111	XX1111	11111	27	1.0	27.0
2	11111	11111	XX1111	X11111	2.5	10.74	26.9
3	11111	11111	11111	11111	0.0	104.50	0.0
<hr/>							
Reader .....	L. Shaw.....					TOTAL 53.9	

**Figure 2.14: Collection tank data sheet example**

### **b. Rotating Slot (Coshocton) Divider**

The rotating slot divider is a much smaller device than the equipment that has been described above, but involves a high degree of precise manufacture. Welding must be accurate and discrete, bumps and distortions of the metal wheel must be avoided. High quality bearings are needed. Detailed drawings for the construction of this runoff sampler are given in Appendix A3. Figure 2.15 shows a sketch of the



**mechanism fitted below an H flume.**

**Runoff is directed from a collection conduit and pours over a horizontal sampling wheel, the slot divider. The action of the water forces the wheel to rotate and the sample slot cut into the wheel continually passes under the water then away as the rotation continues. Runoff that goes through the slot enters a sump and then is conducted away to a collection tank. That which does not pass through the slot, runs to waste.**

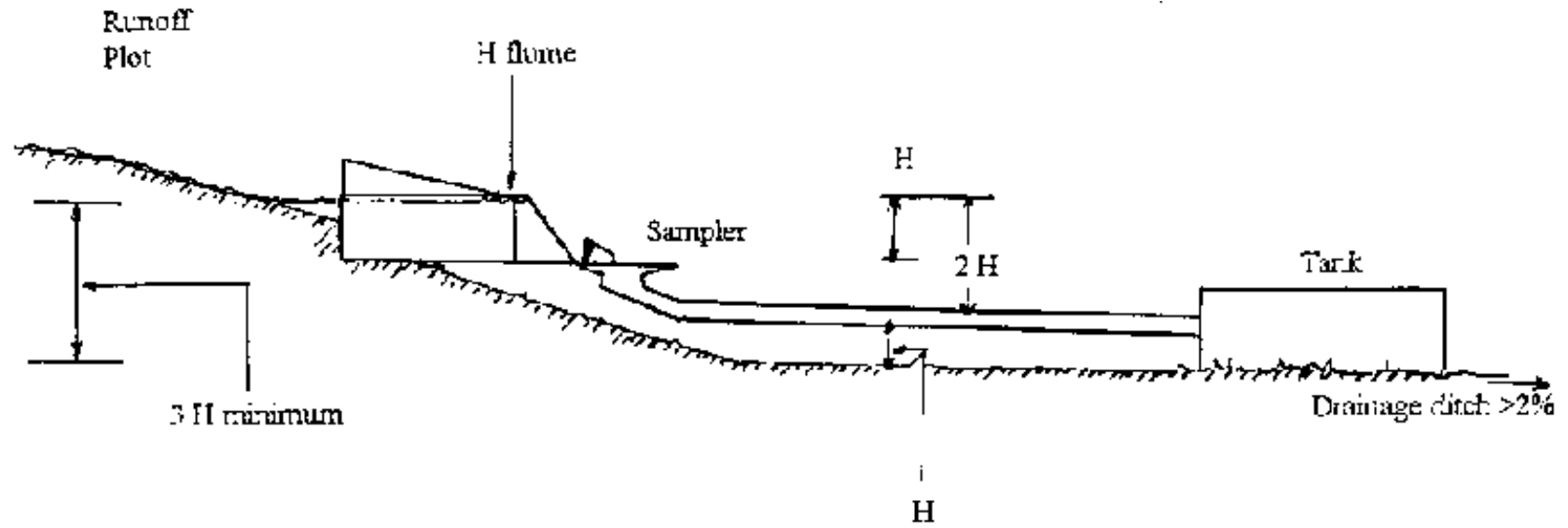
## **Installation**

**Plot design and collectors are as described above.**

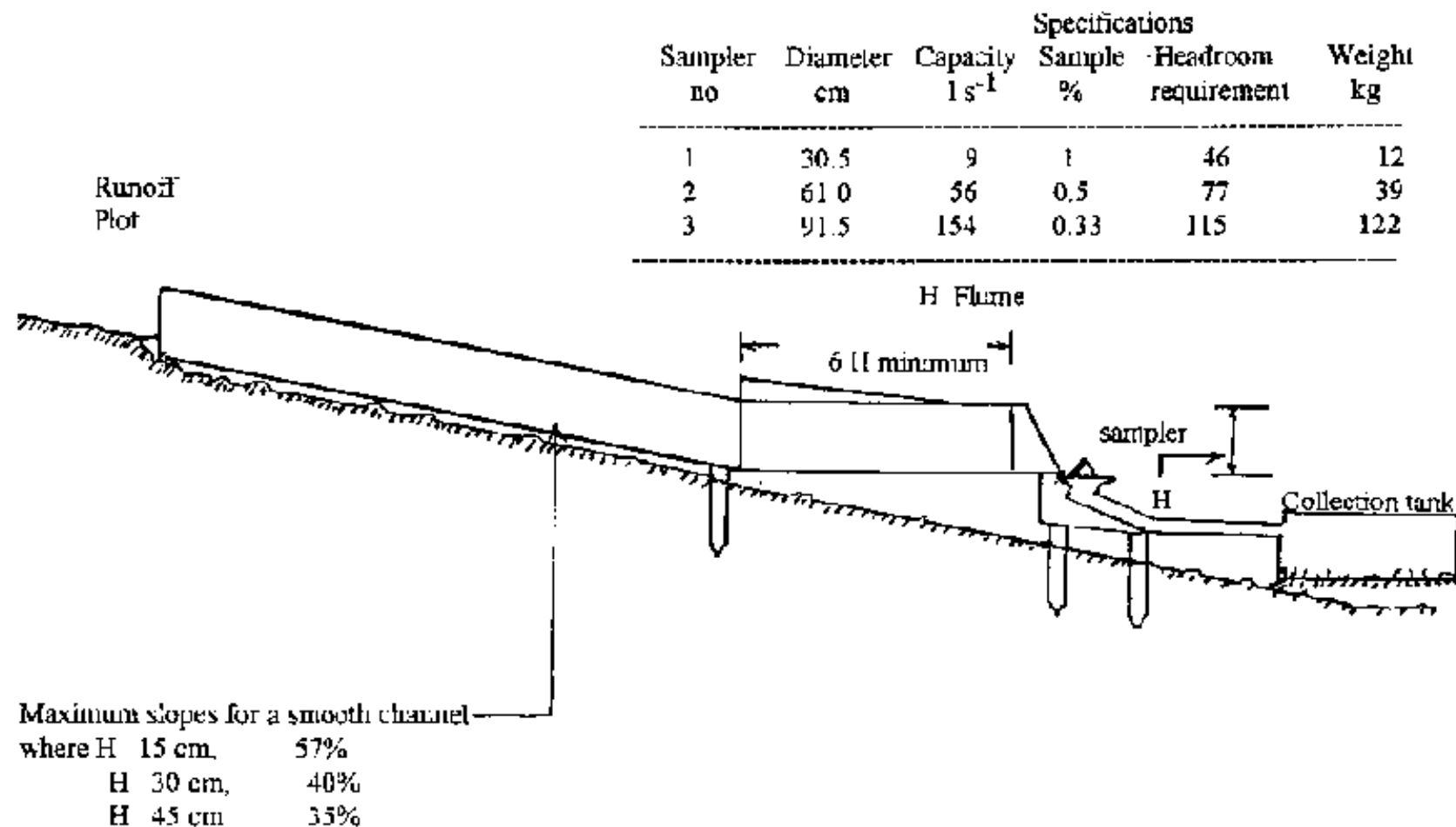
**Installation design often depends on the land form of the runoff area.**

**Figure 2.17 shows an example.**

**The complex tank systems described above are frequently used for sampling sediment load and the combination of runoff and sediment measurement is obviously a cost-effective manner of organising activities, the value of which should be carefully considered at the planning stage of any project.**



**Figure 2.16**



**Figure 2.17**

**Figures 2.16 and 2.17 Alternative Installations of the Rotating Slot Divider Source: USDA Handbook 224**

### 2.2.2 Collection of Data from Continuous or Flow-through Systems

**Flow-through systems are used where catchments provide too much runoff to be collected in tanks. They are also necessary where knowledge of the start, the duration, peak and end of flow of runoff (the flow hydrograph), is needed. These**

**systems are particularly useful at remote sites, where visits cannot be made after every rain storm. In humid climates, they can be used to make continuous readings of permanent streams. Measurements are made at a control section with known hydraulic properties, where the flow volume can be measured simply by recording the depth (stage) of water passing through the control section at any time.**

**Controls fall into two main categories:**

### **Natural controls**

**exploit the physical features of the stream channel or other waterway, (be it ephemeral or permanent) to provide a location for the measurement of flow. This is not as simple as it may appear.**

**Artificial controls are made to pre-designed specifications, according to their use and are placed where required. There are many designs of artificial control.**

**In general, the most useful controls for work in agrohydrology and water harvesting are artificial. However, it is possible that natural controls may be used of necessity, especially where natural channel flow in large amounts is present. These volumes of water may be too large for the use of a pre-calibrated device or conditions may be unfavourable for its operation. The cost of building artificial controls on any but the smallest river channels will probably be prohibitive.**

#### **2.2.2.1 Natural Controls for Flow Measurement and Stream Gauging**

**The first problem to overcome is the identification of a suitable site. Bends in channels should be avoided. Eddying and spiral flow occur and cause changes in the**

**river bed and the undercutting of banks, making such locations unsuitable. Straight sections of channel are desirable. Sites should be located where the bed is as uniform as possible, away from tributaries and other flow disturbances. Changes in vegetation, human activity etc. can all affect the control at a site.**

**The effects of controls (the influence of the channel having a particular form that restricts flow) can be present at low water, high water or may change as the depth of the river alters in flood. Usually low water controls become ineffective as stage increases. Contracted sections such as bridge openings may operate at highwater which may be a disadvantage, though bridges are frequently convenient access locations for measuring stream discharge.**

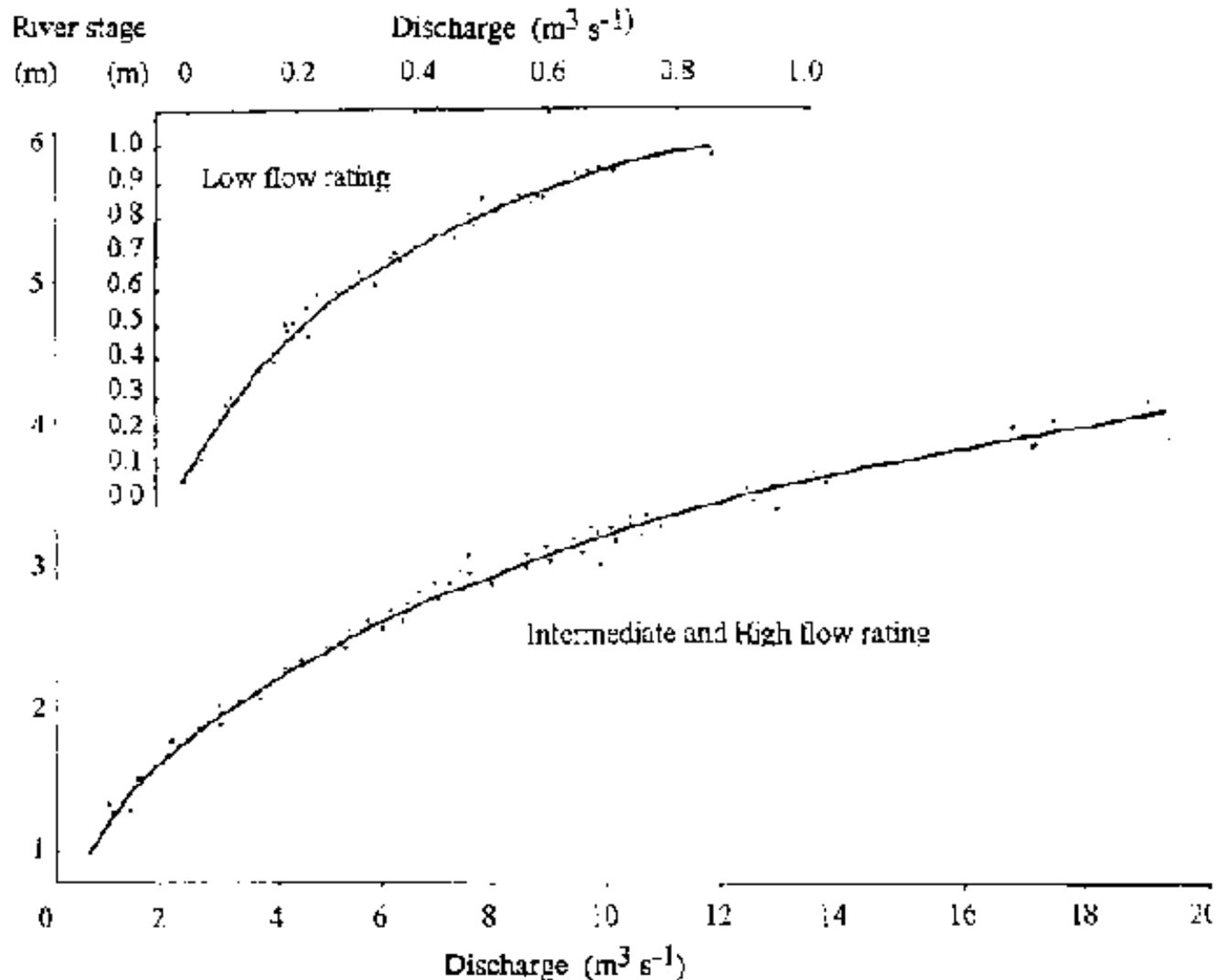
**At gauging sites, locations where frequent flow measurements are made, gauges that facilitate the recording of stream depth are placed. If possible, an automatic water level recorder and manually-read posts are used, though this is expensive. Where a continuous record of stage is not required, manual posts alone are sufficient. The hydraulic properties of a natural channel, which must be determined to allow the use of stage-only recordings to measure flow, are defined by rating curves, sometimes by rating tables.**

## **Rating Curves**

**A rating curve is a calibration curve, a graph of the relation between stream depth (stage) and flow (discharge). Obviously, as stream depth increases, so does discharge. However, this relation is unique at each location on the channel and is rarely if ever a straightforward linear relation. When sufficient depth/discharge data are collected (see below) to define this relation, unknown discharge can be found by simply reading the known depth from the rating curve. Further discharge**

**measurements are taken on a routine basis to up-date the rating curve. This will be necessary if the stream channel changes, for example after a severe flood. It is a serious problem for short-lived projects that it may take many years to compile a rating curve which, of necessity, should include a wide range of discharge, from low to high.**

**A typical rating curve will be similar to Figure 2.18. The relation can also be defined in a rating table, which allows more convenient use in computer programs. Note that the curve will plot as a number of straight lines when logarithmic axes are used, indicating a change of control at the inflection point(s) as stage/discharge relations change.**



**Figure 2.18 Example Rating Curve**

**Data points collected after the compilation of the rating curve, should lie within 10% of the curve. Values that do not, indicate a change in control of the river section or large measurement error. Values not within +/- 2% of rated discharge can indicate that re-drawing of the curve may be necessary in some circumstances, but it is assumed here that moderately accurate values of discharge are satisfactory,**

**and that agricultural and water harvesting projects will not wish to invest the time nor resources to delve deeply into the theory and practice of hydrometry, nor undertake the rigorous field schedule of data collection that would be necessary to achieve wholesale rating curve revision. A simple stage/discharge plot should be adequate to define the relation.**

**From a graph such as 2.18, the flow hydrograph can be obtained from a continuous reading of stream height.**

**There is no easy way to extrapolate extreme discharges from a rating curve and although the general equation of any curve is assumed to be  $q = k (g - a)^b$ , where  $a$ ,  $b$  and  $k$  are site constants, this formula cannot account for changes of channel geometry at higher stages and an abrupt discontinuity of the relation will be seen when bank-full conditions are experienced; that is when the river floods and is no longer confined to the channel.**

**Stream gauging procedures measure the stage and discharge of a stream and provide the basic data for rating a channel location. Rough estimates of discharge for different stages can be made by taking the cross-sectional area of the channel and multiplying the channel area by stream velocity. Values of velocities can be estimated by using Manning's equation (see later in this chapter).**

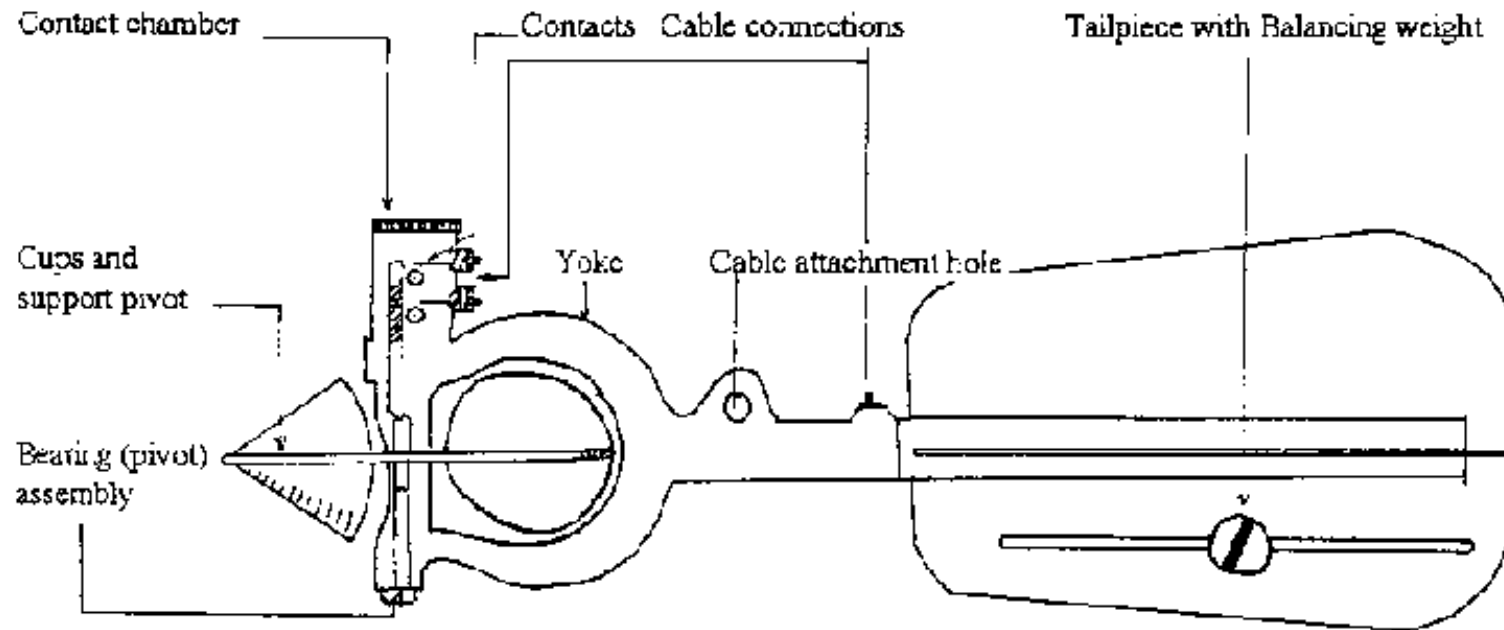
## **Methods of Flow Measurement**

### **a. Velocity-Area method**

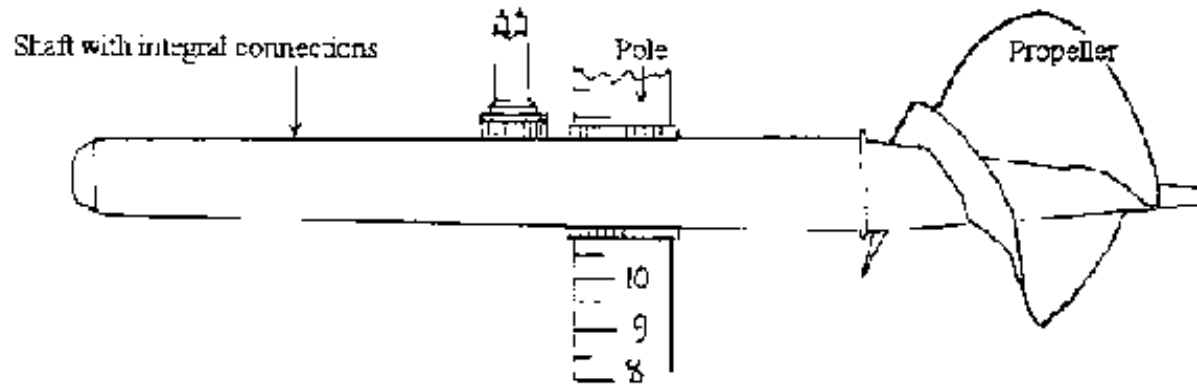
**This most accurate and usual method uses a current or flow meter and associated equipment. The meter consists of a set of horizontally mounted cups (vertical axis)**



that move a contact breaker as they rotate. This breaker, wired to a battery and either an automatic counter or head phones, registers each rotation of the cups. Each meter is individually calibrated and provided with a table (usually) fixed to the carrying case. This table is used to convert the number of rotations per time period into flow velocity in feet or metres per second. For very small streams or highly vegetated conditions a horizontal axis propeller-type meter is used, but the method of measurement is the same for both instruments. Figures 2.19 and 2.20 show typical cup-type and propeller meters.

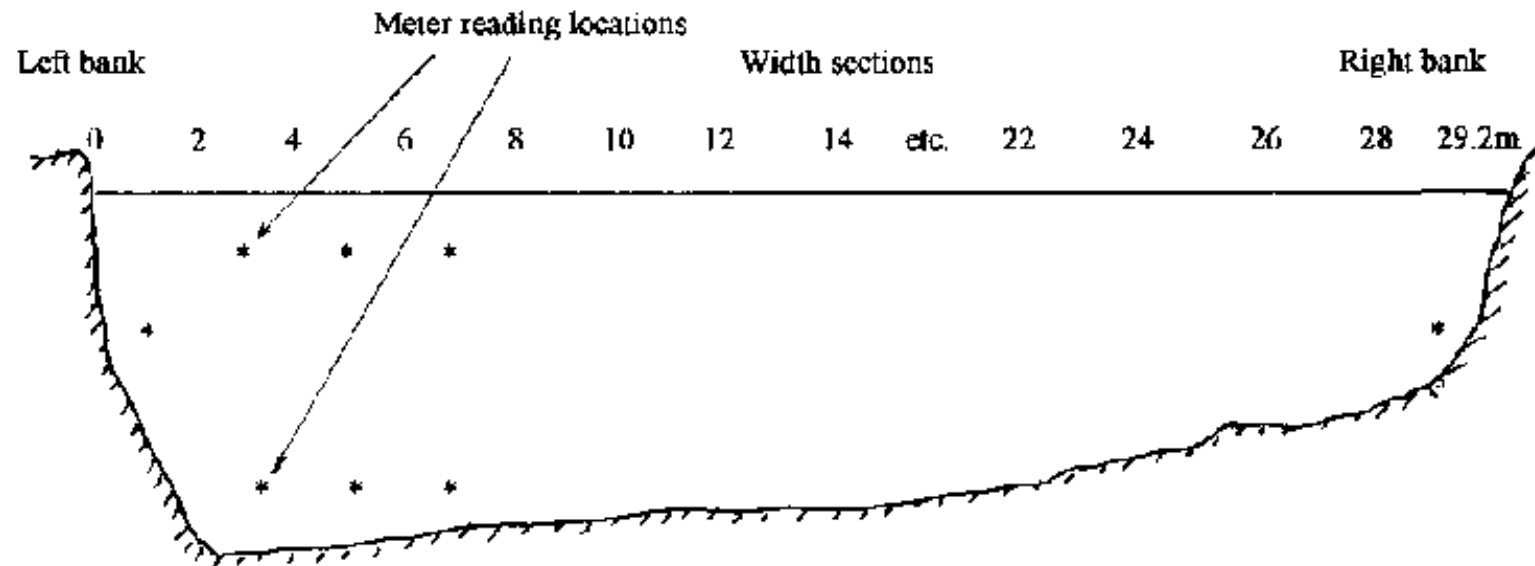


**Figure 2.19: Typical Cup-type Flow Meter**



**Figure 2.20: Propeller-type Flow Meter**

**A marked cable or tape is stretched across the stream channel at the gauging site, at right angles to the flow. The tape is used to divide the stream width into convenient sections. In Figure 2.21 below,  $14 \times 2.0$  m sections are used, starting from the initial point (0) on the left bank. This leaves one section of 1.2 m at the right bank, to complete the full stream width of 29.2 m. To ensure a sufficient number of velocity readings across the stream width, no section should be greater than 10% of the total width, where possible 5% gives greater accuracy. The subdivision of the channel width allows the measurement of the different velocities and discharge within each section, due to friction and eddying. On the other hand, the time taken to complete the procedure should not be too lengthy, because minimum change in stage of the stream, during the time of gauging, is desirable. Any large change in stage can cause an inaccurate measurement of discharge, unless corrections are made. These are quite complicated and best avoided. Stage readings should be taken from the staff gauges located at the site, before starting and after completion of discharge measurements to check for excessive change of stage.**



**Figure 2.21: Velocity-Area Method**

**Figure 2.21, shows the arrangement of channel sections used in the velocity-area method. The flow meter is positioned at 0.2 and 0.8 times the vertical depth of the water, pointing against the flow. At each position the number of rotations in a given time (or given number of rotations in a measured time) is counted and the velocity calculated from the calibration table of the flow meter. The average velocity of the two readings is taken as the overall average velocity of the whole vertical section. The distribution of velocities from bed to surface in a stream is parabolic and the average of the two measurements gives an accurate measure of true mean velocity.**

Stream ..... **Sihun** ..... Gauging location ..... **Madiba** .....

Measurement rated : Excellent (2%); Good. **(5%)**; Fair (8%); Poor (< 8%)

Based on: ..... **mid stage, smooth flow** ..... Spin test before measurement ..... **good** .....

Date ..... **26.03.93** ..... Time start ..... **10: 45** ..... Finish ..... **11:28** .....

Stream Gauge Height Before Start... **2.78** ..... (m) Finish..... **2.77** ..... (m) Change... **- 0.01** ..... (m)

Distance from initial point (m)	Width of section (m)	Depth (m)	Obs depth (m)	Revs No	Time (sec)	Velocity		Area (m <sup>2</sup> )	Discharge (m <sup>3</sup> s <sup>-1</sup> )	
						At point (m s <sup>-1</sup> )	Mean in vertical (m s <sup>-1</sup> )			
1.0	2.0	0.9	0.6	10	58	0.24	0.24	1.80	0.43	
3.0	2.0	1.7	0.2	24	45	0.45				
			0.8	26	46	0.47	0.46	3.40	1.56	
5.0	2.0	2.2	0.2	34	52	0.68				
			0.8	30	54	0.62	0.65	4.40	2.86	
"	"	"	"	"	"	"	"	"	"	
28.6	1.2	0.4	0.6	7	64	0.09	0.09	0.48	0.04	
<b>TOTALS</b>								<b>29.2</b>	<b>26.43</b>	<b>37.67</b>

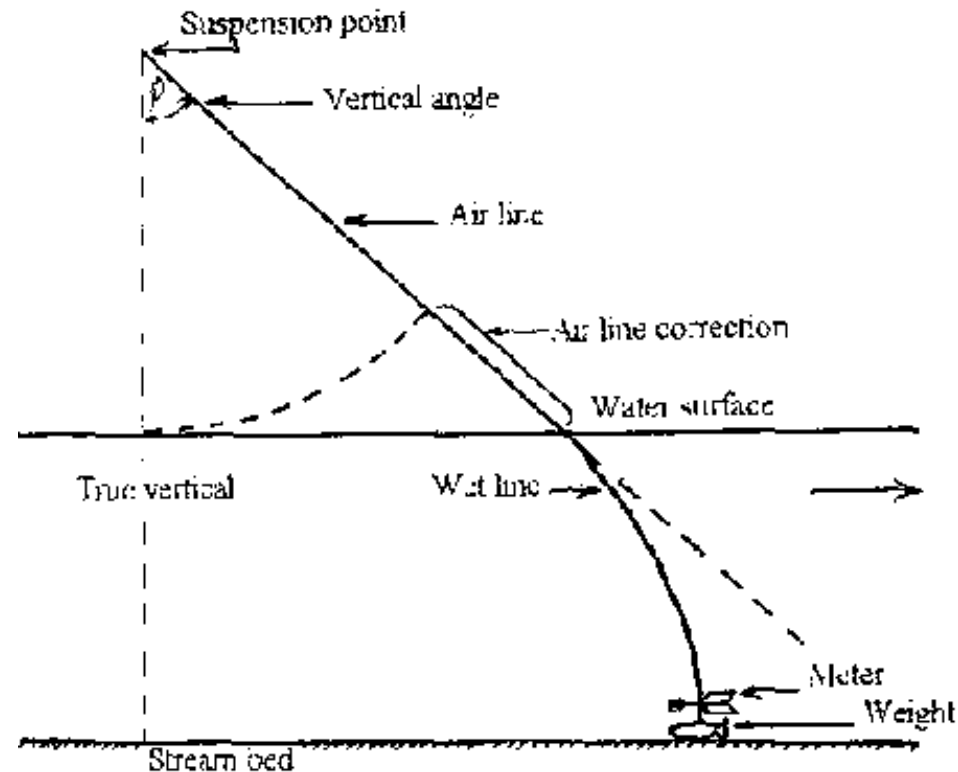
Observer .... **S. Walsh** .....

**Figure 2.22: Sample Discharge Measurement Form**

The depth of the stream is noted from the graduated bar that holds the current meter. The procedure is followed for all the sections of the stream. Where the stream is too shallow (< 0.50 m) to allow two velocity readings to be taken, the 0.6 of stream depth position, below the stream surface, alone is used. Calculations of depth, velocity and thereby, discharge are made as illustrated in Figure 2.22.

In some cases, usually when the river is at a high stage, wading the stream to effect measurement will be impractical. In such circumstances a bridge or other

**convenient structure must be used. Readings are taken with the meter suspended from a cable and held down by a large, streamlined weight. The current will carry the instrument downstream and it will not hang vertically, but a small correction can be made to overcome this. With the cable  $12^\circ$  from the vertical the inaccuracy of measured depth is about +2%, but corrections will depend on exactly how much cable is paid out and how much is in and out of the water. A table can be drawn up and used, according to Figure 2.23 below.**



**Figure 2.23: Geometry of a Cable-suspended Flow Meter**

## Operation and maintenance

**On the whole, the equipment is easy to operate and maintain. Regular oiling of the**

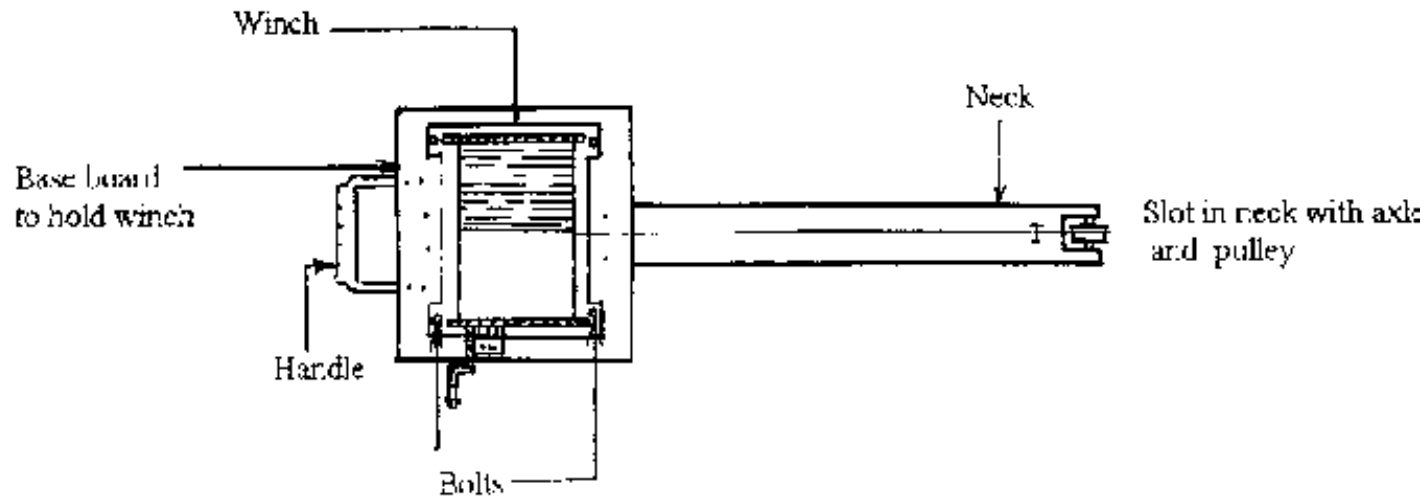
**cup bearings with light lubricant is essential (sewing machine oil is a good substitute if manufacturers' oil is unavailable, but do not foul the contact points) and spare bearings and a spare set of cups should be purchased. The cups in particular should be treated with care as any damage will alter the rating of the instrument. Equipment should be cleaned and dried after use. The electrical contacts should be kept clean as they tend to burn out at the tips with use. Propeller meters usually have bearings of synthetic plastic material and usually should not be lubricated.**

**It is desirable for current meters to be re-calibrated by the manufacturer or a hydraulics laboratory every few years, therefore careful use of the equipment is essential if this costly inconvenience is to be kept to a minimum.**

**Equipment suspended from a bridge or similar structure will necessitate the use of a winch. This is purchased with meter weights, cable and fittings and will include an integrated depth-counter. A simple board can be made to which the winch can be fixed for manual operation. Figure 2.24, below shows a vertical view of the winch board.**

**It is suitable for use by one person with all but the largest of weights used for very large rivers. Some help may be needed when the weight and meter is lowered over the side of the bridge. Purchased stands for winches tend to be expensive and large.**

**It assumed that suspended cable ways, which are sometimes used in operational hydrology, will be far beyond the resources of an agrohydrological or water harvesting project and that less accurate but cheaper methods of flow volume estimation, such as float-gauging would be more appropriate. Inflatable dinghies are not too expensive, but the need for an outboard motor adds to the cost.**

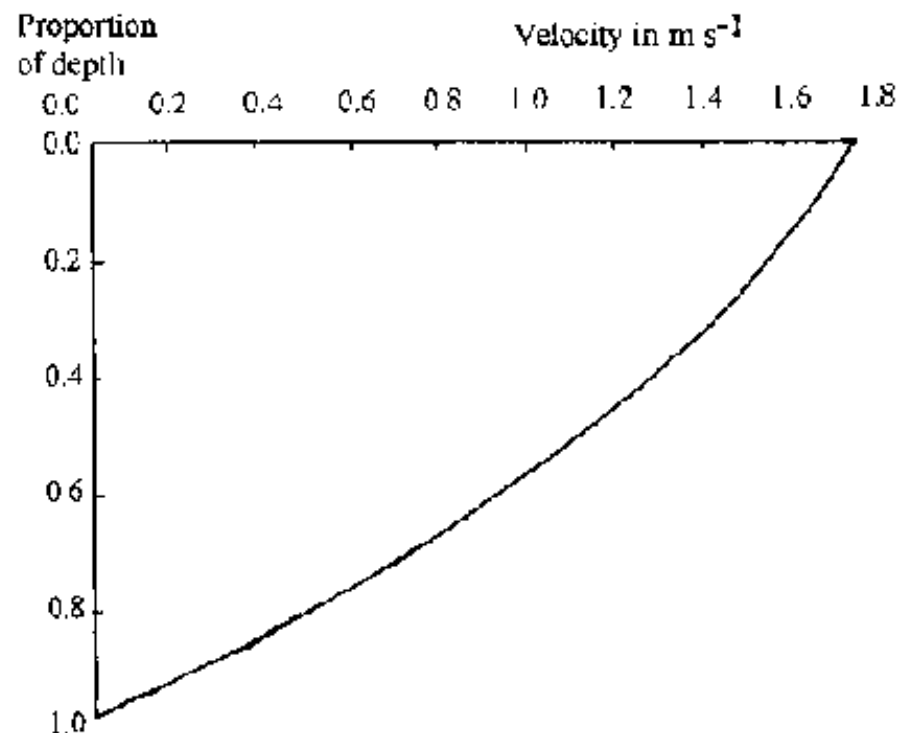


**Figure 2.24: Simple Hand-held Winch Board**

## **b. Alternative methods of discharge estimation**

### **Float gauging**

**This method probably provides the most suitable alternative way to measure stream velocity and discharge. Surface floats travel at about 1.2 times the mean stream velocity. See Figure 2. 25 below which shows the distribution of stream velocity with depth.**



**Figure 2.25: Depth / Velocity Relations of Stream flow (Velocity Profile)**

**Floats should be clearly visible and of uniform size and material. A straight stretch of channel should be used to avoid velocity changes and eddy currents. Where possible, changes in velocity should be accounted for by placing floats across the width of the stream. Several floats should be used and average reading taken.**

**Remember that a cross-sectional profile of the stream with depth measurements to calculate area will be essential to allow the computation of discharge. This will require a survey of the channel at a later date. Permanent staff gauges can be emplaced and a rating curve determined. This method may be useful when a river is at a very high stage and impossible to gauge by the velocity-area method. In general the cost of an automatic water level recorder to measure river stage would**



**not be warranted if float gauging is used to the exclusion of more accurate methods.**

**Chemical gauging, whereby salts, dyes or radioactive materials are introduced into river flow is sometimes used. With this " dilution" or "tracer" method, a concentration  $c_t$  of the tracer is injected into the flow at a rate  $q_t$ . Downstream, samples are taken when equilibrium concentration  $c_c$  has been achieved and the discharge  $q_t$  is**

$$q_t = (c_t/c_e - 1) q_t \quad (2.18)$$

**Methods of concentration determination however, involve expensive detection equipment that would not be appropriate to most projects.**

### **Stream Flow Networks**

**It is likely that a project that measures stream flow will require a number of stations, but at the same time will need to keep down costs. A basic network should consider:**

- Determination of the minimum catchment area to be monitored, perhaps as large as 250 km<sup>2</sup> per station in developing regions .**
- A station should always be located at the catchment outlet.**
- Gauging of major tributaries should be undertaken.**
- Locations/streams of particular significance such as those in areas of future development should be targeted.**

- Regard should be given to the kind of use the information will be put to: flood forecasting; irrigation development etc.**
- A good sample of hydrological, topographical and geological types could be monitored.**
- Probability forecasts are usually an important factor in collecting stream flows and the longer the station records, the better.**
- However, if budgets are severely restricted, then stations can be moved after 5 or 10 years and synthetic data derived thereafter.**
- Where possible sites should be located near bridges etc. for ease of measurement and instrumentation and should have good, all year access.**
- Gauge height readings from manually-read, graduated posts will require a site reader.**

### **2.2.2. Artificial Controls for Runoff Measurement**

**Natural controls are limited by the occurrence of natural channels, whereas artificial controls can be placed wherever there is need for them. This can be in natural channels if desired, but bunds and channels can also be installed to bring dispersed surface flow to a point suitable for measurement. Furthermore, artificial controls are pre-calibrated with known rating curves which do not have to be compiled using flow-discharge information. These advantages make artificial control structures the most suitable for agrohydrological applications. There are many designs of artificial controls, each developed to be suitable in different circumstances and it is**



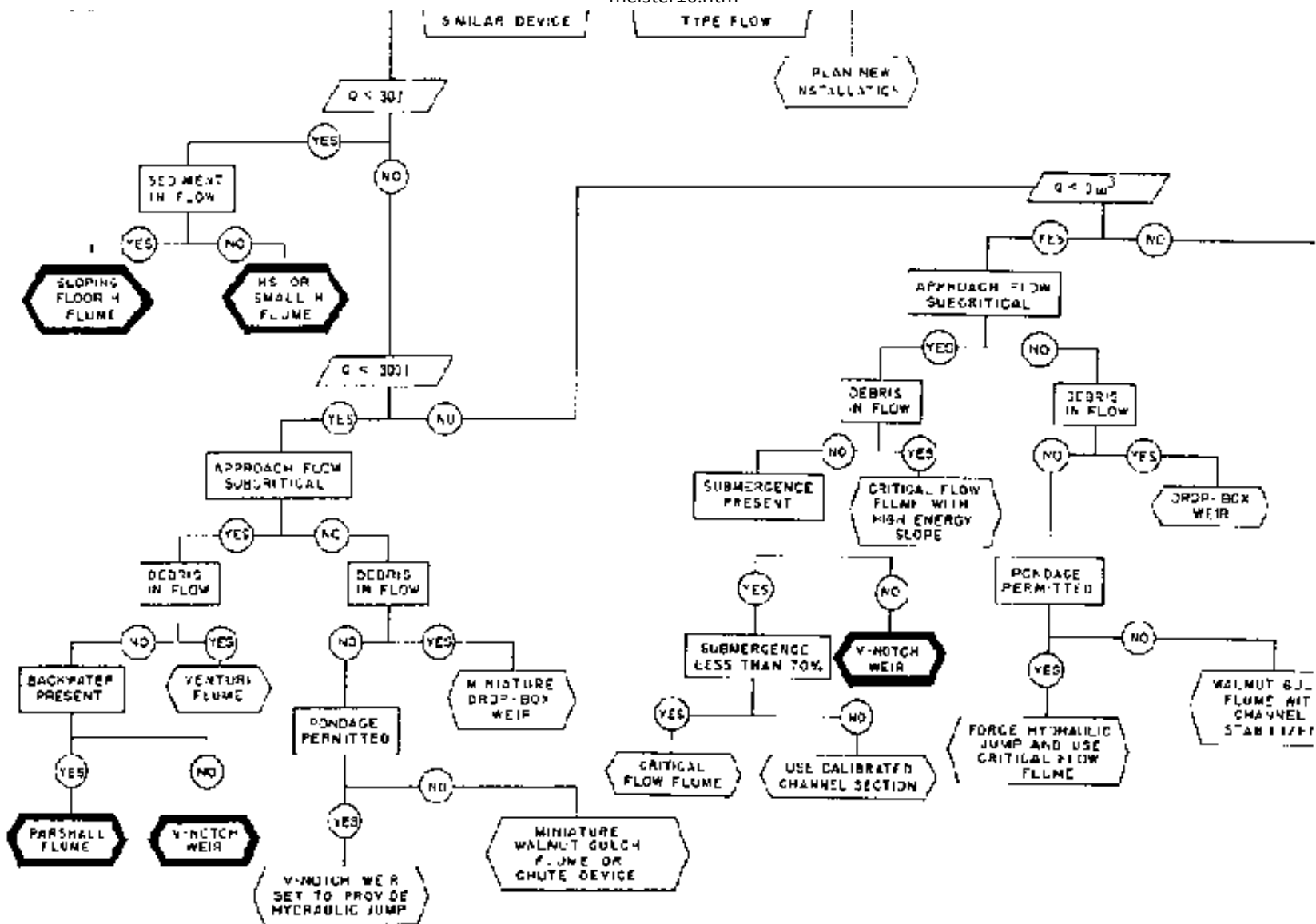


Figure 2.26: Selection of Artificial Control Structures

Situations may be encountered where small structures are inadequate, and examples of large artificial controls are given, but in less detail. These are minor works of civil engineering and their construction is usually undertaken only by River

**Authorities and similar organizations. They are costly and permanent, but in some situations may be essential if stream flow data are to be collected where natural controls are unsuitable. Any project proposing to enter into the construction of such controls is urged to approach the relevant Authority and seek advice as to those which have proved most suitable for local conditions, their likely cost and problems of installation.**

### **2.2.2.1 Flumes**

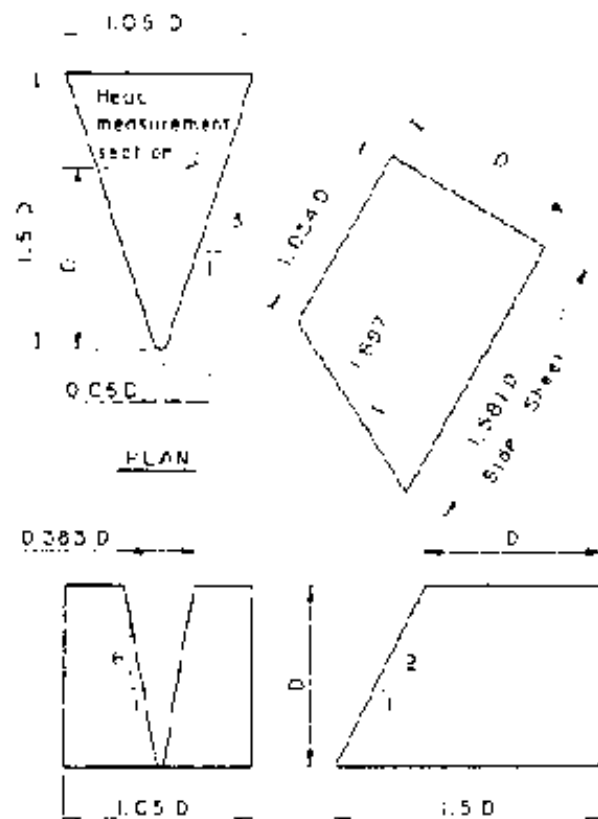
**Flumes are essentially long, box-like structures that allow the flow of water to retain or increase its kinetic energy as it passes through them. They have the advantages of being able to measure small flows accurately while allowing debris and sediment to pass. They can be made light and portable and can be located in most situations. They may be fitted to small experimental plots which do not have natural channels, or be placed in stream beds. They are probably the most suitable of all artificial controls for agrohydrological applications.**

#### **a. H, HS and HL flumes**

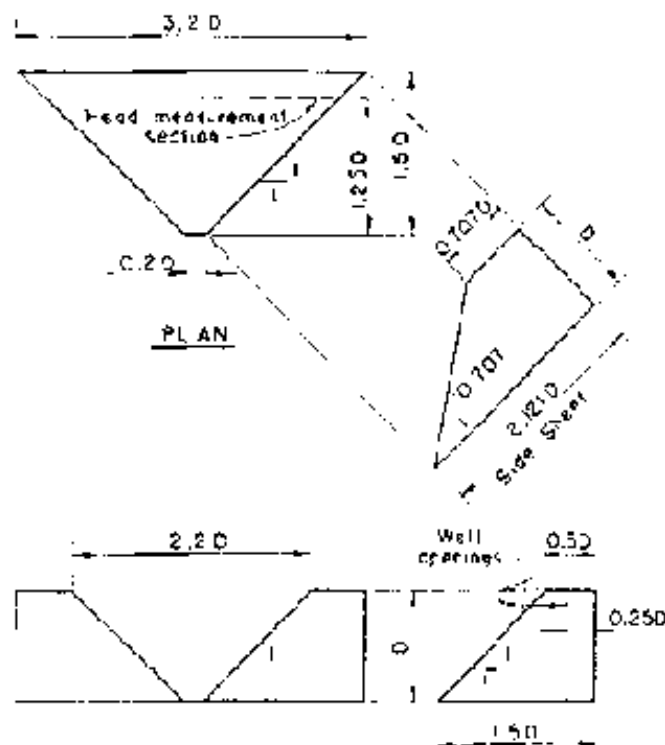
**The H flume is the basic instrument of this group. HS flumes are designed to measure very small flows accurately (flows  $< 28 \text{ l s}^{-1}$ ), while HL flumes are capable of measuring much greater flows (up to  $3.3 \text{ m}^3 \text{ s}^{-1}$ ). The materials from which they are made, their installation and operations are similar to the H flume, though their dimensions are somewhat different. H flumes fill a wider niche of runoff measurement than HS and HL flumes, therefore this section will discuss them in detail. The design criteria of HS and HL flumes are given below in Figures 2.27 and 2.28. Rating tables for the conversion of recorded stage to discharge are given in Appendix A1. The main point to note is that the dimensions and quality of**

**manufacture strictly determine the rated capacities of the flume, therefore they should be made as accurately as possible to retain the correct rating characteristics.**

## HS and HL Flumes



**Figure 2.27: Design Specifications of HS Flume**



**Figure 2.28: Design Specifications of HL Flume**

Approximate capacities of the HS flume:      Approximate capacities of the HL flume:

Depth D (m)	Capacities ( $\text{l s}^{-1}$ )	Depth D (m)	Capacities ( $\text{m s}^{-1}$ )
0.12	2.4	0.61	0.57
0.18	6.6	0.76	1.00
0.24	13.3	0.91	1.57
0.30	23.4	1.07	2.28
		1.21	3.13

Source: USDA Handbook 224

**Table 2.19: Capacities of HS and HL Flumes**

**Rating tables for these HS and HL designs are given in Appendix A1.**

## **H flumes**

**For the range of flow measurement met in agrohydrology, especially runoff plot and farmer's field studies, H flumes are very useful measurement devices, but it is important that they are manufactured and installed with precision. Figure 2.29 gives the design dimensions.**

### **Construction**

**The flume is the component of the whole structure to which the water level recorder is attached to measure stage.**

- To manufacture the flume, prepare detailed drawings of the design with the maximum capacity needed.**
- Make a paper and then a thin sheet metal template of the flume that can be used many times.**
- Use either heavy gauge galvanised or mild steel sheet that can be rust-resist painted to make the flume.**
- The thickness of metal should be appropriate to the overall size of the flume.**
- Support all edges with angle iron or structural steel to prevent warping.**
- Welded joints should be water tight, strong and ground smooth.**
- Vertical sides should be exactly vertical and made from one piece, the**



**bottom plate should contain no more than one joint and it should not be closer than 30 cm to the outlet.**

- Avoid all distortions, dents and warps when cutting and fixing plates.**
- Before installation, the flume should be checked for adherence to the proportional dimensions in Figure 2.29.**

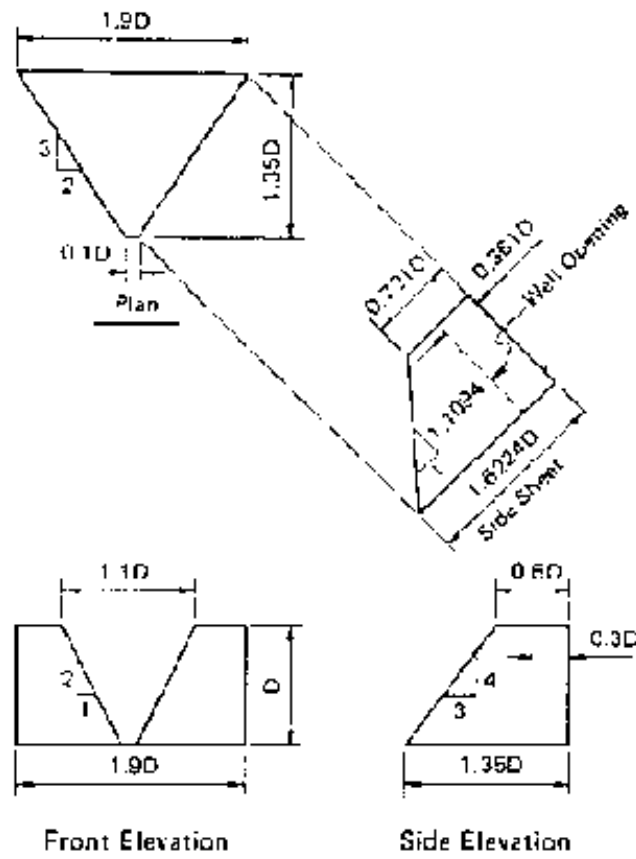
### **Approach section and stilling well**

**The flume head or measuring section acts as an artificial control to allow stage measurement, in addition all flumes need an approach section, attached to and upslope of the flume. They also need a stilling well upon which to site the water level recorder (WLR). Remember that the top of this well must be of a suitable design to take the specific manufacture of WLR. It is usually essential therefore, to obtain the WLR before the well is designed and fitted. Stilling wells are best made of the same metal as the flume and welded to the head measuring section. Openings allow the passage of water between the flume and stilling well.**

### **H Flume Specifications**

**For small flumes ( $D = 20$  to  $60$  cm), it is good procedure is to construct the approach section out of flume metal according to the specified dimensions and weld it to the flume in the workshop, with the required slope of 2%. In the field, the flume measuring section is installed with its floor horizontal (use a spirit level) and the approach section will then be set at the correct slope without further action. Such an installation has the advantage of being portable and can easily be removed for ploughing or relocation. Large flumes may require under-floor support of the**

approach section. Handles on the walls allow ease of portability (see Figure 2.30 below).



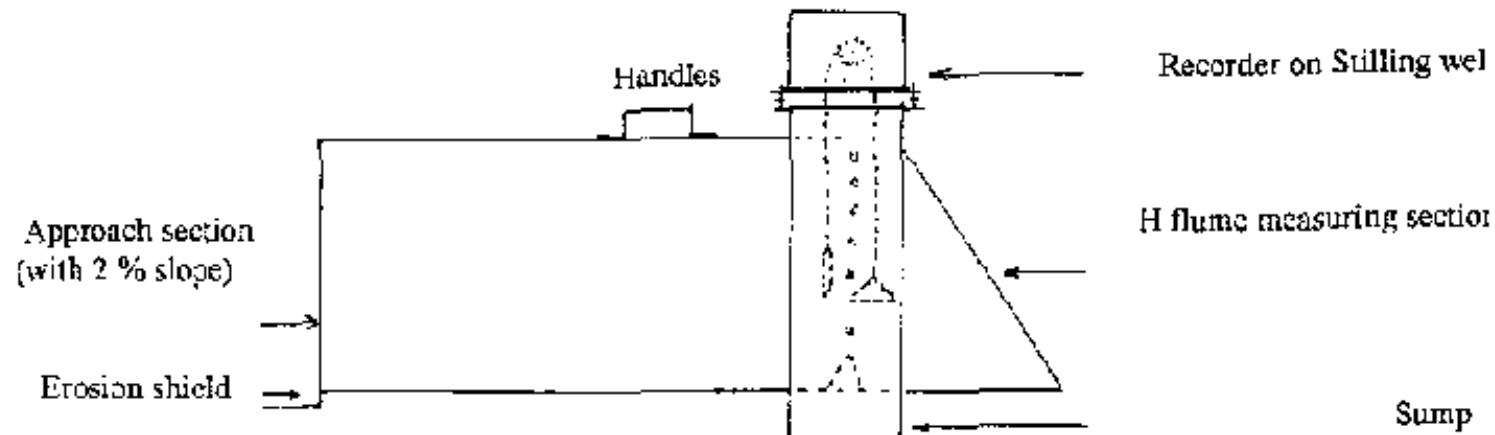
**Figure 2.29: Design of H flume**

**Note:** for flumes with  $D < \text{than } 30 \text{ cm}$ , length of flume is made greater than  $1.35 D$  to allow for float and stilling well.

**Source:** USDA Handbook 224

**For large flumes (depth 1.2 m+), construction of the approach section can be**

completed in the field using cement block walls to the appropriate dimensions in **Figure 2.32**. All block work and cement floors should be rendered smooth and the joint between flume and approach section should be well sealed. Alternatively, treated wood (tongue and groove with water tight joints) can be used for large or small flumes. This can be sheet metal-covered if preferred and makes a good, cheap temporary structure, but consider the problems of termite damage and rot.



**Figure 2.30: H Flume, Approach Section and Stilling Well**

A concrete approach floor with a 2% slope can be used, with the (metal) flume discretely bolted to it and the joint sealed. However, concrete floors do not allow the same flexibility of removal and may be problematic where installation is dependent on seasonal ploughing. In all cases, angle iron should form the sloping edges of the flume, to prevent any distortion.

### Installation

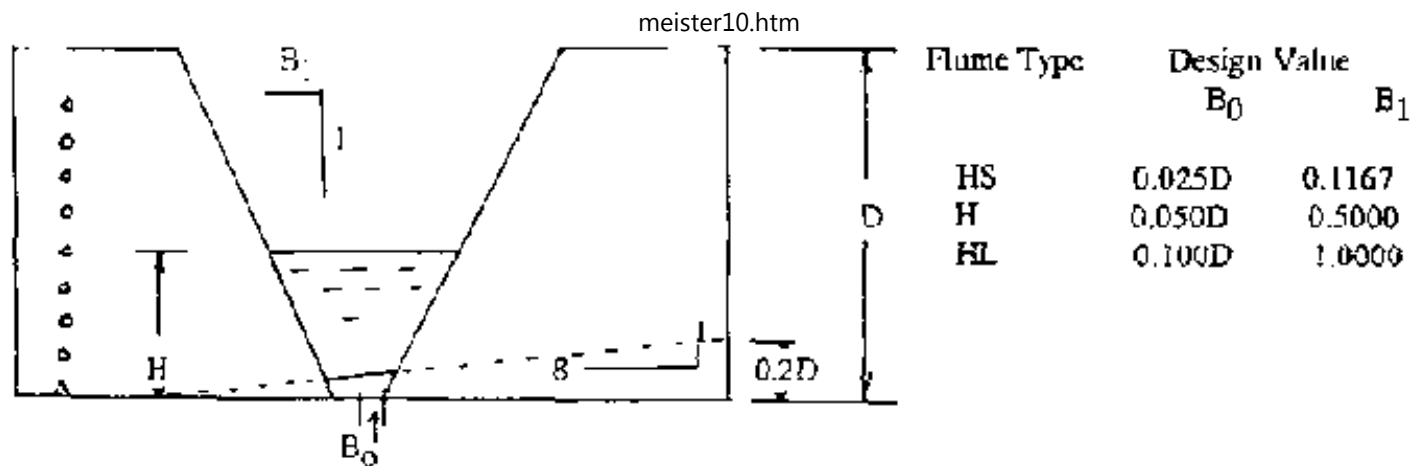
Before installation, it is well worth considering the following points:

- Has the flume been checked for correct manufacture?

- **Has a test fit of WLR, float and counter weight been made?**
- **Has permission to install been given where required?**
- **Will the installation be permanent / be there for many seasons ? or**
- **Will it have to be removed for ploughing and then replaced?**
- **Is the design too big for easy transport and installation?**
- **Is it located in the correct position?**
- **Would many cheaper but shorter-lived flumes serve the purpose better?**

**Installation should take place with the approach section just below ground level and at the lowest elevation of the plot or catchment. This is convenient if in a natural stream channel, but for agrohydrological measurements, this may entail the construction of bunds (typically earth or galvanised steel) to concentrate the flow. If gutters are used instead, they should be covered or the runoff from rain falling directly into them must be taken into account in runoff calculations. To avoid scouring and undermining of the approach section, a small clay or cement apron can be positioned where water runs into it from the plot. A hard surface (tiles, cement) is placed below the outlet point to prevent erosion.**

**Remember that the measurement of runoff from ploughed fields in particular involves sedimentation as a problem. If so, then the flume should have a 1 in 8 sloping floor fined as shown in Figure 2.31. A sloping floor makes no significant difference to runoff measurement.**



**Figure 2.31: Front Elevation of H Type Flumes Showing Sloping Floor**

### Setting the water level recorder

Flumes require water level recorders to be fixed at the measuring section to record water height. The simplest way to fit the WLR is as follows.

- Test that the WLR float and counterweight move freely up and down within the stilling well, with the WLR sitting on top of the well, but not fixed.
- The stilling well should be designed to have its base at a lower level than the flume floor by about 10 cm, thus forming a sump.
- The sump is filled with water until it flows out into the flume.
- The WLR is fixed with tape, float and counterweight.
- When the float is lowered, water is displaced until the float rests at the zero position.
- The WLR pen or electronic level is set and the WLR stand can be bolted into

## **fixed position.**

- **The WLR is then set in relation to the flume floor and any accidental subsidence will not affect readings.**
- **As the sump water evaporates the WLR will register negative readings, but in the event of runoff, the sump will fill and the float will rise rapidly.**
- **The amount of runoff needed to fill the sump is negligible.**
- **Alternatively, a wire frame in the sump set to a level whereby the float rests on it at zero level with the flume floor can be used to prevent negative values. - Check the sump for sediment and clear as necessary.**

## **Rating Tables and Equations**

**Strictly speaking, current metering checks should be made on the operation of flumes, to ensure that design specifications have been followed precisely and rating is accurate. However, in practice the facilities and time to do this will rarely be available for project staff working in the field, especially in developing countries where suitable facilities may not exist. It is essential therefore to construct the flumes accurately and avoid accidental damage to them. Damage is most likely during transit to the installation location, or during seasonal removal.**

**The equations that govern the rating (stage/discharge) of H flumes are complex and it is advised that the rating tables provided in Appendix A1 are used.**

**The rating equations for H, HS and HL flume stages are given below for discharge in cubic feet:**

## Low Flow: Transition:

$$Q = A_0 (280 + B_1 H) H (H - 0.01)^{A_1}$$

$$Q = (K_0 B_0 + K_1 B_1 H) (2g)^{0.5} H^{1.5} \quad (2.19), (2.20)$$

## Medium and High Flows:

$$Q = \{(E_0 + K_1 D) B_0 + (F_0 + F_1 D) B_1 (H + v^2/2g)\} (2g)^{0.5} (H + v/2g)^{1.5} \quad (2.21)$$

with  $D = 1$  and  $v =$  average velocity at the head measuring section

Flume Type	Floor	Range of H in feet	$A_0$	$A_1$	$E_0$	$E_1$	$F_0$	$F_1$	$K_0$	$K_1$
HS	flat	0.01 - 0.10	3.93	0.526						
HS	flat	0.20 - D			0.861	0.112	0.479	-0.035		
H	flat	0.01 - 0.10	3.14	0.486						
E	flat	0.20 - D			0.612	0.209	0.409	-0.024		
E	sloping	0.01 - 0.10	3.30	0.500						
E	sloping	0.20 - D			0.630	0.174				
EL	flat	0.01 - 0.10	3.57	0.522						
EL	flat	0.20 - D							0.7804	0.3788

**Table 2.20: Coefficients of Rating Equations 2.19, 2.20 and 2.21**

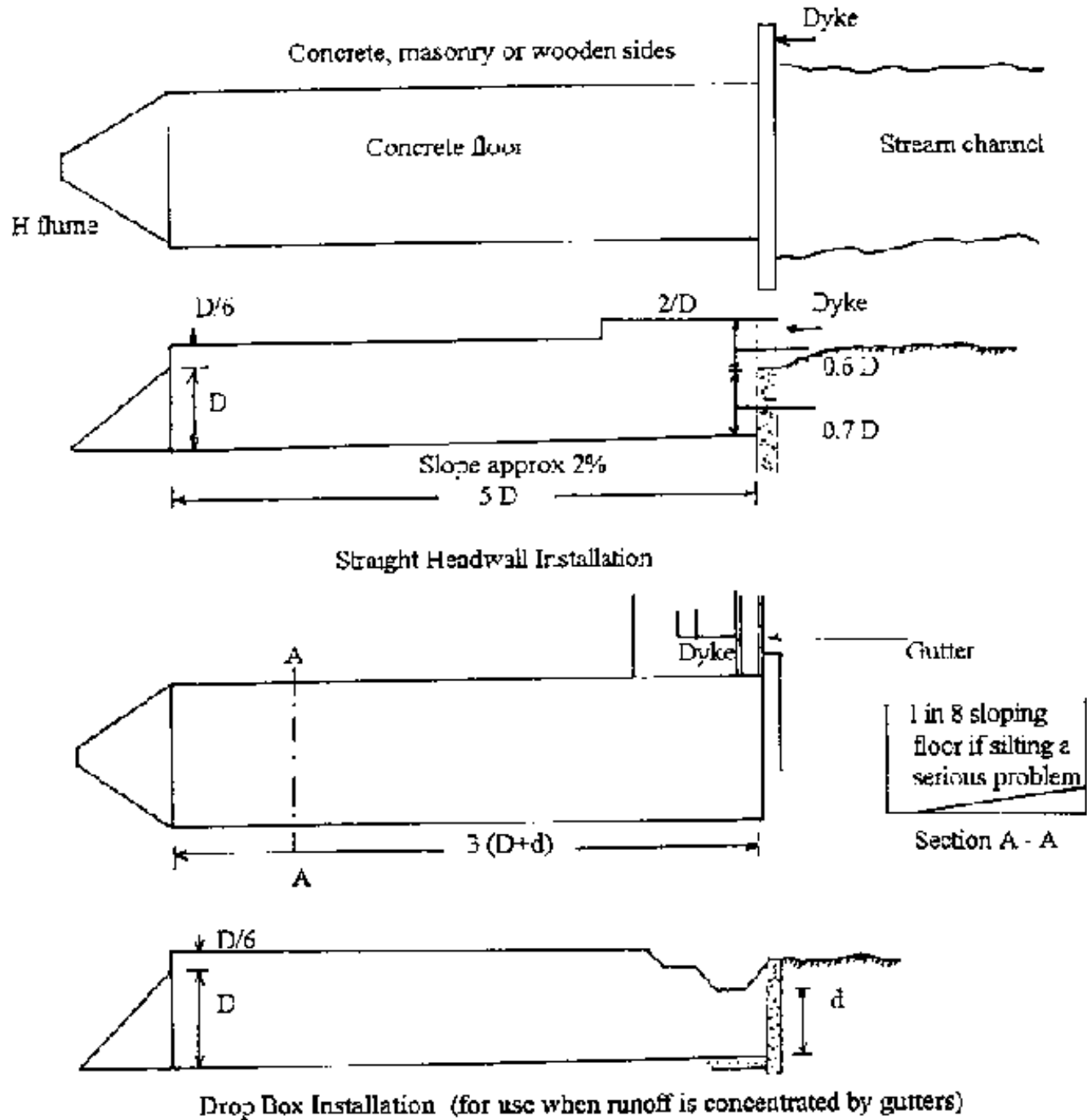
## Siting and Plot Construction

**For small catchment and plot runoff measurement, the simplest location for the flume is in the lowest-lying corner. Use of a simple levelling instrument from one base will identify this point, without the need to undertake a comprehensive plot survey. Few plots, even those that have been land-levelled are absolutely square to**

**the land contours and it is likely that the lowest point will lie in a corner of the plot, which is conveniently the focus of the defining bunds or walls. However, the use of a level is necessary as an assessment of elevation by eye can be misleading. Galvanised sheeting cut to 30 cm wide strips and dug into the ground will form a durable perimeter for small plots. The edges must overlap well, with upslope ends of the metal sheets on the inside of the overlap. Where they meet the flume approach section, they can be bolted to it and provided with a water-proof seal. Earth banked against the inside of the sheets at this point can help prevent scouring.**

**Rarely, scouring around the flume approach mouth can be a problem. The metal approach in Figure 2.30 has a step dug under the ground to help prevent this. Compacted soil, clay or cement aprons can also be used, but a solution will depend on the particular circumstances of the site and workers should be prepared to use their imagination in overcoming small problems such as these. Earth bunds will be cheaper for larger catchments. Experience shows that for a 0.4 ha plot (4,000 m<sup>2</sup>, 100m × 40m) a perimeter bund built to 50 cm takes about 4-8 days to complete by 4 people on a hard, compact sandy loam soil. Picks, shovels and mattocks will be needed. Settling of the soil reduces the height of the bund to approximately 35 cm after a few weeks, with no further reduction. Weed growth soon aids stability. As a guide to perimeter bund construction, pegs with string at the desired height are adequate. Soil is dug and thrown in, with the trench on the outside of the plot. Obviously 35 cm bunds enclosing a plot with a flume of greater depth would not be adequate, or if they were, they would indicate that the flume had been over-designed. For any but the smallest plot, it is not necessary to cover the flume or account for rain falling directly onto it. In the example plot above, the H flume and approach section represent only about 0.01% of the runoff area.**

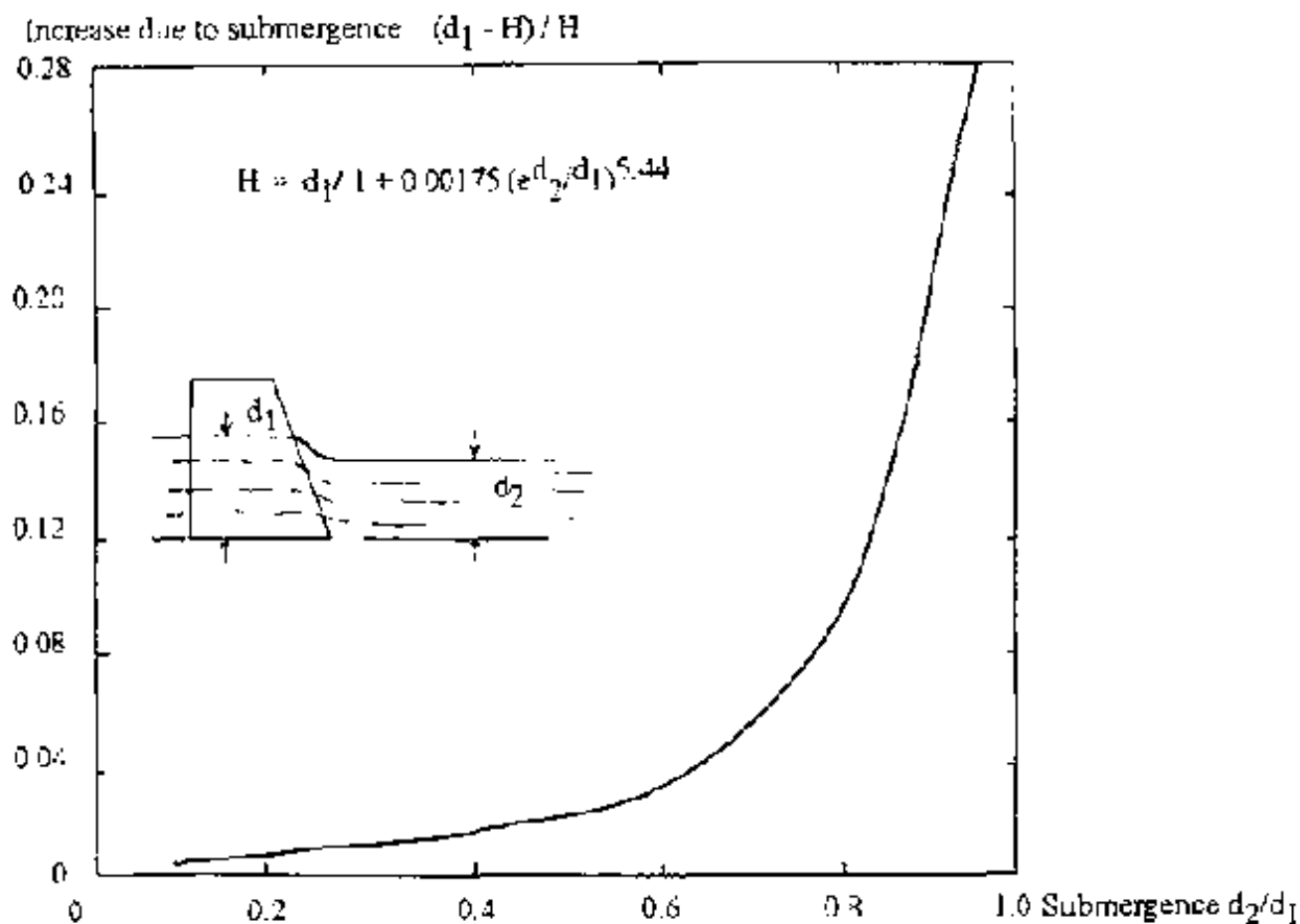




**Figure 2.32: Alternative Installations for H Flumes**

## Submergence

Wherever possible, flumes should not be located where submergence, that is the ponding of discharged water around the outlet, will occur. Drainage channels (where necessary) should be adequate to deal with the removal of discharge. This is not a problem at locations with any reasonable slope, but in low-slope areas (1% or less) it can cause difficulties. H flumes are well designed to cope with the submergence problem, 30 and 50 % submergence cause less than 1 and 3% inaccuracies in the measured flow, respectively.



## Figure 2.33: Head and Submergence, H flume

Figure 2.33 gives the relation between the increase of flume water head due to submergence and depth of submergence. It is defined by the equation:

$$H = d_1 / \left( 1 + 0.00175 \left( e^{d_2/d_1} \right)^{5.44} \right) \text{ where (2.22)}$$

**H** = free flow head;

**d<sub>1</sub>** = actual head with submergence;

**d<sub>2</sub>** = tail water depth above flume zero head

**e** = base of natural logarithms (2.71828)

However, before seeing the head / submergence relation as a way out of this problem it must be remembered that a second WLR, or some other method, is needed to measure the depth of submergence. Given the high cost of WLRs, (as well as the extra time needed to analyze the data) it is best to choose a less problematic site for installation, if at all possible.

### b. Parshall flumes

Parshall flumes are a particular type of Venturi flume, their chief advantage being that they cause only a low loss of head during operation. Their design is based on a long constricting section or throat, the floor of which is flat. They are more difficult to construct than H-type flumes, having a more complex shape, but in general they have no significant advantages for measuring runoff in most circumstances, except that they can be constructed on site to measure very much larger flows. Field calibrations, with velocity recordings and large flows of water, which are difficult to

**arrange, could be necessary. Small Parshall flumes can be bought relatively cheaply, but they are too small to be fitted with WLRs and therefore are only suitable for regular, predictable flow, such as that in irrigation channels. In these circumstances, stage can be measured manually on a regular basis. Small flumes can be manufactured from welded sheet metal, following the careful practice outlined above in this section, though the design is complex and the tolerances of dimensions are very small. They are installed with the flume floor level and care must be taken that they are stable and undermining by erosion cannot take place in front of the converging section. The stilling wells are located in the adjacent banking (see Figure 2.34) and hydraulic connection to the water level recorder is provided by a connecting pipe at flume floor level. WLR installation procedure is the same as for the H flume.**

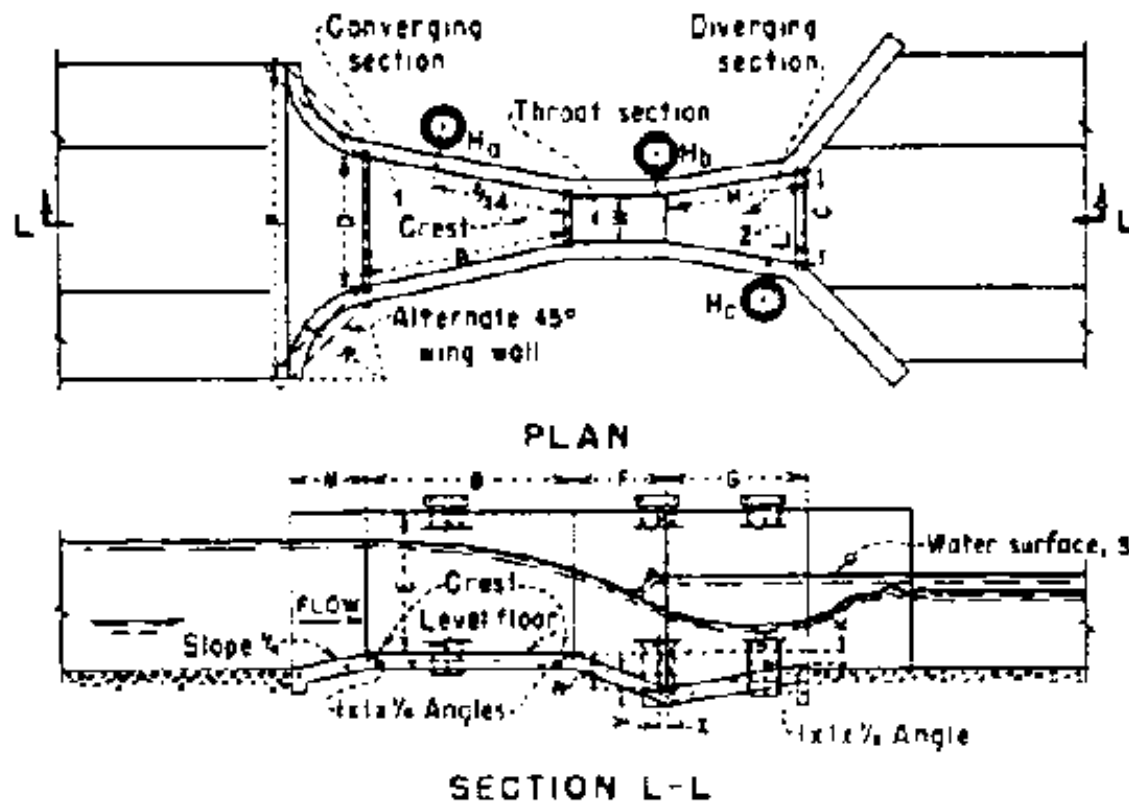


Figure 2.34: Parshall flume

Source: USDA Handbook 221

### Rating Equations

The general rating equation for small Parshall flumes is:

$$Q = 4Wh_a^{1.522} w^{0.026} \text{ where (2.23)}$$

**Q** = discharge in cubic feet

**W** = throat width or length of crest in feet (the size of the flume)

**H<sub>a</sub>** = gauged head,  $\frac{2}{3} \left\{ \left( \frac{W}{2} \right) + 4 \right\}$  feet back from the crest in feet

**In metric form, with dimensions in metres, the rating equation is:**

$$Q = 4 (0.3048)^2 - 1.57(W)^{0.026} W H_a^{1.57(W)^{0.026}} \text{ where (2.24)}$$

**Q = discharge in m s<sup>-1</sup>**

**W = throat width in m**

**H<sub>a</sub> = upper gauge head in m at a point 2/3 (W/2 + 1.219) metres back from the crest.**

**The general formula for large flumes (> 3 m) is given by Parshall as:**

$$Q = (2.29265 W + 0.47376) H_a^{1.6}, \text{ with all values in metres (2.25)}$$

**Large flumes are constructed of reinforced concrete in the field and their manufacture is a difficult task and accordingly expensive. They are generally used where flows are large (they can measure flows much greater than H-type flumes) and where backing up of water and submergence can be a problem. They do need more than one water level recorder where this latter condition is met, however. Where flows are regulated and orderly (for example during irrigation procedures) they can be used with manual gauges, which should be read at short, regular intervals. This saves greatly on the cost of WLRs, as is also the case for H flumes. Capacities and dimensions for Parshall flumes are given in Appendix A 5.**

## **Submergence**

**Submerged conditions occur when water in the diverging section impedes flow in the converging section and they demand a more complex formula than for H flumes.**

**It is accurate for values of  $H_b / H_a$  up to 0.96:**

$$Q = C_1 (H_2 - H_b)^{n_1} / \{-(\log H_b/H_a + M_2)\}^{n_2} \quad (2.26)$$

**Values for submerged flow coefficients and exponents,  $C_1$ ,  $H_a$ ,  $H_b$ ,  $n_1$ ,  $C_2$  and  $n_2$ , are given below in Table 2.21.  $S_t$  is transition submergence, where free flow changes to submerged flow.**

W	C <sub>1</sub>	C <sub>2</sub>	n <sub>1</sub>	n <sub>2</sub>	S
0.025	0.172	0.0044	1.55	1.000	0.56
0.051	0.360	0.0044	1.55	1.000	0.61
0.076	0.535	0.0044	1.55	1.000	0.64
0.152	1.005	0.0044	1.58	1.080	0.55
0.228	1.432	0.0044	1.53	1.060	0.63
0.035	1.76	0.0044	1.52	1.080	0.62
0.457	2.56	0.0044	1.54	1.115	0.64
0.610	3.48	0.0044	1.55	1.140	0.66
0.762	4.26	0.0044	1.555	1.150	0.67
0.914	5.10	0.0044	1.56	1.160	0.68
1.219	6.66	0.0044	1.57	1.185	0.70
1.524	8.23	0.0044	1.58	1.205	0.72
1.829	9.74	0.0044	1.59	1.230	0.74
2.134	11.29	0.0044	1.60	1.250	0.76
2.438	12.68	0.0044	1.60	1.260	0.78
3.048	15.23	0.0044	1.59	1.275	0.80
3.658	18.03	0.0044	1.59	1.275	0.80
4.572	22.22	0.0044	1.59	1.275	0.80
6.096	22.22	0.0044	1.59	1.275	0.80
7.620	29.22	0.0044	1.59	1.275	0.80
9.114	43.22	0.0044	1.59	1.275	0.80
12.192	57.21	0.0044	1.59	1.275	0.80
15.240	71.20	0.0044	1.59	1.275	0.80

**Table 2.21: Submerged low Coefficients and exponents for Parshall Flumes (m)**

### 2.2.2.2. Weirs

**A weir is a low dam or wall built across an open channel and has a specific shape and size. Water flows over in a free-falling sheet (nappe), but if the nappe is**



**partially under the water downstream of the dam, it is said to be submerged. In this condition the accuracy of measurement is reduced. There are many types of weir, but none are suitable for locations other than those with light concentrations of sediment. Some common designs are described below.**

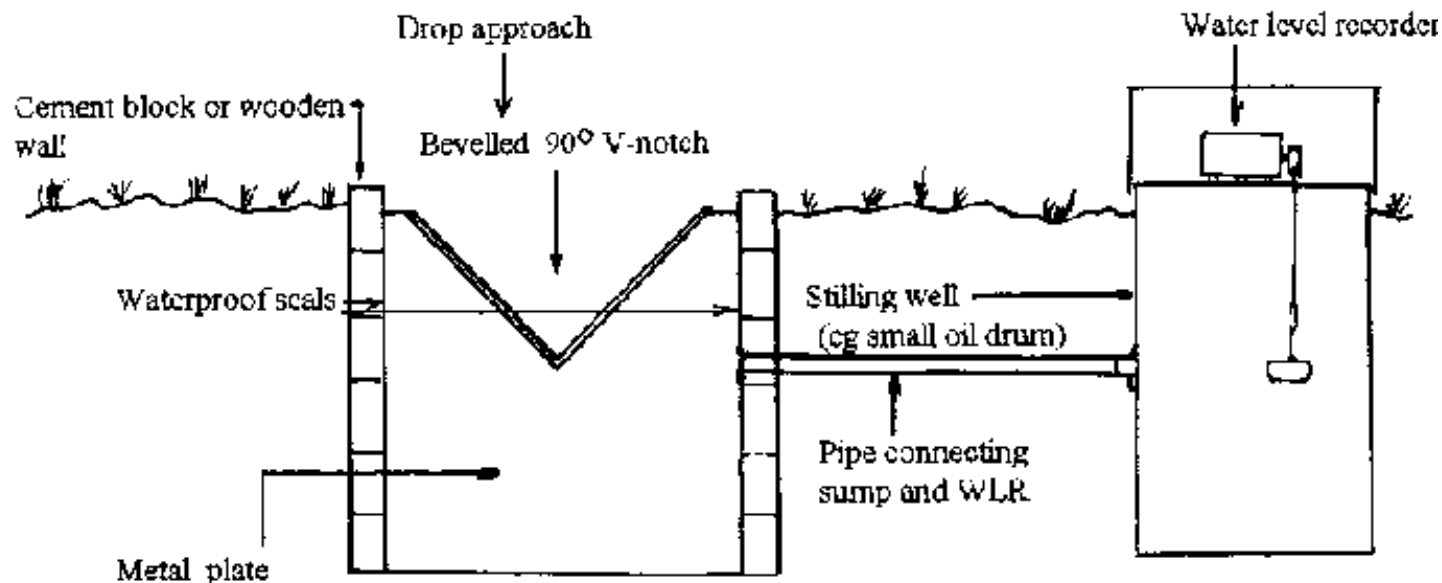
### **a. V-notch Weirs**

**These are often used to measure low flows, as they do so accurately. They are therefore relatively useful in agrohydrological situations. The common V-notch is a 90° opening (usually cut from a metal plate) with the sides at 45° to the vertical. The approach velocity of flow can be ignored if the distance from weir to bank is twice the head and the height from channel bottom to the crest is twice the head. To fulfil these criteria, modification to the approach section is not usually difficult. V-notch weirs are also useful in the agrohydrological context, because not only can they be used to measure flow from plots and small catchments, they are relatively easy to make and install. Their rating equation for various flows is simple. Their biggest disadvantage is that they are unsuitable for locations with any other than low concentrations of sediments. The V-notch should be kept clean and sharp at all times.**

### **Manufacture and Installation**

**The 90° V-notch is cut from rigid 10 mm sheet mild steel, which is galvanised or carefully painted to resist corrosion. This is bolted to the cement block approach section (with a rubber gasket sealed joint), which also acts as a sediment sump.**

**Figure 2.35 below shows a typical installation of a small V-notch weir.**



**Figure 2.35: Installation of V-notch Weir**

The V-notch is bevelled to a sharp edge and must be maintained in this condition. The stilling well is located away from the weir, at a convenient point and hydraulic connection is made to the sump (at the level of the V apex) by a 5 cm diameter pipe. The stilling well can be any convenient dimensions. A small oil drum fixed into the ground, with a suitable outlet for the connecting pipe, makes a good form for the stilling well. It should be treated to resist corrosion. The top of the drum has welded or bolted onto it, fixings appropriate to the type of water level recorder to be used. It should also be fitted with a lid with small holes adequate for the passage of the float / counterweight tape or wire. The connecting pipe should be fixed to the drum prior to installation, laid horizontal by levelling and sealed at the sump end. Bunds are raised to direct flow to the weir and should be solid enough to resist erosion. The simplest way to set the level of the WLR and to check that the levels of the V-notch and pipe are the same, is to fill the sump and stilling well with water (though this may take several hundred litres, depending on the size of stilling well

**and sump). The water level should be allowed to settle until it is just at the apex of the V-notch and at the bottom of the pipe in the sump and stilling well. The float can then be lowered, a small amount of displaced water will drain and the pen or electronic counter on the WLR set to zero. The WLR will register negative values due to evaporation from the stilling well during long periods without runoff. Some account must be made of runoff collected in the sump and refilling of the stilling well after rainfall, especially if the runoff event is small. The capacity of the sump may be several hundred litres. This procedure will depend upon the exact circumstances of the installation, the size of runoff event and the degree of sedimentation of the sump, etc.**

## **Rating Equation**

**The rating equation for a 90° V-notch weir is relatively simple and from it a rating curve or table can be derived. It is:**

$$Q = 2.49 H^{2.48} \text{ where (2.27)}$$

**Q = discharge in cubic feet ( 35.3 ft<sup>3</sup> = 1 m<sup>3</sup> = 1,000 litres)**

**H = head above lowest part of the V-notch in feet ( 1 foot = 0.305 m)**

**For V-notch weirs with angles not equal to 90°, the rating equations are complex and discussed below for large structures. For small weirs, however, there is little or no advantage in diverging from this orthodox design.**

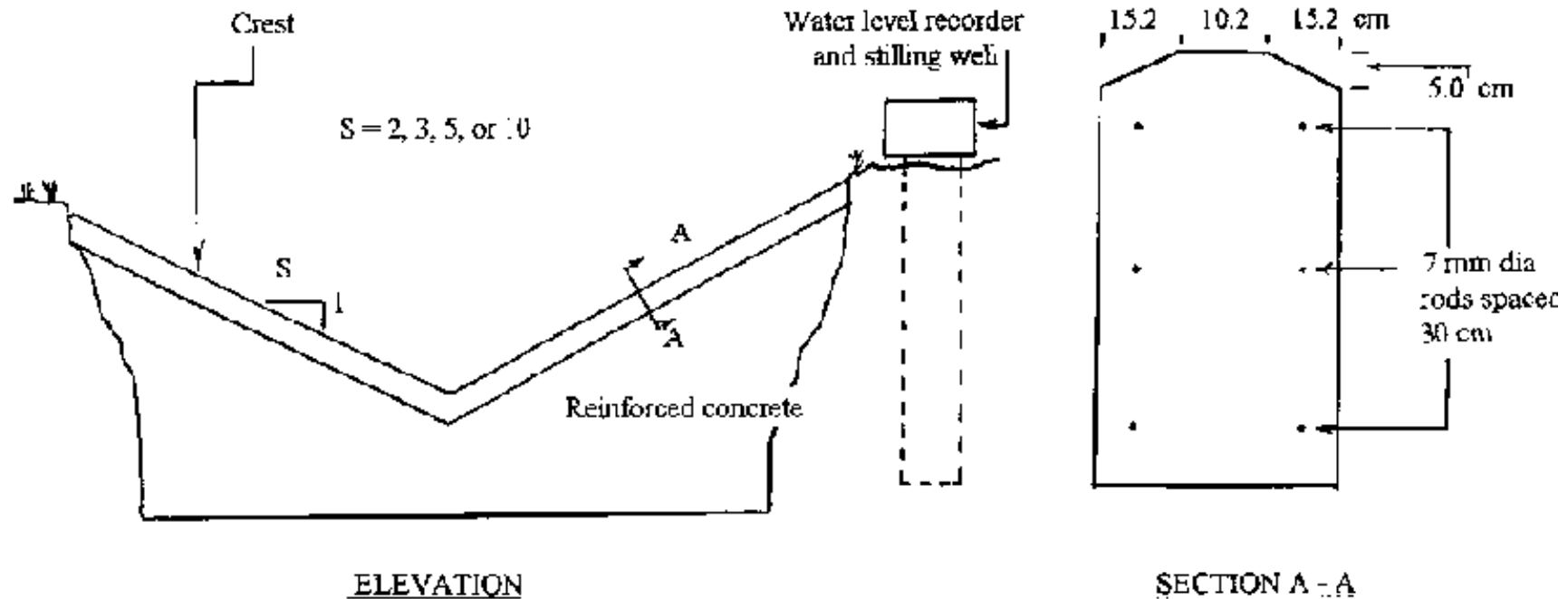
## **b. Large Weirs**

**Examples of large artificial controls are given below, but in less detail than those**

used for the measurement of small runoff flows. These structures are minor works of civil engineering usually undertaken only by River Authorities and similar organisations with the necessary equipment and skills. They are costly and permanent, though in some situations they may be essential if stream flow data are to be collected and natural controls are unsuitable. Any project proposing to enter into the construction of such controls is urged to approach the relevant Authority and seek advice as to those which have proved most suitable for local conditions and their likely cost.

### Broad Crested V-notch Weirs (Triangular Weirs)

Large versions of the 90° V-notch weir can be used to measure large volume of runoff, but as runoff amounts increase so does (usually) the presence of debris which may block the outlet. Triangular weirs pass floating debris easily.



## Figure 2.36: Broad Crested Weir

**They are large, permanent concrete structures, capable of measuring flows greater than  $30 \text{ m}^3 \text{ s}^{-1}$  and involve a considerable input of finance and labour. Backwater ponding is not permitted. However, they are relatively simple in design and construction' compared to alternative weirs and so are discussed here in some detail. Figure 2.36 shows the dimensions of such a weir with a 3:1 sloping section.**

**A straight section of channel is needed for 20 m upstream and a concrete apron 4m long is needed downstream. A large end cutoff wall is necessary to prevent the structure being undermined. The calibration of these weirs is affected by the approach velocity, the cross-sectional area of the approach 3 m upstream from the weir being a measure of this. Rather than providing a series of rating equations, which are very complex for these weirs, rating tables are given in Appendix A 4.**

### **c. Culverts and Similar Existing Structures**

**In some instances it is possible to use existing structures such as road culverts to measure runoff. The advantages of such structures are that they may be fairly common and will be already in place. Sometimes they may have to be built out of necessity for other project activities and so impose no extra cost on the hydrology budget. It is important to remember however, that in most cases existing structures will not have been made with runoff measurement in mind and modification may be necessary.**

**This can be costly and time-consuming. They may not be conveniently located and serious errors of estimation can occur when such structures are used without knowledge of suitability. The basic aspects of flow in culverts are discussed here**

**because culverts and their runoff capacities can be an important aspect of water harvesting schemes, farm layouts and irrigation projects. In particular, square concrete and circular corrugated metal culverts are frequently encountered.**

## **Flow in culverts**

**Culvert capacity can be controlled by the inlet section or the conduit. In either case the head water elevation may be above or below the top of the inlet and the solution to calculating culvert flows depends on the head and tail water conditions. Square or circular sectioned culverts may be used, but neither are accurate meters of flow when compared to pre-calibrated artificial control sections. The three main types of flow in culverts are:**

**1. Where the slope of the conduit is less than the neutral slope. The conduit is full and therefore controls the flow. Inlet submerged, outlet submerged or not.**

**Use Pipe Flow Equation (2.29).**

**2. Where conduit slope is greater than neutral slope. Inlet submerged, outlet is not submerged. Entrance controls exist (inlet submerged) .**

**Use Orifice Flow Equation (2.30) or Figure 2.38**

**3. Inlet not submerged, outlet not submerged, culvert slope less than neutral slope.**

**Conduit controls exist and Entrance controls do not.**

**Use Manning's Open Channel Formula (2.31)**

**Neutral slope is defined for small angles of the conduit to the horizontal by:**

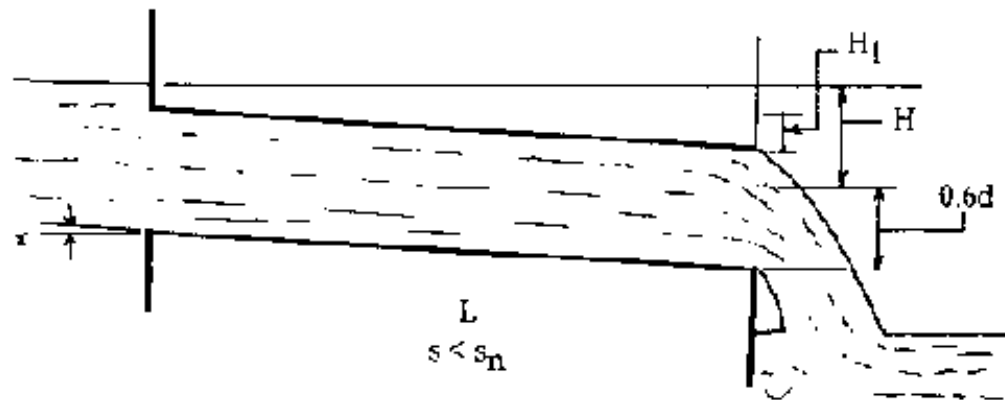
**Neutral slope =  $\tan x = \sin x = H_f/L = K_C (v^2/2g)$  where (2.28)**

**$x$  is the slope of the conduit,**

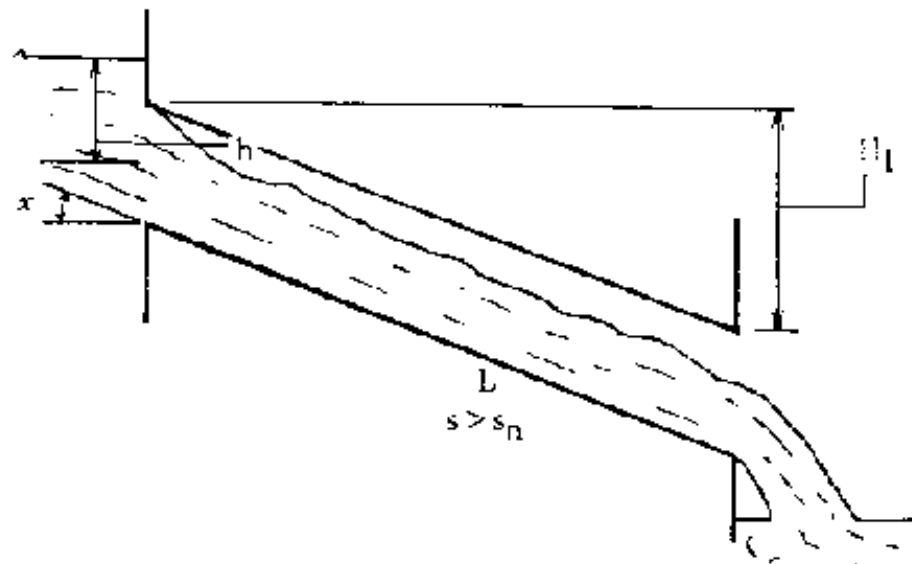
**$H_f$  is friction loss in conduit of length  $L$  (m)**

**$K_C$  is the friction loss coefficient  $v$  is the velocity of flow in  $m\ s^{-1}$   $g$  is the gravitational constant in  $m\ s^{-2}$**

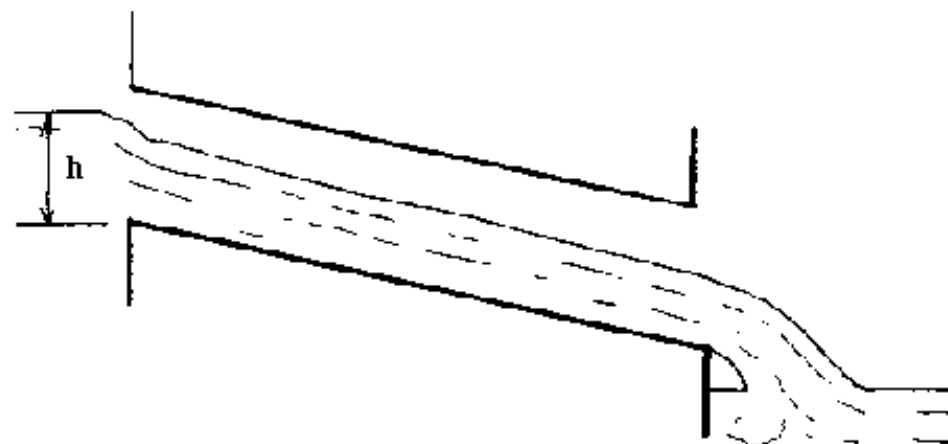
**Figures 2.37 (a) to 2.37 (c) illustrate these conditions, respectively.**



**Figure 2.37 (a)**



**Figure 2.37 (b)**



**Figure 2.37 (c)**

**1. Pipe flow (that is when the conduit controls the capacity of flow) usually occurs when the slope of the conduit is less than the neutral slope. The pipe flow equation is:**



$$Q = a\sqrt{2glH} / \sqrt{1 + K_e + K_b + K_c L}$$

**where (2.29)**

**Q = flow capacity in units of  $L^3 T^{-1}$**

**a = cross-sectional area of conduit in units  $L^2$**

**H = head causing flow in units of L**

**$K_e$  = entrance loss coefficient**

**$K_b$  = loss coefficient for bends in the culvert and can therefore often be ignored.**

**$K_c$  = head loss coefficient (which =  $(1,244,522 n^2) / d^{1.33}$  where d = diameter in SI units and n = Manning's n)**

**Values of a, L and H are measured.**

**To see if conduit slope ( x ) is less than the neutral slope, the latter is found by equation 2.28:**

$$S_n = \tan x = \sin x = H_f / L = K_c (v^2 / 2g) \text{ where}$$

**x = slope angle of the conduit**

**$H_f$  = friction loss in conduit length L in m**

**L = conduit length**

**$K_c$  = friction coefficient**

**v = velocity of flow in  $m s^{-1}$**

**g = gravitational constant in  $m s^{-2}$**

**Worked example**

**What is the capacity of a 600 mm diameter culvert, 15.0 m long with a square edged entrance? Survey shows the inlet elevation to be 456.35 m, the outlet elevation = 456.20 m, the head water elevation is 457.95 m and tail water elevation is 455.25 m ?**

**The first step is to assume that pipe flow prevails and use equation 2.29**

$$K_e = 0.5 \text{ (square inlet)}$$

$$K_c = 0.319 \text{ (with Manning's } n \text{ estimated at } 0.036)$$

**$K_b$  is only used for conduits with bends and therefore is not included**

$$H = 0.94 \text{ m}$$

$$a = 3.14 \text{ m}^2$$

**Therefore:**

$$Q = 3.14 \sqrt{2 \cdot 9.8 \cdot 0.94 / \sqrt{1 + 0.5 + 0.319 \cdot 15}} = 5.38$$

$$\text{m}^2 \text{ s}^{-1}$$

**To determine if the pipe flow assumption is correct, the neutral slope is calculated from equation 2.28 and substituting discharge / area for velocity in SI units,**

$$S_n = 0.319 \times (0.283)^2 / 2 \times 9.8 \times (0.28)^2 = 0.0166, \text{ or } 1.7\%$$

**As the actual slope of the culvert  $S = (456.35 - 456.20) / 15.0 = 0.01$ , or 1.0 %, then as culvert slope < than neutral slope, pipe flow conditions prevail. To check whether orifice conditions (as opposed to pipe flow) prevail, the orifice equation 2.30 below, is used. The values of  $h$  and  $C$  in this equation are 0.85 and 0.6 respectively. The discharge is:**

$$Q = 3.14 \cdot 0.6 \sqrt{2 \cdot 9.8 \cdot 0.85}$$

$$\mathbf{m^3 s^{-1}}$$

**This discharge is greater than the full pipe capacity and therefore pipe flow must prevail. Using the procedures above and in cases where the culvert slope is found to be greater than the neutral slope, pipe flow cannot prevail, the orifice equation should be used. Outlet not submerged.**

**2. Orifice flow is the second type of flow and is found when the conduit slope is greater than the neutral slope, the inlet is submerged but the outlet is not (i.e. inlet controls exist). The equation for orifice flow is:**

$$Q = aC\sqrt{2gh}$$

**where (2.30)**

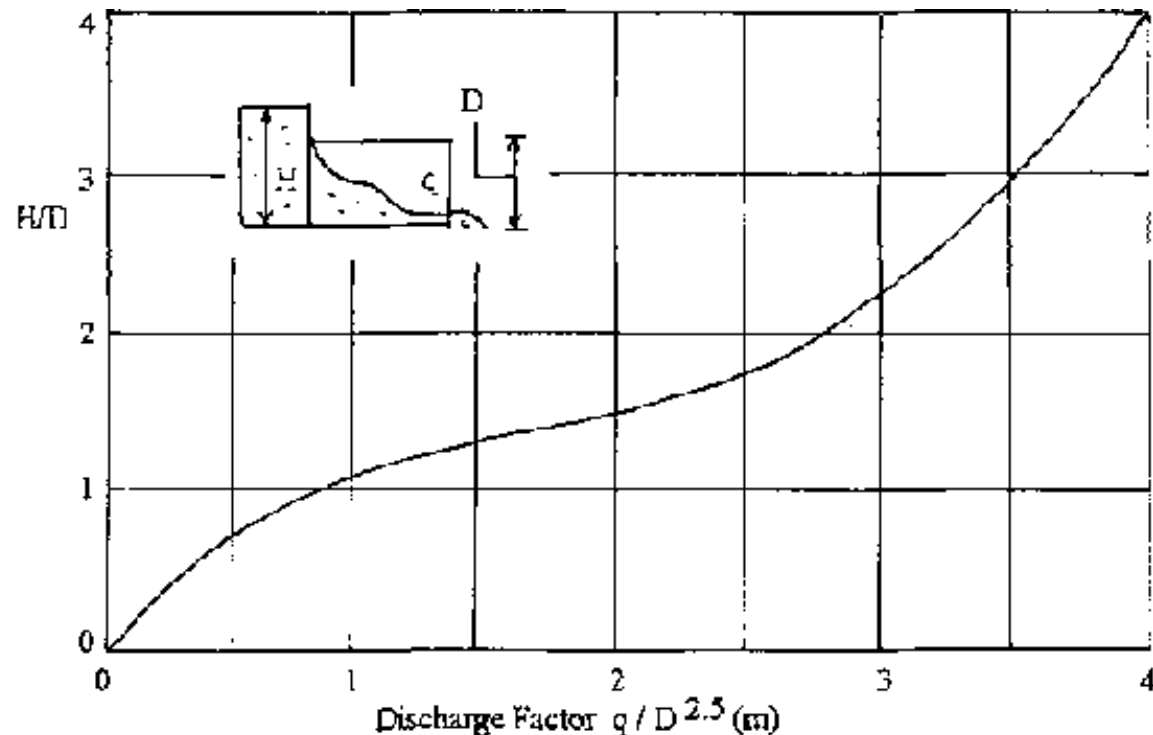
**a = cross sectional area**

**h = head to the centre of the orifice**

**C = 0.6 for sharp-edged orifices**

**g = the gravitational constant in  $m s^{-2}$**

**Alternatively, Figure 2.38 can be used to determine flow from an orifice with inlet (entrance) controls where H= head and D= diameter of a circular sectioned culvert in m.**



**Figure 2.38: Stage Discharge Relation for Control by Square Inlet to Circular Pipe**

### **3. Channel Flow (Manning's Formula).**

**In some cases the headwater elevation is lower than the top of the inlet and control is by the channel or conduit itself. This occurs where the conduit slope is too shallow to allow the maximum possible flow that could be provided. Manning's formula is used to calculate flow. In other cases, despite the low head, the inlet section still provides the control and restricts the flow. This occurs when the slope of the conduit is greater than that required to move the possible flow through the inlet. Figure 2.38 can be used in these cases. To determine whether the results as given by either channel flow or inlet restriction calculations are correct, follow the steps below.**

**Assume restriction at the entrance does not exist.**

**Calculate channel flow using Manning's formula:**

$$v = R^{0.667} S^{0.5} / n \text{ where (2.31)}$$

**v = average velocity of flow in m s<sup>-1</sup>**

**n = roughness coefficient of the channel**

**R = the cross-sectional area divided by the wetted perimeter (a/p) in m**

**S = hydraulic gradient (channel slope)**

**The use of this formula depends on making the dimensions of the channel such that  $v = Q/a$  and where Q the flow rate of the channel.**

**Then use Figure 2.38 to check the flow through the inlet. If the Manning's solution gives a flow greater than that from Figure 2.38 then obviously the latter is correct since this represents the upslope control of all flow through the conduit. Where the situation is reversed (channel flow < inlet flow), channel flow will prevail.**

### **Manning's Formula Worked Example**

**Determine the capacity of a pipe of 1.20 m diameter, 20 m long with a square-edged entrance. Elevation of the inlet is 224.0 m, outlet is 223.95 m . Head water elevation is 225.0 m and tail water elevation is 220.0 m. In this case, the conduit has a very shallow slope and channel conditions may prevail. In the first instance assume a flow depth in the conduit of 0.6 m. Then**

$$a = 0.57 \text{ m}^2$$

$$\begin{aligned}n &= 0.015 \\R &= 0.185 \text{ m} \\S &= 0.0025\end{aligned}$$

Substituting in Manning's formula (2.31),  $v = 1.08 \text{ m s}^{-1}$  and  $Q = 0.62 \text{ m}^3 \text{ s}^{-1}$

If it is assumed that the approach velocity is negligible, then the loss of static head due to acceleration is  $= v^2/2g, = 1.082 / 19.6 = 0.06 \text{ m}$ . The depth of water at the entrance (headwater elevation minus inlet elevation) is  $1.00 \text{ m}$  and a loss of  $0.06 \text{ m}$  would give  $0.94 \text{ m}$ , which does not correspond with the assumed depth of  $0.6 \text{ m}$ . The process of iteration can be continued. If the flow depth is now assumed to be  $0.90 \text{ m}$ , then:

$$\begin{aligned}a &= 0.94 \text{ m}^2 \\n &= 0.015 \\R &= 0.269 \\S &= 0.0025\end{aligned}$$

Substituting into Manning's formula:  $v = 1.39 \text{ m s}^{-1}$  and the loss of head,  $v^2/2g$ , now  $= 0.10 \text{ m}$ , which when subtracted from  $1.00 \text{ m} = 0.90 \text{ m}$ , the assumed depth. Thus flow is limited by the conduit and the discharge of the flow is:  $Q = 1.39 \times 0.94 = 1.31 \text{ m}^3 \text{ s}^{-1}$

Very many different designs of culverts are constructed and it is recommended that specialist manuals be consulted if work in the area of culvert structures and their hydraulic properties in to be studied in great detail.

## 2.3 Water level recording instruments

### Crest Gauges

### Manual Gauges

### Automatic Water Level Recorders

### Electronic Logging Recorders

### Chart Recorders

### Bubble (Servo-manometer) Recorders

**The measurement of flow volumes that use control sections, be they natural or artificial, necessitates the collection of water level data for the passing through the section, either automatically or by observer. The collection of these records is made by the use of one of three types of instrument. In order of providing least data first they are:**

Crest gauges:	These gauges record only the highest level of
	flow, but do so automatically.
Manual gauges:	These are simple gauges and provide records
	whenever an observer is present to read them.
Water Level Recorders:	These are relatively sophisticated gauges that
	provide a constant record of water levels.

**The choice of gauge will depend upon the importance of the data: the first two types of instrument are cheap to manufacture from local materials, whereas the latter must be purchased at considerable expense. However, to help in correct choice, here is a list of the advantages and disadvantages of each, with a description of the**

## **circumstances for which they are suitable.**

### **Crest gauges**

#### **Advantages:**

- **Cheap to manufacture out of local materials**
- **Easy to transport, place and maintain**
- **Very little instruction is needed for correct reading**

#### **Disadvantages:**

- **Provide very little data, only maximum peak flows**
- **Must be visited and read after a high flow**

#### **Suitable For:**

- **Situations where peak flow and maximum discharge only are required, for example estimating maximum flood levels, survey work, maximum flow probabilities. Some manner of converting flow stage to discharge must be available, if discharge values are needed.**

### **Manual Gauges**

#### **Advantages:**

- **Cheap to manufacture from local materials**
- **Can be easy to install**
- **Need little maintenance**



- **Can provide good data from streams that flow regularly**
- **Essential backup and check on natural controls that have WLRs**
- **Data is a permanent, written record**

### **Disadvantages:**

- **Do not give continuous records**
- **Need to be visited regularly or retain a gauge reader**
- **Data is as good as the reliability of the reader**
- **Can be washed away in flood**
- **Installation can be difficult**
- **Analysis demands manual input into computer storage**

### **Suitable For:**

- **Commonly used on permanent streams**
- **Irrigation schemes**
- **Can be used on flumes etc. instead of WLRs where flow is regular and easily monitored**
- **Not suitable where a continuous record is needed**
- **Distant sites visited from base on a regular but not frequent basis can often be provided cheaply, but a local reader will be necessary.**

## **Water Level Recorders**

### **Advantages:**

- **Automatic, need infrequent visits**

- **Give complete runoff record: duration, peak flows, flow recession, volumes**
- **Data can be linked well to rainfall data (from intensity gauges)**
- **Data can often be downloaded directly into the computer for analysis with a great saving of time.**
- **Most suitable for remote sites, need no reader at site**

### **Disadvantages:**

- **Expensive**
- **Need regular checks and maintenance**
- **May be difficult to repair.**
- **Solid state electronic instruments will have to be returned to manufacturers for repair.**
- **Need a higher level of training for correct usage.**

### **Suitable For:**

- **Used where good quality data is essential**
- **Often used at remote sites where data collection would otherwise be impossible**
- **Especially useful at base stations where core research is being conducted**

### **a. Crest Gauges**

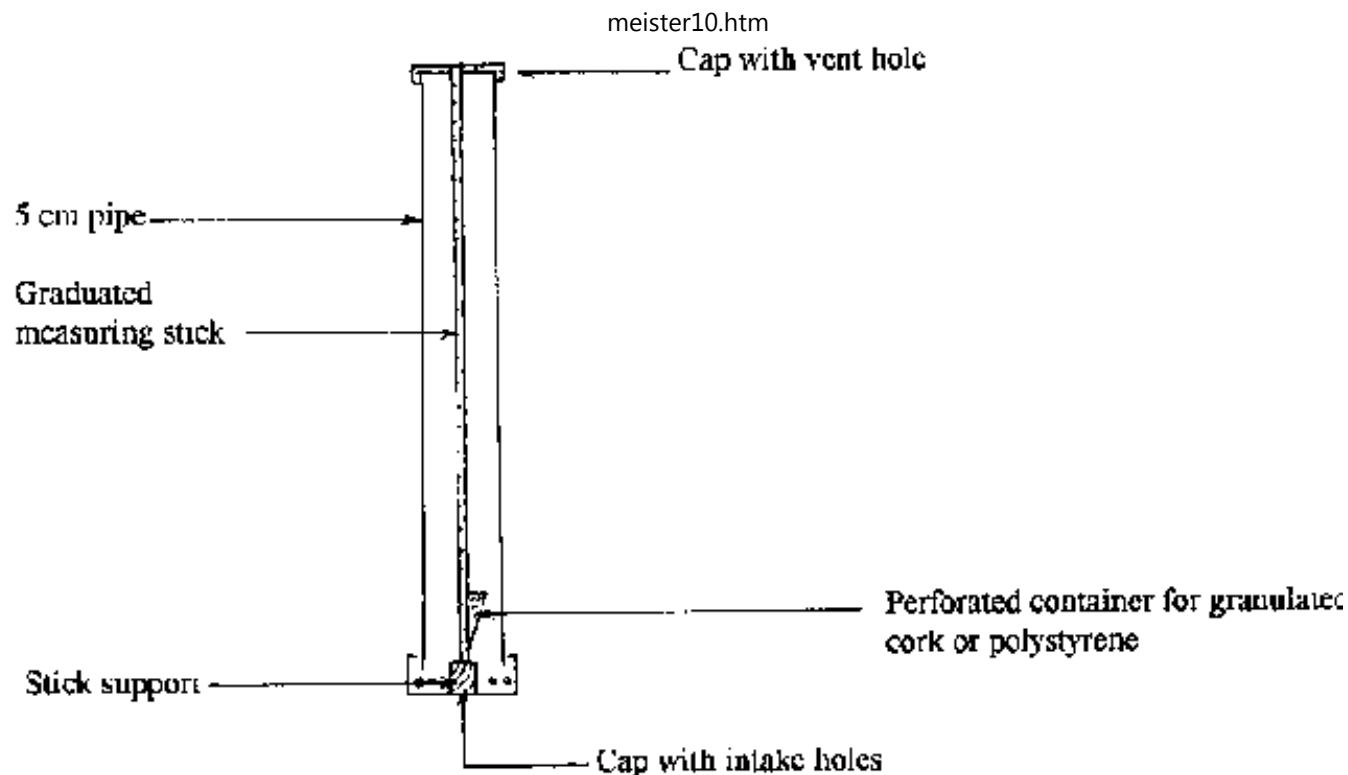
**A typical crest gauge is illustrated below in Figure 2.39. Crest gauges provide useful information on peak flows when no observer is present. They can be fixed to**

**bridges, stable stream banks or spillways. One of their most important advantages is the ease at which they can be constructed easily from cheap, locally-available materials.**

### **Construction and Installation**

**Galvanised steel water pipe or plastic water pipe, with a 5 - 8 cm diameter is suitable. The former is less prone to damage from flood water, debris and rough handling, but plastic is easier to work with, lighter and cheaper.**

**Suitable caps for plastic pipe are sometimes more easily obtained and do not need to be screw-threaded to fit. Any suitable length from 1.0 - 1.5 m can be used conveniently. A series of 0.5 cm holes are drilled into the lower pipe cap and act as intakes to provide hydraulic continuity with the flow. A vent hole must be provided in the top cap or upper portion of the pipe. Inside the gauge a wooden measuring stick is placed, graduated with clear markings. One centimetre marks give adequate accuracy. Screwed to the measuring stick is a small, perforated container of plastic or non-corroding metal. For this purpose it is better if the stick has a square section. Within this container is placed powdered cork or fine polystyrene granules. When peak flow occurs, this material floats out of the perforated container and deposits itself on the measuring stick, from which the peak flow reading is taken.**



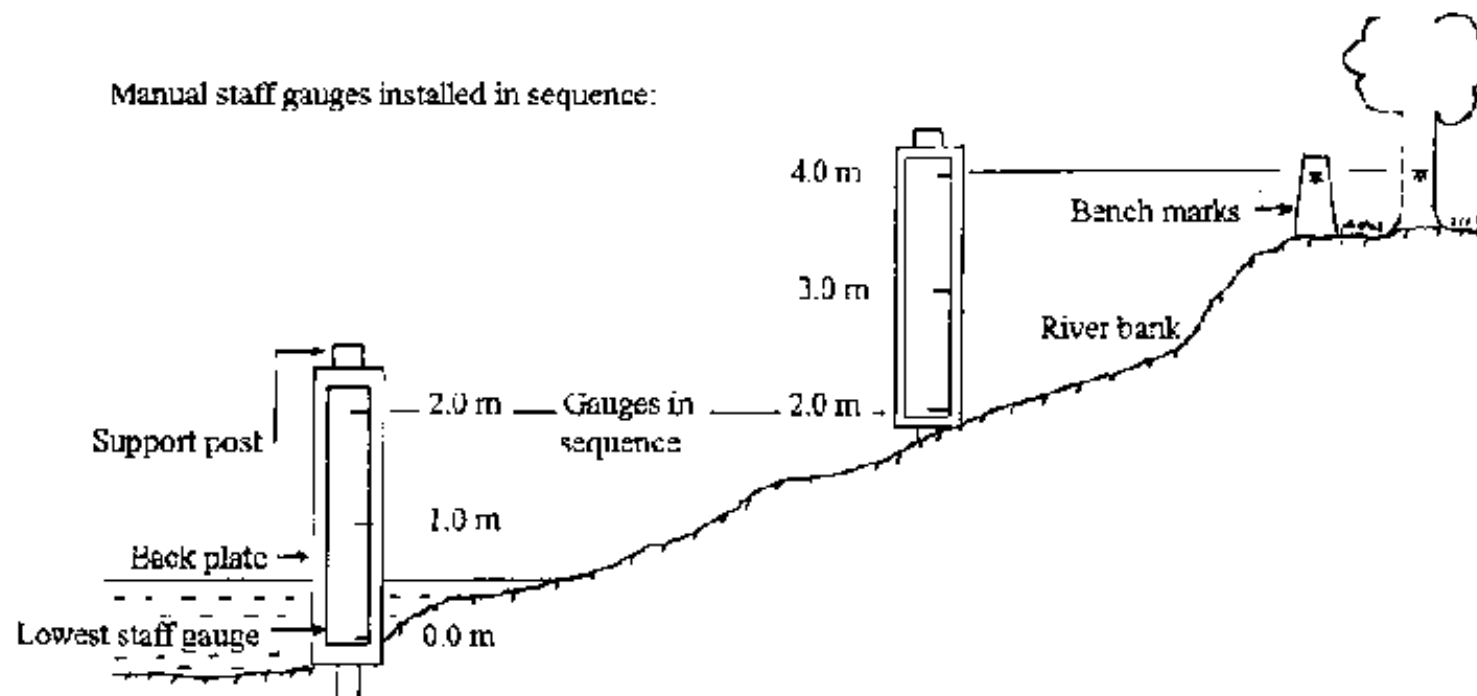
**Figure 2.39: Typical Crest Gauge**

**Note that the lower cap has a support for the measuring stick, which is securely screwed to the top cap. The gauge should be installed precisely in a vertical position, using rust-resistant, bolted brackets. The openings should face the direction of flow. The gauge should be levelled to a permanent bench-mark, so that in the event of removal, replacement can be effected from the same base level. Where other gauges are used (for example manually-read staff gauges), it should be levelled in sequence with these if possible, or at least to the same bench mark, so that a relative reference point is available. Care should be taken when replacing the measuring stick if the water level is higher than the bottom of the gauge, as a temporary displacement of water in the gauge could lead to a false reading.**

**As well as measuring peak flows, crest gauges can be used to measure volumes at unattended sites, or at times when the observation of maximum runoff volumes is impractical. For example, some water harvesting systems direct runoff into small basins that provide supplementary water for fruit trees. Knowledge of the basin symmetry and water level can provide an estimate of total received runoff, though infiltration losses need to be accounted for. Evaporation is unlikely to cause serious inaccuracy.**

### **b. Manual Staff Gauges**

**Staff gauges are made of metal (often ceramic-covered) or plastic strips, about 12-15 cm wide in 1 - 2 m long sections. They have numbered, graduated markings at 1 cm intervals. They are placed in a low-velocity location on structures (bridges, stilling wells, etc.) or on posts in the river bank. The water level is read from their graduated markings. They may be installed singly or in sequence, as illustrated below. In the case of ponds and reservoirs, the posts are set inclined for increased accuracy, as a small increase in water level can represent a large increase in volume. In this case the graduation and setting must be done very carefully.**



**Manual staff gauges installed in sequence**

**Staff gauges can be purchased and these are of high quality, but very expensive compared to those manufactured from local materials, especially when shipping costs are taken into account. On the whole, plastic gauges are best avoided as they eventually become brittle and breakage can result when they are placed in rivers that carry much debris. Resetting (which in flashy streams may be necessary each season) of these gauges can also lead to damage and they make popular targets for shooting practice.**

### **Construction and Installation**

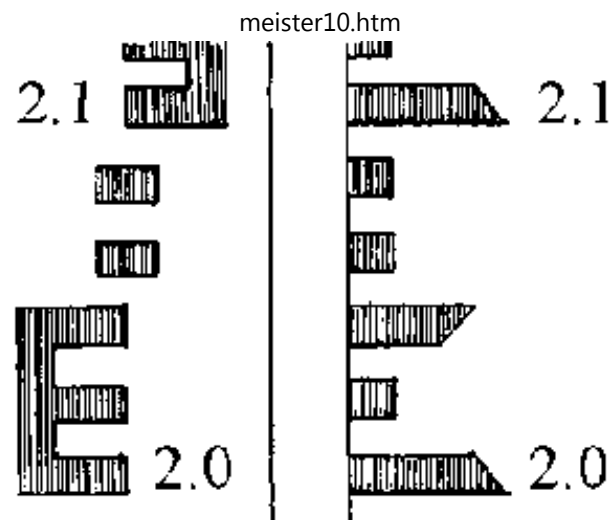
**The facility to manufacture locally is a great advantage. As well as providing large savings in cost, it is important to have replacement gauges available immediately.**

**Perfectly serviceable gauge plates can be made in the following way, for less than one tenth of the commercial cost.**

**Cheap gauges can be made from flat wooden boards which have been treated to prevent rotting though these will last a few seasons. Aluminium sheet and galvanised steel sheet provide better alternative materials and can be cut into strips for use.**

**A suitable stencil with which to paint the graduations can be cut (0.5 m is a practical length) from acetate or thin, stiff card,. Thin metal makes a durable stencil, but tends to bend and work less well. The metal strip is painted black as a background. The stencil is placed on the sheet and the markings spray painted in white. Numerals 5 cm high are sprayed at 10 cm intervals in white on the black background Numerals 7.5 cm high are sprayed on at every metre interval. These can be sprayed on in the field according to particular need, another advantage over pre-marked, purchased plates. Two suitable designs are shown in Figure 2.40. The finished plates are then screwed (brass or stainless steel screws) to a treated back-board to maintain a suitable rigidity.**

**Staff gauges are emplaced at the gauging station during the dry season when permanent streams are at their lowest, or at any convenient time for ephemeral flows. Where possible, they should be fixed to bridges etc. to reduce the risk of loss in floods.**



**Figure 2.40: Example Graduated Markings for Gauge Plates**

**The type of fixing will depend on the structure available, but all plates should be vertical. Set the lowest one first and then in sequence. If they are to be placed on a stream bank, 5 cm galvanised water pipe sections make good posts. Alternatively rot-resistant local timbers can be used, but these are difficult to hammer into the stream bed or banks and may necessitate the use of a manual post hole digger. River Authorities and similar bodies have access to heavy installation equipment that is unlikely to be available to most projects. In all cases, the gauges must be levelled to ensure the sequence is accurately placed and the bottom of the gauge must be levelled to a permanent bench mark. If man-made structures are not available, nailed and painted marks on several large trees, well away from the river, will suffice. At many sites it will be too difficult to level into a national survey, but a site plan including all levelling details, should be made. Checks on the level of the gauges should be carried out at least once each year. Staff gauges can be used with artificial controls where flow is regular and reading can be arranged.**

### **c. Automatic Water Level Recorders (WLRs)**



**There are many different manufacturers of WLRs. There are, however two main types:**

**Float and Counterweight Recorders  
Pressure Sensing (Bubble gauge ) Recorders**

**Advantages and disadvantages:**

**In general, the former are the cheaper and more commonly encountered. They are the most suitable for agrohydrological applications because of their small size and ease of siting on artificial controls, especially H flumes which have integral stilling wells. They are easier to install. They do not need special housing, unlike bubble gauge recorders and are therefore more easily re-located. Either type will measure large differences in water level.**

**Float and Counterweight Recorders**

**There are two main types of these instruments, according to the manner in which data is recorded and stored: those with electronic data loggers and those which record with pens and paper charts set on a clockwork drum. The relative advantages and disadvantages of each type are listed below. The costs of both types are similar.**

<b>Electronic</b>	<b>Chart</b>
Advantages	
- Compact and robust	- Widely known
- Wide range of easily set recording times	- Sometimes possible to repair locally
- Good precision.	- Do not need computer facilities

- Wide range of level differences	
- Long periods between visits if necessary	
- Download direct to computer	
Disadvantages	
- Batteries can fail	- Sensitive to rough handling
- Cannot be repaired locally	- Time/level adjustments limited by
- Need computer facilities	charts and clock which can be
	difficult
	- More limited recording time
	- Manual data entry into computer

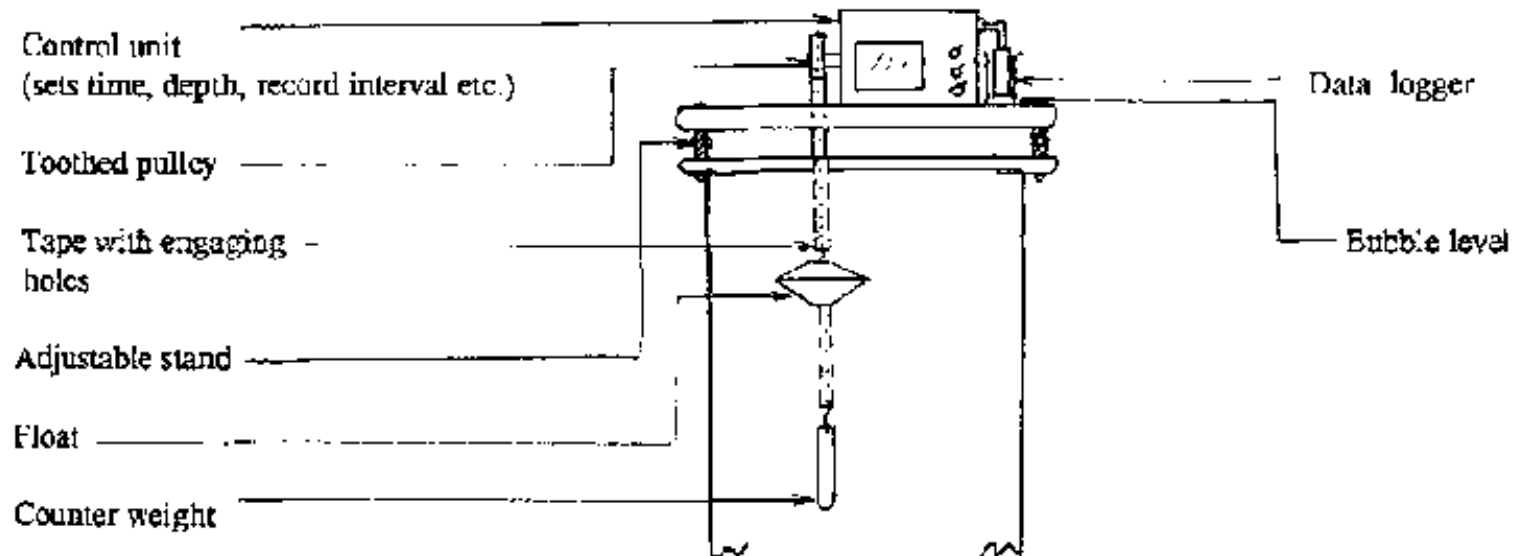
## Operation

### 1. WLRs with Electronic Data Loggers

**In keeping with the general trend towards solid state electronic instrumentation, this type of WLR is becoming increasingly common, but the float and counterweight, mechanical aspect of these recorders is still very much the same as orthodox chart recorders. The operation of these WLRs is discussed prior to installation procedures, as it is assumed that familiarity with the equipment will be desired before selection or installation in the field.**

**Changes in water level are detected by a float which sits on the water level in the stilling well, connected to a stainless steel tape or wire that ascends to and over a pulley connected to the recorder. At the other end of the tape or wire which descends from the pulley a counterweight is fitted to balance the mass of the float.**

**As the float rises and/or falls, this movement is registered via the pulley axle. The rotational movement of the axle is converted into electrical signals by an electronic integrator. These signals are passed on to the main processing unit and then to the data logger, at pre-set time intervals specified by the operator. Figure 2.41 below shows a typical electronic WLR set to an H flume stilling well.**



**Figure 2.41: Electronic Water Level Recorder set in H flume Stilling Well**

**These recorders are compact and good designs are very robust. The main processing unit is powered by dry cell (preferably alkaline) batteries which should last for a year and which can easily be replaced. In many cases the loggers are powered by integral lithium batteries which last for up to ten years, but which can only be replaced by the manufacturer. These batteries enable the loggers to be removed from the recorder without the loss of data. The electronic components of the loggers are usually resin-sealed to prevent damage. Their operation is relatively simple. Once installed, facilities are available to label the recorder number, date and time. (Typically, these are recorded as a heading prior to the water level data and**

**can be viewed when the data are down-loaded). This information is usually displayed on an LCD screen, which is located on the processing unit and is easily revised by using various switches.**

**The time interval that is desired for the data to be recorded is adjusted and displayed in a similar way and provides a very flexible facility. Time periods usually range from 1 minute to 24 hours, in 1 minute steps. Changes of date are normally recorded. Readings are precise to 1 mm, but the accuracy of this sensitivity depends on the correct installation and operation of the recorder and measuring section of the control. When a replacement logger is installed, the heading information is usually written on to it automatically. The recorders are capable of recording level differences (zero to maximum) of 100 m, but tapes and wires can be purchased or cut to any desired length. Ensure before purchase, that the correct type of power batteries are easily available.**

**Avoid the temptation to leave recorders untended for very long periods, just because the loggers allow this. It increases the probability of undetected faults, damage by flood, vandalism and theft. Data that are lost can never be replaced. In addition to the annoyance and loss of data, the misuse of such expensive equipment will greatly reduce its cost-benefit to the project. The more frequent the visits, even to automatically recording equipment, the better, though of course each project must decide upon the priority that this activity can take..**

**For small catchments and plots, which will provide short periods of runoff, it is important to make the time interval between the logging of water levels short, perhaps no longer than 5 to 10 minutes. A 32 kb logger should not need to be replaced more frequently than once each week or ten days with a 10 minute record interval. For much larger catchments with longer durations of flow, half or one hour**

**periods may be adequate. For seasonal or perennial streams, records once, twice or four times each day may be suitable. Loggers in these circumstances can remain unchanged for many months. In all cases, the most suitable time interval is a balance between these factors:**

- logger memory size;**
- frequency of site visits;**
- duration of runoff**

**Logger memories vary in size, but 100 kb+ or so is typical. An example data set is illustrated below, from a recorder on a 30 cm H flume: note that no-flow data are also recorded.**

**Level recorder Nr. 0045**

**Level in mm**

**Repeat Period 5 (min)**

D T	"90/02/07	23:05 "
P 0		
P 0		
P 3		
P 7		
P 11		
P 11		

P 55		
P 110		
P 114		
P 107		
P 86	"90/02/08	00:00"
P 65		
P 33		
P 27		
etc.		

**Spare batteries and the tools to replace them should always be carried on site visits, a note of the visit and logger change should be kept. It is difficult to check batteries with a voltmeter and experience is the best indication as to how long they will last. Recorders set on flumes etc. are unlikely to require replacement floats and counterweights if treated properly, though sometimes spares are useful.**

**Data are usually down-loaded into computer storage by a program provided by the manufacturer. When this is done, the data in the logger is marked for erasure by new data.**

## **2. Chart Water Level Recorders**

**These recorders have a relatively complicated mechanical action, though this will vary to some extent according to manufacturer, whose instructions must be closely adhered to. The float and counterweight system is similar to that describe above. Typically, the action of the pulley, as the float rises, rotates a horizontal bar along**

**which is a sunk spiral thread. Along this thread a pen and ink carriage is moved to the right by the rotation until it reaches the end of the bar, if the rotation of the bar continues the pen action reverses and it moves to the left along a counter-spiral. In this way the pen traces zig-zags along the chart. When the float falls, the action of the pen is reversed. This allows a wide range in levels to be recorded.**

**Particular care is needed on two points. First, the chart must be accurately placed on the drum according to its marked, correct position. Second, the pen must be accurately placed at the zero position after the chart is replaced. The adjustments for the speed of the drum can be altered to allow longer or shorter times between chart replacement. This is effected by changing part of the gearing mechanism (provided by the manufacture according to request) or engaging different cogs, often by a lever or sliding rod. Figure 2.42 below shows an example of this type of equipment.**

**It is important that the ink supply is adequate and that the pen functions properly, drying can be a problem in hot climates. The timing of the clock should be monitored and corrected if necessary. Before and after field installation, the pen should be checked that it turns at the correct place on the chart. Details of recorder number, date etc. can be written onto the chart. Analysis of the data is according to the level/time pen trace and can be undertaken (for flow volumes) by digitiser or by hand.**

**Charts should be clearly identified with station, recorder number date and time of removal, checks with manual gauges and checks on pen reversal. Change-overs from rising to falling flow, time corrections because of fast or slow clock running marked to the nearest minute and pen relocations should be recorded in pencil on the chart at the correct point. Make sure that the pen moves freely by rotating the**

**pulley to raise the float tape. A free pen will make a perpendicular mark which should be noted as a check. The chart should be replaced on immediate arrival so that time can be spent to check that the equipment is working correctly. It is important to instil a regular routine for each inspection.**

**In the case of both electronic and chart recorders, the diameter of the float and the length of the counterweight should be appropriate to the size of the stilling well. No contact with the well sides should be allowed.**

### **Installation of WLRs on Small Artificial Controls, Flumes and small V-notch weirs**

**The installation of water level recorders on to such equipment as H flumes and V-notch weirs was covered earlier. This procedure is straightforward and the same for both kinds of recorder. The main points of installation are the same for all control types: the tape and counterweight should move freely after the recorder has been set horizontally, as indicated by the spirit level provided on the recorder. The details of setting the recorder heading and time period or placing the chart and pen will depend on the manufacturer's specifications, but will be broadly similar to the above.**

### **Installation on Natural Controls and Large Artificial Controls**

**The installation of the stilling wells for WLRs using large artificial and natural controls, whether electronic or chart, is a costly and difficult process. On the whole, agrohydrological and water harvesting projects will be concerned with small plot or catchment runoff, but the need to install WLRs to measure larger runoff amounts may be an important adjunct to these activities. The basic requirements of installation are described here.**



**The need in these circumstances, is to provide a large stilling well upon which the WLR can sit. The structure should be:**

- Robust enough to withstand peak flows.**
- Sited upstream of the control.**
- It is of great advantage if the WLR can be secured to a solid structure such as a bridge, or attached to the control by supports.**
- It should be placed in a relatively protected location.**
- Access should be available at all stages of the river (for example by providing steps which ascend the structure or a walkway from the bank).**
- Installation is best done in the driest season.**
- Perforated steel water pipe or cemented pre-cast concrete sections can be used.**
- To place the well in the lowest part of the channel, (perennial) streams must be diverted to allow access to bedrock. In sand rivers, air or water jetting can be used to sink the pipe, but the danger of it being washed away remains.**
- If absolute minimum flows are not required, a diversion is not necessary.**
- Heavy lifting gear will be necessary.**

**- Artificial controls may have to be dug clear of sediment during the dry season, especially in sand rivers.**

**- A series of staff gauges must be emplaced as a check on WLR operation.**

**Advice from local organisations familiar with the installation of such structures should be sought at the earliest planning stage. Construction may be beyond the time and resources of the project and less precise estimates of flows may release valuable resources for other work.**

### **3. Bubble gauge (servo-manometer)**

**Generally, most advantages lie with the WLRs described above and so this description of bubble gauges, is brief, though this type of gauge is quite commonly used in the USA.**

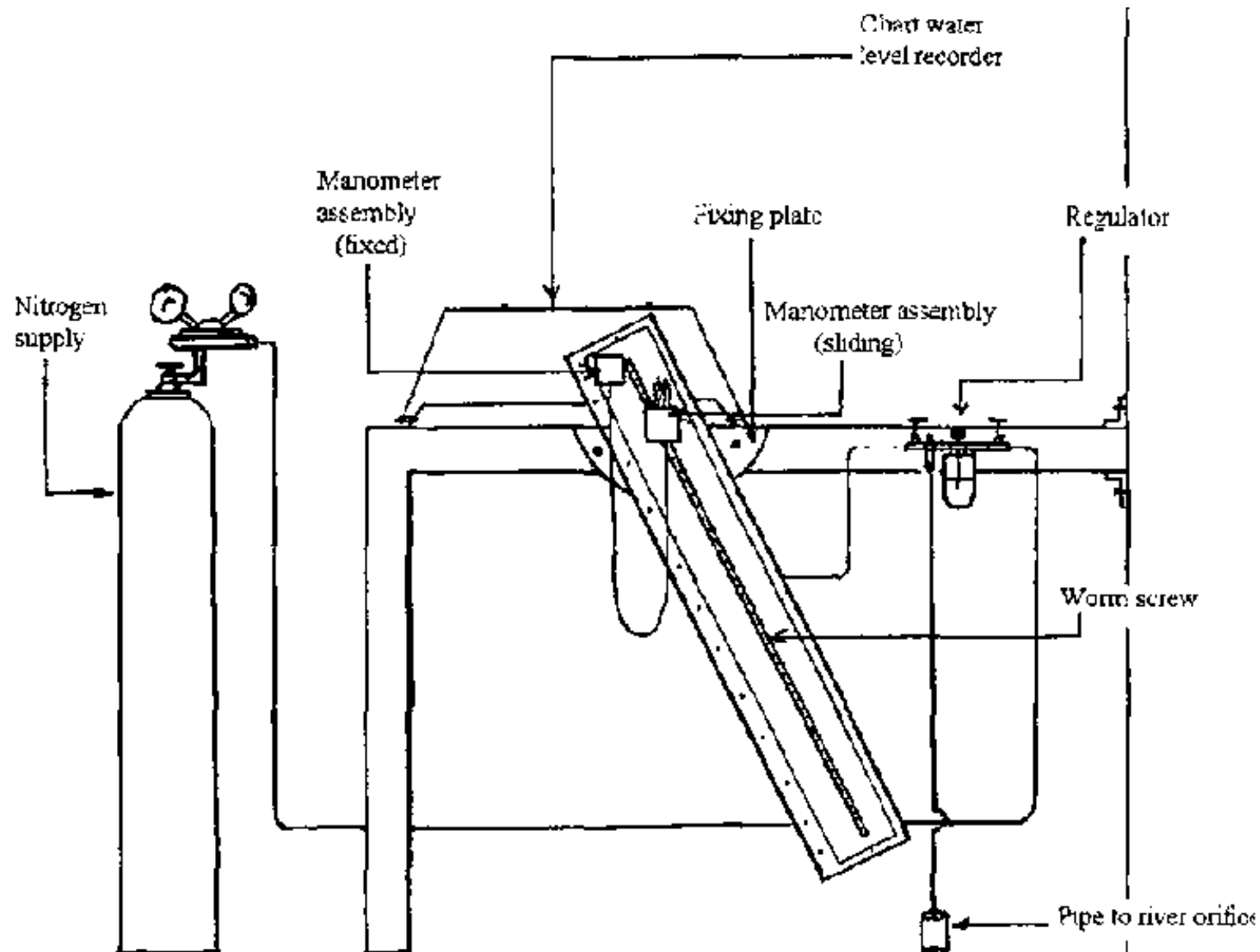
**Where rivers are subject to violent peak flows with the likely loss of WLRs, these gauges have the distinct advantage of being sited away from flood water.**

**The manufacturer's manual should be consulted for detailed testing, installation and operation. Bubble gauges work on the principle of depth of water exerting an opposing pressure, registered by a mercury manometer, on that exerted by a regulated gas (nitrogen) supply from a cylinder. An orifice, with a vented cap to minimise sediment entry, is fixed to the river bed from which a plastic pipe leads to the equipment. The orifice should be located below minimum expected river stage. The changes of river level are recorded by a pen, on to a chart fixed to a clockwork drum.**

**Important points to note are:**

- **The equipment must be housed in a water and vandal-proof hut away from maximum floods.**
- **Sediment entry into the orifice vent must be prevented.**
- **The orifice installation can be jetted or driven into the channel bed, but changes in bed topography may arise.**
- **A spare nitrogen cylinder is necessary, though the rate of gas discharge may be regulated.**
- **One cylinder can last many months.**
- **Care should be taken to ensure the gas regulator operates correctly. This must be tested before installation.**
- **The chart recorders are designed specifically for this kind of manometer instrumentation**
- **Especial care should be taken to avoid damage to the mercury manometer**

**Figure 2.43 shows how the components of a bubble gauge are assembled**



**Figure 2.43: Bubble Gauge with Servo-Manometer**

## Equipment costs

**All costs of locally made equipment are very approximate. The costs of raw**

**materials and especially labour are highly variable from country to country, but a good idea of cost magnitude can be gained from the figures quoted below. The costs of manufactured equipment are based on mid-1993 prices, and where possible have been obtained from a range of manufacturers.**

**Shipping costs, agents fees and fluctuations in exchange rates cannot be taken into account.**

Item	Quantity	Typical Approximate cost in US \$ (1 \$US = £ 0.67)
<b>Locally made equipment</b>		
Simple plastic tanks modified to collect runoff	1	5 - 10
Multi-slot tank set with rain-proof housing	1	500 - 1000
Revolving slot divider	1	300 - 500
Sheet metal (for bunds) cut into 30 cm deep strips	10 m	30 - 50
200 litre Oil drums	1	20 - 50
<b>H flumes, complete and installed</b>		
30 cm deep	1	100 - 200
90 cm deep	1	300 - 1000
30 cm V-notch weir	1	200 - 300
Crest gauge, installed	1	20 - 30
Manual gauge plates, installed	1 m	5 - 20
Hand winch	1	20 - 50
	1	20 - 50
<b>Manufactured Equipment</b>		
Small flumes $0.5 - 28 \text{ l s}^{-1}$	1	500 - 800
Small V-notch weir	1	1500 - 2000
Cup meter with wading set	1	3000 - 4000
Propeller meter as above	1	3000 - 4000
Hand suspension set: bar, cable and weight	1	3000 - 4000
Derrick suspension set	1	2000 - 2500
Water level recorder with float/counter weight etc.		
electronic with data logger	1	3000 - 4000
chart type	1	3000 - 4000

**Figure**

## **Appendix A: Measurement of runoff**

### **Appendix A1: Rating tables for H flumes, HS flumes and HL flumes**

**Rating Tables given in the USDA Agriculture Handbook 224 are in feet and inches. If metric measurements are required, conversions can be made using the following conversion factors. 1 inch 2.54 centimetres 1 foot 0.3048 metres 1 cubic foot 0.02832 cubic metres 28.32 litres**

**Because of the size of increments used in the rating tables (0.1 and 0.01 ft.), interpolation may be necessary when conversions to SI units are undertaken. Linear interpolation is permissible and does not lead to serious inaccuracies. Below are presented two conversions of rating tables to SI units, for a 30 cm deep H flume and for a 90 cm deep H flume. Together, these two sizes of flume and their rating table conversions will cover the range of discharge measurements encountered by most agrohydrological projects.**

Head (cm)	0.0	0.1	0.2	0.3	0.4	0.5	0.6	0.7	0.8	0.9
0	0.0	0.0	0.00	0.001	0.001	0.001	0.020	0.024	0.039	0.048
1	0.063	0.077	0.086	0.095	0.104	0.113	0.128	0.144	0.159	0.177
2	0.194	0.212	0.233	0.254	0.275	0.299	0.322	0.347	0.372	0.399
3	0.425	0.446	0.466	0.487	0.507	0.537	0.568	0.598	0.631	0.664
4	0.697	0.733	0.768	0.804	0.842	0.880	0.918	0.958	0.999	1.039
5	1.083	1.126	1.170	1.216	1.262	1.308	1.358	1.409	1.459	1.512
6	1.564	1.617	1.673	1.728	1.784	1.843	1.901	1.960	2.022	2.085
7	2.147	2.212	2.277	2.342	2.411	2.480	2.549	2.621	2.692	2.764
8	2.839	2.915	2.990	3.069	3.149	3.228	3.309	3.391	3.472	3.561
9	3.649	3.738	3.802	3.866	3.929	3.993	4.087	4.182	4.276	4.371
10	4.465	4.560	4.664	4.767	4.871	4.975	5.079	5.183	5.287	5.390
11	5.494	5.607	5.721	5.834	5.947	6.061	6.174	6.297	6.419	6.542
12	6.665	6.787	6.910	7.033	7.155	7.278	7.410	7.543	7.675	7.807
13	7.939	8.071	8.213	8.354	8.496	8.638	8.779	8.921	9.072	9.223
14	9.374	9.525	9.676	9.827	9.987	10.15	10.31	10.47	10.63	10.79
15	10.95	11.13	11.27	11.44	11.61	11.78	11.91	12.04	12.16	12.29
16	12.47	12.65	12.83	13.01	13.19	13.37	13.56	13.74	13.93	14.12
17	14.51	14.50	14.70	14.90	15.10	15.29	15.49	15.69	15.90	16.11
18	16.31	16.52	16.73	16.94	17.15	17.37	17.59	17.80	18.02	18.24
19	18.46	18.69	18.92	19.15	19.37	19.60	19.84	20.07	20.31	20.55
20	20.80	21.04	21.29	21.53	21.78	22.03	22.29	22.54	22.80	25.05
21	23.31	23.57	23.84	24.10	24.37	24.65	24.92	25.13	25.33	25.54
22	25.74	26.02	26.31	26.59	26.87	27.16	27.44	27.73	28.03	28.32
23	28.61	28.91	29.20	29.50	29.80	30.10	30.41	30.73	31.04	31.35
24	31.66	31.97	32.26	32.56	32.85	33.23	33.60	33.98	34.26	34.55
25	34.84	35.21	35.59	35.97	36.25	36.54	36.82	37.20	37.57	37.95
26	38.33	38.70	39.00	39.36	39.65	39.93	40.31	40.68	41.06	41.44
27	41.84	42.20	42.58	42.95	43.33	43.71	44.08	44.46	44.75	45.03
28	45.32	45.60	46.07	46.54	47.01	47.39	47.76	48.14	48.53	48.91
29	49.30	49.67	50.04	50.41	50.88	51.36	51.83	52.21	52.58	52.96
30	53.43									

### Rating Table 30 cm H Flume (litres second<sup>-1</sup>)

Head (cm)	0.0	0.1	0.2	0.3	0.4	0.5	0.6	0.7	0.8	0.9
-----------	-----	-----	-----	-----	-----	-----	-----	-----	-----	-----



0	0.0	0.0	0.0	0.0	0.02	0.04	0.06	0.08	0.11	0.13
1	0.15	0.18	0.21	0.24	0.27	0.30	0.34	0.37	0.41	0.45
2	0.49	0.53	0.58	0.62	0.67	0.72	0.77	0.82	0.88	0.93
3	0.99	1.05	1.10	1.16	1.22	1.28	1.34	1.41	1.47	1.53
4	1.60	1.67	1.74	1.81	1.88	1.95	2.03	2.11	2.18	2.26
5	2.34	2.42	2.51	2.59	2.68	2.76	2.85	2.94	3.03	3.13
6	3.22	3.31	3.41	3.50	3.61	3.71	3.82	3.94	4.03	4.13
7	4.24	4.34	4.44	4.56	4.67	4.79	4.90	5.01	5.13	5.25
8	5.38	5.50	5.63	5.76	5.90	6.02	6.14	6.27	6.40	6.53
9	6.67	6.81	6.95	7.09	7.24	7.38	7.67	7.67	7.83	7.98
10	8.13	8.28	8.43	8.58	8.74	8.89	9.21	9.21	9.37	9.54
11	9.72	9.89	10.06	10.23	10.40	10.57	10.74	10.74	10.91	11.27
12	11.45	11.63	11.81	11.99	12.18	12.37	12.56	12.76	12.96	13.16
13	13.36	13.56	13.76	13.96	14.16	14.36	14.57	14.78	14.99	15.20
14	15.42	15.64	15.86	16.08	16.30	16.52	16.75	16.98	17.21	17.44
15	17.66	17.89	18.12	18.35	18.58	18.82	19.06	19.31	19.55	19.80
16	20.05	20.29	20.54	20.80	21.05	21.31	21.57	21.82	22.08	22.35
17	22.61	22.88	23.15	23.43	23.70	23.98	24.25	24.53	24.81	25.08
18	25.36	25.64	25.91	26.21	26.51	26.80	27.09	27.39	27.68	27.98
19	28.28	28.58	28.89	29.20	29.52	29.83	30.14	30.46	30.77	31.08
20	31.40	31.71	32.03	32.36	32.68	33.01	33.34	33.68	34.04	34.40
21	34.76	35.04	35.33	35.61	35.99	36.37	36.75	37.13	37.51	37.89
22	38.18	38.46	38.75	39.13	39.51	39.89	40.27	40.65	41.03	41.41
23	41.79	42.17	42.55	42.92	43.30	43.68	44.06	44.44	44.82	45.20
24	45.58	46.06	46.53	47.01	47.39	47.77	48.15	48.53	48.91	49.29
25	49.76	50.24	50.71	51.09	51.47	51.85	52.23	52.61	52.99	53.47
26	53.94	54.42	54.89	55.37	55.84	56.22	56.60	56.98	57.45	57.93
27	58.40	58.88	59.35	59.83	60.30	60.78	61.25	61.73	62.20	62.68
28	63.15	63.63	64.10	64.58	65.05	65.53	66.00	66.48	66.95	67.52
29	68.09	68.66	69.14	69.61	70.09	70.56	71.04	71.51	72.08	72.65
30	73.22	73.69	74.17	74.64	75.21	75.78	76.35	76.83	77.30	77.78
31	78.33	78.92	79.49	80.06	80.63	81.20	81.77	82.34	82.91	83.48
32	84.05	84.62	85.19	85.75	86.32	86.89	87.46	88.03	88.60	89.17
33	89.74	90.31	90.88	91.45	92.02	92.59	93.16	93.83	94.49	95.16
34	95.73	96.30	96.87	97.44	98.01	98.58	99.24	99.91	100.57	101.23
35	101.90	102.56	103.13	103.70	104.27	104.94	105.60	106.27	106.27	107.60

36	108.26	108.93	109.59	110.26	110.92	110.92	112.25	112.92	112.92	114.25
37	114.91	115.57	116.24	116.90	117.57	117.57	118.99	119.75	119.75	121.18
38	121.84	122.51	123.17	123.84	124.50	124.50	126.02	126.78	126.78	128.30
39	129.06	129.72	130.39	131.05	131.81	131.81	133.33	134.09	134.09	135.61
40	136.37	137.13	137.89	138.65	139.41	139.41	140.93	141.69	141.69	143.21
41	143.97	144.73	145.49	146.25	147.01	147.01	148.53	149.29	149.29	151.00
42	151.85	152.61	153.37	154.13	154.99	154.99	156.70	157.45	157.45	158.97
43	159.83	160.68	161.54	162.39	163.25	163.25	164.86	165.62	165.62	167.24
44	168.09	168.95	169.80	170.66	171.51	171.51	173.22	174.07	174.07	175.78
45	176.64	177.59	178.54	179.49	180.34	180.34	182.05	182.91	182.91	184.62

### Rating Table 90 cm H Flume (litres second<sup>-1</sup>)

Head (cm)	0.0	0.1	0.2	0.3	0.4	0.5	0.6	0.7	0.8	0.9
46	185.56	186.51	187.46	188.32	189.17	190.03	190.98	191.93	192.88	193.83
47	194.78	195.73	196.58	197.44	198.29	199.24	200.19	201.14	202.09	203.04
48	203.99	204.94	205.89	206.84	207.79	208.74	209.69	210.73	211.78	212.82
49	213.77	214.72	215.67	216.62	217.57	218.52	219.56	220.61	221.65	222.60
50	223.55	224.50	225.55	226.59	227.64	228.68	229.72	230.77	231.72	232.67
51	233.62	234.66	235.71	236.75	237.80	238.84	239.89	240.93	241.98	243.02
52	244.06	245.11	246.15	247.20	248.24	249.29	250.43	251.57	252.71	253.75
53	254.80	255.84	256.98	258.12	259.26	260.30	261.35	262.39	263.53	264.67
54	265.81	266.95	268.09	269.23	270.28	271.32	272.36	273.50	274.64	275.78
55	276.92	278.06	279.20	280.34	281.48	282.62	283.86	285.09	286.32	287.46
56	288.60	289.74	290.88	292.02	293.16	294.30	295.44	296.58	297.74	298.29
57	299.15	301.04	302.94	304.84	305.79	306.74	307.69	308.64	309.59	310.54
58	311.49	312.44	313.39	315.29	317.19	319.09	320.04	320.99	321.94	322.89
59	323.84	324.79	326.69	328.59	330.48	331.43	332.38	333.33	335.23	337.13
60	339.03	339.98	340.93	341.88	342.83	343.78	344.73	346.63	348.53	350.43
61	351.38	352.33	353.28	355.12	357.07	358.97	359.92	360.87	361.82	362.77
62	363.72	364.67	366.57	368.47	370.37	371.32	372.27	373.22	375.12	377.02
63	378.92	379.87	380.82	381.77	383.67	385.56	387.46	388.41	389.36	390.31
64	392.21	394.11	396.01	396.96	397.91	398.86	400.76	402.66	404.56	405.51
65	406.46	407.41	409.31	411.21	413.11	414.06	415.00	415.95	417.85	419.75
66	421.65	422.60	423.55	425.50	426.40	428.30	430.20	432.10	434.00	435.90
67	436.85	437.80	438.75	440.65	442.55	444.44	445.39	446.34	447.29	449.19
68	451.00	452.00	453.00	455.00	457.00	459.00	460.00	461.00	462.00	463.00

68	451.09	452.99	454.89	456.79	458.69	459.64	460.59	461.54	461.44	462.34
69	467.24	469.14	471.04	472.93	473.88	474.83	475.78	477.68	479.58	481.48
70	483.38	485.28	487.18	488.13	489.08	490.03	491.93	493.83	495.73	497.63
71	499.53	501.42	503.32	505.22	507.12	508.07	509.02	509.97	511.87	513.77
72	515.67	517.57	519.47	521.37	523.27	525.17	527.07	528.96	530.86	532.76
73	533.71	534.66	535.61	537.51	539.41	541.31	543.21	545.11	547.01	548.91
74	550.81	552.71	554.61	556.51	558.40	560.30	562.20	564.10	565.05	566.00
75	566.95	568.85	570.75	572.65	574.55	576.45	578.35	580.25	582.15	584.05
76	585.94	587.84	589.74	591.64	593.54	595.44	597.34	599.24	601.14	603.04
77	604.94	606.84	608.74	610.64	612.54	614.43	616.33	618.23	620.13	622.03
78	623.93	625.83	627.73	629.63	631.53	633.43	635.33	637.23	639.13	641.03
79	642.92	644.82	646.72	648.62	650.52	652.42	654.32	656.22	658.12	660.02
80	661.92	663.82	665.72	667.62	669.52	671.41	673.31	675.21	677.11	679.01
81	680.91	682.81	694.71	686.61	688.51	690.41	692.31	694.21	696.11	698.01
82	699.90	701.80	703.70	705.60	707.50	709.40	712.25	715.10	717.95	719.85
83	721.75	723.65	725.55	727.45	729.34	731.24	733.14	735.04	736.94	738.84
84	740.74	742.64	744.54	746.44	749.29	752.14	754.99	756.89	758.78	760.68
85	762.58	764.48	766.38	768.28	770.18	772.08	774.93	777.78	780.63	782.53
86	784.43	786.32	788.22	790.12	792.02	793.92	795.82	797.72	800.57	803.42
87	806.27	808.17	810.07	811.97	813.87	815.76	817.66	819.56	821.46	823.36
88	826.21	829.06	831.91	833.81	835.71	837.61	840.46	843.30	846.15	848.05
89	849.95	851.85	853.75	855.65	857.55	860.40	863.25	866.10	868.95	871.80
90	874.65									

**90 H Flume Rating Table continued**

**Rating Tables for Various Depths of H Flume (feet<sup>3</sup> second<sup>-2</sup>)**

Head (ft)	0.00	0.01	0.02	0.03	0.04	0.05	0.06	0.07	0.08	0.09
0	0	0	0.0004	0.0009	0.0016	0.0024	0.0035	0.0047	0.0063	0.0080
0.1	.0101	.0122	.0146	.0173	.0202	.0232	.0267	.0304	.0343	.0385
0.2	.0431	.0479	.0530	.0585	.0643	.0704	.0767	.0834	.0905	.0979
0.3	.0857	.1139	.1224	.1314	.1407	.1505	.1607	.1713	.1823	.1938
0.4	.205	.217	.230	.244	.257	.271	.285	.300	.315	.331

**Flume 0.5 foot deep**

0	0	(*)	0.0006	0.0013	0.0022	0.0032	0.0046	0.0061	0.0080	0.0101
0.1	.0126	.0151	.0179	.0210	.0242	.0278	.0317	.0358	.0403	.0451
0.2	.0501	.0555	.0612	.0672	.0733	.0802	.0872	.0946	.1023	.1104
0.3	.119	.128	.137	.146	.156	.167	.177	.188	.199	.211
0.4	.224	.237	.250	.263	.277	.291	.306	.321	.337	.353
0.5	.370	.388	.406	.424	.443	.462	.482	.502	.523	.544
0.6	.566	.586	.611	.635	.659	.683	.708	.734	.760	.786
0.7	.813	.841	.869	.898	.927	.957				

**Flume 0.75 foot deep**

Head (ft)	0.00	0.01	0.02	0.03	0.04	0.05	0.06	0.07	0.08	0.09
0	0	(*)	0.0007	0.0017	0.0027	0.0040	0.0056	0.0075	0.0097	0.0122
0.1	.0150	.0179	.0211	.0246	.0284	.0324	.0367	.0413	.0462	.0515
0.2	.0671	.0630	.0692	.0758	.0827	.0900	.0976	.1055	.1138	.1220
0.3	.132	.141	.151	.161	.172	.183	.194	.206	.218	.231
0.4	.244	.257	.271	.285	.300	.315	.331	.347	.364	.381
0.5	.398	.416	.434	.453	.472	.492	.512	.533	.554	.576
0.6	.598	.621	.644	.668	.692	.717	.743	.769	.796	.823
0.7	.851	.880	.909	.939	.969	1.000	1.031	1.063	1.096	1.129
0.8	1.16	1.20	1.23	1.27	1.30	1.34	1.38	1.41	1.45	1.49
0.9	1.53	1.57	1.61	1.66	1.70	1.74	1.78	1.82	1.87	1.92

**Flume 1.0 foot deep**

0	0	0	0.0011	0.0023	0.0039	0.0057	0.0078	0.0103	0.0131	0.0154
0.1	.0200	.0237	.0276	.0319	.0365	.0414	.0467	.0523	.0582	.0545
0.2	.0711	.0780	.0854	.0931	.1011	.1095	.1183	.1275	.1371	.1470
0.3	.157	.168	.179	.191	.203	.215	.228	.241	.255	.269
0.4	.283	.298	.314	.330	.346	.362	.380	.398	.416	.435
0.5	.454	.473	.492	.514	.535	.557	.579	.601	.624	.648
0.6	.672	.697	.722	.747	.773	.800	.827	.855	.883	.912
0.7	.942	.972	1.002	1.033	1.065	1.097	1.130	1.163	1.197	1.231
0.8	1.27	1.30	1.34	1.38	1.41	1.45	1.49	1.53	1.57	1.61
0.9	1.65	1.69	1.73	1.78	1.82	1.86	1.91	1.95	2.00	2.05
1.0	2.09	2.14	2.19	2.24	2.30	2.35	2.40	2.45	2.50	2.56
1.1	2.61	2.67	2.73	2.78	2.84	2.90	2.96	3.02	3.08	3.14
1.2	3.20	3.27	3.33	3.39	3.46	3.52	3.58	3.66	3.73	3.80
1.3	3.87	3.94	4.01	4.08	4.15	4.22	4.30	4.37	4.45	4.52
1.4	4.60	4.68	4.76	4.84	4.92	5.00	5.08	5.16	5.24	5.33

### Flume 1.5 feet deep

Head (ft.)	0.00	0.01	0.02	0.03	0.04	0.05	0.06	0.07	0.08	0.09
0	0	0	0.0018	0.0035	0.0061	0.0089	0.0121	0.0158	0.0200	0.0247
0.1	.0298	0.0350	.0406	.0465	.0528	.0595	.0666	.0741	.0820	.0903
0.2	.0959	.1081	.1176	.1275	.1379	.1486	.1597	.1713	.1834	.1960
0.3	.209	.222	.236	.250	.265	.280	.296	.312	.328	.345
0.4	.363	.381	.399	.418	.437	.457	.478	.499	.520	.542
0.5	.564	.587	.611	.635	.659	.684	.710	.736	.763	.790
0.6	.818	.846	.875	.904	.934	.965	.996	1.027	1.059	1.092
0.7	1.13	1.16	1.19	1.23	1.27	1.30	1.34	1.38	1.41	1.45
0.8	1.49	1.53	1.57	1.61	1.65	1.70	1.74	1.78	1.83	1.87
0.9	1.92	1.96	2.01	2.06	2.11	2.16	2.21	2.26	2.31	2.36
1.0	2.41	2.46	2.51	2.57	2.62	2.68	2.74	2.79	2.85	2.91
1.1	2.97	3.03	3.09	3.15	3.21	3.27	3.33	3.40	3.46	3.53
1.2	3.59	3.66	3.73	3.80	3.86	3.93	4.00	4.07	4.15	4.22
1.3	4.29	4.37	4.44	4.52	4.59	4.67	4.75	4.82	4.90	4.98
1.4	5.05	5.15	5.23	5.31	5.39	5.48	5.56	5.65	5.74	5.82
1.5	5.91	6.00	6.09	6.18	6.27	6.37	6.46	6.55	6.65	6.75
1.6	6.84	6.94	7.04	7.14	7.24	7.34	7.45	7.55	7.66	7.76
1.7	7.86	7.97	8.08	8.19	8.30	8.41	8.53	8.64	8.75	8.87
1.8	8.98	9.10	9.22	9.34	9.45	9.57	9.70	9.82	9.94	10.06
1.9	10.2	10.3	10.4	10.6	10.7	10.8	11.0	11.1	11.2	11.4

**Flume 2.5 feet deep**

FLUME 2.5 FEET DEEP—Con.

Head (ft.)	0.00	0.01	0.02	0.03	0.04	0.05	0.06	0.07	0.08	0.09
2.0	11.5	11.6	11.8	11.9	12.0	12.2	12.3	12.5	12.6	12.7
2.1	12.9	13.0	13.2	13.3	13.5	13.6	13.8	13.9	14.1	14.2
2.2	14.4	14.5	14.7	14.8	15.0	15.1	15.3	15.5	15.6	15.8
2.3	16.0	16.1	16.3	16.4	16.6	16.8	17.0	17.1	17.3	17.5
2.4	17.6	17.8	18.0	18.2	18.3	18.5	18.7	19.1	19.1	19.2

FLUME 3.0 FEET DEEP

Head (ft.)	0	0.01	0.02	0.03	0.04	0.05	0.06	0.07	0.08	0.09
0	0	0	0.0021	0.0045	0.0073	0.0105	0.0143	0.0186	0.0234	0.0288
0.1	.0347	0.0407	.0471	.0538	.0610	.0688	.0768	.0851	.0939	.1032
0.2	.113	.123	.134	.145	.156	.168	.180	.193	.207	.220
0.3	.234	.249	.264	.280	.296	.312	.329	.347	.365	.383
0.4	.402	.421	.441	.462	.483	.504	.526	.549	.572	.596

0.5	0.620	0.644	0.669	0.695	0.721	0.748	0.775	0.803	0.832	0.861
0.6	0.890	0.920	0.951	0.982	1.014	1.047	1.080	1.113	1.147	1.182
0.7	1.22	1.25	1.29	1.33	1.36	1.40	1.44	1.48	1.52	1.56
0.8	1.60	1.65	1.69	1.73	1.78	1.82	1.86	1.91	1.96	2.00
0.9	2.05	2.10	2.15	2.20	2.25	2.30	2.35	2.41	2.45	2.51
1.0	2.57	2.62	2.68	2.73	2.79	2.85	2.91	2.97	3.03	3.09
1.1	3.15	3.21	3.27	3.34	3.40	3.46	3.53	3.60	3.66	3.73
1.2	3.80	3.87	3.94	4.01	4.08	4.15	4.23	4.30	4.37	4.45
1.3	4.53	4.60	4.68	4.76	4.84	4.92	5.00	5.08	5.15	5.24
1.4	5.33	5.41	5.50	5.58	5.67	5.76	5.84	5.93	6.02	6.11
1.5	6.20	6.30	6.39	6.48	6.58	6.67	6.77	6.87	6.96	7.06
1.6	7.16	7.26	7.36	7.47	7.57	7.67	7.78	7.88	7.99	8.10
1.7	8.20	8.31	8.42	8.53	8.64	8.75	8.87	8.98	9.10	9.21
1.8	9.33	9.45	9.56	9.68	9.80	9.92	10.05	10.17	10.29	10.41
1.9	10.5	10.7	10.8	10.9	11.0	11.2	11.3	11.4	11.6	11.7
2.0	11.9	12.0	12.1	12.3	12.4	12.6	12.7	12.8	13.0	13.1
2.1	13.3	13.4	13.6	13.7	13.9	14.0	14.2	14.3	14.5	14.6
2.2	14.8	14.9	15.1	15.3	15.4	15.6	15.7	15.9	16.1	16.2
2.3	16.4	16.6	16.7	16.9	17.1	17.2	17.4	17.6	17.8	17.9
2.4	18.1	18.3	18.5	18.7	18.8	19.0	19.2	19.4	19.6	19.8
2.5	19.9	20.1	20.3	20.5	20.7	20.9	21.1	21.3	21.5	21.7
2.6	21.9	22.1	22.3	22.5	22.7	22.9	23.1	23.3	23.5	23.7
2.7	23.9	24.1	24.3	24.5	24.7	24.9	25.2	25.4	25.6	25.8
2.8	25.0	25.2	25.5	25.7	25.9	27.1	27.4	27.6	27.8	28.0
2.9	28.3	28.5	28.7	28.9	29.2	29.4	29.7	29.9	30.1	30.4

### Flume 2.5 feet deep - Continued

Head (ft)	0.00	0.01	0.02	0.03	0.04	0.05	0.06	0.07	0.08	0.09
0	0	0	0.0081	0.0066	0.0106	0.0154	0.0208	0.0269	0.0337	0.0413
0.1	0.0496	0.0678	0.0666	0.0758	0.0855	0.0959	0.1067	0.1180	0.1298	0.1420
0.2	0.155	0.168	0.182	0.196	0.211	0.226	0.242	0.259	0.276	0.293
0.3	0.311	0.330	0.349	0.368	0.388	0.409	0.430	0.452	0.474	0.497
0.4	0.520	0.544	0.569	0.594	0.620	0.646	0.673	0.700	0.728	0.755
0.5	0.785	0.815	0.845	0.876	0.907	0.939	0.972	1.005	1.039	1.073
0.6	1.11	1.14	1.18	1.22	1.25	1.29	1.33	1.38	1.41	1.45
0.7	1.49	1.53	1.58	1.62	1.65	1.71	1.75	1.80	1.84	1.89
0.8	1.94	1.99	2.04	2.09	2.14	2.19	2.24	2.29	2.35	2.40

0.9	2.45	2.51	2.56	2.62	2.68	2.74	2.79	2.85	2.91	2.98
1.0	3.04	3.10	3.16	3.22	3.29	3.35	3.42	3.49	3.55	3.62
1.1	3.69	3.76	3.83	3.90	3.97	4.04	4.12	4.19	4.27	4.34
1.2	4.42	4.50	4.58	4.65	4.73	4.81	4.89	4.98	5.06	5.14
1.3	5.22	5.31	5.39	5.48	5.57	5.66	5.74	5.83	5.92	6.02
1.4	6.11	6.20	6.29	6.39	6.48	6.58	6.68	6.77	6.87	6.97
1.5	7.07	7.17	7.27	7.37	7.48	7.59	7.69	7.80	7.90	8.01
1.6	8.12	8.23	8.34	8.45	8.56	8.68	8.79	8.90	9.02	9.14
1.7	9.25	9.37	9.49	9.61	9.73	9.85	9.98	10.10	10.22	10.35
1.8	10.5	10.6	10.7	10.8	11.0	11.1	11.2	11.4	11.5	11.6
1.9	11.8	11.9	12.0	12.2	12.3	12.5	12.6	12.8	12.9	13.0
2.0	13.2	13.3	13.5	13.6	13.7	13.9	14.1	14.2	14.4	14.5
2.1	14.7	14.8	15.0	15.2	15.3	15.5	15.6	15.8	15.9	16.1
2.2	16.3	16.4	16.6	16.8	16.9	17.1	17.3	17.4	17.6	17.8
2.3	18.0	18.1	18.3	18.5	18.7	18.8	19.0	19.2	19.4	19.6
2.4	19.7	19.9	20.1	20.3	20.5	20.7	20.9	21.0	21.2	21.4
2.5	21.5	21.8	22.0	22.2	22.4	22.6	22.8	23.0	23.2	23.4
2.6	23.6	23.8	24.0	24.2	24.4	24.6	24.9	25.1	25.3	25.5
2.7	25.7	25.9	26.1	26.4	26.6	26.8	27.0	27.2	27.4	27.7
2.8	27.9	28.1	28.4	28.6	28.8	29.0	29.3	29.5	29.7	30.0
2.9	30.2	30.4	30.7	30.9	31.2	31.4	31.7	31.9	32.2	32.4
3.0	32.7	32.9	33.2	33.4	33.7	33.9	34.2	34.4	34.7	35.0
3.1	35.2	35.5	35.8	36.0	36.3	36.6	36.8	37.1	37.4	37.7
3.2	37.9	38.2	38.5	38.8	39.0	39.3	39.6	39.9	40.2	40.5
3.3	40.8	41.2	41.3	41.6	41.9	42.2	42.5	42.8	43.1	43.4
3.4	43.7	44.0	44.3	44.6	44.9	45.2	45.5	45.8	46.1	46.4
3.5	46.8	47.1	47.4	47.7	48.0	48.3	48.6	49.0	49.3	49.6
3.6	49.9	50.3	50.6	50.9	51.2	51.6	51.9	52.2	52.6	52.9
3.7	53.2	53.6	53.9	54.3	54.6	54.9	55.3	55.6	56.0	56.3
3.8	58.7	59.0	59.4	59.7	59.9	58.4	58.8	59.2	59.5	59.9
3.9	60.2	60.6	61.0	61.3	61.7	62.1	62.4	62.8	63.2	63.6
4.0	63.9	64.3	64.7	65.1	65.4	65.8	66.2	66.6	67.0	67.4
4.1	67.8	68.2	68.5	68.9	69.3	69.7	70.1	70.5	70.9	71.3
4.2	71.7	72.1	72.5	72.9	73.3	73.8	74.2	74.6	75.0	75.4
4.3	75.8	76.2	76.6	77.1	77.5	77.9	78.3	78.8	79.2	79.6
4.4	80.0	80.5	80.9	81.3	81.8	82.2	82.6	83.1	83.5	84.0



<sup>1</sup> Rating derived from tests made by the Soil Conservation Service at the Hydraulic Laboratory of the National Bureau of Standards using 1-on-8 sloping false floor.

<sup>2</sup> Trace.

## Flume 4.5 feet deep

### FLUME 0.4 FOOT DEEP

Head (feet)	0.00	0.01	0.02	0.03	0.04	0.05	0.06	0.07	0.08	0.09
0	0	( <sup>2</sup> )	0.00016	0.00027	0.00034	0.00048	0.00141	0.00194	0.00258	0.00332
0.1	.00417	0.00509	.00608	.00717	.00837	.00968	.0111	.0126	.0143	.0161
0.2	.0179	.0200	.0221	.0244	.0268	.0293	.0320	.0348	.0378	.0409
0.3	.0441	.0475	.0511	.0548	.0586	.0626	.0668	.0711	.0756	.0803

### FLUME 0.6 FOOT DEEP

Head (feet)	0	( <sup>2</sup> )	0.00023	0.00053	0.00091	0.00138	0.00193	0.00259	0.00335	0.00421
0.1	.00517	0.00625	.00742	.00867	0.100	.0115	.0131	.0148	.0166	.0185
0.2	.0207	.0229	.0252	.0277	.0303	.0330	.0359	.0389	.0421	.0454
0.3	.0489	.0524	.0562	.0601	.0641	.0683	.0727	.0772	.0819	.0868
0.4	.0918	.0970	.102	.108	.114	.120	.126	.132	.138	.145
0.5	.152	.159	.166	.173	.181	.188	.196	.205	.213	.221

### FLUME 0.8 FOOT DEEP

Head (feet)	0	( <sup>2</sup> )	0.00030	0.00068	0.00116	0.00174	0.00242	0.00322	0.00412	0.00513
0.1	.00625	0.00750	.00884	.0103	.0118	.0135	.0153	.0172	.0193	.0214
0.2	.0237	.0262	.0287	.0314	.0343	.0373	.0404	.0437	.0471	.0506
0.3	.0543	.0582	.0622	.0664	.0708	.0752	.0799	.0847	.0897	.0949
0.4	.100	.106	.111	.117	.123	.129	.136	.142	.149	.156
0.5	.163	.170	.178	.186	.193	.202	.210	.219	.227	.236
0.6	.245	.254	.264	.273	.283	.293	.303	.314	.325	.336
0.7	.347	.358	.370	.381	.393	.406	.418	.431	.444	.457

### FLUME 1.0 FOOT DEEP

Head (feet)	0	( <sup>2</sup> )	0.00037	0.00083	0.00141	0.00209	0.00290	0.00384	0.00489	0.00606
0.1	.00736	0.00882	.0103	.0120	.0137	.0157	.0177	.0198	.0221	.0245
0.2	.0270	.0297	.0325	.0355	.0386	.0418	.0452	.0488	.0525	.0563
0.3	.0603	.0645	.0688	.0733	.0779	.0827	.0877	.0929	.0981	.104
0.4	.109	.116	.121	.127	.134	.140	.147	.154	.161	.168
0.5	.176	.183	.191	.199	.208	.216	.225	.233	.243	.252
0.6	.261	.271	.281	.291	.301	.311	.321	.331	.341	.351

0.6	.261	.271	.281	.291	.301	.312	.322	.333	.344	.355
0.7	.367	.379	.391	.402	.415	.428	.441	.454	.468	.481
0.8	.495	.509	.524	.538	.553	.568	.583	.599	.614	.630
0.9	.646	.662	.680	.697	.714	.731	.749	.767	.785	.803

<sup>1</sup> Rating derived from tests made by the U.S. Department of Agriculture's Soil Conservation Service at Washington, D.C., and Minneapolis, Minn. Table prepared April 1941.

<sup>2</sup> Trace.

## Rating Tables for Various Depths of HS Flumes (feet<sup>3</sup> second<sup>-1</sup>)

Head (feet)	0.00	0.01	0.02	0.03	0.04	0.05	0.06	0.07	0.08	0.09
0	0	( <sup>2</sup> )	0.005	0.012	0.020	0.029	0.039	0.050	0.062	0.075
0.1	.069	0.103	.119	.135	.152	.170	.190	.211	.232	.255
0.2	.278	.302	.327	.352	.378	.405	.434	.465	.497	.530
0.3	.565	.602	.635	.670	.705	.740	.780	.820	.860	.900
0.4	.940	.992	1.03	1.08	1.12	1.17	1.22	1.27	1.32	1.37
0.5	1.42	1.48	1.53	1.59	1.64	1.70	1.76	1.82	1.88	1.94
0.6	2.01	2.07	2.14	2.21	2.28	2.35	2.42	2.49	2.56	2.64
0.7	2.71	2.79	2.87	2.95	3.03	3.11	3.19	3.28	3.36	3.44
0.8	3.53	3.61	3.70	3.79	3.88	3.98	4.08	4.18	4.28	4.38
0.9	4.43	4.53	4.63	4.73	4.90	5.01	5.12	5.23	5.34	5.45
1.0	5.56	5.68	5.80	5.92	6.04	6.16	6.28	6.40	6.52	6.64
1.1	6.76	6.89	7.02	7.15	7.28	7.41	7.54	7.67	7.80	7.93
1.2	8.06	8.20	8.35	8.50	8.65	8.80	8.95	9.10	9.25	9.40
1.3	9.55	9.70	9.90	10.1	10.2	10.4	10.5	10.7	10.8	11.0
1.4	11.2	11.4	11.6	11.7	11.9	12.1	12.3	12.4	12.6	12.8
1.5	13.0	13.2	13.3	13.5	13.7	13.9	14.1	14.3	14.5	14.7
1.6	14.9	15.1	15.3	15.5	15.7	15.9	16.2	16.4	16.6	16.8
1.7	17.0	17.2	17.4	17.5	17.8	18.1	18.3	18.5	18.7	19.0
1.8	19.2	19.4	19.7	19.9	20.2	20.4	20.6	20.9	21.2	21.4
1.9	21.7	21.9	22.1	22.4	22.7	23.0	23.2	23.4	23.7	24.0
2.0	24.2	24.5	24.8	25.0	25.3	25.6	25.8	26.1	26.4	26.7
2.1	27.0	27.3	27.6	27.9	28.2	28.5	28.8	29.1	29.4	29.7
2.2	30.0	30.3	30.6	30.9	31.2	31.5	31.9	32.2	32.5	32.8
2.3	33.1	33.5	33.8	34.1	34.5	34.9	35.1	35.4	35.6	36.1
2.4	36.5	36.8	37.1	37.4	37.9	38.2	38.5	38.8	39.1	39.5
2.5	39.9	40.3	40.8	41.0	41.4	41.7	42.1	42.4	42.8	43.2
2.6	43.5	43.8	44.2	44.7	45.1	45.5	45.9	46.3	46.6	47.1

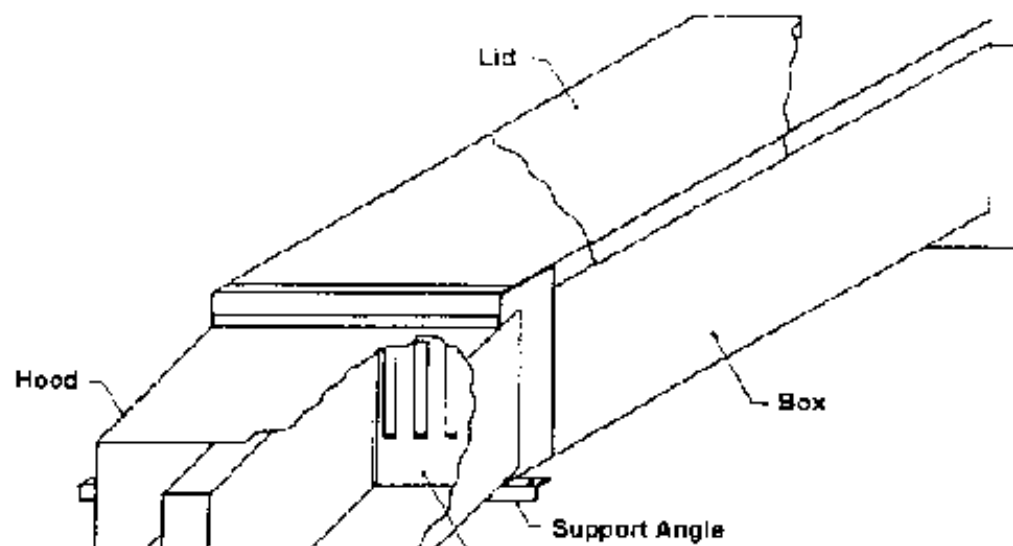
2.6	45.0	45.7	46.3	47.1	48.1	48.9	49.8	50.8	51.8	52.8
2.7	47.5	47.9	48.2	48.6	49.0	49.4	49.8	50.2	50.7	51.1
2.8	51.6	52.0	52.4	52.8	53.3	53.7	54.1	54.5	54.9	55.4
2.9	55.9	56.3	56.7	57.2	57.6	58.1	58.6	59.1	59.5	59.9
3.0	60.3	60.8	61.3	61.8	62.3	62.8	63.2	63.7	64.1	64.6
3.1	65.1	65.6	66.1	66.6	67.1	67.5	68.0	68.5	69.0	69.5
3.2	70.0	70.5	71.0	71.5	72.0	72.5	73.0	73.5	74.0	74.5
3.3	75.0	75.5	76.0	76.5	77.0	77.5	78.2	78.7	79.2	79.9
3.4	80.5	80.9	81.5	82.0	82.5	83.1	83.6	84.2	84.8	85.3
3.5	85.9	86.5	87.1	87.7	88.3	88.9	89.5	90.1	90.7	91.3
3.6	91.9	92.5	93.1	93.7	94.3	94.9	95.5	96.1	96.7	97.4
3.7	98.0	98.6	99.2	99.8	100	101	102	102	103	104
3.8	104	105	106	106	107	107	108	109	109	110
3.9	111	111	112	113	113	114	115	115	116	116
4.0	117									

<sup>1</sup> Rating derived from tests made at the National Bureau of Standards using flat floor.

<sup>2</sup> Trace.

## Rating Tables for HL Flume 4 Feet Deep (feet<sup>3</sup> second<sup>-1</sup>)

### Appendix A2: Construction details of multislotted dividers

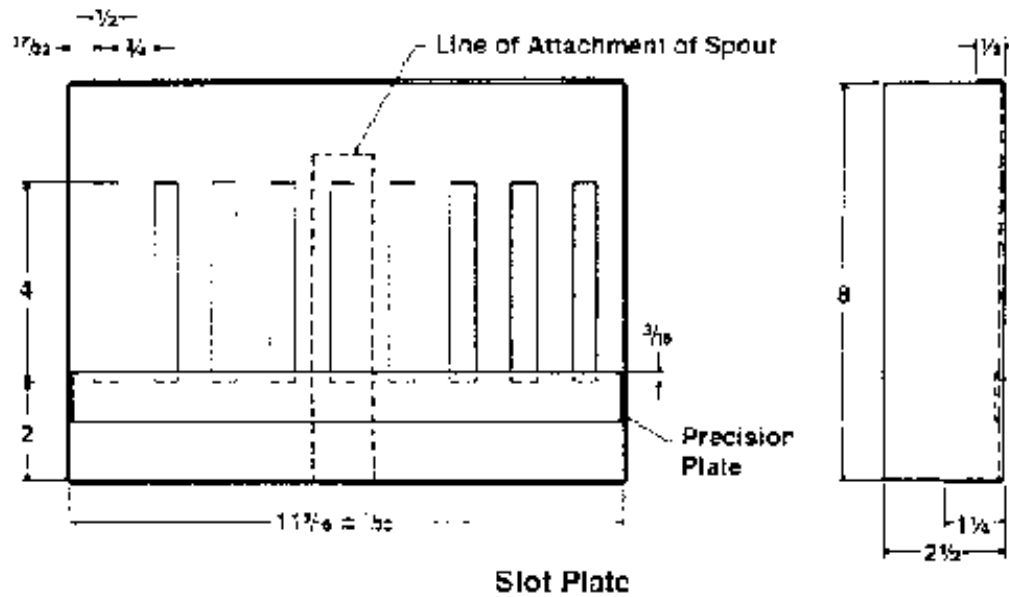


#### Notes

1. Assembly by spotwelding
2. Attach angle to sloplate and box with 3 rivets equally spaced.
3. Solder seams watertight—unit to convey water without leaking—scrape inside seams smooth.

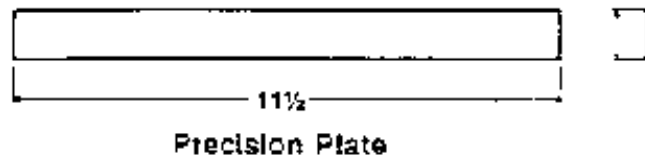
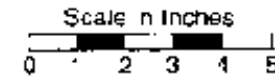


**Multislot Divisor**



**Notes**

1. Materials 18 gauge stainless steel.
2. Make slot plate from single piece — bend after making slots.
3. See specifications for slot tolerances.
4. Spot weld precision plate to slot plate as shown — see specs for further requirements.
5. All dimensions are in inches.

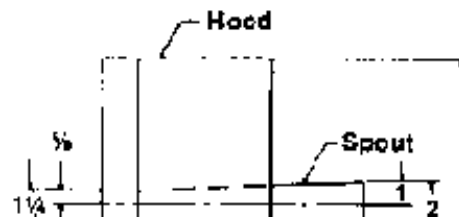


**Precision Plate**

Note: 1 inch = 25.4 mm

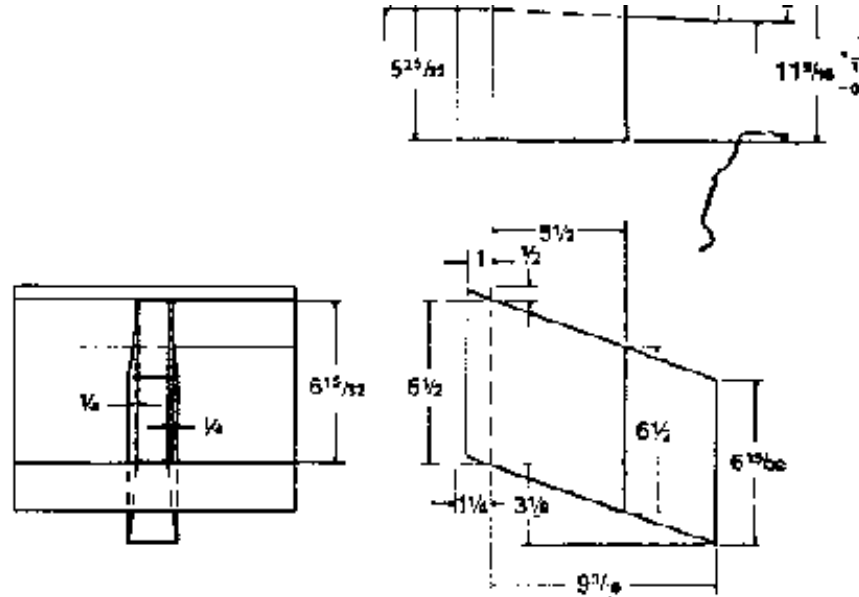
**Slot Plate for Multislot Divisor**

**Figure**

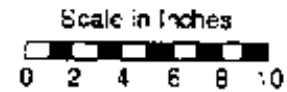


**Notes**

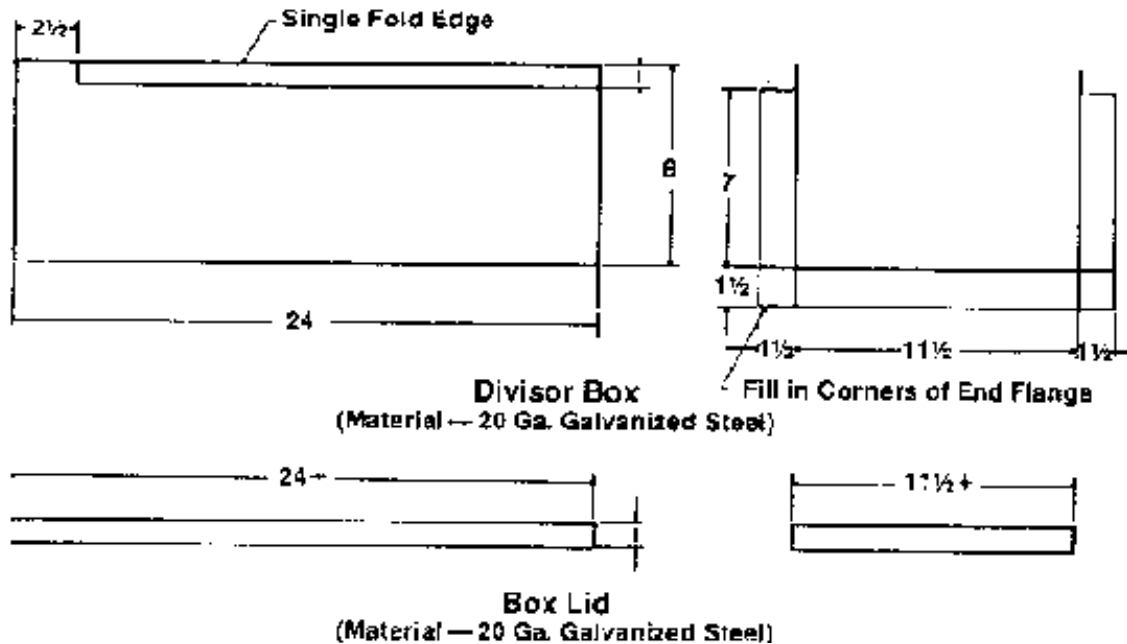
1. All dimensions are in inches — dim. = 1/16 unless otherwise specified.



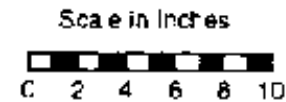
2. Material — 20 gauge galvanized steel.
3. Assemble by spotwelding.

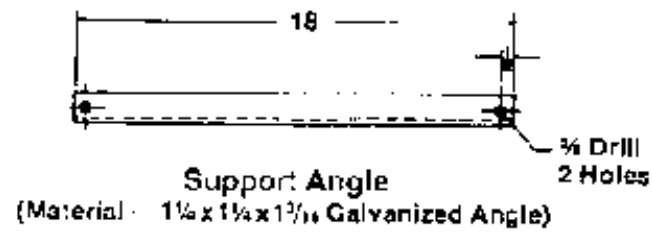


**Spout and Hood for Multiset Divisor**



- Notes**
1. All dimensions are in inches — d m.  $\pm 1/16$  unless otherwise specified.
  2. Make lid to fit snug on box — do not fill in corners of lid.



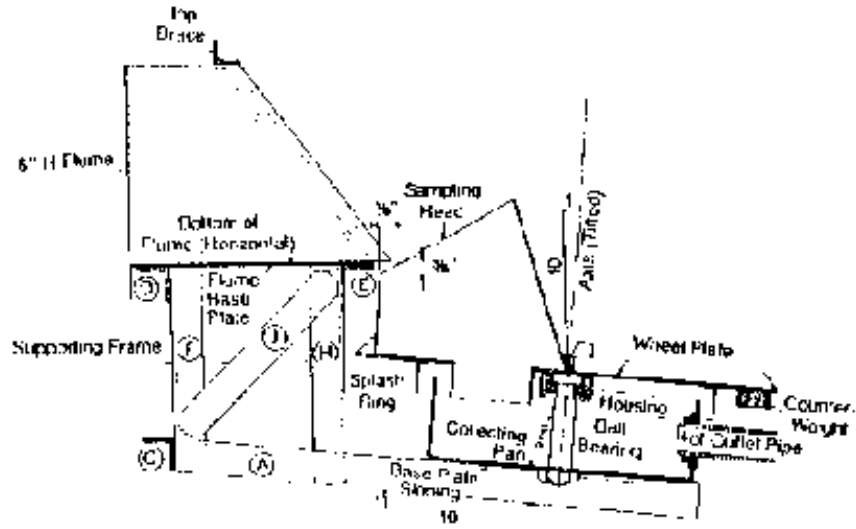


**Box Lid and Support  
Angle for Multislot  
Divisor**

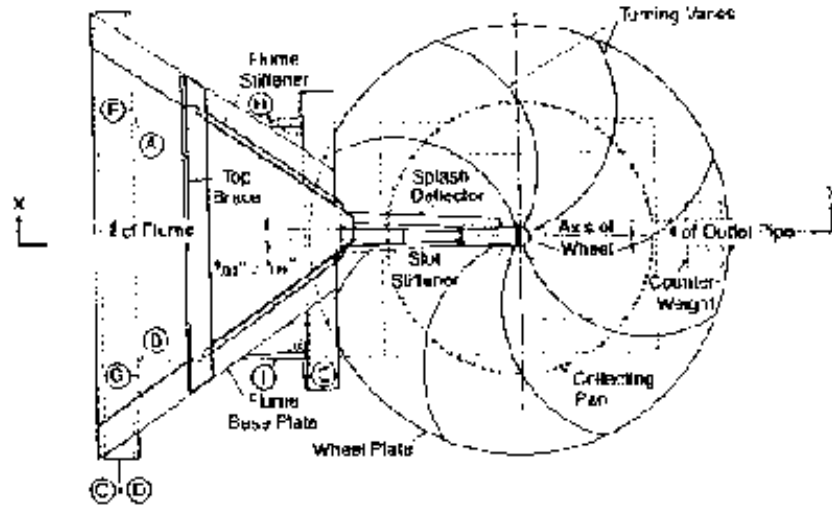
Note: 1 inch = 25.4 mm

**Figure**

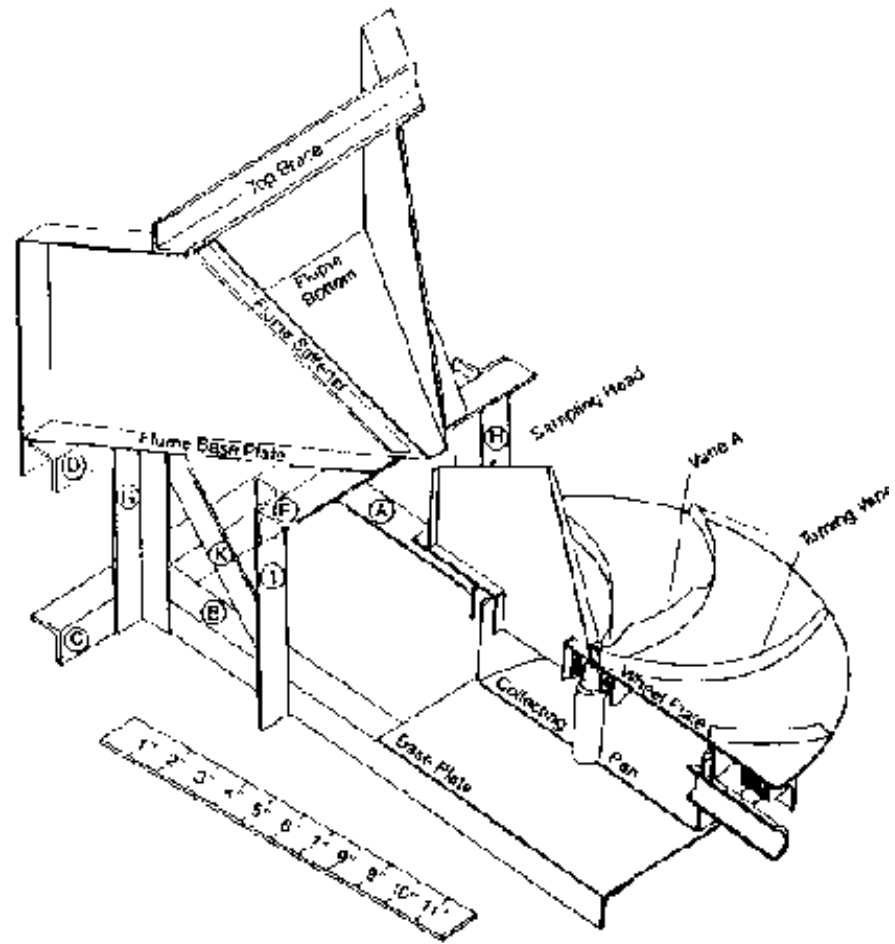
**Appendix A3: Construction details rotary slot dividers**



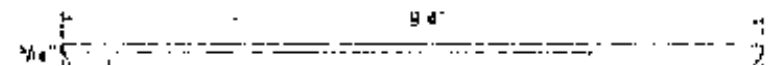
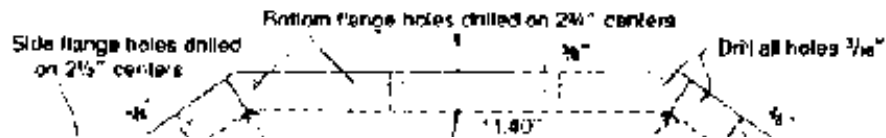
SECTION X-X  
Scale 5" = 1'-0"



TOP VIEW  
Scale 5" = 1'-0"

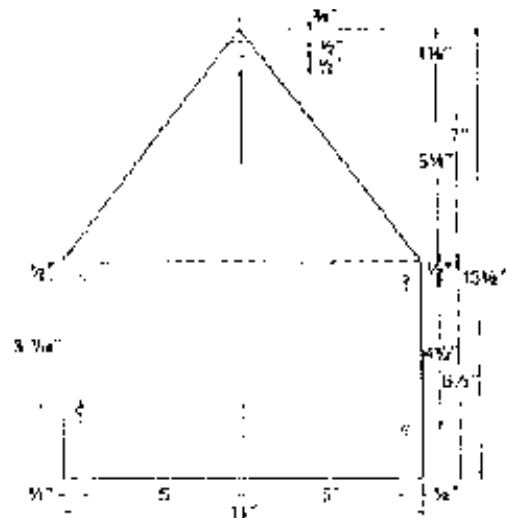


Figure

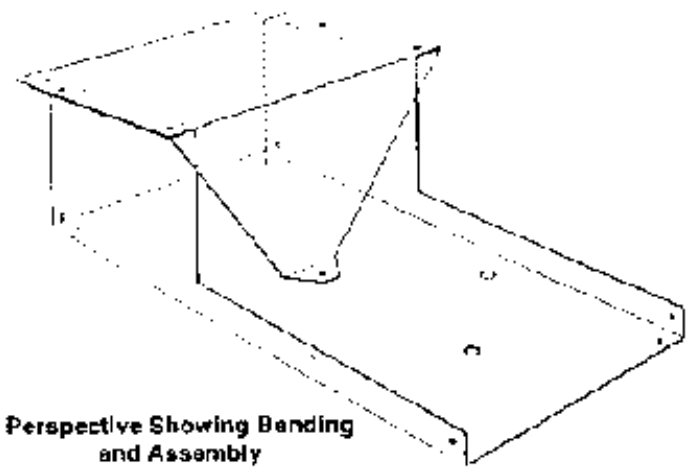




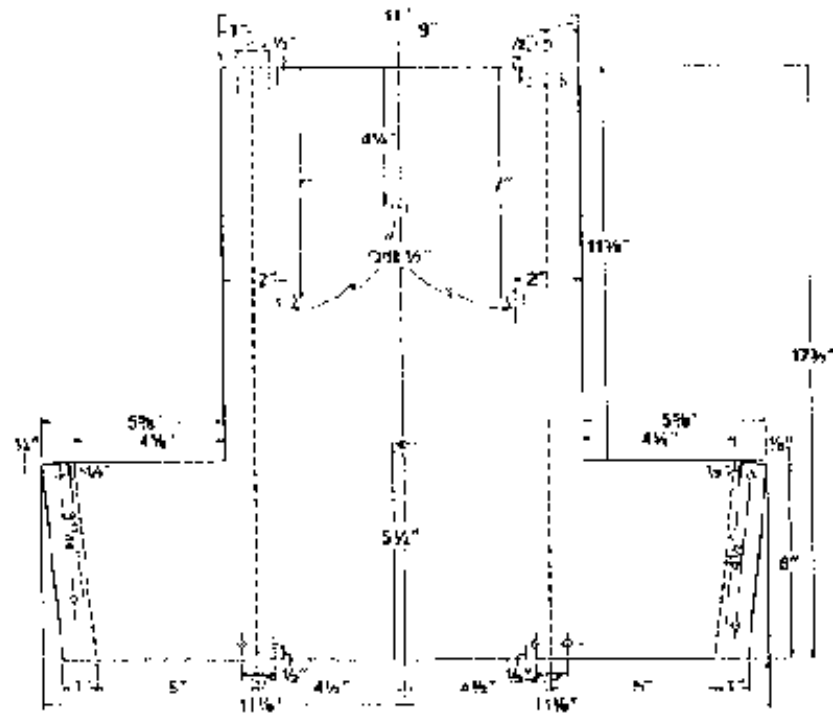




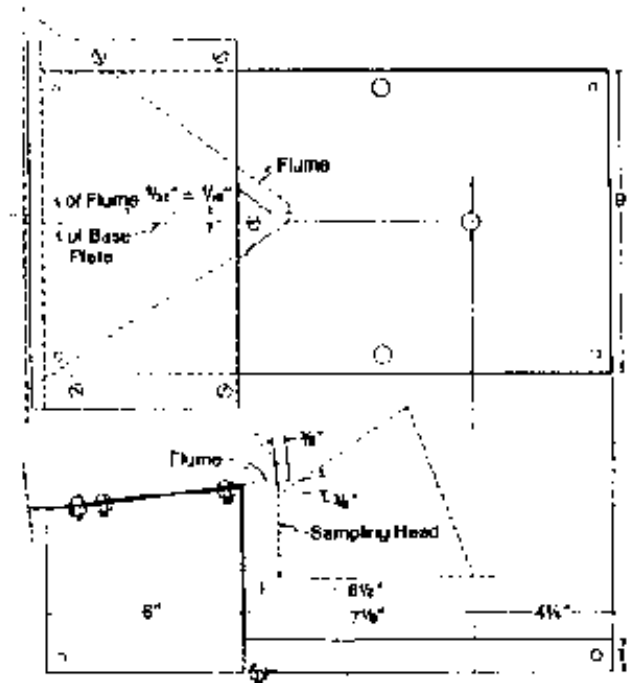
**Base Plate  
for 6-in. Flume**  
(10 Gauge galvanized steel Make 1. Bond on dotted lines)  
All holes 1/4"



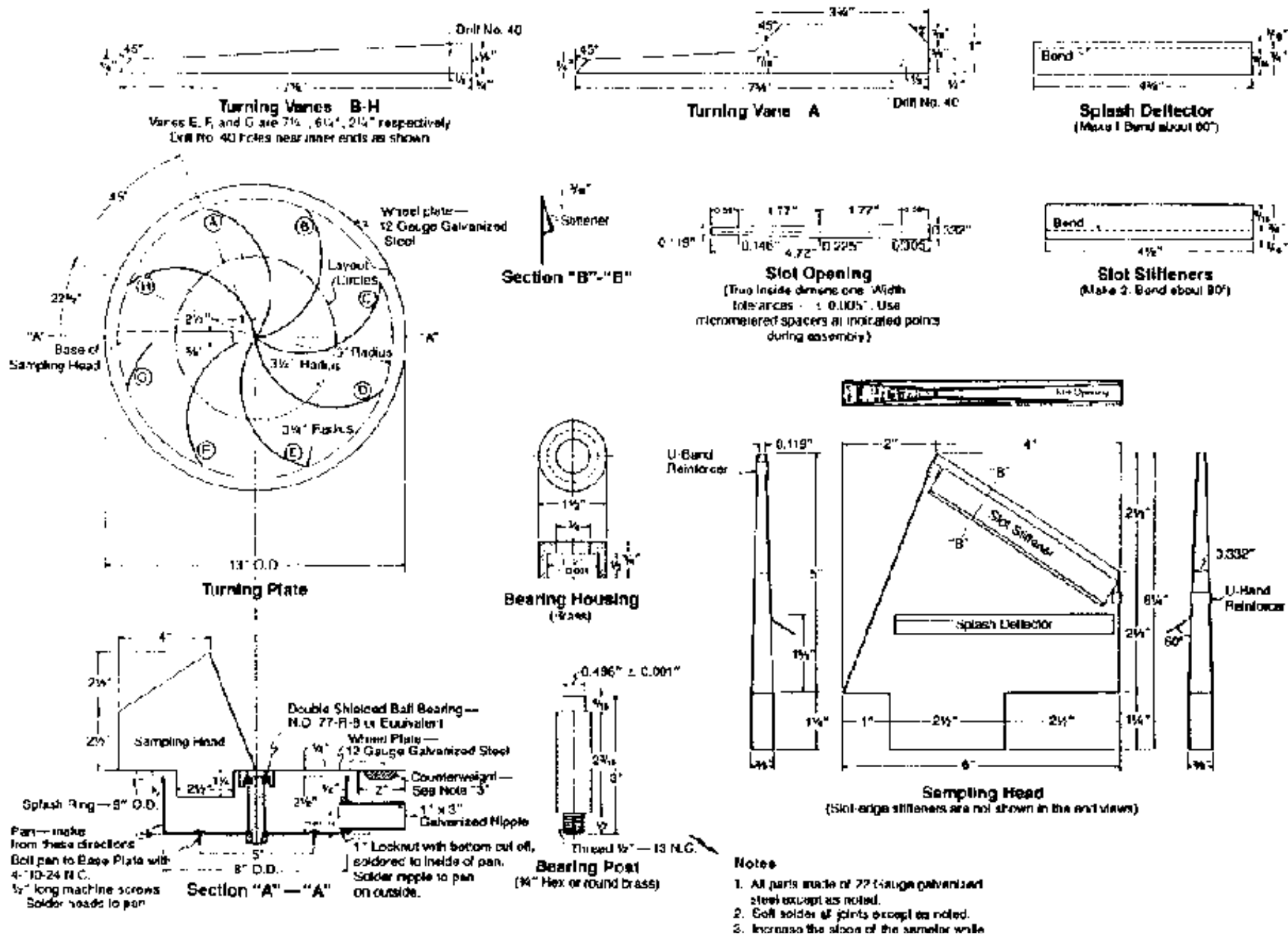
**Perspective Showing Banding  
and Assembly**



**Support for Sampler  
and Base Plate**  
(10 Gauge galvanized steel. Make 1. Bond on dotted line)  
All holes 1/4" except as shown



# Alternate Design for N-1 Coschocton-Type Runoff Sampler



4. The user can change the diameter of the balancing the wheel.
4. Pan, Sampling Head, and connection between Sampling Head and Wheel are to be water-tight.

## Figure

### Appendix A4: Rating table for broad crested (triangular weirs)

For conversions into SI units:

**1 foot = 0.3048 metre,**

**1 square foot = 0.09290 square metre**

**Rating Tables for Various Cross-sectional Areas of Channel 10 Feet (3m) Upstream of Centre of Crest (feet<sup>3</sup> second<sup>-1</sup>)**

1-foot head		2-foot head		3-foot head		4-foot head		5-foot head		6-foot head	
Area	Dis-charge	Area	Dis-charge	Area	Dis-charge	Area	Dis-charge	Area	Dis-charge	Area	Dis-charge
<i>Ft<sup>2</sup></i>	<i>CU/s</i>	<i>Ft<sup>2</sup></i>	<i>CU/s</i>	<i>Ft<sup>2</sup></i>	<i>CU/s</i>	<i>Ft<sup>2</sup></i>	<i>CU/s</i>	<i>Ft<sup>2</sup></i>	<i>CU/s</i>	<i>Ft<sup>2</sup></i>	<i>CU/s</i>
6.0	5.60	13.0	41.3	26.0	132	46	270	72	500	102	900
6.2	5.58	13.2	40.6	26.2	129	47	259	73	480	103	840
6.4	5.56	13.4	40.0	26.4	127	48	250	74	454	104	790
6.6	5.54	13.6	39.4	26.6	125	49	244	75	430	105	750
6.8	5.52	13.8	38.9	26.8	124	50	239	76	437	106	726
7.0	5.51	14.0	38.4	27.0	123	52	231	77	428	107	706
7.2	5.51	14.2	37.9	27.5	119	54	225	78	420	108	692
7.4	5.50	14.4	37.5	28.0	116	56	220	79	413	109	682
7.6	5.49	14.6	37.2	28.5	114	58	216	80	408	110	673
7.8	5.48	14.8	36.9	29.0	112	60	213	82	400	112	660
8.0	5.47	15.0	36.6	30.0	108	62	210	84	393	114	647
8.5	5.45	15.2	36.4	32.0	104	64	207	86	387	116	636
9.0	5.44	15.4	36.2	34.0	102	66	205	88	382	118	627
9.5	5.43	15.6	36.0	36.0	100	68	203	90	378	120	620
10.0	5.42	15.8	35.8	38.0	98.0	70	201	95	370	125	605
11.0	5.41	16.0	35.5	40.0	97.0	72	200	100	364	129	592
12.0	5.40	16.5	35.2	42.0	96.0	74	199	105	359	135	581
13.0	5.40	17.0	34.8	44.0	95.0	76	198	110	354	140	572
14.0	5.39	17.5	34.5	46.0	94.0	78	197	115	350	145	565
15.0	5.39	18.0	34.3	48.0	93.5	80	196	120	346	150	560
20.0	5.38	19.0	33.9	50.0	93.0	82	195	125	343	160	548
25.0	5.37	20.0	33.6	55.0	92.0	84	194	130	341	170	541
30.0	5.35	21.0	33.4	60.0	91.0	86	193	140	337	180	537
35.0	5.35	22.0	33.2	70.0	90.5	88	192	150	334	200	528
40.0	5.35	23.0	33.1	80.0	90.0	90	191	160	331	220	523
45.0	5.35	24.0	33.0	90.0	89.5	100	189	180	328	240	520
50.0	5.35	25.0	32.9	100	89.0	110	187	200	325	270	514
60.0	5.34	30.0	32.5	120	88.8	120	186	230	323	300	510
70.0	5.34	35.0	32.2	140	88.6	130	185	260	321	350	508
80.0	5.34	40.0	32.0	160	88.4	140	185	300	320	400	506
		50.0	31.8	180	88.2	170	184	325	320	450	505
		60.0	31.7	200	88.0	200	183	350	319	500	504
		80.0	31.6	220	88.0	250	183	375	319	550	503
		110.0	31.6	240	88.0	300	183	400	318	600	502
		150.0	31.6	260	88.0	350	183	450	318	650	501

## 2:1 Triangular weirs

8.0	8.37	20.0	57.3	40.0	168	70.0	425	110	715	160	1100
8.5	8.39	22.0	64.4	41.0	180	72.0	488	115	656	162	1075
9.0	8.25	24.0	52.7	42.0	175	74.0	373	120	625	164	1050
9.5	8.22	26.0	51.5	44.0	167	76.0	360	125	605	166	1025
10.0	8.19	28.0	50.8	47.0	159	78.0	352	130	590	168	1000
11.0	8.13	30.0	50.2	50.0	154	80.0	345	135	576	170	990
12.0	8.08	32.0	49.3	52.0	152	82.0	339	140	564	172	980
13.0	8.04	34.0	49.4	54.0	150	84.0	334	145	556	174	970
14.0	8.02	36.0	49.1	56.0	148	86.0	329	150	549	176	961
15.0	8.00	38.0	48.9	58.0	147	88.0	325	155	543	178	952
20.0	7.95	40.0	48.7	60.0	146	90.0	321	160	537	180	945
25.0	7.93	42.0	48.5	62.0	145	92.0	318	165	532	185	930

### 3:1 Triangular weirs

1-foot head		2-foot head		3-foot head		4-foot head		5-foot head		6-foot head	
Area	Dis-charge	Area	Dis-charge	Area	Dis-charge	Area	Dis-charge	Area	Dis-charge	Area	Dis-charge
<i>Ft<sup>2</sup></i>	<i>Ft<sup>3</sup>/s</i>	<i>Ft<sup>2</sup></i>	<i>Ft<sup>3</sup>/s</i>	<i>Ft<sup>2</sup></i>	<i>Ft<sup>3</sup>/s</i>	<i>Ft<sup>2</sup></i>	<i>Ft<sup>3</sup>/s</i>	<i>Ft<sup>2</sup></i>	<i>Ft<sup>3</sup>/s</i>	<i>Ft<sup>2</sup></i>	<i>Ft<sup>3</sup>/s</i>
30.0	7.92	44.0	48.3	64.0	144	94.0	315	170	528	190	912
35.0	7.92	46.0	48.2	66.0	143	96.0	312	175	524	200	890
40.0	7.92	48.0	48.1	68.0	143	98.0	310	180	521	210	870
45.0	7.92	50.0	48.0	70.0	142	100	308	185	518	220	858
50.0	7.92	52.0	47.9	72.0	142	105	304	190	515	230	847
60.0	7.92	54.0	47.8	74.0	141	110	300	195	512	240	838
70.0	7.92	56.0	47.7	76.0	141	115	297	200	510	250	830
80.0	7.92	58.0	47.6	78.0	140	120	295	210	508	260	822
		60.0	47.5	80.0	139	125	293	220	506	270	815
		62.0	47.5	82.0	139	130	291	230	504	280	810
		64.0	47.4	84.0	139	135	289	240	502	290	806
		66.0	47.4	86.0	138	140	287	250	500	300	803
		68.0	47.4	88.0	138	145	286	260	498	320	797
		70.0	47.3	90.0	138	150	285	270	496	340	791
		72.0	47.3	95.0	137	160	284	280	494	360	786
		74.0	47.3	100	137	170	283	290	493	380	782
		76.0	47.2	110	136	180	282	300	492	400	780
		78.0	47.2	120	135	190	281	350	490	450	776
		80.0	47.1	130	134	200	280	400	488	500	773
		85.0	47.1	140	134	250	277	450	486	550	770
		90.0	47.0	150	133	300	275	500	485	600	767
		100	47.0	200	133	400	275	550	484	650	766
		150	47.0	250	132	500	275	600	484		

### 3:1 Triangular weirs continued

15.0	13.7	30	93.0	60	315	115	590	170	1070	230	1880
18.0	13.6	31	95.5	61	306	118	580	180	1015	240	1680
21.0	13.5	32	95.0	62	300	120	572	190	975	250	1615
30.0	13.4	33	93.5	63	295	122	565	200	950	260	1570
50	13.2	34	92.2	64	291	124	559	210	928	270	1530
60	13.3	35	91.2	65	287	126	554	220	910	280	1495
70	13.3	36	90.3	66	283	128	550	230	898	290	1465
80	13.3	37	89.5	67	280	130	546	240	888	300	1440
90	13.3	38	88.9	68	277	132	542	250	880	310	1424
100	13.3	39	88.4	69	274	134	538	260	871	320	1410
		40	88.0	70	272	136	534	270	864	330	1398
		42	87.2	72	268	138	531	280	858	340	1388
		44	86.5	74	264	140	528	290	853	350	1380
		46	85.9	76	261	145	522	300	850	360	1373
		48	85.4	78	259	150	518	310	847	370	1366
		50	85.0	80	257	155	513	320	844	380	1359
		55	84.1	84	253	160	510	330	842	390	1353
		60	83.5	88	249	170	504	340	840	400	1347
		65	83.0	92	246	180	499	350	838	410	1341
		70	82.7	96	244	190	494	360	836	420	1336
		75	82.4	100	243	200	490	370	834	430	1331
		80	82.2	110	240	210	487	380	832	440	1326
		85	82.0	120	237	220	485	390	830	450	1322
		90	81.8	140	234	230	483	400	828	500	1310
		95	81.6	160	232	240	481	450	826	550	1290
		100	81.4	180	231	250	480	500	824	600	1283
		110	81.2	200	230	260	479	550	822	650	1278
		120	81.0	220	229	280	477	600	820	700	1275
		140	80.8	250	228	300	475	650	818	750	1272
		170	80.6	300	227	400	470	700	815	800	1270
		200	80.5	400	226	600	465	800	812	900	1270
		300	80.5	500	226	700	465	1000	805	1000	1270

<sup>1</sup> Based on hydraulic laboratory tests made by the Soil Conservation Service at Cornell University, Ithaca, N.Y.

### 5:1 Triangular weirs

## Appendix A5: Capacities and dimensions of parshall flumes

### For conversion to SI units

**1 inch = 25.4 mm**

**1 foot = 0.3048 metre**

**1 cubic foot per second = 1 second-foot = 0.02832 cubic metres per second = 28.32 litres per second**

	W		A		A		B		C		D		E		F		G		H		K		M		N		P		R		K		Y		Z		FREE-FLOW CAPACITY		
	FT	IN	FT	IN	FT	IN	FT	IN	FT	IN	FT	IN	FT	IN	FT	IN	FT	IN	FT	IN	FT	IN	FT	IN	FT	IN	FT	IN	FT	IN	FT	IN	FT	IN	FT	IN	SEC - FT	SEC - FT	
B	0	1 1/2	1	2 1/2	0	9 1/2	1	2	0	3 1/2	0	6 1/2	0	6 1/2	0	3	0	8	0	8 1/2	0	4	-	-	0	1 1/2	-	-	0	1 1/2	0	3	0	7	0	1	0	01	019
	2	1 1/2	1	4 1/2	1	10 1/2	1	4	5	3 1/2	8	3 1/2	6 1/2	4	10	10 1/2	10 1/2	10 1/2	10 1/2	10 1/2	10 1/2	10 1/2	10 1/2	10 1/2	10 1/2	10 1/2	10 1/2	10 1/2	10 1/2	10 1/2	10 1/2	10 1/2	10 1/2	10 1/2	10 1/2	10 1/2	02	47	
	3	1 1/2	1	6 1/2	1	13 1/2	1	6	7	10 1/2	10 1/2	10 1/2	10 1/2	10 1/2	10 1/2	10 1/2	10 1/2	10 1/2	10 1/2	10 1/2	10 1/2	10 1/2	10 1/2	10 1/2	10 1/2	10 1/2	10 1/2	10 1/2	10 1/2	10 1/2	10 1/2	10 1/2	10 1/2	10 1/2	10 1/2	10 1/2	10 1/2	03	13
B	0	6	2	1 1/2	1	4 1/2	2	0	1	3 1/2	1	3 1/2	2	0	1	0	2	0	-	0	3	1	0	0	4 1/2	2	1 1/2	1	4	0	2	0	3	-	0	5	19		
	9	2	10 1/2	1	1 1/2	2	10	1	3	1	10 1/2	2	6	1	0	1	6	-	0	3	1	0	0	4 1/2	3	6 1/2	1	4	0	2	0	3	-	0	9	89			
	1	0	4	6	3	0	4	4 1/2	2	0	2	9 1/2	3	0	2	0	3	0	-	3	1	3	0	9	4	10 1/2	1	8	0	2	0	3	-	0	11	161			
	1	6	4	9	3	2	4	7 1/2	2	6	3	4 1/2	3	0	2	0	3	0	-	3	1	3	0	9	5	6	1	8	0	2	0	3	-	0	15	246			
	2	0	3	0	3	4	4	10 1/2	3	0	3	1 1/2	3	0	2	0	3	0	-	3	1	3	0	9	6	1	8	0	2	0	3	-	0	42	331				
	3	0	5	6	3	8	5	4 1/2	4	0	5	1 1/2	3	0	2	0	3	0	-	3	1	3	0	9	7	3 1/2	1	8	0	2	0	3	-	0	61	504			
	4	0	6	0	4	0	5	10 1/2	3	0	5	4 1/2	3	0	2	0	3	0	-	3	1	3	0	9	8	10 1/2	2	0	2	0	3	-	0	13	619				
	5	0	6	6	4	4	6	4 1/2	6	0	7	6 1/2	3	0	2	0	3	0	-	3	1	3	0	9	10	1 1/2	2	0	2	0	3	-	0	16	856				
	6	0	7	0	4	8	6	10 1/2	7	0	8	9	3	0	2	0	3	0	-	3	1	3	0	9	11	3 1/2	2	0	2	0	3	-	0	26	1015				
	7	0	7	6	5	0	7	4	8	0	9	1 1/2	3	0	2	0	3	0	-	3	1	3	0	9	12	6	2	0	2	0	3	-	0	30	1214				
8	0	3	0	5	4	7	10 1/2	9	0	11	1 1/2	3	0	2	0	3	0	-	3	1	3	0	9	13	6	2	0	2	0	3	-	0	35	1395					
B	10	0	-	6	0	14	0	12	0	15	7	4	0	5	0	6	0	-	0	6	-	-	1	1 1/2	-	-	0	9	1	0	-	-	0	6	200				
	12	0	-	6	8	16	0	14	8	18	4 1/2	5	0	5	0	8	0	-	0	6	-	-	1	1 1/2	-	-	9	0	-	-	0	8	350						
	15	0	-	7	8	23	0	18	4	25	0	6	0	4	0	10	0	-	0	9	-	-	1	1 1/2	-	-	9	1	0	-	0	9	600						
	20	0	-	9	4	25	0	24	0	30	0	7	0	6	0	12	0	-	0	10	-	-	2	3	-	-	9	0	-	0	10	1000							
	25	0	-	11	0	25	0	29	4	35	0	7	0	6	0	13	0	-	0	11	-	-	2	3	-	-	9	0	-	0	15	1200							
	30	0	-	12	8	26	0	34	8	40	4 1/2	7	0	6	0	14	0	-	0	12	-	-	2	3	-	-	9	1	0	-	0	15	1500						
	40	0	-	16	0	27	0	45	4	50	9 1/2	7	0	6	0	16	0	-	0	16	-	-	2	3	-	-	9	1	0	-	0	20	2000						
50	0	-	19	4	27	0	56	8	60	9 1/2	7	0	6	0	20	0	-	0	20	-	-	2	3	-	-	9	1	0	-	0	25	3000							

1 Tolerance on throat width (W) is 1/4 inch; tolerance on other dimensions is 1/32 inch. Spacing of throat must be parallel and vertical. 2 From U.S. Department of Agriculture, Soil Conservation Circular No. B43. 3 From Colorado State University Technical Bulletin No. 61. 4 From Colorado State University Bulletin No. 426-A.

**Figure**