

Home-immediately access 800+ free online publications.
Download CD3WD (680 Megabytes) and distribute it to the 3rd World. CD3WD is a 3rd World Development private-sector initiative, mastered by Software Developer Alex Weir and hosted by GNUveau Networks (From globally distributed organizations, to supercomputers, to a small home server, if it's Linux, we know it.)[ar](#).[cn](#).[de](#).[en](#).[es](#).[fr](#).[id](#).[it](#).[ph](#).[po](#).[ru](#).[sw](#)

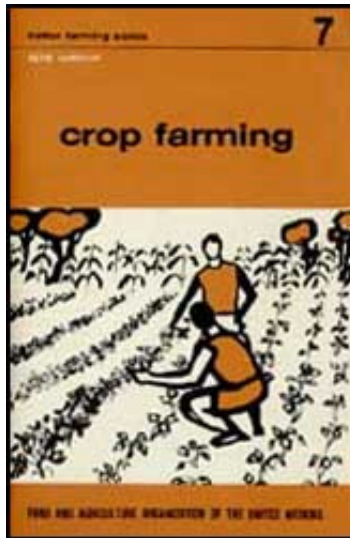

Better Farming Series 07 - Crop Farming (FAO - INADES, 1976, 29 p.)



(introduction...)



Plan of work



(introduction...)



How to till



























By hand



With animal power



-  **Depth of tillage**
-  **When to plough**
-  **Harrowing**
-  **Sowing**
 -  **Choosing seed**
 -  **When to sow**
 -  **How to sow**
 -  *(introduction...)*
 -  **Sowing in rows**
 -  **Sowing in rows by hand**
 -  **Sowing with animal power**
-  **Transplanting**
-  **Looking after the crops**
 -  **Weeding**
 -  **Earthing up**
 -  **Hoeing**

-  Thinning
-  Harvesting
-  How to harvest
-  How to get a better price for the harvest
 -  Grade your crops.
 -  Store your harvest well.
 -  Farmers get together to sell.
-  Suggested question paper



[Home](#)-immediately access 800+ free online publications.
[Download](#) CD3WD (680 Megabytes) and distribute it to the 3rd World. CD3WD is a 3rd World Development private-sector initiative, mastered by Software Developer [Alex Weir](#) and hosted by [GNUveau Networks](#) (From globally distributed organizations, to supercomputers, to a small home server, if

it's Linux, we know it.)[ar](#).[cn](#).[de](#).[en](#).[es](#).[fr](#).[id](#).[it](#).[ph](#).[po](#).[ru](#).[sw](#)

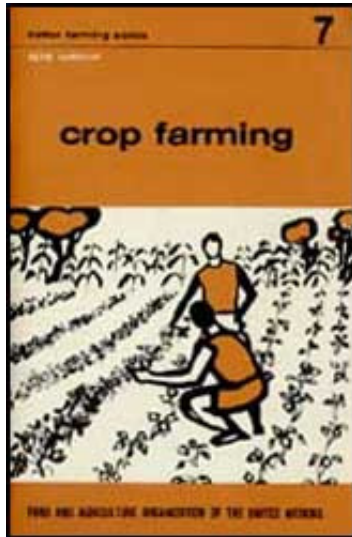

- 📖 Better Farming Series 07 - Crop Farming (FAO - INADES, 1976, 29 p.)
- ➔ 📄 *(introduction...)*
- 📁 Plan of work
- 📁 Sowing
- 📄 Transplanting
- 📁 Looking after the crops
- 📁 Harvesting
- 📄 Suggested question paper

Published by arrangement with the
Institut africain pour le dveloppement conomique et social
B.P. 8008, Abidjan, Cte d'Ivoire

FOOD AND AGRICULTURE ORGANIZATION OF THE UNITED

NATIONS

Rome 1976

FAO Economic and Social Development Series No. 3/7

© French edition, Institut africain pour le dveloppement
conomique et social (INADES) 1970







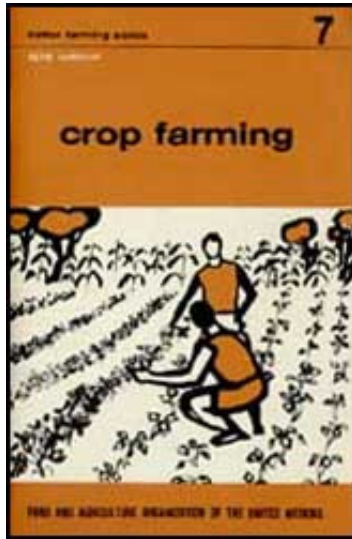

© English edition, FAO 1976



[Home](#)-immediately access 800+ free online publications.
[Download](#) CD3WD (680 Megabytes) and distribute it to the 3rd
World. CD3WD is a 3rd World Development private-sector
initiative, mastered by Software Developer [Alex Weir](#) and
hosted by [GNUveau Networks](#) (From globally distributed
organizations, to supercomputers, to a small home server, if
it's Linux, we know it.)[ar](#).[cn](#).[de](#).[en](#).[es](#).[fr](#).[id](#).[it](#).[ph](#).[po](#).[ru](#).[sw](#)



 **Better Farming Series 07 - Crop Farming (FAO - INADES, 1976, 29 p.)**

- ➔  Plan of work
 -  *(introduction...)*
 -  How to till
 -  By hand
 -  With animal power
 -  Depth of tillage
 -  When to plough
 -  Harrowing

Better Farming Series 07 - Crop Farming (FAO - INADES, 1976, 29 p.)

Plan of work

FIRST WEEK

Tilling

Read pages 4 to 11.

We take a look at tilling done with a hand hoe and tilling done with a plough. Which is done quicker? Which is done better?

Is tilling done at the right time?

Look carefully at a plough and see how it works, how it turns over the earth.

SECOND WEEK

Sowing

Reread pages 4 to 11.

Read pages 12 to 18.

Reread also Booklet No. 3, page 22 on choosing seed.

Let us take a look at sowing broadcast, sowing in rows and sowing in seed holes.

Why must we sow in rows, and how is it done?

Why must we sow as early as possible?

THIRD WEEK

Looking after crops

Reread pages 12 to 18.

Read pages 19 to 24.

Is the work of looking after the crops done well and at the right time? What about weeding? Earthing up? Thinning?

Do you understand why it is important to look after the crops?

FOURTH WEEK

Harvesting

Reread pages 19 to 24.

Read pages 25 to 28.

This week's work is important.

It's no use having a fine harvest if you sell it badly.

What do you do you sell your harvest at a better price?

Reread the whole course. Answer the question paper.

HOW TO CHOOSE A FIELD

You must choose carefully the field you mean to farm.

Choose a field where plants grow well, where the grasses are tall.

Choose good land.

Choose a field near the village so as not to lose time going to and from the field.

Ask the village headman for permission to farm the field for a very long time.

PREPARING THE FIELD

During the dry season prepare your field.

- Improve the field.

If the soil is wet, drain it (see Booklet No. 6, page 20).

If the soil is short of water, irrigate it (see Booklet No. 6, page 18).

If the soil is on a slope, mark the contour lines (see Booklet No. 5, page 8).

- In order to use animal power (see Booklet No. 6, page 28), mark out a rather large right-angled field. Clear the land and grub the trees (see Booklet No. 6, page 21).

TILLING

Tilling means Burning over the soil.

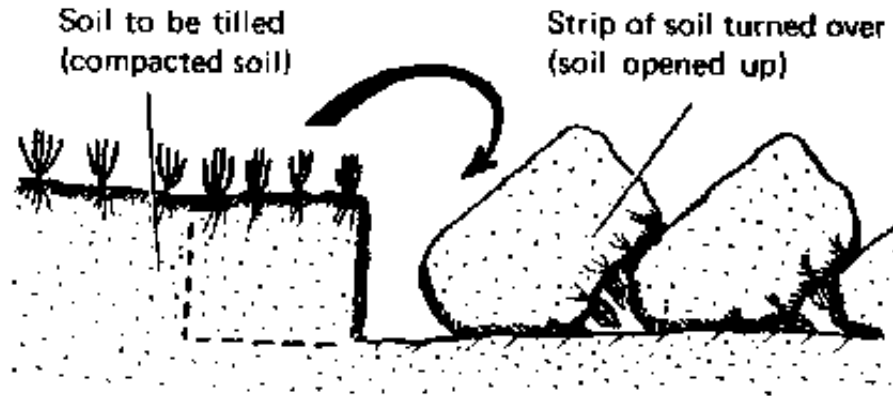

Tilling
Tilling

Tilling enables water and air to get right into the soil. It makes the soil less hard. It loosens the soil.

In well-tilled soil seeds germinate easily. Roots penetrate easily.

Tilling mixes earth and herbage. It cleans the soil. The herbage rots and makes humus by tilling the soil, you can mix fertilizers and manure with it.

How to till

By hand

You can till, that is turn over the soil, with a hoe or a spade.

- **By hand**

You can till, that is turn over the soil,
with a hoe or a spade.

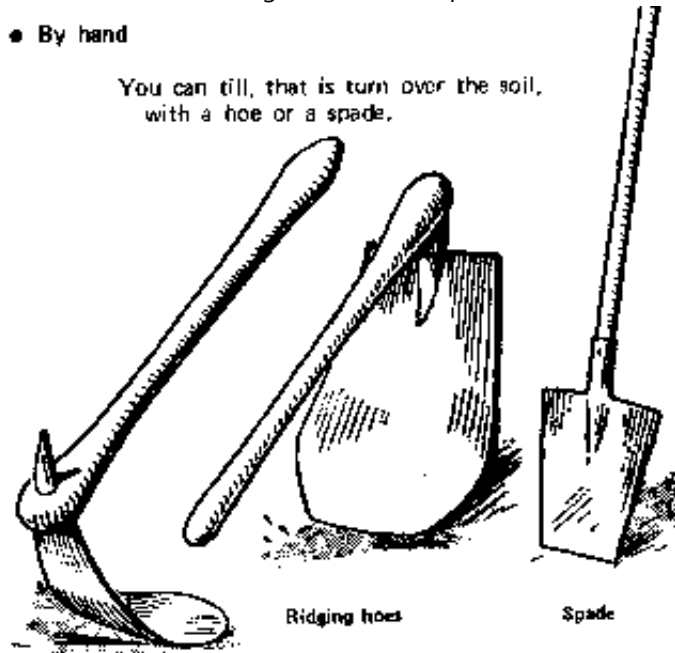

By hand: You can till, that is turn over the soil, with a hoe or a spade.

Usually this work is done with a hoe (daba).

The hoe should be heavy enough to cut into the soil even if it

is rather hard.

You can also do the work with a spade.

With these tools you can turn over the soil and bury organic matter.

But this work is slow and tiring.

With animal power

The trees in the field have been grubbed.

The farmer uses a plough drawn by donkeys or oxen.

The work is done better and done faster.

The plough.

Usually a simple plough is used.

The plough consists of a ploughshare, a mouldboard and two handles.

The ploughshare cuts a strip of earth.

The mouldboard turns this strip over.

Handles for holding the plough

Handles for holding the plough

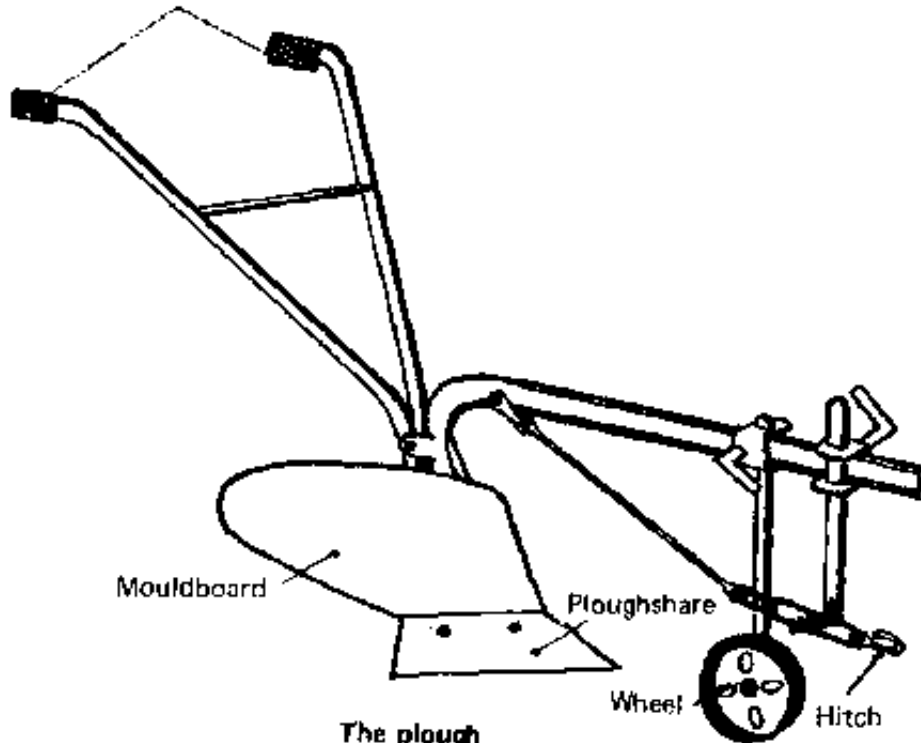

Handles for holding the plough.

Tilling should never bring the subsoil to the surface (see

Booklet No. 4, page 6).

This layer of soil is poor in mineral salts.
Doing this also destroys the soil structure.

Depth of tillage

Tillage can be shallow, normal or deep.

- Shallow tillage.

Look at this drawing:

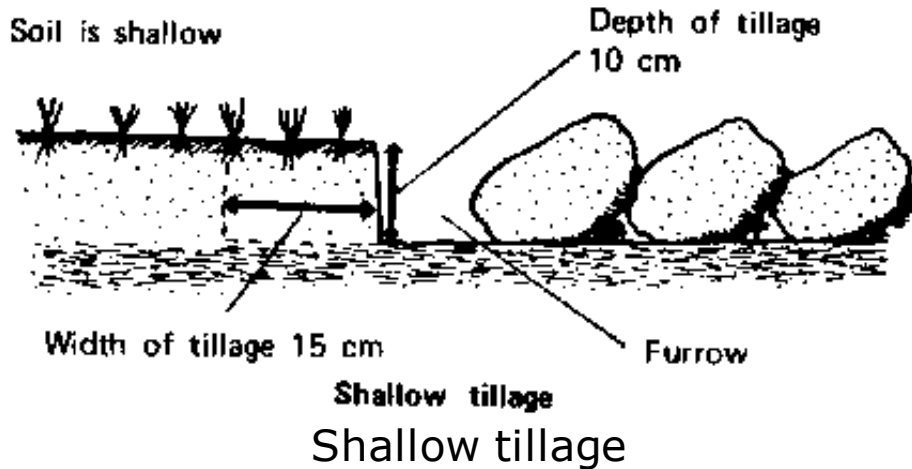

The ploughshare cuts a strip of soil 10 to 15 centimetres thick.

The tillage is said to be shallow when its depth is from 10 to 15 centimetres.

- Normal tillage.

Look at this drawing:

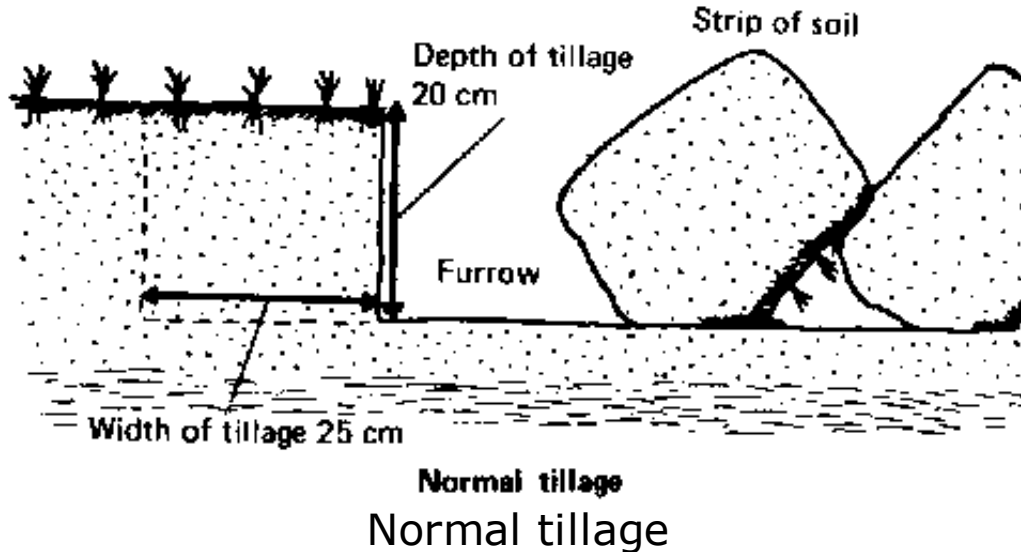

Tillage is said to be normal when the depth of tillage is 20 centimetres.

With normal tillage the soil can be well turned over and the remains of plants can be well buried.

Make a first furrow with the plough across the whole length of

the field.

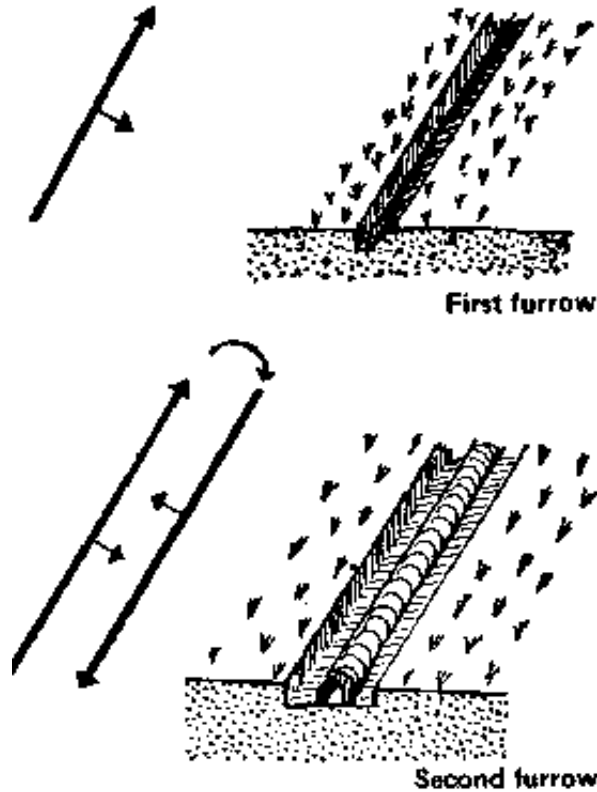

Furrow

At the end of the field, turn.

Make a second furrow alongside the first.

The second strip of ploughed field joins the first.

After that, keep turning round the strip of ploughed field.

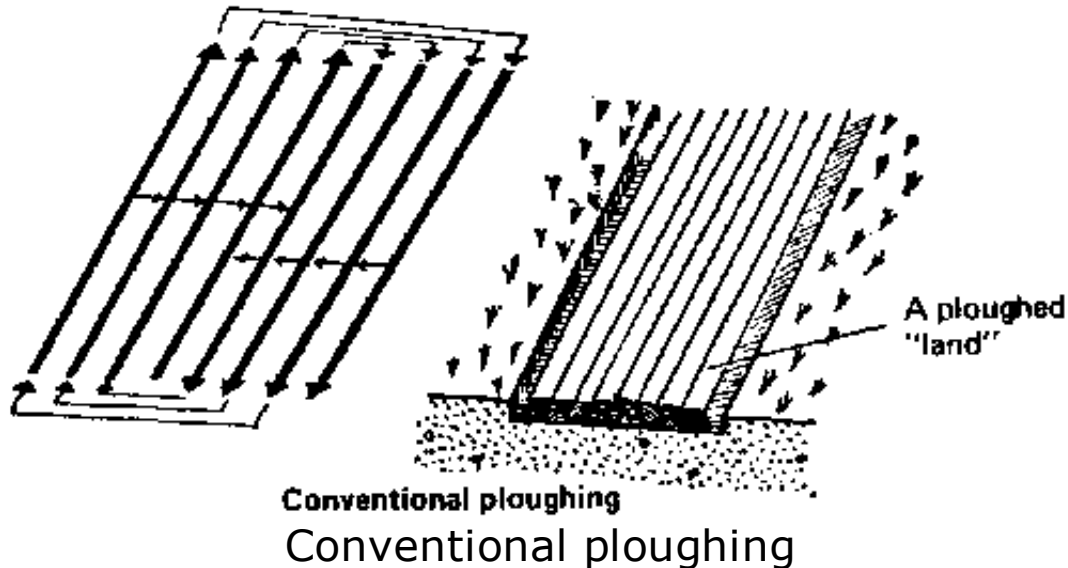

If the field is very big, make several "lands."

If the field is on a slope, plough along the contour lines (see Booklet No. 5, page 8).

If the cultivated soil (see Booklet No. 4, page 9) is not deep, and if the soil is very light, ploughing is not necessary (see Booklet No. 4, page 17). It may even be a bad thing (see page 7).

Instead use a machine with tines, drawn by animals.

The tines stir the soil without turning it over.

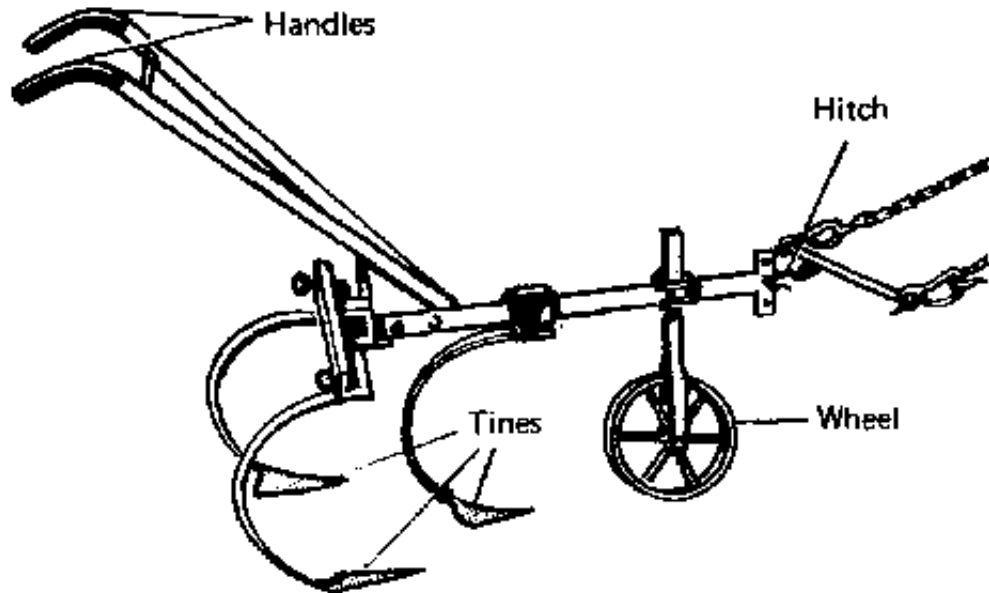

Animal-drawn cultivator

Animal- draw cultivator

With oxen use five to eight tines.

With one donkey, use fewer tines, say three to five.

For other work, such as hoeing, weeding, earthing up (see

page 21) change the tines of the cultivator.

When to plough

Ploughing can be done after the harvest or after the first rains.

- After the harvest, at the beginning of the dry season, the soil is not too hard, you can begin to plough your fields.

Then the first rains will fall on soil already opened up, on loosened soil. The rain will penetrate easily and less water will be wasted.

- If you do not have time to plough after the harvest, you should do so as soon as the first rains have fallen.

Sow as soon as possible, so that the plants can use all the water of the rainy season (see Booklet No. 3, page 20).

Very often, farmers plough all their fields at the beginning of the rainy season and spend a lot of time on the ploughing.

They sow much too late.

When the sowing is too late, the plants do not grow well.

A modern farmer sows in good time.

A good farmer ploughs his fields immediately after the harvest, at the beginning of the dry season.

Harrowing

Ploughing often does not leave the soil flat. There are big pieces of earth - clods. The clods must be broken up to make the soil quite flat, and to give earth that is fine, not lumpy. This is called harrowing.

You can break up the clods with a hoe or rake.

But you can do the work more quickly with a harrow drawn by an animal.

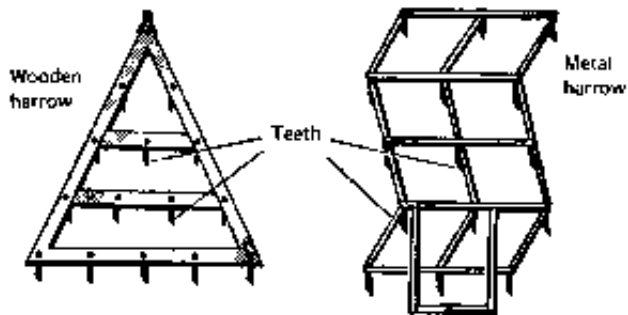

If you have no harrow,
you can make an animal pull big branches over the soil.
The branches will break up the clods.

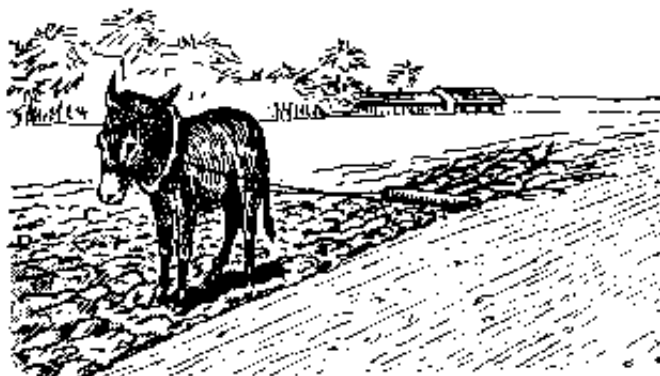





No harrow

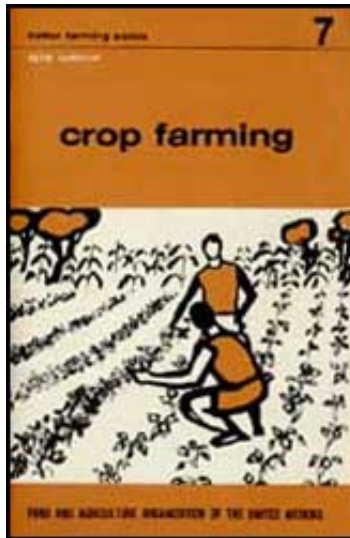

Home-immediately access 800+ free online publications.
Download CD3WD (680 Megabytes) and distribute it to the 3rd World. CD3WD is a 3rd World Development private-sector initiative, mastered by Software Developer Alex Weir and hosted by GNUveau Networks (From globally distributed organizations, to supercomputers, to a small home server, if it's Linux, we know it.)[ar](#).[cn](#).[de](#).[en](#).[es](#).[fr](#).[id](#).[it](#).[ph](#).[po](#).[ru](#).[sw](#)



 Better Farming Series 07 - Crop Farming (FAO - INADES, 1976, 29 p.)

- ➔ Sowing
 -  Choosing seed
 -  When to sow
 - How to sow
 -  (*introduction...*)
 -  Sowing in rows
 - 

Sowing in rows by hand

Better Farming Series 07 - Crop Farming (FAO - INADES, 1976, 29 p.)

Sowing

Choosing seed

In Booklet No. 3, pages 20 to 26, we dealt with seeds and sowing.

Reread these pages.

Seed must be carefully chosen; seed must be from good varieties, must be protected against disease, must be graded.

When to sow

When the soil is well prepared sowing can be done. In savanna

country especially, sowing should be done at the beginning of the rainy season. In this way the plants will make full use of the rains.

- If you sow very early, the plants will grow up before they are hindered by weeds.

Sowing must be done at the right time.

How to sow

Farmers have the habit of sowing in seed holes. The farmer makes a little hole with a stick or hoe, drops in several seeds and covers them with soil.

Some seed, such as rice, is sown broadcast; that is, it is thrown into the air, and falls all over the place.

Then a harrow is drawn to mix the seed with the soil.

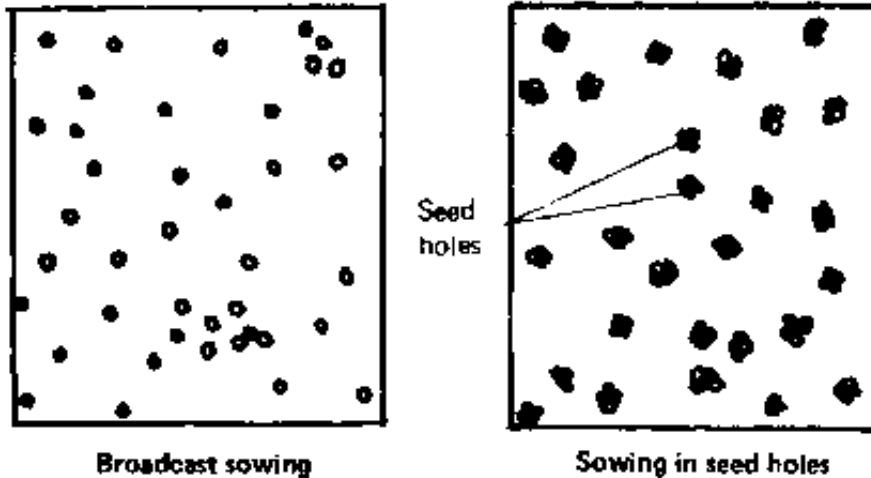

Sowing

But the seed falls anywhere.

Sometimes the plants are too close together and get in each other's way when growing.

Sometimes the plants are not close enough. They do not make full use of the soil. With broadcast sowing it is not possible to

get the right density (see Booklet No. 1, page 26).

When you want to get rid of weeds, you walk on the young plants and often spoil them.

Sowing in rows

By sowing in rows you can:

- get rid of weeds more easily. The animal drawing the cultivator can walk between the rows. The work is done more quickly, and can be done more often.
- give each plant the same amount of fertilizer.
- apply water when possible.

It is better to sow in rows.

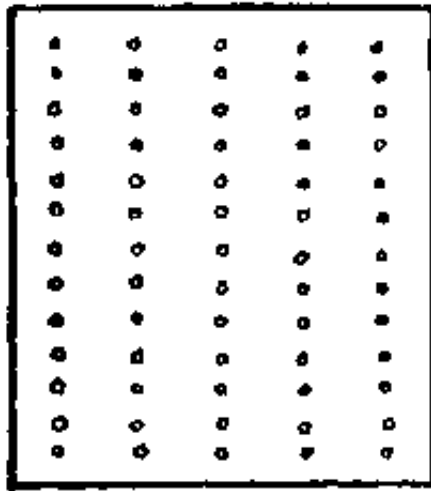

Sowing in rows

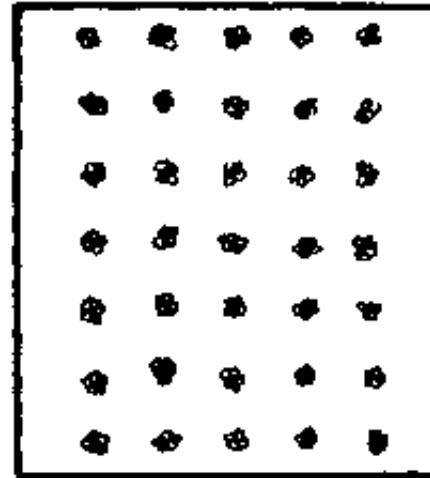

**Sowing in rows and
seed holes**

Sowing in rows

On sloping land, make the rows across the slope to stop erosion.

- As an example take groundnuts:

Leave 60 centimetres between rows. Leave 15 centimetres between seeds. This gives about 110 000 groundout plants to the hectare.

Sowing in rows by hand

When you sow or plant, make the lines quite straight.

Use a marker to make the lines.

This is a wooden bar with teeth. Each tooth marks a row.

To get the first row quite straight, stretch a string between two stakes. Then follow the string with the marker.

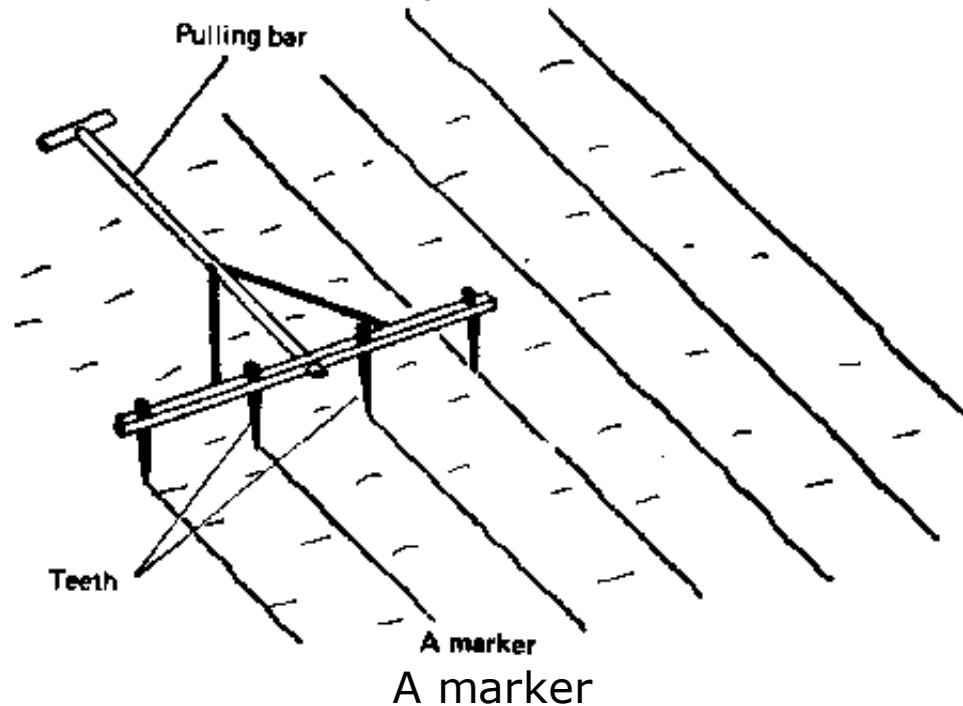

The distance between rows changes according to the size of the seed.

Put the seeds in the rows at the same distance apart and at

the same depth (see Booklet No. 3, page 21)

Cover the seeds with a little earth. Walk over the row to press down the earth.

Then the field will be sown at the right density (see Booklet No. 1, page 26).

- Certain plants such as cotton and millet are sown in seed holes.

Seed holes too must be made in rows.

By that means you can be sure of the right density, you can get rid of weeds and apply pesticides more easily.

To put the seeds at the same distance apart, you can use a spacing wheel.

The spacing wheel.

This can be made of wood or iron. Each tooth of the wheel makes a little hole in the soil. Put one or more seeds in each hole. Cover the seeds with a little earth, either with the hoe or your foot.

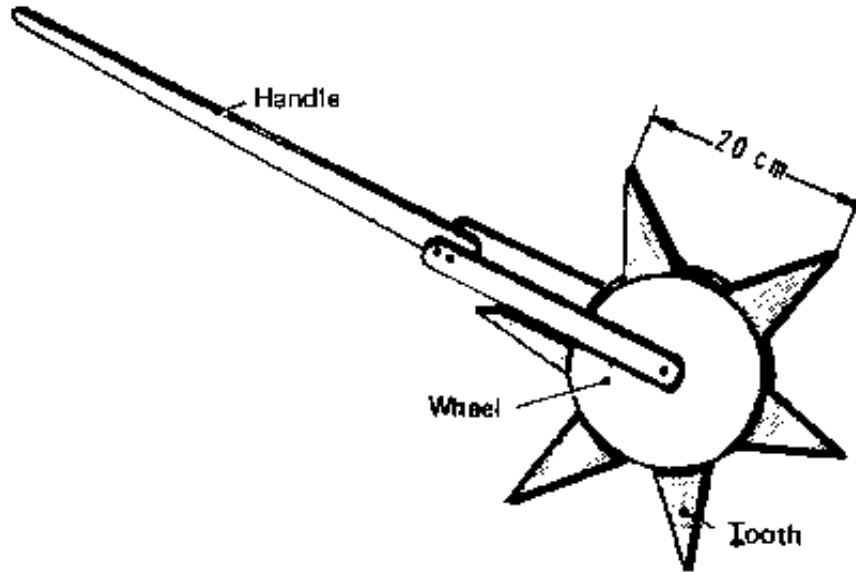

A spacing wheel

A spacing wheel

Sowing with animal power

The seed drill.

In several countries people are beginning to use the seed drill. This is drawn by a donkey or an ox. The seed drill makes furrows and the seeds fall into the furrow the same distance apart and at the same depth.

At the same time, the drill covers the seed and presses down the soil.

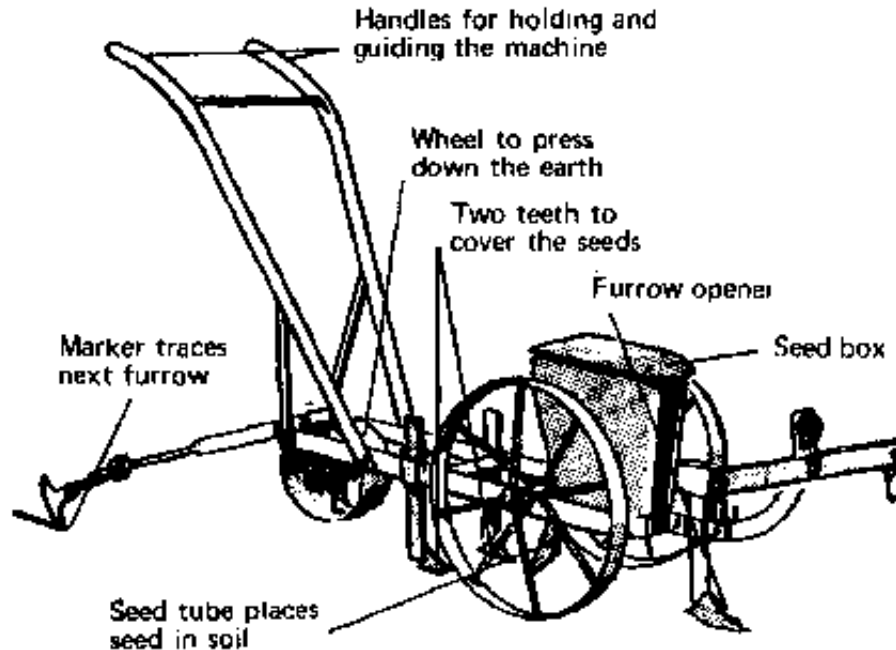

Seed drill
Seed drill



[Home](#)-immediately access 800+ free online publications.

[Download](#) CD3WD (680 Megabytes) and distribute it to the 3rd World. CD3WD is a 3rd World Development private-sector initiative, mastered by Software Developer [Alex Weir](#) and hosted by [GNUveau Networks](#) (From globally distributed organizations, to supercomputers, to a small home server, if it's Linux, we know it.)[ar.cn.de.en.es.fr.id.it.ph.po.ru.sw](#)

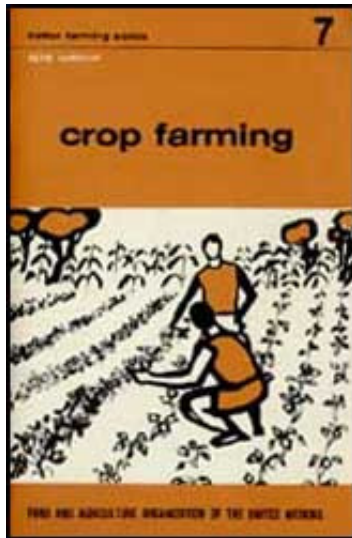

- 📖 Better Farming Series 07 - Crop Farming (FAO - INADES, 1976, 29 p.)
 - 📄 *(introduction...)*
 - Plan of work
 - Sowing
 - ➔ Transplanting
 - Looking after the crops
 - Harvesting
 - 📄 Suggested question paper

Transplanting

Certain plants are first sown in a nursery.

In a nursery you can sow very thickly. When the seeds have germinated, when the plants have grown a little, they are lifted and planted out in the fields. They are transplanted. Tobacco, tomatoes, salad plants, rice and many trees, such as oil palm, mango, avocado, are first sown in a nursery and then transplanted.

Good transplanting.

Plants are lifted from the nursery. But before transplanting them in the field, they must be prepared. Cut off roots that are too long. Cut off damaged roots. Take off half the leaves. Put the plant in the soil up to the base of the stem. Pack the earth well round the roots.

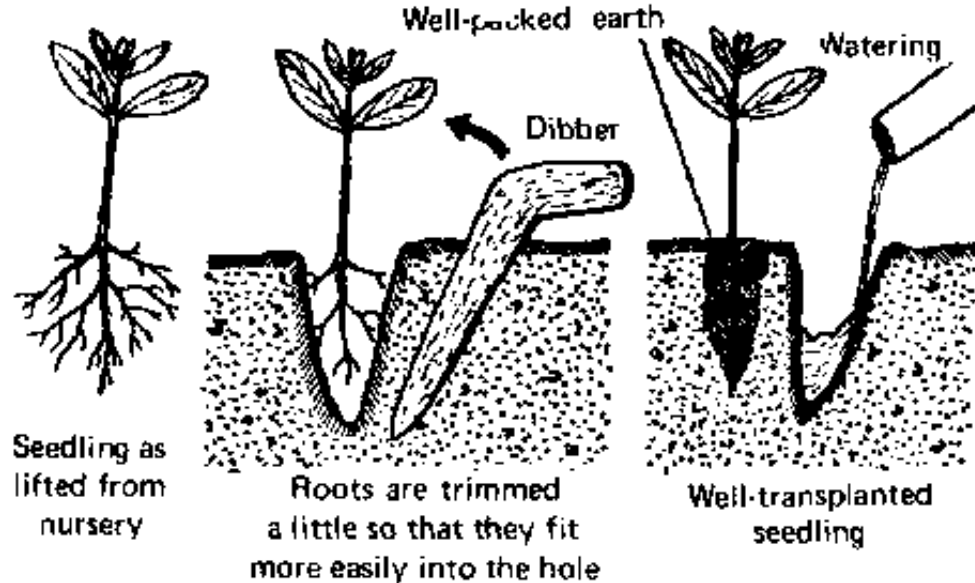

Transplanting

Transplanting

To protect the transplanted seedlings from the sun, make a little shelter.

Bad transplanting.

The roots have not been trimmed; they turn upward.

The earth has not been packed down; the roots dry out. If the transplanted seedling is not watered, it will not grow well.

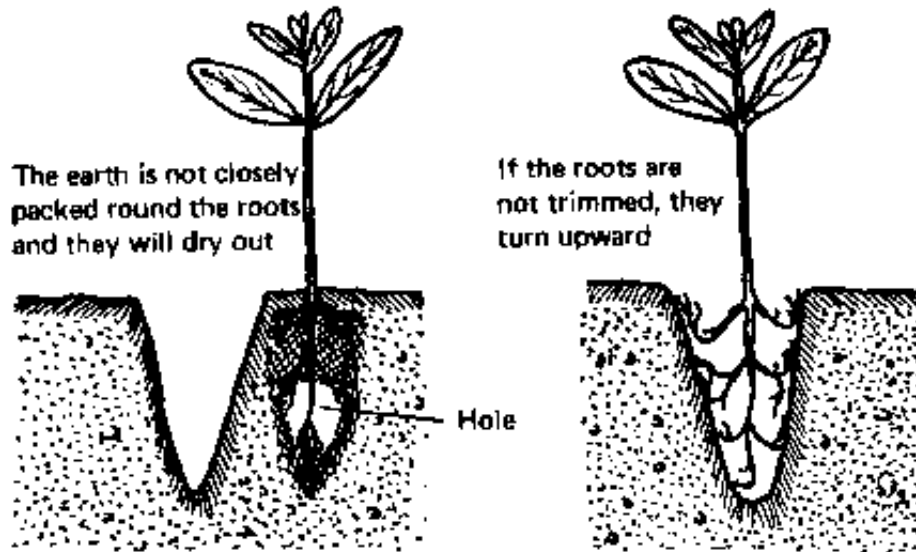

Bed transplanting

Bed transplanting

Cassava is not sown. You put pieces of stem into the earth.

Cassava is planted.

You do not sow pineapples or bananas. You put shoots into the earth. Pineapples and bananas are planted.

This planting must also be done in rows, to get the right density and to get rid of weeds more easily.



[Home](#)-immediately access 800+ free online publications.
[Download](#) CD3WD (680 Megabytes) and distribute it to the 3rd World. CD3WD is a 3rd World Development private-sector initiative, mastered by Software Developer [Alex Weir](#) and hosted by [GNUveau Networks](#) (From globally distributed organizations, to supercomputers, to a small home server, if it's Linux, we know it.)[ar](#).[cn](#).[de](#).[en](#).[es](#).[fr](#).[id](#).[it](#).[ph](#).[po](#).[ru](#).[sw](#)

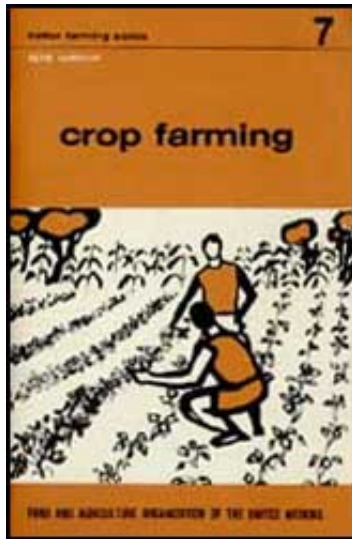

Better Farming Series 07 - Crop Farming (FAO - INADES, 1976, 29 p.)



Looking after the crops



Weeding



Earthing up



Hoeing



Thinning

Better Farming Series 07 - Crop Farming (FAO - INADES, 1976, 29 p.)

Looking after the crops

Weeding

Weeds prevent plants from growing well (see Booklet No. 2, page 24).

They take out of the soil the mineral salts that the crops need. The weeds must be removed.

Weeding can be done with the hand hoe (see page 6), or with an animal- drawn cultivator (see page 10).

Sowing in rows makes weeding easier. The cultivator has tines that cut the weeds between the seed rows.

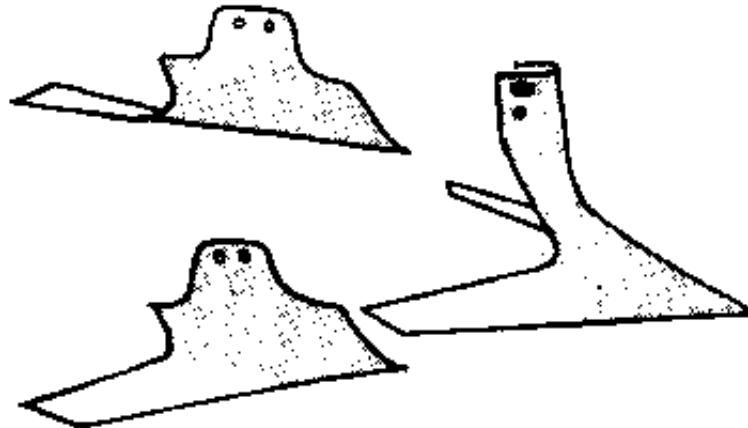

**Weed-cutting tines for
fixing to a cultivator**

Weed- cutting tines for fixing to a cultivator

You must weed each time new weeds grow.

For cotton and groundnuts weed three or four times.

With an animal- drawn cultivator you can only get rid of weeds between seed rows. Remove the weeds among the plants in a row by using the hand hoe.

Weeding must be done when the weeds are still small. Then the work is easier and quicker. Weeds are destroyed more easily when they are still small.

Let the cut weeds dry between the rows.

They will rot and form humus. They will also protect the soil against erosion.

Earthing up

Earthing up, sometimes called ridging up, is putting earth round the collar, or crown, of plants (see Booklet No. 1, page

15).

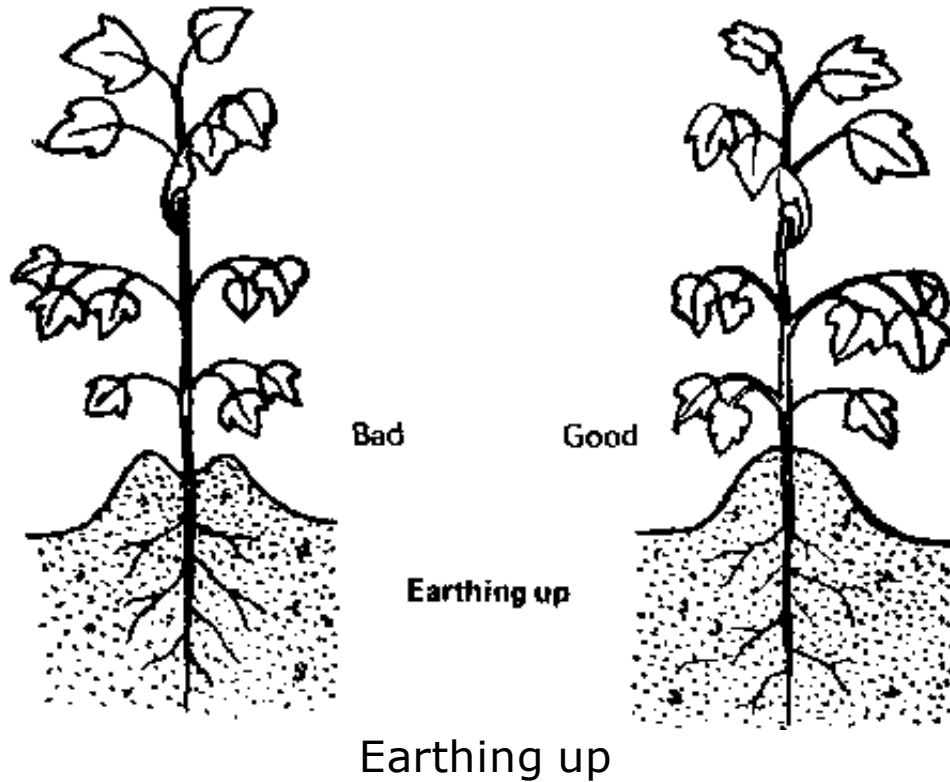

With certain plants, such as maize and millet, adventitious roots then grow in the mound of earth.

Hoeing

With some soils the surface gets hard after rain; a crust of earth is formed. Water rises in the crust as it rises in lumps of earth {see Booklet No. 4, page 30).

- The earth crust must be broken up to prevent the water rising. This is called hoeing.

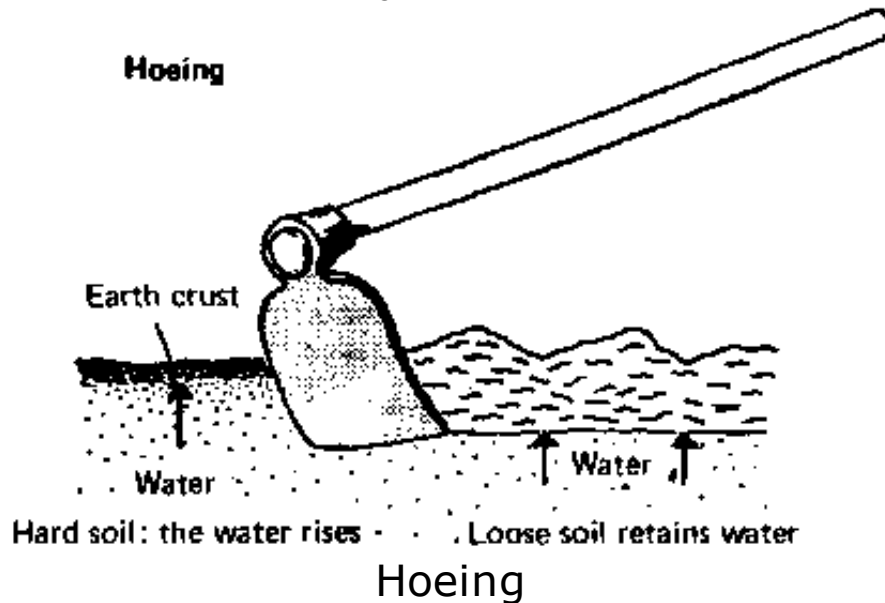

- Rain that falls on a well- hoed soil goes in easily. It does not run off the surface. It is not wasted.
- Hoeing is done with a hand hoe or with an animal- drawn cultivator.

Weeding often serves both purposes: it gets rid of weeds and breaks up the soil crust.

Thinning

Thinning is removing surplus plants.

When you sow in seed holes, you put in four or five seeds. They grow together.

There are too many of them and some must be taken out. Then the plants that are left can grow better.

As a rule the two best plants in each seed hole are left.

Thinning should be done when the plants have a few leaves, but before they are too big.

In pulling out the surplus plants, the soil is disturbed.

So it must be pressed down again round the plants that are left.

The first weeding and thinning are done at the same time.

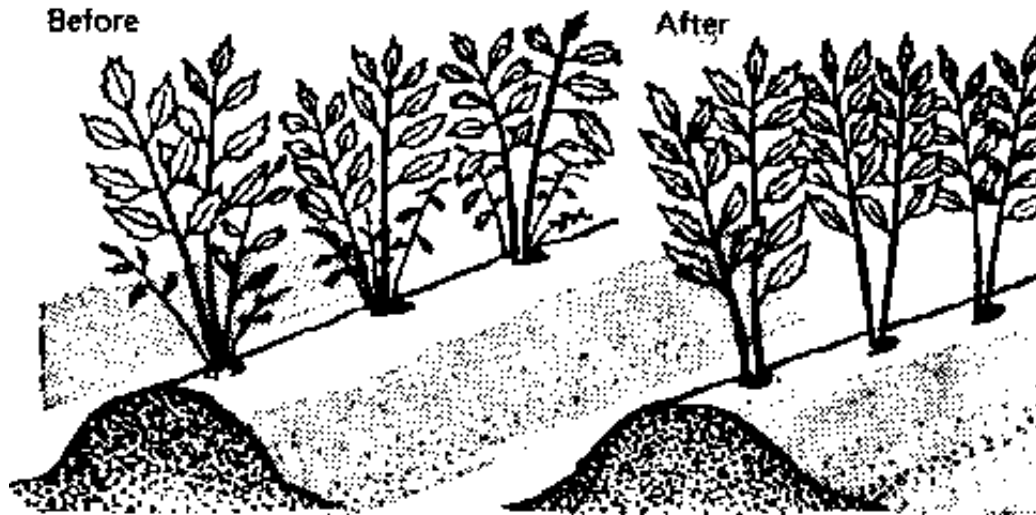



Thinning
Thinning

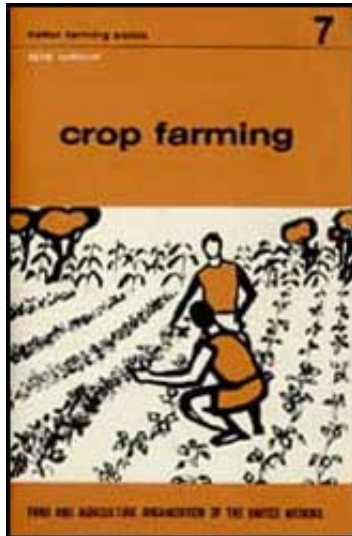

[Home](#)-immediately access 800+ free online publications.
[Download](#) CD3WD (680 Megabytes) and distribute it to the 3rd
World. CD3WD is a 3rd World Development private-sector

initiative, mastered by Software Developer [Alex Weir](#) and hosted by [GNUveau Networks](#) (From globally distributed organizations, to supercomputers, to a small home server, if it's Linux, we know it.)[ar.cn.de.en.es.fr.id.it.ph.po.ru.sw](#)



 Better Farming Series 07 - Crop Farming (FAO - INADES, 1976, 29 p.)

➔ Harvesting

 How to harvest

How to get a better price for the harvest

 Grade your crops.

 Store your harvest well.

 Farmers get together to sell.

Better Farming Series 07 - Crop Farming (FAO - INADES,

1976, 29 p.)

Harvesting

How to harvest

As a rule harvesting is done by hand. This work can be improved by using better tools, for example: a three- pronged lifting fork or hook for lifting cassava; a sickle for cutting rice; a scythe for cutting grass fodder.

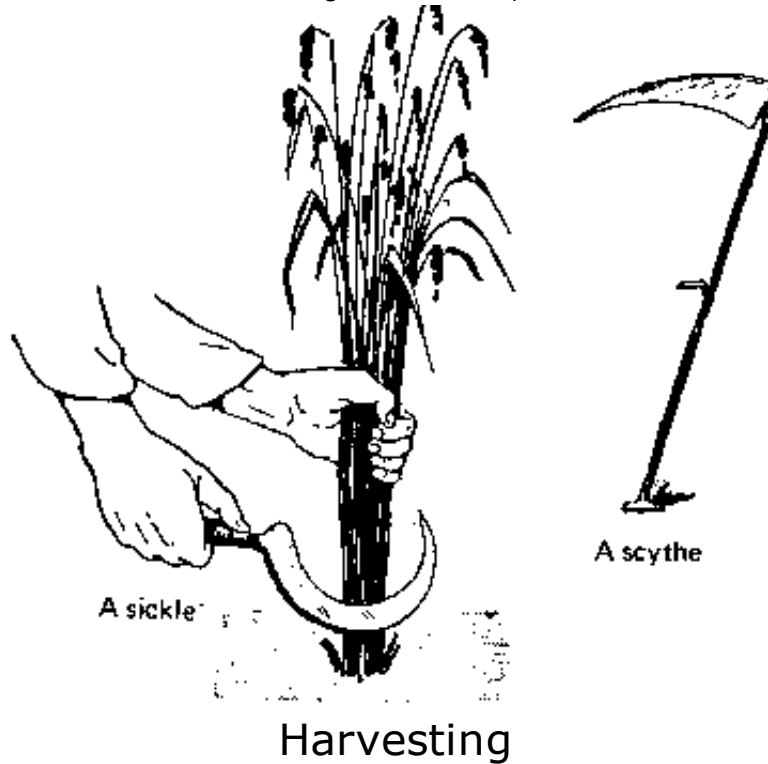

Harvesting must be done at the right moment when the crop is quite ripe.

For example:

The fruits of the oil palm cut at the right moment yield more oil.

If you harvest cotton too late, part of the cotton has already fallen to the ground. It is dirty and sells for less.

If sorghum or millet is harvested too late, the grains fall to the ground and are lost.

How to get a better price for the harvest

Grade your crops.

To get a better price, separate what is good from what is less good. Grade your crops.

If the harvest is not graded, if it is of poor quality, you get a

low price,

For example:

In Cameroon in 1969, cocoa of first quality sold for 85 CFA francs; cocoa of second quality sold for 80 francs;

In Upper Volta in 1969, white cotton sold for 30 CFA francs, yellow cotton sold for 28 francs.

At the market, tomatoes and yams of good quality sell at a better price.

To grade crops: separate the good coffee beans from the broken ones; separate the white cotton from the yellow cotton; take out groundnut pods that are empty; take out spoiled grain, fruit that is rotten or eaten by insects.

If you do not grade your crops, you will sell them at the lowest

price.

Grading your harvest crops means earning more money.

Store your harvest well.

Cassava can be kept in the earth. You can harvest it all through the year. Maize and groundnuts cannot be kept in the ground.

Harvests are kept in houses, in granaries. Sometimes they are hung on trees.

But rats and birds eat part of the harvest. Another part may rot. Farmers lose part of their harvest.

To store your harvest well, build granaries (see Booklet No. 3, page 27) where rats can't get in, where the rain doesn't get in.

Clean and disinfect the granary to kill insects (see Booklet No. 3, page 28).

- Store your harvest to earn more money.

For example:

Just after the harvest the price of millet is low. Ten months after harvest the price of millet is higher.

Mamadou sells 700 kilogrammes of millet just after the harvest at 12 francs the kilogramme. Mamadou earns $700 \times 12 = 8\,400$ francs.

Moussa sells 700 kilogrammes of millet ten months after the harvest at 25 francs the kilogramme. Moussa earns $700 \times 25 = 17\,500$ francs.

Because Moussa stored his millet, he earned 9 100 francs (17

500 less 8 400) more than Mamadou.

By keeping his harvest, Moussa made a lot of money.

Farmers get together to sell.

A farmer by himself often sells his harvest badly.

When he is alone he cannot go and sell his crops where the price is high.

A dishonest dealer can easily trick the seller on the weight of his harvest by means of false scales, by weighing very quickly. The farmer can't check him.

- on the quality. The dealer often says the quality of the harvest is bad and buys at a lower price.
- on prices. The farmer needs money. The dealer knows this and buys at low prices.

- on the reckoning. Some dealers make mistakes in the reckoning on purpose.

Farmers who get together can defend themselves against dishonest dealers.

Unity is strength.



[Home](#)-immediately access 800+ free online publications.
[Download](#) CD3WD (680 Megabytes) and distribute it to the 3rd World. CD3WD is a 3rd World Development private-sector initiative, mastered by Software Developer [Alex Weir](#) and hosted by [GNUveau Networks](#) (From globally distributed organizations, to supercomputers, to a small home server, if it's Linux, we know it.)[ar](#).[cn](#).[de](#).[en](#).[es](#).[fr](#).[id](#).[it](#).[ph](#).[po](#).[ru](#).[sw](#)

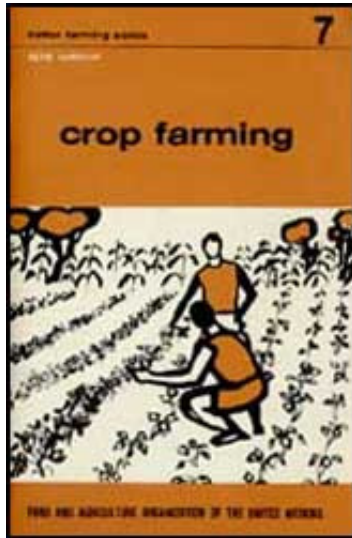

Better Farming Series 07 - Crop Farming (FAO - INADES, 1976, 29 p.)



(introduction...)



Plan of work



Sowing



Transplanting



Looking after the crops



Harvesting



Suggested question paper

Suggested question paper

FILL IN THE MISSING WORDS

A good farmer ploughs his field immediately after the.....at the beginning of the.
.....season.

Then he will be able to sow at the.....of the rainy season.

The plants will use all the.....of the rainy season,.....they will grow up without being hindered by.....

A good farmer sows in.....so that he can get the weeds out better.

It is very important to harvest at the.....moment.

It is useless to farm well if you harvest.....

Finally, a good farmer stores his harvest and sells when the price is.....

He can get together with other farmers tohimself better.

ANSWER THE FOLLOWING QUESTIONS

When should ploughing be done? When should sowing be done? Why should plants be earthed up? Why should plants be

thinned? What is a scythe used for? Tell a friend why it is better to sow in rows. What should a farmer do to sell his harvest at a better price? What was most useful to you in the course on the soil (Booklets Nos. 4,5. 6, 7)?

