

[Home](#) > [ar](#).[cn](#).[de](#).[en](#).[es](#).[fr](#).[id](#).[it](#).[ph](#).[po](#).[ru](#).[sw](#)

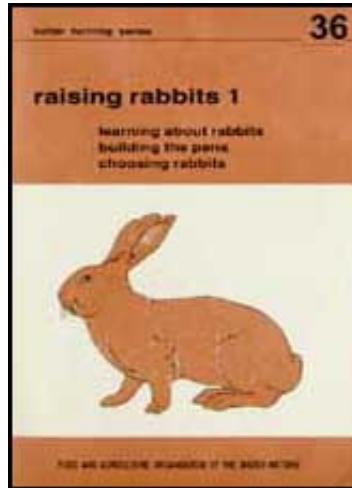

Better Farming Series 36 - Raising Rabbits 1: Learning about Rabbits; Building the Pens; Choosing Rabbits (FAO, 1988, 56 p.)



*(introduction...)*



Preface



Introduction



*(introduction...)*



What do you need to raise rabbits?















Learning about rabbits







*(introduction...)*



What kinds of rabbits can you raise?

-  What can rabbits eat?
-  How many rabbits should you raise?
-  Now you must decide
-  How to begin
  -  (*introduction...*)
  -  Where can you put your rabbit pens?
  -  What materials can you use to build rabbit pens?
-  Building the rabbit pens
  -  (*introduction...*)
  -  Some simple rabbit pens
  -  How to build better rabbit pens
-  The rabbits
  -  (*introduction...*)

-  Choosing good rabbits
-  How to handle your rabbits
-  Bringing your rabbits home
-  Preparing the pens and putting in the rabbits



[Home](#) > [ar](#).[cn](#).[de](#).[en](#).[es](#).[fr](#).[id](#).[it](#).[ph](#).[po](#).[ru](#).[sw](#)

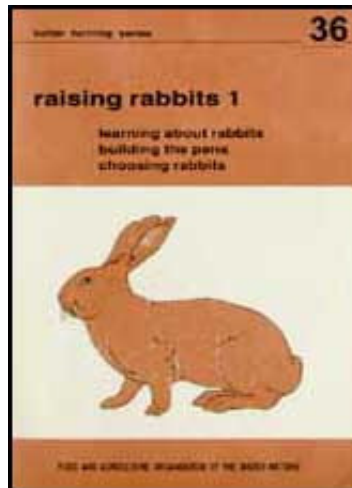

 Better Farming Series 36 - Raising Rabbits 1: Learning about Rabbits; Building the Pens; Choosing Rabbits (FAO, 1988, 56 p.)

  *(introduction...)*

 Preface

 Introduction



- Learning about rabbits
- How to begin
- Building the rabbit pens
- The rabbits

FOOD AND AGRICULTURE ORGANIZATION OF THE UNITED  
NATIONS  
Rome 1988

P-69

ISBN 92-5-102583-5

© FAO 1988



[Home](#) > [ar](#).[cn](#).[de](#).[en](#).[es](#).[fr](#).[id](#).[it](#).[ph](#).[po](#).[ru](#).[sw](#)



Better Farming Series 36 - Raising

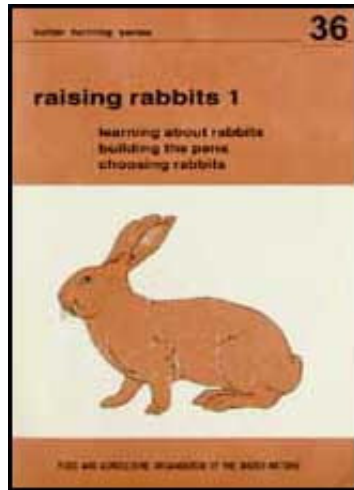

Rabbits 1: Learning about Rabbits;  
Building the Pens; Choosing Rabbits  
(FAO, 1988, 56 p.)

 (introduction...)

➔  Preface

Introduction

Learning about rabbits

How to begin

Building the rabbit pens

The rabbits

## Preface

The first 26 titles in FAO's Better Farming Series were based on the Cours d'apprentissage agricole prepared in Cte d'Ivoire by the Institut africain de dveloppement conomique et social for use by extension workers. Later titles, beginning with No.

27, have been prepared by FAO for use in agricultural development at the farm and family level. The approach has deliberately been a general one, the intention being to provide prototype outlines to be modified or expanded in each area according to local conditions of agriculture and specific training needs.

Many of the booklets deal with specific crops and techniques, while others are intended to give farmers more general information that can help them to understand why they do what they do, so that they will be able to do it better.

Adaptations of the series, or of individual volumes in it, have been published in Amharic, Arabic, Bengali, Creole, Hindi, Igala, Indonesian, Kiswahili, Malagasy, SiSwati, Thai and Turkish.

Requests for permission to translate and adapt this manual are

welcomed. Such translation work may, in specific cases, be supported by FAO. Requests should be addressed to the Director, Publications Division, Food and Agriculture Organization of the United Nations, Via delle Terme di Caracalla, 00100 Rome, Italy.



[Home](#) > [ar](#).[cn](#).[de](#).[en](#).[es](#).[fr](#).[id](#).[it](#).[ph](#).[po](#).[ru](#).[sw](#)

---



Better Farming Series 36 - Raising Rabbits 1: Learning about Rabbits; Building the Pens; Choosing Rabbits (FAO, 1988, 56 p.)



Introduction



(*introduction...*)



What do you need to raise rabbits?

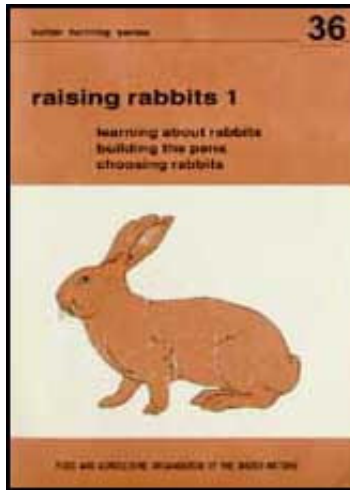

## **Better Farming Series 36 - Raising Rabbits 1: Learning about Rabbits; Building the Pens; Choosing Rabbits (FAO, 1988, 56 p.)**

### **Introduction**

1. A very good way for you and your family to improve your lives is to raise your own rabbits. If you raise your own rabbits



you will always have fresh meat.

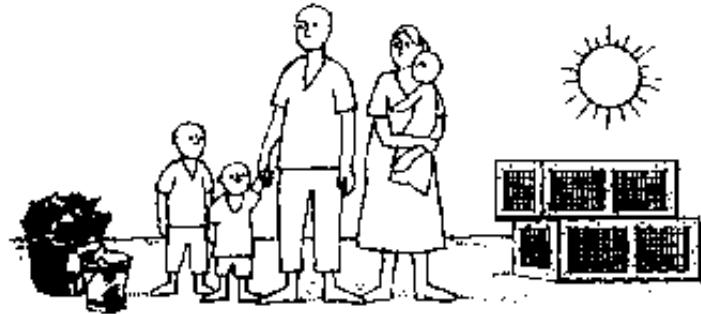

Family

2. Rabbit meat is good for you. It also tastes good. Rabbit meat will help to keep your family strong and healthy.

3. Rabbits are easy to raise. They are clean, quiet and small. You can keep many rabbits in a very small place.

4. The meat that you will get, even by raising only a few rabbits, will help your family to eat better.

5. You can easily find enough food to feed a few rabbits. You can even grow some of the food yourself.
6. Since one rabbit makes a good meal, and you can eat them one at a time when you need meat, you will not have to worry about rabbit meat going bad.
7. Rabbits have babies often. Starting with only a few full-grown rabbits, you can raise many baby rabbits, which will give you a lot of meat.

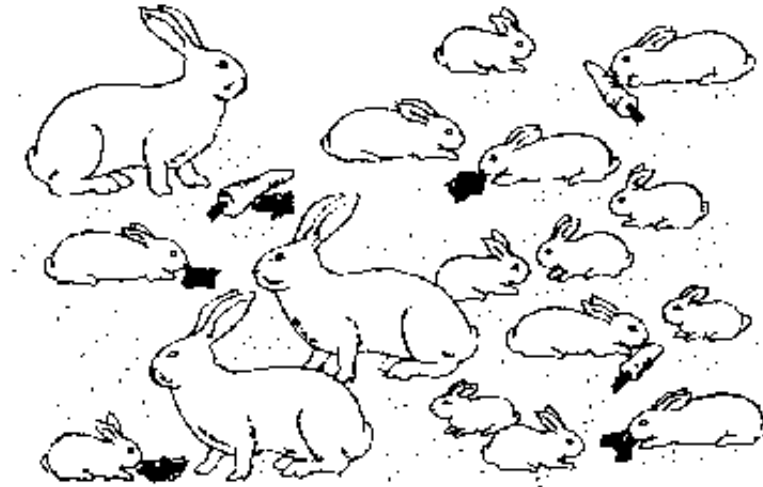

### Rabbits and babies

8. If you grow more rabbits than you need to eat, you can sell what you do not use to your neighbours or at the market.
9. With more food to eat and with the money you get from selling rabbits, you and your family can live better.
10. However, if your family is big, you will have to raise more

rabbits if you are going to have enough to eat and to sell at the market.

## **What do you need to raise rabbits?**

You will need

- healthy, full- grown rabbits
- the kinds of food that rabbits eat and plenty of fresh water
- a pen for each full- grown rabbit and pens for the young rabbits
- time to take care of the rabbits

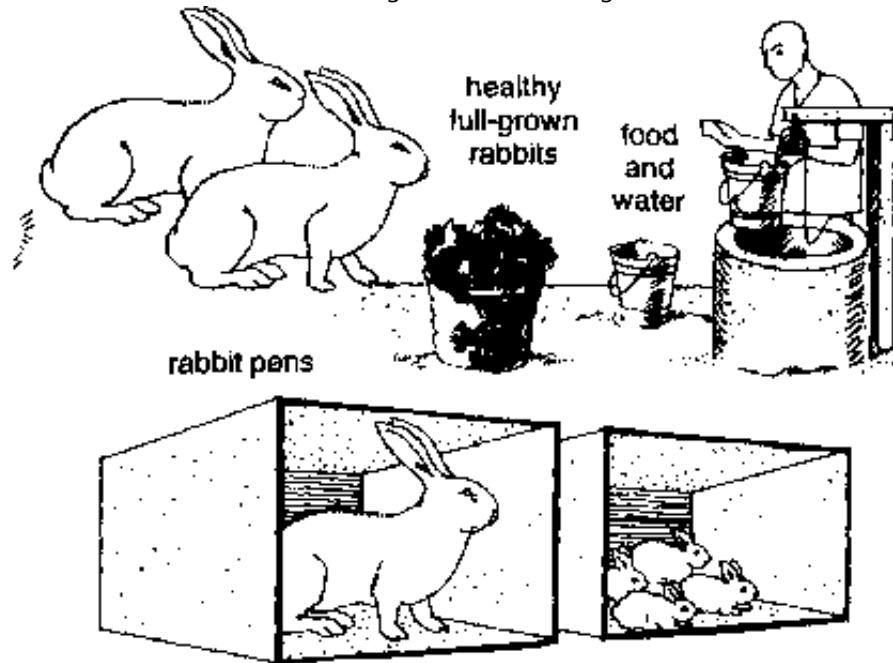

Healthy full grown rabbits' food and water; rabbit pens

11. Later in this booklet you will learn where to get rabbits, how to grow or find their food, and how to build their pens using materials you have at home.



[Home](#) > [ar](#).[cn](#).[de](#).[en](#).[es](#).[fr](#).[id](#).[it](#).[ph](#).[po](#).[ru](#).[sw](#)

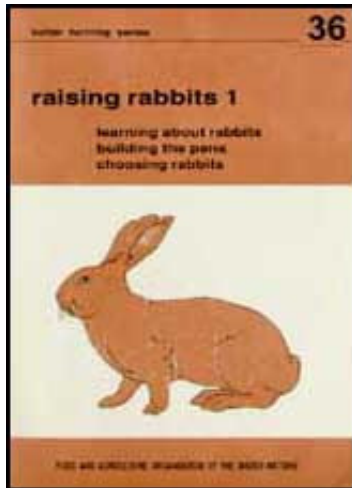

Better Farming Series 36 - Raising Rabbits 1: Learning about Rabbits; Building the Pens; Choosing Rabbits (FAO, 1988, 56 p.)



Learning about rabbits



*(introduction...)*



What kinds of rabbits can you raise?



What can rabbits eat?



How many rabbits should you raise?



Now you must decide

## **Better Farming Series 36 - Raising Rabbits 1: Learning about Rabbits; Building the Pens; Choosing Rabbits (FAO, 1988, 56 p.)**

### **Learning about rabbits**

12. Rabbits are usually very healthy and hardy animals that grow well if you are careful.

13. If you give them a good home and take care of them well they will be less likely to get sick.

14. Remember, it is much easier to keep rabbits from getting sick than it is to make them well after they have become sick.

15. Rabbits must have a quiet place to live where they will feel safe and well protected.

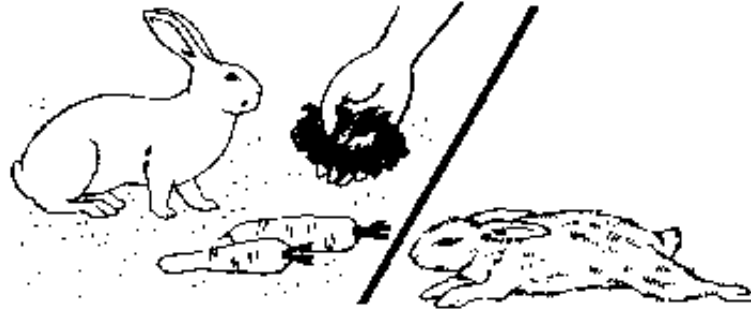

A quiet place to live

16. Rabbits are very quiet animals and are easily frightened. If they become badly frightened, they may become sick or die.

17. So, you must give them a home away from people and noise and animals that may frighten or even harm them, such as foxes, rats, snakes, dogs or cats.

18. If you decide to raise rabbits, the same person should take care of them all of the time



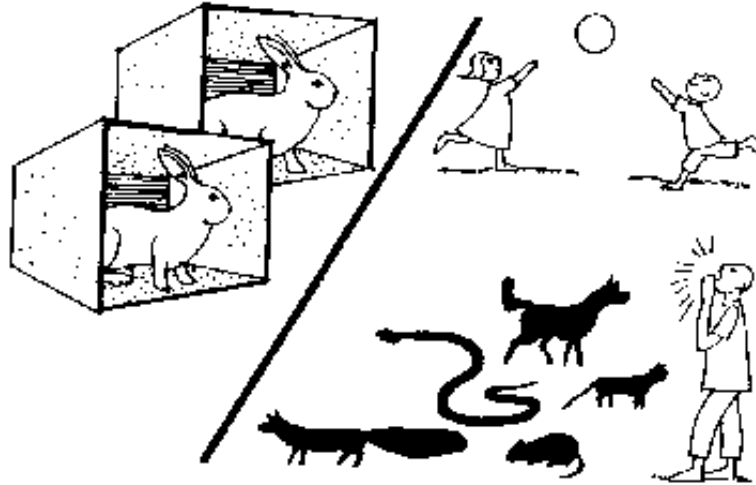

Same person should take care of rabbits all of the time

19. That way, the rabbits will become used to their keeper and will not be frightened.

Sun, wind, rain and fresh air

20. Rabbits may not grow well if they get too much sunshine. They must have a shady place where they can go to get out of

the sun.

21. Rabbits may become sick or die if it is too windy or if they get wet. Rabbits should never be wet. So, they must have a place that is protected from wind and rain.

22. However, rabbits need fresh air. So, if you decide to raise rabbits you must give them a place to live that is closed enough to protect them from the sun, the wind and the rain and yet open enough to allow for plenty of fresh air.

23. Rabbits should have clean, dry homes. You should clean their pens every day, in order to keep them clean and dry.

### PROTECTION

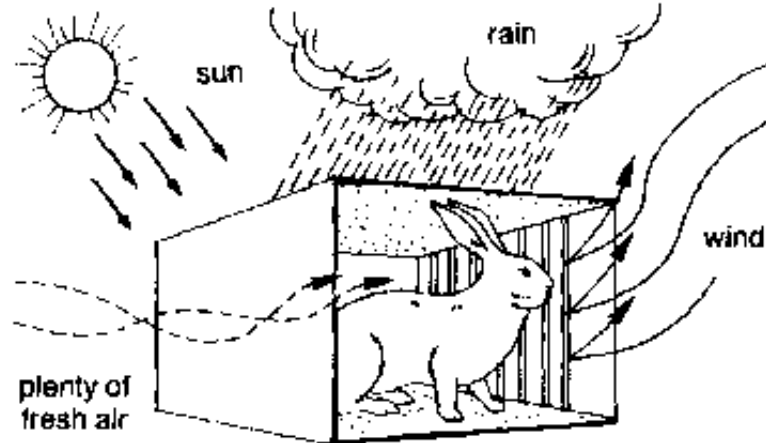

Clean pens, clean food and plenty of clean water

24. Rabbit droppings should never be allowed to collect on the floor of the pen.

25. Rabbits should have clean fresh food and fresh water all of the time.

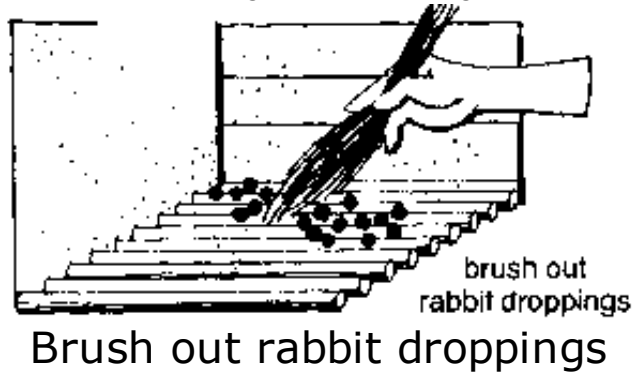

26. Rabbits should be given food twice each day, once early in the morning and once in the evening, after sunset, and water as often as they need it.

27. You will have to be especially careful that your rabbits have enough to eat and drink at night, since they eat and drink as much at night as they do during the day.

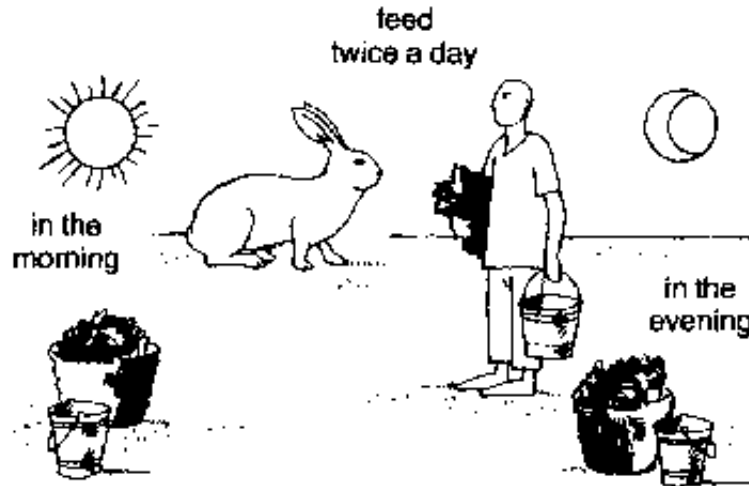

Feed twice a day

28. If your rabbits' food or water becomes old or dirty throw it away, clean their feeders and water containers and give them fresh food and water.

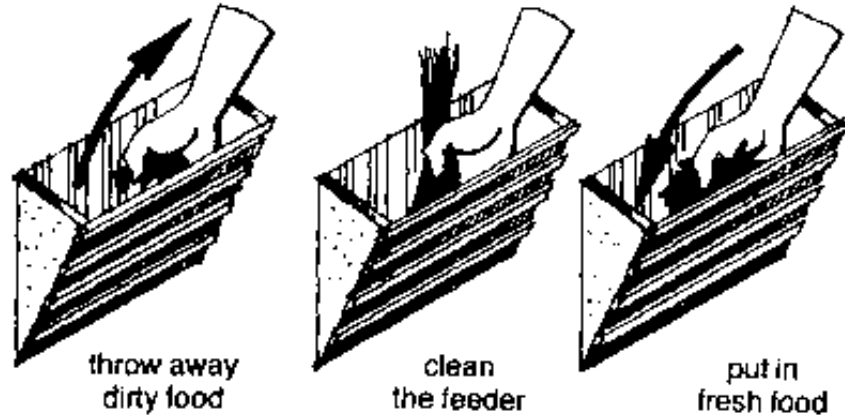

Throw away dirty food; clean the feeder; put in fresh food

## **What kinds of rabbits can you raise?**

29. There are many kinds of rabbits, all with different sizes, shapes and colours and with different kinds of fur.



Different types of rabbits

30. Some rabbits are small and weigh very little. Other rabbits are large and weigh a lot.

31. You must find out the kinds of rabbits that you can get where you live. In most places, you can find several kinds of rabbits.

32. Usually, you can get local rabbits. Local rabbits are strong and hardy and used to living in your area. So, they grow well

and do not get sick easily. However, local rabbits are often small and give little meat.

33. Sometimes, you can get improved rabbits that have been brought from another place. Improved rabbits have been carefully mated over many years and they are better than local rabbits.

34. Improved rabbits are larger and give more meat. However, they are not as hardy as local rabbits. So, if you get improved rabbits you will have to take better care of them.

35. Sometimes local rabbits are mated with improved rabbits. When the babies are born, they have some of the qualities both these kinds of rabbits.



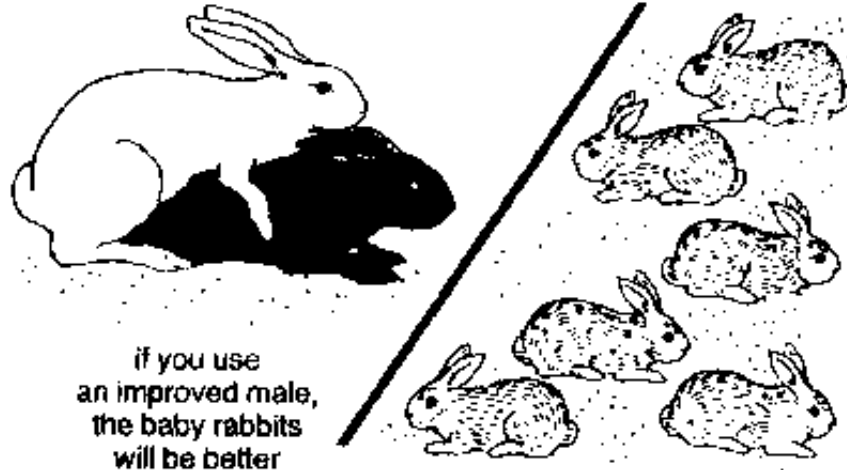

If you use an improved male, the baby rabbits will be better

36. Usually, they are stronger, healthier, live well locally, grow bigger and give more meat than local rabbits.

37. However, if you can get them, the very best kind of rabbits for you to raise are medium- sized improved rabbits. These grow more quickly and give the most meat for the amount of food they eat.

38. The drawings on the next page show you three kinds of improved, medium- sized rabbits.



NEW ZEALAND RABBIT (white or red)



## CALIFORNIAN RABBIT

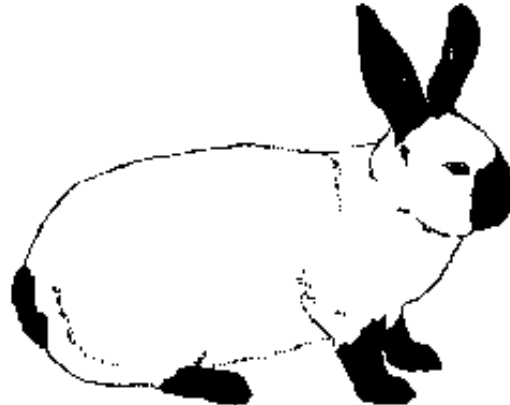

## BLUE VIENNA RABBIT

39. If you need help, your extension agent will be able to give you good advice on the kinds of rabbits you can get and where to get them.

### **What can rabbits eat?**

40. Rabbits eat almost any kind of plant that is not sour or spoiled. Much of the food that they eat is not needed for anything else.

41. So, you can raise rabbits, using very little of the food that you need for your family or for your other farm animals.

42. Rabbits mostly eat green plant materials such as leaves or stems, or parts of green plants that you do not use. They also eat many kinds of weeds.



Rabbit

43. If you have nothing else, you can feed your rabbits only green plants and weeds.

44. However, if you want them to grow very well and fast you will also have to feed them some richer foods.

45. In many places, you can buy good, rich foods made especially for rabbits. These are called rabbit pellets.

46. Some farmers feed only pellets, and their rabbits grow very well. However, rabbit pellets cost a lot of money.

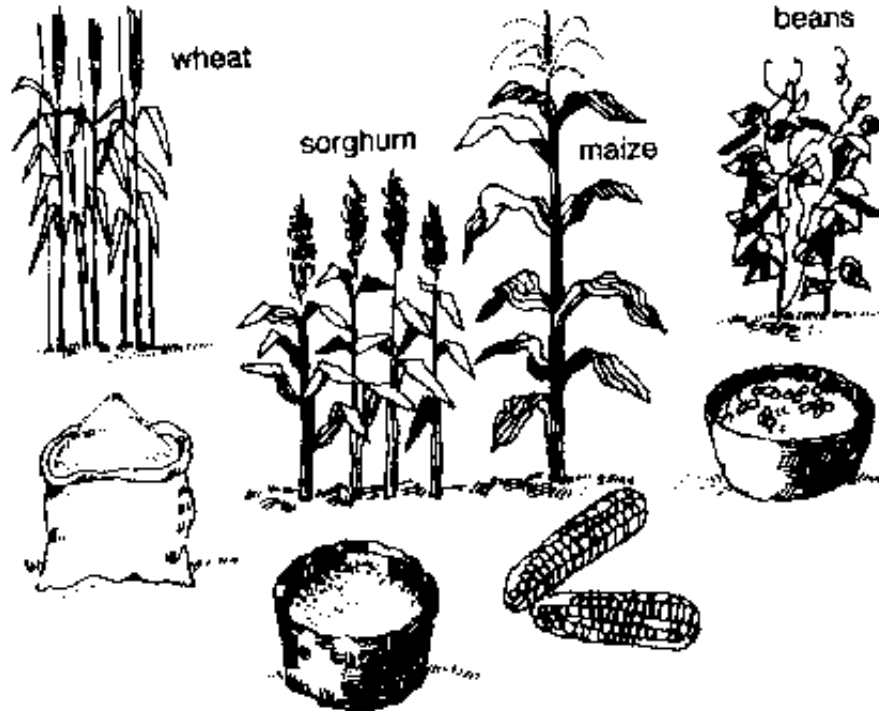

Rabbit foods

47. There are many other rich foods that you can give your rabbits, which do not cost so much or which you can grow

yourself, such as wheat, barley, beans, maize, sorghum, millet or soybeans.

43. You will learn more about what to feed rabbits and when and how to feed them in the next booklet in this series.

### **How many rabbits should you raise?**

49. You can raise many rabbits if you have enough for them to eat, the materials to build enough pens and the time to take care of them.

50. However, until you know more about how rabbits live and grow and what you must do to take care of them well, it is best to start with only a few.

51. A good number to start with is two full- grown female rabbits and one full- grown male rabbit.

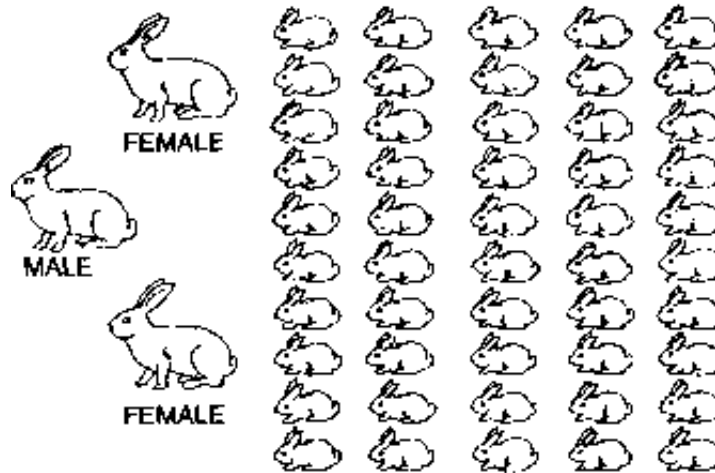

Start with two female and one male rabbit

52. With two females, you will get as many as 40 to 50 baby rabbits each year.

53. Later, if you find that you could eat or sell more rabbits if you had them, you can begin to raise more.

**Now you must decide**



54. In the first part of this booklet you have been told a number of things about rabbits and about raising them.

55. You learned that by raising rabbits, you will always have fresh meat. You also learned that rabbits will grow well if you take care of them well and feed them well.

56. You may also have found that you can get healthy full-grown rabbits where you live.

57. So, now you must decide if raising rabbits would be good for you and your family.

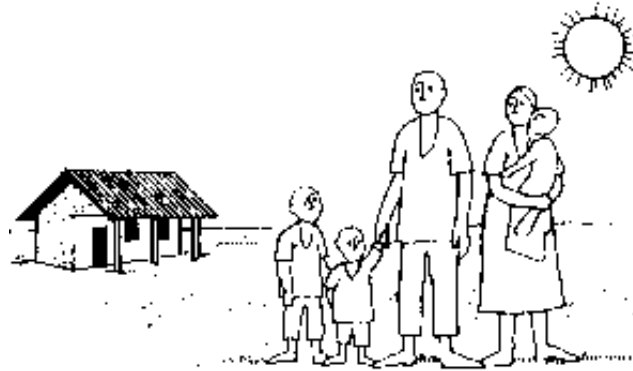

Family

58. If you decide to raise rabbits, you will learn how to begin in the rest of this booklet and in the next booklet In this series.



[Home](#) > [ar](#).[cn](#).[de](#).[en](#).[es](#).[fr](#).[id](#).[it](#).[ph](#).[po](#).[ru](#).[sw](#)



Better Farming Series 36 - Raising

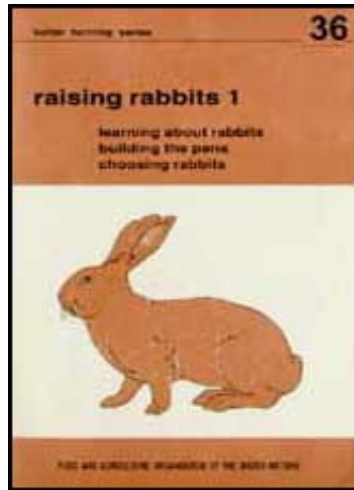

## Rabbits 1: Learning about Rabbits; Building the Pens; Choosing Rabbits (FAO, 1988, 56 p.)

- ➔ □ How to begin
  - 📄 *(introduction...)*
  - 📄 Where can you put your rabbit pens?
  - 📄 What materials can you use to build rabbit pens?

## **Better Farming Series 36 - Raising Rabbits 1: Learning about Rabbits; Building the Pens; Choosing Rabbits (FAO, 1988, 56 p.)**

### **How to begin**

59. The first thing that you will have to do is to build pens for

your rabbits.

60. To begin you will need one pen for each full- grown rabbit. You will also need one pen for the young rabbits of each female.

61. If you decide to start with two females and one male rabbit, as you were told to do in Item 51 in this booklet, you will need five pens.

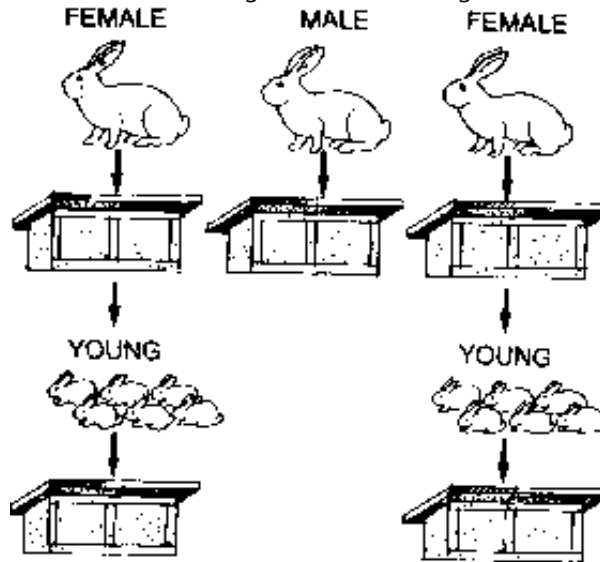

Starting with two females and one male rabbit

## Where can you put your rabbit pens?

62. The best place for rabbit pens is near your home. That way you can watch your rabbits, take care of them easily and protect them from animals.

63. You have already been told that rabbits are easily frightened. So, try to choose a place that is quiet and peaceful, away from animals, people and noise.

64. You were also told that wind is bad for rabbits. So, try to choose a place that is protected from the wind.

65. Perhaps you have a place that is protected from wind by the walls of your house, a fence, some trees or a hill.

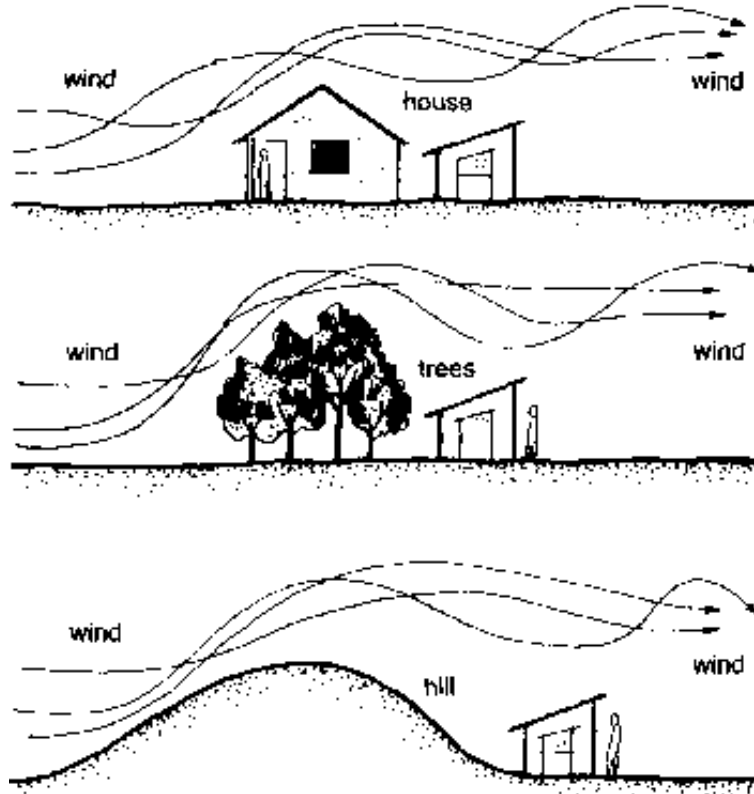

Wind

66. If it rains a lot where you live, put your pens in a place that is sheltered from the rain. You can also build a shelter over the pens to protect your rabbits and keep them dry (see page 43 in this booklet).

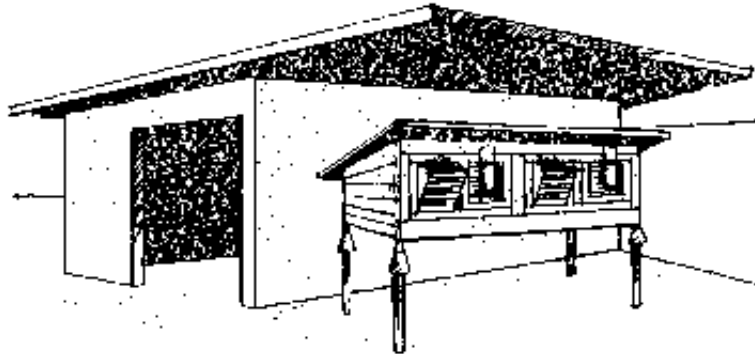

Shelter

67. If you have a wall around your house and farm buildings, put your rabbit pens inside the wall, as shown below.



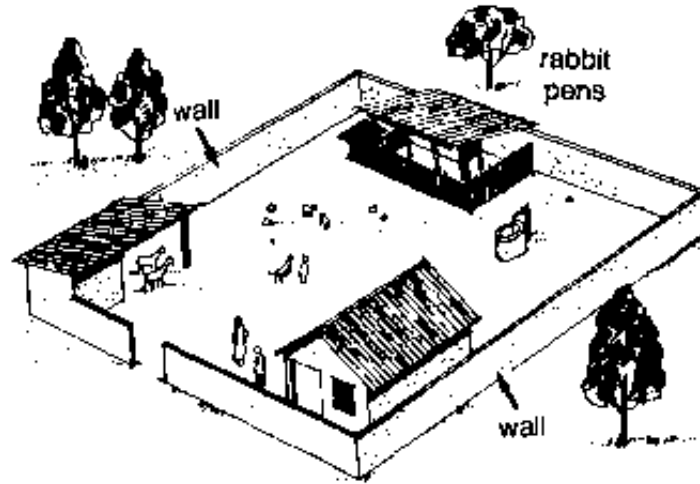

Put rabbit pens inside the wall

## **What materials can you use to build rabbit pens?**

68. Wire mesh is the best material for building rabbit pens. It lasts a long time and is easy to keep clean. However, wire mesh may be hard to find and it costs a lot of money.

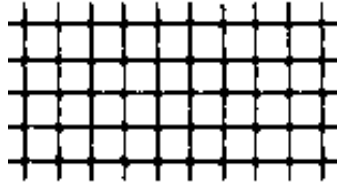

wire mesh 1.25 x 1.25 mm

69. Later, if you begin to sell rabbits you may want to use some of the money that you make to buy wire mesh for your pens.

70. You will be shown how to build pens with wire mesh floors and walls in the next booklet in this series.

71. You can also build good pens using materials that cost little money such as used wood, old boxes, crates, poles from straight tree branches or bamboo.

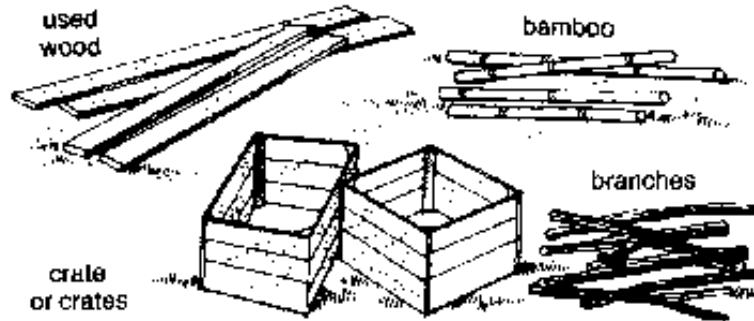

Use cheap materials



[Home](#) > [ar](#).[cn](#).[de](#).[en](#).[es](#).[fr](#).[id](#).[it](#).[ph](#).[po](#).[ru](#).[sw](#)



Better Farming Series 36 - Raising Rabbits 1: Learning about Rabbits; Building the Pens; Choosing Rabbits (FAO, 1988, 56 p.)



Building the rabbit pens

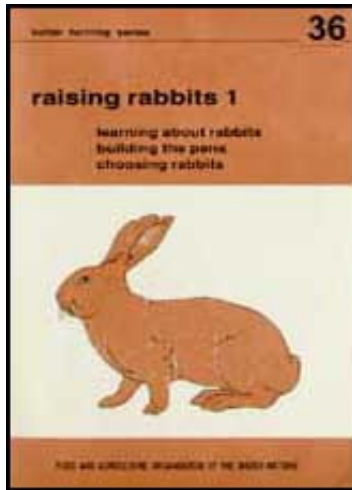

*(introduction...)*



Some simple rabbit pens

How to build better rabbit pens

## **Better Farming Series 36 - Raising Rabbits 1: Learning about Rabbits; Building the Pens; Choosing Rabbits (FAO, 1988, 56 p.)**

### **Building the rabbit pens**

72. Whichever materials you use, it is best to build your pens side by side, as shown below. That way, two pens will share a

wall and you will need fewer materials.

73. Build your pens on legs above the ground. That way, the rabbit droppings will fall to the ground and not collect on the floor.

74. In addition, a pen on legs will help to keep the rabbits safe from other animals.

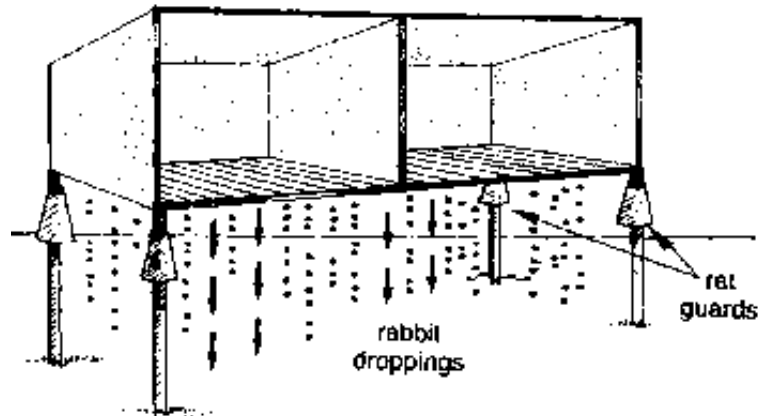

Pen on legs

## Note

Be sure to fit your pens with metal guards (see page 38) to keep rats and other small animals from getting to your rabbits.

75. A good size for a rabbit pen is 70 centimetres wide by 90 centimetres long and 50 to 60 centimetres high.

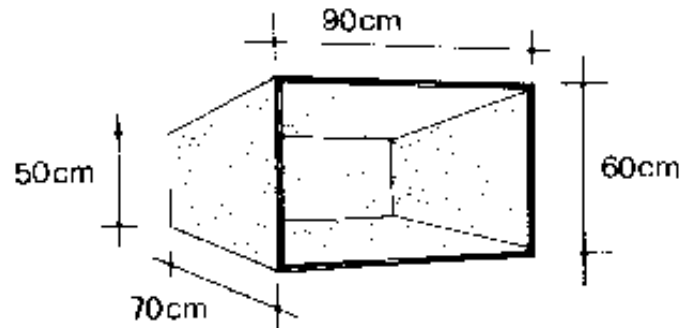

Pen sizes

76. This size of pen is good both for full-grown and for young rabbits, so, you will need to build only one size of pen.

77. Make the inside of each pen as smooth as you can. This is to keep your rabbits from hurting themselves.

78. There are many ways to build pens. If you know another farmer who raises rabbits, perhaps you can get some good ideas from him.

79. The drawings on the next page show you several simple rabbit pens that you can build easily.

80. If you want to build a better pen, the drawings on pages 22 to 43 will show you how. You will also learn how to make feeders for plants and grain and how to build nest boxes.

## **Some simple rabbit pens**

**rabbit pens**

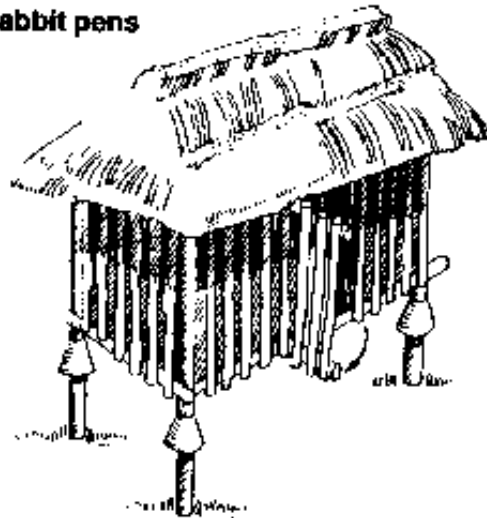

Rabbit pen



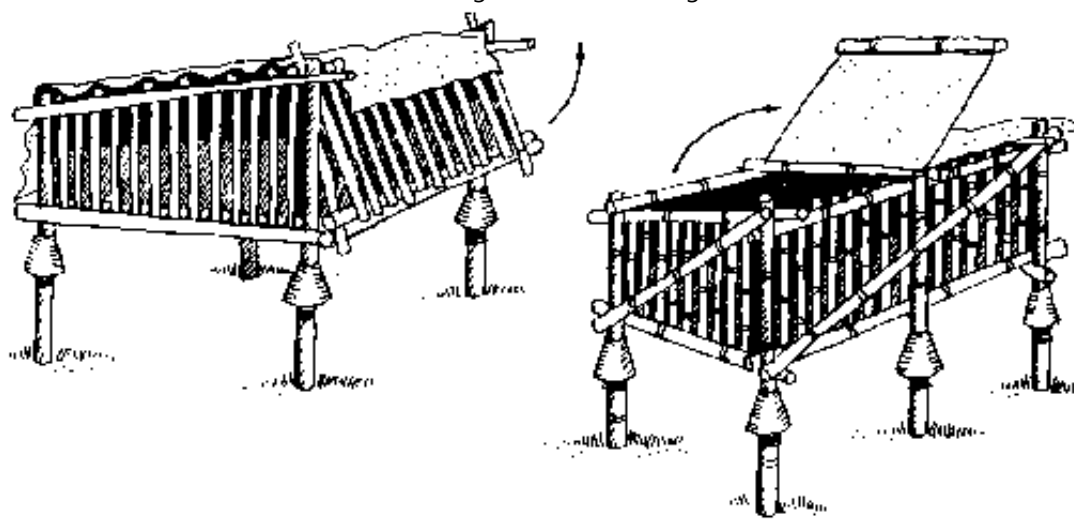

Rabbit pen

## How to build better rabbit pens

1 you will need four posts of about 10 cm in diameter for the legs and two boards of about 4 x 10 cm for the floor braces (each post should be buried in the ground about 45 cm)

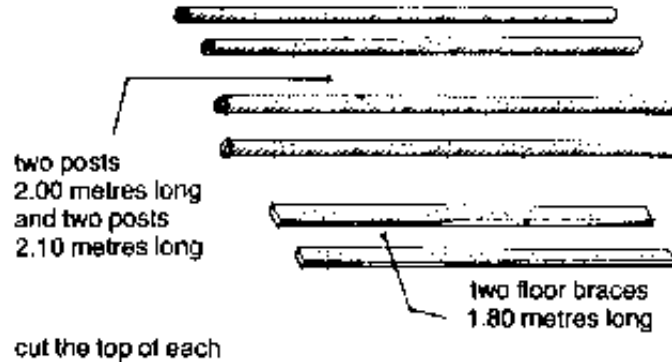

## Floors

2 cut the top of each of the floor braces as shown to keep the rabbit droppings from collecting on top of the boards

3 the floor braces can be attached to the posts using wood screws or bolts with nuts

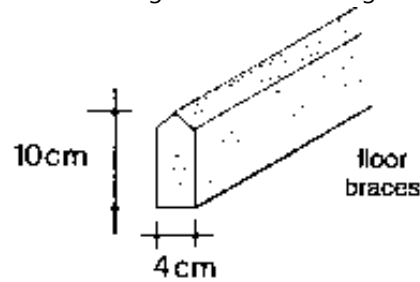

Floor brace

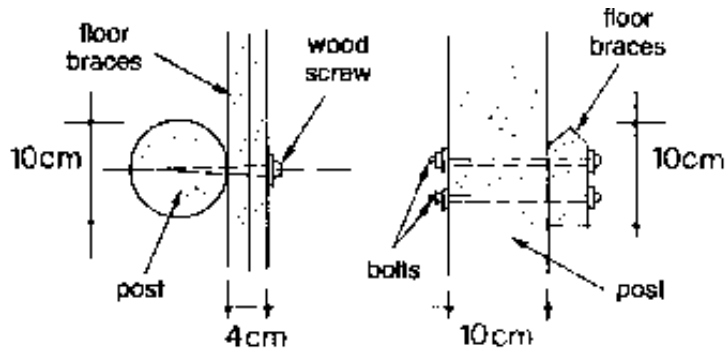

Floor braces

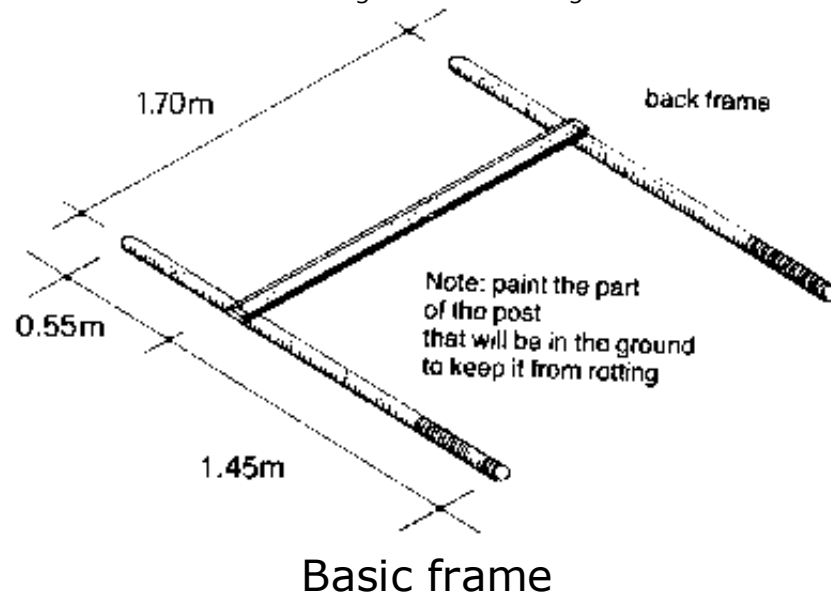

4 build the basic frames for the pens one frame for the back and one frame for the front, as shown above and below

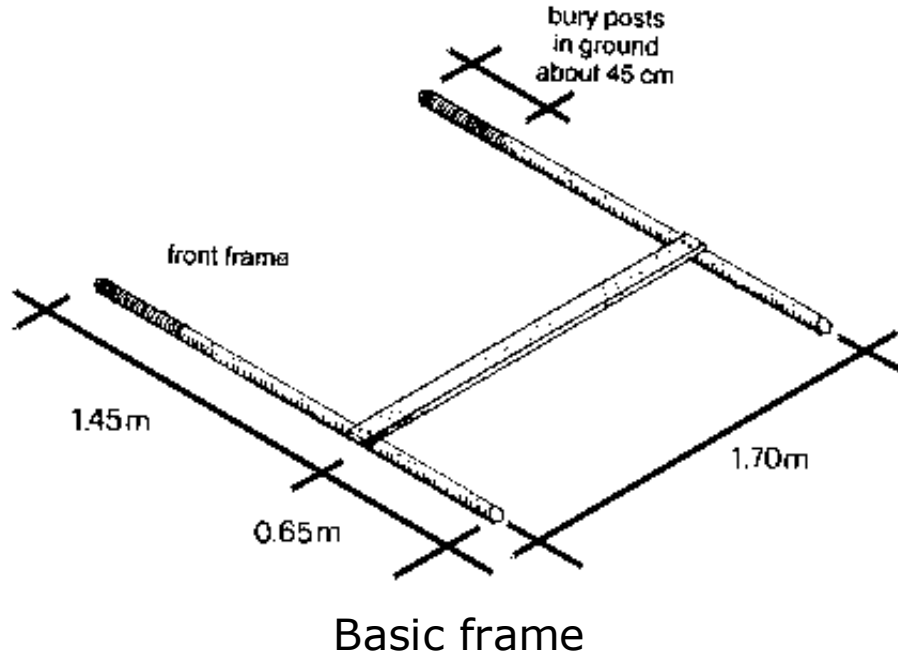

5 dig four holes about 50 cm deep and put about 5 cm of small stones in the bottom of each hole

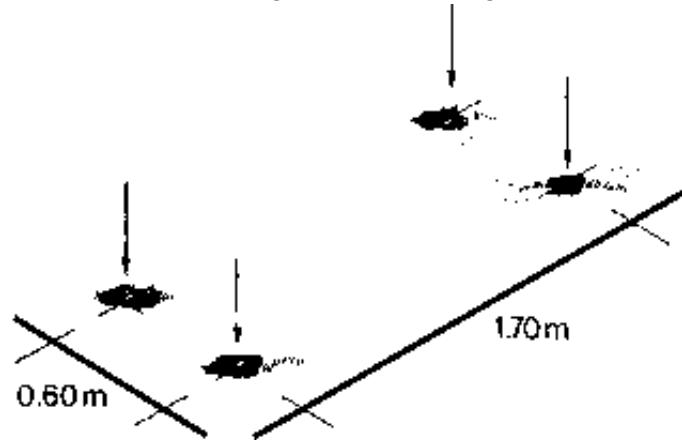

Dig the holes

6 put the frames in the holes and hold them straight with wood strips

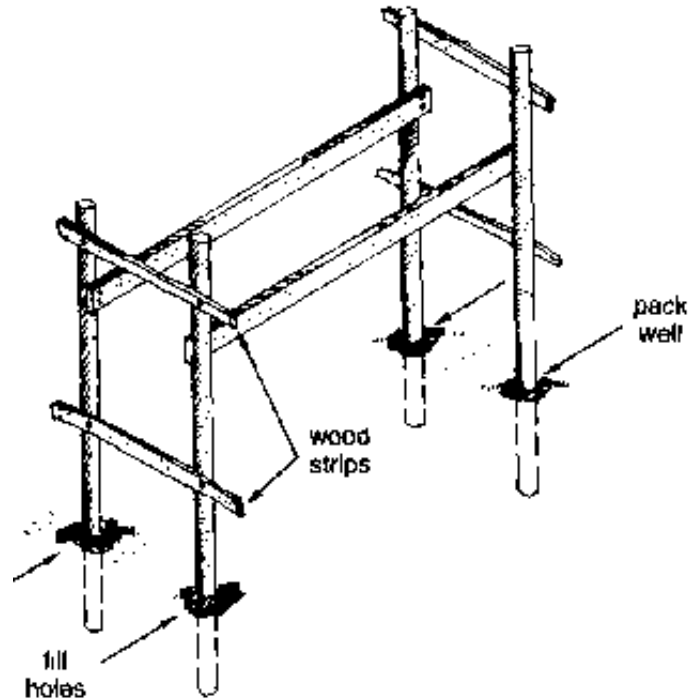

Put frames in holes

7 when the frames are level, fill the holes with earth and pack it well so that the frames cannot move

## 8 cover the ends of the pens with wooden boards

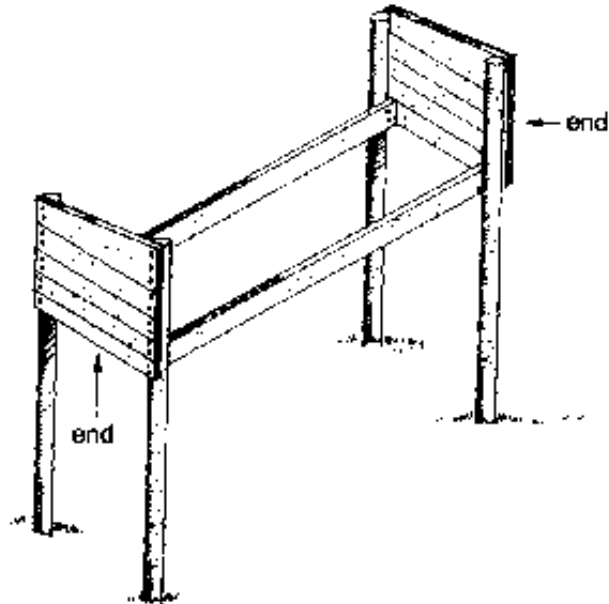

Cover the ends of pens

## 9 cover the back out the pens with wooden boards



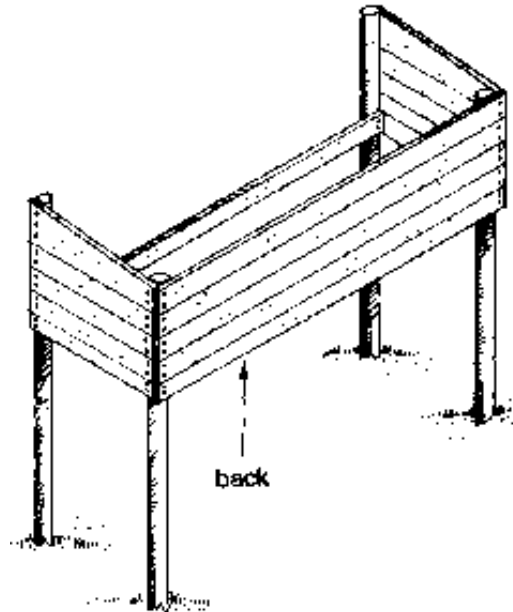

Cover the back out

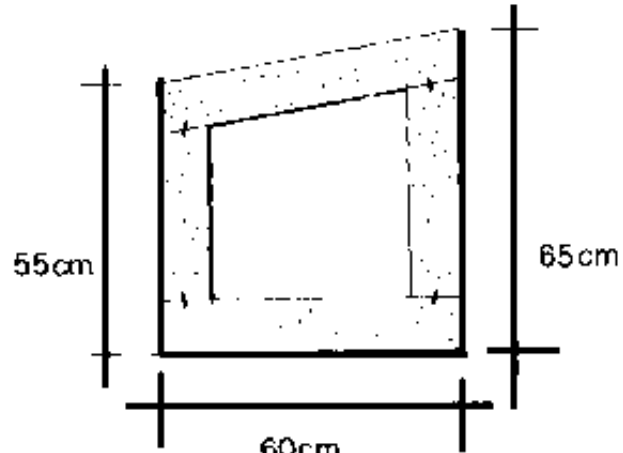

60cm  
Sizes

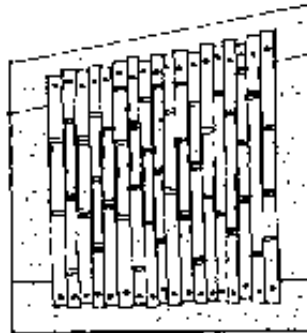

Cover

## 10 build a wall and cover it with bamboo or wooden strips

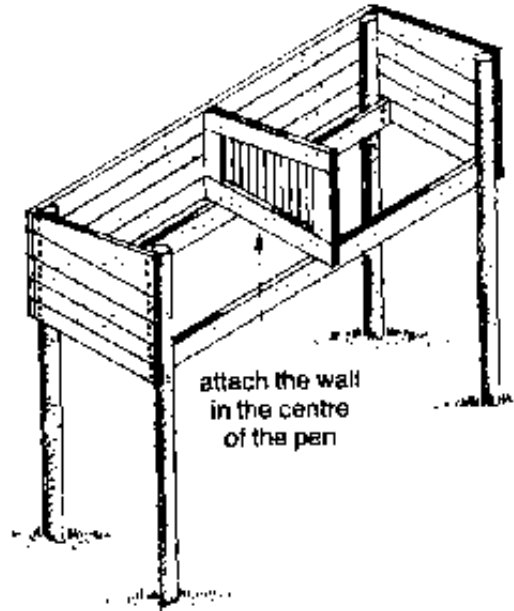

Attach the wall in the centre of the pen

## 11 attach a 15- cm board to the front of the pens, as shown

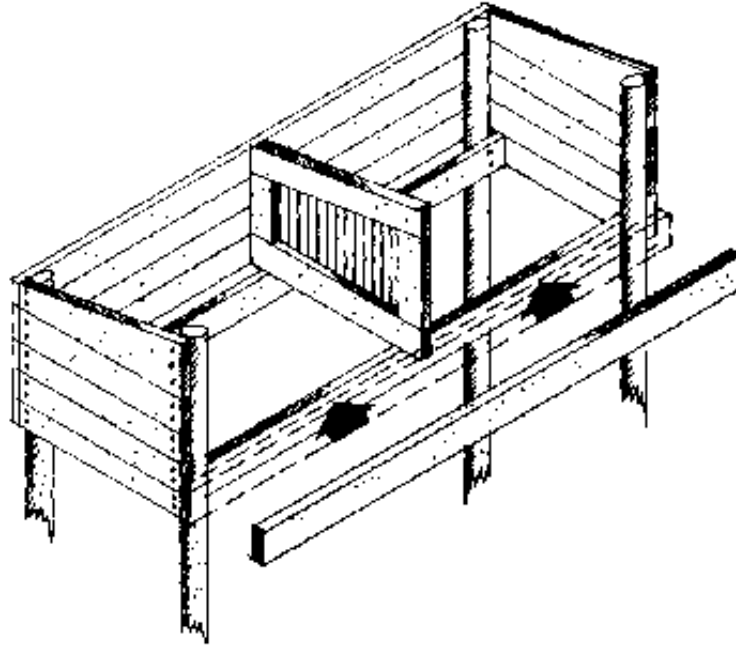

Attach the front of the pens

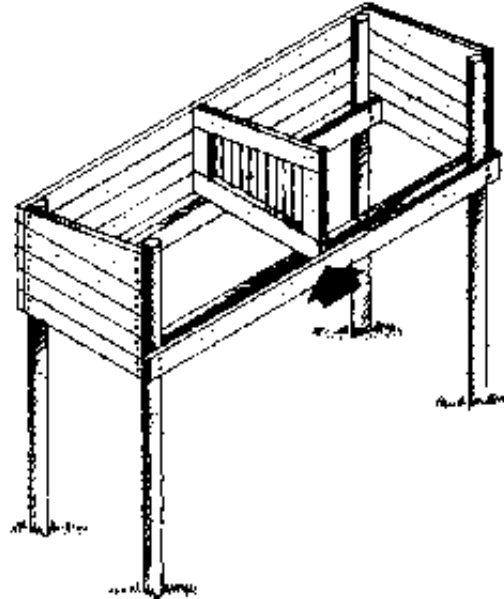

Front attached

12 when the board is in place, make sure that the wall in the centre is straight and fasten the front of the wall to the board (see arrow)

13 for the floor, you can use round pieces of wood, straight

tree branches or pieces of bamboo about 3 cm in diameter, with a space of no more than 1.5 cm between them

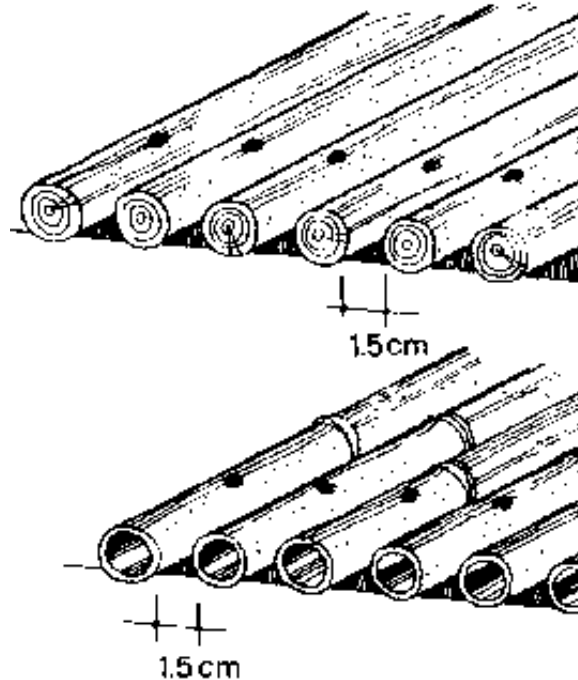

Round pieces of wood

14 if you use tree branches, be sure that they are straight or your rabbits may catch their legs and hurt themselves

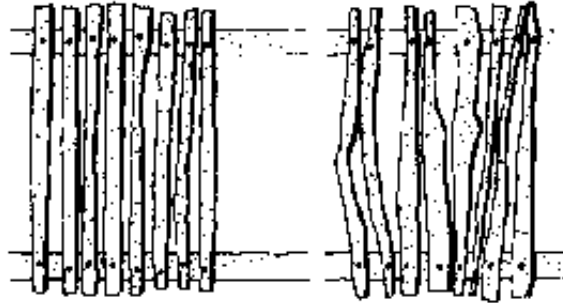

Tree branches

15 when you put in the floor, be sure that the space around the edge is no wider than 1.5 cm

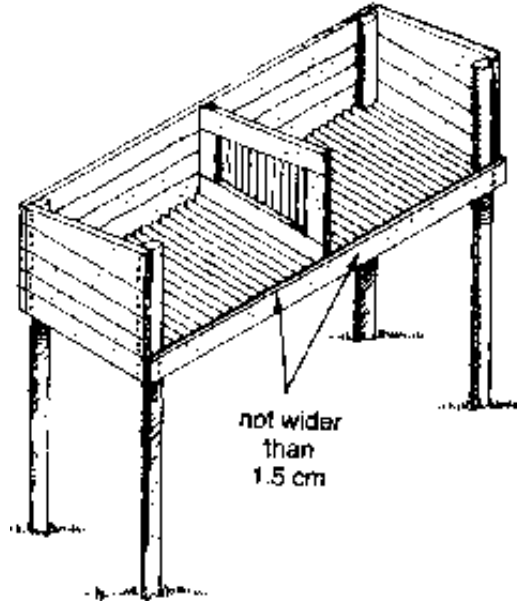

Space around edge



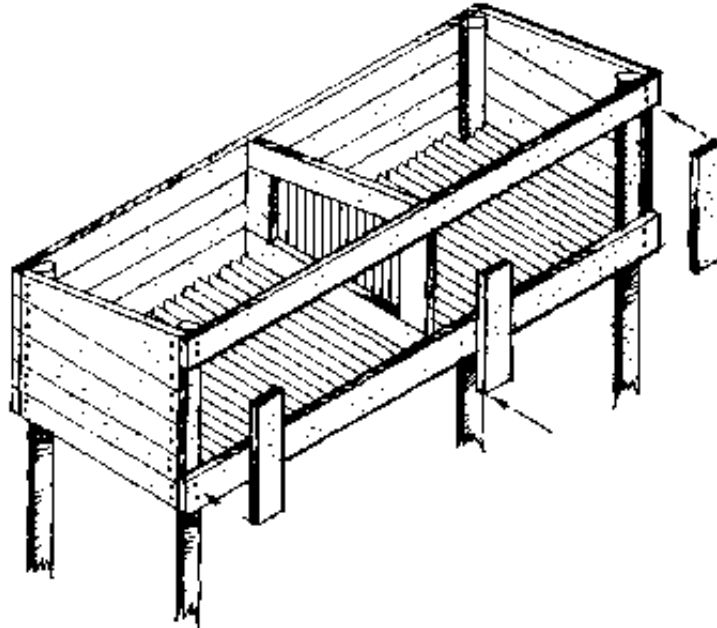

Finish boxing in the front

16 finish boxing in the front of the pens using 10 cm boards making sure that the openings are square and straight

17 attach four pieces of wood to the inside corners of each pen

(see arrows) to hold the pen doors on the inside

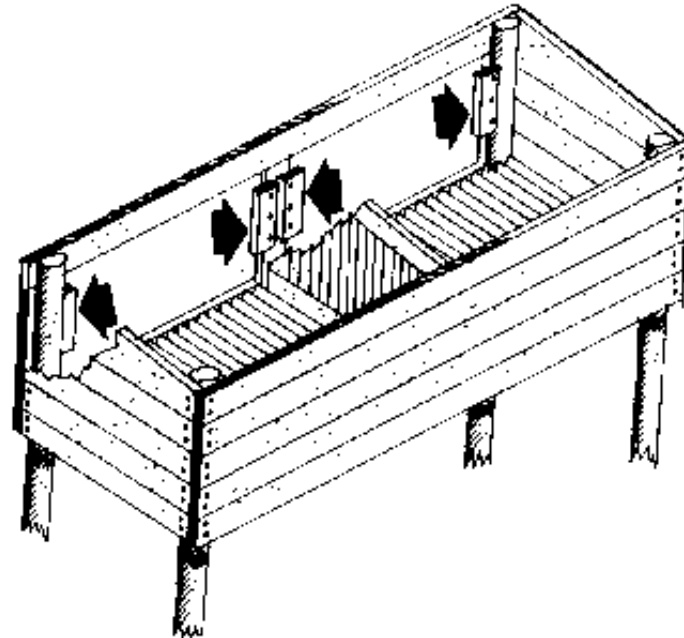

Attach four pieces of wood

18 attach four small wooden blocks that can be turned and a strip of wood (see arrows), to hold the pen doors on the

outside

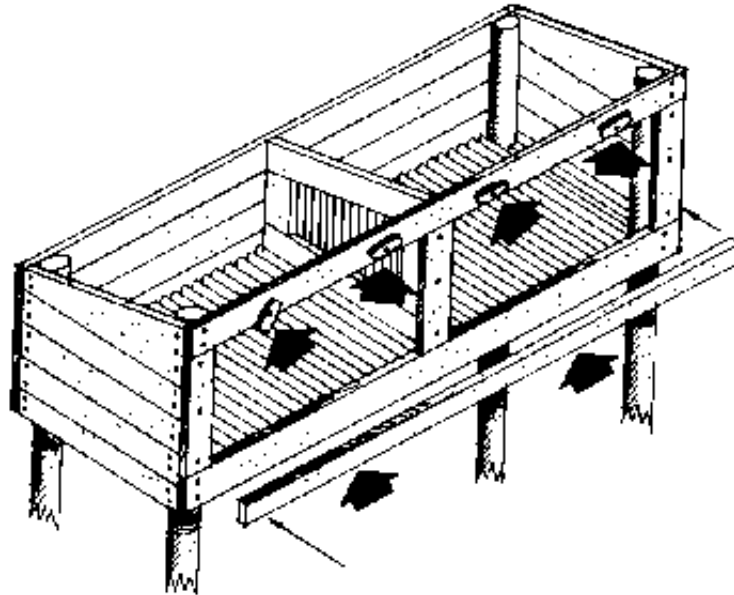

Attach four small wooden blocks

19 build a roof for the pens using wooden boards about 2 cm thick and of any width

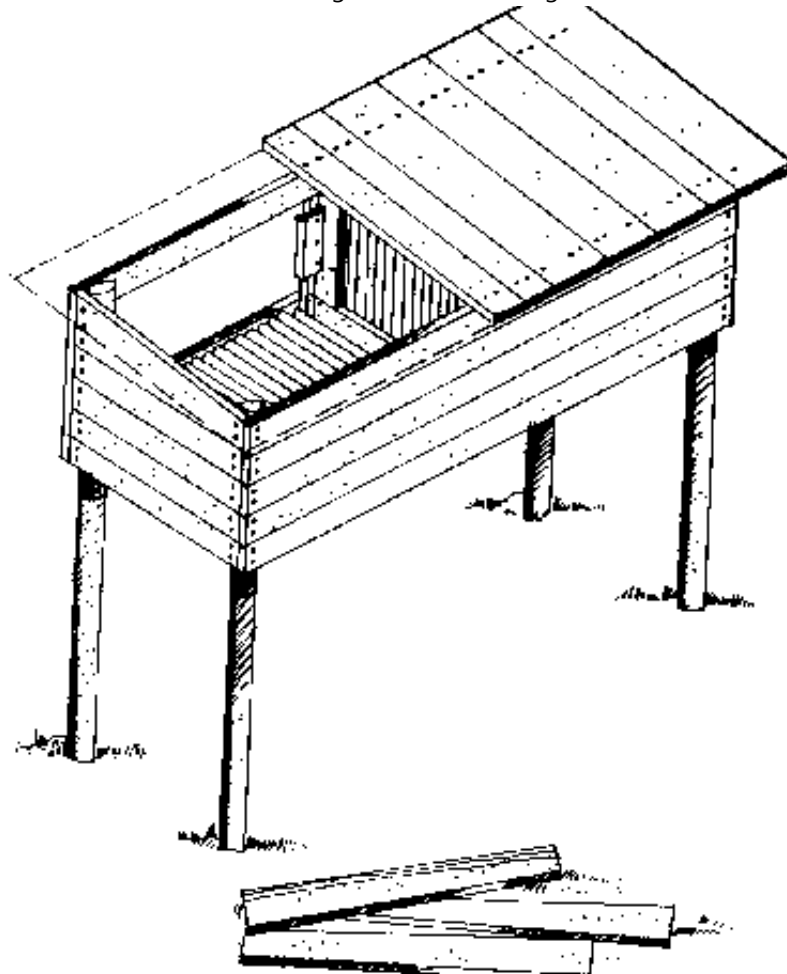

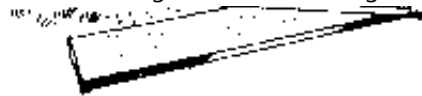

## Build the roof

20 cover the roof with a piece of sheet metal or pieces of tin cut from cans

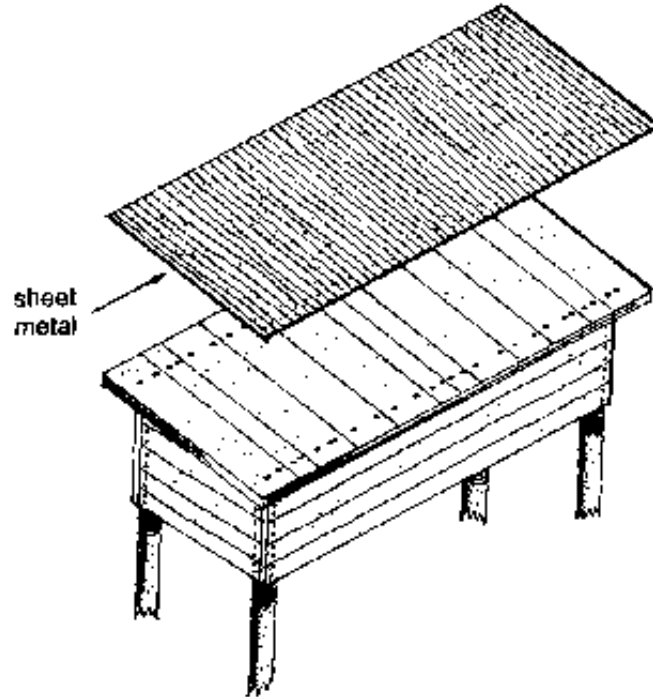

Cover with sheet metal

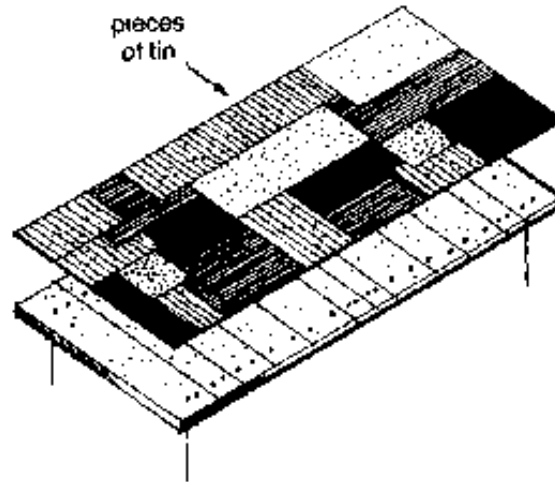

Or cover with pieces of tin

Note: if you use pieces cut from cans, begin by putting the first piece of tin at the bottom of the roof and overlap the edges of each piece of tin above it

21 build door frames for both pens; one to close the whole pen and another smaller door to fit inside the larger door

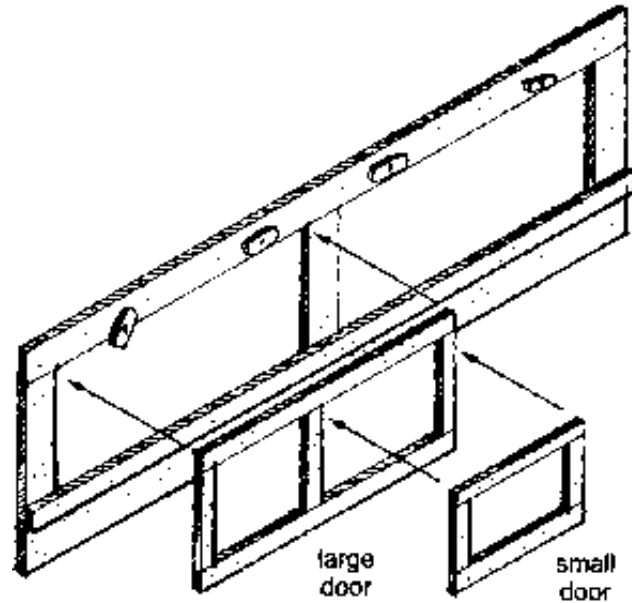

### Build door frames

22 cover the inside of the large and small door with wooden strips as shown below



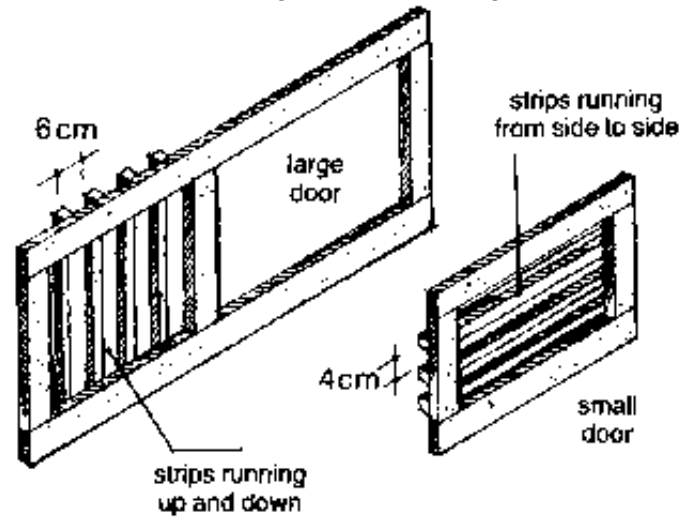

A plant feeder

23 make a plant container using two pieces of wood and close it with wooden strips

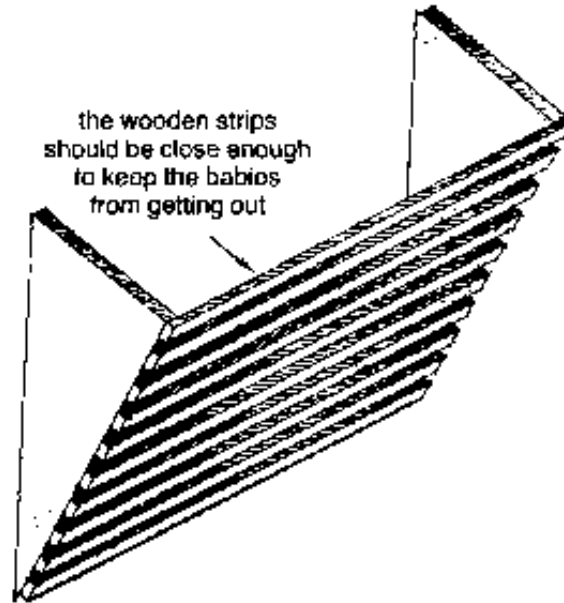

A water container

24 make a water container using a bottle and a tin, such as a sardine tin

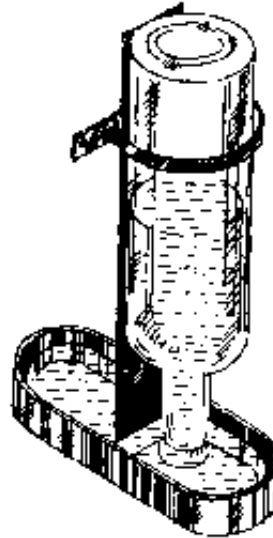

Sardine tin

25 attach the plant container to the large door and the water container to the small door

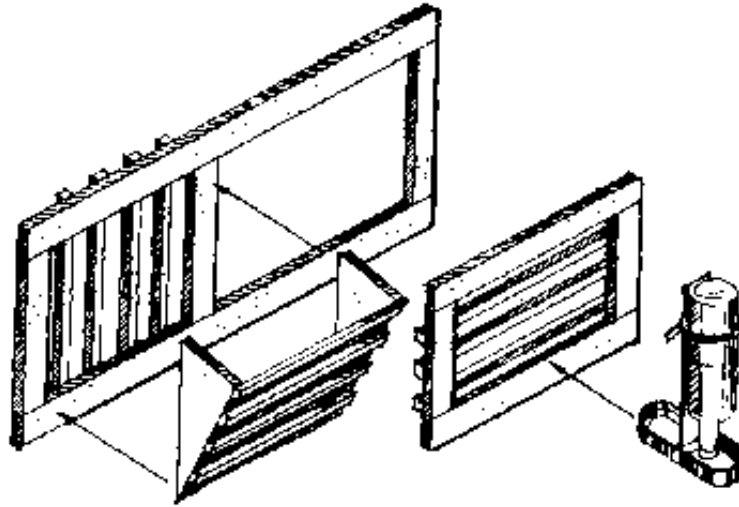

Attach them all

26 attach the small door to the large door

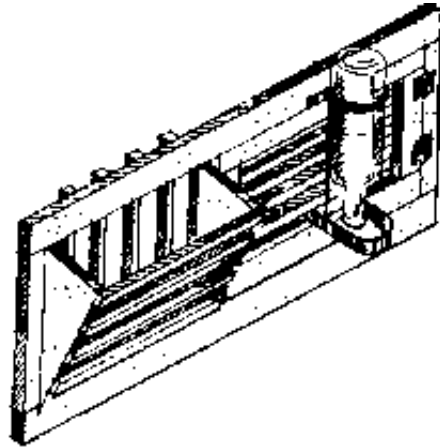

Attach the small to the large door

Ways to attach the small door

27 you can attach the small door using metal hinges or strips of leather



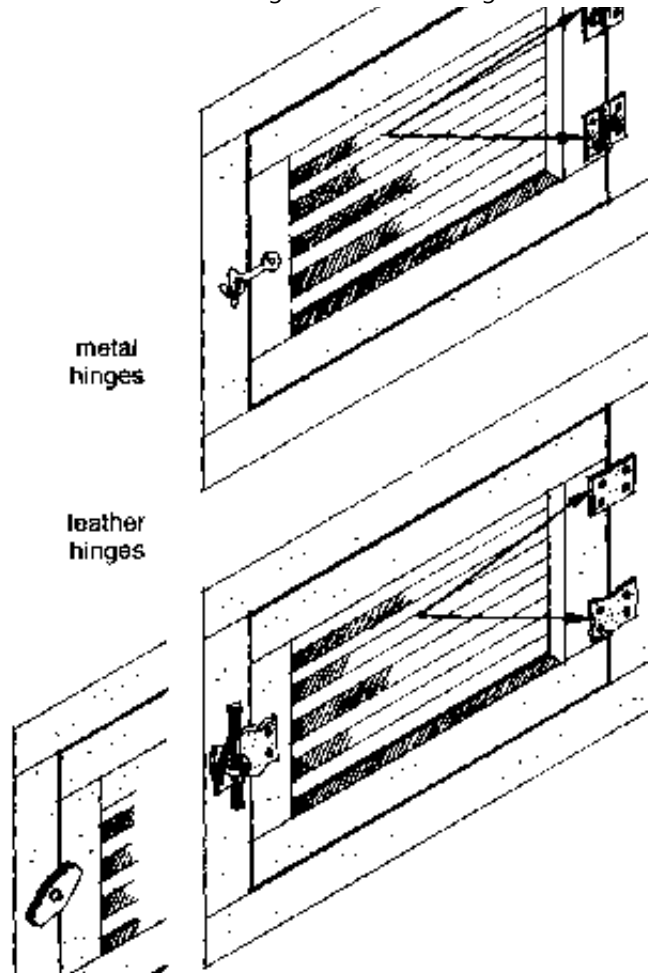

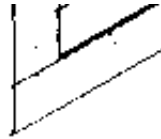

## Using metal hinges or strips of leather

28 when the small door is closed you can hold it in place with a hook and eye, a wooden block and screw, or a leather strap and a wooden pin

29 to finish the pens, put the large door and the small door in place in each pen and attach a rat guard to each of the legs

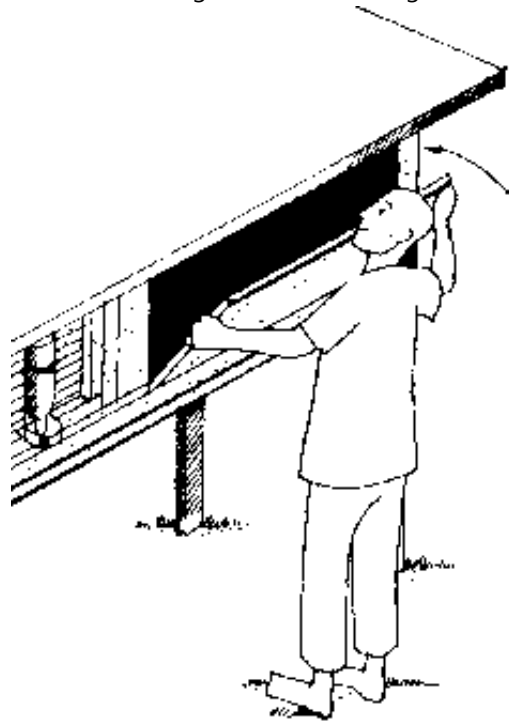

Put the doors in place



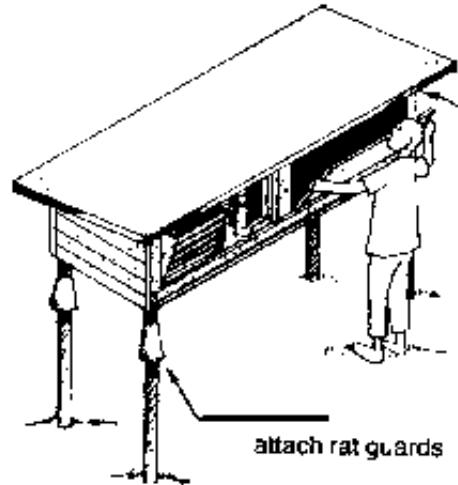

Attach the rat guards

How to make a rat guard

30 you can make rat guards for each of the legs of your pens using a piece of tin



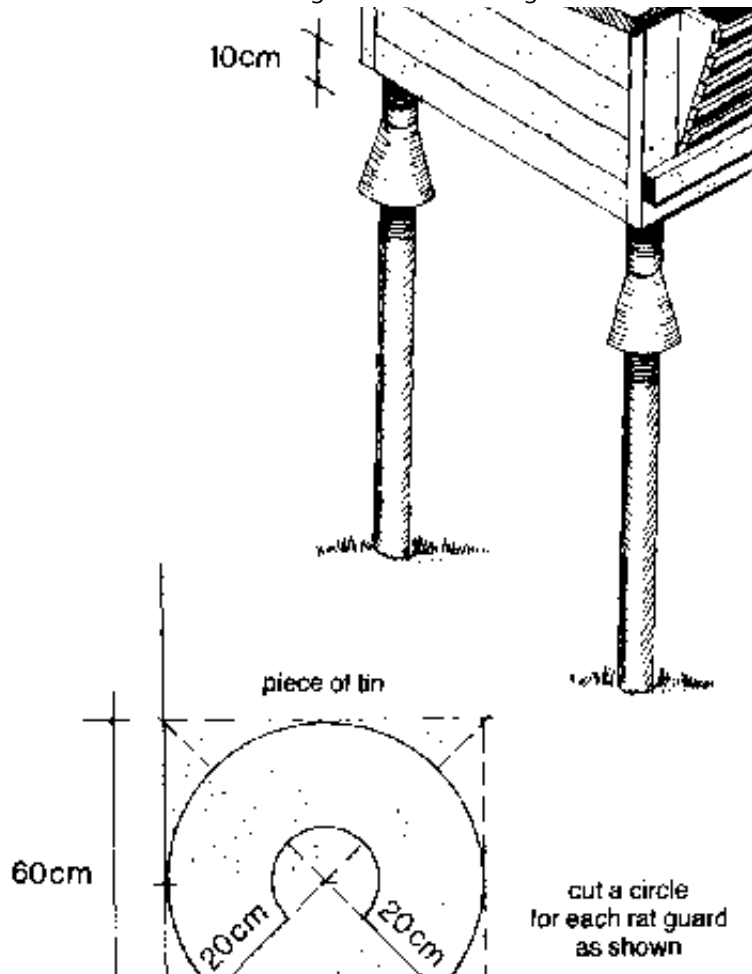

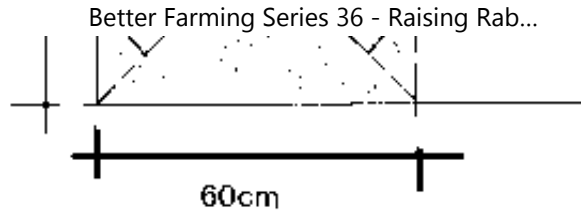

Cut a circle for each rat guard

Three kinds of grain feeders

31 for a grain feeder you can use a hollow piece of bamboo or a dish or other container. Attach the feeder to a piece of wood to keep the rabbits from spilling their food

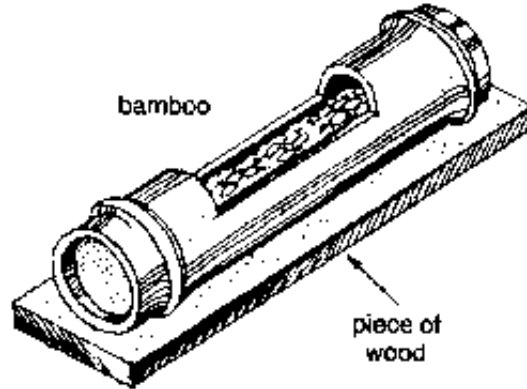

Bamboo

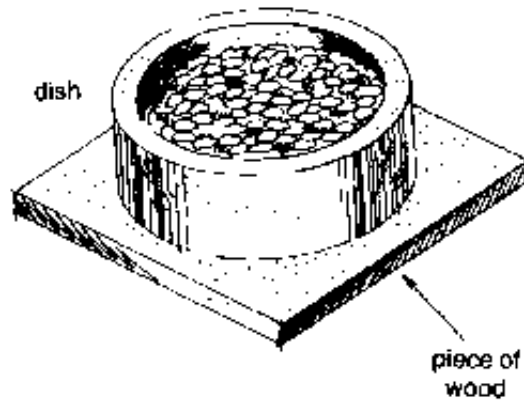

Dish

## 32 you can also make a grain feeder using tin or metal

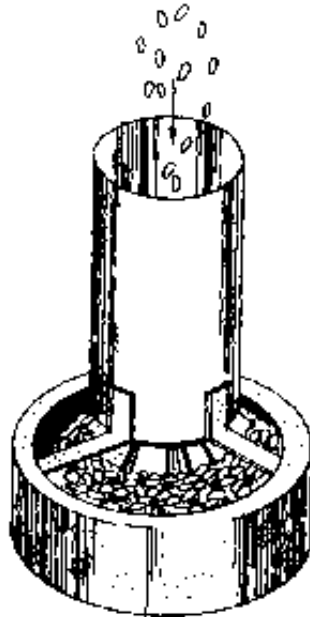

The grain in the holder will slide down as your rabbits eat

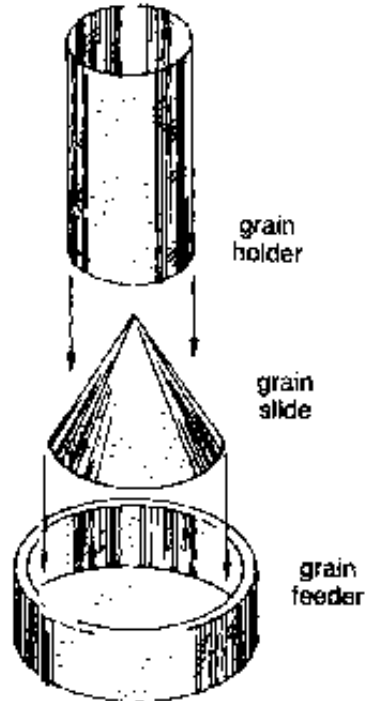

The grain holder will slide down

Two kinds of nest boxes

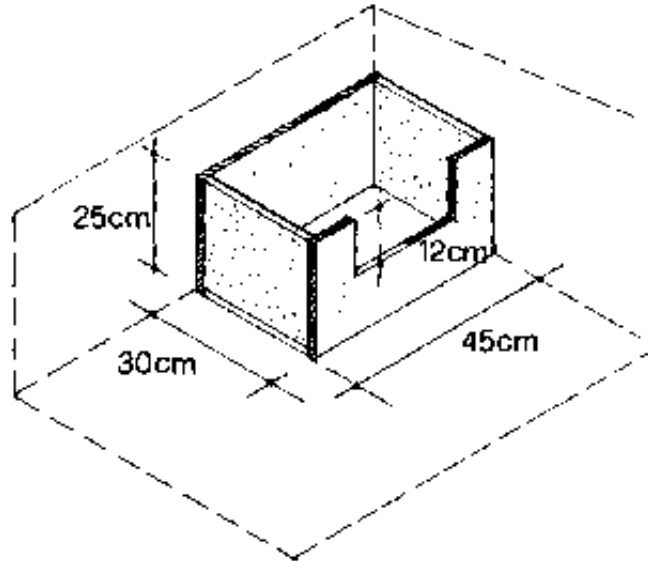

Nest box

33 build a nest box for each female rabbit using wood about 1.5 cm thick

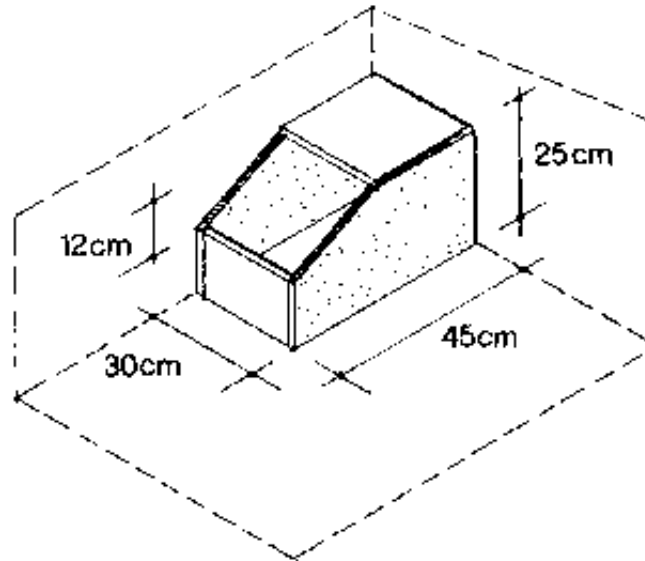

Nest box

Some other ideas for your pens

34 you can dig a pit near your pens to hold the rabbit droppings note: rabbit droppings make a good fertilizer for your garden



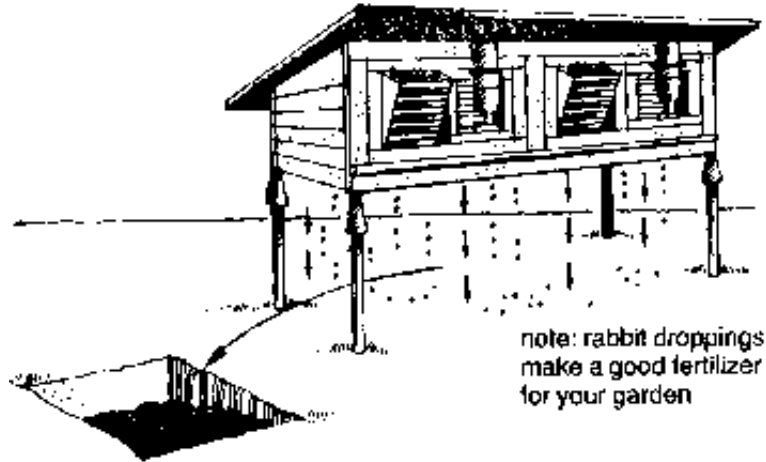

## Dig a pit

35 if there are small animals that might harm your rabbits,  
build a fence around your pens

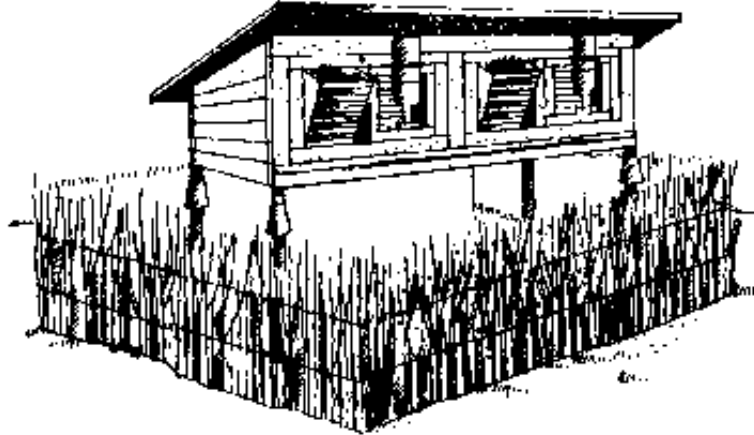

Build a fence

36 if it rains a lot where you live, build a shelter over your pens to keep your rabbits dry

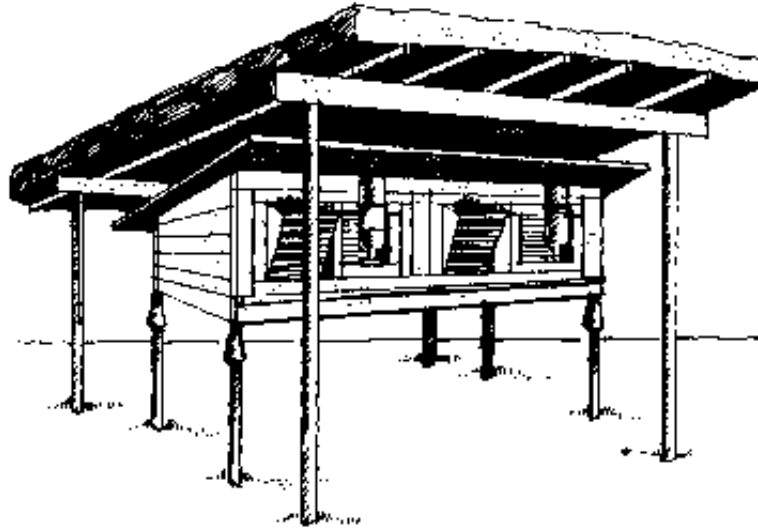

## Build a shelter

37 plastic sheets that can be rolled up and down will also help to keep your rabbits dry and to protect them from wind

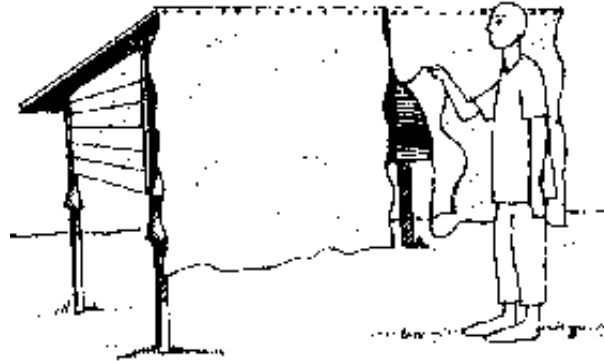

Put plastic sheets



[Home](#) > [ar](#).[cn](#).[de](#).[en](#).[es](#).[fr](#).[id](#).[it](#).[ph](#).[po](#).[ru](#).[sw](#)





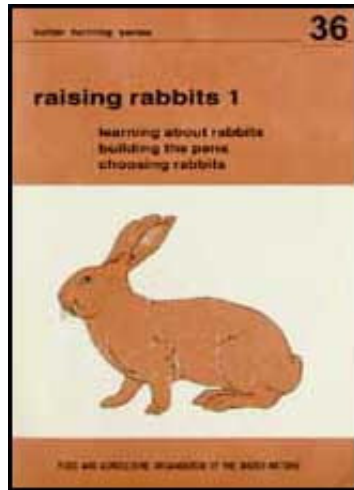

Better Farming Series 36 - Raising Rabbits 1: Learning about Rabbits; Building the Pens; Choosing Rabbits (FAO, 1988, 56 p.)





 The rabbits  
(introduction...)

-  Choosing good rabbits
-  How to handle your rabbits
-  Bringing your rabbits home
-  Preparing the pens and putting in the rabbits

## **Better Farming Series 36 - Raising Rabbits 1: Learning about Rabbits; Building the Pens; Choosing Rabbits (FAO, 1988, 56 p.)**

### **The rabbits**

81. Now it is time to buy your full- grown rabbits. You will have to learn how to choose healthy rabbits.

82. Let us begin by learning the parts of a rabbit. This will help you when you choose yours.

83. Below is a drawing of a rabbit. Look at it carefully and learn the name of each part.

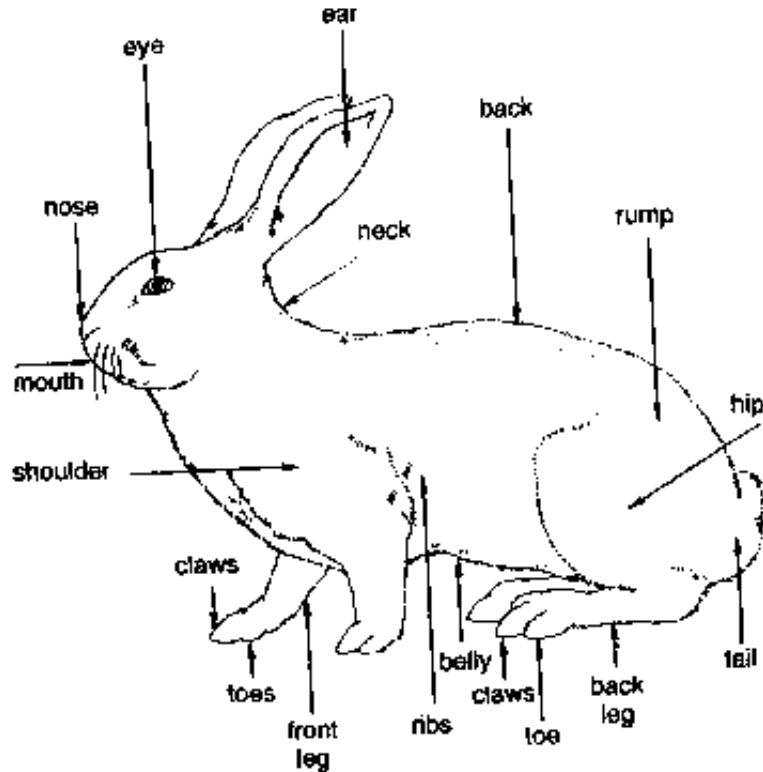

Rabbit

## Choosing good rabbits

84. It is best to buy your rabbits from a place where you can go to see them before you buy them.

85. This way you can be sure that they have been kept clean, that all the rabbits are healthy and that they have been well cared for.

86. Perhaps you can visit a nearby farmer who raises his own rabbits. There may even be a big rabbit farm near where you live.



A nearby farmer





A big rabbit farm

87. Try to find out as much as you can about the rabbits that you may buy. Here are some things that you should look for when you are choosing your rabbits.

88. Look carefully at each rabbit to see that it is active and moves well.

89. Never buy a rabbit that moves slowly or looks dull and sleepy.



A rabbit which looks dull and sleepy

90. Look to see that each rabbit has bright eyes, a dry nose and clean ears and feet.

91. Never buy a rabbit with a runny nose, or with sores in its ears or on its feet.



## A rabbit with runny nose, sores in ears and feet

92. Look at its fur. The fur of a healthy rabbit is smooth and clean.

93. Never buy a rabbit with fur that is rough or dirty or grows in patches.

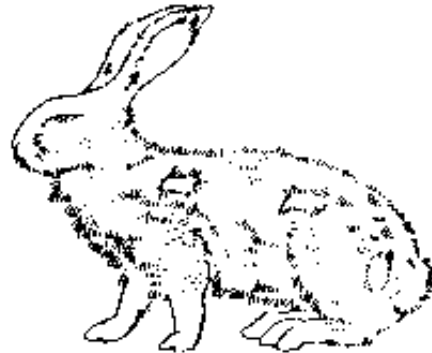

A which is rabbit rough, dirty and grows in patches

94. Look at its teeth. The front grinding teeth of a rabbit should be in line.

95. Never buy a rabbit If the grinding teeth are crooked or out of line. Teeth that are out of line grow and grow until the rabbit cannot eat.



Rabbit with grinding teeth

96. Try to get rabbits from females that have five or six babies at a time.



Female with babies

97. Try to get rabbits that grew well and were healthy when they were young and that weighed 1 1/2 to 2 kilograms when they were three to four months old.

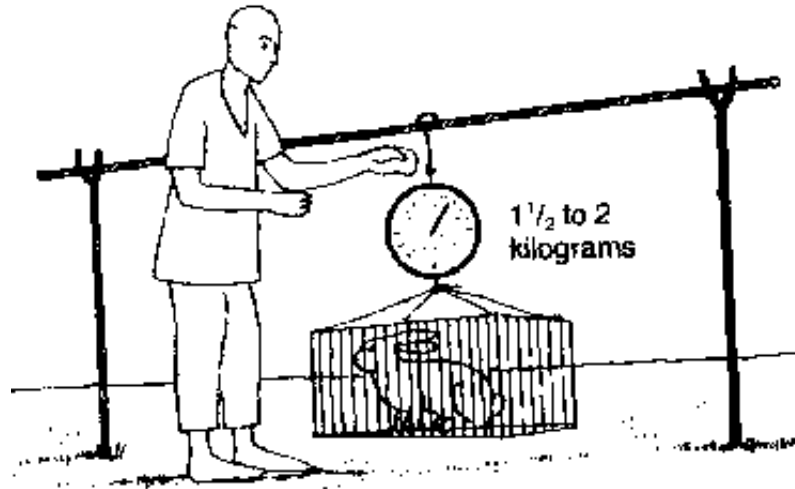

Weigh the rabbit

98. Rabbits that come from big families, that grow well and weigh a lot when they are young are more likely to have big families and big, healthy baby rabbits.

99. When you buy your rabbits, make sure that your female and your male rabbits are not brothers and sisters.

100. The female rabbits that you choose should have eight teats so that they can feed eight babies.

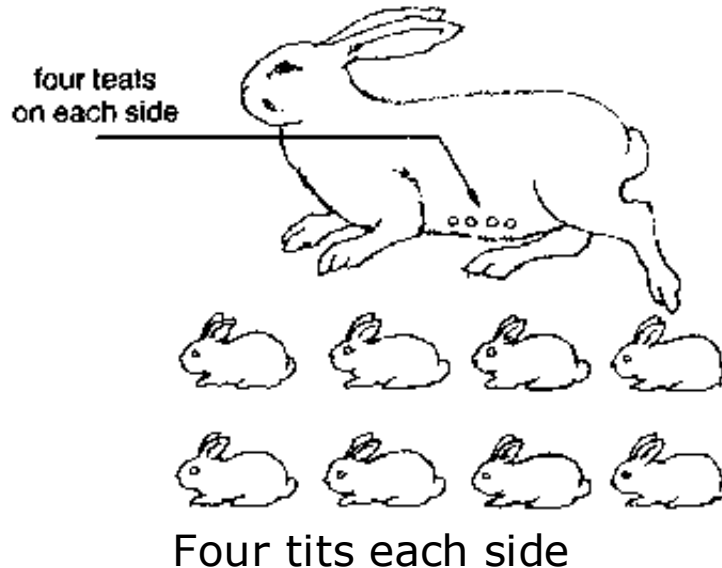

101. With most kinds of rabbits, females are ready to mate when they are 4 to 4 1/2 months old. Male rabbits are ready a little later, when they are 5 to 5 1/2 months old.

102. So, when you first begin, try to get rabbits that are old enough to mate, so that you can begin to raise your own baby rabbits as soon as you can.

103. When you have decided what rabbits to buy, find out what kinds of food they have been eating.

104. This will help you to know what to feed them when you get them home. You may even be able to take home some of this food to feed them for the first few days.

## **How to handle your rabbits**

105. Rabbits must be handled with great care in order not to hurt them.

106. When you pick up a rabbit hold it firmly but gently.

107. Make no sudden movements or you may frighten the



rabbit and it will begin to struggle or scratch you.

108. Remember, never pick up a rabbit by the legs or the ears or you may hurt It.

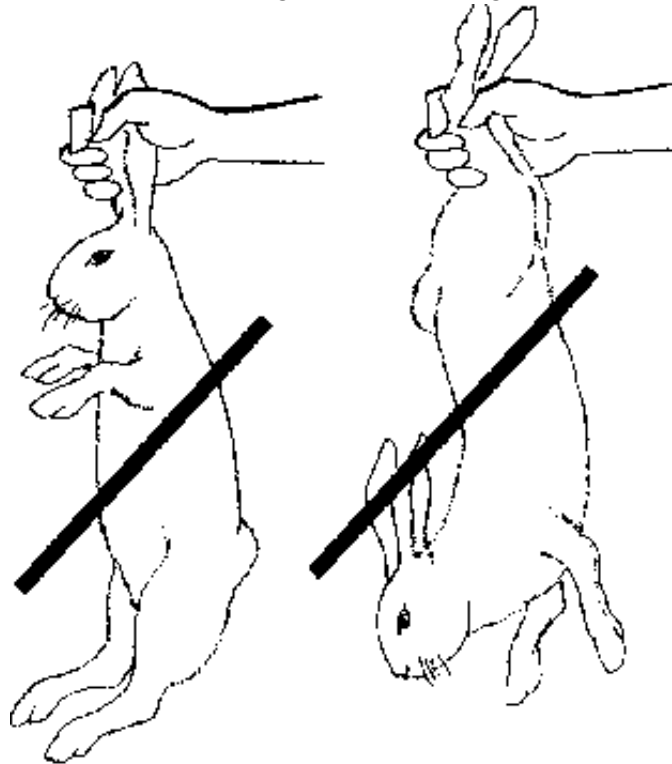

Never pick up a rabbit by its legs or ears

109. Now let us learn the right way to pick up rabbits of

different sizes and how to carry them.

Full- grown rabbits, small rabbits and heavy rabbits

110. When a rabbit is full- grown the skin over the shoulders at the back of the neck is very loose.

111. Gently grasp this loose skin with one hand to hold the rabbit and put the other hand under the rabbit to pick it up.

112. When you lift the rabbit, the hand under the animal should carry nearly all of the weight.

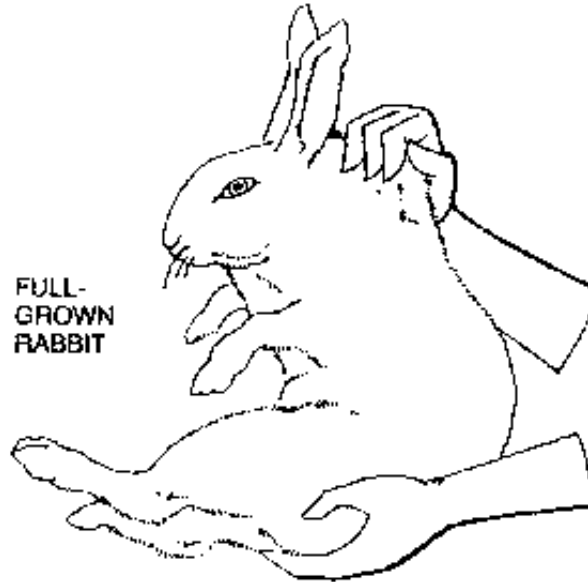

Full- grown rabbit

113. A small rabbit can be lifted and carried by holding it firmly between the hips and the ribs with the head hanging down.



Small rabbit

114. With a heavy rabbit, gently grasp the loose skin at the back of the neck with one hand and put the head of the rabbit behind the elbow of the other arm.

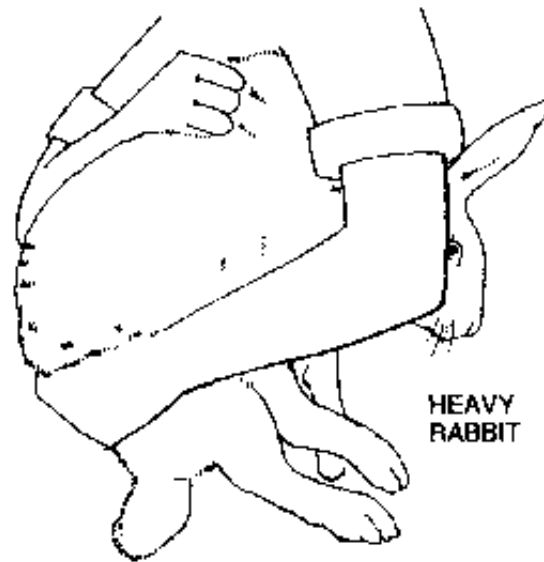

Heavy rabbit

115. Hold the heavy rabbit firmly against your side with the lower part of this arm and put the other arm under the rabbit.

## **Bringing your rabbits home**

116. When you bring your rabbits home you will have to be

very careful not to frighten them or they may get sick or die. So, move them quietly and gently.

117. Do not give any food to rabbits the night before you move them. It is not good to move a rabbit when its stomach is full. However, if the trip is long they should be given water from time to time.

118. It is best to move each rabbit in a separate container such as a crate or a basket with a lid that can be closed. However, the containers you use should let in plenty of fresh air during the trip.

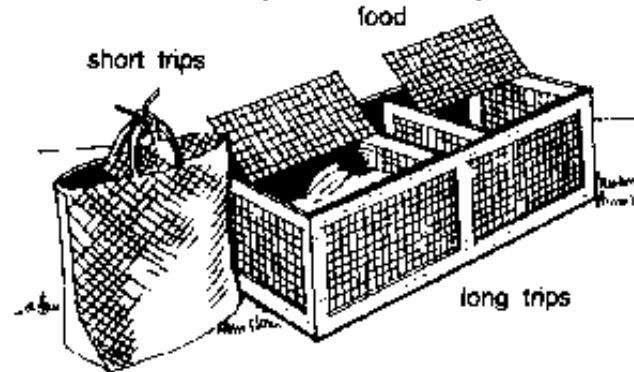

Take everything needed

119. If the weather is hot, move your rabbits early in the morning. If the weather is cooler, move them in the evening.

120. When you reach home, put the containers down gently near the pens. Let the rabbits rest and become calm while you prepare their pens.



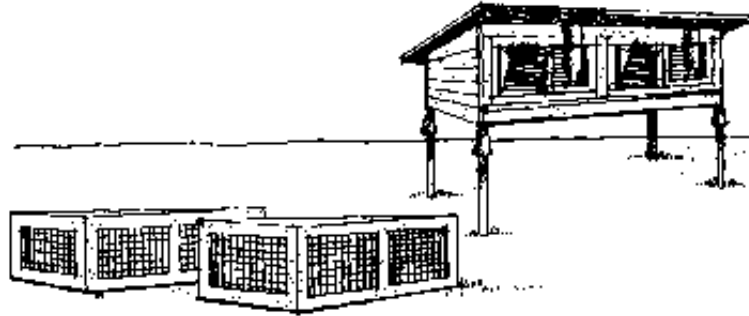

Let rabbits rest

## **Preparing the pens and putting in the rabbits**

121. Put fresh food and water in the pens. This will help your rabbits to feel at home and to settle down more quickly.



Put fresh food and water in pens

122. If you were able to bring home some of the food that they were used to eating (see Item 104 in this booklet), use that.

123. If you were not able to bring home some of the food that they were used to eating, try to give them something that is nearly the same.

124. When the pens are ready, lift the rabbits carefully out of their containers and put them gently in their pens.

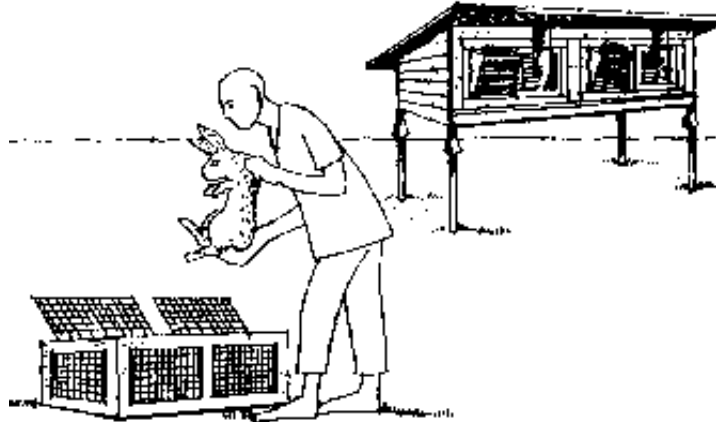

Lift the rabbits carefully

125. You have already been told that it is best to have the same person take care of the rabbits all of the time.

126. So, this person should put the rabbits in their pens and take care of them from now on.

127. Now, let your rabbits settle down. Stay away from them as much as you can until they become used to the pen.

128. Do not bring people to see them. Do not let your children play near the rabbit pens. Do not let dogs or cats or other animals near them.

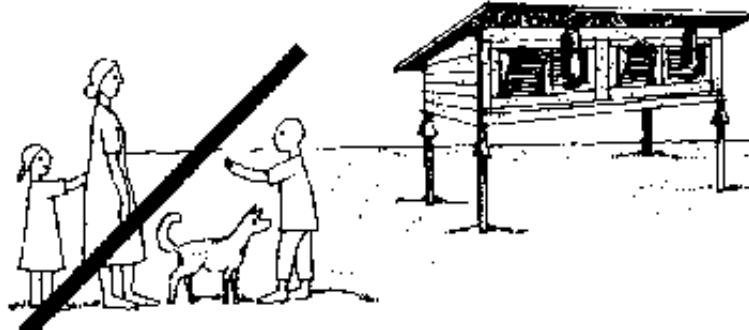

Do not let the children play near the pens

129. In Booklet No. 37, Raising rabbits: part 2, you will learn

- what to feed your rabbits, when to feed them and how much to give them
- how to mate full- grown rabbits and raise your own baby rabbits

- how to take care of your rabbits
- when and how to use or sell rabbits.

130. You will be told some other things that you can do to raise rabbits better in the section on Further improvement.

