

[Home](#) > [ar](#).[cn](#).[de](#).[en](#).[es](#).[fr](#).[id](#).[it](#).[ph](#).[po](#).[ru](#).[sw](#)

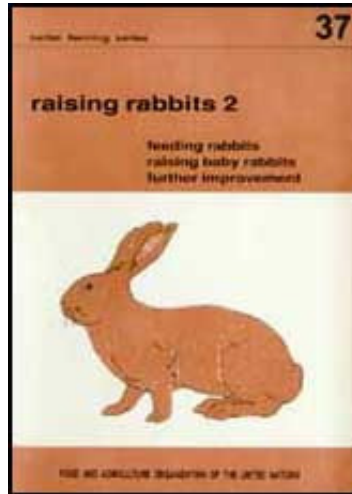

Better Farming Series 37 - Raising Rabbits 2: Feeding Rabbits; Raising Baby Rabbits; Further Improvement (FAO, 1988, 49 p.)



(introduction...)



Preface



Feeding your rabbits



(introduction...)



What can you feed your rabbits?









When to feed your rabbits and how much to feed them



Some other things that you should know about feeding your rabbits

- Raising your own baby rabbits
 - 📄 Mating
 - 📄 Helping rabbits to mate
 - 📄 The baby rabbits
 - 📄 When the baby rabbits are born
 - 📄 Raising young rabbits
 - 📄 How to tell the difference between female and male rabbits
 - 📄 When should you mate female rabbits again?
 - 📄 When to replace your full- grown female rabbits
 - 📄 When to replace your full- grown male rabbit
- Taking care of your rabbits
 - 📄 The pens
 - 📄

-  ~~Feed and water~~
The rabbits
-  Eating or selling your rabbits
-  Further improvement
 -  Raising more rabbits
 -  Building better pens
 -  Taking better care of your rabbits



[Home](#) "" "" "" "" "" "" "" "" > [ar](#).[cn](#).[de](#).[en](#).[es](#).[fr](#).[id](#).[it](#).[ph](#).[po](#).[ru](#).[sw](#)

 Better Farming Series 37 - Raising Rabbits 2: Feeding Rabbits; Raising Baby Rabbits; Further Improvement (FAO, 1988, 49 p.)

  *(introduction...)*

 Preface



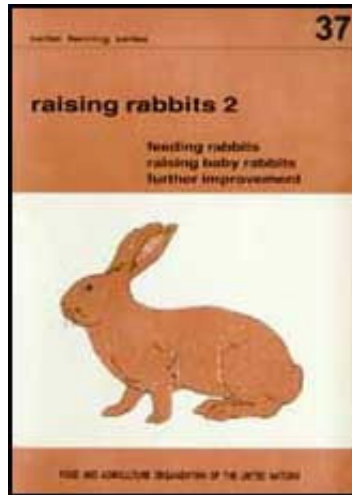

- Feeding your rabbits
- Raising your own baby rabbits
- Taking care of your rabbits
- Eating or selling your rabbits
- Further improvement

FOOD AND AGRICULTURE ORGANIZATION OF THE UNITED
NATIONS
Rome 1988

P-69

ISBN 92-5-102584-3

© FAO 1988



[Home](#) > [ar](#).[cn](#).[de](#).[en](#).[es](#).[fr](#).[id](#).[it](#).[ph](#).[po](#).[ru](#).[sw](#)

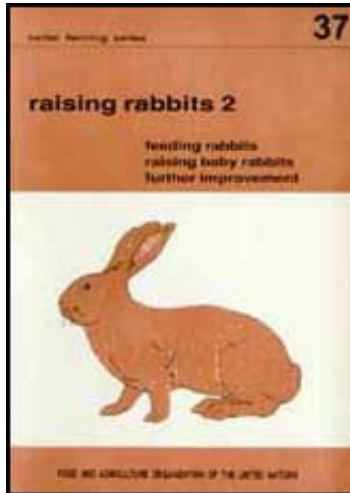

 Better Farming Series 37 - Raising Rabbits 2: Feeding Rabbits; Raising Baby Rabbits; Further Improvement (FAO, 1988, 49 p.)

 *(introduction...)*

  Preface

Feeding your rabbits

Raising your own baby rabbits

Taking care of your rabbits

 Eating or selling your rabbits

Further improvement

Preface

The first 26 titles in FAO's Better Farming Series were based on the Cours d'apprentissage agricole prepared in Cte d'Ivoire by the Institut africain de dveloppement conomique et social for use by extension workers. Later titles, beginning with No. 27, have been prepared by FAO for use in agricultural development at the farm and family level. The approach has deliberately been a general one, the intention being to provide prototype outlines to be modified or expanded in each area according to local conditions of agriculture and specific training needs.

Many of the booklets deal with specific crops and techniques, while others are intended to give farmers more general information that can help them to understand why they do what they do, so that they will be able to do it better.

Adaptations of the series, or of individual volumes in it, have

been published in Amharic, Arabic, Bengali, Creole, Hindi, Igala, Indonesian, Kiswahili, Malagasy, SiSwati, Thai and Turkish.

Requests for permission to translate and adapt this manual are welcomed. Such translation work may, in specific cases, be supported by FAO. Requests should be addressed to the Director, Publications Division, Food and Agriculture Organization of the United Nations, Via delle Terme di Caracalla, 00100 Rome, Italy.



[Home](#) > [ar](#).[cn](#).[de](#).[en](#).[es](#).[fr](#).[id](#).[it](#).[ph](#).[po](#).[ru](#).[sw](#)



Better Farming Series 37 - Raising Rabbits 2: Feeding Rabbits; Raising Baby Rabbits; Further Improvement

(FAO, 1988, 49 p.)

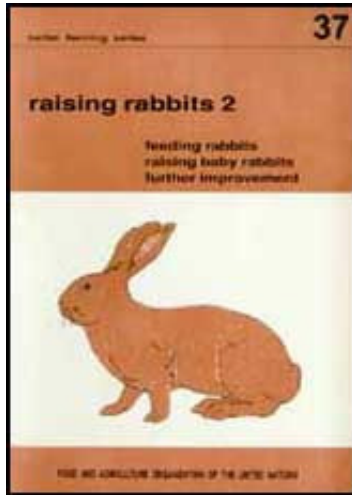

➔ □ Feeding your rabbits

📄 *(introduction...)*

📄 What can you feed your rabbits?

📄 When to feed your rabbits and how much to feed them

📄 Some other things that you should know about feeding your rabbits

Better Farming Series 37 - Raising Rabbits 2: Feeding Rabbits; Raising Baby Rabbits; Further Improvement (FAO, 1988, 49 p.)

Feeding your rabbits

131. Rabbits like to eat green plants, and fresh plants are

best. However, during the times of year when there are few fresh plants, you can feed your rabbits dry plants.

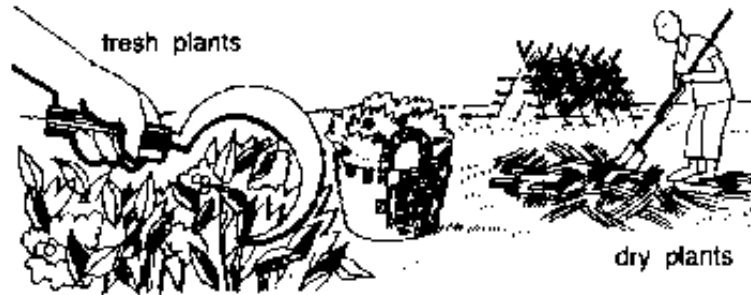

Fresh pens; dry pens

132. Remember, if you want your rabbits to grow well and fast, you will have to feed them some rich foods as well.



Rich foods

133. When you were looking for rabbits to buy, you saw what they were being fed. So, you should have a good idea of the kinds of food that they eat.

What can you feed your rabbits?

134. Here is a list of foods that rabbits like to eat.

Fresh plants

- nearly all green plants, and especially rich plants such as bean plants and alfalfa
- many kinds of grass and weeds
- the outside leaves and the tops of vegetables
- lettuce, endive and chicory
- tender banana, cane and bamboo leaves
- cut- up pieces of the stalks of plants such as maize or banana
- roots such as cassava, yams, carrots, beets and turnips

Dry plants

- nearly all plants dried when they are green, including grass and weeds

Rich foods

- barley, maize, wheat, oats field beans, rye, buckwheat millet

and sorghum

- cottonseed, groundnut, coconut, linseed and sesame cakes.

135. If you have some food that you think might be good, give your rabbits a little of it. If they like it, you can begin to give it to them.

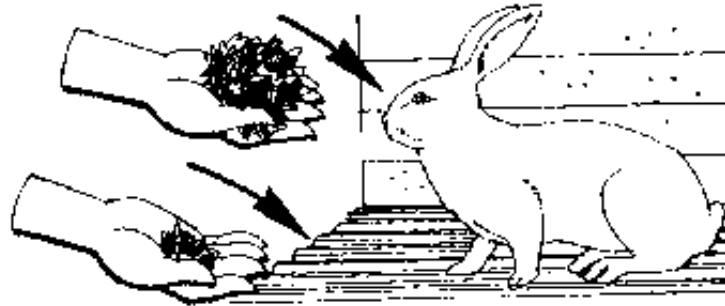

Give little of the new food

136. However, a sudden change of food may make your rabbits sick. So, when you give them something new, give it to them little by little for a week or more until they become used

to it.

Note

The leaves of the potato or the tomato plant may make your rabbits sick.



Potato plant; tomato plant

When to feed your rabbits and how much to feed them

137. You have already learned that rabbits eat at night as well as during the day. So, you must be sure that they have enough to eat all of the time.

138. The best time to feed rabbits is once early in the morning and once in the evening, before it is dark.

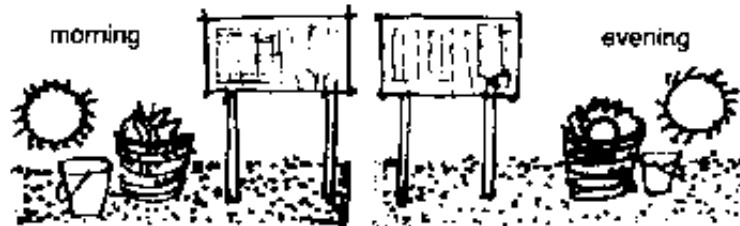

Morning; evening

139. Each time you feed your rabbits, put fresh or dry plant materials in the plant feeder, and put some of the rich food that you are using, such as crushed maize, in the grain feeder.

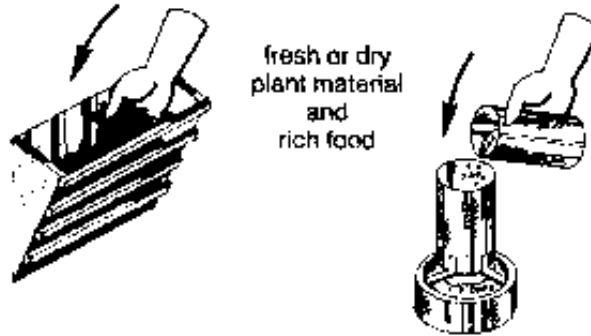

Fresh or dry material and food

140. If you are feeding your rabbits any larger foods, such as sections of banana stalk or whole carrots, beets or yams, you can put them on the floor of the pen.

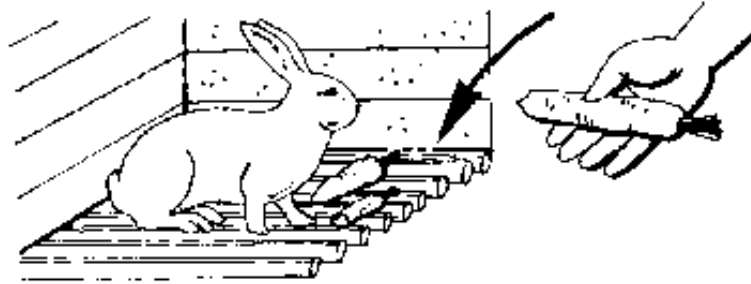

Put food on the floor of the pen

141. Rabbits need different amounts of food at different times in their lives.

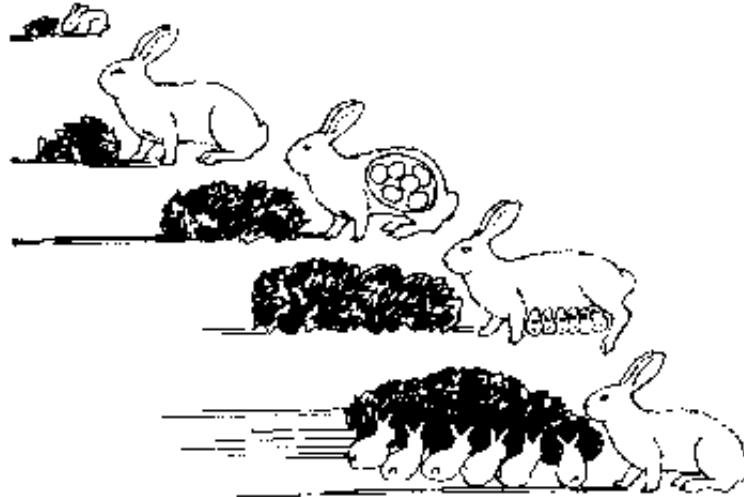

Differen amount of food at different times in rabbit's life

142. The following items will help you learn how much to feed your rabbits.

143. Female rabbits, when they are not having babies, and male rabbits, when they are not mating, need much less food.

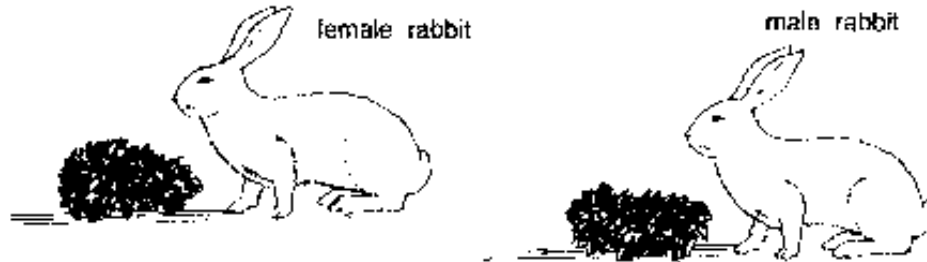

Less food needed when not mating

144. They must be given enough food to keep them strong and healthy but not so much that they get fat.

145. Female rabbits that are fat do not have babies easily. Male rabbits that are fat are lazy and do not want to mate.

146. Female rabbits that are going to have babies need more food, and after their babies are born they need much more food.

147. Once you know that a female is going to have babies,

give her as much food as she can eat.



Give pregnant female as much food as she can eat

148. She will have to eat for herself and for the babies inside her. After the babies are born, she will have to be able to produce a lot of rich milk for them.

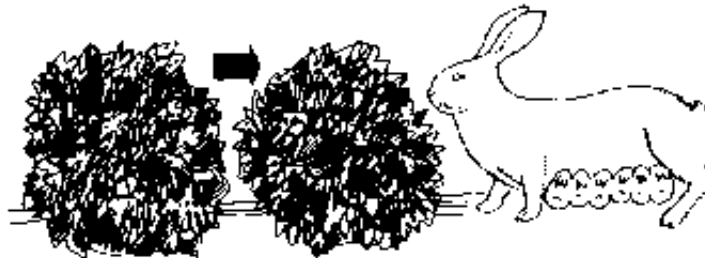

She has to produce a lot of milk

149. So, watch your rabbits carefully to see how much they need to eat and how they grow. You will have to learn by your own experience just how much to give them.

150. If you see that your rabbits do not eat all of their food, give them a little less.

151. If you see that your rabbits eat all of their food, give them a little more unless they are too fat.

152. You will learn what baby rabbits eat in the next section in this booklet, Raising your own baby rabbits.

Some other things that you should know about feeding your rabbits

153. You must be careful that the food you feed your rabbits is

very clean or it may make them sick.

154. Never gather green food from places made dirty by other animals.



Never gather green food from dirty places

155. Never give your rabbits food that is mouldy or dusty. Even food that was once clean, such as dry hay, grass or grain, can become mouldy or dusty after only a very short time.



Never give your rabbits mouldy or dusty food

156. You must also be careful not to feed your rabbits food that is sour or spoiled because it may make them sick.

157. Never give your rabbits fresh green food that has been standing in piles. Fresh green food left standing becomes spoiled very quickly.



Never give your rabbits fresh green food that has been standing in piles

158. If you are going to keep green food even for a very few hours after it has been cut, spread it out and turn it over from time to time so that it will not become warm, sour or spoiled.

159. If you build a rack like the one shown below, you can dry green food completely so that you can use it later when you cannot find fresh food.



A rack

Note

When the green food is dry, you can tie it in bundles and hang it in a place where it will stay dry and clean.



[Home](#) > [ar](#).[cn](#).[de](#).[en](#).[es](#).[fr](#).[id](#).[it](#).[ph](#).[po](#).[ru](#).[sw](#)



Better Farming Series 37 - Raising Rabbits 2: Feeding Rabbits; Raising Baby Rabbits; Further Improvement

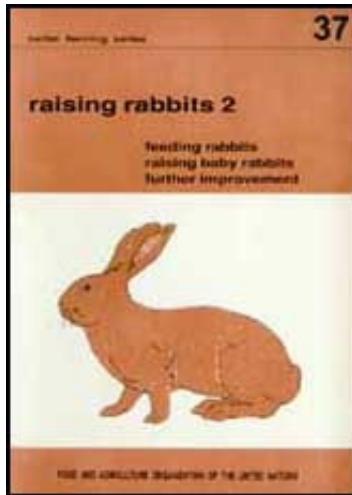

(FAO, 1988, 49 p.)

➔ □ Raising your own baby rabbits

- 📄 Mating
- 📄 Helping rabbits to mate
- 📄 The baby rabbits
- 📄 When the baby rabbits are born
- 📄 Raising young rabbits
- 📄 How to tell the difference between female and male rabbits
- 📄 When should you mate female rabbits again?
- 📄 When to replace your full- grown female rabbits
- 📄 When to replace your full- grown male rabbit

Better Farming Series 37 - Raising Rabbits 2: Feeding Rabbits; Raising Baby Rabbits; Further Improvement (FAO, 1988, 49 p.)

Raising your own baby rabbits

Mating

160. Remember that female rabbits are ready to be mated when they are 4 to 4 1/2 months old, and male rabbits when they are 5 to 5 1/2 months old.

161. So, once your rabbits are old enough (and if they are not sick), you can begin to mate them for the first time.

162. The best time for mating is early in the morning, or in the evening when it is cool.

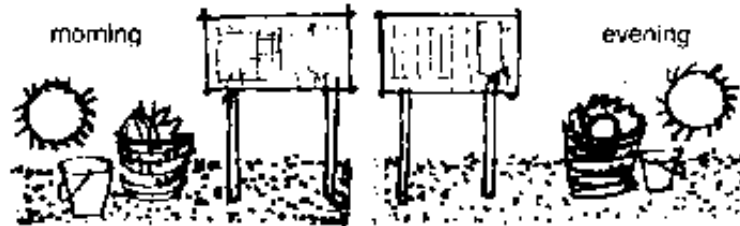

The best time for mating is in the morning or evening

163. When you mate your rabbits, always put the female into the pen of the male.

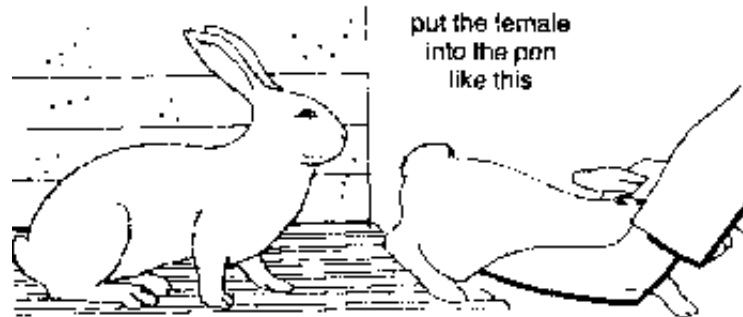

Put the female into the pen of the male

164. Watch to see what happens. Usually they will mate quickly. If the male mounts the female and in a short time falls off to one side, mating has taken place.



Rabbits mating

165. As soon as this has happened, put the female back in her pen and write down the date of mating. This way you will know when to expect the baby rabbits to be born (see Item 171 in this booklet).

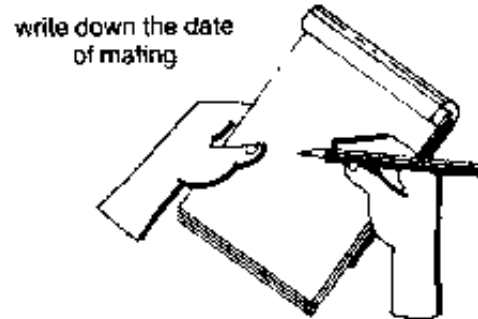

Write down the date of mating

166. If the rabbits do not mate after about five minutes, put the female back in her cage and try again the next day.

Helping rabbits to mate

167. Sometimes when a female rabbit is put into a pen with a male rabbit she will hide in the corner and the male rabbit will not be able to mount her.

168. If this happens, you can help them to mate. To do this,

hold the female by the neck with one hand.

169. Then, put the other hand under the female with one finger on each side of her tail and push gently backwards.

170. This will make the female lift her tail so that the male can mount her. The drawings below will show you how to hold a female rabbit for mating.

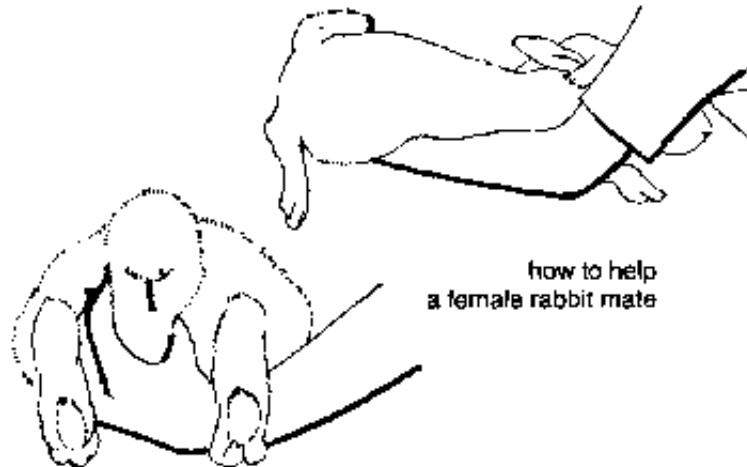

How to help a female rabbit mate

The baby rabbits

171. Baby rabbits are usually born about one month after mating. However, they may be born a few days earlier or a few days later.

172. About five or six days before you expect the babies to be born, put one of the nest boxes that you have built (see page 41 in the last booklet) in the pen with the female.

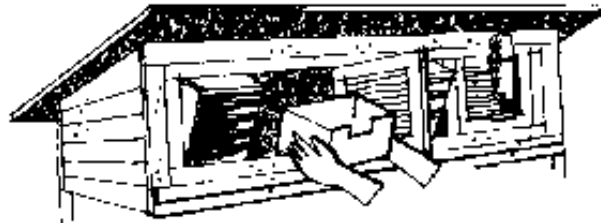

Put one of the nest boxes in the pen with the female

173. Cover the bottom of the box with sawdust or wood chips. This will help to keep the box dry after the baby rabbits are born. Put a little dry grass or hay in the box.

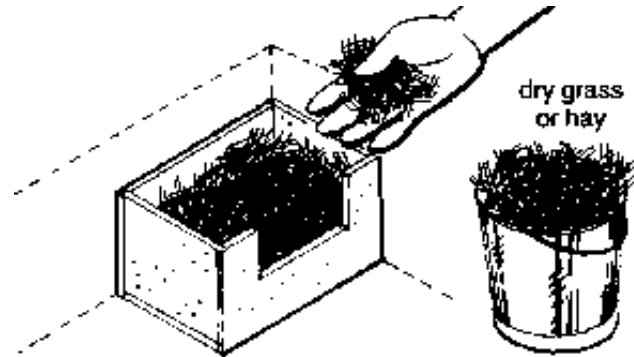

Dry grass or hey

174. The female rabbit will then make a nest in the box to protect the baby rabbits, using some of her fur mixed with the dry grass or hay.

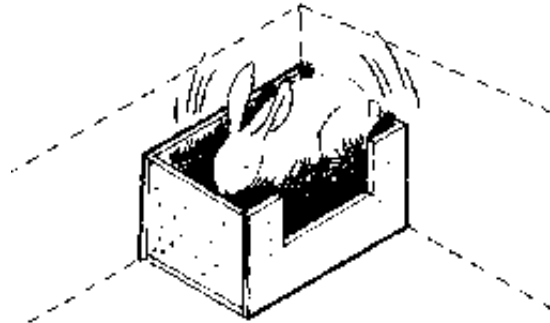

The female rabbit will make a nest

175. The nest box is very important because baby rabbits are weak and helpless when they are born. Baby rabbits have no fur, they cannot see and they cannot walk. So, they must be well protected.



The baby rabbits in the nest

176. Soon after the female rabbit has finished the nest, you can expect the baby rabbits to be born.

177. Stay away from the pen as much as you can during this time and do not bother the female. This is especially true while she is having the babies.

When the baby rabbits are born

178. After the baby rabbits are born, look at them carefully to see that they are all well.

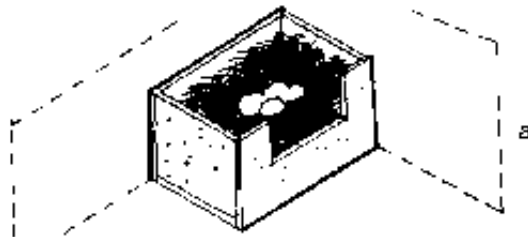

Look at the babies as soon as they are born

179. Here are some things that you should look for. You should see

- if they are lying close together or far apart
- if they are warm and well protected in the nest
- if they are alive and well
- how many baby rabbits there are.

180. One very important thing that you should always remember is never touch baby rabbits unless you must, and if you must, make sure your hands are clean.



Wash your hands

181. All of the baby rabbits should be lying close together. If they are lying far apart carefully move them together.

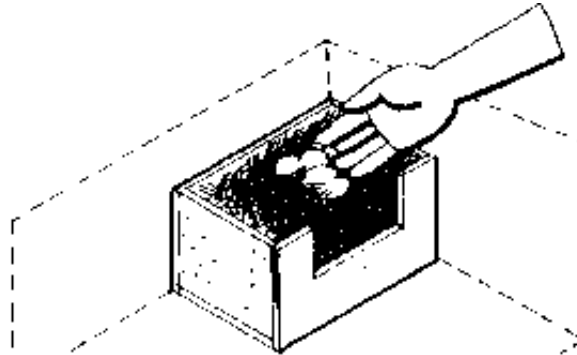

Carefully move them together

182. A female rabbit gives milk to her babies only once a day. If the babies are not close together, she may not feed them all.

183. All of the baby rabbits should be warm and well covered in their nest. If they are not, put the fur and hay in the nest

all around them.

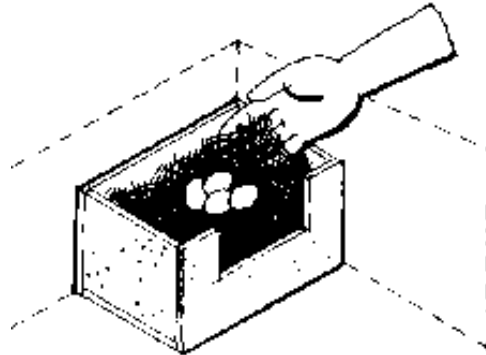

Put fur and hay around them

184. If any of the baby rabbits are dead or deformed, take them away and destroy them.



Take away dead or deformed babies

185. If there are too many babies for the female to feed, take some of them away. A female rabbit with eight teats can feed only eight babies.

186. You can move baby rabbits from one female to another one that also has babies. If you have another female rabbit with too few babies, you can give some to her to feed.

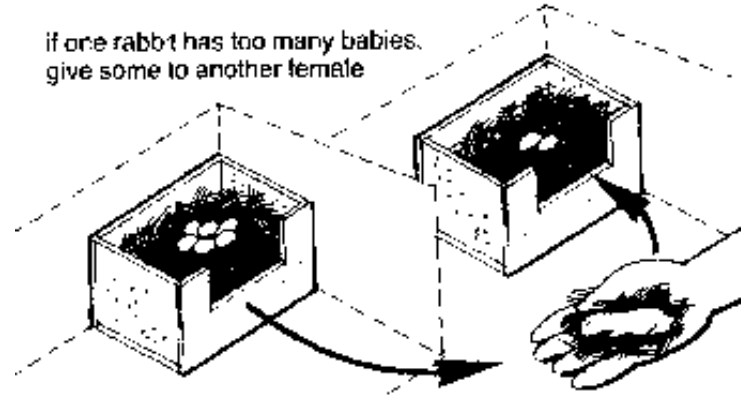

If one rabbit female has too many babies, give some to another

187. However, the baby rabbits that you give to another female should be no more than two days younger or two days older than her own babies.

188. Gently rub the baby rabbits you are going to move with some of the grass or hay of the new nest.



Gently rub the babies with grass or hay from the new nest

189. This will give them the same smell as the new nest so that the new female rabbit will be more likely to accept the new babies as her own.

190. Sometimes female rabbits will kill their babies and sometimes they will not feed them. This can happen if a female rabbit does not have enough milk.



Sometimes female rabbit kills their babies

191. It can also happen the first time that a female rabbit has babies because she does not know how to take care of them.

192. If she kills her babies or will not feed them the next time she is mated, do not use her for mating again. Replace her with a new female.

193. Look at your baby rabbits every day to make sure that they are all well. Take away any babies that die.

194. You have already been told that female rabbits with babies need a lot of food. They also need a lot of water to make milk for the babies.

195. So, be very careful with female rabbits when they are having babies. Be sure that they can get as much food and water as they want.



Make sure that they can get as much food and water as they want

196. At first, your new little rabbits will sleep most of the time and move very little. They will take milk once a day.



Baby rabbit sleeping

197. When they are about two weeks old their fur will begin to grow they will begin to see and they will start to move about.



At two weeks they will start to move

198. At about three weeks, the little rabbits will come out of their nest box and they will begin to eat food in addition to the milk they drink.



At three weeks they will begin to eat

199. From this point on, the little rabbits will eat more and more food. So, be very sure that there is enough food for all the rabbits to eat.

200. By the time they are six weeks old, the little rabbits will no longer take milk and they will eat all of the foods that full-grown rabbits eat.



At six weeks they will all their parents eat

201. However, you must be very careful with little rabbits. This is a very dangerous time for them. They often get sick at this age.

202. Make sure that their pen is always very clean. Make sure that the food and water is always very clean and fresh.

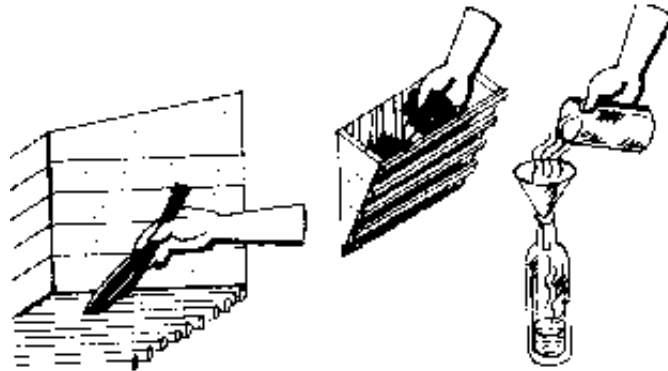

Make sure

203. Never move little rabbits of this age. Leave them with the female rabbit in the same pen. If you move them to a different pen they may get sick or lose weight.



Leave babies with the female until they are eight weeks old

204. When the rabbits are eight weeks old it is safe to move them. Then, you can take them away from the female rabbit and put them in their own pen.

Raising young rabbits

205. You can put as many as six to eight young rabbits in a pen of the size you learned to build in the last booklet.

206. However, it is best to keep all of the young rabbits from the same female rabbit together in the same pen.

207. Once they are in their own pen, you can begin to fatten them to eat or to sell. So, give them as much food as they can eat and plenty of fresh water.

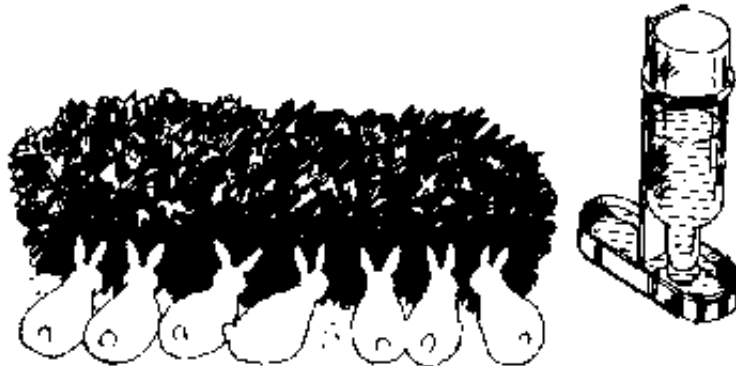

Give your young rabbits as much as they can eat and drink

208. Young rabbits are usually big enough to be eaten or to be sold when they are about three to four months old.

209. After four months of age, rabbits begin to eat a lot more food. So, you should try to eat or sell all of your rabbits by this time.

210. If you keep rabbits longer than this, the male rabbits may begin to fight. So, it is best to eat or sell the male rabbits first.

211. You will next learn how to tell the difference between female and male rabbits.

How to tell the difference between female and male rabbits

212. It is not too hard to tell the difference between female and male rabbits after they are eight weeks old.

213. The easiest way to learn is to ask someone who already knows how. If there is no one to help you, the following items

will tell you how.

214. Hold the rabbit in your arms or put it on its back on a table, as shown below.

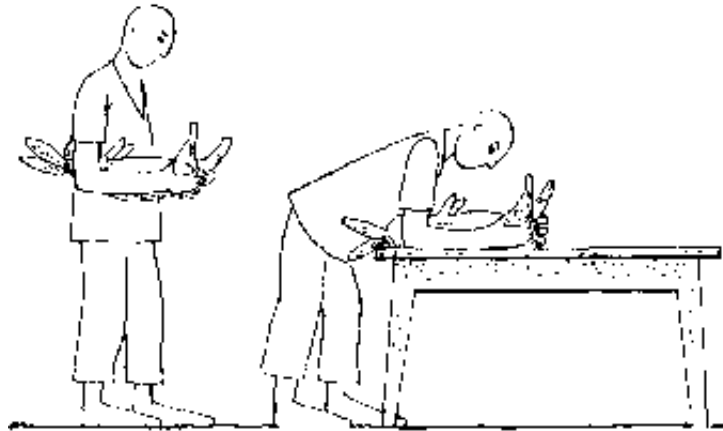

Hold the rabbit in your arms or put on its back on a table

215. Notice that there are two openings just behind the tail. The opening nearest the tail is where the rabbit droppings come out. This opening looks much the same in all rabbits.

216. However, the second opening of a female looks quite different from the second opening of a male. This is how you tell them apart.

217. Push down gently with your thumbs on each side of the openings. You will see that they are red and moist inside.

218. Look carefully at the second opening. Some rabbits have a slit and some rabbits have a circle with a small hole in the centre.

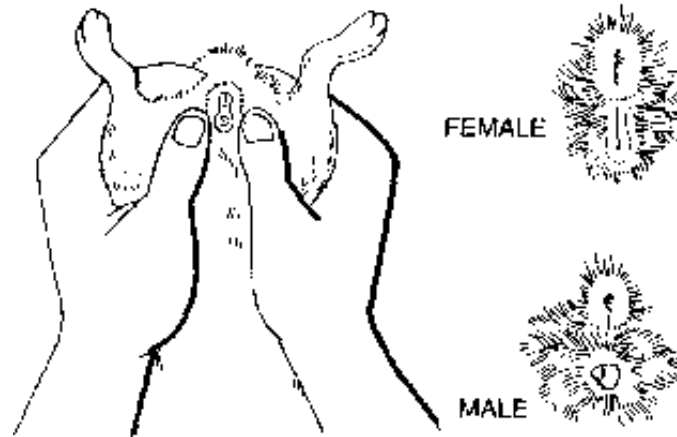

Look at the second opening

219. If you see a slit, the rabbit is a female. If you see a circle, the rabbit is a male.

When should you mate female rabbits again?

220. As you have already learned, rabbits can have babies often. Female rabbits can have babies six or seven times each year.

221. However, a female rabbit must be strong and healthy and be fed good food to produce healthy babies that many times each year.

222. When you first begin to raise your own rabbits, you should mate your females only four or five times each year (see the diagrams on pages 26 and 27).

223. After you have been raising rabbits for some time and you see that your female rabbits are strong and healthy, you may be able to mate them more often.

224. However, if you do mate your female rabbits more often, make sure that you feed them enough so that they do not lose weight.

Note

Remember, if you mate all of your female rabbits at about the

same time, all of your baby rabbits will be born at about the same time. That way you can easily move them from one female to another if you need to (see Items 186 to 189 in this booklet).

225. Babies will be born four times a year if you mate your female rabbits when their babies are eight weeks old.

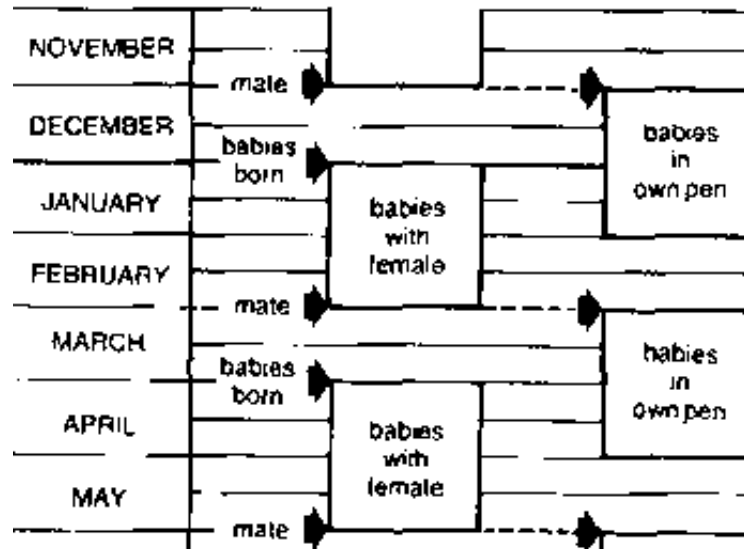

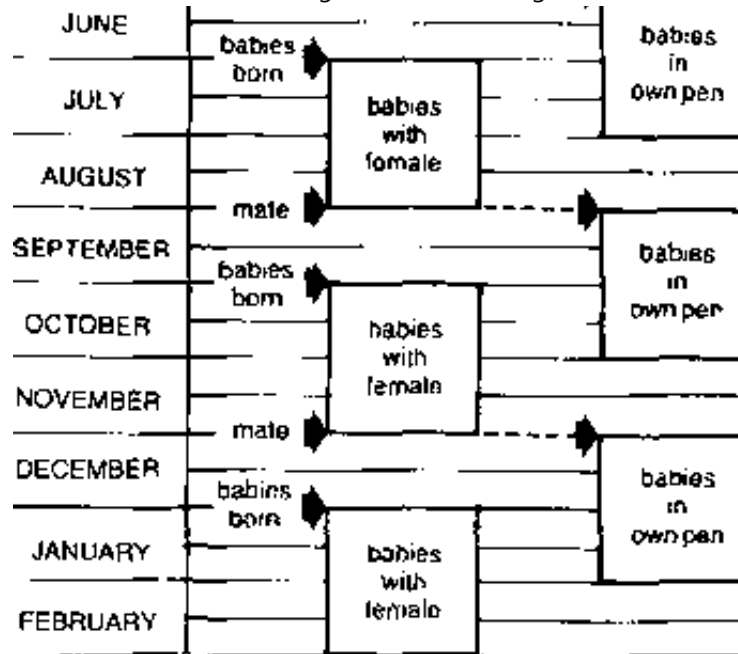

Calendar

226. Babies will be born five times a year if you mate your female rabbits when their babies are six weeks old.



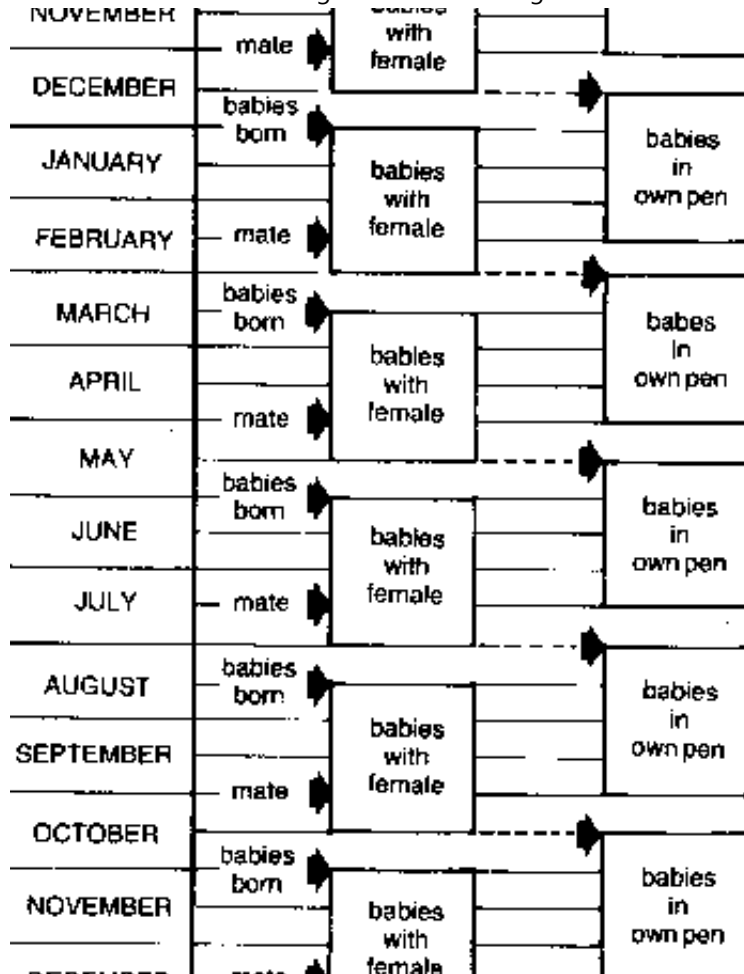

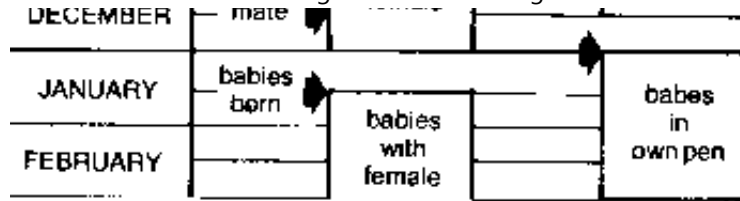

Calendar

When to replace your full- grown female rabbits

227. If any of your full- grown female rabbits become sick or do not have healthy baby rabbits, do not mate them. Replace them with new full- grown females.



Replace unhealthy females with healthy females

228. As long as your full- grown female rabbits are healthy and have healthy baby rabbits, you can continue to mate them until they are three years old.

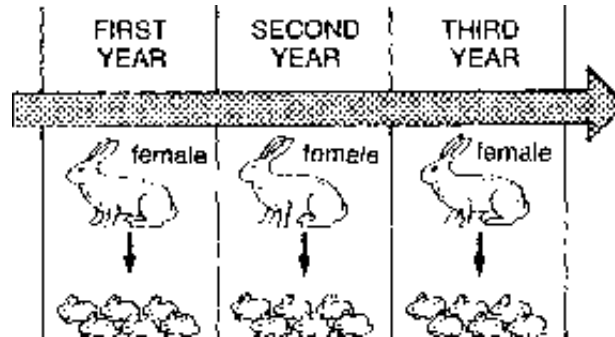

Change female rabbits after three years

229. However, after three years you should replace them with other full- grown females. You can either buy new females or you can use your own.

230. If you decide to use your own, choose one or two of your healthiest and strongest young females before you eat or sell

any of your young rabbits.

231. That way you will always have a healthy young female ready to replace one of your old females or a female that becomes sick. You can also use a young female if you decide to mate more than two female rabbits.

When to replace your full- grown male rabbit

232. Male rabbits can be used for mating until they are about three years old, and even longer if they are healthy and the females that they mate continue to have healthy babies.

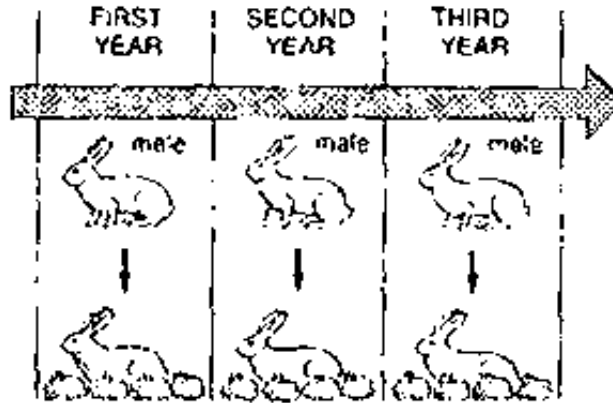

Males can be mated after three years if the babies born are healthy

233. However, you should not mate rabbits from the same family or your baby rabbits may not be strong and healthy.

234. So, after you begin to use your own females for mating, you should replace your male rabbit about once every year. That way you will be sure not to mate a father to a daughter.

235. You can either buy a new male or you may be able to

exchange your old male rabbit for a new male rabbit.

236. Perhaps you can find another farmer with rabbits who would like to exchange male rabbits from time to time. However, be very careful that your new male rabbit does not come from the same family as your old male rabbit.

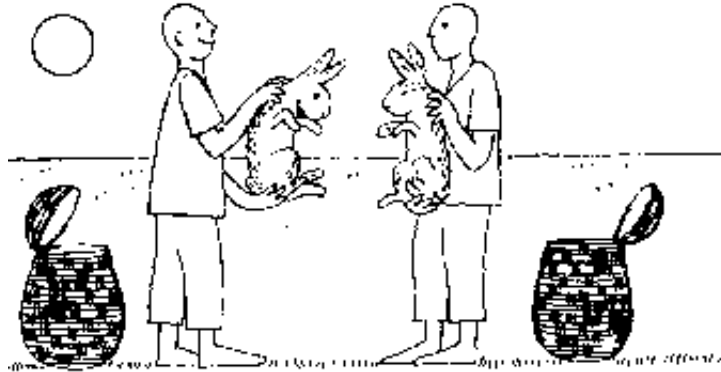

Exchange your old male for a new male

Note

Remember to choose rabbits that come from big families of five to six babies that weighed at least 1 1/2 to 2 kilograms when they were three to four months old. In addition, remember that new females should have eight teats.



[Home](#) > [ar](#).[cn](#).[de](#).[en](#).[es](#).[fr](#).[id](#).[it](#).[ph](#).[po](#).[ru](#).[sw](#)

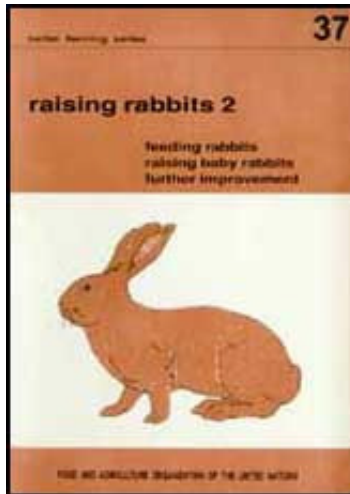

 Better Farming Series 37 - Raising Rabbits 2: Feeding Rabbits; Raising Baby Rabbits; Further Improvement (FAO, 1988, 49 p.)

➔ Taking care of your rabbits

 The pens

 Food and water

 The rabbits

Better Farming Series 37 - Raising Rabbits 2: Feeding Rabbits; Raising Baby Rabbits; Further Improvement (FAO, 1988, 49 p.)

Taking care of your rabbits

The pens

237. It is very important to keep your rabbit pens clean. Your rabbits may get sick if their pens become dirty.

238. If you built your pens like those shown in the last booklet, they will usually stay clean. However, sometimes the droppings may not fall out of the pen.

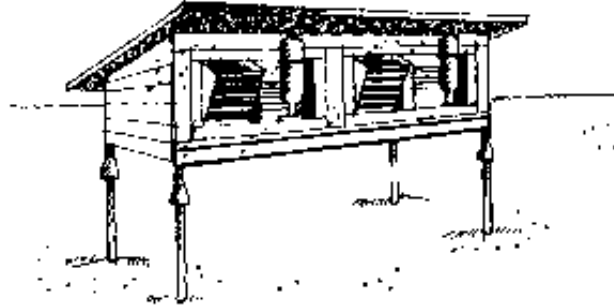

Pens

239. So, watch carefully to see that no rabbit droppings collect on the floor or in the corners of your pen. If they do, brush them out.



Brush out rabbit droppings

240. Clean the pens of your full- grown rabbits with soap and water at least twice each year and more often if they become dirty.



Clean the pens

241. When your baby rabbits are big enough and no longer need their nest boxes clean the boxes with soap and water and put them away for the next time.

242. When all of your young rabbits have been eaten or sold, clean their pens with soap and water before you put in more young rabbits.

Note

If a rabbit begins to ruin its pen by chewing the wood of the walls or the floor give it a piece of wood to chew.



Give it a piece of food to chew

Food and water

243. It is very important to feed your rabbits twice a day and

to keep their feeders and water containers clean. Your rabbits may get sick if their food or water is dirty.

244. When you give your rabbits new food, uneaten food from the last feeding may be left if the food is clean and the feeders and containers are clean.

245. But if the old food or the feeders are dirty, take away the old food and clean the feeders before you put in new food.

246. In addition, if the water or the water containers become dirty, empty out the water, clean the containers and put in new water.

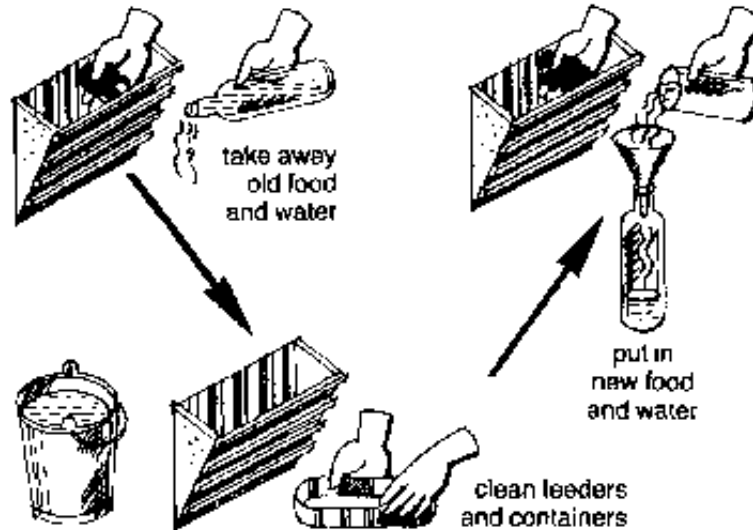

Clean containers and put in new water

The rabbits

247. Watch your rabbits carefully to see that they are not sick. A rabbit may be sick or getting sick if it

- does not eat its food

- loses weight
- dirties the fur around its tail
- sits in strange positions or cannot move about easily
- has rough, dry fur.

248. If one of your rabbits becomes sick, take it out of its pen, wash the pen with soap and water and, when the pen is dry, put the rabbit back.



Sick rabbit

249. If a rabbit becomes very sick, take it out of its pen to keep the sickness from spreading to your other rabbits. This is especially important when there are many rabbits in the same

pen.

250. If a sick rabbit dies, burn it at once to keep the sickness from spreading.

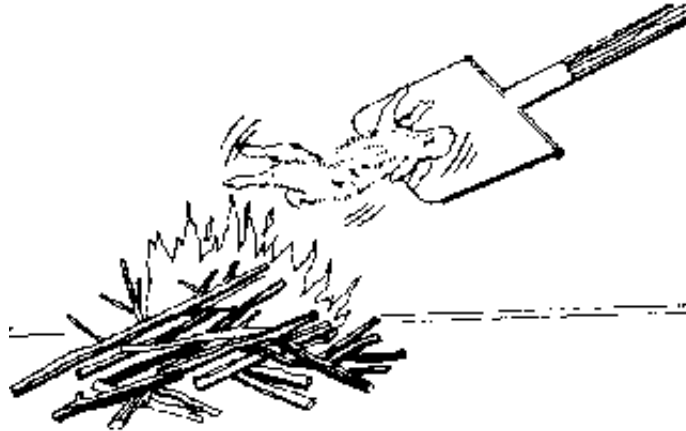

Burn the dead rabbit

251. Here are some other things that you should watch for, and what to do if your rabbits have them.

252. Sometimes rabbits have sore ears. This may be caused by very small mites under the skin inside the ear. If this happens to any of your rabbits, wash out their ears using a clean cloth and vegetable oil.

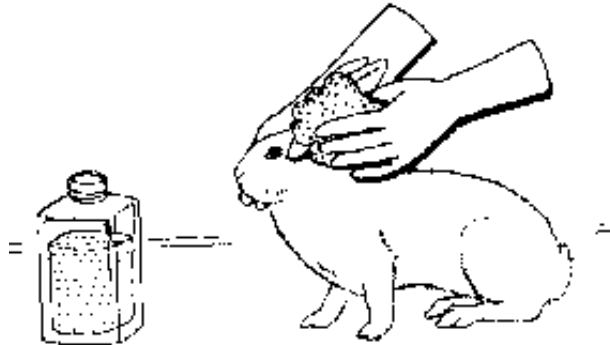

Wash out their ears

253. Sometimes rabbits have sore or runny eyes. This may be caused by flies, or they may have scratched their eyes. If this happens to any of your rabbits, wash out their eyes using a clean cloth and clean water.

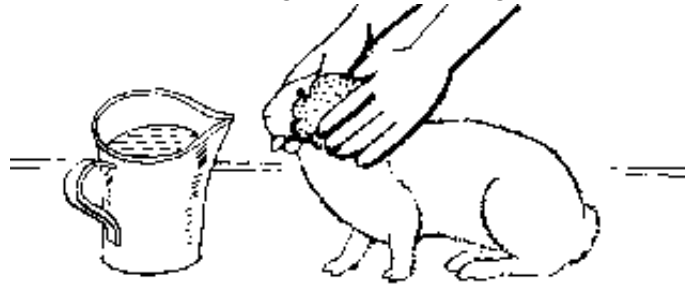

Wash out their eyes

254. If any of your rabbits sneeze or rub their nose or have a runny nose, they may have a cold. Make sure that they are dry and protected from wind and rain. Make sure that their food is clean and free from dust.

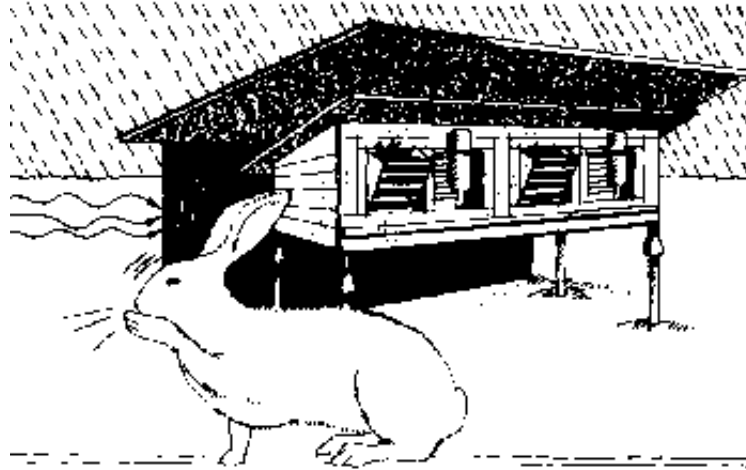

Rabbit may have a cold

255. If any of your rabbits have sore or bleeding feet, it may be caused by a rough place or a wet, dirty floor in their pen. First, smooth out rough places and clean and dry the pen. Wash their feet in warm, soapy water and rinse and dry them well. Then, rub the bottoms of their feet with vegetable oil.

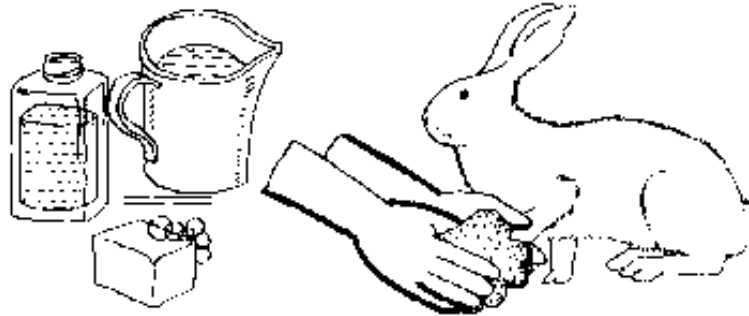

Wash their feet

256. Rabbits that live in pens often grow very long toe claws. If their claws become too long they may get caught in the pen floor and the rabbits may hurt their feet. If this happens trim the claws carefully. However, avoid the red centre of the claw.

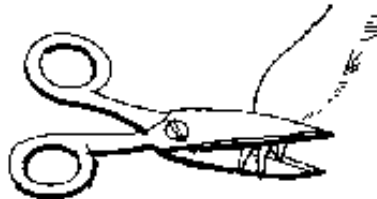

Trim the claws carefully

257. If any of your rabbits become sick and you do not know what to do or you need help with a problem, your extension agent will be able to give you good advice.



[Home](#) > [ar](#).[cn](#).[de](#).[en](#).[es](#).[fr](#).[id](#).[it](#).[ph](#).[po](#).[ru](#).[sw](#)

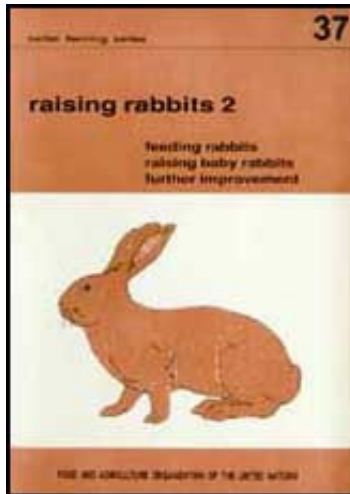

Better Farming Series 37 - Raising Rabbits 2: Feeding Rabbits; Raising Baby Rabbits; Further Improvement (FAO, 1988, 49 p.)



(*introduction...*)



Preface



Feeding your rabbits



Raising your own baby rabbits





Taking care of your rabbits

Eating or selling your rabbits



Further improvement

Eating or selling your rabbits

258. Do not give your rabbits any food to eat the night before you are going to eat them or take them to the market.

259. It is not good to kill a rabbit or move a rabbit from place to place when its stomach is full. However, during this time be sure that it has water to drink.

260. Remember, you can kill rabbits one at a time when you need meat. The drawings on the next pages show you how to kill and clean a rabbit.

261. If you are going to sell rabbits at the market, you should move them when it is cool. If it is too hot, they may die before

you get to the market.

262. Another way to sell rabbits is to put a few of them in boxes or in a pen by the side of the road near your house. That way people can come to look at them and to buy them.

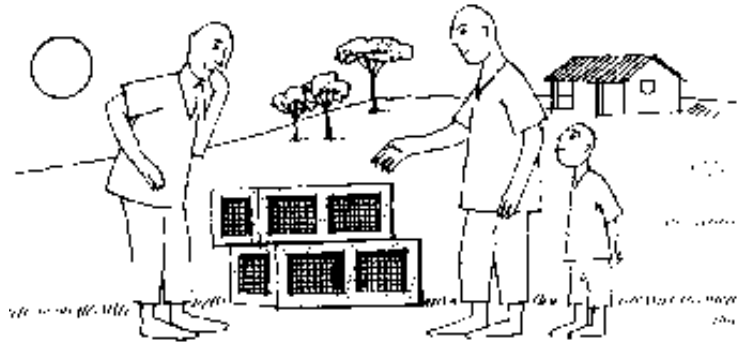

Put a few rabbits in boxes or in a pen by the side of the road

How to kill a rabbit

1 you can kill a rabbit quickly and easily by hitting it on the back of the neck

2 you can also kill a rabbit by holding its back feet and pulling its head down and out (as shown) to break its neck
3 when the rabbit is dead, tie it up by the back feet, cut off its head and front feet and let the blood drip out

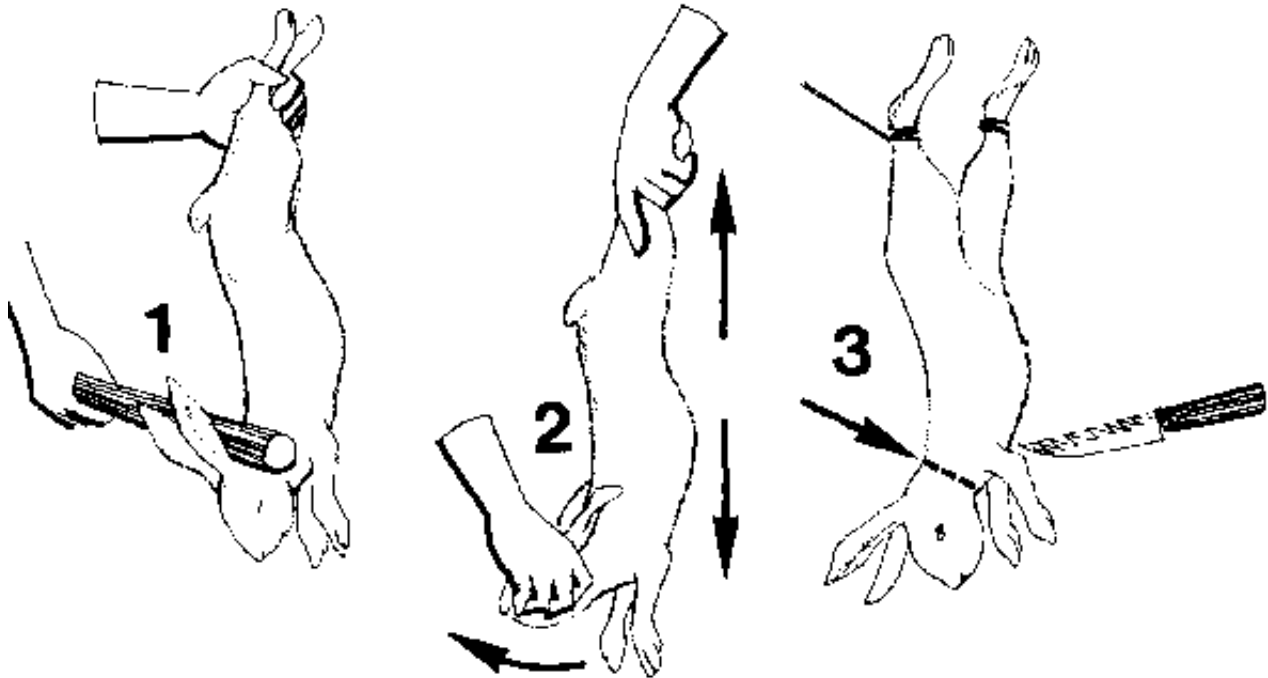

How to kill a rabbit

How to clean a rabbit

- 1 slit the skin around both back feet and make a cut from one leg to the other
- 2 pull off the skin from both back legs and cut off the tail
- 3 continue to pull the skin until it is completely off
- 4 cut the rabbit up the middle and take out everything except the kidneys, liver and heart (which are good to eat)

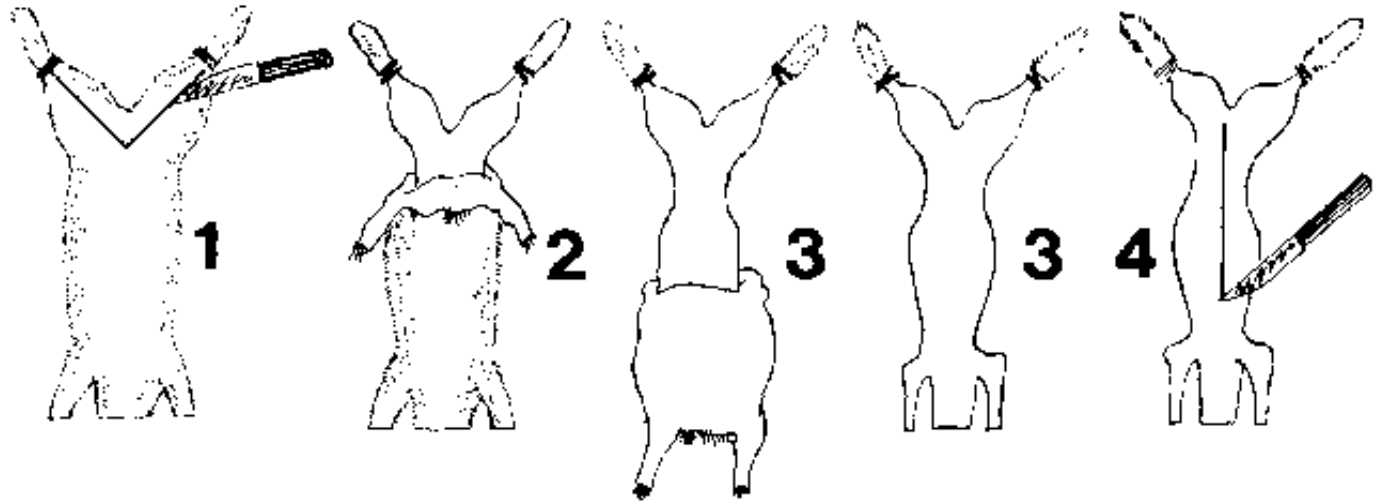

How to clean a rabbit

How to cut up a rabbit

- 1 back legs
- 2 rump
- 3 ribs
- 4 shoulders and front legs

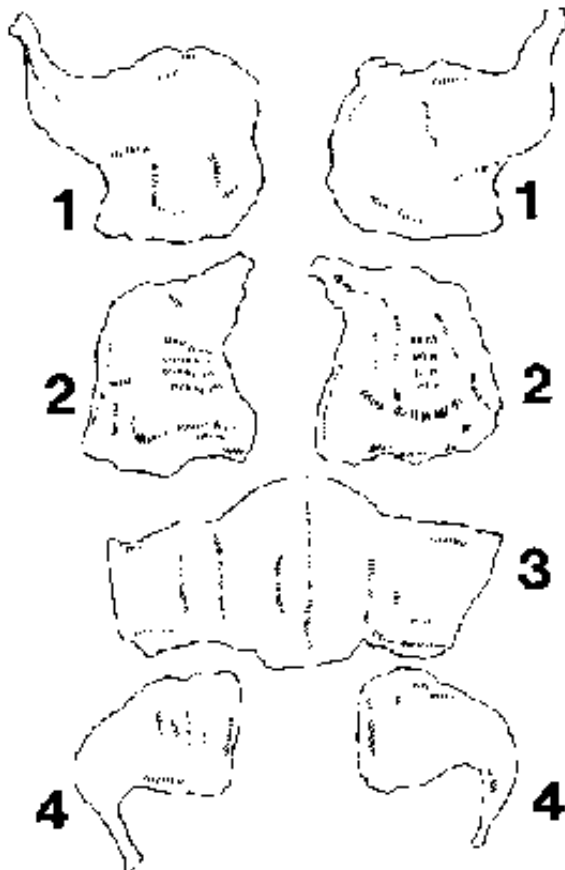

How to cut up a rabbit



[Home](#) > [ar](#).[cn](#).[de](#).[en](#).[es](#).[fr](#).[id](#).[it](#).[ph](#).[po](#).[ru](#).[sw](#)

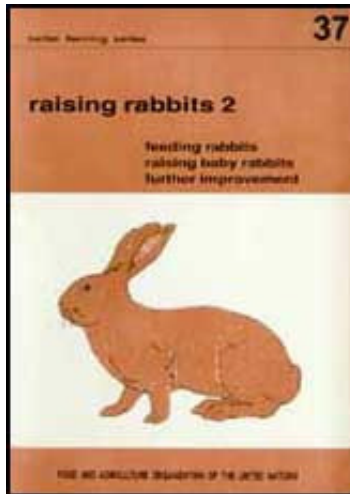

Better Farming Series 37 - Raising Rabbits 2: Feeding Rabbits; Raising Baby Rabbits; Further Improvement (FAO, 1988, 49 p.)



Further improvement



Raising more rabbits



Building better pens



Taking better care of your rabbits

Better Farming Series 37 - Raising Rabbits 2: Feeding Rabbits; Raising Baby Rabbits; Further Improvement (FAO, 1988, 49 p.)

Further improvement

Raising more rabbits

263. After you have been raising rabbits for some time with two full- grown females and one full- grown male, you may find that you and your family could eat or sell more rabbits if you had them.

264. The easiest way to raise more rabbits is to mate your two females more often. However, to do this your females must be very strong and healthy.

265. You can also raise more rabbits by keeping and mating more females. You can begin by keeping three or more full-grown females instead of only two.

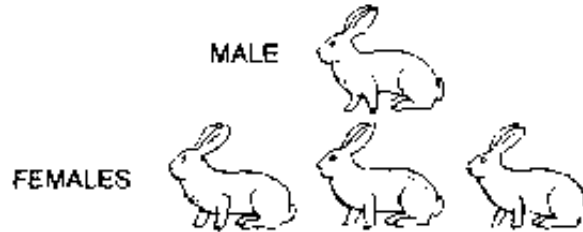

With three females you will need only one male

266. You have already been told that you can use your own young rabbits when you need more females for mating. So, start by choosing one or two of your healthiest females.

267. Remember, when you use your own female rabbits for mating, you must change your male rabbit about once every year (see Items 233 to 236 in this booklet).

268. One male rabbit can be used to mate as many as six females. However, if you have more than six female rabbits you will need to have two males.

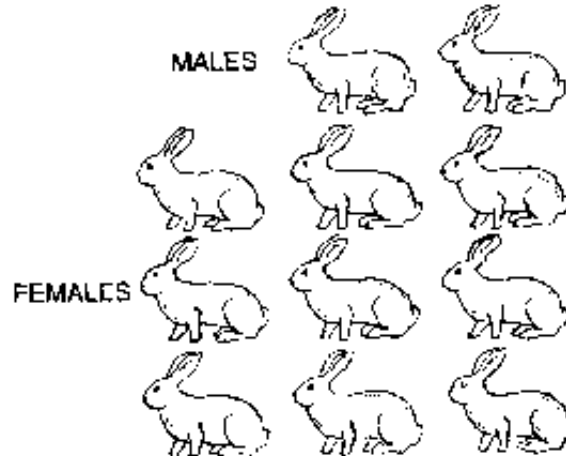

If you have more than six females you will need two males

Building better pens

269. In the last booklet you were told that wire mesh is the best material for building rabbit pens.

270. When you begin to keep more female rabbits for mating you will have to build more pens. Perhaps you would like to

use some wire mesh when you build them.

271. The drawings on the next pages show you how to build a better pen using wire mesh for the floors and for the inside walls.

272. If you do use wire mesh to build any of your pens, be sure to use these pens for your full- grown rabbits.

How to build a better pen using wire mesh

These pens are built much like those that you learned to build in the last booklet; however, the floors, inside walls and doors are made using wire mesh. The following items will tell you how to build these pens . . .

- 1 build the frames as you did before (see pages 22 to 24 in the last booklet), put them in the ground, fill the holes with earth and pack them well

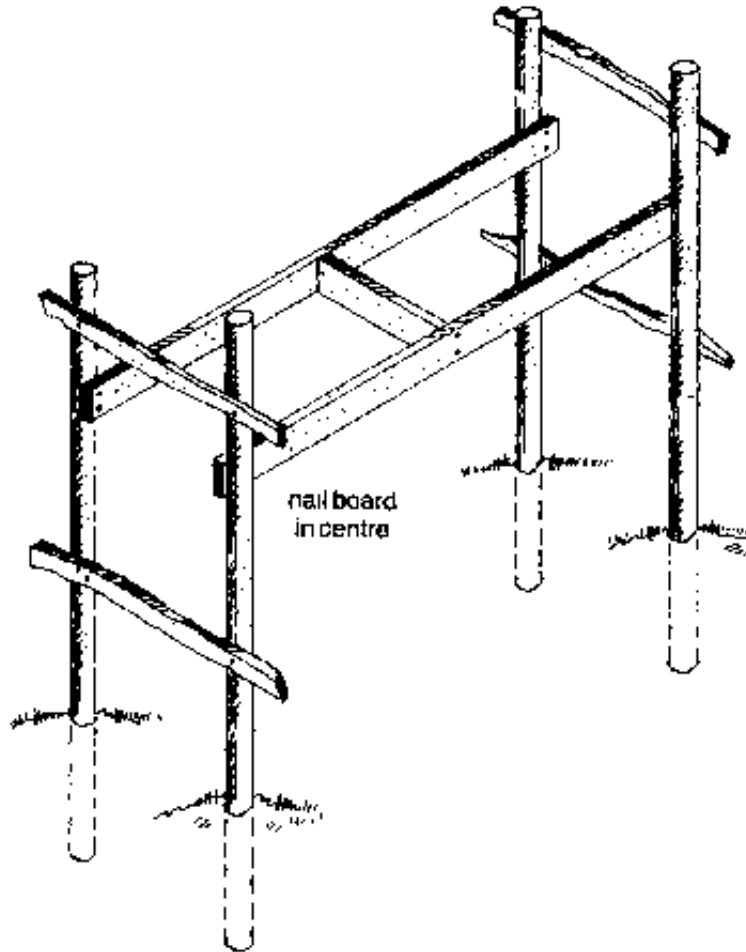

Nail board in centre

2 nail a 4 x 10 cm wooden board between the floor braces where the centre wall will be (see arrow)

3 nail 4 x 10 cm boards at the level of the braces all the way around the frame

4 cover this frame with 1.25 x 1.25 mm wire mesh

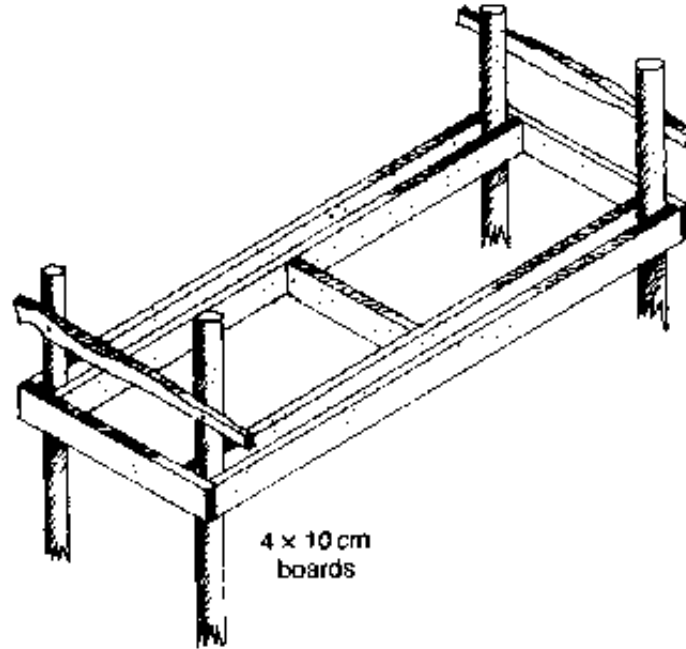

4 x 10 cm boards

5 cover the ends and back of the frame with wooden boards
(see page 25 in the last booklet)

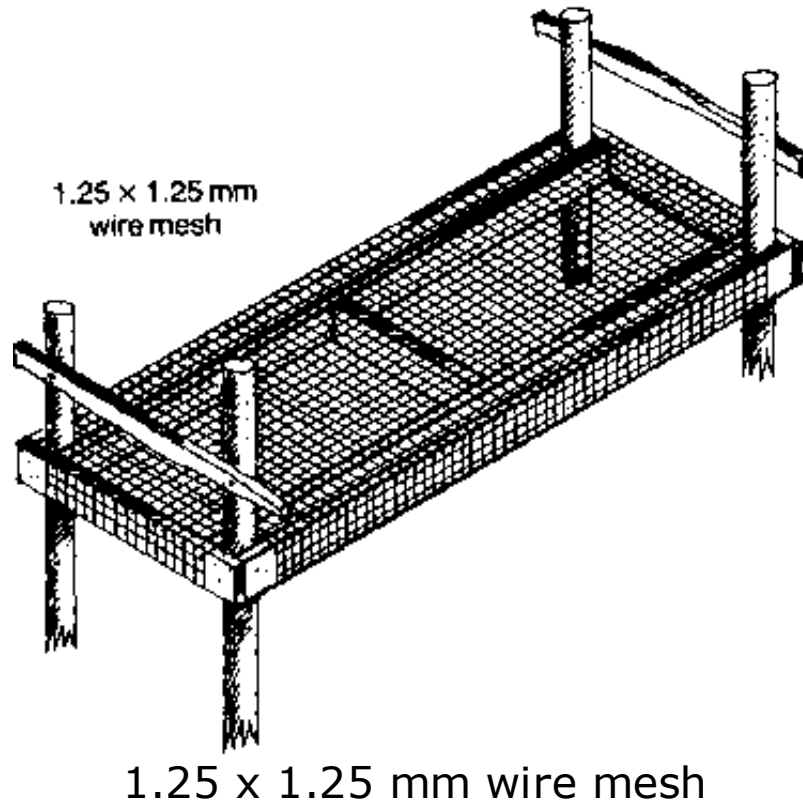

6 build a wall between the pens, cover it with wire mesh and attach it in the centre

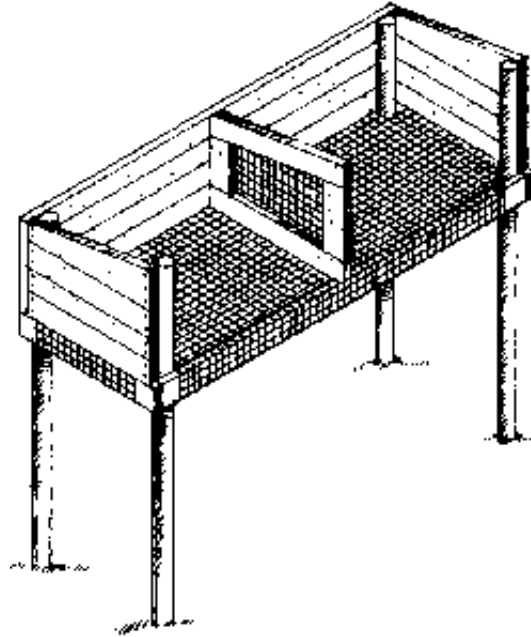

Attach the wall in the centre of the pen

7 finish boxing in the front using 10- cm boards, making sure that the boards are straight and square

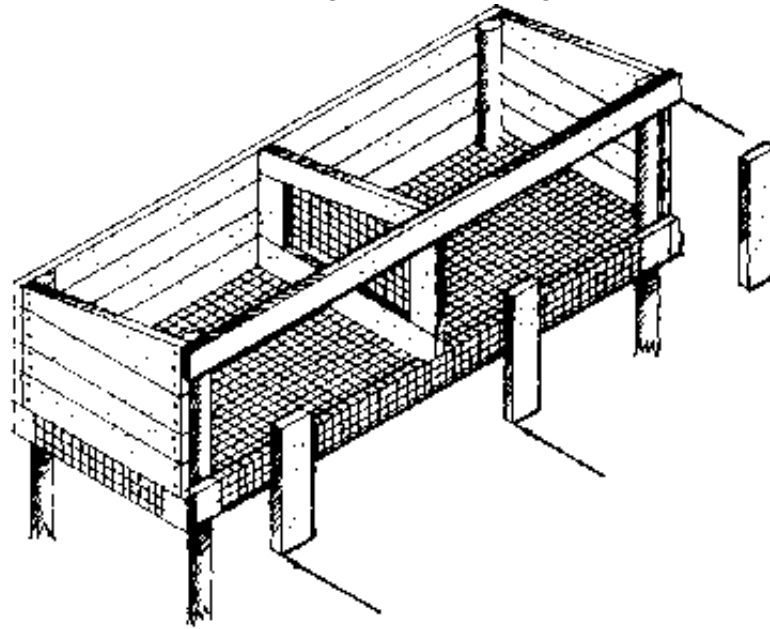

Finish boxing

8 to hold the pen doors in place, attach four pieces of wood to the inside of each pen and four small blocks with screws to the outside of each pen

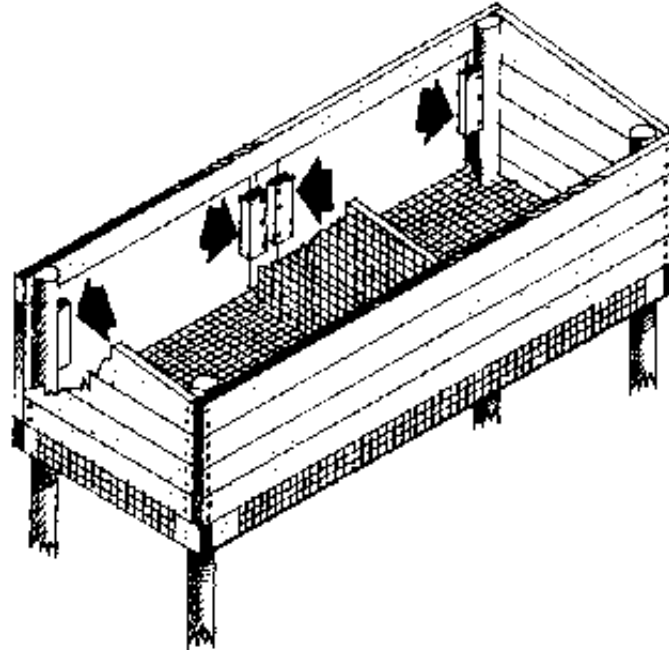

Attach four pieces of wood

9 now you can build the roof and cover it as before (see the last booklet)

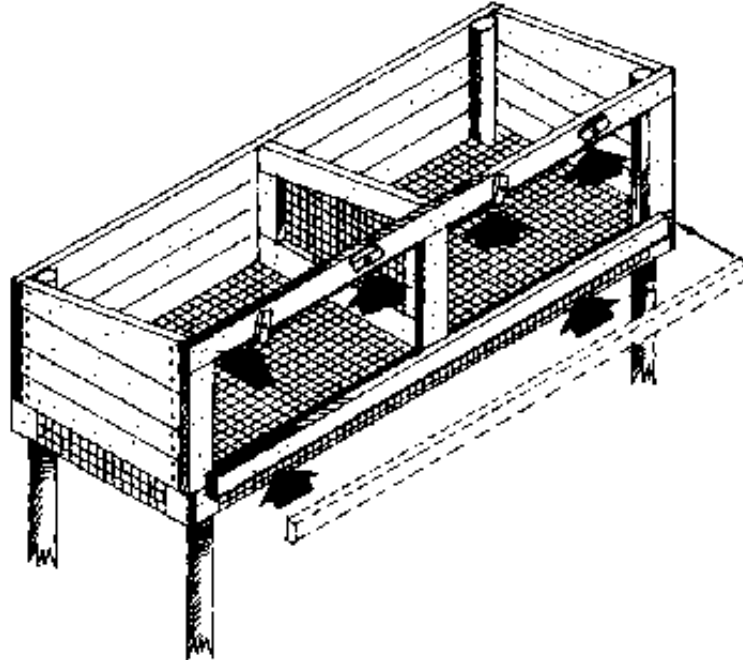

Build the roof and cover

10 build the pen doors as before; however, make the plant feeder using strong wire and wire mesh and cover the small door with wire mesh

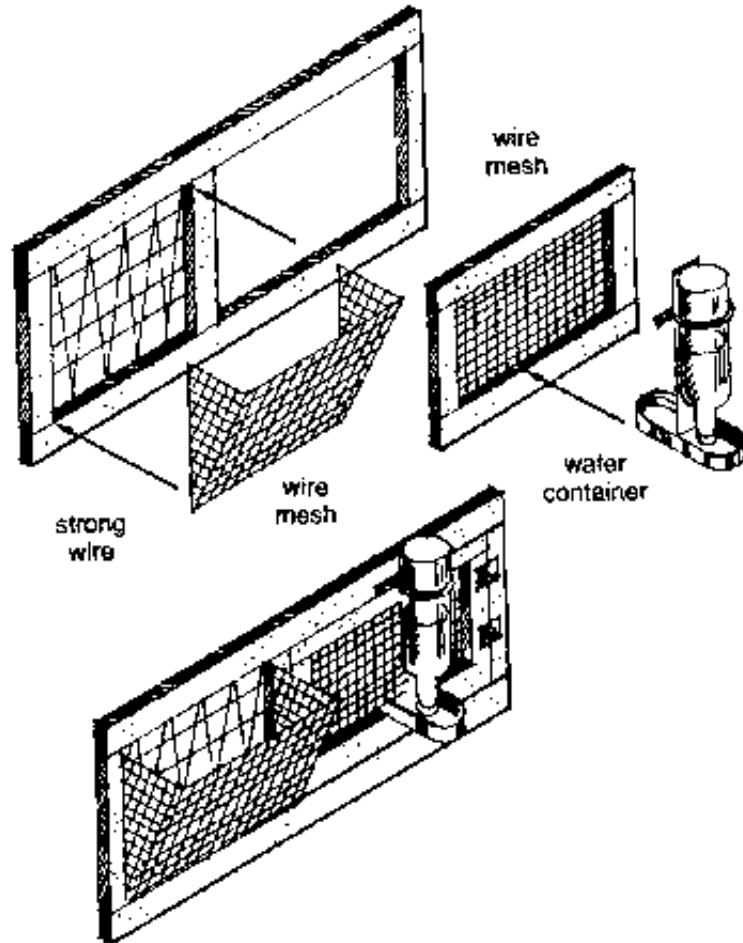

Build the pen doors

Taking better care of your rabbits

273. Remember, the more you learn about your rabbits the better you can take care of them. So, always watch them very carefully and learn as much as you can.

274. With experience you will learn the best food to feed them and just how much so that they will be strong and healthy and always have healthy baby rabbits.

275. You will also learn how best to keep them from getting sick and what to do for them if they do get sick.

276. Then, if you always choose the best young female rabbits when you need a new female for mating, you will improve the quality of the rabbits that you raise.

277. So, with more and better rabbits to eat and to sell, you and your family will be able to live better.

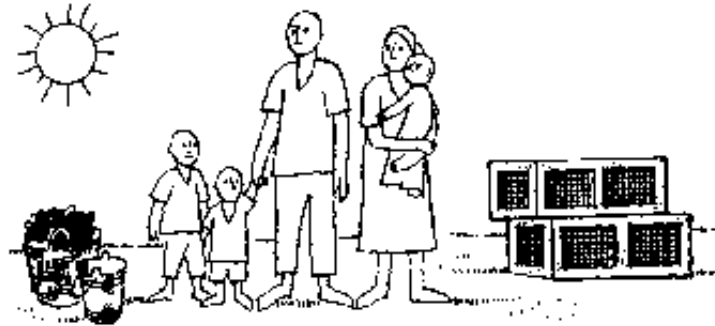

Your family will be able to live better

