

## **Preserving Food by Drying: a Math-Science Teaching Manual (Peace Corps, 1980, 218 p.)**



***(introduction...)***



**Acknowledgments**



**Introduction**



**Part 1. Weather**



***(introduction...)***



**Chapter 1. Water**



**Chapter 2. Sun and air**



**Part 2. Food dryers**



***(introduction...)***



**Chapter 3. Preparing for food drying**



**Chapter 4. Building food dryers**



**Part 3. Nutrition**



***(introduction...)***



**Chapter 5. Food drying tests**



**Chapter 6. Simple tests for food components**



**Chapter 7. Digestion**












**Chapter 8. Preservation treatments**



**Chapter 9. Preparation of dried foods**

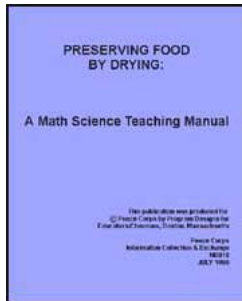












**Appendices**

-  **Appendix A. Materials cross-reference list**
-  **Appendix B. How to make a round hole in a tin**
-  **Appendix C. Conversions between metric British and American weights and measures**
-  **Appendix D. Differences between British and American terminology**
-  **Appendix E. Detecting changes in temperature without a thermometer**
-  **Appendix E. Making an equal arm balance**
-  **Appendix G. Making a set of weight's**
-  **Appendix H. A heating stand made from a tin**
-  **References**



[Home](#)"" """"""> [ar.cn.de.en.es.fr.id.it.ph.po.ru.sw](#)



-  **Preserving Food by Drying: a Math-Science Teaching Manual (Peace Corps, 1980, 218 p.)**
-   **(introduction...)**
-  **Acknowledgments**
-  **Introduction**
-  **Part 1. Weather**
-  **Part 2. Food dryers**
-  **Part 3. Nutrition**
-  **Appendices**
-  **References**

**BY  
CYNTHIA FAHY  
AND  
PER CHRISTIANSEN**






**EDITED BY  
KAREN BOATMAN  
AND  
CARL VOGEL**

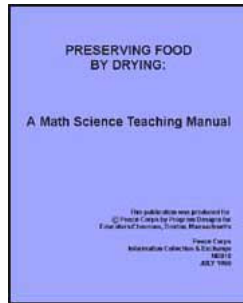
**This publication was produced for  
Peace Corps by Program Designs for  
Educators/Chevrons, Boston, Massachusetts**

**Peace Corps  
Information Collection & Exchange  
M0010  
JULY 1980**



[Home](#) > [ar.cn.de.en.es.fr.id.it.ph.po.ru.sw](#)

- 
-  **Preserving Food by Drying: a Math-Science Teaching Manual (Peace Corps, 1980, 218 p.)**
  -  ***(introduction...)***
  -  **Acknowledgments**
  -  **Introduction**
  -  **Part 1. Weather**



- 📁 **Part 2. Food dryers**
- 📁 **Part 3. Nutrition**
- 📁 **Appendices**
- 📄 **References**

## Acknowledgments

### INFORMATION COLLECTION & EXCHANGE

**Peace Corps' Information Collection & Exchange (ICE) was established so that the strategies and technologies developed by Peace Corps Volunteers, their coworkers, and their counterparts could be made available to the wide range of development organizations and individual workers who might find them useful. Training guides, curricula, lesson plans, project reports, manuals and other Peace Corps generated materials developed in the field are collected and reviewed. Some are reprinted "as is"; others provide a source of field based information for the production of manuals or for research in particular program areas. Materials that you submit to ICE thus become part of the Peace Corps' larger contribution to development.**

**Information about ICE publications and services is available through**

The Peace Corps Internet Web Site address:

<http://www.peacecorps.gov>

Please note the new Peace Corps Mailing Address from July 1998 on is:


ICE/ Peace Corps  
1111 20th Street N.W.  
Washington, DC 20526  
USA

**Add your experience to the ICE Resource Center. Send materials that you have prepared so that we can share them with others working in the development field. Your technical insights serve as the basis for the generation of ICE manuals, reprints, and resource packets, and also ensure that ICE is providing the most up-to-date, innovative problem solving techniques and information available to you and your fellow development workers.**

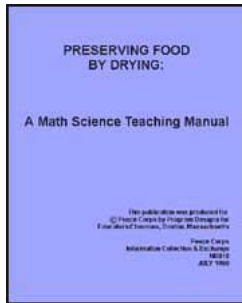
**Many thanks to Sally Babb Landry, Arnulfo Barayuga and Lance Hellman for photography and art work. The final drawings were done by Robert Hammell. Thanks also to Margaret Jerger for her assistance in the overall assembly, editing, and production of the manual; to Janice Coleman for her attention to the details of production and to Rosly Walter for the comprehensiveness of her draft copy review. Research space for testing some of the activities was generously donated by the Boston Food Cooperative. Thanks to Mary Ernsberger and Howard Ebenstein of Peace Corps for their continued support and assistance. Thanks to USDA nutrition staff for their review.**










**[Home](#)** > **[ar.cn.de.en.es.fr.id.it.ph.po.ru.sw](#)**

 **Preserving Food by Drying: a Math-Science Teaching Manual (Peace Corps, 1980, 218 p.)**

 ***(introduction...)***



-  **Acknowledgments**
-  **Introduction**
-  **Part 1. Weather**
-  **Part 2. Food dryers**
-  **Part 3. Nutrition**
-  **Appendices**
-  **References**

## Introduction

**Preserving Food by Drying is a design for teaching science principles and mathematics concepts through a sequence of activities concentrating on weather, solar food dryers and nutrition.**

**Part I concentrates on the effect of the sun's energy on air and water: students learn about evaporation, condensation, radiation, conduction and convection.**

**Applying these concepts to food drying, in Part II, students experiment to build the most effective solar food dryer for their locality. Emphasis is placed on using locally available materials and making the hardware needed.**

**In Part III, students use the food dryer they have built in experiments demonstrating the effect of drying foods and the importance of using proper drying methods. They then create balanced diets from the foods they have dried and compile information about food drying for the people of their community.**

**The three parts each begin with an introduction and a diagram outlining the major concepts covered. Concepts are presented through a constellation of activities designed to**

**keep students actively involved and focused. Background information is provided before each related group of activities.**

**Each activity contains a brief introduction, a list of materials needed, instructions for what is to be done, questions to ask the students while they are doing the activities, instructions on what information the students should be noting as they work, and suggestions for discussion. By the middle of Part I, when students have become accustomed to the way the activities are organized, instructions for activities are somewhat less detailed.**

**Scattered throughout the manual are suggestions enclosed in boxes, these are recommended for further study for students who show particular interest. A reference section is also provided, with an overall listing of materials and/or equipment needed for each activity, and suggestions for alternatives.**

**While Food Preservation by Drying is designed as a full-year classroom course of study, any of the activities can be selected to enhance a standard curricula, to reinforce learning in another subject such as agriculture or health science, or to encourage discussion in an informal or adult literary setting. Other ICE publications which might prove useful to teachers focusing classwork or community work on food preservation include:**

- 1. How to Make Tools (#R 35)\***
- 2. Food Preservation Resource Packet (#P 7)**
- 3. Small Farm Grain Storage (#M 2)**
- 4. Agricultural Mathematics for Peace Corps Volunteers (#R 4)**
- 5. Visual Aids (#R2)**
- 6. Intensive Vegetable Gardening for Profit and Self-Sufficiency (#R 25)**

**Like other ICE manuals, Food Preservation by Drying is designed to be used, adapted, modified and revised and it is you, the users in the field, who know best how relevant it is.**

**ICE would appreciate your feedback, particularly in the following areas:**

**Were the materials for activities easy to acquire?**

**Were your students able to use the open-ended, lack of step-by-step approach in developing problem-solving skills?**

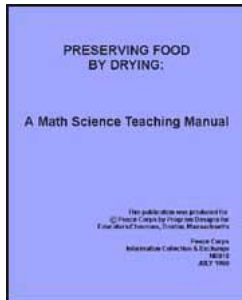
**What changes would you recommend in materials, activities or sequencing of activities?**


**Please send any comments you have to:**


**\*How to Make Tools was prepared in conjunction with Food Preservation by Drying and several of its sections have been included in the appendices on pp. 191 to 213 . However, if your students do not have access to tools such as saws, hammers, etc., Reprint 35 provides directions for making all the basic tools necessary to build both small and large dryers.**



[Home](#) > [ar](#) [cn](#) [de](#) [en](#) [es](#) [fr](#) [id](#) [it](#) [ph](#) [po](#) [ru](#) [sw](#)



 **Preserving Food by Drying: a Math-Science Teaching Manual (Peace Corps, 1980, 218 p.)**

➔  **Part 1. Weather**

 **(introduction...)**

 **Chapter 1. Water**

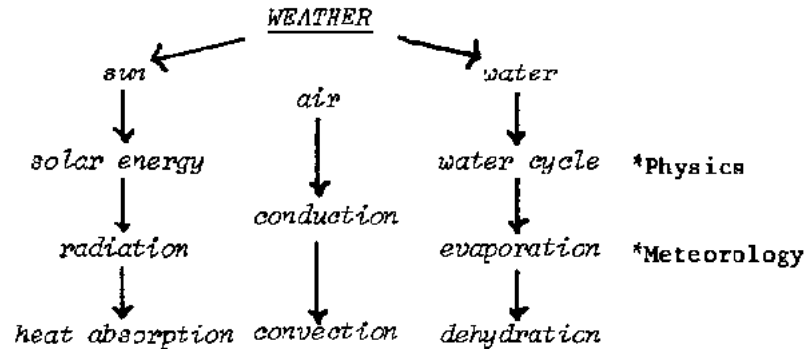
 **Chapter 2. Sun and air**



**Preserving Food by Drying: a Math-Science Teaching Manual (Peace Corps, 1980, 218 p.)****Part 1. Weather**

**The activity lessons in this part provide the basis for an understanding of weather. This is done by looking at some interactions of water and air with energy from the sun. Important concepts are learned during the study of these interactions which provide a basis for designing and operating food dryers effectively.**

**Part I is presented in two chapters. The first chapter includes activities about water and its relation to weather. The second chapter is concerned with the sun and its energy, and includes activities relating to conduction and convection. In the final activities of this chapter, students build and test small devices that are, in fact, simple models of food dryers. The concepts learned in the activities in this part are expanded in Part II and applied to the construction and testing of large food dryers. Part III supplies the rationale for preserving perishable foods by showing that good nutrition is possible throughout the year.**



**Figure**

The number of weather ideas to include or emphasize is dependent on the science skill level of the students and on what they have studied previously. This part concentrates on what could be called the "microscopic view" of weather, with emphasis on developing a familiarity with evaporation and condensation, and how the presence of the sun's energy affects these processes in nature. The "macroscopic view", concerned with the influence of oceans and mountain ranges on regional weather patterns, is something that you can introduce if the students are unfamiliar with it.

At the conclusion of Part I, the students will be able to:

1. name the three variables affecting the evaporation of water.
2. vary the factors affecting evaporation to increase or decrease the rate of evaporation.
3. make predictions about a system of evaporation when one or more variables are changed.

#### **4. use controls in experimenting, testing only one variable at a time.**

**After reading through Part I, you may see some areas that need special attention because your students lack appropriate preparation. One approach is to proceed slowly through these areas, including additional activities from other sources whenever you find that your students need additional work. Another approach is to precede this part with lessons on weighing, heat, displacement, etc.**

**To help you plan for materials, in the Appendices there is a chart showing everything needed in Part I. The chart lists all the activities where each item is used. From this chart, you can quickly see which materials are often used, and which materials are only needed for a few activities. Alternatives for many materials are also shown.**

**Alternate activities for students with particular interests and abilities are offered throughout the unit. Some of the activities involve expanding studies of solar devices such as a solar still. The distilled water produced could be used later in the food preservation and preparation activities in Part III.**

**A number of the activities in Part I could be conducted at various times during the year as the seasons change. This would be useful if weather studies are to be emphasized. Also, if some students are interested in weather, they could independently conduct the activities each season.**

### **Chapter 1. Water**

#### **BACKGROUND INFORMATION ON EVAPORATION**

**The sun's energy is useful to us in many ways. One of them is in the evaporation, transportation and condensation of water. This is known as the water cycle.**

**As water absorbs the sun's energy, it is warmed and evaporates; it changes from liquid to gaseous water vapor. The rate of evaporation depends on:**

- 1. the temperature of the water.**
- 2. the area of water exposed to air.**
- 3. the ability of the air to hold more water vapor.**

**When other substances such as salt or dirt particles are dissolved or mixed with water, they are left behind when the water evaporates. Distillation is one process of purifying water whereby water is caused to evaporate, leaving behind impurities, and then cooled to condense the pure water. Rain is essentially pure water that has evaporated from lakes, oceans, soil, leaves of plants, etc. and has condensed in the air high above the earth.**

**These concepts are developed in the activities. Some of the devices used in these activities can be enlarged and used later during the food preservation and preparation activities. You may want to expand the activities to develop weather studies or follow the suggested sequence to lead more directly to the development of food dryers. If the science students have studied weather previously, you can ask them to summarize their knowledge during discussions.**

### **Activity I-1 EVAPORATION OF WATER**

**This activity begins the study of evaporation. Students explore what happens when water is allowed to stand exposed to air under different conditions. The students discover or reaffirm that water evaporates at a rate that can be varied by changing the conditions in which the water is stored. Surface area, purity of the water, and temperature are each varied separately. Each of four groups sets up a different evaporation experiment. (You may want to alter this arrangement.) Containers of water are allowed to stand over a period of several days. The students observe them each day to determine how much water has evaporated. Throughout questioning and the discussions of the process, encourage**

**record keeping as well as writing descriptions of experiments. The records can be used during discussions and for future reference. Secondarily, they provide practice in communication skills.**

**Measuring the volume of water is required in this activity. Students who do not have much experience with the manipulation of measuring vessels may need an extra class period to develop a concept of the hierarchy of measuring units. For example, they could pour water from one container to another, using a variety of containers, until they find relationships such as:**

**15 bottle caps full = 1 small tomato tin**

**3 small tomato tins = 1 large tin**

**Measuring units developed by the students may be more immediately understandable than standard metric or English units. Also, it may be more practical if the supply of standard measuring devices is limited. Developing a system of measurement using available containers and other materials assures that each group of students can have a set of equipment for the activities. Conversion tables for the student-developed system to metric units and to English units can be developed and posted for use.**

**For these experiments, the class should adopt a unit of volume for water that is an appropriate size to evaporate during a few class periods, You should practice the activity for "Group One" ahead of time so you can find out about how much water to use. It varies a lot in different localities, depending on the humidity and on whether or not there is much movement of the air near the surface of the water.**

**Many tins are needed for this activity. Ask your students to begin collecting tins now. Every size of tin will be useful, including very small tins. The tins will also be used in many other activities. If each student brings three tins, there will be enough.**

	Group			
	One	Two	Three	Four
Size of each sub-group	2	2	3	3
Tins of various sizes and dishes or trays	6			
Tins of the same size		4	4	2
Water	X	X	X	X
Measuring spoons, cups, tins, bottle caps, etc. as needed to measure the amount of water you have found appropriate	X	X	X	X
Means for labeling the tins, such as paper; and cement, elastic bands, or tape		X		
Cloth				2
Small stones				3
Rulers marked in centimeters	X	X	X	
Paper	6	1	1	1
Salt		X		
Sugar		X		
Cooking oil		X		
Source of a smoky flame, such as a candle or paraffin lamp			1	
Matches			X	
Sunlight			X	X

**Materials**

**Divide the students into four groups. However, if your class is large and your groups contain many students, make subgroups within each group. The recommended size of each subgroup is shown on the first line of the materials list. Each sub-group should have between two and four members because small sub-groups are better than large sub-groups. The quantities of materials listed are what one sub-group needs. Multiply by the number of sub-groups you have.**

**Items shown with an "X" can be shared by everyone or by several sub-groups.**

**Procedure for Croup One Choose several tins of different diameters, and some dishes or trays. On a piece of paper, trace around the top of each container. Save these tracings because they will be used in Activity I-2. Into each container, pour one measure of water. With a ruler, measure the diameter of the container and write it down. Measure how many centimeters deep the water is in each container.**

**Is the water the same depth in each container?**

**Which container has the deepest water?**

**Which container has the shallowest water?**

**Does each container have the same amount of water?**

**Which container has the largest area inside the tracing on the paper?**

**Do you think there will be any change in the amounts of water in these containers tomorrow?**

**Put the containers in a shady place where they will not be disturbed.**

## **Day 2**

**How deep is the water in each container today? Write down the measurements.**

**Which container do you think will have the most water after another day?**

**Which container do you think will have the least water after another day?**

**Procedure for Group Two Choose four tins of the same size. On a piece of paper, trace around the top of one of them and save it for Activity I-2. In the first tin, put one measure of water. In the second tin, put one measure of water and a quarter ( $1/4$ ) measure of salt. Stir. In the third, put one measure of water and a quarter measure of sugar. Stir. In the fourth, put one measure of water and a quarter measure of cooking oil. Stir. Label the tins. Measure how many centimeters deep the liquid is in each tin. Write these measurements down.**

**Do all the tins contain the same amount?**

**Which tin has the deepest liquid?**

**Do any of the tins have the same depth of liquid?**

**Do you think there will be any change in the amounts of liquid in these tins when we measure them tomorrow?**

**Put the tins in a shady place where they will not be disturbed.**

## **Day 2**

**How deep is the liquid in each tin today? Write down the measurements.**



**Which tin do you think will have the most liquid after another day?**

**Which tin do you think will have the least liquid after another day?**

**Is there any difference in the appearance of the tin that has salt dissolved in it and the tin with sugar dissolved in it?**

**Procedure for Group Three Choose four tins of the same size. On a piece of paper, trace the open top of one of them to use in Activity I-2. With a smoky flame, cover the outside of two of the tins with soot. Then pour one measure of water in each of the four tins. Measure how many centimeters deep the liquid is in each tin, Write these measurements down.**

**Do all the tins contain the same amount?**

**What do you expect will happen to the water in the tins?**

**Place one black and one shiny tin in sunlight and one black and one shiny tin in the shade. Place the tins so they will not be disturbed. If they are likely to be disturbed outdoors during the night, bring in all the tins that are kept in sunlight indoors each night and put them in sunlight again each morning.**

**Day 2**

**How deep is the liquid in each tin today? Write down the measurements.**

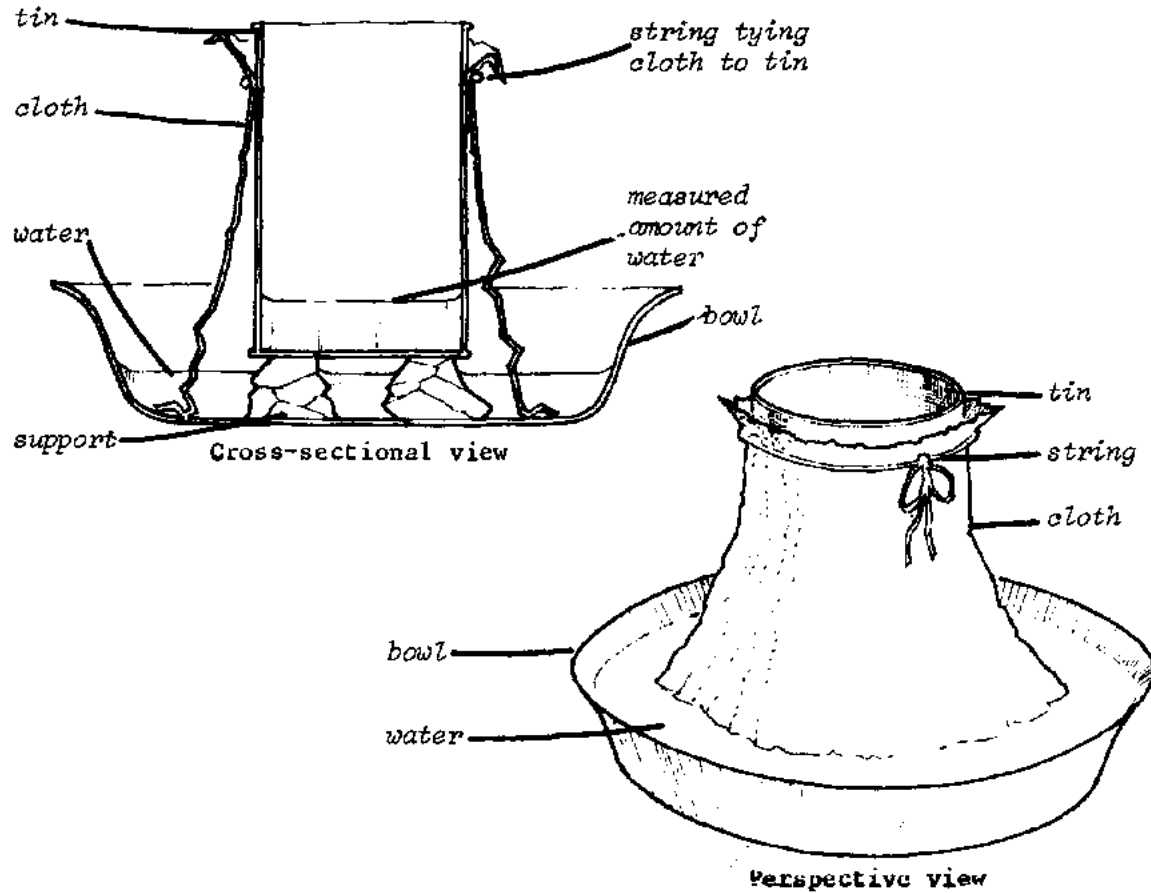
**Which tin do you think will have the most liquid after another day?**

**Which tin do you think will have the least liquid after another day?**

**Do any of the tins have the same depth of liquid?**

**Procedure [or Group Four Choose two tins of the same size. Trace the top of one of them on paper to use in Activity I-2. Cut two round pieces of cloth about three times the height of the tin from the same piece of cloth. They need not be exactly round. Each sub-group in Group Four should use a different kind of cloth for its pair of tins if possible. Make a hole in the center of each cloth large enough so the open end of a tin can fit into it. Next, choose two trays or wide bowls that are several centimeters deep. As support, put three small stones, or a small short tin with a hole punched in its bottom, into each bowl. A tin will stand on this support. Put one cloth over each tin so the open end of the tin comes out of the hole. With string, tie the cloth onto the tin near the open top of the tin.**

**Into one bowl, pour almost enough water to cover the support. Leave the other bowl dry. Put each tin, with its cloth, into a bowl so it stands on the three stones or on the short tin. The cloth should drape into the bottom of the bowl. Pour one measure of water into each tin.**



**DIAGRAM 1**

**Measure how many centimeters deep the water is in each tin. Write these measurements down.**

**Does each tin have the same amount of water?**

**Do you think there will be any change in the amounts of water in these tins when we measure them tomorrow?**

**Does the cloth with its lower edge in the water become wet all over?**

**Place both bowls and tins in a sunny location. Carry them carefully indoors each night and put them in sunlight again each morning if they are likely to be disturbed outdoors during the night. Pour extra water into the wet bowl as it is needed to keep the edge of the cloth in water. Do not add water to the tins.**

**How deep is the water in each tin today? Write down the measurements.**

**Is anything else different between the water in the two tins?**

**Have you any theories about how the water in the bowl changes the rate of water loss?**

### **Teaching Method Alternatives**

**The first day, the students will be occupied setting up the equipment. On the last day, there will be comparison and discussion of results. During the intermediate days only enough time will be needed for the students to observe the liquid in each container and write down their measurements and any other observations. They will do this until all the water is evaporated from most of the containers. During these days, there will be time available to do something else with the students. Here are two suggestions of what to do:**

**1. Have each group show the others their experiments each day. This will give everyone a**

**chance to know what each group is doing, and to make their own guesses about the results of each group's experiments. If your class is already used to comparing and discussing their results, this alternative will work out well. If the students are not ready to exchange information as outlined above, begin Activity I-2 with whatever extra time you may have in these intermediate days.**

**2. Begin Activity I-2. In this activity, the students make use of the tracings they make the first day of the sizes of the tins or other containers. They find the area of these tracings, and they also find the area of other things.**

**Note: The discussion after Activity I-2 uses the results gotten by Group One, I-1, and some of the results from the other groups. Therefore, the discussion of I-2 should not be begun before the students have finished Activity I-1.**

### **Discussion of Activity I-1**

**At the end of the activity, have each group report their findings to the class. These should include:**

- 1. Amounts of liquid in each container or tin each day.**
- 2. Comments about which predictions were correct or not, and ideas that led to these predictions.**
- 3. Each group's conclusions resulting from their measurements and other observations.**

**During the discussion, introduce the term 'evaporation' after the students have described the concept.**

**The rest of the class should have a chance to consider the conclusions of each group, and to form a tentative opinion concerning whether each experimental situation is satisfactorily understood. You should allow groups or individuals to do any of these experiments again if they express interest. Tell the students that the next experiments will help them become more familiar with evaporation.**

**Ask the students if they are aware of situations in nature where evaporation occurs. If some situations are mentioned, ask if these vary with the time of year.**

### **Activity I-2A AREA**

**This activity provides a brief look at the concept of area which is needed to understand that evaporation of a given volume of water will be more rapid if it is spread out more. The concept of area provides a measurable way of talking about how much of a liquid is exposed to air. If the students have demonstrated an understanding of area previously, such as in discussions during Activity I-1, you can proceed directly to the next discussion after doing Activity I-2A.**

### **Materials**

**Sub-group size: This activity can be done by each student individually. However, you may decide to have the students work cooperatively in the same subgroups formed for Activity I1.**

**Grid paper with 1 centimeter squares. You can have students make this, or you can produce it with a hectograph or cyclostyle or other copying device.**

**Samples of the tins, trays and dishes used in the first activity.**

**Tracings of tins, trays, dishes from the first activity.**

**Rulers marked in centimeters.**

**Scissors or razor blades.**

**Pencils.**

**The squares on the grid paper are 1 centimeter on a side. The area each square covers is 1 square centimeter. Have the students trace around the top of a container used in the first activity, or cut out a tracing from the first activity and draw around it on the grid paper.**

**How many square centimeters are inside the tracing?**

**A good approximation can be made by first counting all the squares that are completely inside the tracing line, and then adding an estimate of the area of squares that are partly inside the line. Encourage your students to try different ways of approximating the area accounted for by squares that are only partly inside the tracing.**

**Find the area of the open tops of all the sizes of tins, trays or dishes used in the first activity. Students who do not have tracings can trace around the containers they used in the first activity. Have the students make a list of these areas, starting with the largest, then the next-to-the-largest, and so on, with the last area on the list being the smallest. Have this list saved because it will be used in a discussion later.**

**Further Study**

**1. Estimate the area of a circle. Draw a 10 centimeter radius circle. Its radius is 10 cm, therefore its diameter is 20 cm. Make a square around this circle. Its sides each have a length of 20 cm, the same size as the diameter of the circle. The area of the square is 20 = cm by 20 cm, or 400 square cm.  $A = D^2$ . Now make an estimate of the area of the circle. Some possible estimates could be:**

$A_0 = (1/2)A$	$A_0 = (3/4)A$	$A_0 = (7/8)A$
----------------	----------------	----------------

**What is yours?**

**2. Check your estimate of the area of the circle. Make a grid sheet out of the piece of paper that has the circle and the square drawn on it. Your squares should all be the same size but you can choose any size squares between 1 cm and 4 cm on a side. Count how many are in the circle and how many are in the square.**

$$A_0 = (\text{squares in circle} / \text{squares in square})A$$

**3. Compare the area of the circle you get with your estimate**

$$A_0 = (?/? )A$$

**4. The exact formula for a circle can be written as:**

$$A_0 = \pi r^2 \text{ or } A_0 = (\pi/4)D^2$$

**Since  $D^2 = A$  , the area of a circle can also be written:**

$$A_0 = (\pi/4)A$$

**Compare your estimate of the area of the circle with the exact formula.**

**( $\pi$  is pronounced "pie". Its value is about 3, which is close enough for most practical use).**

**You can find the percentage difference between your estimate and the exact area this way:**

$$\% \text{ diff.} = [(\text{your area} - \text{formula area}) / (\text{formula area})] \times 100$$



**If the answer is positive, your estimate was larger than the exact area; if negative, your estimate was smaller. If your estimate was within 10% of the exact area, it was an accurate enough estimate for most purposes.**

### **Activity I-2B AREA**

**Finding the area of parts of the human body is a way of developing skills in estimating surface areas.**

#### **Materials**

**Sub-group size: Students can work individually or in sub groups.**

**Grid paper with 1 centimeter squares.**

#### **Pencils**

**Have the students trace around their hands on 1 centimeter grid paper. Have them find the area enclosed in this outline and use it as a basis for estimating the area of all the skin on their hands.**

**What is the area enclosed in your tracing?**

**What is your estimate for the area of all the skin on your hand?**

**How did you decide on your estimate?**

**Have the students make a list that shows each student's name and the area of their tracing. Start with the smallest area, then the next-to-the-smallest, so that the last name on the list is the student whose tracing has the largest area. Now have the students add each person's estimate of the area of all the skin on their hand to this table.**

## Estimating Total Hand Area

Name	Area of tracing	Estimate of total of hand area

**Which estimates seem accurate when compared to the rest of the estimates?**

**Which estimates are very different from others nearby on the list?**

**Which is more correct?**

**Have the class consider each estimate that deviates a lot from surrounding estimates to decide whether it is more accurate or less accurate than the others.**

**The area of the hand is approximately one hundredth of the total skin area of the body.**

### Further Study

**The body's area can be approximated also by wrapping cylinders of paper around the arms, legs, trunk and head. Then calculate the area of the paper used.**

**This activity can be tied to health studies by discussing the body's evaporative process: sweating.**

### Discussion of Activities I-1 and I-2

**Direct a discussion in which students compare the area of each container's open top with the number of days it took the water to completely change to vapor. Use all the results for containers that were kept in the shade but not those that were put in sunlight each day. As a way to focus the discussion, the following table could be placed on the blackboard and**

**be filled in by students from each group. Use the list of areas which was prepared in Activity I-2A. This starts with the largest area and ends with the smallest.**

### **Comparison of Area of Open Top to Time Necessary for Complete Evaporation**

Description of container	Area of open top	Number of days to completely evaporate in the shade	Number of centimeter deep when experiment started	What was in each container
--------------------------	------------------	---	---	----------------------------

**Note that in this experiment the number of measures of water put in each container was the same.**

**Do the results show any relationship between area and time for the water to evaporate?**

**If so, what is it?**

**If so, what cases don't seem to fit the relationship?**

**Does the height of the sides of the container affect the rate of evaporation?**

**Are there any containers where the area of the open top is larger or smaller than the area of the liquid's surface?**

**If so, does this have any effect?**

**If water was not the only thing in the tin, was there any change in the rate of evaporation?**

### **Further Study**

**1. Make a graph of days to evaporate versus square centimeters of area.**

**2. Do the Group One experiment again but this time (a) put the same depth of water in**

**each container or (b) use tins of the same diameter but with different heights or (c) use tins of various diameters but with the same height. See how many days it takes for the containers to become empty. Tabulate the results in a similar way and discuss them.**

### **BACKGROUND INFORMATION ON BOILING**

**One way to increase the rate of evaporation is by heating the liquid. This was illustrated in Activity I-1 where Group Three and Group Four put tins with water in sunlight and found that the water evaporated faster in the tin that was warmed the most by the sun. The rapid disappearance of water when it is heated is part of the everyday experiences of drying clothes, ironing clothes and cooking food.**

**If enough heat is applied to water, it will reach a temperature where further heating causes it to change to vapor. As the water becomes warm, bubbles of air form on the inside surface of the container. This is air that was dissolved in the cool water. Therefore bubbles form as the water becomes warmer. Knowing that air dissolves in water helps in understanding that water can dissolve in air, which is what has been happening in the evaporation experiments you have been doing. (Realizing that air is able to dissolve in water also helps in understanding how fish can breathe without coming to the surface of the water.) The idea that temperature has an effect on how much of one substance can be dissolved in another will be worked with in future activities.**

**When the water becomes quite hot, bubbles of water vapor are formed where the water is in contact with the part of the container that is being heated by the fire. At first, they change to water again as they rise through the somewhat cooler water near the surface. Sound comes from the container, but the bubbles of vapor are not reaching the air. If heat continues to be supplied, all the liquid becomes hot enough so the bubbles reach the surface and the vapor in them mixes with the air. This process is called boiling.**

### **Activity I-3A HEATING WATER**

**In this activity, a tin of water is placed over a fire and heated. The water becomes hot and boils until no liquid is left.**

### **Materials**

**Sub-group size: Two or three students. All the sub-groups follow the same procedure.**

**Heat source: Charcoal cooker and charcoal or three stones and firewood, and a metal grating or other support so tins of various sizes can be put over the fire. Two or three sub-groups can use each fire.**

**Tongs or cloth to lift tins on and off the fire.**

**Tins of various sizes.**

**Alternate heat source: Burner and paraffin or gas, and support for tins. One for each sub-group,**

**Watch or other timer such as a pendulum made from a stone hanging on a piece of wire about two meters long. This swings about forty-two times each minute. All the subgroups can use the same timer.**

**Matches.**

**If the heat source has a large hot area like a charcoal burner or a fire, you can assume that the heat is being applied to the entire bottom of the tin. Each sub-group should make a chart like this to collect their results.**

**Time Required to Heat and Change Water to Vapor in Various Size Tins or Containers**

Diameter	Number of seconds or	Number of seconds or swings	Number of seconds or
----------	----------------------	-----------------------------	----------------------

of tin in cm	swings until sound comes from tin	with sound but not yet boiling	swings boiling until water is gone
-----------------	--------------------------------------	--------------------------------	---------------------------------------

**Choose several tins with different diameters. Measure the diameter of each tin and write it on the chart. Estimate the diameter of the fire or charcoal burner. To be sure the assumption is true, all of the tins should have diameters smaller than the hottest part of the fire.**

**If the heat source is a small hot flame like a paraffin pressure stove or a Bunsen burner, you can assume that all the heat supplied by the flame is reaching the bottom of the tin. Each sub-group should make a chart like the one shown above to collect their results.**

**Estimate the diameter of the area heated by the burner. Choose several tins with different diameters. To be sure the assumption is true, all of the tins should have bottoms larger than the area heated by the burner. Measure the diameter of each tin and write it on the chart.**

**In each tin, put the same amount of water that was used in Activity I-1. Note time or start the pendulum swinging. One person from each sub-group should be watching the watch or pendulum to keep track of how many seconds or swings of the pendulum it takes for the water to heat up and boil until it is gone. Put a tin on the fire.**

**Do you have any theory to explain the differences in time that you have measured?**

**Is the same amount of heat reaching the water in each tin?**

**Do you think the area of the bottom of the tin affects the time it takes for all the water to heat and change to vapor?**

**Do you think the area of the surface of the water affects the time it takes for all the water**

**to heat and change to vapor?**

**Can the results of another sub-group help you?**

**Do you need to do another experiment before you can be sure what affects the boiling time?**

**At the end of this activity, there should be agreement that water changes to vapor much faster when it is heated and boiled than when it is kept at room temperature. If the students have become involved in this activity, there may be argument as to which makes more difference in how quickly the water boils away: the diameter of the bottom of the tin, or the diameter of the surface of the liquid. You may decide to do the same activity again, using containers with walls that are not vertical. Some possibilities are frying pans, teapots, Erlenmeyer flasks, and tins where you have bent the walls inward so that the surface of the liquid is much less than the size of the bottom. Information gained by using these containers will allow the arguments to be resolved.**

### **Further Study**

**A thermometer is needed with a range that includes 100 centigrade and which has a heat-sensitive part that can be put into water.**

**Heat some water over a burner or small fire. As the water is heated, measure its temperature very close to the bottom, in the middle, and just below the surface. Take these three measurements every two minutes (about 84 swings of the pendulum). Make a note on your measurements to remember (a) when sound begins to come out of the liquid, and (b) when bubbles begin reaching the surface. Stop taking measurements eight minutes after the water begins boiling.**

**Make a graph of temperature in degrees centigrade versus time in minutes. Plot the three**

**measurements on the same graph. Also mark the times (a) and (b) on the graph.**

**Report your results to the rest of the class.**

**CAUTION: Make sure the heat source does not set you on fire. If you are using a glass thermometer, avoid resting its bulb on the bottom of the container because the heat may crack the glass. If you need something to lean it on while measuring the water temperature very close to the bottom, put a pebble in the container.**

### **Activity I-3B HEATING WATER**

**In this activity, a tin of water is placed over a small fire and heated. The water becomes hot enough to begin making a sound but not hot enough to boil. The fire or the position of the tin is adjusted to keep the water this way.**

#### **Materials**

**The materials and sub-groups are the same as in Activity I-3A.**

**Use the same amount of water in the tin as was used before.**

**The time that it takes for the water to disappear should be measured using a watch or by counting swings of the pendulum. The depth of the water should be measured at regular intervals such as every five minutes so that if all the water has not changed to vapor in the time you have available, an estimate can be made of how much more time it would have taken. (An alternative, if this happens, is to cover the tins tightly to keep the remaining water inside and continue the activity another day.)**

**As soon as each sub-group has their tin on the fire, have someone in the sub-groups make a chart like this. It will contain the results from this activity as well as some of the results**



**from previous activities. Be sure the students have all their previous results on hand the day you plan to discuss the results of this activity.**

### **Time Required for Water to Change to Vapor in Various Open Tins or Containers**

Diameter of tin in cm.	At room temperature	In the sun during the day	With water hot but not boiling	With water boiling
	(Act. I-1)	(Act. I-1)	(Act. I-3B)	(Act. 1-3A)

**Do you think that any of your water has changed to vapor?**

**What evidence do you have that some of your water has changed to vapor?**

**How much time did it take for half of your water to change to vapor?**

**How much time did it take for all of your water to change to vapor?**

### **Discussion of Activities I-3A and I-3B**

**Have the students fill in the parts of their charts that need information from previous activities if they have not already done this. Meanwhile, have a student make a large chart on the blackboard. Then have students from different sub-groups put some of their information onto the chart on the blackboard. When the chart is filled with their results, ask the students questions such as:**

**Which column refers to water that was kept at the coolest temperature?**

**Which water was hottest?**

**Which water was next-to-the-coolest?**

**Does there seem to be a relationship between temperature and rate of evaporation?**

**Can you establish a range of time in which you would expect water to change to vapor, for the conditions in each column of the chart?**

**A lot of discussion may arise if there are large differences of time within a column. For example, some of the tins kept in sunlight may have evaporated in half a day while others took two or three days. When the first activity was being done, the students were not asked to measure the temperature. However, some of the students may have noticed differences of temperature of the various tins kept in sunlight. Now that the students have more understanding of the relationship between temperature and the rate of change of liquid water to water vapor, some results which may have puzzled them should become clear.**

**By the end of this discussion, the students should agree that increasing surface area tends to speed up evaporation and that increasing temperature also tends to speed up evaporation. Also, decreasing either of these tends to make evaporation take place more slowly.**

**The following activities concentrate on changing water vapor to liquid water.**

**Activity I-4A CONDENSATION OF WATER VAPOR**

**It is hard to believe that something exists when you cannot see it, feel it or smell it. This problem exists with water vapor when it is completely dissolved in the air. When people see fog, or "steam", coming from the spout of a tea kettle, they are looking at a mixture of tiny droplets of liquid water mixed with air and with water vapor. It is the tiny droplets of liquid water that are visible. As soon as all the tiny droplets are dissolved in the air,**

**nothing is visible.**

**In this activity, the students heat water to produce water vapor. Then they collect some of the vapor on nearby surfaces.**

	Group			
	One	Two	Three	Four
Size of each sub-group	2	2	2	2
Bottles or jars made of clear glass, not colored glass	3	2		
Elastic bands that can stretch around the bottles or jars	6	4		1
Water	X	X	X	X
Sunlight	X	X		
Pieces of white paper, black paper such as carbon paper, and various other colors including metal foil if available	3	4		1
Lids or caps for bottles or jars, or use plastic and elastic bands	3	2		
Scissors or blades to cut paper and plastic	X	X		X

### Materials

	Group			
	One	Two	Three	Four
Candles or burners using paraffin or gas that can produce a small flame			1	
A heating stand to support each tin that is heated by a candle or burner (See Appendix H for a procedure for making heating stands from tins.)			1	
Matches			X	X
Drinking glasses			1	
Small pieces of wood to support the glasses			1	
Tins with small enough diameters to fit inside the drinking glasses. Each tin should be taller than the glass it is used with			1	
Tins of various sizes				1
Pieces of transparent plastic large enough to cover the tops of the tins used by Group Four				1
Several nails of different sizes for making round holes in tins (See Appendix B for a procedure to make a round hole in a tin.)				X
Watch or other timer	X	X	X	X

**Materials (cont. d.)**

**Divide the students into four groups. Students should stay in the same group for this activity and Activities I-4B and 4C. For each group, these three activities form a series. In discussions, each group will tell the rest of the class what they are doing and the results they have gotten. As was mentioned in Activity I-1, your class is probably large enough so that each group contains two or more sub-groups. For these three activities, most students may find it best to work in pairs. Look at Activities 4A, 4B and 4C now.**

**You may have to adjust how many sub-groups you have in each group based on the materials needed. For example, if you have many bottles, but only eight heating stands, and you have thirty-six students, you could divide the class as follows:**

Group	Number of students	Number of sub-groups
Group One	10	5
Group Two	10	5
Group Three	8	4
Group Four	8	4

**In this way, each sub-group in Group Three and Group Four would have a heating stand, yet all of the sub-groups would have only two students each.**

**The quantities shown in the materials list are what one subgroup needs. Multiply by the number of sub-groups you have. Items shown with an "x" can be shared by the class or by several sub-groups.**

### **Procedure for Group One**

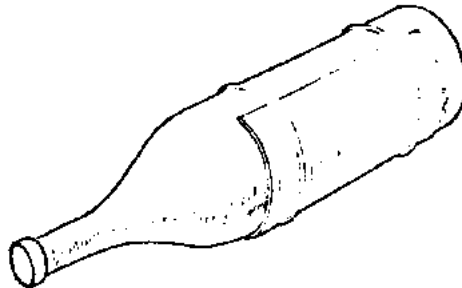
**Choose paper of different color for each bottle used. Each piece of paper will be attached to a bottle with two or three elastic bands. The height of the paper should be about the**

**same as the cylindrical part of the bottle. The width of the paper should be about half the circumference of the bottle.**

**Put a little water in the bottle and put a lid on it. Shake the bottle, then loosen the lid and let the water drip out. Tighten the lid. There should be some drops of water on the inside of the bottle.**

**Do you think the air inside the bottle contains a lot of water vapor or very little water vapor?**

**Dry the outside of the bottle and attach a piece of paper to the bottle. Put the bottle in the sun as shown in Diagram 2. Sunlight should reach both the paper and the part of the bottle that is not covered by the paper. Take note of the time so you can look at the bottle after five minutes, and again after ten and fifteen minutes. Do the same thing for each bottle.**



**DIAGRAM 2**

**What do you see inside the bottle after five minutes?**

**Has it changed any after another five minutes?**

**After fifteen minutes, take the bottle into the shade and examine the part of the bottle that was not covered by the paper. Then remove the paper and examine the part of the bottle that was covered by the paper.**

**Is there any difference between what is on the inside of the walls of the bottle in different places?**

**Can you feel any difference in the temperature of various parts of the bottle?**

### **Procedure for Group Two**

**Shake water in each bottle as is done for Group One. Then attach two pieces of paper to each bottle. The pieces should be of different colors such as red and green, black and silver, light green and dark green, etc. Each piece of paper covers half the cylindrical part of the bottle, as shown in Diagram 3. Sunlight should strike each piece of paper equally. The paper will have to be partially removed to look inside the bottle after five minutes. The position of each piece of paper on the bottle should not be allowed to change while this is being done.**



**DIAGRAM 3**

### **Procedure for Group Three**

**Choose a small tin and a drinking glass that can fit over the end of the tin, as shown in the**

**next diagram. Cut a hole in the top of the tin. Cut a small piece of wood so that it rests on the edges of the tin and supports the glass. Measure a small amount of water and put it into the tin. Heat the water with a small flame so the water is hot but not boiling. If there is a breeze, have the open part of the heating stand face away from the flow of air so the flame is disturbed as little as possible.**

**Place the glass over the tin. Note the time and look at the glass after five minutes, ten minutes and fifteen minutes.**

**Do you think the air inside the tin contains a lot of water vapor or very little water vapor?**

**What do you see inside the glass after five minutes?**

**Has it changed any after another five minutes?**

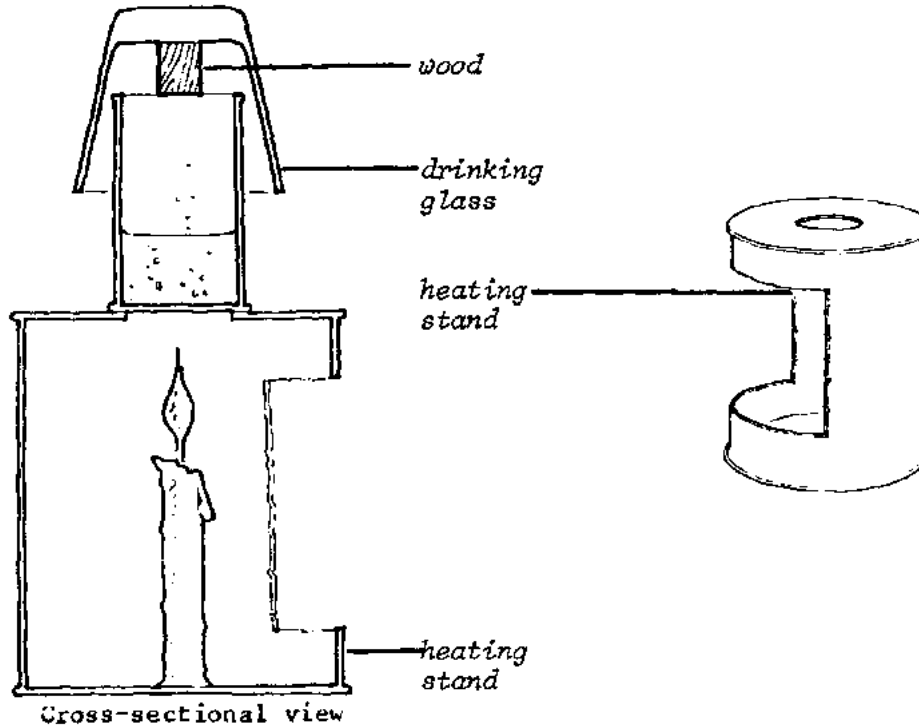
**Do you think there is any difference between the temperature of the glass and the temperature of the tin?**

**After fifteen minutes, examine the glass again and remove it from the tin. Measure the amount of water in the tin.**

**Did a measurable amount of water leave the tin?**

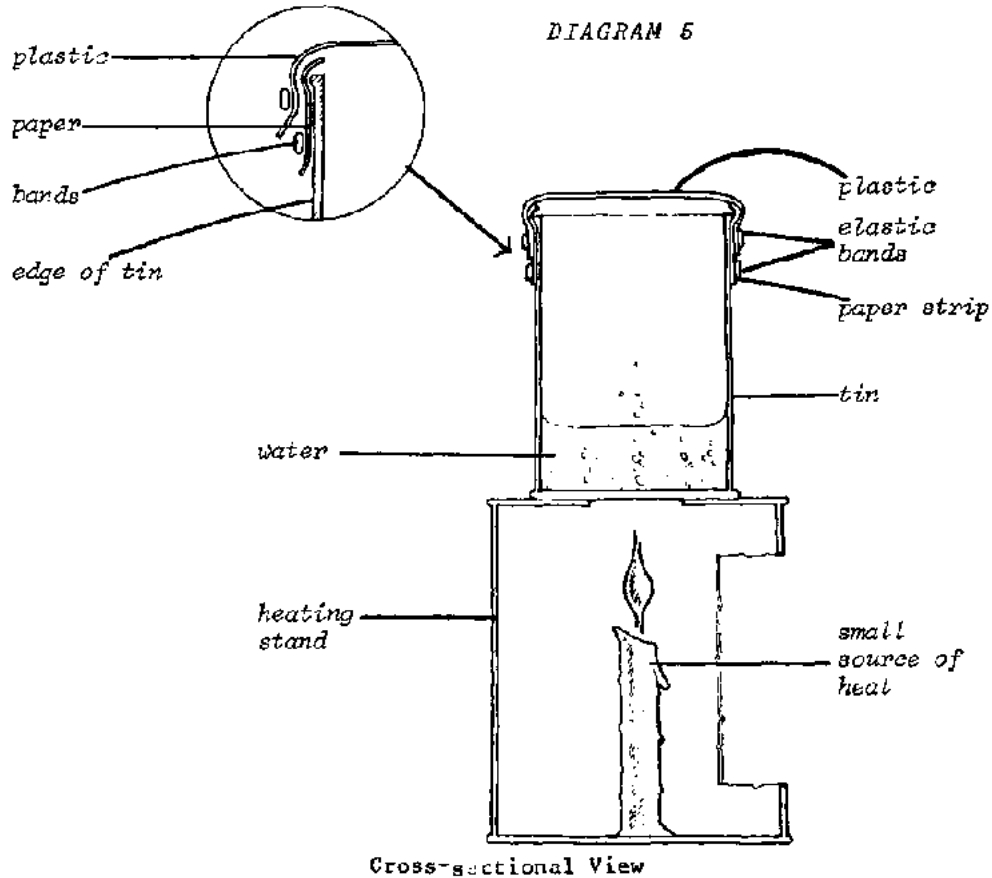
**If so, what percentage of the water changed to vapor and left the tin?**



**DIAGRAM 4****Procedure for Group Four**

**Choose a tin that has a height a bit greater than its diameter. Make a small hole in the side of the tin about 1 centimeter below the top. For this activity, the size of the tin is not**

**important, and the hole in the side does not need to be round. However, if you want to be ready for the next activity, use a tin that is large enough for a tea glass or very small tin to fit inside, and make the hole as round as possible, just large enough so the outer tube from a Bic pen can fit tightly in it. (A simple procedure for making a round hole of this size is found in Appendix B.) Cut a strip of paper about 1 centimeter wide and a little longer than the circumference of the tin. Attach it to the top edge of the tin with an elastic band. The top edge of the paper should be a little higher than the top edge of the tin. Measure a small amount of water and put it into the tin. Then put a piece of transparent plastic over the open top of the tin and hold it in place with an elastic band. The purpose of the strip of paper is to prevent the tin from melting the plastic when the tin is heated.**



**DIAGRAM 5**

**Heat the water with a small flame until the water is hot but not boiling. The heat should be adjusted to keep the water hot but not boiling throughout the activity. When the water becomes hot, take note of the time and look at the transparent plastic to see if any change has occurred. Look at the plastic again after five minutes, ten minutes and fifteen minutes.**

**Do you think the air inside the tin contains a lot of water vapor or very little water vapor?**

**What do you see inside the plastic after five minutes?**

**Has it changed any after another five minutes?**

**Do you think there is any difference between the temperature of the transparent plastic and the temperature of the tin?**

**After fifteen minutes, look at the plastic again and remove the heat. Take the plastic off the tin. Then measure the amount of water in the tin.**

**Did a measurable amount of water leave the tin?**

**If so, what percentage of the water changed to vapor and left the tin?**

**If there is enough time, each group can show the others their experiment. This will give everyone a change to know what each group has been doing. However, there are two more related activities to be done before the students will have enough information for a discussion in which they compare their results and summarize what they have learned about evaporation and condensation.**

### **Further Study**

**To the water add some color such as ink or use dark vinegar instead of plain water for all groups in Activity 4A.**

**Note which water is clear and which water is colored after about ten minutes.**

### **Teaching Method Alternatives**

**In the last activity, droplets of water formed on surfaces within a few minutes after starting the activity. Perhaps enough water collected on the drinking glass so that some drops fell off the edge of the glass. However, no effort was made to collect the water that condensed. In this activity, the equipment is adapted so the condensed water can be collected.**

**Depending on your educational objectives, you have a choice of methods in this activity and the next activity.**

**1. Student Investigation. Tell the students that they have a "design problem" to solve. The design problem is to find ways to collect the water vapor that is being produced. You should provide all of the materials that are on the materials list and anything else you have around that might be useful. This way of managing the class helps the students develop judgement and self-confidence in applying what they are learning. It is a useful approach to use when students are not soon facing external examinations. Some classes enjoy a contest:**

**Which group can produce the sun-powered device that collects the most water?**

**Which group can produce the flame-powered device that collects the most water?**

**Some of the students will not be able to think of anything on their own. You can suggest that they try something similar to what other students are preparing to do. You can also suggest one of the ideas shown in Activities I-4B and 4C, or ideas shown in the "distillation" section of science texts.**

**2. Guided Learning Continue with Activities I-4B and 4C as they are outlined here. This**

**way of managing the class reaches understanding of the science concepts more quickly than the student investigation method and is best for students who are required to cover all the material in the syllabus because they have to attempt an external examination at the end of the year. However, this method is not as effective in producing people who can put what they have learned to practical use after they have left school. This is because directions for what to do, and the pressure to do it, are being supplied by the teacher and the school. School leavers are left with little practice in deciding on their own projects, and then carrying them through, which are skills valuable in applying knowledge in real situations.**

**As much flexibility as possible for making decisions has been included in the directions for making equipment used in activities. Exact sizes are rarely specified. Judgement is therefore necessary to make equipment with proportions similar to what is shown in the diagrams, and learning experiences occur by seeing whose equipment works best and thinking about why differences in size may have caused differences in function. In these ways the guided learning method can develop some skills not ordinarily considered necessary while remaining acceptable to students, teachers and administrators.**

### **Activity I-4B CONDENSATION OF WATER VAPOR**

**If you use Method 1, the students will be occupied building and trying out the alternatives that they think of.**

**If you use Method 2, it will take only a short time for the students to get their devices working. Then there will be some time when they have nothing to do. During this time, you could have each group describe Activity I-4A to the rest of the students. Another thing you can do is to begin Activity I-5 which is about relative humidity. That activity requires very little equipment. Near the end of the time available, they will see how much water has collected, and will write down their measurements.**

	Group			
	One	Two	Three	Four
Size of each sub-group	2	2	2	2
Jars made of clear glass. Some of them must have the same size mouths.	1	2		
Elastic bands that can stretch around the jars	2	2		
Sunlight	X	X		
Pieces of paper of various colors, or a smoky flame or paint as used in the last activity	1	1		

### Materials

	Group			
	One	Two	Three	Four
Lids for the jars or use plastic and elastic bands	1			
Absorbent cloth such as from an undershirt or singlet or paper which is very absorbent	1	1		
Tes glasses or small tins that will fit inside some of the other jars and tins	1		1	1
Water	X	X	X	X
Blocks or pieces of wood to use as a support	1			3
Scissors or razor blades for cutting paper, cloth and plastic	X	X	X	X

Tins with a round hole in the side				1
Tins with a hole in the side, where the hole need not be exactly round			1	
Gandles or burners, and heating stands as used in the last activity			1	1
Tops from small tins to make a stand inside tins being heated, or small stones			1	1
Outer tube of Bic pen or hollow bamboo branch				1
Tins of various sizes				1
Pieces of transparent plastic to cover tops of tins			1	2
Small stones, coins or washers to use as weight at the center of plastic pieces			1	1
Matches			X	X
Watch or clock	X	X	X	X

### Materials (cont'd.)

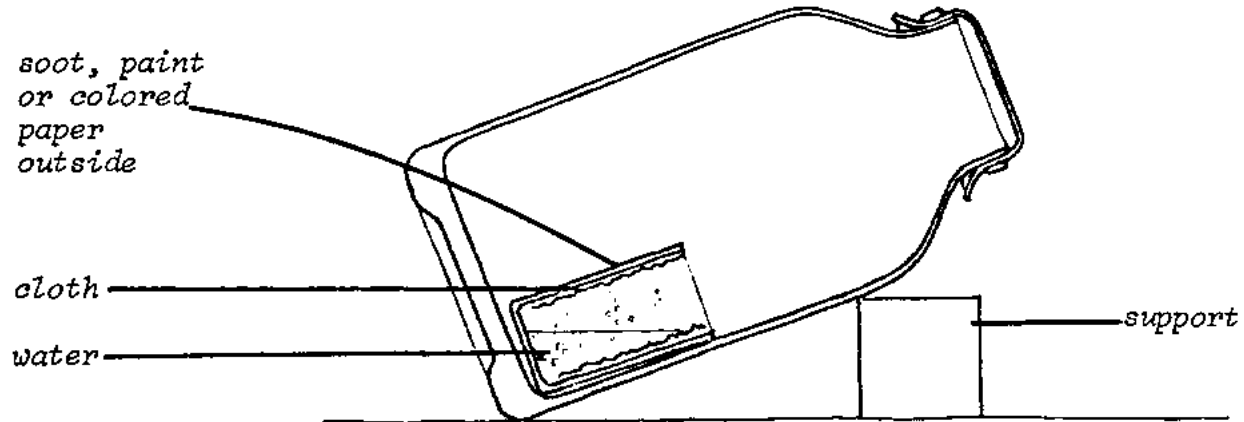
**In this activity each group uses equipment that is quite similar to what they used in Activity I-4A, but this time the water vapor condenses into droplets that are collected in a separate container.**

### Procedure for Group One

**A tea glass or a very small tin is placed inside a jar. The outside of the tea glass or small tin is coated or painted or covered with paper of whatever color the students have decided works best. A measured amount of water is placed inside the tea glass or small tin. Then a piece of very absorbent paper or cloth is placed so it sticks to the inside wall of the glass or tin. Cloth that makes a good wick works well. One part of the cloth or paper should be in the water. Another part of the cloth or paper should be under the part of the glass or tin**



**that will be heated the most by the sun. The students will place the tea glass or tin inside the jar and cover the jar with its lid or with plastic held by an elastic band. The inside of the jar should be dry when this is done.**



Cross-sectional view

**DIAGRAM 6**

**Without spilling any of the water from the glass or small tin, carefully place the jar in sunlight. Note the time. Near the end of the time available, have the students examine the jar.**

**Did any droplets of water collect on the inside of the jar?**

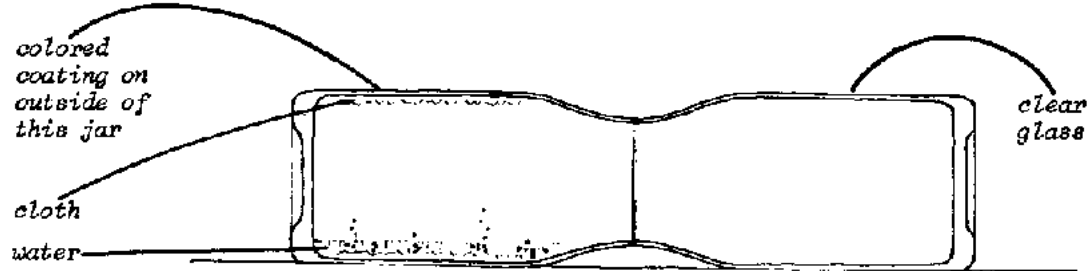
**Did enough water collect to accumulate at-the bottom of the jar?**

**If so, what percentage of the water changed to vapor and then condensed on the jar?**

**The students should record the amount of time the jar was in sunlight and the amount of water that collected in the jar, if it was enough to measure. They should also note any other details so they will be able to describe what happened.**

### **Procedure for Group Two**

**Two jars are placed together so they form one container. Their mouths must be about the same size.**



Cross-sectional view

**DIAGRAM 7**

**If the mouths are not quite the same size, something such as clay or cloth can be stuffed into the gap. If only a few jars are available, one jar and one tin can be used.**

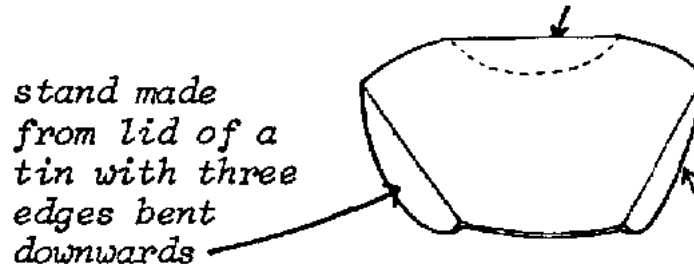
**Prepare one of the jars or the tin the same way that the tea glass or small tin was in the Group One activity, with water and a wick inside, and colored paper or other coating outside.**

**Place the two jars, or the jar and the tin, in sunlight with their mouths together. Note the time. Near the end of the time available, examine the jars.**

**The questions to ask and the measurements to make are the same as for Group One.**

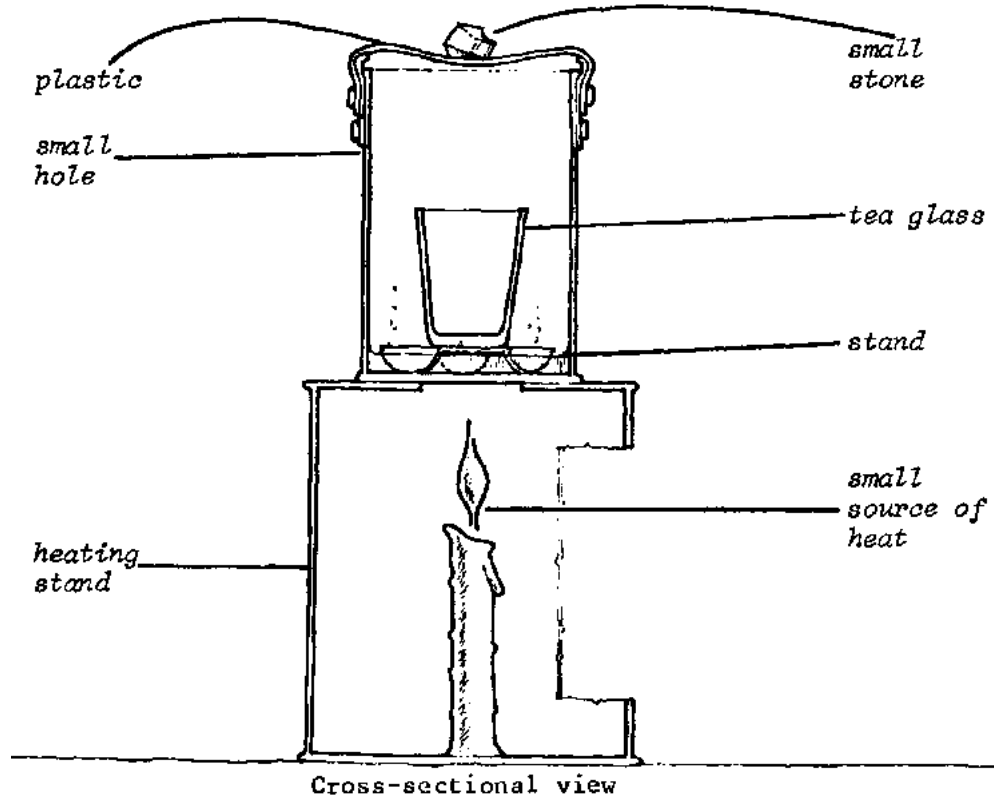
### **Procedure for Group Three**

**A tin with a measured amount of water is heated with a small flame. Inside the tin is a tea glass or a tiny tin, supported by a stand. The stand can be made from the top of another tin. It should have a somewhat smaller diameter than the tin it is placed in. Bend the edge of the tin top in three places as shown in Diagram 8. Three small stones inside the tin can be used as a stand also.**



**DIAGRAM 8**

**Make a hole near the top of the tin. It doesn't have to be round. Attach a paper strip and a piece of transparent plastic to the tin, as was done in Group Four in Activity I-4A. At the center of the plastic, put a coin or a small stone so that the plastic is lower at the center than elsewhere.**

**DIAGRAM 9**

**Heat the water with a small flame until the water is hot but not boiling. The heat should be adjusted to keep the water hot but not boiling throughout the activity. When the water**

**becomes hot, take note of the time.**

**Near the end of the time available, the students should record the time that the water has been hot and remove the heat.**

**Did any water collect in the tea glass?**

**How did it get there?**

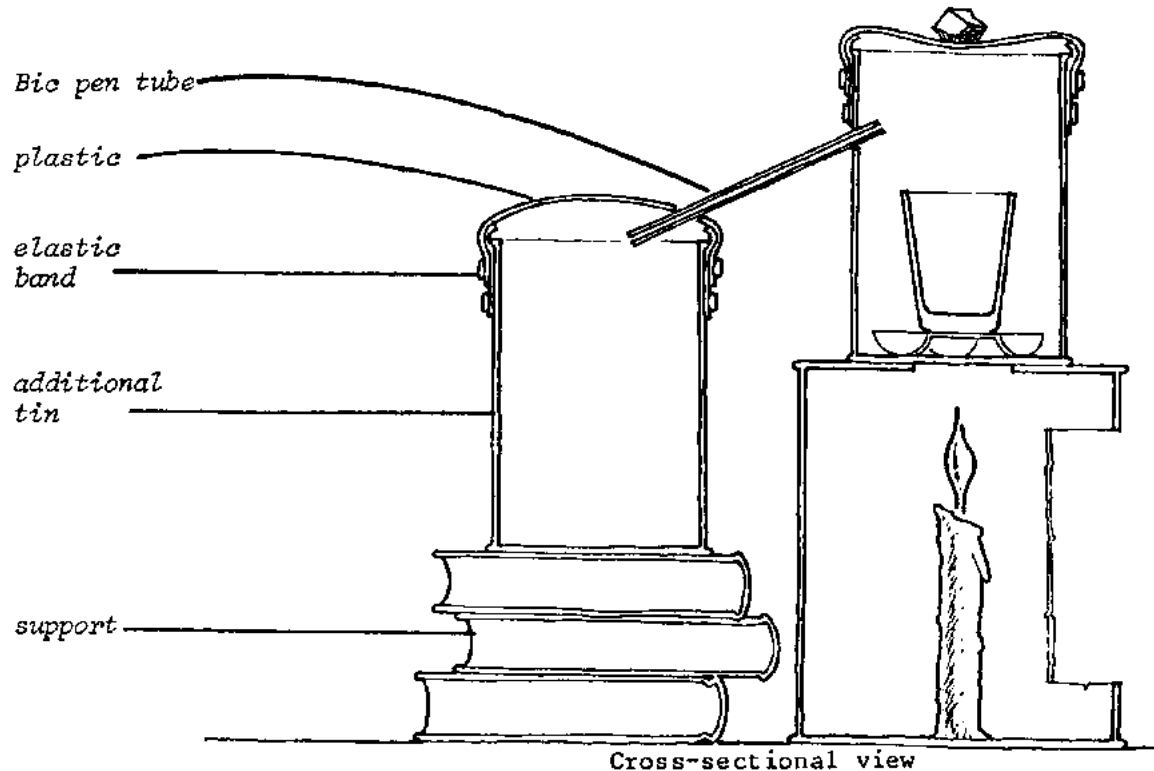
**What percentage of the water you started with is now in the tea glass?**

**What percentage of the water you started with remains at the bottom of the tin?**

#### **Procedure for Group Four**

**Some things are added to the equipment that was used by this group in Activity I-4A. The same heating stand and heat source with a small flame is used. If the tin used the last time has a round hole, and you have a tea glass or a very small tin that can fit inside, it is suitable for use in this activity. Make a stand to support the tea glass, or use three small stones. Fit the outer tube of a Bic pen into the hole in the side of the tin. A hollow bamboo branch can also be used, but it is not as good because you can't see inside it. The other end of the tube passes through a hole in a piece of transparent plastic which is attached to the top of another tin with an elastic band. This hole should be a little bit bigger than the tube so that air can escape from the tin as the system is heated and the air inside it expands.**

**Put a measured amount of water in the tin on the heating stand. Place the tea glass on its support inside the tin. Attach the paper strip around the top edge of the tin with an elastic band. The plastic should be a little loose in the middle so a coin or a small stone will keep the middle lower than the edges.**

**DIAGRAM 10**

**Heat the water with a small flame until the water is hot but not boiling. The heat should be adjusted to keep the water hot but not boiling throughout the activity. Note the time when the water becomes hot. Near the end of the time available, note the time and remove the**

**heat.**

**Did any water collect in the tea glass?**

**Did any droplets form inside the tube?**

**Are there any droplets of water in the tin at the other end of the tube?**

**How much water remains in the bottom of the tin you heated?**

**How much water is in the tea glass?**

**Is there a measurable amount of water in the other tin? If so, how much water is there?**

**Do these amounts add up to what you started with?**

**Unless the students are eager to have a discussion, continue with Activity I-4C first. Tell the students to keep good records of their results so that comparisons can be made in the discussion after Activity I-4C.**

**Further Study**

**1. Add some salt to the water.**

**Taste the liquid which has condensed after about ten minutes to see whether the salt was transferred together with the water vapor.**

**2. Use vinegar instead of water.**

**Taste the liquid which has condensed after about ten minutes to see whether anything was transferred together with the water vapor or not.**

**Activity I-4C CONDENSATION OF WATER VAPOR**

**In this activity, Group One and Group Two continue to use sunlight as their source of heat while Group Three and Group Four use somewhat larger flames than before.**

	Group			
	One	Two	Three	Four
Size of each sub-group	2	2	2	2
Access to the outdoors	X	X		
Shovels or other tools for digging holes in the ground	X	X		
Trays or dishes able to hold water		3-6		
A smoky flame for coating some of the trays or dishes with soot		X		
Small glass jars or drinking glasses	1	1		
Sunlight	X	X		
Pieces of transparent plastic larger than used before	1	1		
Stones to hold down the edges of the plastic	X	X		
Small stones to use as weight at the center of plastic pieces	1	1		
Water	X	X	X	X
Measuring spoons, bottle caps, rulers, etc. to measure amounts of				

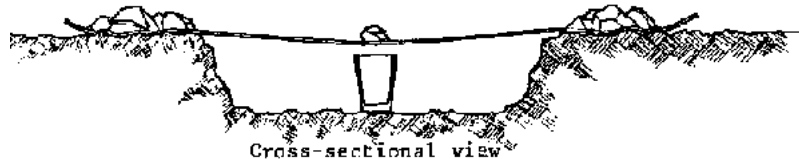


water collected	X	X	X	X
All of the materials used in Activity I-4B by Group Three and Group Four, except that the burners must now be hot enough to boil the water gently			X	X
Watch or clock	X	X	X	X

### Materials

**Procedure for Group One Dig a shallow hole almost as large as the piece of transparent plastic you have. The area of the top of the hole should be somewhat smaller than a square meter but preferably more than 1/4 of a square meter. If the plastic you have comes in-a roll only about 1/4 of a meter wide, you can sew two or three strips together to get a piece that is approximately square.**

**Sprinkle a measured amount of water on the soil at the bottom of the hole. Put a glass or jar at the center of the hole. Place the plastic over the hole. Use stones and soil to hold down the edges so air does not blow under the plastic Put a small stone on the plastic above the glass. The plastic should be loose enough so the center is lower than the edges. Note the time. Near the end of the time available, note the time again.**



**DIAGRAM 11**

**Did any droplets form on the plastic?**

**Is there any water in the glass?**

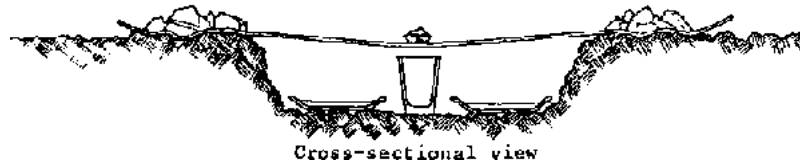
**If so, how much water is in the glass?**

**What percentage of the water you sprinkled in the hole is now in the glass?**

**If possible, put the glass and the plastic back and leave it until the sun is not shining on it anymore. Then measure the amount of water that has collected in the glass again.**

### **Procedure for Group Two**

**Prepare a hole and plastic the same as used by Group One. Put several trays or dishes into the hole. Use dishes of various colors. Coat one dish with soot if you do not already have a black dish. Measure the same amount of water that Group One sprinkled in their hole. Put this water in the dishes so each dish has an equal portion of the water. Place a glass or jar at the center of the hole. Put the plastic over the hole. Use stones and soil to hold down the edges of the plastic so air is not blown into the hole by the wind. Put a small stone on the plastic above the glass. Be sure the plastic is loose enough so the center is much lower than the edges. Take note of the time. Near the end of the time available, note the time again.**



Cross-sectional view

**DIAGRAM 12**

**Did any droplets form on the plastic?**

**Is there any water in the glass?**

**If so, how much water is in the glass?**

**What percentage of the water you put in the dishes is now in the glass?**

**How much water remains in each dish?**

**If possible, put the glass and the plastic back and leave it until the sun is not shining on it anymore. Then measure the amount of water in the glass again. Also measure the amount of water, if any, remaining in each dish.**

**Procedure for Group Three**

**All the materials are the same used in Activity I-4B, except the flame, which is larger. Heat the water until it begins to boil and note the time. Adjust the flame to keep the water boiling throughout the activity, but be careful the Bic pen tube is not heated so much by heat coming up next to the tin that it melts. Use the same amount of water that you used in Activity I-4B. Near the end of the time available, note the time and remove the heat.**

**How much water collected in the tea glass?**

**What percentage is this of what you started with?**

**How much water collected in the other tin?**

**What percentage is this of what you started with?**

**How much water remains in the bottom of the tin that was heated?**

**What percentage is this of what you started with?**

**What percentage do the three of these percentages add up to?**

**What percentage of the water was lost?**

**Did the temperature of the second tin change while water vapor was condensing in it?**

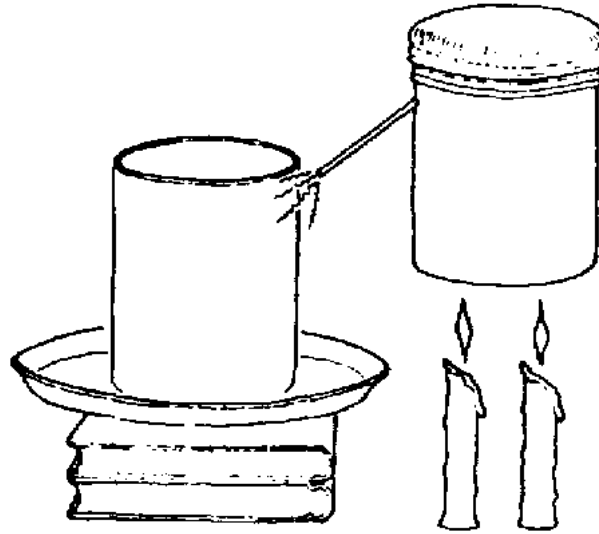
**For the discussion that follows, the students will need to use the results they have gotten during these last three activities. They may also need to refer to their results from some of the earlier activities. Remind the students to have all of their records in class for the discussion.**

### **Further Study**

**1. If you have a room where the windows can be closed so that there is very little breeze, it is recommended that some of the students do this activity and report their results to the rest of the class.**

**Use the Group Four equipment but with the second tin standing on a dish, and the end of the Bic pen tube almost touching the side of this tin.**

**Put the tin on the dish after the water is boiling, and keep it there for ten minutes. Do this three times: (a) put cool water in the second tin, (b) put warm water in it, (c) put very hot water in it.**



**Figure**

**After each ten minutes, measure the amount of water that has collected in the dish. Have the students discuss possible reasons for different amounts of condensed water.**

**2. Use the Group Four equipment, but aim the Bic pen tube into various other containers such as a tea kettle. Use each container for ten minutes. Compare the water collected in the different containers tried. Feel the temperature of each container after vapor has been coming into it for a few minutes. In this activity the water should be boiling during the ten minutes that each container is being tried.**

### **SUMMARY**

**As a result of doing the various activities, and sharing their results in the discussions, the students by now should feel familiar with a number of procedures and concepts.**

**The procedures include measuring liquids by volume, measuring surfaces using square measure, measuring time, noticing differences in temperature, measuring temperature (if thermometers are available), computing rates of change, keeping records of results, making comparisons where differences in quantitative results are important, and making predictions or decisions using knowledge from previous experimental results.**

**The concepts include evaporation, water vapor, condensation, rates of change, the sun as a source of heat, and area. Also cool, warm, hot and boiling as they apply to water.**

**For some students the procedures may also have included looking for suitable equipment and bringing it to class, deciding which items to use from a supply of different sizes and shapes of tins, jars, pieces of plastic, etc., adjusting heat sources to maintain a certain rate of heating, using the sun as a source of heat, improving ways of collecting heat from the sun, approximating the surface area of solid objects, making graphs of results, using a pendulum as a timer, measuring temperature with a thermometer, and considering the flow of heat in a system.**

**For some students the concepts may also have included evaporation as a way of reclaiming something that is dissolved in water (salt), evaporation as a way of cooling something (burlap refrigerator), condensation as a way of heating something, and distillation as a way of obtaining pure water from water that has things dissolved in it.**

#### **Discussion of Activities I-4A, 4B, and 4C**

**As outlined in the summary, there is a core of procedures and concepts that all the students have been exposed to. Then there are additional procedures and concepts that some students have learned. The discussion should be a time when students in each group**

**strive to explain clearly to the rest of the class what they did and what happened. It is also a time for students who did further activities to tell the class what they did.**

**You may decide that the students' results can be best compared by using a chart similar to that available during the last discussion. Some of the students may be able to develop the necessary headings for such a chart, or you can develop one or more charts based on your knowledge of what the students have been doing.**

**If the class understands exactly what happened in each case, questions about similarities and differences in results should come up, and discussion will be lively. However, while a certain group is describing an experiment, in order to clarify the situation for the rest of the class, you may have to ask all the questions that you asked them during the activity. This helps to improve the communications skills of the students.**

**It is sufficient at this time for most of the students to know what happened in most of the activities. In the discussion at the end of Part I, the students should be able to make generalizations about the major concepts they will have learned.**

### **BACKGROUND INFORMATION ON RELATIVE HUMIDITY**

**The ability of air to hold water vapor can vary a lot throughout the day and night. This is because the amount of water vapor that a given amount of air can hold is related to the temperature of the air. For each 10 degrees centigrade that air is warmed, its capacity to hold water vapor increases by about 100 percent. Similarly, for each 10 degrees centigrade that air cools, its capacity to hold water vapor is halved. If there is dew at night, the air is being cooled to a temperature where some of the water vapor it holds condenses onto plants and other objects. At that time, the air is saturated with water vapor, and the relative humidity is 100 percent. (when the air is holding all the water vapor it can, its relative humidity is 100 percent. Air containing no water vapor would have a relative humidity of 0 percent.)**

**Consider a situation where the daytime maximum temperature is 10 degrees centigrade higher than the minimum temperature at night, and where dew forms at night. In this situation, the capacity of the air to hold moisture is doubled when the air is warmest, compared to when it is coolest. If no additional moisture is added to the air as it heats, its relative humidity would now be 50 percent. However, most of the moisture deposited at night as dew changes to vapor again when the air becomes warmer, so part of the capacity of the air to hold water vapor is used up. Therefore, the actual relative humidity at the maximum temperature in this example is somewhat greater than 50 percent.**

**Now consider another situation. At certain times of year in some desert areas, the temperature goes down to about 5 degrees centigrade at night, and dew forms. The daytime temperature rises to about 45 degrees centigrade. If no additional moisture is added to the air as it heats, its relative humidity as the temperature rises would be as shown in this chart:**

### **Comparison of Temperature to Relative Humidity**

Temperature (degrees centigrade)	Relative Humidity (percent)
5	100
15	50
25	25
35	12(1/2)
45	6(1/4)

**However, most of the moisture deposited on the sand at night as dew changes to vapor again when heated by the sun, so part of the capacity of the air to hold water vapor is**



**used up. Therefore the actual relative humidity in this situation at 45 degrees centigrade is somewhat more than  $6\frac{1}{4}$  percent.**

**In both of these examples, the relative humidity reaches 100 percent when the temperature becomes cool. The evidence that the relative humidity reaches 100 percent is the dew, which forms when the air has more moisture than it can hold. The more the temperature rises in the daytime, the lower the relative humidity.**

**If dew forms in your locality at night, you can get an idea of what the minimum relative humidity could be in the daytime by measuring the usual high and low temperatures. Early in the morning the temperature is approximately the same as the lowest it may have been during the night. The high temperature can be measured around midday. These temperatures should be measured outdoors in the shade.**

**Evaporation is slow if the relative humidity is near 100 percent and faster if the relative humidity is low. Air that has gained some extra water vapor by being in contact with the surface of water has higher relative humidity than it had before. If this air is moving away from the water and is being replaced by drier air, evaporation is faster than if the same air stays near the water for a long time.**

### **Activity I-5A EVAPORATION AND TEMPERATURE**

**In this activity, students investigate what happens when water evaporates without any heat being applied. The human body's ability to sense differences in temperature is used to detect whether any change of temperature takes place.**

#### **Materials**

**Sub-group size: Students can work individually or in sub-groups. All the students follow the same procedure.**

**A bowl or basin for each six to eight students**

**Fans**

**Pendulum or watch for timing**

**Water to fill the basins**

**Sunlight or another way of warming the water**

**Dip your hand in water that has been out in the sunlight. Does it feel warm? Remove your hand from the water. Does your hand feel warm now? Swing your hand around while it is still wet. Does it still feel warm? When your hand dries, swing it as you did before. Does it feel the same as before? If you get both hands wet, hold one still and move the other one around. Which hand feels warmer? If you use a fan to move air to your hand, does it dry faster than when you don't fan it? How much time does each hand take to dry? Which makes your hand dry more quickly: fanning or swinging? Which makes your hand feel cooler?**

### **BACKGROUND INFORMATION ON HEAT FLOW DURING EVAPORATION AND CONDENSATION**

**After Activity I-3A, there is a Further Study which requires a thermometer. If you were able to do this activity, you saw that the temperature of water does not rise above a certain level (somewhere between 90 degrees centigrade and 100 degrees centigrade) when heat is supplied. Instead, the water boils. Water vapor is produced very rapidly, and it requires a continuous supply of heat. If you take away the heat, the boiling stops. If you put the heat back again, the boiling resumes, but the temperature of the water stays the same. How can the temperature stay the same when heat is being supplied? One way to answer this question is to think of the heat as being removed by something. It is being**

**removed by the process of making water vapor from liquid water.**

**In Activity I-4C, as done by Group Four, the tin at the end of the Bic pen tube became warm. Some of the water vapor condensed on this tin. Heat was being supplied to the tin by the process of making water from water vapor. This is the opposite of the situation just discussed. When water condenses it adds heat to the materials it is in contact with.**

**If the relative humidity was close to 100 percent when your students were swinging their wet hands in the air, they would have had difficulty noticing any difference of temperature between their wet hands and their dry hands. Without any evaporation, there is no cooling taking place due to having a wet surface exposed. The lower the relative humidity is, the easier it is to notice the cooling, because more evaporation is taking place. When water evaporates it removes heat from the materials it is in contact with.**

**In some localities with a hot climate, a small quantity of drinking water is kept in a slightly porous clay pot. Some of the water seeps through the walls of the pot, and evaporates from its surface. The cooling effect of this evaporation keeps the water in the pot noticeably cooler than water kept in an ordinary container. In the same way, the human body cools itself by sweating. Spoiling of fresh foods may be retarded by surrounding them with wet cloths. The water in the cloth evaporates, and cools the food a little bit.**

**Drying of clothes is usually done in whatever way is most convenient and effective. Thus, they are put in sunlight in clear weather, and often hung near a fire in damp, rainy weather. If there are dry seasons and humid seasons in your locality, it would be interesting to compare the time it takes clothes to dry, if you keep all other conditions the same. For example, hang the clothes away from sunlight or fire, and where there is no breeze. The only remaining difference is the relative humidity of the air.**

### **Activity I-5B EVAPORATION AND TEMPERATURE**

**If you have a thermometer, or if you can make a device that responds to fairly small changes in temperature and which is not destroyed by getting wet, do this activity. (See Appendix E for suggestions on developing these devices.) It enlarges upon Activity I-5A, and provides interesting results to compare if you can do it in dry weather and in wet weather.**

## **Materials**

**Thermometers or homemade temperature sensing devices**

**Water**

**Cloth**

**Fans**

**This can be done as a demonstration if you have only one thermometer or by sub-groups if you have many thermometers or temperature sensing devices. Everyone follows the same procedure.**

**Hang the thermometer in the shade or indoors and let it adjust to the correct temperature for a few minutes. What is the reading? With a fan, wave air towards the thermometer for a couple of minutes. Does the temperature change? Now wrap a small piece of wet cloth around the bulb of the thermometer. Leave it alone for a few minutes. Is the temperature different from when there was no cloth? If there is a difference, is the wet temperature higher or lower than the dry temperature? What is the reading? Fan the wet cloth for the same amount of time you fanned the dry thermometer before. Does the temperature change? What does it read now? If it changed, fan the wet thermometer again, until its reading stops changing. Compare the differences in temperature.**

### **Discussion of Activities I-5A and I-5B**

**After Activity I-5B has been completed, have the students discuss their findings. They should compare these results with what they found when they moved and fanned their wet and dry hands in Activity I-5A. Also, Group Four should remind the other students of Activity I-1 where tins containing water and covered with cloth were placed in sunlight. Some pieces of cloth were wet, and some were dry. It should now be possible to understand what took place in that activity.**

### **Further Study**

**If a wet-dry bulb humidity table is available, some study of humidity can be done. Relative humidity should be measured at various times of the day. It would also be useful to measure it at various times of the year: during dry months and during wet months.**

**Discussion should correlate humidity with how people feel, as well as with what plants are growing during different periods. This study could be part of an expanded weather studies program.**

### **Activity I-6 COMPARISON OF WEIGHT AND VOLUME OF FRESH AND DRIED FOOD**

**This activity uses concepts from previous activities to study how food dries. Equal arm balances or other means for weighing are needed. Weighing is also done in Activities II-1 and 2, and in measuring sulfur in Part III. Also, when the results of full size dryers are evaluated, the wet weights and dry weights of the food dried will be required.**

**The students may not be familiar with weighing. They could obtain practice by building equal arm balances, making a set of weights, and weighing various small objects. If you decide to have the students build equal arm balances, the instructions in Appendix F can be used. Appendix G shows ways of making improvised sets of weights.**

**This activity also involves determining volume by displacement of water. If some students do not know this method of finding volume, this activity can serve as an introduction.**

**Materials**

**Piece of a large firm vegetable such as potato or cassava**

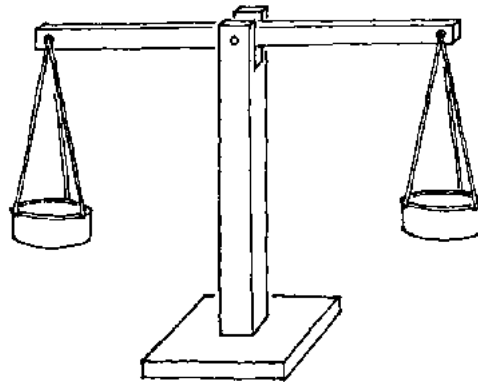
**Straight sided jar at least 6 cm in diameter**

**Equal arm balance or other device for comparing weights**

**Cloth which air can circulate through**

**Tray, dish, or piece of pasteboard**

**Knife to cut potato**



Example of  
equal arm balance

**DIAGRAM 13**

**Razor blade or scissors to cut paper**

**String**

**1 cm grid sheets**

**Water**

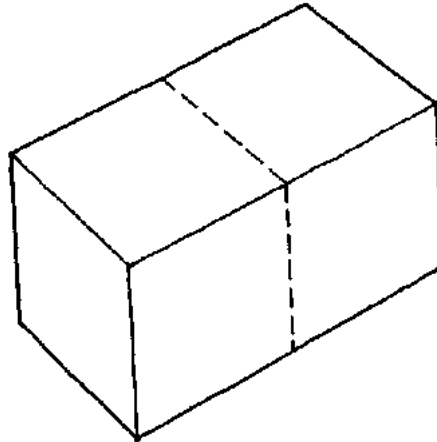
**Pencils**

**Ruler**

**Each sub-group should have one set of materials. Weighing equipment can be shared.  
Direct the students as follows, or hand out work sheets.**

**Cut three pieces of potato in cubes, 4 cm on a side. Weigh each cube. Do they weigh about the same? If not, cut them so that all three are the same size, 4 cm on a side with equal weights.**

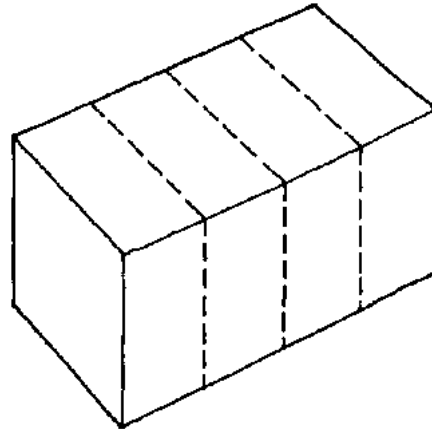
**Cut one piece in half so that you have two equal pieces. How big is each piece? Measure the half pieces. How big is each edge?**



**DIAGRAM 14**

**Cut one 4x4x4 piece into 4 equal pieces so that each piece measures 1x4x4.**



**DIAGRAM 15****Weight**

**Weigh each piece of potato on a balance. Does one  $4 \times 4 \times 4$  piece equal two  $2 \times 4 \times 4$  pieces? Does one  $4 \times 4 \times 4$  piece weigh the same as four  $1 \times 4 \times 4$  pieces?**

**Volume**

**Fill a jar half full of water and mark the water level with string. Then put one  $4 \times 4 \times 4$  piece of potato in the water, and mark the water level. Remove the potato. How many cm and mm did the water rise?**

**Put one  $2 \times 4 \times 4$  piece of potato in the jar. How many cm and mm did the water rise? Put the other  $2 \times 4 \times 4$  piece in the water. Did the water rise to the same level as with the  $4 \times 4 \times 4$  piece? Remove the pieces from the water. Now put one  $1 \times 4 \times 4$  piece in the water and measure the water rise. Then add another  $1 \times 4 \times 4$ . Does the water rise the same amount?**

**Add the third  $1 \times 4 \times 4$  and measure the rise. Add the fourth piece of  $1 \times 4 \times 4$ . Do four of the small pieces of potato change the water level the same as one big piece ( $4 \times 4 \times 4$ )?**

### **Area**

**Wipe all the potato pieces dry. How many sides does the  $4 \times 4 \times 4$  cube have? Put the cube on a grid sheet and trace around each side. When you have traced around all of the sides, count the squares you have traced around. This is how many sq cm the cube of potato has on its surface. If you put the cube down on the table how many surfaces can you see without lifting the cube? How many sq cm of the surface can you see?**

**Now count the sides on a  $2 \times 4 \times 4$  piece of potato. Trace around each surface of the piece on the grid paper. Count the number of sq cm the surfaces of the piece covered. How many sq cm are there on the surface? What is its area? When the  $2 \times 4 \times 4$  piece is sitting on the table, with the large surface upward, how many surfaces can you see without lifting the piece?**

**Put the  $4 \times 4 \times 4$  piece and the two  $2 \times 4 \times 4$  pieces on the table with the large surfaces upward. Which has more area that you are able to see? One  $4 \times 4 \times 4$  or two  $2 \times 4 \times 4$  pieces?**

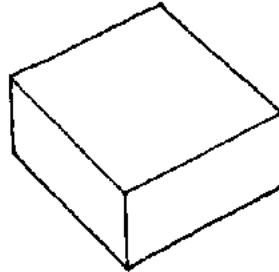
**In the same way as with the larger pieces, count the surfaces of the  $1 \times 4 \times 4$  pieces and trace around each surface of each of the four  $1 \times 4 \times 4$  pieces. Count the number of sq cm of surface on all four  $1 \times 4 \times 4$  pieces. Also calculate the number of sq cm that are exposed to the air if the four pieces are put separately on the table.\***

**\*Note: If the students have trouble conceptualizing the connection between area of grid paper and area of potato pieces, cut the grid paper out and pin it on the faces of the potato cubes.**

**Stack the  $1 \times 4 \times 4$  pieces. What is the surface area exposed? Remove one piece from the**

**stack and put it on the table. How much more area is exposed than when all four were stacked? Remove another piece from the stack and put it separately on the table. How much more area is exposed now?**

**How can a  $4 \times 4 \times 4$  piece be cut to give more surface area than by cutting four  $1 \times 4 \times 4$  pieces?**



**DIAGRAM 16**

### **Drying and Surface Area**

**on a large tray or dish or piece of pasteboard, place one  $4 \times 4 \times 4$  piece of potato one  $2 \times 4 \times 4$ , one  $1 \times 4 \times 4$ , and any others you have decided to try. Measure these new pieces so you know their sizes and weights. Put the tray in a place where it will not be disturbed, and cover with cloth. Leave it a few days. What do you think will happen to the pieces of potato? Will they all be the same? How will the size and surface area affect the changes?**

### **Teaching Method Alternatives**

**While waiting for the pieces of potato to dry, begin the next activities. Activities I-7, I-8A, I-8B, and I-8C are written as if everyone in the class will be doing the same thing on a particular day. However, you may decide to have certain students build the devices to be**

**used in Activities I-8A and I-8B right away. These devices are for measuring angles. If you decide to do this, consider now whether or not you want the class to do Activity I-9. In Activity I-9, the students make a device to condense water using the heat of the sun so that pure water can be obtained from contaminated water. It is then operated at various angles to find the angle at which the most water is produced. However, it requires woodworking skill to build this device, so you should select students with this in mind. Students who are not building any devices should begin with Activity I-7A, and should then do the other activities as soon as the devices are finished.**

### **Discussion of Activity I-6**

**When the pieces of potato have dried, have the students report on their findings. This should include the weight of each piece wet and dry, how much time each piece took to dry, which pieces dried and which pieces if any spoiled. The volume of each dried piece should be approximated and compared with the volume of the piece before drying.**

**During the reporting of findings, you should note the extent to which the students apply any of the concepts they have been exposed to so far.**

**At the end of the discussion, encourage the students to think of suggestions about how food drying may be done best. Tell them that after they do some more activities, they will have a chance to try out their suggestions. Have the students make a list of the suggestions they make now so they can be used in later discussions.**

### **Chapter 2. Sun and air**

**The activities in this section emphasize the use of the sun's heat energy. They begin with observations of surfaces heated by radiation from the sun. Attention to the use of black surfaces to absorb radiant heat is continued. The activities also explore the angle of a surface relative to the sun, and the effect of this angle on heat absorption. A familiarity**

**with the measurement of angles is needed. This offers an opportunity to collaborate with a math teacher.**

**The students will construct a box for condensing water, and maximize the amount collected by controlling the angle between the sun and the black material at the back of the box. Finally, activities studying how air moves when it is heated lead to the construction of food dryers in Part II.**

### **BACKGROUND INFORMATION ON ENERGY FROM THE SUN**

**The sun continuously gives off large amounts of energy which travel through empty space as radiant energy. A small amount of this energy reaches the earth, and some is absorbed by the atmosphere. The sun's energy exists as a continuous spectrum of different kinds of energy from radio waves to light, heat, ultraviolet and x-rays.**

**On a clear day, most of the sun's heat energy passes through the atmosphere and is absorbed by the surface of the earth. Dark colored materials absorb most of the heat energy that strikes them, while light colored materials reflect much of the heat and light energy that strikes them. Energy that strikes materials directly, perpendicular to their surface, is the most concentrated as it is spread over only a small area. Energy striking a surface obliquely is spread over a larger area and therefore less energy is absorbed per unit of area. The greatest absorption of radiant energy then is by a dark colored surface that is at a right angle to the source of energy (sun).**

**These principles are used in devices which collect solar energy to make that energy usable to people. These devices can be used to gather heat energy from the sun to cook, bake, dry, heat water, distill water, produce electricity, produce steam and do other useful things.**

**Because the earth is tilted, it receives more energy on one half than on the other. During**

**the months of September through March, the half of the earth south of the equator receives the sun's energy more directly and is heated more than the Northern Hemisphere, From March to September, the northern half of the earth receives energy more directly and is heated more than the Southern Hemisphere. This unequal heating of the earth's surface leads to some areas becoming warmer. Air above these regions is heated by touching warm land and oceans.**

**This air expands due to warming and is pushed upward by heavier, cooler air. This rushing of cool air to replace lighter warm air is the wind. The energy in the wind comes from the sun, and can be used to do work.**

**Heat, a kind of energy, moves from something of higher temperature to something of lower temperature in three ways:**

- 1. Conduction - heat moves from one substance to another substance that is touching the first substance.**
- 2. Convection - one fluid material heats and expands, causing it to rise and carry heat to other areas.**
- 3. Radiation - heat energy moving through space that is absorbed finally by a material.**

**At the conclusion of Part I, the students will be able to:**

- 1. name the three ways that heat moves from something of higher temperature to something of lower temperature.**
- 2. vary the factors affecting absorption of heat to increase or decrease the amount being absorbed in a system they have built.**

**3. describe what happens in a convection box heated by the sun, including radiation, conduction, and convection in their description.**

### **Activity I- 7 RADIATION**

**Some materials that have sat in the sun absorb more heat and feel hotter than other materials. Which materials collect the sun's heat efficiently?**

#### **Materials**

**Sub-group size: Two or three students. All the sub-groups follow the same procedure.**

**1 Smoky flame for coating tiles and tins with soot, such as a candle or a paraffin burner**

**3 Clay tiles, bricks, or blocks molded from soil taken from termite mounds**

**Thermometer or other method of measuring temperature (see Appendix E)**

**Flat glass or clear plastic sheet**

**2 Tins of the same size**

**Matches**

**Water**

**White paint, cassava paste, or whitewash**

**Watch or other timer**

**If you have only one thermometer, one person can circulate among the sub-groups to**

**make the temperature measurements. Soil from termite mounds can be mixed with water and molded into blocks if other clay tiles or bricks are not available. Each sub-group should have three tiles: one that is coated on one surface with soot from a candle flame; one that is coated with whitewash, white paint or paste made from cassava or a similar food starch; and one that is left uncoated. These tiles should be kept in a shady place for a few hours before the activity, where their temperature will not have been raised by exposure to sunlight.**

### **Procedure for All Sub-Groups**

**Set the three tiles out in the sun with the colored surfaces upwards. Take the temperature of the tiles when you first put them out. After thirty minutes, take their temperature again. Which tile became the warmest? While measuring the temperature, stand so the thermometer and the tile are in the shade of your body. If the thermometer receives heat directly from the sun, it gives a false reading. Thermometers should be stored in the shade because it is possible for them to become too hot and break if the temperature reading goes beyond the maximum.**

### **Further Study**

**Take the temperature of each block at ten minute intervals. Make a time vs. temperature graph for heating of the blocks.**

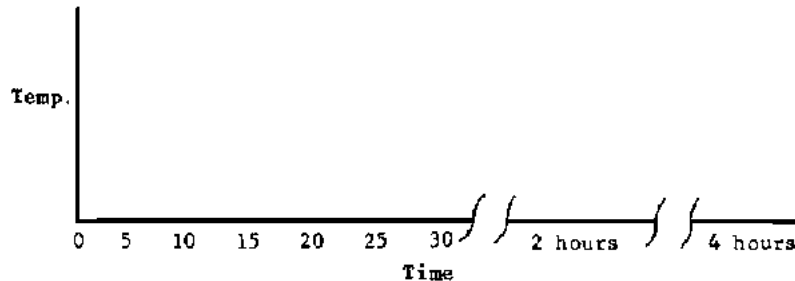
**While the blocks of clay are lying exposed to the sun, each sub-group should gather two tins of the same size. One tin should be covered with soot from a candle, one should be left shiny. Fill each tin to the top with water and take the temperature of the water. Place the tins in the sun, after five minutes take the temperature. Record the temperature in a table like this:**

Water Temperature at Five Minute Intervals
--



	0	5	10	15	20	25	30
Shiny Tin							
Black Tin							

**Record the temperatures every five minutes and write them in the table. Continue recording the temperature for thirty minutes. Leave the tins in the sun and measure the temperature again after two hours and, if possible, after four hours. What is the highest temperature reached? Draw a graph from the temperature recorded on the table.**



**Water Temperature vs. Time in Sunlight**

**Which tin absorbs the most heat? Which tile absorbs the most heat?**

### **Further Study**

- 1. Lay several pieces of cloth out in the sun. Some dark colors, some light colors, After a few minutes feel them.**
- 2. Put a band of dark cloth around one arm or leg. Put a band of light cloth around the other arm or leg. Lie town in the sunlight for a short time.**

**Which colors absorb the most heat?**

**Which colors are not good absorbers?**

**Which colors reflect the most sunlight? The least sunlight?**

**(The reflection is judged by the brightness of the cloth when you look at it in sunlight).**

**Sometime during the class period, put your hand in sunlight, then put your hand behind a piece of glass or clear plastic so that the sun shines through the clear material onto your hand. Does your hand feel warmer or cooler behind the clear material? Does the clear material stop all the sun's heat? Part of it? None of it? The air also is mostly clear on a sunny day. Do you think the air stops much of the sun's heat from coming to you? Do clouds stop the sun's heat from reaching you?**

**Discuss your results with the other sub-groups.**

### **Activity I-8A MEASURING THE ANGLE OF SUNLIGHT**

**Discuss: At what time of the day is the sun highest in the sky? How high does the sun get? Does the sun get higher in some seasons than in others? How can we measure how high the sun gets in the sky?**

**Caution You can damage your eyes by looking at the Sun. you can use the following device to measure the angle of elevation of the sun without looking at it directly.**

#### **Materials**

**6 pieces of wood, bamboo or reed**

**Newspaper or other large paper**

**Hammer**

**Nails or pegs and a drill**

**Heavy paper or cardboard for making a protractor**

**Stone, bolt or similar for weight**

**2 tins with both ends cut out**

**String**

**Saw or knife**

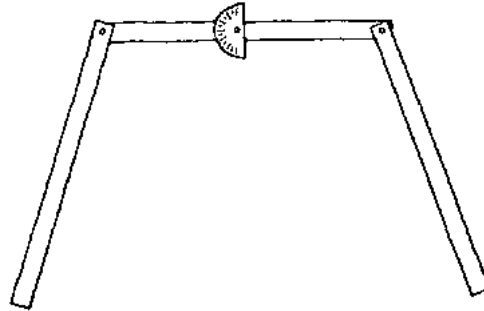
**Protractor**

**Heavier stones, bricks or logs**

### **Activity I-8A BUILDING AN ANGLE MEASURING TUBE FOR SUNLIGHT**

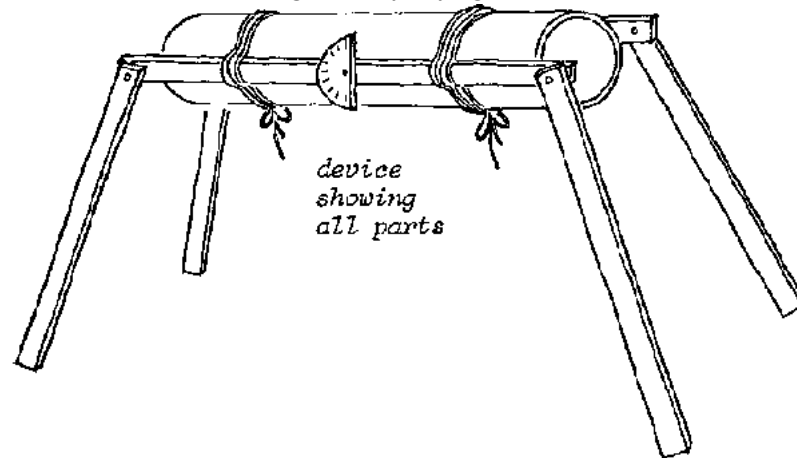
**Make a roll of newspaper by rolling the paper around two tins from which both ends have been cut out. You should be able to see down the center of the roll. Tie the roll with string to keep it from unrolling. Cut six pieces of wood 10 cm longer than the roll of paper. Hammer a thin nail or peg into one piece of wood 2 cm from the end, then drive the nail into a second piece U of wood, also 2 cm from the end. The pieces of wood should be able to rotate. Nail a third piece of wood to the other end of the first piece in the same way. Nail the other three pieces of wood together in the same manner. Make a copy of a protractor on a piece of cardboard. Nail the cardboard protractor to the middle of one of these, as shown in Diagram 17. Make the straight edge run at right angles to the piece of wood, with the 90° mark centered on the piece of wood. Hammer a small nail into the protractor at the center of the straight edge of the protractor. It should stick out about**

**one centimeter because a string with a weight will be tied to it as shown in Diagram 19.**

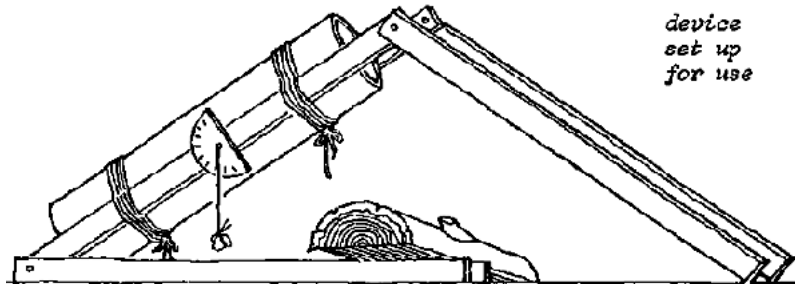


**DIAGRAM 17**

**Tie the roll of paper onto the two center pieces of wood with string as shown in Diagram 18. Cut another piece of string as long as the distance from the protractor to the end of the center piece of wood. Tie a weight to the string, and tie the other end onto the nail.**

**DIAGRAM 18**

**Weight the lower legs down with stones, bricks or logs. Move the front legs in and out, aiming the tube toward the sun until sunlight can be seen when your hand is held at the bottom of the tube. Measure the angle of elevation above the horizon by reading where the weighted string crosses the protractor.**



**DIAGRAM 19**

**Using this device, measure the angle of the sun throughout the day. Each sub-group should use this device until everyone is familiar with the measurement of angles. Alternately, each sub-group could build one device. The device can be used at different times of the year - seasons - for weather studies.**

**Further Study**

**Mount a mirror at the bottom of the tube between the pieces of wood for viewing the moon and stars as part of a unit on studying the skies. The device can be used to measure the elevation of heavenly bodies.**

**Activity I-8B MEASURING THE ANGLE OF SUNLIGHT**

**What angle is the best for heating?**

**Materials**

**Tiles or bricks used in Activity I-7**

**A smoky flame**

**Matches**

**Thermometers**

**Square pieces of cardboard for making protractors**

**String**

**Washers or bottle tops for weights****Small nails****Pieces of wood a little longer than one side of the square cardboard****Protractors****How to Make an Elevation Angle Measuring Device**

**Draw a protractor on a square piece of cardboard. Attach a piece of wood to the cardboard as shown in Diagram 20. The nail at the center of the straight side of the protractor should stick out, so the string with a weight at the end can swing freely from it. If a bottle top is being used as a weight, hammer a small hole in it using a nail. Adjust the length of the string so the weight does not reach the edge of the cardboard in any position.**

**To use this device, hold a straight edge of the cardboard against the surface whose angle is to be measured. The string crosses the edge of the protractor to show the number of degrees away from the horizontal the surface is.**

**This is the elevation angle of the surface. For example, if held under a table, the reading should be 0 degrees. If held against a wall, the reading should be 90 degrees.**

**After everyone is familiar with measuring the elevation of the sun, the way the sun heats surfaces which are set at different angles to the sunlight can be investigated. The results of Activity I-7 show that dark surfaces absorb more heat than light surfaces. Now, blacken one surface of each tile with soot from a smoky flame. Before putting the tiles in sunlight, measure and record their temperatures. Bring the tiles out in the sunlight and tilt one so that it faces the sun directly. With an elevation angle measuring device, measure the angle of the tilt. It should be at right angles to the sunlight. The elevation angle measuring**

**device should show an angle 90 degrees different than the angle measuring tube for sunlight shows on its protractor.**

**Another tile can be laid flat on the ground. How many degrees from the horizontal is it? Stand one tile straight up. Use rocks to hold it upright. How many degrees from the horizontal is this tile? Put another tile with its edge facing the sun. How many degrees is it from the tile which faces the sun?**

**Which tile do you expect to heat best? Which one do you expect to be heated least? After several minutes, measure the temperature of the tiles with a thermometer or feel them with your hand. Which tile is heated the most? Almost as much? The least? Is this what you expected? How would you explain this to another student?**

### **Activity I-8C MEASURING THE ANGLE OF SUNLIGHT**

**Why do surfaces facing the sun directly heat better than surfaces at an angle to the direct rays?**

#### **Materials**

**1 cm grid paper**

**Angle measuring tube**

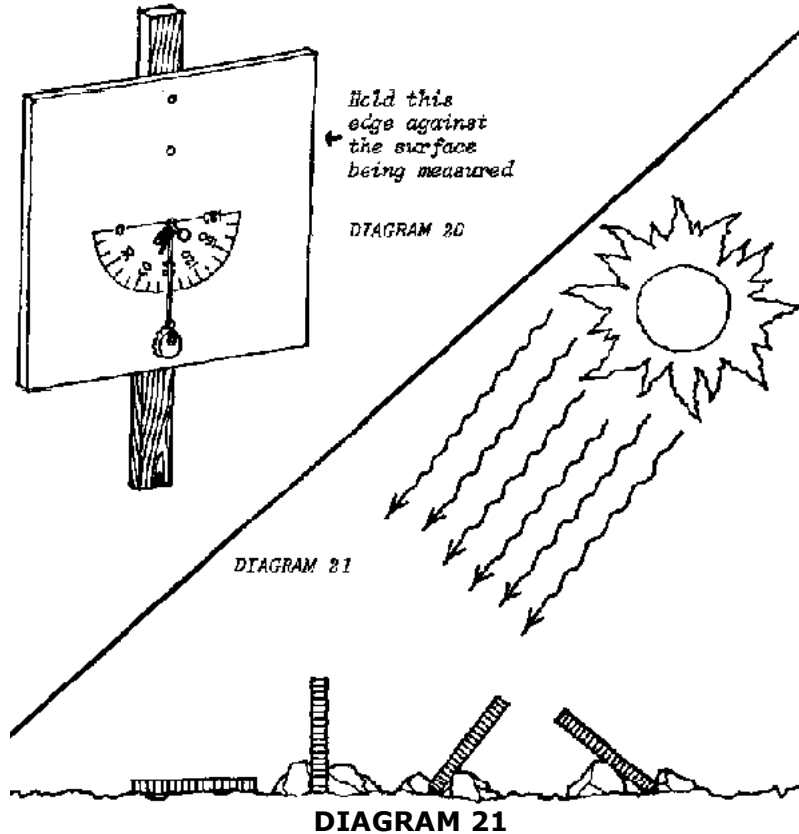
**Protractor**

**Flat cardboard rectangular pieces**

**Tape**

**Angle measuring devices**





### Procedure for All Sub-Groups

**Tape a sheet of 1 cm grid paper to a board, book or other flat rigid object. Tilt the grid**

**paper to face the sun directly at the angle measured by the angle measuring tube. Place a rectangular piece of cardboard smaller than the grid paper over the grid paper. Tape the cardboard along one edge so that the edge lines up with one grid line. Trace the cardboard outline onto the grid paper. Count the number of square cm the cardboard covered. Measuring with a protractor, lift the cardboard rectangle  $20^\circ$  from the grid paper and trace the edge of the shadow. Count the squares that are inside this line. Did the shadow of the cardboard cover more or less grid paper than when the cardboard was flat? Did the cardboard tilted at  $20^\circ$  catch more or less sunlight than when it was flat? Measuring with a protractor, tilt the cardboard up at a  $40^\circ$  angle from the paper. Trace around the shadow's edge. Is the area covered by this shadow more or less than at a  $20^\circ$  angle? Tilt the cardboard at a  $60^\circ$  angle and trace the shadow. How many square cm of sunlight does the cardboard catch at a  $60^\circ$  angle? Do the same for  $80^\circ$ , then  $90^\circ$ . Refer back to the tiles in Activity I8B. Which tile was heated most in the sunlight? Why did one heat more than the other? Discuss the results with the other groups. How would you explain this to other students?**

### **Further Study**

**Stand in front of the cardboard and grid paper so that the shadow of your head is on the cardboard. You are looking now at the cardboard from the same way the sun does. Put the cardboard flat on the grid paper. Have somebody else lift it up by a free edge. Which way do you see more cardboard? Which way do you see less cardboard? How can you tilt the cardboard so that you do not see any of the surface? At which angle would the cardboard heat best from the sun? Why? Report your findings to the class.**

### **Activity I-9 USING THE SUN TO PURIFY WATER**

**The preceding activities have shown the relationship between the angle at which the sun strikes a surface, the color of the surface, and the heating of the surface by the sun's rays.**

**The following device uses the sun's heat to evaporate water. The water condenses on a flat piece of glass that is heated less than the dark surface below it. Water runs down the glass surface, which is sloped, and is collected in a trough. Water is fed into the box by a tube leading from a container of contaminated water. This device calls for a greater degree of woodworking skill than previous activities. Some of the construction could be done in the woodworking class, collaborating with the woodworking teacher. The basic design presented can be modified to fit the local materials, tools and woodworking skills. The box may be made as large as desired, limited by the size of glass or clear plastic available to cover the top surface.**

### **Materials**

**4 pieces of wood, making the sides of the box, planed and sanded, sealed if possible.**

**Boards, making the bottom.**

**Bamboo tube, about 2 cm diameter, 5 cm longer than the width of the box.**

**Nails**

**Hammer**

**Metal shears or chisel**

**Clear plastic or glass, making the top.**

**Crack sealer: use what is available.**

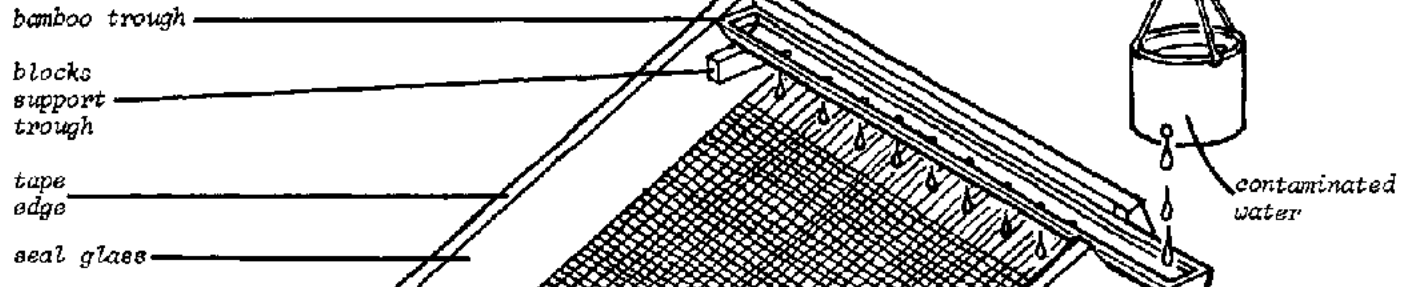
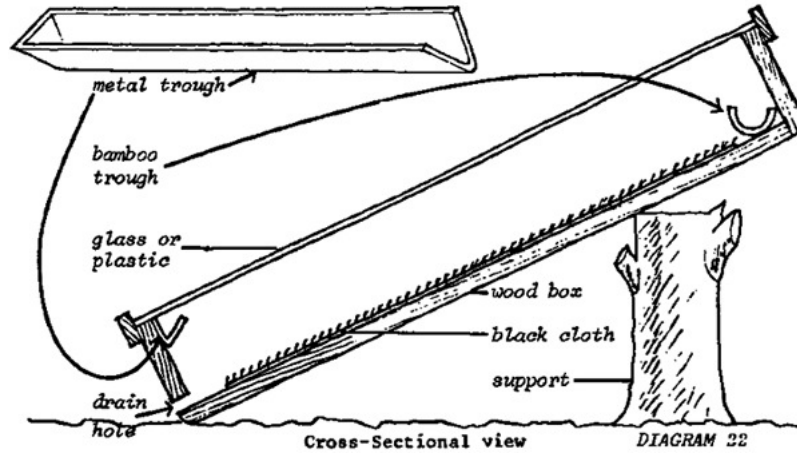
**Black cloth, covering the bottom**

**Large tin and a piece of a large tin**

**Saw****Drill****Tape**

**The bottom of the box may be made with tightly fitted and sealed boards or it may be covered with plastic sheeting nailed tightly to seal the bottom. Over this some dark cloth is nailed. A hole is bored in one side at the upper end for the bamboo trough. The tube is cut in half to serve as a trough for water to enter the still. Small holes are bored in the bamboo trough so the water will drip down onto the cloth. Water in the supply tin drips through a tiny hole into the trough. Small blocks nailed to the inside of the box hold the bamboo trough in place. The collector trough for fresh water at the lower end is made from metal from a large tin. It is cut with metal shears and bent to form a V - shaped channel. It is nailed to the lower end of the box with the metal set tightly against the wood so that no leakage will occur between metal and wood. The end of the metal trough may be set tightly against the wood, or it may have a piece of metal soldered over the end to form a water-tight end.**

**The other end is open for pure water to drip into a container for collection. The metal trough passes through a hole bored in the side of the box. A small hole is bored in the lower end of the box, below the metal trough, for extra contaminated water to run out. When all the parts are installed, glass cut to size or clear plastic sheeting slightly larger than the top of the box is fastened onto the box. The plastic can be nailed over the edges. Glass can be set on top with small blocks of wood nailed on the sides of the box, projecting up to keep the glass from sliding off. Then the glass may be taped to keep it sealed. See additional Diagram 23.**



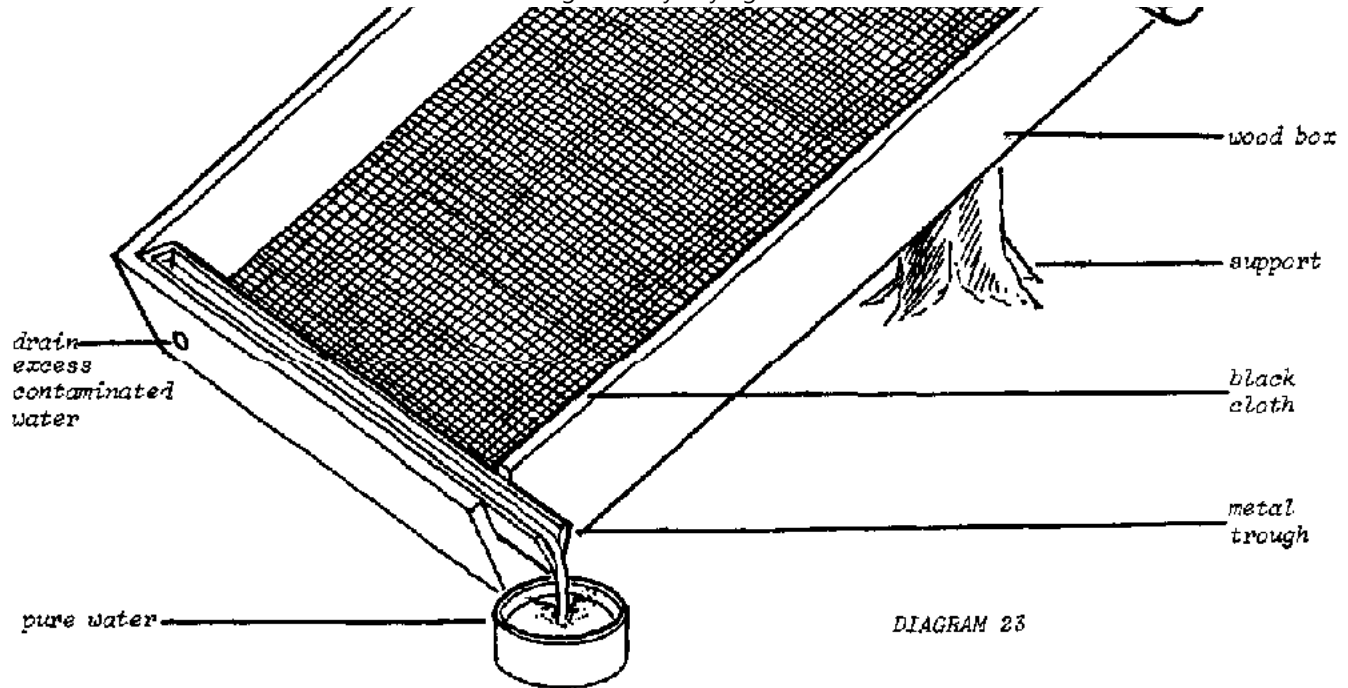


DIAGRAM 23

## BACKGROUND INFORMATION ON CONDUCTION AND CONVECTION

Energy reaches us from the sun by radiation. By now, the students have used this source of heat energy a number of times. In the last several activities, the students learned that to collect radiant heat energy effectively, its direction has to be taken into account. They also found that dark colored surfaces absorb radiated heat better than light colored

**surfaces.**

**Heat energy is often transferred from one substance to another by conduction. If the two substances are touching each other and have different temperatures, the cooler substance will become warmer as it receives heat from the hotter substance. A table becoming warm beneath a teacup is an example of heat being transferred because substances are in contact with each other. The tea warms the cup by touching it. The cup warms the table by touching it. Movement of heat by conduction is studied in Activity I-10.**

**If one of the substances involved in transfer of heat is a liquid or a gas, movement within the liquid or gas takes place while its temperature changes. This movement, which is called convection, is studied using air as the gas that moves, in Activities I-IIA and I-IIB.**

**Activity I-10 CONDUCTION**

**In this activity, the students use the body's ability to sense differences in temperature to study conduction.**

**Materials****Tins****Sources of heat such as charcoal burner or flame.****Table or floor not in sunlight.****Stones****Watch or other timer**

**Heat the stones on the charcoal burner or flame. While this is being done, everyone should**

**note if the tins and table feel warm or cool. One or two hot stones are put in each tin, and the tins are placed on the table or floor, and not moved. After about 5 minutes, feel the tins and the table underneath it. Are they warmer or cooler than before? Are the stones warmer or cooler than before? Where has heat moved in this activity?**

### **Teaching Method Alternatives**

**Experiments are provided for each of the four groups in this activity concerning convection.**

**Depending on how your class is working, you have a choice of two alternatives for teaching convection.**

- 1. Have the sub-groups in each group do the experiment outlined for them here. If by now the students are able to communicate effectively with each other when each group explains to the rest of the class what they have been doing, this procedure will work well.**
- 2. If you feel that communication between groups has not been effective, it is suggested instead that each experiment should be done by all the groups. The equipment required to do this would not be much more than would otherwise be needed, since the same equipment can be used by different groups on successive days.**

### **Activity I-11A CONVECTION**

**In this activity, how heat is transferred by convection is studied, and a device is built that could function as a small food dryer using air heated by the sun.**



	Group			
	One	Two	Three	Four
Students in each sub-group	3	3	3	3
Pieces of paper about 20 cm by 25 cm	3		6	
Elastic bands or string	2			
Thin wire	1			
Small stones	1		5	
Source of heat such as a charcoal burner or fire	X	X	X	

### Materials

	Group			
	One	Two	Three	Four
Scissors or blades to cut paper	1	1	1	1
String or braided cotton that produces smoke when glowing	1	1	1	1
Hot charcoal		1		
Small boxes made of paper, pasteboard or wood; or tubes made from paper		1		
Stands made from tin lids to support hot charcoal		1		
Candle		X		
Common pins		8	20	8
Small boxes made of paper or pasteboard with open top				1
Black ink or paint				1
Transparent plastic				1
Matches	X	X		
Pendulum or watch	X			

### Materials (cont'd.)

#### Procedure for Croup One

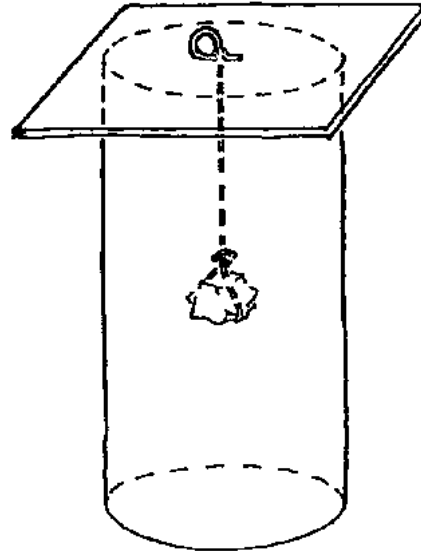
**Make a tube from paper about 6 to 8 centimeters in diameter and about 20 centimeters in length. The wall of the tube should have a thickness of not more than 2 or 3 layers of**

**paper because in this activity the students will feel the temperature of the air inside the tube. Tie the tube together with several elastic bands or pieces of string. A small stone that has been heated in a fire will hang from the roof of the tube by a thin wire. Make the roof strong enough to support the wire, but thin enough so the temperature of the air inside can be felt through the paper. Folding a piece of paper twice is one way to make a suitable roof.**

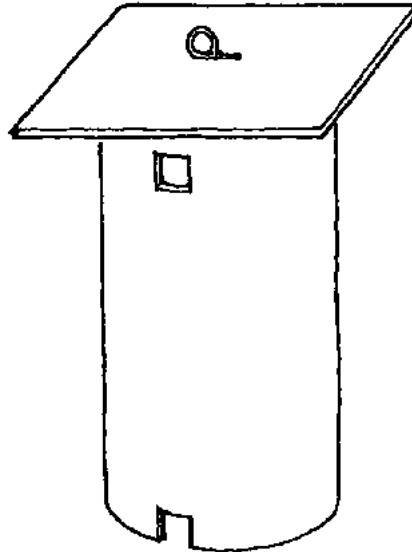
**Attach a thin piece of wire to the small stone. Measure enough additional length of wire so that the stone will hang about half way down the tube. Put the stone with the wire attached on the fire. It should become as hot as possible. Place the tube in as little breeze as possible. Attach the end of the wire to the center of the roof. Lower the stone into the tube until the roof rests on the end of the tube. The roof must be flat and rest on the end of the tube so that there are no holes for air to pass out of the tube.**

**After about two minutes, feel the tube at the bottom, the middle, the top, and on the roof. Write down whether the tube feels cool, warm, or hot in each of these places. Were you surprised by the temperature of the tube in any of these places? Repeat the any or activity if everyone did not have a chance to feel the tube, or if there are any disputes about what parts of the tube were cooler or warmer.**

**Now cut a small opening at the top and bottom of the tube. Each opening should be about 1 square centimeter. Heat the stone. Light one end of a piece of string or braided cotton so that it glows and produces smoke but not a great amount of hot air.**



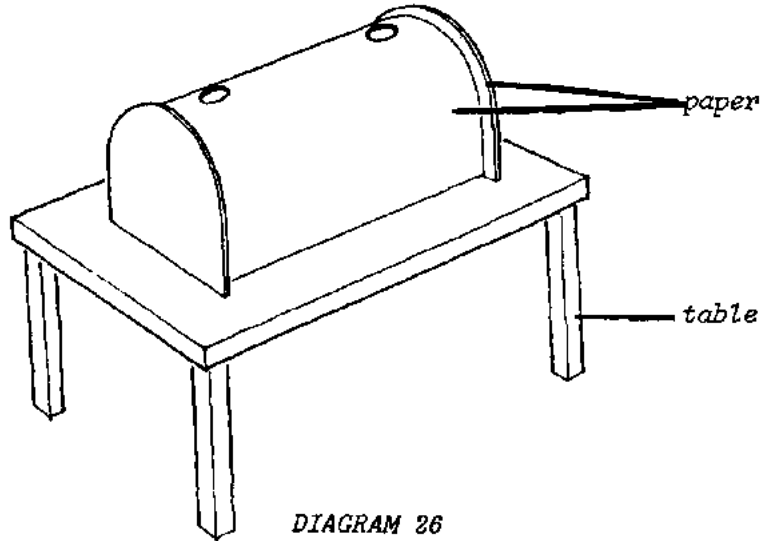
**DIAGRAM 24**

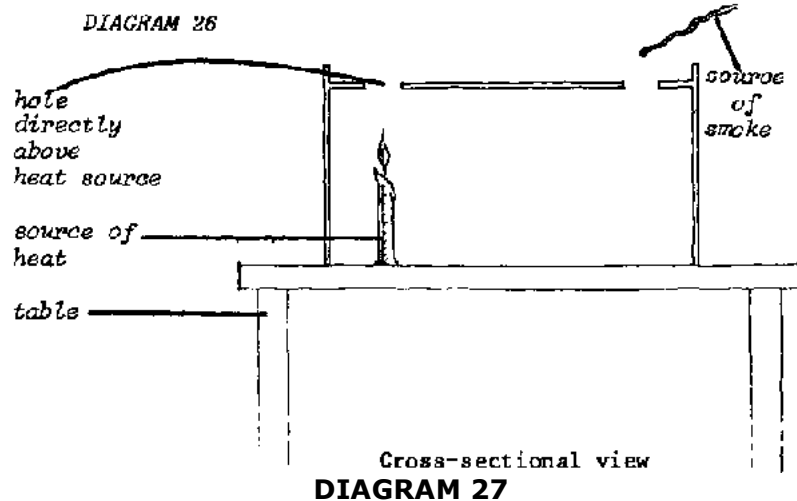
**DIAGRAM 25**

**Put the stone in the tube. Hold the smoking end of the string at the bottom opening in the tube, and then at the top opening in the tube. Try putting it just inside each opening, and just outside each opening. Watch what the smoke does. The way the smoke moves shows how the air is moving. In what direction is the air moving? Make a diagram showing how the air flows. Note: If you are doing this in a breeze, it may be impossible to see the smoke. Try using a larger source of smoke and replacing the hot stone with a piece of hot charcoal. Take precautions for fire because the charcoal may burn the tube.**

**Procedure for Group Two Do the same experiment as is done by Group One, except use a box. If it poses a difficulty to make boxes, you can make tubes from paper and flatten one**

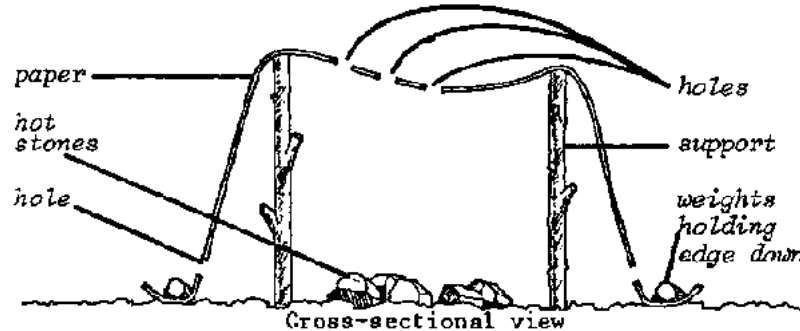
side as in Diagram 26. Have the tube lying horizontally, and close off both ends of the tube similar to the way the roof is used by Group One. Make two holes, one directly above the heat source, the second near the other end of the box or tube. Use a hot stone, hot charcoal, or a candle as source of heat. Test the flow of air by holding a piece of smoking string near each hole. Which way does the air flow? Make a diagram showing how the air flows.

*DIAGRAM 26***DIAGRAM 26**



### Procedure for Group Three

Put about five hot stones on the ground, and place a paper enclosure over them as shown in Diagram 28. Feel which parts of the paper get warm. Make several holes about 4 square centimeters each along the bottom edges of the enclosure. Test for flow of air using a smoking string. Then make several similar holes near the top of the enclosure. Test for air flow again. Which way does the air flow? Make a diagram showing how the air flows.

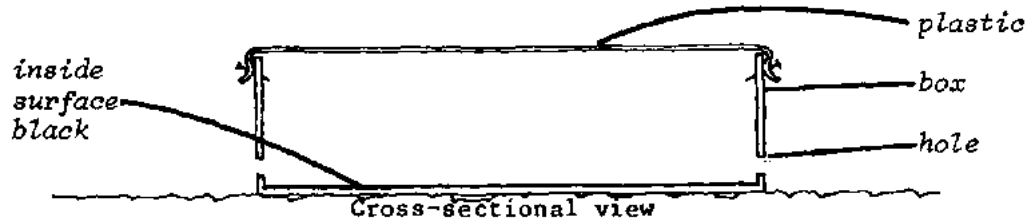


**DIAGRAM 28**

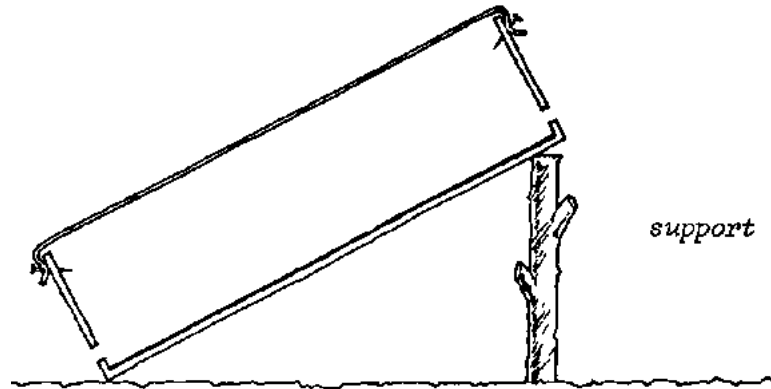
### Procedure for Group Four

Use a box with one hole at each end, near the bottom of the box, as shown in Diagram 29. Coat the bottom of the box with black ink or paint. Attach transparent plastic with pins to make the top of the box. Leave this in the sunlight a few minutes, and test for air flow using a smoking string. Test it when the box is horizontal, and when one end is propped up, as shown in Diagram 30. This should be done where there is as little breeze as possible. Then put the box horizontal again, and make a hole at the top edge of one of the sides. Test the flow again. If a thermometer is available, measure the difference in temperature between the air entering the box and the air leaving the box.

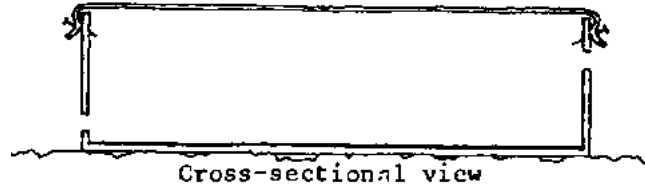




**DIAGRAM 29**



**DIAGRAM 30**

**DIAGRAM 31**

**After each group has reported its results to the rest of the students, continue with the next activity which concludes Part I.**

### **Activity I-11B CONVECTION**

**In this activity all sub-groups need the same materials that were used by Group Four in Activity I-IIA. The students have learned that air warmed by a source of heat inside a box tends to flow out of the box if there are two holes in the box, and one hole is higher up than the other hole. They have also learned that a surface absorbs the most energy from the sun if it is at an angle of  $90^\circ$  with the sunlight. In addition, they have been told that for each 10 degree centigrade raise in temperature, the relative humidity of air is halved.**

**In this activity, the students build boxes that have transparent tops. You should encourage them to produce what they think are the most desirable conditions inside the box for food drying. They should design their boxes with following questions in mind:**

**How can this box make the most effective use of the sun?**

**How much temperature rise is best?**

**How much air flow is best?**

**How can ways to adjust these be built into the design of the box?**

**These boxes can be used to dry pieces of food in Activity II-1 which concerns finding the percentage of water in various kinds of food.**

### **SUMMARY**

**These procedures include using smoke to detect air flow, measuring the direction of light, measuring elevation angles of surfaces, computing ratios of weight, and estimating ratios of volume.**

**These concepts include relative humidity, surface-to-volume ratio, radiation, conduction, convection, measuring volume by displacement, evaporation as a means of cooling, and radiation being directional.**

**For some students, the procedures may also have included measuring relative humidity and designing a system where everything cannot be maximized and an effective balance must be sought.**

**For some students, the concepts may also have included reflection contrasted with absorption, and consideration of a situation where two or more variables must be taken into account simultaneously.**

**The students have now been exposed to all the concepts necessary to participate knowledgeably in building and operating food dryers.**

**If you are teaching a class which will eventually face an external examination, it will be worthwhile to look at the Syllabus to see how questions are framed that relate to each concept the students have learned in Part I. If there are gaps in the students' knowledge, you can teach lessons interspersed in Part II, so that there will be no confusion about the**

**terminology or calculations your particular Syllabus requires.**

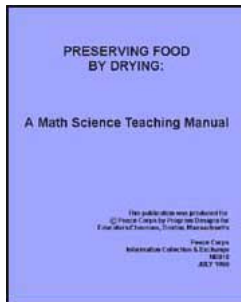
**There are several ways by which you can assess how much and what your students have learned. One or more of the following methods may be appropriate for you situation:**


- 1. Listen to the way students describe their work and otherwise participate in discussion.**
- 2. Observe the way they have designed their boxes and their food dryers in Part II.**
- 3. Note their answers to specific problems and questions that you pose.**

**If your teaching is designed for practical outcomes only, these informal methods may be sufficient. If, however, written examinations of knowledge acquired is a requirement, then those exams can serve to help you identify areas in which students will need additional instruction.**



[Home](#) > [ar](#) [cn](#) [de](#) [en](#) [es](#) [fr](#) [id](#) [it](#) [ph](#) [po](#) [ru](#) [sw](#)



 **Preserving Food by Drying: a Math-Science Teaching Manual (Peace Corps, 1980, 218 p.)**

➔  **Part 2. Food dryers**

 **(introduction...)**

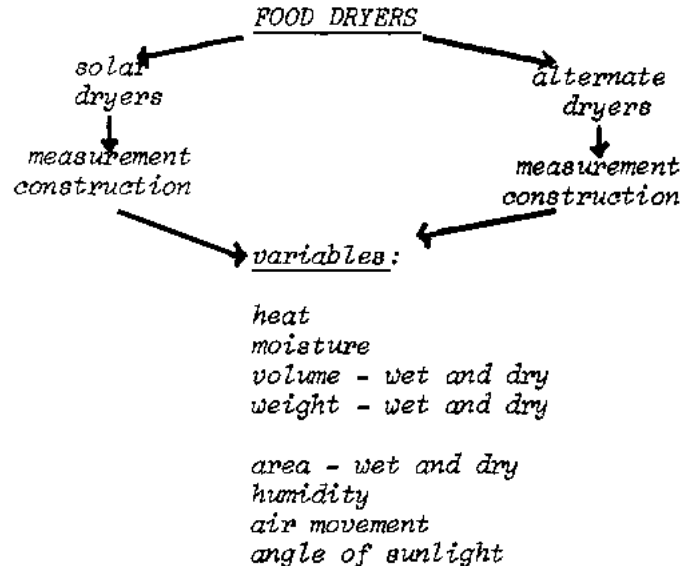
 **Chapter 3. Preparing for food drying**

 **Chapter 4. Building food dryers**

## Preserving Food by Drying: a Math-Science Teaching Manual (Peace Corps, 1980, 218 p.)

### Part 2. Food dryers

This part develops and applies the concepts learned in Part I. It contains activities concerned with food drying, and activities constructing food dryers.



**Figure**

**Note: Other subjects for related work are agriculture, math and trigonometry.**

**Chapter 3 begins with simple food drying to determine the water content of foods.**

**Volume, weight and surface area are measured, expanding on the food drying activity in Chapter 1. Heat, air movement and the angle of sunlight, which were introduced in Chapter 2, are explored further as students build and test small models of food dryers. As the students improve the effectiveness of their small models by modifying them, they will determine which of their designs work most effectively.**

**In Chapter 4, various designs of dryers are presented with some building suggestions. These dryers cover a range of designs using a variety of materials. They can be modified a number of ways to suit the local materials and climate, in accordance with what the students have learned with their small dryers. However, students may build a large dryer they design themselves, instead of depending on the designs presented.**

**Some trigonometry is required to build one of the dryers. The math class could work on this aspect while the science class works on another aspect or another dryer. The two classes could then build the large dryer(s) collaboratively. If this is not possible, you can make the necessary calculations and give the figures and dimensions to students interested in this dryer.**

**Dryers using heat from a source other than the sun are also introduced. If electricity is available, a very inexpensive model can be built, encouraging the science student-s to apply concepts in an alternative situation. Also, the students can test and compare the results of drying foods with solar dryers to the results with alternative dryers (coal, paraffin) in order to determine the advantages of various dryers.**

**Both small and large dryers can be built with tools the students have made. If the students have not made tools or do not have access to tools, you may want to precede some of the activities with tool building. If each group of students has a set of tools, the problem-solving activities can run more smoothly.**

### **Getting the Community Interested**

**To increase the likelihood of the methods and skills being generalized, try to involve the community as you and the students gather materials for the activities. (Some items may be donated also. Are dry mild, bursar wheat, and other dry staples available in the local area?) Would a local restaurant owner give food to the science class in exchange for dried food during the season of shortage, thus improving the menu and saving money on purchases of expensive imported items? Would farmers give their extra perishable crops in exchange for having some of it dried? Are there international agencies or businesses in the area? Would they donate food or money for food for the project? What could the science class offer them?**

**Presenting the food drying project as a potential community service increases the likelihood of assistance, and provides a link to the community for increased education.**

### **Advantages of Food Drying and Solar Dryers**

**Preserving food by drying allows for nutritious meals even in the season of shortage. Besides this obvious advantage, there are other reasons for preserving food by drying.**

- 1. Drying preserves the vitamin, mineral, protein and fiber content of food more than methods which expose it to extremes in temperature. (See pp.162,174)**
- 2. Dry food is often more flavorful than fresh food because even after rehydration it is somewhat smaller than its original size. The flavor is therefore more concentrated. Eaten dry, the flavor and nutrients are much more concentrated.**
- 3. Drying costs less than freezing and canning.**
- 4. Dry foods require very little storage space.**
- 5. Dry foods when kept dry will remain edible indefinitely. Mold and bacteria can grow only**

**where there is water.**

**Solar dryers offer further advantages:**

- 1. Solar dryers can maintain high enough temperatures to eliminate the possibility of mold or bacterial spoilage. (See p. 122) Spoilage is common with open drying methods, especially in humid climates. Also, if the solar dryer can reach a temperature of 55° C, further pasteurization is not needed. This saves time and effort. (See pp. 125, 171-2)**
- 2. Solar energy is free and readily available.**
- 3. Food in solar dryers is protected from dirt and animals.**
- 4. Any insects already in the food will be killed or driven off by the high temperature in the dryer.**
- 5. The rise in temperature inside the dryer reduces the relative humidity. The moisture in the food is carried off by the heated air moving around the food. As a result, food can be dried faster in a solar dryer than outside.**

### **Objectives**

**The students will learn to identify and manipulate the variables involved in food drying:**

- 1. Heat**
- 2. Moisture content**
- 3. Volume**
- 4. Weight**
- 5. Area**
- 6. Humidity**



**7. Air movement****8. Angle of sunlight**

**This will be done through discussion, activities and the building and testing of small and large food dryers.**

**Chapter 3. Preparing for food drying****Activity II-1 WATER CONTENT OF FOODS**

**(See introduction to II-2, p.91 ). In Chapter 1, the students began a preliminary investigation of the water content of food. In this activity, students weigh various foods wet and dry and calculate the water content. The students should apply the ideas learned in the evaporation activities to reduce the time needed to complete the activity. They will begin also to collect information about food types to use later when the small and large food dryers are built and tested.**

**Each sub-group of students should have a balance to use for its studies. As discussed in Appendix G, it is also a useful learning experience to develop one's own system of measures.**

**By comparing the wet weight and dry weight, the students can calculate the percentage of water in foods.**

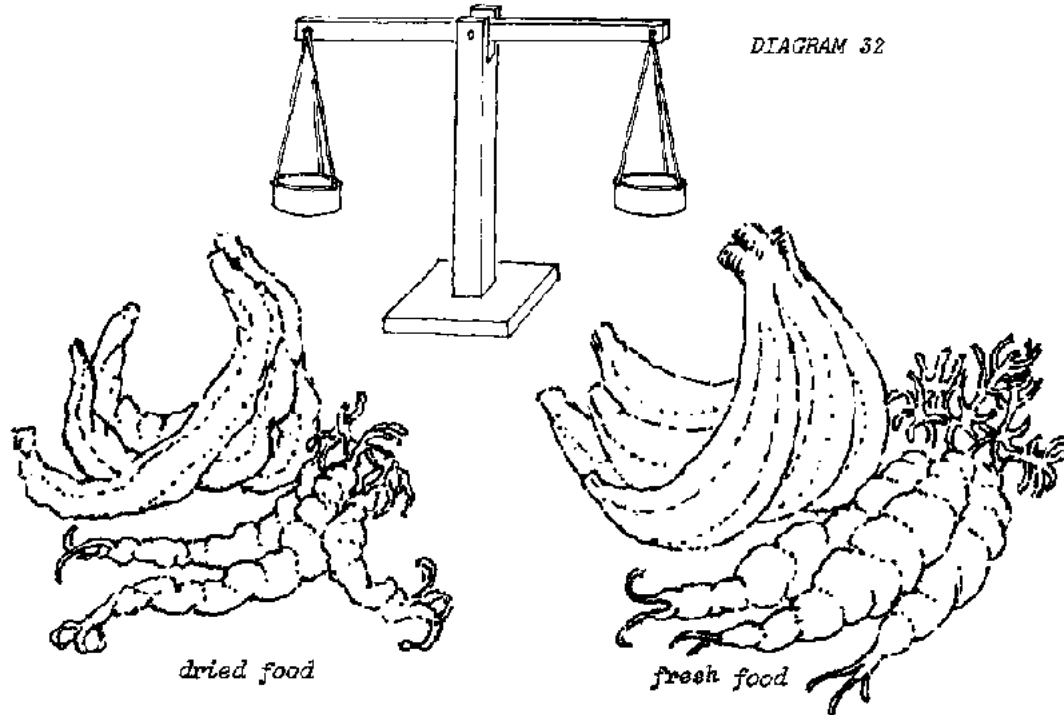


DIAGRAM 32

**Formula:**

**(Final dry weight)/(First wet weight)x100 = Food; nutrients and fiber and some water = F**  
**100% - F = Water content; removed by drying = W**

**Example:**

**(1 bottle)/(4 bottlecaps)x100 = 25% Food content**  
**100% - 25% = 75% Water content**

The students also can compare the volume of food pieces wet and dry. For some food items, this would be an approximation. For example, mango slices can be put in a straight sided jar and the volume of a cylinder can be calculated for the space the wet slices occupy and the space the dry pieces occupy. For other food items which can be cut in geometric shapes, such as potato or melon, the volume can be calculated directly. Using grid sheets may facilitate this measurement.

### Further Study

If math is to be emphasized, encourage your students to calculate the volumes of their food pieces using the following formulas:

Cube	$V = S^3$	Cylinder	$V = \pi R^2 h$
	S = One dimension		$\pi = 3$
			r=radius
RectangularPrism	$V = l d w$		h=height
	l = lenght	Sphere	$V = 4r^3/3$
	d=depth		
	w=width		

As a guideline, dried fruit and vegetables have 1/6 - 1/3 the volume and around 10 - 20% the water of their original fresh state.

Have soap and basins available and encourage everyone to wash their hands before handling food. Have the students clean the food also before preparing it for drying.

**Encourage sanitary conditions during the activities. Some discussion of the reasons for sanitation may be developed as the students work on their experiments. Note also the pre-drying procedures outlined in Chapter 8.**

**Materials**

**Vegetable: potato, cassava, carrot, celery**

**Fruit: banana, mango, melon**

**Cereal or seed: bean, rice, sorghum**

**Protein: fish, cheese**

**(Use food items available. Although it is useful to test a variety of foods to compare the water contents and drying times, it is not necessary to have one of- each food to test)**

**Razor or similar cutting tool**

**Water**

**Basin, bowl or bucket**

**Equal arm balance or other device for comparing weights**

**Bottlecaps, tins or similar items to be used as weights**

**One small dish or piece of pasteboard for each piece of food to be dried**

**1 cm grid sheet**

**Straight sided jar to calculate approximate volume****String****Ruler****Soap****Cloth: cheesecloth, gauze, nylon tulle**

**Each sub-group should have one set of materials. Weighing equipment and basins can be shared. Direct the students as follows or hand out work sheets.**

**After washing your hands, take one food sample. Check to see that your sub-group has a variety of food samples. Cut the clean food sample so that you can measure and dry it. Food for sampling should be gathered when ripe. Pieces should be selected which have no cracks, bruises or rotten spots. Bad spots should be cut out.**

**First, measure the cut piece. What is its area? What is its volume? Record this information.**

**Next, select a dish or pasteboard piece, weigh it and record the weight. Place the cut food piece on the dish and weigh them together. Record the result.**

**Place the food piece and board or dish in a warm place and cover it with a piece of cloth. Note the time and location. Leave it for a number of hours or until the next day. Then weigh it (food and dish) and record the weight. Wait again for some time and weigh it and record weight. Continue to wait, weigh, and record until there is no change in the weight. What is happening? Why is there no more change in weight?**

**Next, measure the food piece. What is its area? What is its volume? How does this volume compare with the first volume? What fraction or percentage of the first volume is the final**

**volume?**

**Compare the first weight of the food with the final weight of the food.**

**What fraction or percentage of the first weight is the final weight?**

**How much water has evaporated from the food?**

**What percentage is the water content of the food sample?**

**How does this food compare with the other foods?**

**How long did it take to reach a final weight?**

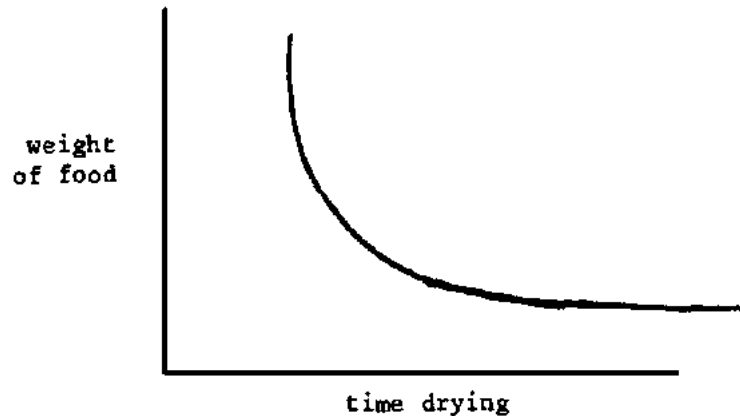
**How does the time compare with the other foods?**

**How long did it take to reach a final weight?**

**How does the time compare with the other foods?**

**With the same food dried in a different location?**

**Report your findings to the rest of the students. Some of the results can be presented in the form of a graph.**



## **Figure**

### **Activity II-2 SMALL SOLAR FOOD DRYERS**

**In this activity, students begin to apply the concepts learned and information gathered in Part I. This activity links with the last activity of Part I, Activity I-II, where the students discuss and design food dryers. You can do this activity before, during or after Activity II-1 depending on the areas of student interest and what is most convenient for you.**

#### **Materials**

**Tins and pieces of metal from tins**

**Black paint, soot or black cloth**

#### **Wood**

**Pasteboard or wood boxes**

**Paste or cement or other adhesive**

**Thermometers**

**(Angle measuring device)**

**Equal arm balances or other devices for weighing**

**Razor blades, knives, glass cutter**

**Aluminum foil or aluminum paint**

**Cotton gauze, nylon tulle, mosquito netting**

**Nails**

**Glass or plastic**

**One type of food to slice for drying tests, preferably one that does not spoil readily.**

**Soap**

**Basins, bowls or buckets**

**Rulers**

**Hammers, saws, chisels, drill, etc.**

**Each sub-group should have access to enough materials to build, test and modify their food dryers until they are satisfied with the results. This activity, as others, can be conducted outside, especially if the construction noise would be distracting to other classes. The activity should continue for a number of class periods until the students have determined which models work most efficiently and effectively in the local environment. Encourage the use and modification of the designs the students developed in Activity I-11.**

**Have all the materials in a central location to facilitate the building. Ask the students to build a small device to dry food. Let the students know that after they have built and tested the small models, the class will build one or more large dryers. Ask the students to find out which design will dry food the fastest.**

**Let the groups work independently. While the students are building the small models, move from group to group to ask questions. Ask questions about the design and how it takes these variables into consideration?**



**How is the air around the food heated?**

**What way will the air move through?**

**What would be the best location for that model?**

**Will moisture gather inside?**

**What would happen to the device on a windy day?**

**What surface color will work best?**

**Where will the food be placed?**

**Can the model's angle be changed?**

**Some models built by students are diagrammed below:**

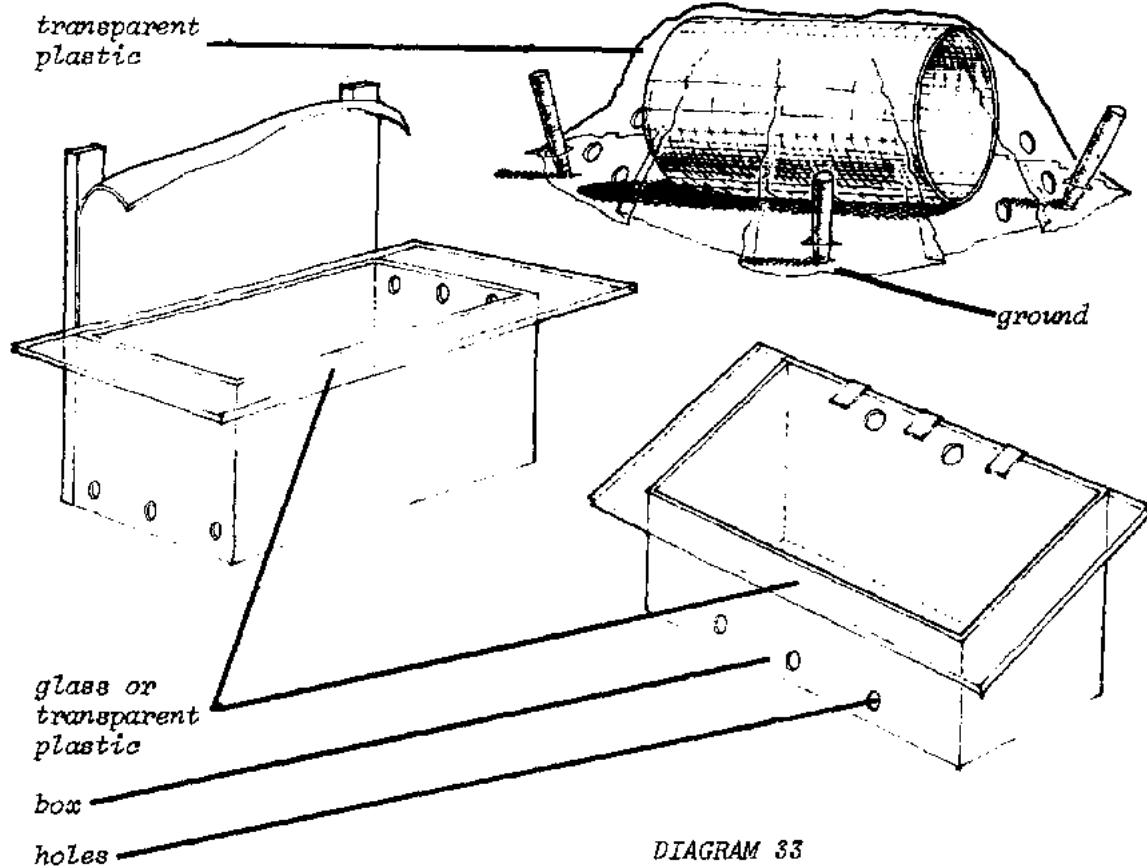


DIAGRAM 33

**Have one type of food available for cutting and drying. As each sub-group finishes building**

**its small model, including trays or shelves (p.96) for the food, have these students prepare some food for drying. Encourage the students to wash their hands before handling the food. Ask the students to keep records on their experiments.**

**How did you cut the food?**

**What size were the pieces?**

**What time of day did you begin to dry the food pieces?**

**What was the weather like?**

**Where did you place the dryer?**

**How was the dryer placed?**

**What did the food pieces weigh wet? What area? Volume?**

**How much did the food change as it dried?**

**Did the drying go fast or slow at first? Or was the drying rate consistent the whole time?**

**How long did the drying take?**

**What was the dry weight? Area? Volume?**

**Ask the students to observe all the models being built and discuss their designs and ideas between the groups.**

**After the drying tests, have each group report on their design and the results to the class. From this discussion should come ideas for modification of some of the dryer models.**

**These will then be tested. Eventually, the students should agree on which designs work best. Then have the students work on the designs of one or more large dryers. At this point, there may be some collaboration with the math and woodworking classes. Collaborating on different aspects of the same problem or project involves using time allocated to different subjects which are often taught by different teachers. When circumstances favor this arrangement, learning outcomes are often enhanced.**

## **SUMMARY**

**The students now know what has to be done to food to dry it. They also know how to make the many decisions necessary to build an effective dryer, and how to test and adjust until good results are gotten.**

**The next activity will be building large dryers. Build the designs the students have determined are best suited for the local environment and materials available, or have them adapt a design from Chapter 4. Alternate heat sources for drying can be introduced, if desired, while the building is going on or after the students have built and tested the sun heated dryers (e.g. paraffin, coal).**

## **Chapter 4. Building food dryers**

**The dryers presented here are samples to use after the students have experimented with small models. Some may not be appropriate for your local situation. All of them can be modified considerably. Some designs can be used with the sun's heat or with alternate heat sources. Some of the dryers can be adapted for indoor use which may be useful if there is a long wet season. All of the dryers can reach temperatures around 45 degrees centigrade and can therefore also be used to incubate yogurt, sour cream and other cultured milk products. Another modification to consider: Can a dryer be used as a chick incubator?**

**Food drying trays can be built with a variety of materials. (See "Food Preservation Resource Packet",) The general design is a wooden or metal frame with cloth, netting, woven wood strips or woven bamboo attached. There must be holes for ventilation. Woven wood, bamboo or baling wire trays are sturdier and can be washed and reused more than trays made with cloth. Rubbing the trays with a small amount of cooking oil keeps the food pieces from sticking and makes cleaning easier. Don't use a material such as aluminum, copper or fiberglass which can contaminate the food. Generally each 20 square decimeters of tray accommodates about one kilogram of raw food. It is best to keep the size of the trays small enough to carry easily. This way, food can be washed and cut and placed on the trays indoors and then carried outdoors and put in the dryer. Also, the food laden trays can be moved easily indoors at night or if it should rain.**

## **SOLAR DRYERS**

**Three very different dryers are described in this section. Each dryer has certain advantages. The students have weighed the factors affecting dryer operation in the local environment as they built and tested the model dryers. They can therefore develop a design appropriate to the locality and the materials available, using the designs shown here as a resource for additional ideas. All the dryers are heated by solar radiation and operate with convection currents of air. The food is enclosed and is protected from dirt and pests. All the dryers reach temperatures in the optimum drying range: 40°C. to 60°C. Some dryers can reach this range even on overcast days in the colder climates.**

### **Site**

**Location of the dryer should be chosen based on needs, i.e. exposure to maximum sun; little wind, enough for ventilation but not cooling.**

## **OIL DRUM SOLAR DRYER**

**As the sunlight changes direction throughout the day, this dryer with its curved surface has about the same area available to collect solar energy. Once the dryer has warmed up, the heated air moves across the food inside at a fairly constant temperature as long as the sun continues to shine on it.**

**The sun heats the drum. The air outside the drum is warmed by touching the drum, before it flows into the drum. Two layers of plastic insulate this air from the cooler air outside. This minimizes unnecessary loss of heat.**

Oil Drum  
Solar Dryer

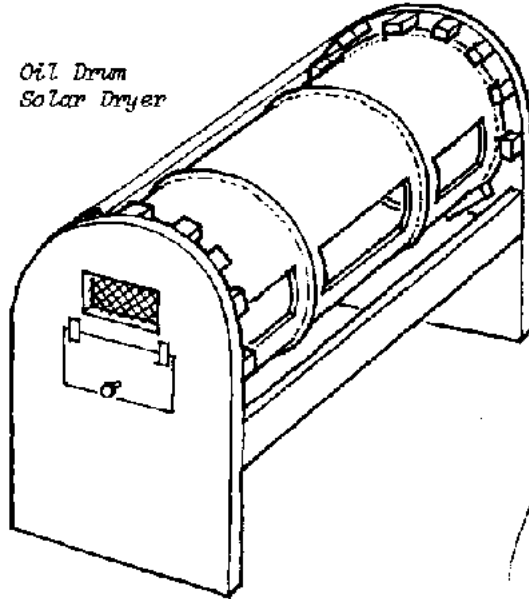


DIAGRAM 34

Below: Cross-section of dryer showing how the air flows in the bottom, around between the plastic and the drum, in through the holes in the drum, and out the ends near the top.

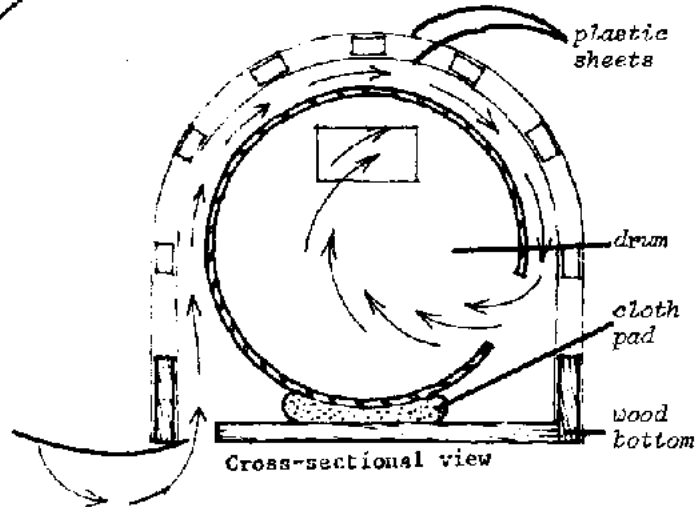
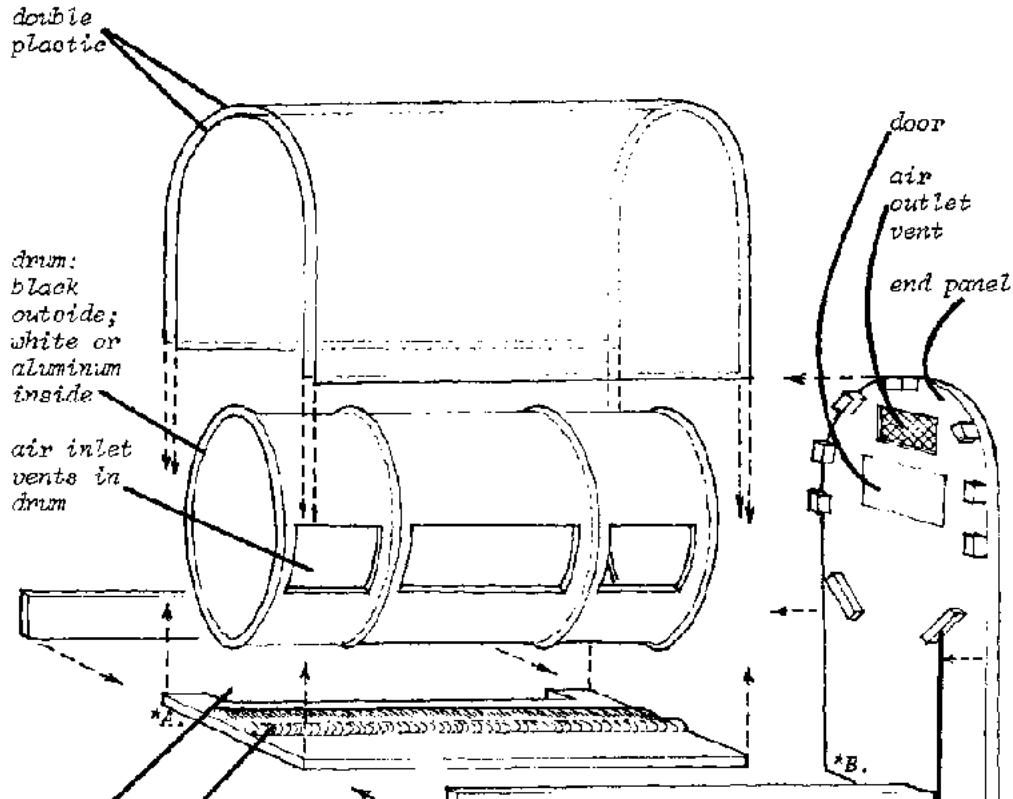
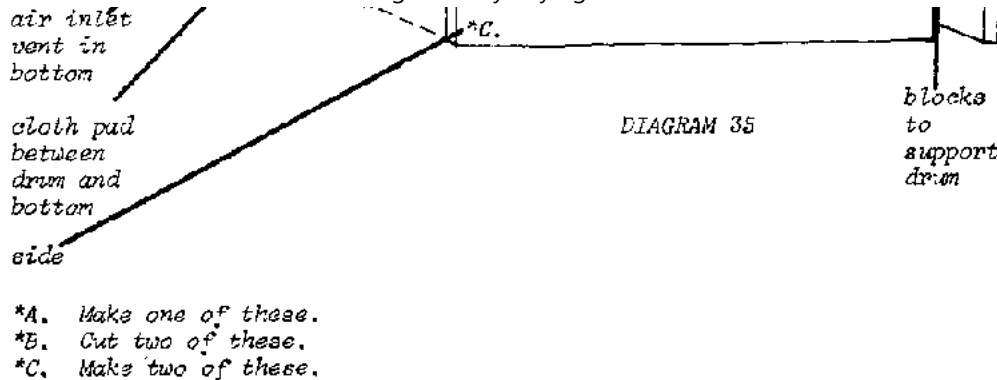


DIAGRAM 34

**Inside the drum the heated air flows past the food and gains moisture. It also gains some additional heat by touching the inside of the drum. Then it leaves the dryer through the vent at the top of each wooden end. However, the food should not receive much radiation from the drum because the food may get too hot and cook.**







**DIAGRAM 35**

**A black surface absorbs radiation best, and is also the best surface to radiate heat.**

**A light colored surface absorbs radiation poorly because most of it is reflected away. A light colored surface is also the poorest surface to radiate heat.\***

**This is the reason why the inside of the drum is supposed to be painted a light color. In your locality, it may not matter, but if you don't paint it and the food cooks instead of drying, you should then paint it.**

### **Materials**

**Oil drum**

**Chisel and hammer or welding torch**

**Clear plastic**

**Cloth for pad under drum**

**Hinges for door**

**Paint thinner**

**Tacks or very small nails**

**Nails or pegs**

**Saw**

**Trays (see the first page of Chapter 4)**

**Wood for frame**

**Black paint or something similar**

**Aluminum paint or whitewash**

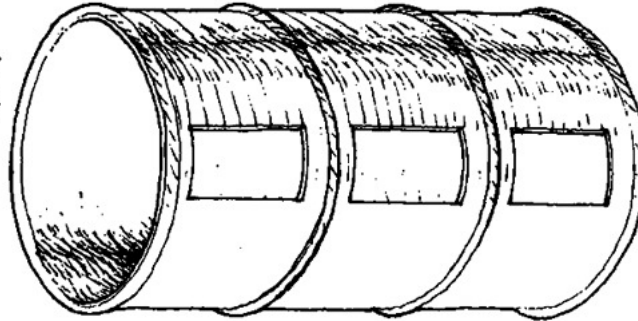
**Paint brush**

**Net or wire to cover vents**

**Pegs, wood strips and small blocks**

**Hammer**

*Both ends of the drum are removed, and three holes are cut in one side as shown here.*



**DIAGRAM 36**

### **Oil Drum Solar Dryer Construction**

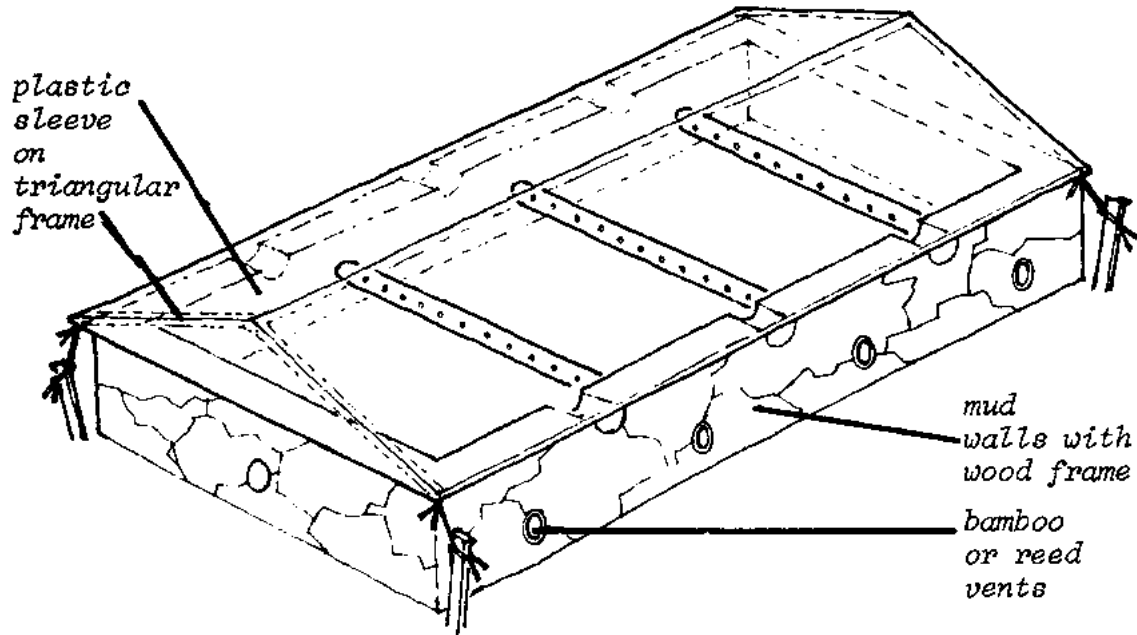
**(See diagram) Read through completely.**

- 1. Cut the top and bottom (the ends) out of the oil drum, using a hammer and chisel or a welding torch. Cut a rectangular piece from each area on the side of the drum between the ridges as shown above.**
- 2. Paint or coat the outside black on all surfaces that sunlight will reach. Paint the inside with aluminum paint or whitewash.**
- 3. Measure and cut pieces of wood to make the ends, the bottom, and the sides.**
- 4. Make the ends. Near the top of each end is one vent opening, which should be covered with netting or cloth. In one end is a door which is large enough so that trays can be put in the dryer easily. Hinge the door.**
- 5. To support the drum, attach blocks of wood to the inside surface of each wooden end.**

- 6. To provide a place to fasten the inner layer of plastic, attach curved strips of wood, or small blocks of wood, (at least 2 cm wide) to the inside the drum to hold the trays.**
- 8. Nail the cloth pad onto the bottom. Its purpose is to prevent air from flowing between the drum and the bottom.**
- 9. Attach the ends to the bottom, leaving sufficient space above the ground for air to enter freely. The bottom should be a short distance below the blocks or strips that will support the drum, the cloth pad to fit firmly against the drum.**
- 10. Put the drum on the blocks.**
- 11. On the bottom air vent side, beginning where the bottom is attached to the ends, attach a layer of plastic to the inside of the curved strips or blocks on the ends. Let it hang down on the side that is not cut away for the air vent. Pull the plastic smooth and attach it to the edge of the bottom. Nail the side piece on this side only to the bottom. These nails pass through the plastic you have just attached to the bottom. Also nail it to the ends.**
- 12. Place the other side piece in position. The inner plastic is now between the side and the bottom. Nail this side to the ends only. (Most of the bottom is cut away on this side for the air intake).**
- 13. Pull the plastic smooth and attach it to the side.**
- 14. Attach the outer plastic sheet to the ends and to the sides. Plug any leaks.**
- 15. Position the dryer to take best advantage of the sunlight for as many hours of the day as possible.**

## **MUD WALL SOLAR DRYER**

**This dryer was developed in Tanzania. It is built in a permanent location so care must be taken to determine the best direction to position the dryer, and to locate it where it will not be disturbed. It could be built on the school grounds or somewhere in the town or village so that community residents could use it. Except for not being movable, this dryer has all the advantages of other solar dryers, making it more efficient and effective than open air drying and much cheaper than drying with alternative heat sources. It also costs very little to build, and uses building skills that most people have.**

**DIAGRAM 37**

## **Materials**

**Plastic sleeve - all dimensions for the dryer must match the plastic sleeve so that the cover fits on the walls. One standard size has a circumference of about 240 cm and can be gotten in any length.**

**Nails**

**String**

**Bamboo tubes the width of the dryer (cut ventilation holes)**

**Lime or cement or cow dung**

**Hammer**

**Knife**

**Measuring tape or meter stick**

**Clay soil or termite hill soil or some similar material**

**Wood or bamboo poles as long as the dryer**

**Boards to cut for end pieces for sleeve top**

**Reeds, strips or twigs**

**Charcoal powder**

**Wood posts about 50 cm long**

**Sand paper or something similar**

**Saw**

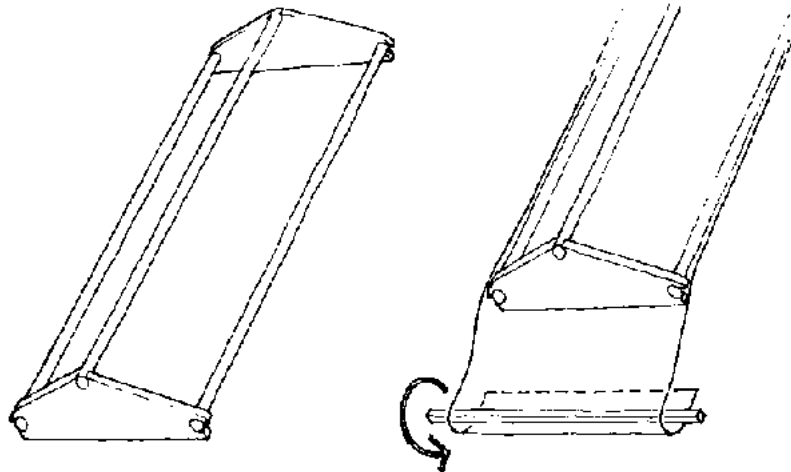
**Hoe**

### **Mud Wall Dryer Construction**

**1. The wood frame for the plastic sleeve is built first so that the other construction can be matched to the plastic sleeve roof.**

**A. Cut the end boards in triangular shapes that will fit in the plastic sleeve.**

**B. Cut out holes at the corners and fit and nail the poles into these holes.**



**DIAGRAM 38**

**C. Sand down all the rough edges on the frame so that the sleeve will fit over the frame without tearing.**

**D. Slip the plastic sleeve over the frame. Roll the excess plastic on the ends around wood poles. Draw the rolls up tightly against the ends and tie them securely.**

**2. The dryer walls are built next to match the dimensions of the plastic sleeve roof.**

**A. Clear and level the site for the dryer.**

**B. Mark out the dimensions using pegs driven in the earth and string drawn between the pegs. The corner angles should be 90°.**

**The plastic sleeve roof should overlap the outer edge of the walls by 3 to 5 cm so rain will not run off the roof onto the walls.**

**C. Dig holes for the poles at the corners and at 25 cm intervals. The holes should be about 25 cm deep.**

**D. Put the poles in the holes so that they are aligned and all the same height, which should be about 25 cm above ground level.**

**E. Tie or nail twigs or reeds connecting the poles at two or three levels above the ground. This makes a sturdy frame.**

**F. Mix the clay or similar substance to make a smooth mud. Pack this inside the spaces between the linking reeds. Smooth the mud completely over the inside and outside of the frame to make smooth walls.**

**G. Insert the bamboo tube vents from side wall to side wall while the mud is wet. Set them at 50 cm intervals. When the dryer is finished, the food trays can sit on the bamboo**



**tubes above the ground to assure good air circulation.**

**H. Around the top edge of the wall, carve out half circles for exhaust vents. Make sure the rest of the top edge of the wall is smooth and level so that the plastic sleeve roof will sit securely on it.**

**I. After the mud has dried completely, plaster over the outside walls with lime, cement or cow dung.**

**J. Mix charcoal powder with mud or some other sticky substance and plaster the inside walls and the bottom of the dryer with this black paste.**

**3. Build trays to hold the food. The trays should be wide enough to be supported by the bamboo tubes. Instructions for making trays are on the first page of Chapter 4. After the trays with food have been placed in the dryer, the roof is set on top and can be tied down to pegs to secure it against the wind.**

### **COLD FRAME CABINET SOLAR DRYER**

**This rectangular shaped dryer has a roof angled to catch the optimum solar radiation. The students experimented with this angle in Part I. Generally, it can be approximated if one knows the latitude of the area.**

Latitude	Roof Angle with Horizontal
0°	0°
10°	0°
20°	10°
30°	15°
40°	25°

50°	35°
-----	-----

**The double layer glass or plastic framed roof is hinged and the food trays are put in the dryer from the top.**

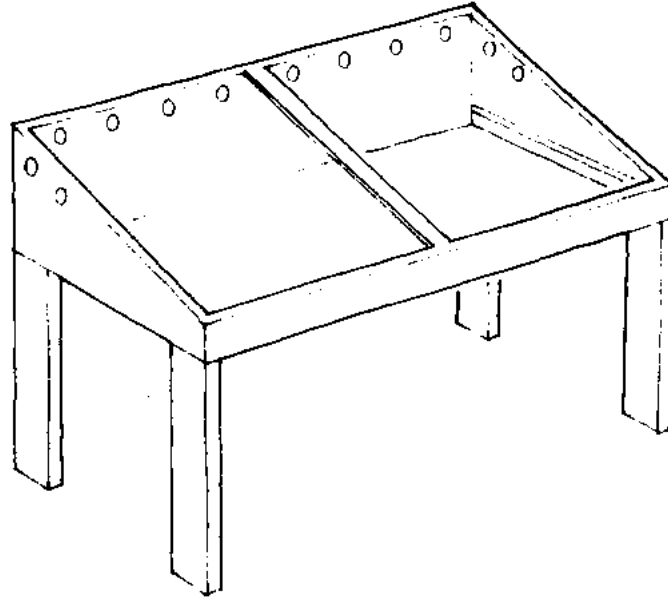
**The cabinet should be at least three times as long as it is wide to minimize shading from the sides.**

**The double cabinet walls and bottom are insulated with about 5 cm of thickness between inside and outside walls. Wood shavings, sawdust, dry organic matter, animal hairs and other similar things can be used for insulation. The double walls and bottom are sealed tightly after insulating.**

**The inside is coated with black to absorb heat.**

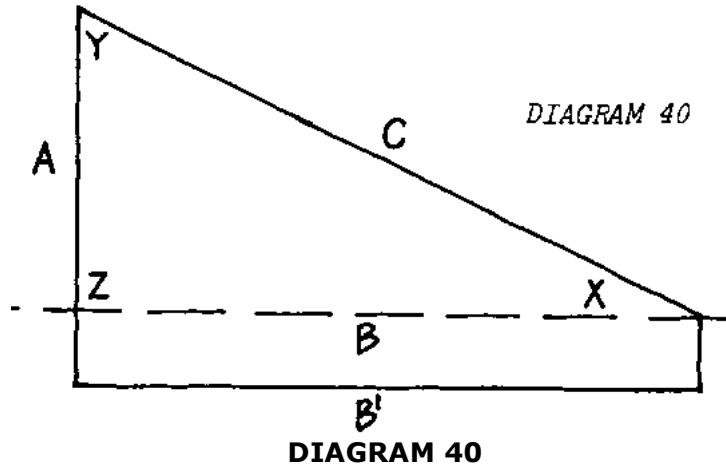
**The dryer is set on legs. There are holes along the front edge of the bottom, and along the top of the side and back walls. Convection currents or air move in through the bottom, pass by the food, and out the top.**

**Braces are attached to the inside of the dryer to put the trays on.**



**DIAGRAM 39**

**If math is to be emphasized, trigonometry can be used to calculate the dimensions of the end pieces once the optimum angle with the horizontal has been determined.**



**ABC is a right triangle. Angle x is known; it is the angle for optimum solar heating. Angle z is  $90^\circ$ .**

**Angle  $y = 90^\circ - \text{Angle } x$**

**The framed glass or plastic size is known. Therefore, the hypotenuse (C) would be known.**

**Since:**

$$\sin y = B/C$$

$$\cos y = A/C$$

**Then:**

$$C \sin y = B$$

$$C \cos y = A$$

**Also, since  $A^2 + B^2 = C^2$ , any side dimension can be calculated from the equation. For example, if  $B = 16$  and  $C = 18$ , then,**

$16^2 +$	$A^2 = 18^2$
	$A^2 = 18^2 - 16^2$
	$A^2 = 68$
	$A = 8.25$

**As with the mud wall solar dryer, it is good to start with glass or plastic and frame the double layer. Then with the known dimensions of the lid, the other dimensions can be calculated. The glass or plastic may be available only in certain widths. The length of the lid, and therefore the cabinet, needs to be three times the width or more.**

### **Materials**

**Glass or clear plastic**

**Nails**

**Wood pieces for legs and frame and braces for trays**

**Hammer**

**Black paint or charcoal paste**

**Hinges**

**Wood boards for inside and outside walls and bottom**

## **Saw**

**Insulating material such as sawdust, animal hair rags, lint, rice husks**

**Wood strips or tape to cover the edge of the insulating material**

## **Drill**

**Short pieces of bamboo or other tubes to keep insulation from plugging the vent holes in the sides and bottom**

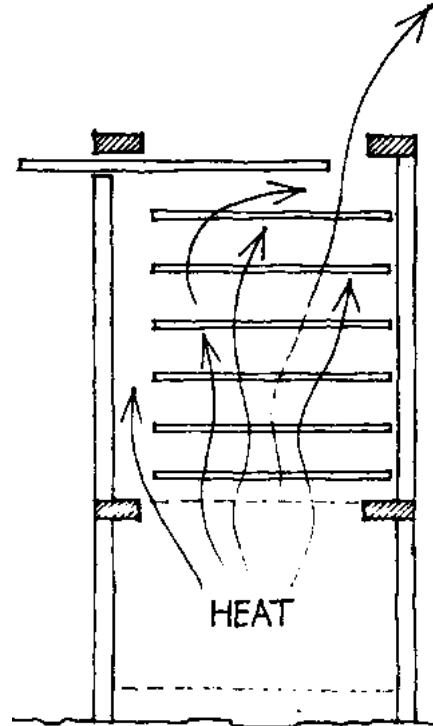
**As you consider these designs for dryers, keep in mind that the students are likely to think of useful modifications of materials as well as design, in producing a dryer suitable for your locality.**

**After the large dryers are ready, proceed with the lessons on treatment and preparation of food for drying in Part III and begin preserving usable quantities of food by drying.**

## **ALTERNATE DRYERS**

### **CABINET DRYER**

**This dryer is the most complicated design and requires more woodworking skill than the other dryers. It can be adapted for use with several heat sources and so, can be used indoors during the wet season. This may be viewed as an advantage. It can use electricity from a hot plate or similar source, or a paraffin heater, or a coal burner, or a solar plate collector similar to the device built in Activity I-II B, to supply warm air. The heat source is below the cabinet and convection causes the heated air to move through the trays carrying the moisture from the food out through the top. It is possible to collaborate with the woodworking class to build this dryer. Note : Discuss dangers of paraffin and coal .**



*top slides  
for venting*

*walls can be  
wood or bamboo  
or woven reed*

*screening can  
be used above  
heat source*

*heat source:  
charcoal,  
electricity*

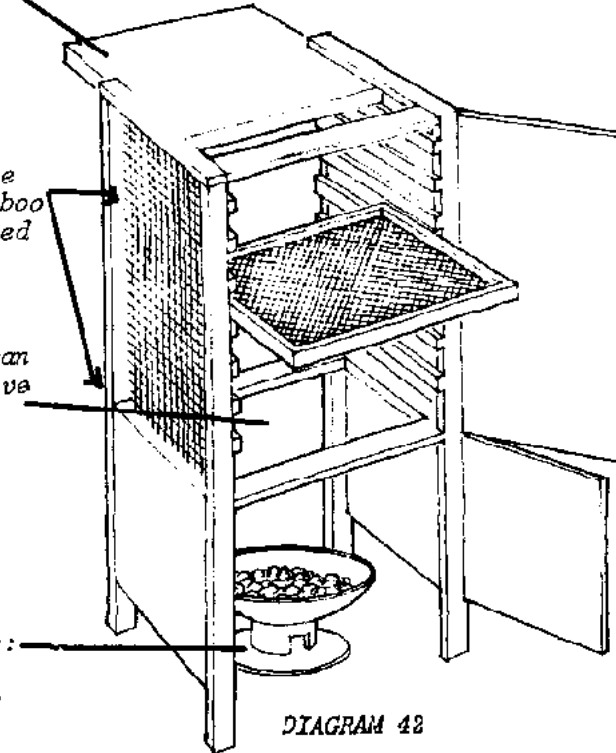


DIAGRAM 42

**DIAGRAM 42**

**Materials**



**Wood****Hammer**

**Wood strips about 2 cm by 4 cm to hold shelves**

**Wood pieces about 4 cm by 4 cm for the frame**

**Hinges and latches for the doors**

**Saw****Ruler**

**Wide wood pieces for sides, back, doors and top (or bamboo or reed mats)**

**Trays that can slide into the cabinet**

**Nails**

**You can adjust the dimensions to fit the materials available. Generally, the cabinet dryer is about 2(1/2) to 3 times as tall as it is wide. Also, if other dryers are being built, it is a good idea to make a standard size tray that will fit all the dryers; this consideration also affects the choice of dimensions. The trays should be less deep than the dryer to allow for circulation of the warmed air so that the moisture is lifted from the food and carried out.**

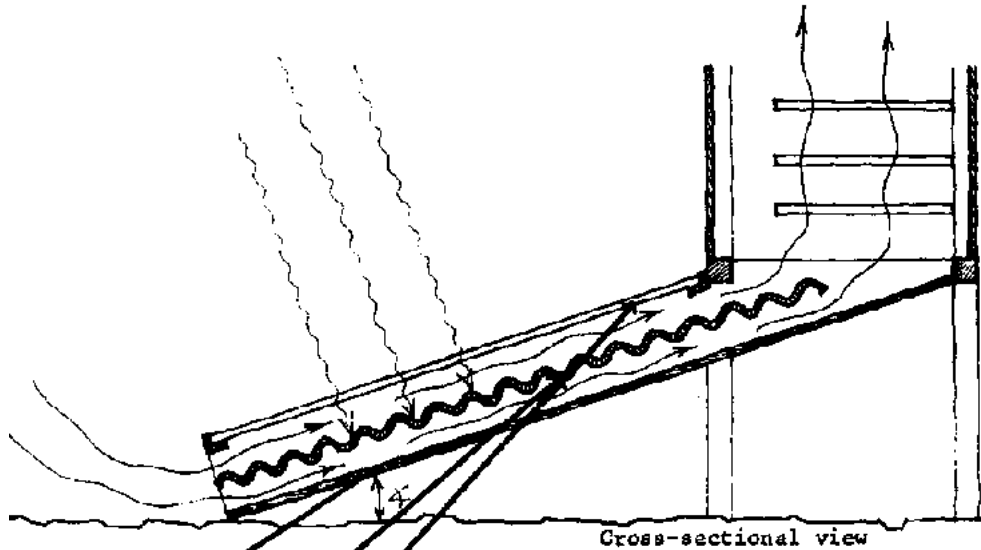
**The walls of the cabinet can be constructed with wide pieces of wood or can be built with a number of thin strips fit tightly together and sealed or lined with plastic. Split bamboo strips, woven bamboo or reed mats can be used as walls if lined well with plastic and nailed to a wood frame.**

**As with other dryers, check the temperature with a thermometer placed on a tray or hanging from a tray. Adjust the heat source or the sliding top as indicated by the temperature.**

## **SOLAR CABINET DRYER**

**The cabinet dryer can also be used outdoors, since the food is protected from dirt, insects, rodents and birds. By attaching a solar plate collector to the base, the air can be warmed using the sun's heat. The device used in Activity I-11B is a simple solar plate collector. Solar radiation passes through the clear glass or plastic and is absorbed by the black surface. Air moving through the collector is heated and moves up out of the collector by convection. The solar plate collector shown below uses black coated corrugated metal to absorb the radiation. The heat is then transferred to the air inside which is touching the metal. This collector has a double panel of glass or plastic to insulate the warm air inside. If only one thickness of glass or plastic is used, the air inside can lose much heat by touching the transparent material which is cooled by the air outside. In this collector, the air passes on both sides of the heated metal, as shown in the diagram.**

**The solar plate collector is attached to the cabinet with pegs or screws. The angle of the collector should be the angle that resulted in the best heating in the experiments in Part I. If you make its connection to the cabinet flexible, the collector can be raised or lowered at the base to adjust for the optimum angle.**



Cross-sectional view

DIAGRAM 43

bottom

black  
surface

glass  
or  
plastic

DIAGRAM 43

**LIGHT BULB DRYER**

**If crops mature and spoil during a cloudy time of year in your locality, and electricity is available or can be generated, this dryer may be useful.**

**It is simple and inexpensive to build. It could also be kept in the classroom and used for pasteurizing food which has been dried in the sun in solar dryers that do not reach pasteurizing temperatures. This small dryer reaches a range of 55° to 60° C. after heating for a period of time. (This dryer was adapted from an Organic Gardening & Farming magazine design.)**

**Materials**

**50 watt light bulb**

**Cardboard or wood to make two boxes**

**Aluminum foil or aluminum paint**

**Hammer**

**Metal sheet cut to fit top of box or a cookie sheet that fits the box**

**Light cricket, base, cord and plug**

**Small nails**

**Knife or scissors**

**Screwdriver**

## **Saw**

## **Chisel**

**Black paint and brush or black cloth and cement or a smoky flame for coating the bottom of the metal sheet with soot.**

- 1. Paint the bottom of the metal sheet black, or cement black cloth to the bottom or cover the bottom with soot.**
- 2. Line the inside of box with aluminum paint. One could use other shiny substances to line the box; the object is to create reflective surfaces to focus the light and heat on the black bottom of the metal sheet which absorbs the heat.**
- 3. Notch the box or cut a small opening at the base of the box to pass the electrical cord through to the electricity source.**
- 4. Set the bulb, socket and base in the bottom of the box.**
- 5. Make holes in the metal sheet and place it on top of the box.**
- 6. Make a pasteboard or wood box with no bottom which is almost as large as the tray. It should have holes along the lower edges of three sides. The top should be adjustable to control the flow of air leaving the box.**

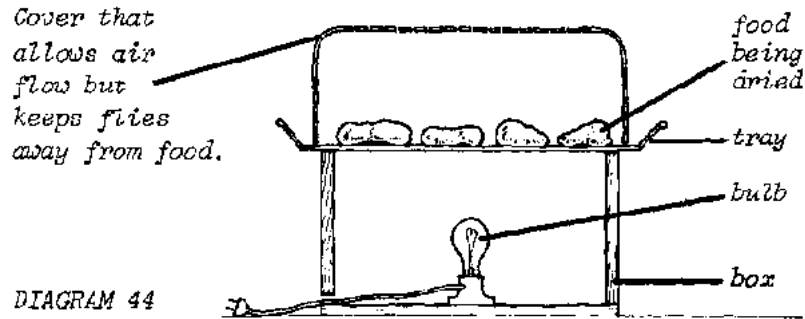


DIAGRAM 44

Cross-sectional view

DIAGRAM 44

One 50 watt bulb is adequate for 15 to 20 square decimeters of tray. If a larger area is set up for drying, use six 50 watt bulbs for each square meter of area. the depth can vary considerably; with the bulb placed 20 to 25 centimeters below the sheet, the dryer will heat from 20° to 30° C within an hour. After four hours, the temperature will be between 55° and 60° C.

Rub the sheet (tray) lightly with oil before putting food slices on it. Each 20 square decimeters of tray space holds about one kilogram of raw food. Drying time averages from 8 to 12 hours. This may vary with the relative humidity. Place the top box on the dryer. If the dryer is used in a breezy location, make sure that the top box is placed over the tray so the side with no holes is facing the breeze to prevent the flow of air from being too rapid, Have the students experiment to see how controlling the flow of air over the tray affects the drying rate. If there is concern about insects or dirt, cheesecloth can be draped over the upper box, covering the air holes.

The cost of using this dryer can be calculated using the following formula:

**(watts/1000 X energy prices)/(square decimeters of drying space) = cost per hour per square decimeter of drying area**

**For example, in the United States, electricity costs about 5 cents a kilowatt hour, so using this dryer for 12 hours costs about 3 cents. This dryer activity can be tied to other electricity studies. Encourage your students to compare this dryer's effectiveness and cost with other dryers they build.**

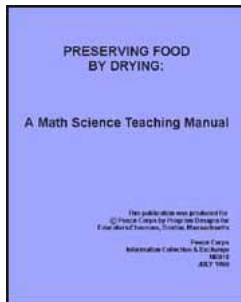
## SUMMARY

**The students now have the training and, if they have built one or more large dryers, the equipment to preserve significant amounts of food by drying.**

**Part III provides the students with sufficient background in nutrition to realize that including a variety of foods in one's diet is worth making an effort. There are also reference tables and practical guides for designing good diets.**



[Home](#) > [ar.cn.de.en.es.fr.id.it.ph.po.ru.sw](#)



**Preserving Food by Drying: a Math-Science Teaching Manual (Peace Corps, 1980, 218 p.)**

**Part 3. Nutrition**

**(introduction...)**

**Chapter 5. Food drying tests**

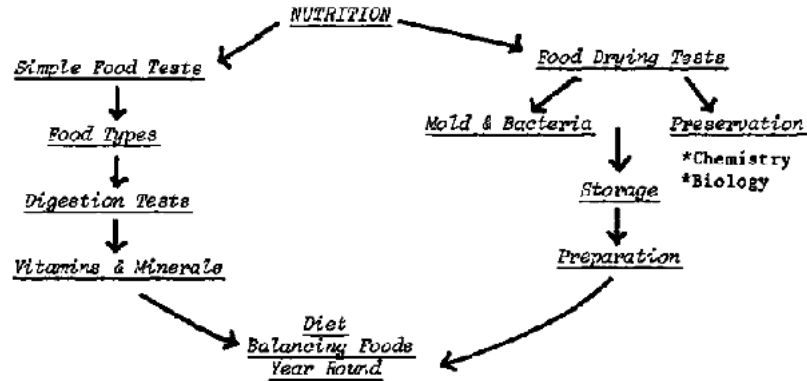
**Chapter 6. Simple tests for food components**

**Chapter 7. Digestion**

## Chapter 8: Preservation treatments Chapter 9: Preparation of dried foods

**Preserving Food by Drying: a Math-Science Teaching Manual (Peace Corps, 1980, 218 p.)**

### Part 3. Nutrition



**Figure**

This part can be presented as food is being dried and stored. A number of lessons will evolve as students test the different dryers. Some vegetables and fruit may spoil as students run tests and learn the most productive drying methods. When this occurs, lessons on spoilage from mold and bacteria can be introduced as well as lessons reinforcing the use of preservation and pasteurization methods. The decomposition of food by mold and bacteria is similar to the digestive process in humans. As simple food tests and digestion tests are being run, students can also test spoiled foods and note differences between fresh, spoiled and dried foods. This will emphasize the value of drying



**and preserving foods as well as increase the students' awareness of the digestive process.**

**The sequence of chapters presented is a suggestion. It is best to sequence the chapters as students bring up issues, questions and concerns. Lessons on preservation and spoilage and decomposition may precede or follow simple food tests based on the students' questions. In this section, food drying tests are presented before simple food tests only as a suggestion for following upon the equipment constructed in Part II.**

## **Chapter 5. Food drying tests**

### **BACKGROUND INFORMATION ON MOLD AND BACTERIA**

**In this series of lessons, students learn more about the impact of mold and bacteria on the preservation of foods. This is important in studying food preservation by drying because bacteria and molds are found in foods. By ingesting foods contaminated with mold and bacteria, we can become infected so we need to preserve foods free of mold and bacteria. (p.178 )**

**These lessons show the behavior of mold and bacteria under different conditions and thereby reinforce the preservation and storage methods necessary to avoid the contamination and spoilage of foods. A lesson also shows the digestive process of mold and bacteria and thus emphasizes what will be learned in the food test and digestion test lessons.**

**The discussion of mold and bacteria is offered to assist the teacher in facilitating lessons and directing student research. It is not necessary to include all the detail in the lessons. It is your choice to interject various pieces of information in the discussion after the activities. You may want to discuss food storage in association with this chapter. (See p. 178 )**

## **BACTERIA**

**Bacteria are considered plants primarily for classification, though many scientists would prefer to put them in a class separate from plants and animals. Bacteria have the following characteristics:**

- 1. Small size: micro-organism.**
- 2. Unicellular.**
- 3. Rigid cell wall.**
- 4. Reproduction: primarily binary fission; some produce spores.**
- 5. Able to obtain food in a soluble form.**
- 6. No chlorophyll.**

**Some examples of bacteria are:**

- 1. Staphylococcus, which causes infections on the skin and in the respiratory tract.**
- 2. Diplococcus pneumoniae, which causes pneumonia.**
- 3. Salmonella typhi, which causes typhoid fever and is spread through contaminated water, milk and food.**
- 4. Rhizobium, which is the nitrogen fixing bacteria on legumes' roots and is quite necessary and beneficial for plant growth.**

**Bacteria sources for the lessons include decaying fruit and the dirt under fingernails.**

**MOLD**

**There are many types of mold; they are classified by their reproductive processes. Molds have the following general characteristics:**

- 1. Multicellular.**
- 2. Majority of molds are composed of many thread-like filaments (exception - Slime Molds).**
- 3. Filaments are thin walled.**
- 4. Reproduction: asexual or sexual; most molds have both cycles. Each mold produces a fruiting body where spores are formed. The spores are thick walled.**
- 5. Ability to obtain food in a soluble form.**
- 6. No chlorophyll.**

**Some examples of mold are:**

- 1. Rhizopus Nigricans, the "bread mold." It is a soft, white, cottony mass with black spore cases. It grows on moist bread, raw sweet potatoes, and other starchy foods.**
- 2. Penicillium grows commonly on citrus fruits, forming blue-green spots on the fruit. It is used to make the antibiotic Penicillin and is also used in cheese production.**
- 3. Aspergillus appears reddish or black depending on what it grows on; it is similar to Penicillium and is very common.**
- 4. Neurospora grows in bread, on fruit and on grains. It is red. In culture, it has produced**

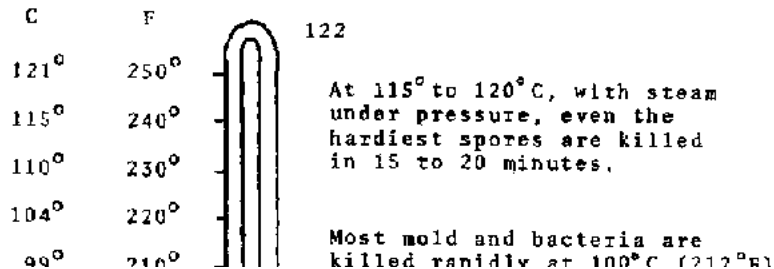
**a number of enzymes including Lipase and Trypsin.**

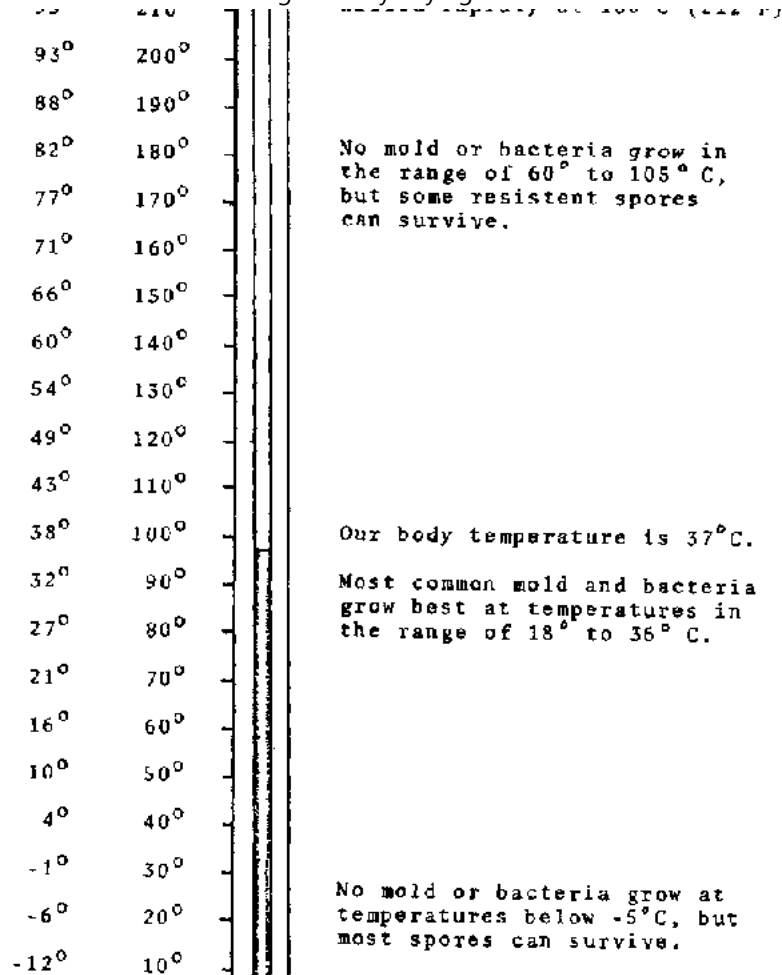
**Mold can be found or produced for the lessons on moist bread, citrus fruits and/or by placing dead flies in stagnant water.**

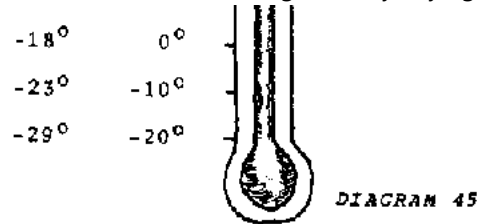
## **MOLD AND BACTERIA**

**Mold and bacteria differ in the first four characteristics listed above, but have other characteristics in common. As mentioned, both mold and bacteria contain no chlorophyll and both are able to obtain food in a soluble form. Also, all mold and bacteria are killed or made dormant by low or high temperatures or when moisture is low. These factors are very important when considering the preservation of foods and will be studied in this chapter. Although bacteria and mold differ in some ways, the factors important in a discussion of food preservation are common to both. For this reason, they will be studied together. Learning the advantages of preserving food by drying and employing good drying procedures will be the outcome of these lessons.**

**The following diagram on the effect of temperature on mold and bacteria growth is offered to facilitate discussion while the students prepare materials and during the tests. It is best that the students discover the relationships through the activities; presenting this diagram before the activities might inhibit some problem solving.**





**DIAGRAM 45**

### **Preparation of Materials for Activities**

**Students will gain a better awareness of the need for cleanliness, sterilization and pasteurization in food preservation and preparation as they become involved in the preparation of materials for this chapter. Check in the local area for resources. Would the local meat market butcher be willing to donate bones? Or would he be willing to trade bones in return for the fat that is rendered while making gelatin? Could the farmer who slaughters an animal use some of the gelatin? The uses of gelatin can be a secondary objective learned in this series of lessons.**

**Agar, which is similar to gelatin, may be available. It is made with seaweed from the East Indies. It has some advantages over gelatin, one being a higher melting point. Gelatin can be used for these studies, though, and may be easier to secure or produce.**

**While the students are involved in the preparation of materials, concepts learned in other lessons (solutions, colloids, characteristics of fat, measurement, evaporation) can be reinforced through questioning and discussion.**

### **CULTURE**

#### **Materials**

## **Animal bones (uncooked or boiled)**

**Water**

**Scale**

**Pot**

**Procedure**

- 1. Crush the bones to small pieces.**
- 2. Put the bone pieces in a pot, cover with water and boil for 15 minutes.**
- 3. Cool. Skim off the fat. (The fat can be used.)**
- 4. Remove the bone pieces and retain the water.**
- 5. Grind the bones to powder; weigh.**
- 6. The water should equal 8-10 times the weight of the bones. Add more water if necessary to obtain this proportion.**
- 7. Return bone powder to the pot.**
- 8. Boil until evaporated to 1/2 the volume. The resultant liquid is gelatin.**
- 9. Pour gelatin into sterile dishes for the mold and bacteria studies or keep gelatin warm while the additions are prepared for the activities.**

**ALTERNATIVE CULTURE**

**If gelatin cannot be produced, potato, cassava, cooked egg white, or margarine can be sliced and put in dishes with lids and sterilized. The test results with this procedure, though, are not as definitive. It may be useful to have both types of culture dishes prepared and used, especially if the students seem unsure about the results.**

**Another alternative culture for growing mold and bacteria can be made with well cooked cereal. Put cooked cereal in dishes or small jars, cover, and sterilize.**

**If each group of students runs the full series of tests, you will need 18-24 culture dishes total for each group. This may be difficult. It is possible to run a test/activity, record and discuss results and then clean, prepare and sterilize the dishes for the next test, With this procedure, you will need 2 or 3 dishes for each group. Alternately, you can assign one test/activity to each group of students and have them conduct the tests simultaneously. This would require 18-24 dishes total for the class (4-6 tests).**

### **TO STERILIZE OR PASTEURIZE**

**Sterilizing, the killing of microorganisms, is done by placing the item (dish, stick) in an oven, heater, or dryer at a temperature of 45°- 50° C. for one hour. This is sufficient to kill most mold and bacteria, except the spore forming bacteria which require higher temperatures. Many spores resist higher temperatures and will sprout when placed in favorable conditions.**

**Pasteurizing its a modified, partial sterilization recommended for sun dried foods that may not have been kept at a high enough temperature for the length of time needed to kill microorganisms (mold and bacteria, pp. 172, 174). The process is modified so that the food is not cooked and the loss of nutrients is minimized. During the mold and bacteria lessons, it would be useful to emphasize the similarities between sterilizing, pasteurizing and food preservation methods.**



## **Sterilization in on Oven**

### **Materials**

**Items to be sterilized.**

**Oven or dryer able to heat to 70°- 80 C.**

### **Procedure**

**Heat items in oven at 70° - 80° C. for 10 - 15 minutes.**

## **Sterilization by Steam**

**Another sterilizing procedure uses steam and, thus, reaches higher temperatures and kills more molds and bacteria than the other procedure.**

### **Materials**

**Items to be sterilized**

**Water**

**Source of heat**

**Large pot or can with rack or platform**

**Lid to pot or can**

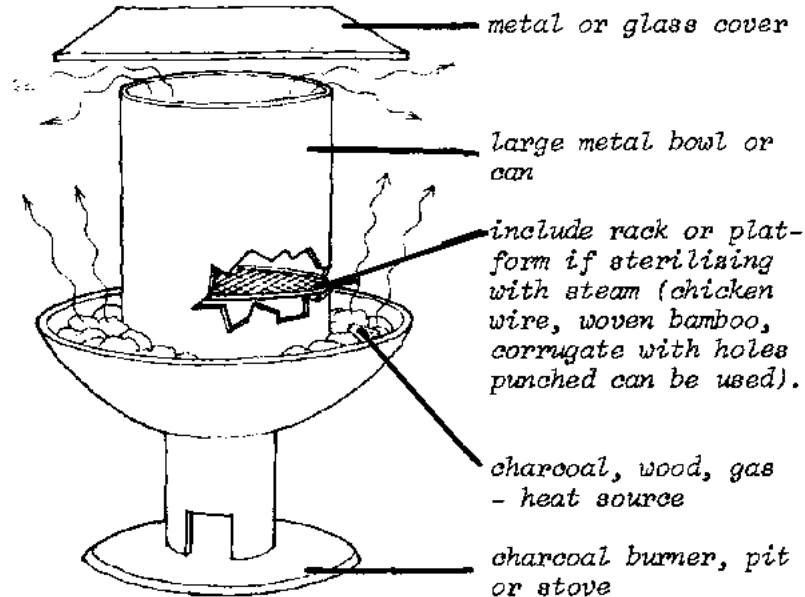
### **Procedure**

**Put 5 cm of water in the pot and place a rack or platform above the water. The dishes/jars**

**to be sterilized are put on the rack in the pot. Bring the water to the boiling point. Steam will be visible, escaping from the cover. Boil for twenty minutes. Remove from the heat source to cool. Keep the pot covered while cooling.**

**There are many ways to adapt available materials for sterilizing and pasteurizing. Some models of food dryers can reach temperatures sufficient for pasteurization and partial sterilization and can be used to prepare culture dishes for the mold and bacteria studies. It is useful to have another alternative, preferable a steam sterilizer. Students can compare results in the dishes/jars sterilized with the different procedures; this increases the opportunities for learning.**

**Oven or Sterilizer**

**DIAGRAM 46****To Make Transfer Needles**

Transfer needles are used to transfer mold or bacteria from their source to a sterilized dish or jar. Each time this is done, the student should sterilize the needle by heating the end of it in a flame before using the needle to transfer again. This transfer to a sterilized dish is called planting.

**Materials**

**Soft wood twigs or branches about the size of pencils**

**Sewing needles**

**Procedure**

**Push the needle into the end of the wood leaving the needle eye about 3 cm from the end.**



**DIAGRAM 47**

### **Activity III-1. PRELIMINARY INVESTIGATION OF MOLD AND BACTERIA**

**In this activity, students will observe some physical characteristics of mold and bacteria. This preliminary investigation is particularly important if the students have not discovered mold and bacteria during other food lessons and activities.**

**Materials**

**Source of bacteria and mold**

**Hand lens**

**Procedure**

**Have the students observe and record what they have noted about mold and bacteria. During the discussion, cover such questions as:**

**What does it look like?**

**Where is it found?**

**Have you seen it other places?**

**Are the samples different? How?**

**Are some larger?**

**How do they grow?**

**What is needed?**

**The preliminary discussion should bring out some questions to test. Sequence the test lessons according to the questions the students raise. If the students discuss the need for water for mold and bacteria growth, begin with this study. If the concern is focused on the type of food mold and bacteria grow on, begin with that study. Ask the students how they can check how bacteria and mold grow. For example: How can we test whether water is needed for mold or bacteria to grow? Have the students discuss and develop plans to answer the question. Let the students begin the tests/activities.**

**The following activities outline the kinds of tests students can perform for some of the basic questions about mold and bacteria. The students can gain more if they design the test procedures themselves; it is not necessary to limit the study to the questions presented here.**

### **Activity III-2 DO MOLD AND BACTERIA DIGEST COMPLEX FOODS?**

**In this activity, students will discover that mold and bacteria themselves digest many of the foods which we eat. This will reinforce the concept that foods must be prevented from**

**being contaminated by mold or bacteria. An example of a chart for students to use in recording their observations for this and the following activities is found after Activity III-6.**

## **Materials**

**Sources of mold and bacteria**

**Sterilized culture dishes**

**Pieces of protein, carbohydrate and fat**

**Transfer needles**

## **Procedure**

- 1. Transfer mold and bacteria to sterilized dishes, each containing a different food type.**
- 2. Label the dishes according to food type.**
- 3. Put the dishes in a warm place (18-35° C) for 2 or 3 days.**
- 4. Observe the various dishes. Are there differences in the size of the mold and bacteria from its previous size? Are there differences from one food type to another? What changes have occurred to the original foods?**
- 5. Record your observations and conclusions.**

## **Activity III-3 DO MOLD AND BACTERIA NEED WATER TO GROW?**

**In this activity, the necessity for water for bacteria and mold growth is investigated. This**

**is done by planting bacteria in wet and dry cultures and observing the differences over a period of a few days.**

## **Materials**

**Sources of mold or bacteria**

**Gelatin in sterile dishes**

**Light bulb dryer or other solar dryer with cover**

**Dry cereal or dried food in sterile dish**

**Cooked cereal or fresh food in sterile dish**

**Transfer needle**

## **Procedure**

- 1. Plant mold and bacteria in some gelatin dishes. Place half the samples on a light bulb dryer covered with a box or place them in a solar dryer covering the open dishes with a box or bowl. Place the other covered samples in a warm, dark place. Check all the dishes after a few days. Note the differences and record the results.**
- 2. Place a spoonful of dry cereal or a few pieces of dried food in a sterile dish with lid.**
- 3. Place a spoonful of cooked cereal or a few pieces of fresh food (same kind as dried) in a sterile dish with lid.**
- 4. Plant each dish with mold or bacteria.**

- 5. Put the dishes in a dark warm place for a few days.**
- 6. Check them. What has happened? How do the dishes differ?**
- 7. What can you conclude about the results?**

#### **Activity III-4 DO MOLD AND BACTERIA GROW WELL IN LIGHT AND IN DARK?**

**In this activity, students will study the effects of light and darkness on mold and bacteria.**

#### **Materials**

##### **Culture dishes**

##### **Source of mold and bacteria**

##### **Transfer needles**

#### **Procedure**

- 1. Plant some dishes with mold or bacteria.**
- 2. Place some of the dishes in a light place such as by a window.**
- 3. Place the other dishes in a dark place.**
- 4. After a few days, check the dishes. Observe the results and record your findings.**

#### **Activity III-5 DO MOLD AND BACTERIA GROW BEST IN COLD, WARM OR HOT PLACES?**

**In this activity, students investigate whether mold and bacteria grow best in cold, warm or hot places.**



## **Materials**

**Culture dishes with covers**

**Dryer or oven**

**Source of mold and bacteria**

**Transfer needles**

## **Procedure**

- 1. Plant dishes as in the other tests and cover with lids.**
- 2. Place one in a very cold place such as on a concrete floor in a well shaded corner.**
- 3. Place one in a warm place.**
- 4. Place one dish in a hot place such as a dryer or oven.**
- 5. Check the dishes after a few days. Record your findings.**

## **Activity III-6. DOES SUNLIGHT KILL BACTERIA OR MOLD?**

**In this activity, students will discover what effect direct sunlight has on the growth of bacteria and mold.**

## **Materials**

**Culture dishes**

**Source of mold and bacteria**

## **Transfer needles**

### **Direct sunlight**

#### **Procedure**

- 1. Put mold or bacteria in two sterile dishes.**
- 2. Place one of the dishes in open sunlight for several hours.**
- 3. Place the other dish in a warm dark place.**
- 4. After a few hours, remove the first dish from the sun and place it with the other dish.**
- 5. Check them after a few days. Record your findings.**

**Have the students prepare charts such as the on the following page. If the class has been divided into groups, with each group doing a different activity, have a table written on the blackboard, so that each group can record and share the results of its activity. Have the students discuss the differences they have noted and what these results mean for food storage.**

**What food sources did the mold prefer?**

**What sources did the bacteria prefer?**

**What conditions slowed or stopped the growth of mold and bacteria?**

**What conditions were necessary for bacteria and mold to survive?**

**What would you want to do to make food less appealing to mold and bacteria?**

## What does drying food in a solar dryer do that makes food last longer?

Although light and temperature affect the growth of bacteria, the amount of moisture is the significant difference. Lack of moisture alone is sufficient to prevent the growth of mold and bacteria. This should be emphasized as it might not be definitive from the tests and it is the major advantage of preserving food by drying.

	MOLD	BACTERIA	COMMENTS
I Fat			
Protein			
Carbohydrate HCl Iodine			
II Dry			
Wet (dark place)			
Dry food			
Wet food			
III Window (not direct light)			
Shade			

Direct sunlight			
Cold			
Warm			
Hot			

Table

## Chapter 6. Simple tests for food components

### BACKGROUND INFORMATION ON FOOD TYPES

Several of the tests in this chapter are used by chemists to analyze chemicals. Chemists look at, feel, smell and taste substances as part of preliminary analysis. By working with the groups, you can encourage students to test and record their results.

You may want to perform the tests by yourself beforehand to become acquainted with the results. This also gives you the opportunity to develop directive questions to ask the students as they experiment. You can also anticipate opportunities to re-emphasize things learned in other lessons—for example, evaporation and dehydration while students conduct Test 5, or solubility if basic chemistry lessons have been taught earlier.

In this chapter the students will:

1. learn the basic food types: Sugar, Protein, Starch and Fat by experimenting and observing differences.

**2. develop record keeping skills as demonstrated by the charts and tables produced after the food tests have been conducted.**

**3. keep diet records to learn what types of food they consume. Diet records, discussion and observation of animals will direct students to the need for balanced diets. Measurement of this learning can be done by having the students prepare menus or diets that contain the basic food types.**

**The activities are used to identify the basic food types: Sugar, Starch, Protein and Fat.**

### **PROPERTIES OF SUGAR**

**1. Sugar is soluble (Test 1). Simple sugars are absorbed in the human body by direct diffusion. Digestion, or chemical breakdown, is not necessary.**

**2. Sugar turns brown when mixed with iodine (Test 2).**

**3. Sugar has a sweet taste (Test 1).**

**4. When burned, sugar turns black and gives off water vapor. This is because it contains carbon and water (Test 4). The presence of carbon and water indicate that sugar is a carbohydrate. It is a simple carbohydrate. Because it is absorbed in the body directly (soluble), it is separated from other carbohydrates (starches) which require digestive reactions, starting in the mouth with the action of the enzyme, ptyalin, in the saliva.**

### **PROPERTIES OF STARCH**

**1. Starch is soluble.**

**2. Iodine turns blue when mixed with starch (Test 2).**

**3. When burned, starch turns black and gives off water vapor (Test 4). This is because starch, like sugar, is a carbohydrate.**

### **PROPERTIES OF PROTEIN**

**1. Proteins, such as those in meat, fish and egg whites, are large chemical compounds and require a series of digestive reactions to be broken down to amino acids which are absorbed and used by the human body.**

**2. Protein is not water soluble (Test 1).**

**3. Protein begins to break down in the presence of hydrochloric acid (Test 5). This is what occurs in the stomach.**

### **PROPERTIES OF FAT**

**1. Fats, such as palm oil or margarine, are large chemical compounds.**

**2. Fats are not water soluble (Test 1).**

**3. Fats are the only food type that change paper, leaving a smear on the paper, which appears translucent when held up to a light (Test 3).**

**There are several tests that students can perform in order to observe differences between the four basic food types: Protein, Fat, Starch and Sugar. The food tests will take 2 or 3 class periods. If students are interested and continue to test food items, this part of the unit could be extended.**

**You can divide the class into groups. Each group can run one or two of the tests and report to the rest of the class. Alternately, each group can run all the tests and compare their results with other groups.**

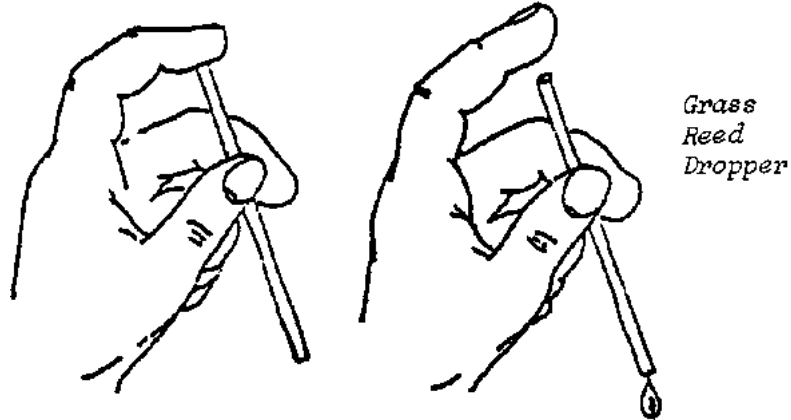
**The written directions for each test can be handed out to each group. This can save time and allow the teacher more time for questioning as the activities are in progress.**

**Choose food items that are locally available, but try to get at least one sample from each food type. The food samples can be cut ahead of time, or the students can cut or chop pieces from the items as they perform the tests.**

**Newspapers can be spread on the desks or tables to protect them as the chemical tests are in progress.**

**Have the students use only a small amount of food for each test. While testing is going on, you might question the students about mixing or keeping the food items separate. Emphasize the importance of control in science experiments.**

**Have the students practice using grass reed droppers or Bic pen droppers as accuracy with these takes trial and error. The diagram below shows how the grass reed dropper is held.**

**DIAGRAM 47**

**There should be an area of the room set aside for washing and rinsing used equipment such as jars and caps. The soap and water are also essential for students who accidentally get HCl on their skin. They must wash the area liberally with soap and water. The soap will neutralize the acid.**

**Following are the directions to be given to the students. You may want to circulate among the groups questioning the students about their process. "How did you crush the food sample?" "What happened to the rice when you put iodine on it?" "Does the sample smell different now?" The questioning should direct the students toward observing the difference between foods, the changes that take place, The questioning also can reinforce problem solving skills and the scientific method.**

### **Activity III- 7 FOOD TEST 1**



**This activity tests the effect of water on food samples.**

**Materials**

**Small jars**

**Samples of each food type**

**Water**

**Procedure**

- 1. Place food sample in a small jar. If solid, crush it. Fill jar 1/4 full with water. Mix. What happens?**
- 2. Taste a small amount of food. What does it taste like? Sweet, sour, bitter or no taste?**

**Activity III-8 FOOD TEST 2**

**In this activity students will test to see what effect iodine has on the food samples.**

**Materials**

**Bottle caps**

**Water**

**Iodine**

**Samples of each food type**

**Grass reed dropper or Bic pen dropper**

### **Procedure**

- 1. Place small food sample in a clean bottle cap. If solid, crush it first. Add a few drops of water.**
- 2. Add a few drops of iodine to the sample. Do not taste this - iodine is POISON. What happens?**

### **Activity III-9 FOOD TEST 3**

**Students will test to see if the food samples have any effect on paper.**

#### **Materials**

**Samples of each food type Brown paper**

#### **Procedure**

- 1. On a small piece of brown paper, place a food sample. If solid, crush it. Wipe off extra food, leaving a spot on the paper.**
- 2. Set this aside and check it later. What happens? Hold the paper up to the light. What do you observe?**

### **Activity III-10 FOOD TEST 4**

**Here, students will observe the effect of heat on the food samples.**

#### **Materials**

#### **Food samples**

**Bamboo tweezers (see Appendix A).**

**Bottle caps**

**Candle**

**Piece of glass**

**Procedure**

- 1. Place a small amount of food in a clean bottle cap. Crush it if necessary.**
- 2. Using bamboo tweezers, hold the bottle cap over a flame of a candle. Trim the wick to get a small flame with no smoke. While doing this, hold a piece of glass over it. What happens? Continue heating it. What happens?**

**Activity III-11 FOOD TEST 5**

**In this activity, students will test the effect of hydrochloric acid (HCl) on the food samples.**

**Materials**

**Hydrochloric acid**

**Food samples**

**Small jars**

**Water**

**Tin labelled ACID****Candle or burner****Procedure**

- 1, Place small amount of food sample in a small jar and cover with water.**
- 2. Mix the solution thoroughly.**
- 3. Heat slowly over a candle or burner. Record what happens.**
- 4. Carefully add a few drops of HCl to the food sample. Record what happens.**

**Important. HCl is an acid and can burn your hand. When finished, empty the mixture into the tin marked ACID. Put the jar or test tube into the basin/bucket with soap and water. Wash.**

**During the next science period, the groups can report on their findings by developing a chart on the blackboard.**

Food Types	Water	Iodine	Paper	Heat	HCl
Sugar					
Starch					
Protein					
Fat					

**TESTS**

**Have the students discuss the results. Why do certain foods react to only some of the**

**tests? Direct the discussion to bring out four basic reactions. Introduce the food type terms: Protein, Fat, Starch and Sugar. Have the students develop lists of foods in the four groups. Point out by referring to the test results that sugars are carbohydrates as are starches. The test results vary because of the size of the chemical compounds. In the future lessons, this difference will be clarified through digestion experiments and activities. Have the materials ready should some conflict about food items come up in the discussion. If there is some conflict, have the students test the food items in question. Discuss the basic uses of the food types. Carbohydrates and Fats produce energy, while Proteins build and repair tissues as well as provide needed substances in the body. (Refer to "Food Preservation Resource Packet.")**

**Ask the students to write down what they eat (their diets) each day for the next week. A diet record form is found in Chapter 7.**

**What types of food do they eat each day?**

**How much of each food type?**

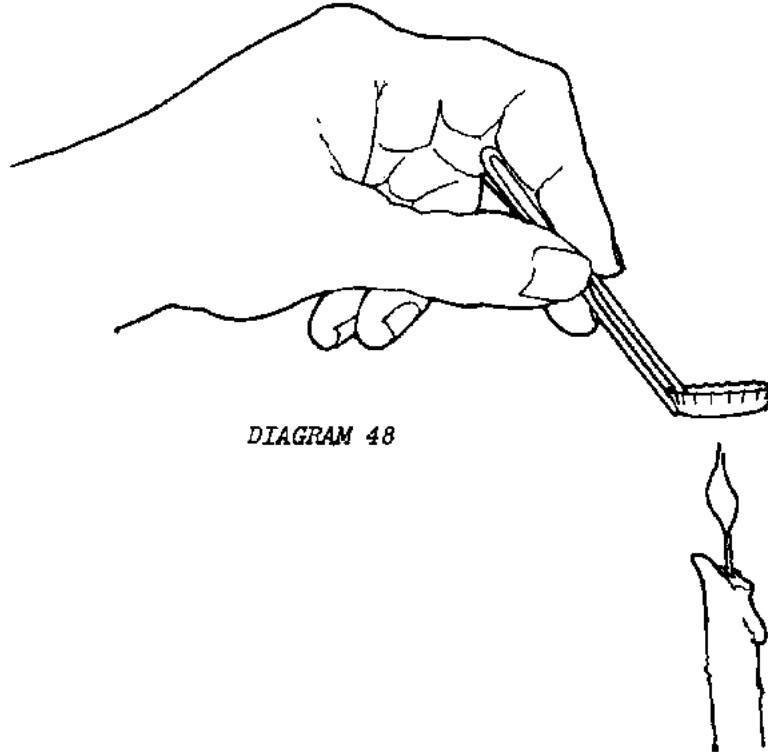
**What season is it?**

**Do they eat different foods at other times of the year?**

**What are the differences in diet throughout the year?**

**Why? What foods are available in each season?**

**If the students are finished with the food tests at this point, proceed with the lessons on digestion and nutrition including the need for vitamins and minerals. When the students have their diet records ready, use the reports on diets to develop a discussion on nutrition and the need for well-rounded diets.**



*DIAGRAM 48*

**DIAGRAM 48**

## **Chapter 7. Digestion**

**This chapter can be presented in 6 to 14 lessons dependent on what concepts you choose**

**to include and the interest and skill level of the science students.**

**For example, if the students have not studied solutions, colloids and suspensions, you may want to set up materials and activities for these students to determine the differences. This activity could precede the food test lessons. This is appropriate at the beginning of digestion studies because the behavior of food substances in water is important in digestion (hydrolysis). This activity would involve samples of substances: sugar, gelatin (protein), starch and oil (fat). These samples would be mixed with water. Each mixture is shaken and allowed to stand for about 5 minutes. The students then record the results and discuss their findings. The format of the food test lessons can be used for this activity.**

**Through the activities and discussions, the students will develop an understanding of the following concepts and be able to apply them to their daily lives.**

**1. Digestion is the chemical change of foods into particles that can be absorbed by the body cells.**

**2. Fats, proteins and carbohydrates must be digested to make possible their absorption and entry into the body cells. Fats, proteins and carbohydrates all contain Carbon (C), Hydrogen (H), and Oxygen (O) used to produce energy. Proteins also contain Nitrogen (N), Sulfur (S), and Phosphorus (P) used to produce chemical substances essential to life. Proteins are used to build and repair body tissues. We are about 20% protein by weight. The body depends on proteins to produce enzymes, hormones and hemoglobin. In addition, proteins are used to regulate body fluids. An insufficient amount of protein in the diet causes fluids to build up in parts of the body. This is why children with protein deficiencies (Kwashiorkor) have distended stomachs.**

**3. Hydrolysis is the breaking down of a chemical compound by combining it with water (H<sub>2</sub>O).**

**4. An enzyme is a catalyst that speeds the hydrolysis of foods. The general equation for a digestive equation is:**

**Food + water**  $\xrightarrow{\text{enzymes}}$  **food parts**

**The equations for the basic food types are:**

**Fat + water**  $\xrightarrow{\text{lipase}}$  **fatty acids - glycerine**

**Protein + water**  $\xrightarrow{\text{proteinase}}$  **amino acids**

**Carbohydrate + water**  $\xrightarrow{\text{carbohydrase}}$  **glucose**

**5. Glands produce the digestive juices such as saliva, gastric juice, pancreatic juice and intestinal juice. These digestive juices contain enzymes.**

**6. Proteins, fats and carbohydrates are digested as they move through the alimentary canal which consists of five main parts: mouth and pharynx, esophagus, stomach, small intestine and large intestine.**

**7. Water, vitamins, simple sugars and minerals (inorganic salts) are taken in the body by direct diffusion; digestion is not necessary.**

**On the following pages is a table on the composition of some foods to assist you in generating discussion questions and clarifying students' research.**



## Preserving Food by Drying: a Math-Sci...

FOOD	Protein	Fat	Carbo.	Ca	P	Fe	Vitamin				
							A	B	C	D	E
Avocado	2	23	7				++	++			
Banana	1		23	.01	.03		++	+	++		
Barley	9	1	78	.04	.40	.01		++			
Beans (navy)	23	2	60	.16	.47	.01	+	++			+ sprouted
Beans (soya)	37	17	28				+	++			+ sprouted
Beans (lima)	18	2	66	.07	.34	.01					
Beans (lean)	22	3		.01	.24		+	+	+		+
Butter	1	85		.02	.02		+++				+ +
Cabbage	2		6	.05	.03		+	++	+++		
Cheese	28	37	4	.93	.68		++				
Chicken	22	3		.01	.23		+	+			
Coconut	6	57	32	.06	.15		+	++			
Corn Starch			90								
Dates	2	3	78	.07	.07	.01	+	++			
Eggs	13	10		.07	.18		+++	++			+ +
Egg (whites)	12	1		.01	.01						
Egg (yolk)	15	33		.14	.53		+++	++			+
Flour (white)	11	1	75	.02	.09			+			
Flour (whole wheat)	14	2	72	.03	.24		+	++			+
Gelatin	91						+	+			
Lamb	20	13		.01	.22		+	+			
Lard		100					+				+

COMPOSITION OF SOME FOODS (Adapted from Handbook of Chemistry, Lange ed.)

## Preserving Food by Drying: a Math-Sci...

FOOD	%	%	%	%	%	%	Vitamins				
							Protein	Fat	Carbo.	Ca	P
Lenon	1	1	9	.04	.02		+	+	+++		
Milk	3	4	5	.12	.10		+++	++	+	+	+
Noodles	2	3	17								
Margarine	1	83					+				+
Olive Oil		100					+				+
Onions	2		9	.03	.05		+	++	++		
Orange	?		11	.05	.02				+++		
Parsley						.02		++			
Peanuts	26	39	24	.07	.40		+	++			
Peppers (green)	2		5		.03		+	++	+++		
Pineapple			14	.02	.03		++	++	++		
Pork	17	31			.01		+	++			
Potato	3		20	.01	.06		+	++	++		
Rice	2		23		.02						
Sardines	23	20		.03	.26						
Spinach	2		3	.07	.07	.01	+++	+	++		
Squash	1	1	9	.02			++				
Sugar			100								
Tomato	1		4	.01	.03		++	++	+++		
Turnips	1		8	.06	.05		+	++	++		
Watercress	1	1	4	.20			+++		+++		
Whitefish	23	7		.02	.26		+	+			
Yeast	11	1	21				+	+++		++	

**COMPOSITION OF SOME FOODS (Adapted from Handbook of Chemistry, Lange ed.)  
(cont'd.)**

## Abbreviations

**Ca - Calcium**

**P = Phosphorus**

**Fe = Iron**

**+ = vitamin present**

**++ = good source of vitamin**

**+++ = excellent source of vitamin**

**Blank space = no appreciable amount of substance**

## Activity III-12 DIGESTION INTRODUCTORY ACTIVITY

**In this activity, students will begin to understand the digestive reaction, the breaking down of food for absorption, as they solve the introductory problem and discuss their solutions. (A written assignment can be used also to measure the students' knowledge of digestion.)**

Box - closed with holes cut out on all sides

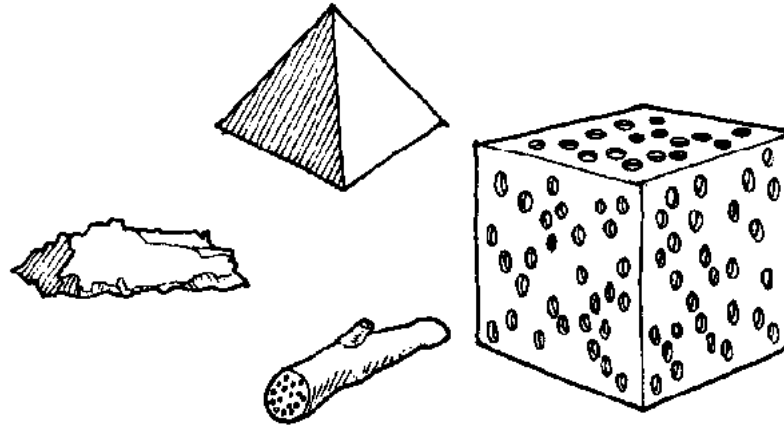
Large dirt clod or piece of termite hill

Large piece of cassava or other fibrous root

Large piece of wood - block, cylinder, pyramid shape

*These must  
be larger  
than the  
holes  
in the  
box*

## Materials

**DIAGRAM 49**

**Have one set of materials for each group or team of students. Set the task and have each team work on the problem collectively and then share their results. An alternative to this would be to have one set of materials and direct questions to the total class, although there is generally less problemsolving with this approach.**

**The box is completely enclosed; the walls have small round holes. These holes cannot be made larger. How can the dirt, root and wood be moved into the box?**

**Give the problem and let the groups work on solutions. While the groups are working you can move from group to group and ask questions to stimulate problem-solving.**

**What solution (s) have you come up with?**

**Does that solution require work (energy)?**

**What steps are involved in the solution?**

**What is doing the work?**

**What arrangement or change in the materials is necessary to get them in the box?**

**Are other materials (substances) needed to change the objects?**

**Are there other solutions to the problem?**

**Do the different objects require different solutions?**

**When the groups seem to be at a stopping point, ask for oral reports from the groups.**

**Again, ask directive questions during the reports and discussion. Some groups will offer breaking/cutting up the materials as the solution. Others may offer dissolving substances with water as another solution. Discuss these different solutions, emphasizing that different agents (knife, water) are required. Through the discussion, bring out that this process is like digestion in the human body. Food must be broken down mechanically and chemically by hydrolysis and enzyme action in order to be absorbed by body cells in much the same way as the objects had to be broken down, using such things as a knife and water, in order to be put in the box. Someone may offer the use of chemicals as a solution to the problem. Ask how the chemical is used. Does it go in the box as well as the material? Develop the use of enzymes for digestion from this response. Enzymes are catalysts/agents that speed up hydrolysis. If the problem-solving and discussion demonstrate that students understand the process, the general food equation can be presented.**

**FOOD + WATER  $\xrightarrow{\text{enzyme}}$  FOOD PARTS**

**The terms: hydrolysis, enzyme, catalyst, digestion can be introduced as the students generate definitions out of the problem-solving.**

**Note: The next series of activities involve digestive reactions of the basic food types. Some of the activities require materials that may not be easily available. These can be eliminated without losing continuity although they do serve as reinforcers of the concepts. The teacher may wish to tell the students what the results of those activities would be.**

### **Activity III- 13 DIGESTION OF CARBOHYDRATES**

**Through experimentation, the students will learn that digestion of carbohydrates begins in the mouth. Mechanical (chewing) and chemical (ptyalin in saliva) breakdown is necessary for hydrolysis of carbohydrates. Starches are broken down to simple sugars. The equation for this process is:**



#### **Materials**

#### **Starch**

#### **Cooked potato**

#### **Crackers, tortilla or bread**

#### **Benedict's solution (Indicator of sugar)**

#### **Food samples from food tests**

#### **Raw potato**

**Wax****Iodine (Indicator of starch)****Jars or test tubes****Candles or burners**

**The first step in these activities is to have the students test the food samples used in Chapter 6 with Benedict's solution to determine what it indicates. The solution changes to a yellow-red color in the presence of simple sugars. If you are not able to get Benedict's solution, you can proceed with the other exercises reinforcing the students' observations of changes in the presence of starch. Through discussion, you can develop the concept of starch breakdown to sugar.**

**A. WHAT DOES BENEDICT'S SOLUTION TEST?**

**Take a small food sample of protein, fat, sugar and starch, if solid, crush it and mix each sample with a little water in a jar or test tube. Heat the mixtures, then add a few drops of Benedict's solution to each jar. What happens? Record any change in color.**

**Discuss the results. When the students have determined what Benedict's solution indicates, proceed to the other activities.**

**B. DOES SALIVA CHANGE BENEDICT'S SOLUTION?**

**Have the students work in small groups. Each group member chews a different food sample for a few minutes and collects saliva in a jar or test tube. Have one student in each group chew a small piece of wax and collect saliva. After the saliva is collected, direct the students to add about 1 teaspoon (5 ml or cc ) of Benedict's solution. Heat the jars over**

**burners or candles for about 30 seconds. What happens to the sample of just saliva?**

### **C. HOW DO ENZYMES WORK - CARBOHYDRATES?**

**Ask groups of students to arrange eight jars containing the materials listed below. Suggest that the students find a way to be able to identify the contents of the jars (label, code, record).**

- 1. 2 jars with 5 ml of water and a small piece of raw potato in each.**
- 2. 2 jars with 5 ml of water and a small piece of cooked potato in each.**
- 3. 2 jars with 5 ml of water, 10 ml of saliva and a small piece of raw potato in each.**
- 4. 2 jars with 5 ml of water, 10 ml of saliva and a small piece of cooked potato in each.**

**Test one jar of each sample (1-4) with iodine. What are the results? Do the samples vary? Does the presence of saliva make a difference?**

**Let the other samples (1-4) stand for 15 minutes. Add 10 ml of Benedict's solution to each jar and heat each jar for thirty seconds. What happens? Record any changes that occur in each Jar.**

**As the students are experimenting, move from group to group to question them. In addition to the questions in the above paragraphs, you may wish to discuss the use of controls with them.**

**Have the students report their findings by developing a chart on the blackboard. During the discussion, introduce the equation that describes the action the students observed. Introduce the term, Ptyalin, the enzyme in saliva that begins digestion of carbohydrates to sugars by speeding up hydrolysis of carbohydrates.**



**Carbohydrates + water**  $\xrightarrow{\text{Ptyalin}}$  **Sugar**

#### **D. ANOTHER TEST - HOW DOES PTYALIN WORK?**

**Have the students test pieces of cracker, bread or tortilla with iodine. By this point, the students may be familiar with the food type. Ask the students what type of food the cracker, bread or tortilla samples are. If the students know this, begin the activity at the next step.**

**Chew a piece of cracker, bread or tortilla for a minute. Take the chewed cracker out and put some of it in one dish and some in another. Add a few drops of iodine to one dish. Add a few drops of Benedict's solution to the other dish. What happens? What can you conclude about saliva?**

#### **Activity III-14 DIGESTION OF FATS**

**These activities emphasize emulsifying fats. Here you can encourage thinking about increases in surface area. Why is physical or mechanical breakdown of food necessary? What are the advantages? Why is mixing food and water important? Can enzymes react with food more readily if the food is in smaller pieces?**

**The equation for fats:**

**Fats + water**  $\xrightarrow{\text{lipase}}$  **Fatty acids + Glycerine**

**The chemical tests for fats, fatty acids and glycerine are complicated and involve solutions and equipment not readily available. Focusing on emulsification as well as comparing the reactions of different foods should give the students an understanding of digestion and the rudiments of nutrition.**

**Materials**

**Water**

**Hydrochloric acid**

**Vinegar**

**Jars**

**Oil**

**Soap**

**Gum Acacia**

**Bucket/basin**

**Assign groups of students the following problems:**

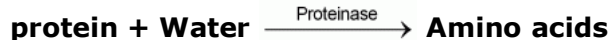
- 1. Put equal amounts of water and oil (about 60 ml ) in a small jar. What happens? Mix them. What happens? What size are the drops?**
- 2. Add an equal amount of vinegar. Mix or shake. What happens? What size are the drops?**
- 3. In another jar, add equal amounts of water and oil. Add some gum acacia. What happens? Mix and note the change. Note size of drops.**
- 4. In another jar, add equal amounts of water and oil. Add about 15 ml of hydrochloric acid. Mix carefully. Note any change.**

**As students discuss their findings, reinforce the concepts of hydrolysis and the advantages of mechanical and chemical breakdown of foods. Introduce the equation for the digestion of fats. You may want to include some explanation of fatty acids and glycerine and how the body uses these substances.**

### **Activity III-15 DIGESTION OF PROTEINS**

**As with fats, a series of steps are necessary to break down proteins to amino acids. We must replenish our supply of essential amino acids daily because the body does not store them. Amino acids, like fats and carbohydrates, can be stored for energy but not as amino acids necessary to tissue repair and building or the production of hormones and enzymes.**

**The equation for protein digestion:**



**The activities involve the first steps of protein breakdown, as occurs in the stomach. Further breakdown occurs in the small intestines.**

#### **Materials**

**Hydrochloric acid**

**Egg whites (boiled) or meat**

**Pepsin**

**Fresh pineapple or juice squeezed from papaya leaves**

**Water**

## **Jars**

## **Milk**

## **Candles or burners**

## **Procedure**

**1. Put a small amount of milk (about 60 ml ) in two small jars. Add 15 ml of hydrochloric acid to one jar. Add 15 ml of vinegar to the other jar. What happens? Why? Do the same changes occur in both jars? Why?**

**2. This activity takes 1-2 days to complete. The students can proceed with other activities, checking the results of this activity during the next lesson.**

**Set up four jars (test tubes) with pieces of egg white. Add one of the following to each jar of egg white. (Meat can also be used).**

- a. Water - 5 ml**
- b. Pepsin solution - (1g pepsin, 50 ml H<sub>2</sub>O, and a few drops of HCl.**
- c. Water - 15 ml and a few drops of HCl.**
- d. Pepsin - 15 ml and a few drops of HCl.**

**Allow the jars to set 24 to 48 hours. Observe and record the results.**

**Which jar showed the most change?**

**What can you conclude about pepsin?**

**Where in the body do these chemical reactions take place?**

**How did saliva react with egg white in the earlier experiments?**

**During the discussion of the results, introduce the equation for protein digestion. Emphasize hydrolysis and enzyme action in the stomach.**

**3. Set up 2 jars with egg white pieces. Add 15 ml fresh pineapple Juice to one jar. Boil an equal amount of Juice and add it to the other jar. Allow the mixtures to set for 48 hours. Observe and record the results. What can you conclude about pineapple juice? Why was one jar of juice boiled? (This experiment can be done with juice extracted from papaya leaves. They contain the same plant enzyme. Or egg white or meat pieces can be wrapped in crushed papaya leaves and allowed to set.)**

### **Activity III-16 ANATOMY OF DIGESTIVE SYSTEM**

**Students dissect fresh fish to observe the digestive system (alimentary canal). This activity can be used to summarize the findings in the other exercises, keying the chemical reactions to the various parts of the system.**

**After the fish have been dissected, they can be cleaned and prepared and put in one of the food dryers!**

#### **Materials**

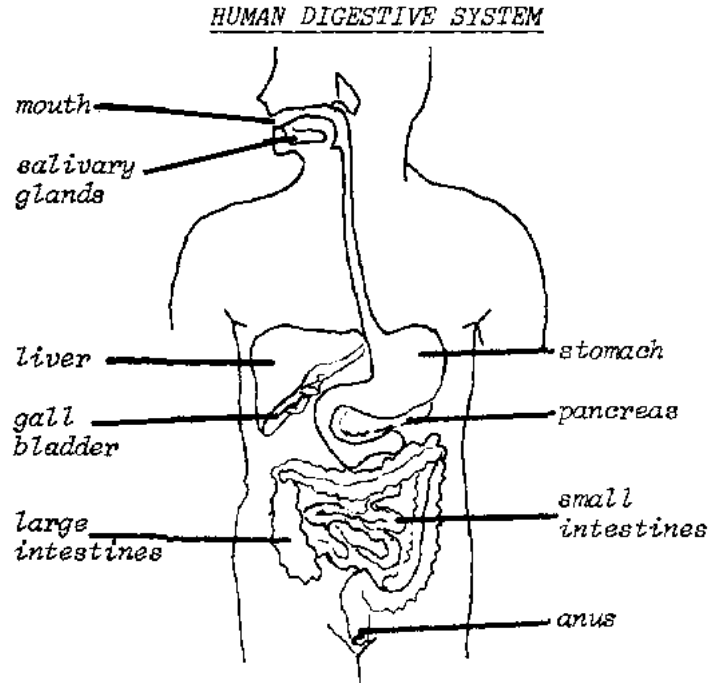
**Fish, frogs or toads**

**Knives or single edge razors**

**Newspapers for desks or Food dryer tables**

**The students can work individually or in pairs. Direct the students to cut the fish from the mouth to the anal area, taking care not to cut any organs. Trace the alimentary canal - the**

**mouth, the esophagus, the stomach and the intestines to the anus. Can you find the liver and gall bladder? Move from group to group to check progress. Compare what you find with the diagram below.**



**DIAGRAM 50**

**At this point, you may want to summarize the digestive system activities or have the students prepare the fish for drying (refer to Part II), Following are Further Studies on**

**vitamins and minerals which give the students more to work with on their diet records. In fact, the diet records can be used as the focus for the summary discussion.**

**On the following pages are vitamin and mineral charts to use for the lessons. Also, a sample of a diet record form which the students can use at the end of this study, follows the charts.**

## **Further Study**

### **Vitamins and Minerals**

**These lessons involve the transfer of information. As such they may be scheduled at a number of points in the nutrition studies. They supplement the digestion and other nutrition activities. They can be introduced in the summary discussions. The students can supplement their diet records and meal planning work with this information.**

**Activities studying vitamin and mineral needs are complex and take long term efforts. If the school has a poultry farm, students with high degrees of interest may study v-tamin and/or mineral needs in poultry as an independent special study.**

**Another supplementary activity could be a field trip to a local health center including discussion with center staff: a physician, public health nurse or health auxiliary for example. This may be especially useful in areas where there is a recognized deficiency that can be overcome with a change in diet. Alternately, a health practitioner can be invited to the school as a guest speaker or you may want to coordinate a community workshop with the local health facility staff, having the science students help with the planning and presentation.**

**Reproducing the charts that follow on a hectograph or similar device may be useful.**

**Sample for Diet Record****(Record sheets can be reproduced on hectographs or copy machines.)****Name****Date**

MEALS	QUANTITY	PROTEIN	CARBO-HYDRATES	FAT	VITAMIN	MINERAL
Breakfast						
Lunch						
Dinner						
Snacks						

**Daily Food Intake**

Mineral	Function	Source
Calcium	Good bone and tooth development. Prevents rickets if vitamin D is present. Important in blood clotting and muscle action.	Milk, cheese, egg yolk, dried beans, green vegetables and nuts.
Phosphorus	Good bone and tooth development.	Cheese, chocolate, egg yolk,



## Preserving Food by Drying: a Math-Sci...

Phosphorus	Good bone and tooth development and nervous tissue.	Cheese, chocolate, egg yolk, dried beans, peas, peanuts, whole wheat flour, soybean flour and seafood.
Iron	Making hemoglobin in red blood cells.	Liver, heart and kidney, raisins, dried apricots, peas, lima beans, whole wheat flour, oats, spinach, onions, cabbage, bulgar wheat.
Iodine	Production of thyroxin.	Seafoods, iodized salt, and vegetables grown in soil containing iodine.
Flourine	Good teeth and eye tissue	Some waters, fruit and vegetables grown in soil containing flourine.
Sodium	Essential to blood plasma, lymph and body tissues. Aids digestion.	Salt, baking soda, spinach, cabbage and tomato.
Chlorine	Same as sodium.	Salt, lettuce, spinach, cabbage, bananas, beans, corn and seafood.
Sulfur	Making body proteins	Eggs, cabbage, fish, meat, corn, cheese and beans.
Magnesium	Tissue building, mainly teeth, bone and muscles.	Greens, cabbage, tomato, lemon, banana, pineapple, wheat, rice and barley.
Potassium	Good tissue tone.	Potato, spinach, beans, tomato, lime and lemon.
Manganese	Aids in carrying oxygen from lungs to cells.	Watercress, parsley, egg yolk and some nuts.

**MINERALS**

Vitamin

Function

Source

A	Maintains a moist covering in eyes, respiratory system, digestive system and urinary system. Prevents night blindness.	Green, leafy vegetables, yellow vegetables, liver, butter and eggs.
B <sub>1</sub> (Thiamin)	Prevents beriberi. Keeps nervous system healthy. Promotes good appetite and good digestion. Helps the body use carbohydrates.	Milk, eggs, peas, beans, peanut butter, meats and whole-grain or enriched cereals.
B <sub>2</sub> (Riboflavin)	Keeps eyes and skin healthy keeps up general body resistance to disease, promotes health of nervous system.	Eggs, pork, cheese, beef, lamb, liver, broccoli, milk spinach, fresh green peas, and green vegetables.
Niacin	Prevents pellegra, keeps skin healthy, protects health of nervous system, stimulates appetite.	Milk, lean meats, tomato, green peas, fish, beans, many leafy vegetables, eggs liver, fish, nuts, whole-grain cereals.
B <sub>12</sub>	Prevents pernicious anemia. Keeps number of red blood cells at a normal level.	Liver, green vegetables.
C (Ascorbic Acid)	Prevents scurvy. Keeps blood vessels healthy. Contributes to good bone and teeth formation.	Fresh vegetables, fresh citrus fruits and tomatoes.
B <sub>6</sub> (Pyri-	Essential for hemoglobin formation; metabolism of amino acids. Absence	Grains, seeds, legumes, liver, milk and egg yolk.

doxin)	Impairs growth.	
E (Toco- pherols)	Absence causes sterility in either sex. Influence growth and healing.	Vegetable oils, lettuce, beans, rice, corn, meat, meat, milk and eggs.
K	Promotes normal blood coagulation.	Green vegetables, tomatoes, vegetable oils and egg yolk.

### VITAMINS

## Chapter 8. Preservation treatments

There are four steps in the preservation of food by drying: the pre-drying treatment, the drying, the post-drying treatment, and the storage. The actual drying of the food was studied in Part II. ( See p.87) This chapter addresses the remaining three steps of the preservation process.

### BACKGROUND INFORMATION ON PRE-DRYING TREATMENTS

Fruits, vegetables, meat and fish are treated before drying to preserve nutrients and the natural color and to slow the enzyme action that breaks down the food. If the students have studied digestion (Chapter 7), they will be aware of the action of enzymes. Otherwise, you may want to use examples of food left out in the open to show the breakdown that occurs. Choose some food item that is not obviously overgrown with microorganisms. Comparing a just ripe mango to one that has fallen and begun to discolor and soften should illustrate enzyme action. The various treatment methods slow this process down. Treating vegetables by blanching, in fact, loosens the tissues and the drying is quicker.

Treating foods prevents the loss of nutrients. Vitamins A, E, and many of the B's are broken down by light and oxygen. Vitamin C is destroyed by heat. There will be some loss

**with any preserving method but some of the treatments will minimize the loss.**

**The temperature range of the dryer has an effect on the preservation of color and nutrients as was mentioned in the food drying section. The temperature of the dryer, the availability of treatment substances, the humidity of the air, and the availability of storage containers need to be taken into account as the students prepare food for drying. It is possible to clean, cut and dry food in dryers without having to use any of the treatment methods before drying. There is, however, more nutrient loss if drying without pre-drying treatment. If the temperature in the dryer reaches 60° C , enzyme action in vegetables can be stopped, making the vegetables palatable even after long term storage. If the temperatures are kept higher than 60° C for long periods, however, food can start to cook and scorch, and there is a high loss of nutrients.**

**Although it is possible to dry and store many foods without any treatment prior to drying, the various treatments are presented to give you and the students more options. There is a wide range of methods offered, and experts do not agree on the amount of treatment substance to use, the length of time of the treatment or the preparation of the food type for drying. This is due to the fact that many factors are involved in the drying of food. Also, the experts emphasize different results, some want to minimize nutrient loss while others want to extend storage life. During the lessons when the students are preparing food for the dryers, it is important to emphasize the factors affecting food preservation and the purpose of different methods.**

**Factors affecting food preservation by drying can be summarized as the following: (See "Food Preservation Resource Packet").**

- 1. size of food pieces**
- 2. temperature of dryer**

- 3. moisture content of food**
- 4. humidity**
- 5. air movement - in dryer - in surroundings**
- 6. treatment method used**
- 7. type of storage containers available**
- 8. type of food - fruit, vegetable, meat, or fish**

**The major reasons for treating foods before drying them can be summarized as the following:**

- 1. preserve natural color**
- 2. preserve nutrients**
- 3. stop decomposition (enzyme action)**
- 4. make drying even**
- 5. extend storage life**

**Begin the food drying lessons with types of food that do not need treatment before drying. Onions and peppers can be used. Encourage the students to keep records. How was the food cut? (See p. 89, pp. 175 - 177). How thick were the pieces? How much did the food weigh before drying? What size? (Refer to food drying activity, Chapter 3).**

**As the lessons proceed, introduce the various treatment methods. Start with the less**

**complex processes, such as blanching and adding an anti-oxidant, and move on to the more complex processes, such as suffering and salting. This can only be done if there is a type of food available for each of the treatment processes. If this is not the case, plan the lessons around the foods that are available to dry. This may change the sequence of treatment presentations. The important thing, though, is to encourage the students to test different procedures, keep thorough records and learn how to weigh the factors involved in drying and storing and develop methods useful for the local area. Have the groups of students experiment with different preparations and treatments. With thorough record keeping, by the end of this book, the students should have the information needed to produce a table listing local foods and the most effective preservation technique for each food. You may want to reproduce copies of the local food preservation tables for the students to take to their villages and for community residents who may have been involved or are interested. Another way to share this information with the community would be at the school open house. Have groups of students demonstrate the steps in food preservation using the equipment the science class(es) has built. Of course, special community workshops could be offered as well.**

**Explanation of each of the treatments follow along with tables of some fruits and vegetables to help you get started and to facilitate planning the sequence of lessons for treatment, drying and storing.**

**The information in this section was developed on the farm, in classes and in the kitchen. The book, Putting Food BY and the Organic Garden and Farming magazine and the report from the "Food Preservation and Storage" workshop in Tanzania were also used to develop this section.**

## **PRE-DRYING TREATMENTS**

### **ANTI-OXIDANTS**

**Some foods, when exposed to the air, oxidize quickly, turning brown. This especially is true of light colored fruit. Anti-oxidants are acids that prevent oxidation. Ascorbic acid\* (Vitamin C) is the most effective antioxidant.**

**It is water soluble. The solution is sprinkled on the fruit as it is being sliced for the drying trays. Turning the pieces over a number of times while slicing and sprinkling will assure a sufficient coating of ascorbic acid. The nutrient value of the fruit is improved also by adding vitamin C. One cup of solution will treat about 5 quarts of cut fruit.**

### **Materials**

**Water**

**Ascorbic acid**

**Source of heat**

**Food to be treated**

### **Procedure**

**Boil water for 20 minutes and cool it before preparing the solution. It is important to use pure water while preparing food for drying as water borne microorganisms can cause much food spoilage. The proportion for mixing the solution is 4 ml of ascorbic acid crystals to 240 ml of pure water.**

### **BLANCHING**

**Vegetables contain enzymes which cause decomposition while drying if not destroyed by heat first. Blanching, exposing vegetables to full steam (100° C See pp. 175 - 177) stops enzyme action and protects the natural color. Also, because enzyme action is stopped,**

**nutrients are preserved.**

## **Materials**

**Water**

**Cover for pot**

**Wire rack, bamboo, or reed basket or clean cloth**

**Pot, bowl or basin**

**Source of heat**

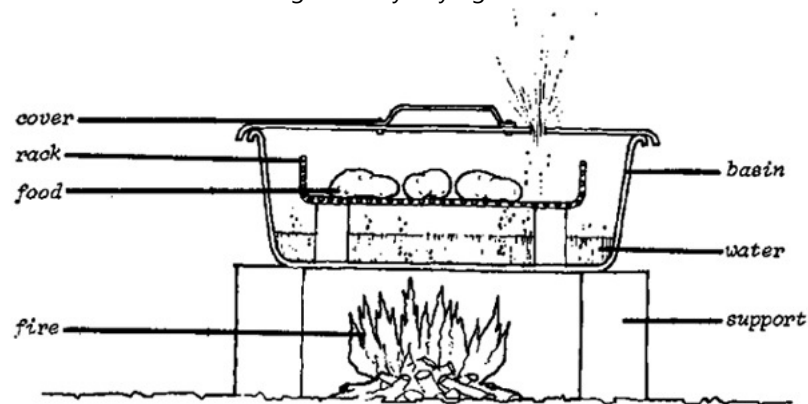
**Tin or flat rock**

**Food to be treated**

**A large pot, bowl or basin can be used for blanching. Put about 5 cm of water in the pot. The cleaned and cut vegetables can be placed in a wire rack, a bamboo or reed basket or a piece of clean cloth tied loosely.**

**The rack is placed in the pot above the water when there is full steam. A lid or cover is put on the pot. Blanching time varies for the type of vegetable; thicker or denser vegetables are blanched for a longer period of time than leafy vegetables. It may be necessary to put a tin or a flat rock in the pot so that the rack or basket sits above the water. If a cloth is used, knot it around a stick that can rest on the top edge of the pot to keep the cloth out of the water.**



**DIAGRAM 51**

**After blanching, remove the vegetable pieces and lay them on a clean cloth to soak up the extra moisture and then arrange them on drying trays. Blanching times are listed on the tables at the end of this section. Experiment with local vegetables using the samples listed in the tables as a guideline.**

## **SULFURING**

**Sulfuring fruits before air or sun drying slows down enzyme action and preserves the fruits' color. It protects vitamins A and C. It also protects against insects and mold, although if a closed dryer (such as a solar dryer) is used, insects are not a problem. Also, as mentioned earlier, if the temperature in the dryer is high enough, mold and bacteria growth are inhibited. As with other treatment methods, sulfuring is an extra assurance that the dried food will keep for longer periods of time and will be nutritious and palatable.**

## **Sulfite Soak**

### **Materials**

**Pure water**

**Food to be treated**

**Sulfite substances (see below)**

**Bowl or basin**

**This treatment involves preparing a solution with any number of sulfite compounds. The food pieces are then soaked in the solution for 15 to 30 minutes. Sulfite substances that can be used are:**

**sodium sulfite**

**sodium bisulfite**

**potassium metabisulfite**

**sodium metabisulfite**

**The solution releases sulfur dioxide into the food. The general ratio for the solution is one liter of water to about 10 ml of sulfite. The specific proportions for different types of food are listed in the tables. There are some problems with sulfite soak that make it less effective than using sulfur dioxide fumes, although it is an easier process. The soaking results in an uneven penetration of food. The food can become waterlogged which extends the drying time considerably. Also, there is a loss of water soluble nutrients while the food is being soaked.**

## **Sulfur Dioxide Fumes**

### **Materials**

#### **Food to be treated**

#### **Sublimed sulfur**

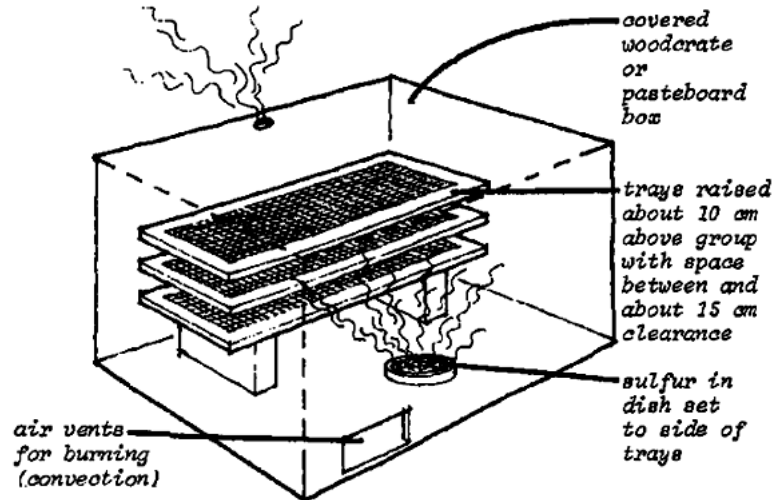
#### **Drying trays**

#### **Wooden box covered with heavy paper or pasteboard box**

#### **Dish**

**Food is sulfured by being enclosed in an area filled with sulfur dioxide fumes. The fumes penetrate the food pieces. This treatment is done outdoors as the fumes irritate the eyes and the breathing passages. Sulfur is burned in a dish under the box after the drying trays loaded with food are stacked and placed under the box. Sublimed sulfur or refined sulfur (sold in cake form with wick for fumigating buildings) can be used. Sulfur melts at 115° C and the proportion to use is 12 ml for each kilogram of cut fruit. Experiment with the burning sulfur. A thin layer in a shallow dish may burn more evenly than a thicker layer. The sulfur burns to a brown syrup that expels the fumes. Time the sulfuring after the sulfur has burned and the air vents have been closed off. When the sulfuring is finished, generally after 30 minutes for small slices and 60 minutes for larger pieces, unload the sulfur box by opening it away from you and on the leeward side if it is a windy day. By checking the wind first and lifting the box away from you, you can avoid having the fumes blow in your direction. You may want to discuss this with the students before sulfuring or while they construct the box. It may be useful to burn a small bit of sulfur beforehand to observe the changes and plan the sulfur treatment. It may be an opportunity to review change of state concepts. Also, the concept of convection can be reviewed and applied to**

**the design of the box. A sample of a sulfur box is diagrammed below:**



**DIAGRAM 52**

### **Sulfuring steps:**

- 1. Weigh food and calculate the amount of sulfur needed.**
- 2. Sulfur the same type of food: mixing foods in the box can get complicated.**
- 3. Put trays on rocks or wood blocks and stack trays with about 8 cm between each tray and 10-15 cm clearance from the ground and above the trays.**
- 4. Set dish of sulfur beside the food trays and put the box over.**

- 5. Light the sulfur and let it burn to brown syrup.**
- 6. Block the air vents; the cut at the bottom of the box and the small hole at the top on the opposite side of the box.**
- 7. Time the sulfuring after the sulfur has burned and the vents are blocked.**
- 8. After the sulfuring, remove the trays of food, taking care to avoid the sulfur dioxide fumes.**
- 9. Arrange trays in a food dryer.**

## **SALTING**

**Foods high in protein invite spoilage more than other foods and therefore require extra steps to dry and preserve. Salting meat and fish discourages the growth of microorganisms, preserves the color and speeds up the drying process. Protein foods also must be stored in a cool place, around 4° C , to avoid spoilage. Pickling salt is used for salting or making brine, a salt solution. It is coarse salt that has not been refined and no iodine has been added. Iodine will discolor some foods.**

**Meat**

**Materials**

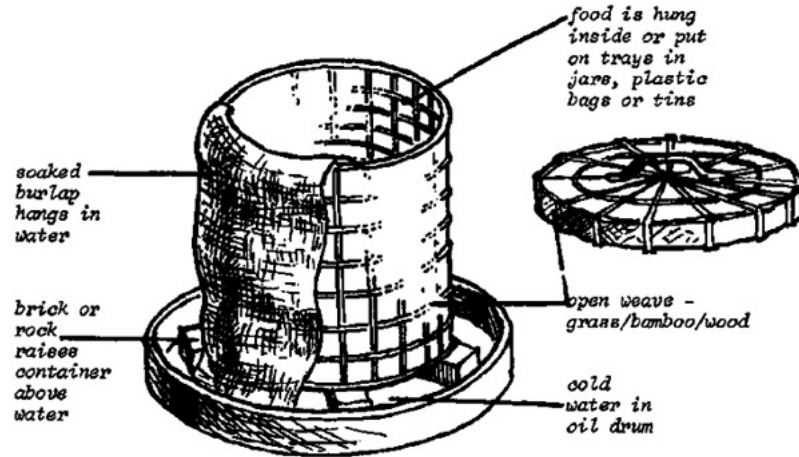
**Food to be treated**

**Brine**

**Dryer**

**Meat can be dried without salting although it does not keep as long as salted meat. Use only lean meat. Fatty meat spoils too readily. Cut the meat into strips lengthwise of the grain. The strips should have a width of 2.5 cm and a thickness of a little more than 1 cm. The strips are hung on the drying frame. Trays made of woven wire, bamboo or grass reed can be used, hanging the meat strips over the cross pieces. The dryer should have a temperature range around 49° C. The meat strips will be brittle when dry. The dry meat weighs about 1/4 the weight of fresh raw meat.**

**Salted meat can also be prepared by making a brine using approximately 1 liter of salt to 5(1/2) liters of pure water. The meat is cut as described above and then soaked in the brine for 1-2 days. The meat is removed then from the brine, wiped dry with a clean cloth and arranged in a dryer. When brittle and at least 1/4 the weight of the raw mess, the strips are removed, cooled and stored in air tight containers in a cool place. The cooler illustrated below can be used to store dry meat and fish. A model of this device was studied in Activity I-1. See also Activities I-5A and I-5B.**



**DIAGRAM 53**

**Fish**

**Materials**

**Food to be treated**

**Pickling sale**

**Knife**

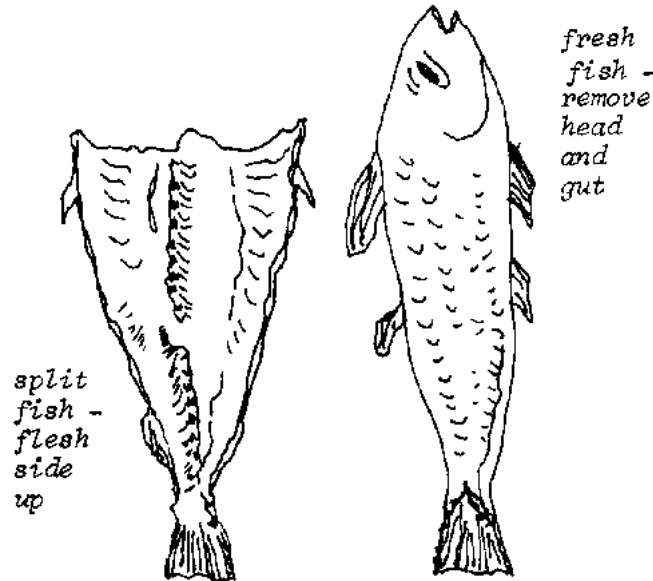
**Dryer**

**The process for drying fish is more complicated than drying meat, but if fresh fish is readily available only part of the year, it may be useful to learn the process in the science**

**class. Fish is an excellent source of protein. Adding a little fish to dishes with vegetable proteins, such as beans, grains or nuts and seeds greatly increases the protein value of the dish.**

**Fish has to be dried in the shade. Direct sunlight will cook fish, even at a temperature as low as 23° C. Frames that can be covered with cloth placed under a large shade tree work well.**

**Use fresh, lean fish. Split the fish and clean out the internal organs. The head can be removed. (The head and organs can be composted for the school garden. Add some lime.)**



**DIAGRAM 54**



**The split fish is coated with pickling salt. One half kg of spit for each kg of fish. The salted fish is arranged on trays flesh side up. The trays are placed on frames in the shade for 1 - 2 weeks. Each night, the trays should be brought indoors. Press the racks or frames to squeeze out extra brine. After 1 - 2 weeks, the fish is scrubbed to remove the extra salt and then set outside again to finish the drying. When the fleshy part of the fish can be pinched, leaving no imprint, it is dry. The dried fish can be cut into pieces and put in air tight containers and stored in a cool place.**

## **POST - DRYING TREATMENTS**

**These treatments are extra assurance that mold and bacteria are killed and that the food has dried evenly before storing. Whether these treatments are necessary depends on the temperature of the dryer, the length and thoroughness of the drying and the amount of humidity in the air.**

## **CONDITIONING**

**Conditioning gives fruit an opportunity to complete the drying process and prevents growth of mold. Food is conditioned to check for thorough drying. If the food is air or sun dried, it is possible that the dryness of some of the pieces may vary. If the food is stored immediately and one piece still has some moisture, the whole batch can spoil in the storage container. On the other hand, if the weather is humid, the dried fruit can take up moisture from the air while being conditioned.**

### **Materials**

**Dried food**

**Large con-tainer**

**To condition, place cool, dried food in a large open container such as a crock or enamel bowl or basin and put it in a warm, dry room with good air circulation. Stir the food in the container two times a day for 10 - 14 days. Again, if it is humid, it may be better to cool and dry test the food pieces and store in airtight containers immediately.**

**The factors involved in pasteurizing and conditioning should be discussed with the students. Ask questions that make the students weigh the factors and develop methods that solve the problems in the local environment. Ask the students:**

**Why are high temperatures important in food dryers?**

**What would happen to dried food if the weather is humid?**

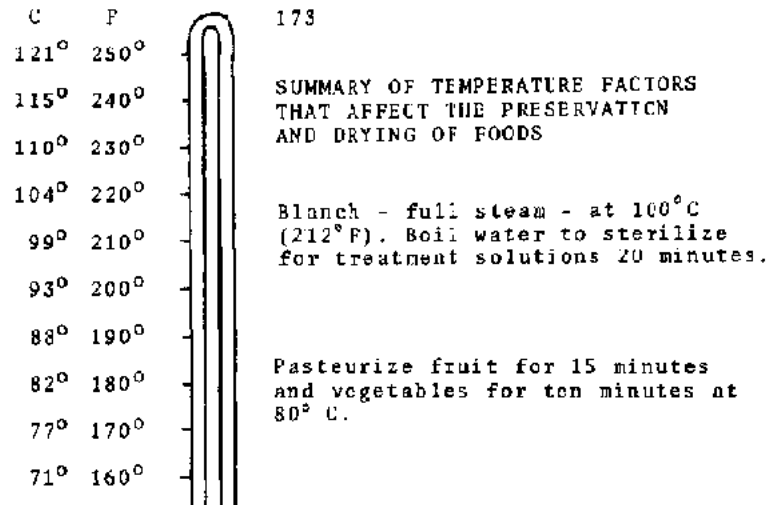
**The following tables outline the preparation, treatment and drying for some fruit and vegetables. Use them as a guideline and encourage students to develop processes for local foods. A suggested sequence to include all the treatment methods in the lessons is to start with onions (no treatment) and proceed with greens such as tampala, mustard or bok choy (blanching) and a fruit like bananas (anti-oxidant coating), then mangos or apricots (sulfuring) and finish with beef or a lean fish like cod, tilapia or congo (salting). Of course, choose food that is available. By picking foods that are available seasonally, the nutritional advantage of having dried foods can be reinforced.**

## **PASTEURIZING**

**Pasteurizing is the partial sterilization of food to kill microorganisms without causing a chemical change in the food that is a loss of nutrients. Some experts recommend pasteurizing for air and sun dried foods. The drying time may not have been long enough to kill mold and bacteria. Others find that if a dryer is kept at 57° C for one hour (solar dryers can reach this range), the food is pasteurized sufficiently to avoid spoilage.**

**Materials****Dried food****Source of heat****Oven****Rocks**

**One method for pasteurizing is to expose dried food to a temperature of 80° C. This can be done in an oven or the container used for blanching can be put on a flat rock or brick that is set in hot coals. The dried food is layered (2 1/2 cm layers) on rocks in the oven or blanching pot. Fruit is pasteurized for 15 minutes; vegetables for 10 minutes.**



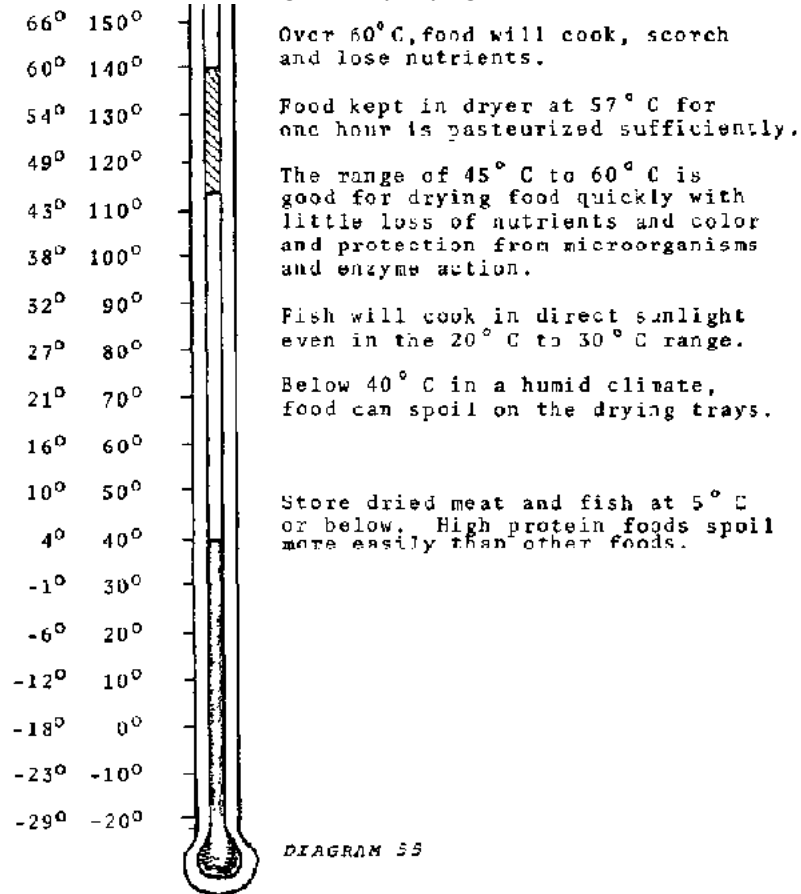
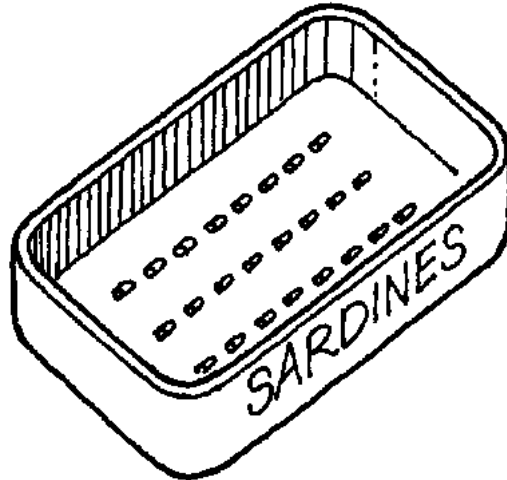


DIAGRAM 55

**Note: For foods that need shredding (see pp.175 - 177) a food shredder can be made by pounding nail holes in a sardine tin, holding the nail at a 30° - 40° angle. The holes are cutting edges that shred food. Shreds will dry faster than slices. Food can be cut up very fine with a knife also to make shreds.**



**DIAGRAM 56**

FOOD	PREPARATION	ANTI-OXIDANT	BLANCH	SULFUR	DRY TEST	NOTES
Apricots	Halve and remove pit		15 minutes <u>or</u>	fume 2 hours	leathery; pieces fall apart when squeezed to- gether.	

Figs	Cut in half		20 minutes	if light, fume in 30 minutes	leathery, sticky but do not stick together.	
Pears	Core and slice 6 mm	coat with ascorbic acid	5 minutes or	fume 1 hour	no moisture when cut and squeezed.	
Bananas (ripe)	Peel and slice 3-6 mm	coat			leathery and tough.	
Bananas (unripe)	Peel and slice 6-8 mm		3-4 minutes	dip in sodium metabisulfite solution (3g/l l )	brittle	can be pou into flour
Guava	Peel and slice 6 mm	coat			leathery, tough	can be stewed,
Melon	Peel and slice 5 cm cubes				leathery, tough	
Mangos	Peel and slice 3-6 mm or shred	coat			tough	

### PREPARATION, TREATMENT AND DRY TEST OF SOME FRUIT AND VEGETABLES

FOOD	PREPARATION	ANTI-OXIDANT	BLANCH	SULFUR	DRY TEST	NOTES
Carrots	Slice 6 mm		15-20 minutes		brittle	
Cabbage	Shred or cut		8-10 minutes		ridges tough, edges brittle	

	fine					
Mushrooms	Separate caps and stems. Cut 12 mm					brittle Many vegeta can be drier without bli ing if the of the dryer high enough They won't as long. I prox. 6-9 r in containe
Okra	Slice 3-6 mm leave seeds		6 minutes	dip in sodium metabisulfite (12 g/l l)		brittle
Corn	Shuck, remove kernals after water blanch		whole ear in boiling H <sub>2</sub> O. 10 minutes. Drain. Cool.			transparent and hard
Onion	Peel and slice 6 mm strips or rings					brittle
Peppers	Slice 6 mm strips					brittle spicy hot: leave seeds mild: remov seeds. Can pounded to paprika.
Greens	Cut uniform size. Split stems if thick		4 minutes			brittle

**PREPARATION, TREATMENT AND DRY TEST OF SOME FRUIT AND VEGETABLES (cont'd-1)**

FOOD	PREPARATION	ANTI-OXIDANT	BLANCH	SULFUR	DRY TEST	NOTES
Sweet Potato	3 mm pieces or shred		30 minutes whole		brittle	
Potato/ Cassava	Slice 3-4 mm or shred		20 minutes peeled and quartered		brittle	
Beans: lima, shell, etc Peas: green and black eye	Remove from pod		10 minutes		brittle, break clean	store some next growing season.
Celery	Slice stalks 6 mm Chop leaves		4 minutes		brittle	dry leaves stalks on separate trays; leaves dry faster.

### PREPARATION, TREATMENT AND DRY TEST OF SOME FRUIT AND VEGETABLES (cont'd-2)

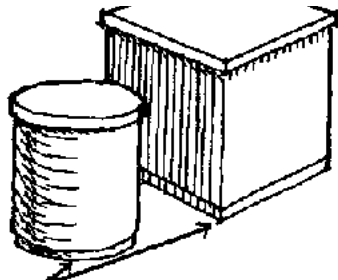
### FOOD STORAGE

Food storage methods can be covered in the lessons in Chapter 5. The key to safe storage is to keep the moisture content to a minimum. If this is done, other problems, such as insect or vermin invasions, can be avoided. The reasons for pasteurizing, adding preservatives and using airtight containers should be emphasized.

Some examples of food storage containers:

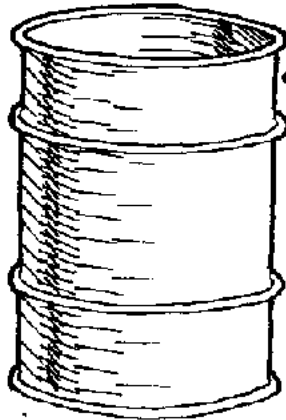
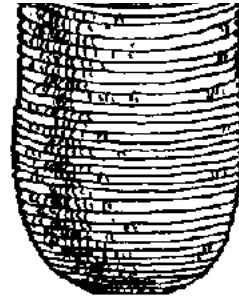




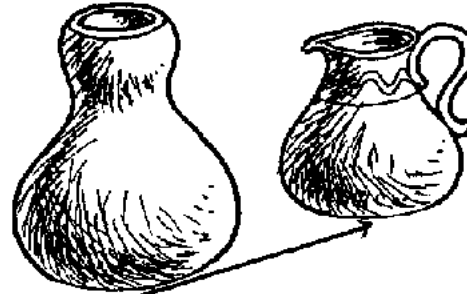


57. Any kind of tins with lids.

58. Basket lined with plastic or coated with melted wax.



59. Well cleaned, used oil drum.



60. Ceramic pots and bowls and gourds.

**DIAGRAMS 57 - 60**

**If dried food is stored in baskets, ceramic pots or gourds, a lid or seal can be made by dipping a piece of cloth in melted wax (use candle stubs from other lessons) and quickly tying it over the top of the container.**

**Lessons on storage can be conducted in much the same manner as some of the other lessons by having groups of students work together to design and test various storage containers. It may be a good idea to initially store small amounts of foods in the various containers until the effectiveness of the containers is established by the students' tests. Keeping moisture out of the storage containers is the most important factor to develop.**

**Removing 80 - 90% of the moisture from foods concentrates the sweetness (fruit sugar) in fruits and the nutrients in all foods, and since foods rehydrate to 90X of their original size, dried foods can be more nutritious than fresh foods.**

**Dry food also conserves storage space.**

#### **Examples:**

1 kg fresh carrots = 80 g dried carrots  
8 kg potatoes = 1 kg dried potatoes  
12 kg onions = 1 kg dried onions  
  
1 kg fresh fruit = 200 g dried fruit

#### **A Special Note on Food Storage**

**Beans and other seeds can be protected from weevils and other insects by putting a dried hot pepper or a dry bay laurel leaf in each storage container of beans, peas or other dried seeds including those stored for the next growing season.**

**Bay laurel and other medicinal or culinary herbs should be dried in a dark, dry, cool place. Light and heat will cause the loss of the herb's volatile oils and, therefore, their flavor or medicinal value. See the food preservation materials in this packet.**

## **Chapter 9. Preparation of dried foods**

**This final chapter can be tied to the diet record work and meal planning that the students began at the end of the nutrition studies.**

**Some math can be included as students calculate the portions of protein, fat and carbohydrate in the meal plans. Also, converting proportions of fresh ingredients in local recipes to dried foods involves some math.**

**After this work, the students may want to prepare a balanced meal made from dried foods for the school. It may be beneficial to invite the community people who have been involved. This can help to transfer some of the skills and methods to the general population.**

### **BACKGROUND INFORMATION ON REHYDRATION**

**Rehydration is the opposite of dehydration; it is the process of adding pure water to dried food. Dried foods absorb water and rehydrate to about 90% their original size. Generally, 1 kg of dried food will equal 2 - 2(1/2) kg of food when rehydrated. Dried food can be rehydrated and then prepared in recipes as fresh food or it can be added to recipes, absorbing liquid and cooking in one process. For example, dried vegetables can be added to soup stock without rehydrating beforehand.**

**A variety of rehydrating methods are used by nutritionists. As with food drying methods, a number of approaches work equally well, depending on taste and local food preparation methods. The variety of methods possible lends itself to testing by the students to develop**

**acceptable methods for the local recipes.**

**Some general guidelines and methods will be offered here to develop the problem solving rehydration activities with the students.**

**Some experts feel the proportion of 1 part food to 2 parts liquid is adequate for all rehydration. Generally, water is used, but fruit juices and stocks can be used as well.**

**Fruit\* 1 : 2 liquid (water)**

**- be sure to use pure water with foods.**

**Vegetable 1 : 2 boiling water**

**- cover and wait 5 minutes; then cook at low temperature to taste.**

**Other experts suggest a 1 : 3 ratio for dried vegetables. Again, this depends somewhat on taste.**

**Beans, such as soybeans, are covered with water and soaked overnight and then cooked for 1 - 2 hours in fresh water.**

**The bulkier foods will take up more water. You may ask the students to refer to the figures they recorded in the water content activity (Activity II-1) to figure how much water different foods may absorb when rehydrated.**

**Some experts suggest that soaking before cooking makes the food tough. This seems to be dependent, though, on the type of food and how it is prepared. These experts pour boiling water over the dried food and cover and cook at low temperatures. They adjust the water level while cooking the food, adding just enough water for the food to rehydrate and cook without getting tough or soggy.**

**As mentioned in the treatment charts in Chapter 8, dried foods can be pounded to powders. The powders can be stored mixed or separately. The powders can be mixed, added to boiling water and cooked low for soups, porridges or sauces. A mix of high protein, carbohydrate and fat dried food powder can be used for special food for babies and young children. A high protein food powder can be added to sauces and other dishes to supplement the protein intake if it is low in a particular region. Milk powder is commonly used this way, but others, such as soybean or groundnut powder, could be used as well.**

**Dried food that is to be eaten raw can be put in a bowl with enough boiling water to cover. A lid is put on the bowl and the food soaks for several hours.**

**The concept of balanced diets can be expanded and reinforced during these activities. The students can return to the diet records they began after the food and digestion tests (p. 157). At this point, you may introduce the need for average portions of protein, fat and carbohydrate in the daily diet.**

**The following chart depicts the daily protein, fat and carbohydrate needs of adolescents and adults.**

	Person's Wt. in lbs.	Person's Wt. in kgs	Protein Veg./Animal		Fat	Carbo- hydrates
Growing	100	45.5	100	80	90	380
Adult	120	54.5	120	96	100	440
Adult	120	54.5	60	48	80	330
	140	63.5	70	56	90	380

**Daily Protein, Fat and Carbohydrate Needs in Grams**

**(This chart is adapted from figures given in Diet for a Small Planet and caloric value**

**conversions in Today's Basic Science.)**

**Adults need about 1.1 g /kg of body weight of plant protein (grains, legumes, nuts) or about .88 g/kg of animal protein (meat, fish, eggs, milk, cheese, yogurt) each day. Growing people, children and young adults, need 1(1/2) - 2 times as much protein per pound of body weight each day. The fat and carbohydrate needs are approximations. Excess protein in the body will be converted to carbohydrates for energy, therefore altering the carbohydrate intake need**

**You may want to use average figures for each need based on the average age and weight of the science students in a class. The chart, or a portion of the chart of average figures, can be given to the students.**

**Activity III- 17 ANALYSIS OF DIETS**

**Using their diet records, the students can calculate the amount of protein, fat and carbohydrate they -consume in a day. You may want to pose' a conversion table or note some conversions on the blackboard. Ask the students to explain the procedure. Some math review may be needed.**

**After the students have finished their calculations, ask for reports. During the reports, bring out the need for the food types and vitamins and minerals in the diet.**

**Why do we need protein?**

**What do carbohydrates provide?**

**Why do we need green vegetables?**

**Are there protein foods that can be added to improve the diet?**

**For example, milk powder, nuts or seeds can be added to sauces or cooked rice to increase the amount of protein in the diet. Sesame seeds, bulgar wheat or soybeans can be cooked with rice if rice is a common part of the diet.**

### **Activity III-18 MEAL PLANNING**

**At the end of the discussion, ask the students to begin to plan nutritious meals starting with local recipes. This can be done in the class or as a task outside the class. If the class is made up of people with different traditions and diets, divide the class into groups so that all the various diets are considered.**

### **Activity III-I9 REHYDRATION**

#### **Materials**

**Dried foods - use small portions for the tests.**

**Bowls or pots with lids - some tins may be used for cooking.**

**Burners, charcoal pots or fire pits.**

**Pure water (boiled for 20 minutes).**

**Mortar and Pestle, pounding stones or similar utensil.**

**Conversion table and food portion need chart.**

**Milk powder, if available for special powder mixes.**

**Stirring, mixing tools - wood, metal, plastic.**

**Basin**

**Soap**

**Cloths**

**Water**

**Measuring spoons, plastic caps or something similar for measuring small amounts.**

**Direct the students to experiment with, small portions of dried food to discover the best way to rehydrate a particular food either for cooking or eating raw. Groups of students can work together with one type of food per group or each group can test all the types available. Encourage record keeping.**

**How much water did you use?**

**Was it boiling or cold?**

**How did you decide on the amount of water to use?**

**(Did the students remember the water content activity results and apply them to these tests?)**

**How much dried food did you use?**

**(Encourage using only spoonfuls for the tests.)**

**How long did it take for the food to soak up the water?**

**Did you cook the food? How long? What temperature range? Low? Medium? High**



**(boiling)?**

**Through questioning, alert the students to the variables involved:**

**Water - amount and temperature.**

**Food - amount and type.**

**Time - soaking and cooking.**

**After the testing, have the groups report their findings. The students can develop a chart such as the one that follows, on a large paper or the blackboard outlining the rehydration process that works best for each type of dried food. This information will be used again. It can also be compiled with the food drying methods developed earlier.**

Food Type	Amount of Food	Amount of Water	Water Temperature	Soaking	Time Cooking

**At this point, you may want to have the students compile all their results into tables, charts and recipes. Assign the various parts of the study to each group of students. Have each group give a final report.**

**If there are copying machines or hectographs available, the science students could produce a booklet on drying, preserving and preparing local foods for balanced nutritious meals the year round, even in the season of shortage.**

### **Activity III-20 PREPARATION OF POWDERS FROM DRIED FOODS**

**Direct groups of students to pound various kinds of dried foods to make powders if this**

**has not been done. Give a problem to each group to solve.**

**Problems:**

- 1. What mix of powders would make a balanced nutritious food for babies and young children?**
- 2. What mix of powders would make a sauce that could be served with rice (wheat, noodles, cassava, potatoes) to make a nutritious meal?**
- 3. What mix of powders would make a soup or porridge that is complete (nutritious)?**

**The students will have to consider and calculate proportions of food types. Have the food type need chart and conversion tables posted. Some review of ratios may be needed to get started. Ask the students to use small portions. Later when recipes are developed, the amounts can be increased to usable portions for meals.**

**With milk powder available some mixes may be easier to develop. Having dried commonly used herbs also may facilitate developing sauce recipes. Also, having some cooked rice or similar food in the class may be useful for tasting the samples of new sauces being developed.**

**The steps involved in this activity are:**

- 1. Calculate the portions of food types needed for a balanced meal ( $1/3$  of daily need).**
- 2. Decide which available powders fit each type.**
- 3. Measure and mix samples from each type.**
- 4. Add herbs if desired.**

**5. Cook sample mix in small tin with pure water.**

**6. Taste sample.**

**7. Adjust sample if necessary.**

**8. If acceptable, record the recipe increasing the portions to normal amounts for a meal.**

**While the students are working, move from group to group to question them. How did you calculate the portions to use? Do children need the same portions of food types as adults? What did you have to consider? Use this activity set to question and review the nutrition concepts from earlier lessons. Ask the students to gather and record local recipes -or various dishes. Using their dehydration and rehydration records and results, have the students convert local -recipes to the appropriate portions using dried foods.**

**Using the results of the various activities, have the students plan, prepare and give a meal at school for the other students. Invite interested community residents as well. If some people have donated food or time to the project, include them also.**

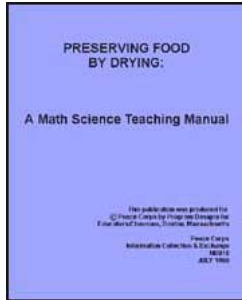
## **SUMMARY**

**In Part I and Part II, the students learned the basic construction of solar dryers and the scientific principles needed in order to design and understand how solar dryers work.**

**In Part III, the students have investigated and learned why it is important to preserve foods by drying. They have also learned enough about basic nutrition for them to be able to plan well balanced meals the entire year.**











**[Home](#)"" """"> [ar.cn.de.en.es.fr.id.it.ph.po.ru.sw](#)**



## **Preserving Food by Drying: a Math-Science Teaching Manual (Peace Corps, 1980, 218 p.)**

### **Appendices**

-  **Appendix A. Materials cross-reference list**
-  **Appendix B. How to make a round hole in a tin**
-  **Appendix C. Conversions between metric British and American weights and measures**
-  **Appendix D. Differences between British and American terminology**
-  **Appendix E. Detecting changes in temperature without a thermometer**
-  **Appendix E. Making an equal arm balance**
-  **Appendix G. Making a set of weight's**
-  **Appendix H. A heating stand made from a tin**

## **Preserving Food by Drying: a Math-Science Teaching Manual (Peace Corps, 1980, 218 p.)**

### **Appendices**

#### **Appendix A. Materials cross-reference list**

**A list of all the equipment and materials needed to do the activities in "Preserving Food by Drying" is presented here. The list is divided into categories intended to assist you in the practical tasks of locating and storing these things. The categories are as follows:**

**Items used without modification which can be obtained free or purchased locally.**

**Items cut from a larger piece, or that need to be modified slightly, and which can be obtained free or purchased locally.**

**Items made from easily available materials that need some effort or skill to build.**

**Consumable items obtainable locally.**

**Consumable items obtained from specialized sources.**

**Equipment obtained from specialized sources.**

**Available resources.**

**Colored materials.**

**Heat sources using fuel.**

**Where appropriate, the items in a category are divided according to whether or not they require special care in storing. Items in each list are in the order of their first use in the book. Next to each item are listed all of the activities throughout the book where it is needed. By looking through this list, you can see what materials and equipment are frequently needed, what is needed occasionally, and what is needed only once or twice. Thus, you can make decisions about what items to accumulate, what items to borrow when needed, and what activities you may have to modify or omit due to lack of materials or equipment.**

**Alternatives are suggested for many of the items. Any of the alternatives should work in all of the activities listed for the particular item. Many of the materials can be collected by your students. Involving your students finding materials has value because they learn what materials are available locally, and their resourcefulness and problem solving**

**abilities increase as they learn to substitute other materials for those suggested here. We are anxious to know about any successful materials substitutions you and your students make. Returning PCV's are urged to write Program Designs for Educators at: Chevrons and PDE, P.O. Box 235, Jamaica Plain, Boston, Massachusetts 02130, U.S.A.**

**Most of the activities do not require tools, but as the students make the transition from learning how dryers work to designing and building them (Activities I-IIB and II-2), the importance of having tools suddenly increases. We recommend making your own tools. As part of the framework of this manual, "How to Make Tools" was created by Per Christiansen and Bernard Zubrowski as a companion piece.**

Fragile or Damaged if Stored Wet:

Dishes or small trays able to hold water	I-1, I-4C
Rulers marked in centimeters	I-1, I-2A, I-6, II-1, II-2, p.126
Scissors or razor blades	I-2A, I-4A, I-4B, I-4C, I-6, I-11A, I-11B
Watch or clock or other timer for measuring relatively long periods of time	I-4A, I-4B, I-4C, I-7, I-10, p.122-5
Jars	I-4A, I-4C, III-7, III-11, III-13, III-14, III-15
Bottles	I-4A
Elastic bands	I-4A, I-4B, I-11A
Drinking glasses	I-4A, I-4C
Jars with certain size requirement	I-4B, I-6, II-1
Tea glasses or very small tins	I-4B, I-4C
Basins, large bowls or buckets	I-5A, II-1, II-2, III-14, p. 166, III-18
Trays or dishes or pieces of pasteboard	I-6, II-1
Clay tiles or bricks, or blocks molded from adhesive material such as soil taken from termite mounds	I-7, I-8B
Protractor	I-8A, I-8B, I-8C

**Items used without modification which can be obtained free or purchased locally**

Common pins	I-11A, I-11B
Cooking pots or large tins	pp. 122-6, 163

Culture dishes	p.122, III-2, III-3, III-4, III-5, III-6
Sewing needles to use as transfer needles	p.126 , III-2, III-3, III-4, III-5
<u>Not Fragile:</u>	
Tins of various sizes	I-1, I-3A, I-3B, I-4A, I-4B I-4C, I-10, II-2, III-11, III-20
Tins of the same size	I-1, I-7
Small stones	I-1, I-4B, I-4C, I-10, I-11A, p. 163
Measuring spoons, cups, tins, bottle-caps, etc. for measuring small amounts of liquid or powder (p. 8 )	I-1, I-4C, p. 125, III-13 III-14, III-15, III-18
Lids or caps for bottles or jars, or use plastic and elastic bands	I-4A, I-4B, III-8, III-10
Tins with a certain size requirement	I-4A
Several nails of different sizes	I-4A
Shovels or other tools for digging holes in the ground	I-4C
Bricks or similar size stones	I-4C, I-8A
Nails or pegs	I-8A, I-9, II-2
Tins with both ends cut out	I-8A
Small nails, brads or tacks	I-8A



Small metal, glass or plastic	I-9
Large tins	I-9
Bottle-tops or other objects having uniform weight, to be used as weights	II-1, II-2
Pieces of metal from large tins, or dishes, to use as covers	p. 125, p.163

### Items used without modification which can be obtained free or purchased locally (cont'd.)

#### Fragile or Damaged if Stored Wet:

Cloth	I-1, I-5B, p. 161, III-18
Paper other than usual notebook	I-1, I-4A, I-11A, III-9, III-16
Means for labelling, such as paper and cement, elastic bands or tape	I-1, III-2, III-13, III-15
String	I-3A, I-3B, I-5A, I-6, I-8A, I-8B, II-1
Cloth which air can circulate through, such as cheesecloth, gauze or nylon tulle	I-6, II-1, II-2
Thin transparent plastic, small pieces	I-4A, I-4B, I-4C
Absorbent cloth such as from an undershirt or singlet, or paper which is very absorbent	I-4B
Blocks or pieces of wood to use as a support	I-4B
Thin transparent plastic, larger pieces	I-4C, I-11A, I-11B, II-2
Hand-held fans, or big leaves, pieces of newspaper, etc. to use as fans	I-5A

Flat glass or clear plastic and tool to cut it	I-7, I-9, II-2, III-10
Poles such as straight tree branches, reeds, broom handles, or narrow boards	I-8A
Newspaper or other large pieces of paper	I-8A, III-7, III-8, III-9, III-10, III-11
Pasteboard or heavy paper with a smooth surface on at least one side	I-8A, I-8B
Pasteboard	I-8C
Tape	I-8C, I-9
Thin wire	I-11A

**Items cut from a larger piece, or that need to be modified slightly, and which can be obtained free or purchased locally**

## Preserving Food by Drying: a Math-Sci...

String or braided cotton that produces smoke when glowing	I-11A, I-11B
Small boxes made of paper or pasteboard	I-11A, I-11B, II-2, III-12
Pieces of soft wood about the size of a pencil	p.126

Not Fragile:

Small pieces of wood	I-4A, I-8B, II-1
Outer tubes of Bic pen, preferably transparent, hollow bamboo branches, or hollow grass reeds	I-4B, I-4C, III-8, III-11, III-13
Tops from small tins (Diagram 8) or other stand that will not be damaged by water or heat	I-4B, I-4C, I-11A
Bottletop with a hole in it, washer, or other small object to hang on a string	I-8A, I-8B
Wood boards or slabs	I-9, II-2, III-12
Bamboo	I-9
Pieces of metal from tins	I-9, II-2

**Items cut from a larger piece, or that need to be modified slightly, and which can be obtained free or purchased locally (cont'd.)**

Fragile or Damaged if Stored Wet:

Grid paper with 1 centimeter squares	I-2A, I-2B, I-6, I-8C, II-1
--------------------------------------	-----------------------------

## Preserving Food by Drying: a Math-Sci...

Pendulum made from a stone hanging on a piece of twine about 2 meters long, to be used as a timer for relatively short times. A clock or watch with a second hand can also be used.	I-3A, I-3B, I-5A, I-11A
Device for comparing weights, such as an equal arm balance	I-6, II-1, II-2, p. 122
Knife	I-6, II-1, III-12, III-16, p. 169
Saw (Appendices D, E and L)	I-8A, I-8B, I-9, II-2, pp. 95-113
Angle measuring tube (I-8A)	I-8C, I-11B, II-2
Elevation angle measuring device (I-8B)	I-8C, I-11B, I-2
Chisel or shears to cut metal	I-9, II-2
Device to purify water (I-9)	p. 163, 166
Tweezers	III-10
Food dryers (Part II)	III-3, III-5, III-16, pp. 163-9

Not Fragile:

Tongs or cloth to lift hot objects off a fire	I-3A, I-3B, p. 122-5
Support for tins to be heated by a candle or small burner	I-3A, I-3B, I-4A, I-4B, I-4C
Tins with a round hole in the side or equivalent container	I-4B, I-4C

Device to hold wood while cutting or drilling it	I-8A, I-8B, I-9, II-2, pp. 95-113
Hammer	I-8A, I-9, II-2, pp. 95-113
Drill	I-8A, I-9, II-2, pp. 107-113

### Items made from easily available materials that require some effort or skill to build

Salt	I-1
Sugar	I-1
Cooking oil	I-1, III-14
Potato, cassava or other large, firm vegetable	I-6, II-2, III-12, III-13
Crack sealer, such as mud or tar	I-9, II-2
Charcoal	I-11A, p. 122-5
A variety of kinds of kinds of food such as fruits, vegetables, meat, etc.	II-1, p.122, III-2, III-3, III-7, III-8, III-9, III-10, III-11, III-13, III-15, III-16, p.163-9
Soap	II-1, II-2, II-11, III-14, III-18
Paste or cement or other adhesive	II-2
Piece of termite hill or large clod of dirt	III-12
Wax	III-13
Animal bones	P.122
Mold and bacteria (pp. 119-21)	III-1, III-2, III-3, III-4, III-5, III-6

Crackers, tortilla or bread	III-13
Starch	III-13
Vinegar	III-14
Gum acacia	III-14
Milk	III-15
Lemon juice	p.163
Brine	p.169

### Consumable items obtained locally

Iodine	III-8, III-13
Hydrochloric acid	III-11, III-14, III-15
Benedict's solution	III-13
Pepsin	III-15
Ascorbic acid	p. 163
Pure water	p. 163, 166
Sublimed or refined sulfur	p. 166
Sulfite substance	p. 166
Pickling salt	p. 169

**Consumable items obtained from specialized sources**

**Note: Most of these items are likely to be available at pharmacies, hospital laboratories, health centers and secondary schools.**

**Water**

I-1, I-3A, I-3B, I-4A,  
I-4B, I-4C, I-5A, I-5B,  
I-6, I-7, II-1, p. 122-5,  
III-7, III-8, III-11,  
III-11, III-14, III-15,  
p. 163 , III-18

**Sunlight**

I-1, I-4A, I-4B, I-4C,  
I-7, I-8A, I-8B, I-8C,  
I-11A, I-11B, II-2,  
III-4, III-6

**Equipment obtained from specialized sources**

Source of a smoky flame, such as a candle or a paraffin lamp, for coating surfaces black with soot I-1, I-4C, I-7, I-8B

Pieces of white paper, black paper such as carbon paper, and various other colors including metal foil, if available I-4A, I-4B

White paint, cassava paste, whitewash or aluminum paint I-7, II-1

Black cloth I-9

Black ink or black paint I-11A, I-11B, II-2

### Colored materials

Matches I-1, I-3A, I-3B, I-4A, I-4B, I-4C, I-7, I-8B, I-11A

Charcoal cooker, or three stones and firewood, and a metal grating or other support so tins can be heated I-3A, I-3B, I-10, I-11A, pp.122-6, 113, III-18

Burner and paraffin or gas that provide a medium source of heat I-3A, I-4C, II-13, III-15

Candle or small burner and paraffin or gas, to provide a small source of heat I-3B, I-4A, I-4B, I-11A, III-10, III-11, III-13, III-15



## Heat sources using fuel

### Appendix B. How to make a round hole in a tin

In cases where one wants to insert a tube into a tin tightly so that there is no leakage between the tube and the hole it fits into, it is necessary to make a round hole in the tin. If the hole is large enough to be able to fit the case of a Bic pen into (or a very small hollow bamboo branch) use the following method. First, make a tiny hole with a nail having a length of 5 centimeters. Then enlarge the hole with a 6(1/2) cm nail, followed by a 10 cm nail, and lastly by a 15 cm nail. It is important that these four nails be used in this way. If only the largest nail is used, it will make a square hole because the point of the nail has four sides.

### Appendix C. Conversions between metric British and American weights and measures

These conversions have been rounded to produce values that are easy to work with and to remember. However, they are all within 2 percent of the exact values.

#### LENGTH

<i>Metric</i>	<i>British and American</i>
1 centimeter	= 4/10 inch
1 decimeter	= 4 inches
1 meter	= 40 inches
1 kilometer	= 5/8 mile
<i>British and American</i>	<i>Metric</i>
1 inch	= 2.5 centimeters
1 foot	= 3 decimeters

1 yard	= 9/10 meter
1 mile	= 1.6 kilometer

## AREA

<i>Metric</i>	<i>British and American</i>
1 square decimeter	= 15.5 square inches
1 square meter	= 10.8 square feet
1 square meter	= 1.2 square yards
1 hectare	= 2.5 acres
<i>British and American</i>	<i>Metric</i>
1 square inch	= 6.5 square centimeters
1 square foot	= 9.3 square decimeters
1 square yard	= 5/6 square meter
1 acre	= 4/10 hectare

## VOLUME

<i>Metric</i>	<i>British</i>	<i>American</i>
100 milliliters	= 3.5 ounces	= 3.4 ounces
500 milliliters	= 17.5 ounces	= 17.0 ounces
1 liter	= 0.88 quart	= 1.06 quart
5 liters	= 1.1 gallons	= 1.3 gallons

<i>British</i>	<i>Metric</i>
----------------	---------------

1 cubic inch	= 16.4 milliliters
1 ounce	= 28.0 milliliters
5 ounces (1/4 pint)	= 140.0 milliliters
10 ounces (1/2 pint)	= 280.0 milliliters
1 pint (20 ounces)	= 560.0 milliliters
1 quart (40 ounces)	= 1.1 liters
1 gallon (4 quarts)	= 4.5 liters
<i>American</i>	<i>Metric</i>
1 cubic inch	= 16.4 ml
1 ounce	= 30.0 ml
4 ounces (1/2 cup)	= 120.0 ml
8 ounces (1 cup)	= 240.0 ml
1 pint (15 ounces)	= 480.0 ml
1 quart (32 ounces)	= 960.0 ml
1 gallon (4 quarts)	= 3.8 l
<i>Miscellaneous</i>	<i>Metric</i>
1 bottle top (Coca-Cola, etc.)	= 3.5 milliliters
1 usual teaspoon	= 4 to 5 milliliters
1 measuring teaspoon	= 5 milliliters
1 tablespoon, eating	= 8 to 10 milliliters
1 tablespoon, serving	= 14 to 16 milliliters

1 measuring tablespoon = 15 milliliters

**Note:**

40 British ounces - 1 British (Imperial) quart, and 32 American ounces = 1 American quart. The unces are almost the same size but this relationship creates a difference of about 20 percent in the else of pints, quarts and gallons between British and American measurement of volume.

**WEIGHT**

<i>Metric</i>	<i>British and American</i>
10 grams	= 7120 ounce
100 grams	= 3.5 ounces
1 kilogram	= 2.2 pounds
<i>British and American</i>	<i>Metric</i>
1 ounce	= 28 grams
1 pound	= 450 grams
10 pounds	= 4.5 kilograms

**Note: The British and American units of weight shown above are the ones in common use, the "Avoirdupois" system, which hoe 16 ounces in a pound. Another system exists in both Britain and America, the "apothecary" or "troy" system. Its pound, which equals about 370 grams, contains 12 ounces. This system is only used in certain specialties.**

**TEMPERATURE**

**See page 122 for a conversion chart between the Fahrenheit and Centigrade temperature scales.**

**Appendix D. Differences between British and American terminology**

British English	= American English
Cement	= Glue
Common pins	= Pins or straight pine
Edible oil	= Cooking oil
Muriatic acid	= Hydrochloric acid
Paraffin	= Kerosine, charcoal lighting fluid
Pasteboard	= Cardboard
to revise a lesson	= to review a lesson
Spirit	= Alcohol
Tin	= Can

### **Appendix E. Detecting changes in temperature without a thermometer**

**In a number of the activities where an increase of temperature takes place, it can be felt with your hand. These are Activities I-3B, I-4C, I-4C Further Study, I-5A and I-10.**

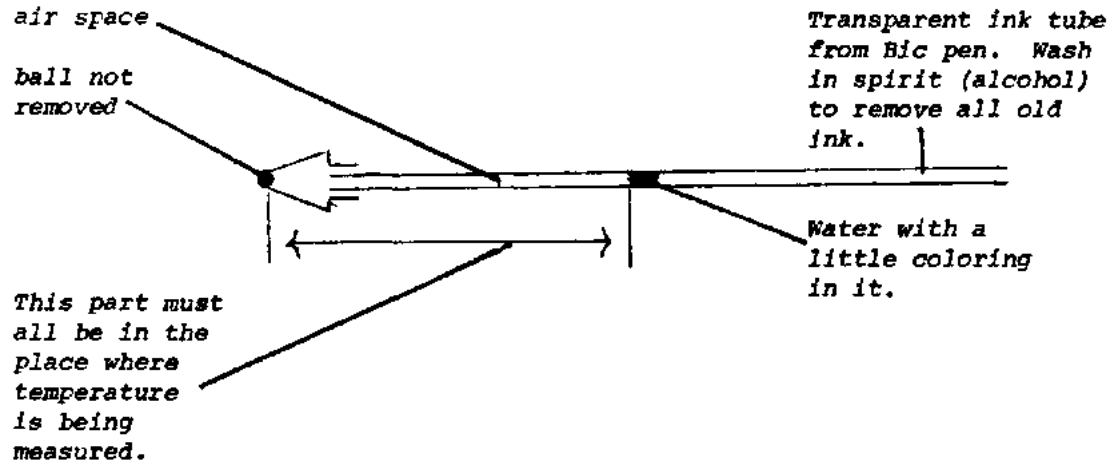
**In several other activities, the increases in temperature can be noted the same way, but it would be desirable to improve both measuring skills and understanding of the situations by making a somewhat more quantitative measurement. The approaches suggested here apply to these activities: I-5B, I-7, I-7 Further Study, I-8B, I-IIA, I-IIB and II-2.**

**In the Further Study following Activity I-3A, a laboratory thermometer which can measure temperatures up to 100 C is needed. This is a difficult requirement to meet with improvised temperature measuring devices, but perhaps you can invent one or locate an existing design that is easy to make and works well. If you do, please communicate it to the Information Collection and Exchange office. Also, please let us know about your**

**successful or unsuccessful attempts to measure temperature in any of the lessons.**

**In many industrial applications, temperatures are measured using pieces of material that melt at known temperatures. For example, in Activity I-7, three tiles are placed in the sun. They are all horizontal. One is black, one is earth colored, and the other one is white. On each tile, you could put a piece of margarine and a piece of wax. Whether both of these melt on each tile, and how long it takes could be noted. Maybe in your locality, both of these melt too easily. Can you find another material that melts at a higher temperature?**

**The following device can measure small and medium changes of temperature.**

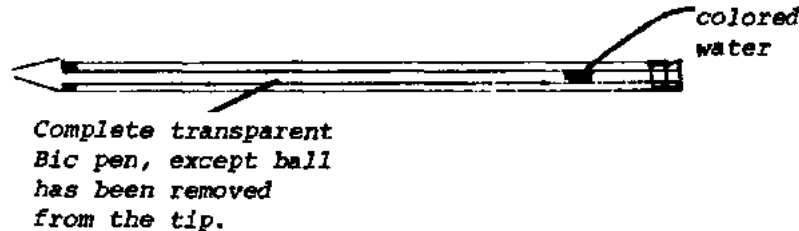


**Figure**

**The air trapped in the tube expands as the temperature rises. Experiment with the size of the air space. A small air space gives less sensitivity, but a higher temperature can be**

measured without the water spilling out the end of the tube. The range has an upper limit near the boiling point of water because too much water vapor forms in the air space. Positions along the tube can be marked, or it can be glued to a piece of paper, pasteboard, plastic or wood, and that can be marked.

The following device is useful for measuring relatively small changes in temperature. Air in the body of the pen expands to move the colored water. Air must be free to leave or enter the tip. Water getting in it will impair its operation.



Figure

All connections must be sealed, including the small hole on the side of the pen. When the air is warmed and expands, it pushes the colored water. It must not escape elsewhere. The whole device is sensitive to change of temperature. Either the whole thing should be put in the place where temperature is being measured, or the same length must be used for all measurements which are to be compared. It also responds to your warm fingers, and thus must be held some other way.

As you can see, these devices have some merit, and we are anxious to hear of your efforts to use them. However, they also have limitations. Perhaps they can be adapted in some way to become better.

Activity	Wet or Dry	Amount of temperature change	Temperature present over a large or small area	Calibration of device needs numbered uniform intervals	Temperature too hot to touch by hand for very long
I-5b	wet	slight	can be either	no	no
I-7	dry	moderate to large	large area	no	maybe
I-7	wet	moderate	large area	yes	no
I-7 Further Study	dry	moderate to large	large area	yes	maybe
I-8b	dry	moderate to large	large area	no	maybe
I-11a I-11b II-2	dry	moderate	depends on size of equipment	no	no
I-3a Further Study	wet	very large	depends on size of equipment	yes	yes

The conditions of measurement in the various activities are as follows

#### Appendix E. Making an equal arm balance



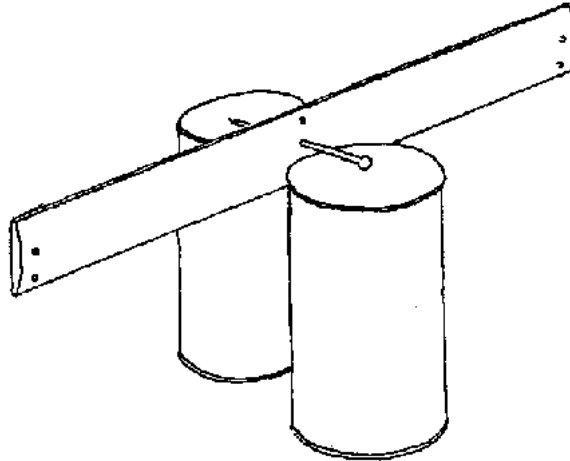
**Many science lessons can be improved by having weighing equipment available for the students to use. Often there is only one triple arm balance or weighing scale in the science room, and the teacher is apprehensive that it may become broken if students are allowed to use it.**

**Simple designs for equal arm balances that can be made from easily available materials are shown here.**

**Several details of design affect how sensitive a balance is:**

- 1. Friction at the center point.**
- 2. Whether the center hole is placed above or below the end holes.**
- 3. The weight of the beam and where the center of gravity of the beam is located compared to the center hole.**

**Friction at the center point can be kept very low as long as the pivot uses rolling instead of sliding friction. Using a nail that rolls on the edges of tins is one effective way to keep friction at the pivot from being a problem, and is the method used in the diagrams that follow.**



**Figure**

**To investigate the effect of having the end holes**

**a. below the center hole, and**

**b. in line with the center hole, make the holes shown in the following diagram in a wooden ruler.**

**Put a nail in the center hole, which is approximately at the center of gravity of the ruler. Then hang a hook or lightweight container from the lower holes at each end of the ruler. Get many small objects that all have the same weight. These could be common pins, paper clips or staples. One of these object should be enough to unbalance the ruler. (If the ruler does not hang level at first, put an elastic band around the portion of it that is higher, and use its position to adjust the ruler so it is level.)**

**Then put five pins on each side.. Add a sixth to one side. Does the ruler move? Add five more pins to each side, so you have ten on each side. Add an eleventh to one side. Does the ruler move? Continue this procedure for fifteen and twenty pins.**

**Now hang your hook or light weight container from the upper holes at each end of the ruler. Do the same thing, testing the sensitivity to detect the weight of one pin when there are zero, five, ten, fifteen and twenty other pins already in each container.**

**You will find that in one case, the sensitivity decreased greatly when many pins were already on each container. This characteristic is useful when you want students to quickly compare objects that are approximately the same weight with other objects that are very different in weight, such as being only half as heavy. Too much sensitivity might make every object seem different in weight from every other object, and the students would get bogged down. Measuring the potato cubes in Part I of Preserving Food by Drying is an activity where the balances purposefully should not be very sensitive.**

**Now make one more hole in the center of the ruler, so it looks as follows:**

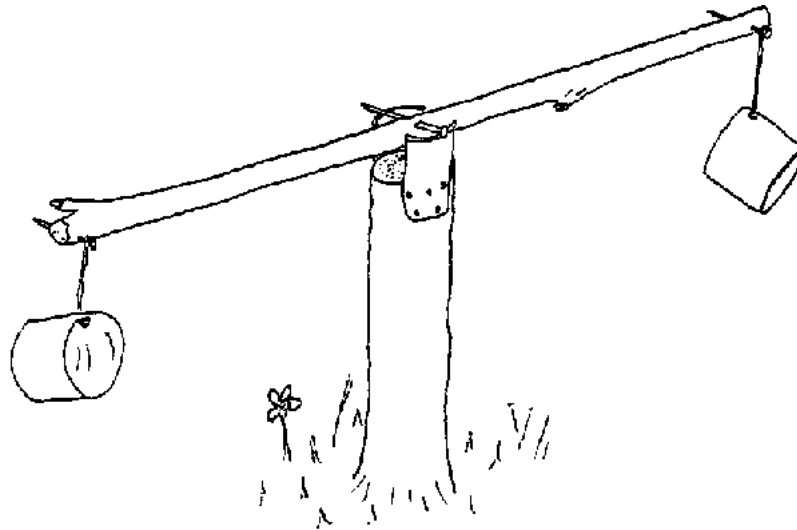
**In this explanation, the weight of the beam is staying the same it is the weight of a ruler. If you need to make an extremely sensitive balance, the same principles described here can be used with a light weight beam made from thin cardboard. Similarly, if a more rugged balance is needed for heavier weights, a design using parts of a tree could be made, similar to the diagram at the end of this explanation.**

**Now put the nail in the new hole you have made near the edge of the ruler. First put it on the pivot with the hole near the lower edge of the ruler. You will see that it does not balance when it is used this way. This is because the center of gravity of the ruler is above the pivot. The ruler tries to fall to a position where its center of gravity is below the pivot.**

**Now put the ruler on the pivot so the new hole (with a nail through it that rests on the**

**edges of the tins) is near the top edge of the ruler. Repeat the same procedure of testing the sensitivity of the balance by putting one pin on one side, when you have zero, five, ten, fifteen and twenty pins already in the containers at each end of the beam.**

**You now have seen how the sensitivity varies according to where you make the holes at each end, and the hole in the center that the pivoting nail goes in. Now you will be able to make a balance where you can design what the sensitivity will be, even if you use materials such as shown in the following diagram:**



**Figure**

### **Appendix G. Making a set of weight's**

**Without a set of weights, an equal arm balance can be used to see whether various objects**

**are equal in weight or not. This is done in Activity I-6, where the equal arm balance shows that if one of the cubes is cut into several pieces, the pieces still weigh the same as the other cube that was not cut.**

**If the objects are to be weighed with the equal arm balance, a set of weights is needed. This is necessary where the weight of a piece of fresh food is to be compared with the weight of the same piece of food after it has been dried. The equal arm balance can be used for weighing by putting the piece of food on one side of the balance and by putting enough weights on the other side to balance the food.**

**The set of weights should be based on some easily available objects that all weigh about the same. In Appendix S, things like staples, common pins, and paper clips are suggested for testing the sensitivity of the balance. However, these are too light to be useful for weighing the food pieces. They also have the disadvantage that unless they are all bought from the same source, they may not all have the same weight. Washers also do not make suitable weights, because they are made from scrap pieces of sheet metal, and although the diameter may be the same, the thickness varies tremendously.**

**Bottletops from Coca-Cola, Fanta and beer bottles are quite uniform in weight. These are probably the best things on which to base your set of weights. They have the added advantage of being obtainable for free.**

**The set of weights can consist only of bottletops. For example, a piece of food might weigh 130 bottletops fresh and 47 bottletops after being dried. This gets to be a lot of bottletops to pile on the balance, however.**

**Somewhat heavier objects that are quite uniform are batteries of the kind used in flashlights and radios. The weights may vary between batteries from different makers, but all batteries of a certain type made by the same company should weigh about the same. Consider that you have some small batteries that each weigh 14 bottletops, and some**

**large batteries that each weigh 55 bottle-tops. To weigh the fresh food in the example, two large batteries would equal 110 bottle-tops, one small battery would add 14, and 6 bottle-tops would add the rest, to reach the total of 130 bottle-tops of weight. To weigh the dried fruit, three small batteries would equal 42 bottle-tops, and 5 bottle-tops would be added to balance the food's weight of 47 bottle-tops.**

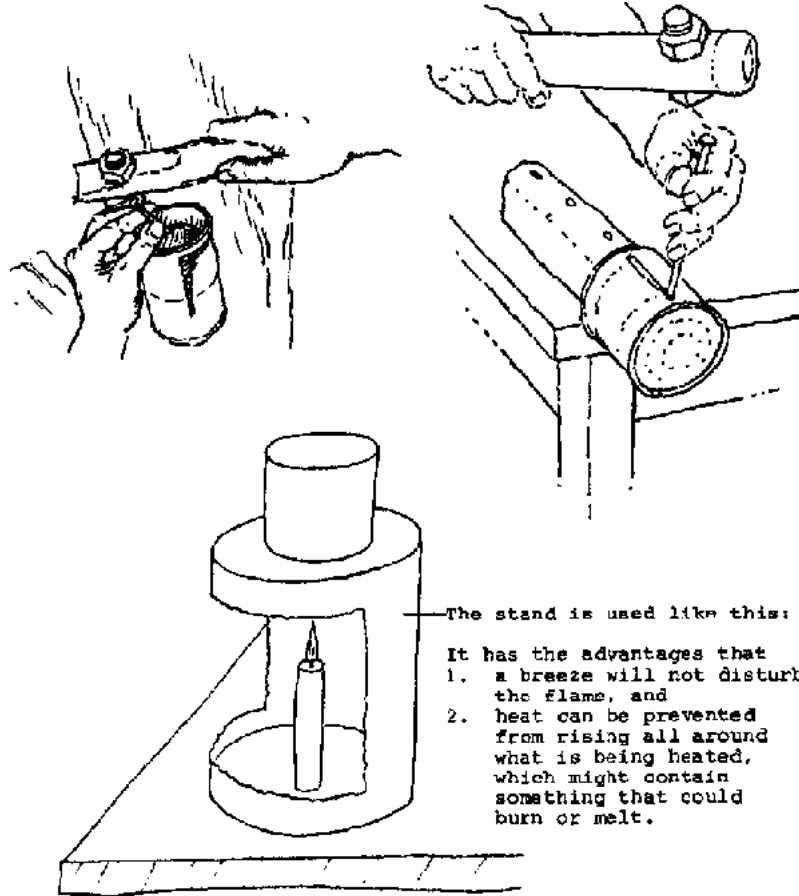
**Objects such as these can be used to make sets of weights suitable for all the food drying activities in this book.**

	Fresh Food				Dried Food			
	Objects on balance	X	Object weight	= Equivalent weight	Objects on balance	X	Object weight	= Equivalent weight
Large Battery	2	X	55	= 110	0	X	55	= 0
Small Battery	1	X	14	= 14	3	X	14	= 42
Bottle-tops	6	X	1	= 6	5	X	1	= 5
Total weight (bottle-tops)	130				47			

**Table**

#### **Appendix H. A heating stand made from a tin**

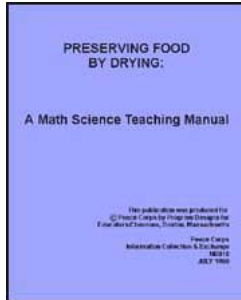
**Using one of the methods of cutting a tin shown previously, you can make heating stands while you obtain rectangular pieces of metal to use for other purposes.**












**Figure**



[Home](#) > [ar.cn.de.en.es.fr.id.it.ph.po.ru.sw](#)



-  **Preserving Food by Drying: a Math-Science Teaching Manual (Peace Corps, 1980, 218 p.)**
-  **(introduction...)**
-  **Acknowledgments**
-  **Introduction**
-  **Part 1. Weather**
-  **Part 2. Food dryers**
-  **Part 3. Nutrition**
-  **Appendices**
-  **References**

## References

**Christiansen, Per and Bernard Zubrowski, How to make Tools, Peace Corps ICE Reprint #35, Washington, D.C., 1980**

**Daniels, Farrington. Direct Use of the Sun's Energy. (p. 271) (\$1.95 paperback) Ballantine Books, Division of Random House, 201 E. 50th St., NY, NY. 10022 (1974). Available in most college bookstores and most bookstores that have science or ecology sections. Dr. Daniels was America's leading authority on solar energy. Excellent background material for any solar energy experimentation with students, farmers or builders. Fairly technical. Chapters on radiation, measurement, geographical distribution of radiation, as well as chapters on solar cooking, heating buildings, heating and distilling water, solar drying and solar energy conversions to electrical energy.**



**Dick, William. Dick's Encyclopedia of Practical Receipts and Processes or How They Did It in the 1870's.** Leicester and Harriet Hansfield, editors. P. 607 (\$7.95) Funk and Wagnalls, distributed by Thomas Crowell Company, 666 5th Ave., NY, NY 10019 (1975). Available from the Whole Earth Access Company, Berkeley, CA. This book is fun to read through to develop an appreciation for the practical arts of the late 1800's, as well as increase one's awareness of the methods used for appropriate technology. It is a collection of practical science recipes and processes. Its major drawback is that the terms used for various chemicals and processes are antiquated and are not readily translatable to the young scientist of the late 1900's! We hope to remedy this in a later Peace Corps publication. Recipes and processes in Dick's include: soap making, wine making, brewing, perfumes, toothpastes, cheese, preservatives, disinfectants, cements, and pastes, whitewash and paints, electroplating, acids and alkaloids, and medical receipts. Useful and enjoyable!

**Hertzberg, R., B. Vaughn and J. Greene. Putting Food By.** (p. 565) (\$2.50 paperback revised edition) Bantam Books, Inc., 666 5th Ave., NY, NY 10019 (1976). Available in most bookstores with cooking sections. Most useful compilation of all the safe ways to preserve foods: drying, canning, freezing, pickling. Useable tables and charts.

**Lappe, Frances. Diet for a Small Planet.** (p. 301) (\$1.95 revised paperback) Ballantine Books, Division of Random House, 201 E. 50th St., NY, NY 10022. A discussion of protein sources and how to plan diets without using animal protein. Well written information that can be used for nutrition lessons. Easily modifiable recipes with high protein content. Gives the reader..."a way of eating that makes the most of the earth's capacity to supply this vital nutrient, ...protein."

**Magee, John. How to Build Food Drying Equipment,** (p. 17) (\$2.00 paperback), California Wood Plans, P.O. Box 5 1, San Luis Obispo, CA 93406 (1975). Also available through the Whole Earth Truck Store, San Mateo, CA. Step-by-step guide to building three basic types of food dryers with steps to modify the designs for varied heat sources. The plans use

**plywood and therefore need to be modifies for use in most developing countries.**

**McDowell, James. Solar Drying of Crops and Foods in Humid Tropical Climates, The Caribbean Food and Nutrition Institute, Jamaica Centre-Trinidad Centre, 1973**

**Organic Gardening and Farming Magazine, "Solar Drying: It's Energy Free", Staff Report, August, 1977. "How to Use Dried Foods", Ron Beasley, August, 1977. "Build a Low Cost Indoor Dryer", Brenda Bortz, August, 1975. Rodale Press, Inc., 33 E. Minor Street, Emmaus, PA 18049. Subscription rates (in 1977 us Dollars): United States and Possessions: One year, \$7.85; Two years, \$14.25; Three years, \$19.95. (In Canada, add an additional \$1.00 per year, other foreign, add \$1.50 per year). Single copies are \$.75 each.**

