

➔  **Livestock and Poultry Production (IIRR, 1992, 106 p.)**

 **(introduction...)**

 **Message**

 **Workshop to revise the agroforestry technology information kit (ATIK)**

 **List of participants**

Current program thrusts in upland development

 **(introduction...)**

 **1. Integrated social forestry program (ISFP)**

 **2. National forestation program (NFP)**

 **3. Forest land management agreement (FLMA)**

 **4. Community forestry program (CFP)**

 **Simple agro-livestock technology (SALT-2)**

 **Intensive feed garden**

 **Characteristics of forage grasses for IFG**

 **Plant-based livestock medication**

-  **Small-scale cattle production
Forced-feeding technology (including Batangas
cattle-fattening system)**
-  **Native pig production**
-  **Pig-feed garden**
-  **Low-cost goat housing**
-  **Improving the native chicken**
-  **Family Backyard Poultry project**
-  **How to raise ducks**
-  **Native bee production**
-  **On-farm fodder sources in agroforestry (trees
and grasses)**
-  **Off-farm fodder sources in agroforestry (trees
and grasses)**



 **Livestock and Poultry Production (IIRR, 1992,
106 p.)**

  ***(introduction...)***

 **Message**

 **Workshop to revise the agroforestry
technology information kit (ATIK)**

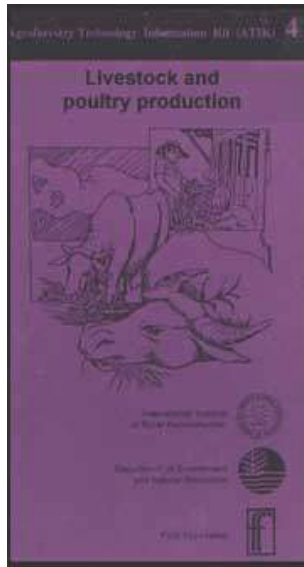

-  **List of participants**
-  **Current program thrusts in upland development**
-  **Simple agro-livestock technology (SALT-2)**
-  **Intensive feed garden**
-  **Characteristics of forage grasses for IFG**
-  **Plant-based livestock medication**
-  **Small-scale cattle production**
-  **Forced-feeding technology (including Batangas cattle-fattening system)**
-  **Native pig production**
-  **Pig-feed garden**
-  **Low-cost goat housing**
-  **Improving the native chicken**
-  **Family Backyard Poultry project**
-  **How to raise ducks**
-  **Native bee production**
-  **On-farm fodder sources in agroforestry (trees and grasses)**

 **Off-farm fodder sources in agroforestry (trees and grasses)**

International Institute of Rural Reconstruction (IIRR) Silang 4118, Cavite, Philippines Tel. No. (0969) 94-51 Fax No. (632) 522-24-94

Department of Environment and Natural Resources (DENR) Visayas Ave., Diliman Quezon City, Philippines

Ford Foundation (FF) 6th Floor, Doña Narcisa Bldg. Paseo de Roxas, Makati Metro Manila, Philippines

ISBN: 0-942717-31-7



 **Livestock and Poultry Production (IIRR, 1992, 106 p.)**

 ***(introduction...)***

 **Message**

 **Workshop to revise the agroforestry technology information kit (ATIK)**

 **List of participants**

 **Current program thrusts in upland**

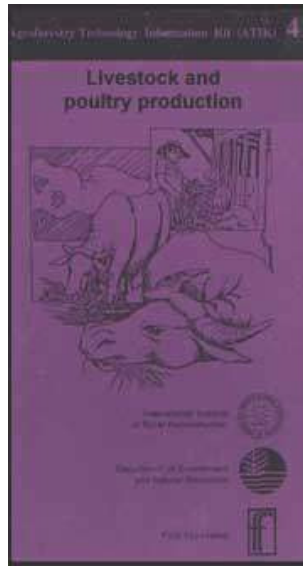

- development
- Simple agro-livestock technology (SALT-2)
- Intensive feed garden
- Characteristics of forage grasses for IFG
- Plant-based livestock medication
- Small-scale cattle production
- Forced-feeding technology (including Batangas cattle-fattening system)
- Native pig production
- Pig-feed garden
- Low-cost goat housing
- Improving the native chicken
- Family Backyard Poultry project
- How to raise ducks
- Native bee production
- On-farm fodder sources in agroforestry (trees and grasses)
- Off-farm fodder sources in agroforestry (trees and grasses)

Small-scale cattle production

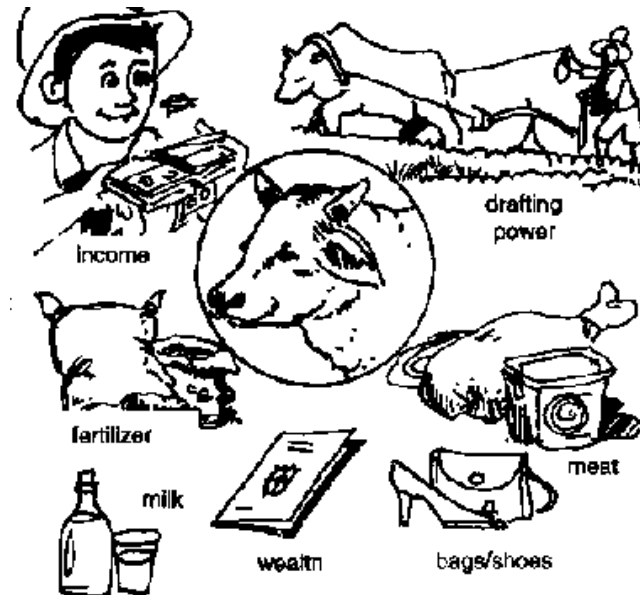

Small-scale cattle production

In the Philippines, between 75 and 90 percent of the total cattle production are raised in backyard systems. Smallscale cattle production offers many benefits.

Raising cattle on the farm helps to promote integration with crops,

trees and soil and nutrient cycling is facilitated. Crop residues not suited for human consumption can be converted to food such as milk and meat. Waste in the form of manure can also be incorporated to the soil to fertilize high-value crops. Generally, between one and five heads of cattle are raised by farmers in backyard systems.

The most common limiting factor in backyard cattle production is the poor quality, of feed and or inadequate feed. Grasslands and native pastures only provide fodder for the maintenance of animals and not for improved reproduction or performance. Feed quality, not quantity alone, is critical in cattle feeds and feeding.

Selection of feeder stock

Zeb-breed grade bulls or steers which weigh approximately 180 kg and are between three years of age are preferred as feeder animals. At this age, the rate of growth is faster and more efficient, so that the desired market weight of 275 kg can be easily reached in a shorter fattening period. A daily rate of gain of between 0.5 to 0.8 kg can be expected, especially if enough feeds of sufficient quality can be provided. The health condition of the animal is determined by its bright eyes, soft smooth hair coat and moist muzzle. Avoid blind or lame animals with rough skin and long dull hair. The animals should be square-shaped,

with well-spung ribs and straight legs.

Production practices



Tethering or Staking

Tethering or Staking -This is one of the most common methods of raising cattle by small farmers who have a few head of cattle. The animals need to be moved several times throughout the day.

Unfortunately, the wide- spread monocropping and large-scale production of cash crops have resulted in the reduction or loss of pasture areas formerly alloted for tethering of animals.



Stall feeding or zero grazing

Stall Feeding or Zero Grazing - Also known as Cut and Carry System. Animals are completely confined in stalls. Feed is carried to them and fed in the stall.

This practice promotes wise use of land. Pasture areas can be divided into a cash crop production area and a forage production area thus income generation can be derived from crops and livestock. Nutrient cycling can also be enhanced

Housing

Cattle sheds are usually constructed using local materials such as bamboo, nipa and coco lumber. A 1.5-sq m area (0.75 m × 2 m) per animal is necessary for shelter. A 5-sq m fenced area for exercise is advisable. If possible, the shed flooring should be cemented or elevated for good drainage and easier removal of manure. The roof of the shed should be at least 3 m high. Feeding troughs and waterers should be provided.

If complete confinement of several animals will be practiced, as in the zero grazing, each stall should measure 1.5 × 4 m which can accommodate the feeder stock during the entire fattening period.

Additional information on feeding fatteners

The primary and most cost-effective source of feed for cattle is quality forage or roughage. Farm wastes such as com stover, rice straw and sugar cane tops are usually given together with some concentrates. Good quality grass usually contains eight percent crude protein on a dry matter basis; growing feeder stock need about 12 percent for normal growth. A grasslegume mixture would be better since legumes contain about 20 percent crude protein and have a high calcium value. On the

average, cattle consume feed dry matter (less water) at a level of two percent of its body weight. The percentage is higher for young animals and decreases as the animal matures. For example, a 300-kg animal is expected to consume about 6 kg dry matter of feed per day or roughly 24 kg fresh forage.

Since feeding roughage may not be adequate to supply the required energy and protein for fattening, it is necessary to add concentrates in the diet at the rate of 1 to 1.5 percent of the animal body weight. Concentrates can either be formulated and mixed in the farm or purchased off-farm. Molasses, a good source of energy, is usually added to the ration to increase palatability. Rations containing 15-25 percent concentrate and 75-85 percent roughage have been found to be satisfactory in promoting good daily weight gain. One half of the ration should be given in the morning; the other half in the afternoon. The ration to be fed to the animal will also depend on the size of the animal at the time they are purchased and the desired final weight. Ordinary salt (30 to 50 gms/day/head) and good quality water should be provided at all times. Newly purchased feeder stock should be gradually introduced to the concentrate diet.

Do you know that...

Annually, one head of cattle excretes 60 kilograms Nitrogen, four kilograms Phosphorus and 18 kilograms Potassium.

A cow reaches puberty at the age of 18 months and has a gestation period of 283 days. Estrous cycle is 18 - 24 days.

Cattle can be used in transporting farm products to and from markets and to transport fuel, water and goods.

It takes about 1,000 days to breed and raise cattle to the butchering weight of 400-500 kilograms.

On an average, Filipinos consume two kilograms of beef per year as the country's cattle supply drops continuously.



 **Livestock and Poultry Production (IIRR, 1992, 106 p.)**



 ***(introduction...)***

 **Message**

 **Workshop to revise the agroforestry technology information kit (ATIK)**

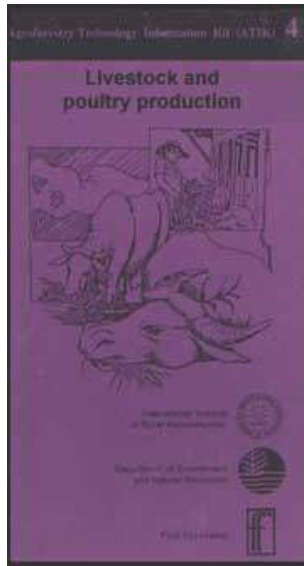
 **List of participants**



- Current program thrusts in upland development**
-  **Simple agro-livestock technology (SALT-2)**
-  **Intensive feed garden**
-  **Characteristics of forage grasses for IFG**
-  **Plant-based livestock medication**
-  **Small-scale cattle production**
-  **Forced-feeding technology (including Batangas cattle-fattening system)**
-  **Native pig production**
-  **Pig-feed garden**
-  **Low-cost goat housing**
-  **Improving the native chicken**
-  **Family Backyard Poultry project**
-  **How to raise ducks**

-  **Native bee production**
-  **On-farm fodder sources in agroforestry (trees and grasses)**
-  **Off-farm fodder sources in agroforestry (trees**

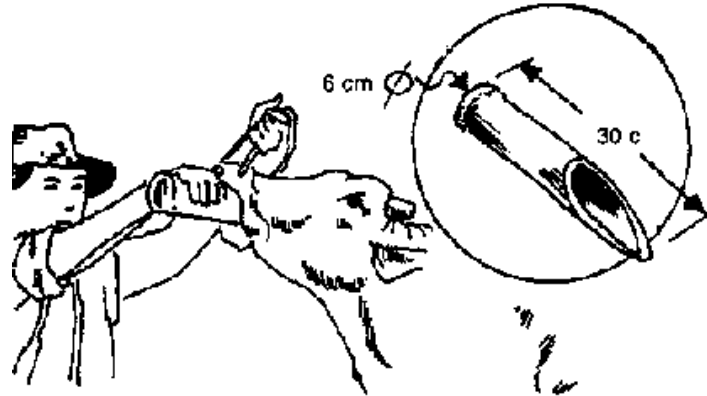
and grasses)**Forced-feeding technology (including Batangas cattle-fattening system)****Forced-feeding technology**

Forced-feeding technology is used in fattening draft cattle in confinement in a shorter period of time. Known as supak method, this apparently indigenous practice from Batangas is done 60-90 days before the livestock is sold. The feed composition makes for rapid increase in body weight (because of high feed conversion rate) and improved meat quality.

Below are the steps in preparing the feed mixture.

- 1. Get about 20 kg of fresh leaves of ipil-ipil (*L. leucocephala*) or acid ipil-ipil (*L. diversifolia*) and chop them. Remove the midribs.**
- 2. Pound the leaves with mortar and pestle and put these into a mixing container.**
- 3. Add 1-2 kg of fine rice bran, 15-19 liters clean water and a handful (0.1 kg) of salt. Mix the ingredients thoroughly.**

This mixture is fed to the cattle using a bamboo tube (as shown above) once or twice daily. The animal is also provided full feeding of soilage. Provide water at all times. Later, when the animal is used to the feed mixture (slop), it will eat it on a pail.

Feeding the animal six times a day gives the best results.

7:00 a.m. - fodder or cut grasses

10:00 a.m. - forced feeding

12:00 noon - fodder

3:00 p.m. - fodder

5:00 p.m. - forced feeding

8:00 p.m. - fodder

Cattle with poor appetite should also be forced-fed regularly in addition

to fodder provided to them. Any of the following mixtures is divided into two and given to animals twice a day:

- **Pounded ipil-ipil leaves (15-20 kg) + water (15 li) + granulated table salt (0.1 kg)**
- **Finely chopped gabi tuber the kind which is edible to man (15-20 kg) + water (15 li) + table salt (0.1 kg)**
- **Rice bran (2-3 kg) + water (15 li) + table salt (0.1 kg)**

Proper position of animal when forced feeding. The head is level with the animal's back. The animal can be killed by improper forced feeding. The slop goes into its lungs instead of the stomach, which causes pneumonia. If the animal chokes, lower the head immediately to save R.

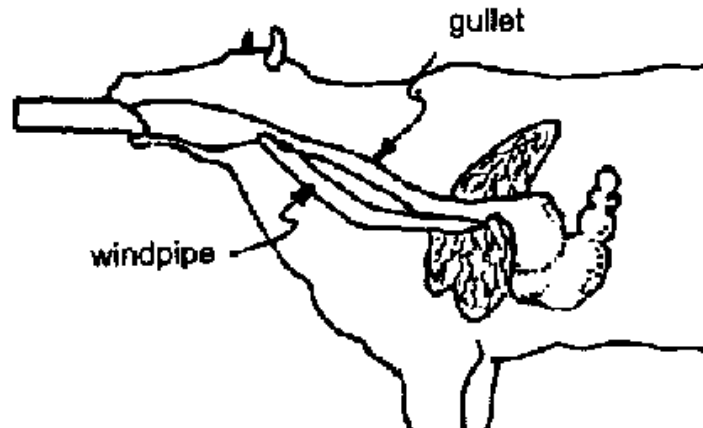

Proper position of animal when forced feeding

Case study of batangas cattle fattening system

Backyard cattle fattening is important to the livestock industry in the Philippines. It can provide farmers year round work and additional income. Batangas farmers have a unique cattle fattening system. They use cheap farm by-products which ordinarily go to waste. The technology of Batangas farmers include:

1. Selecting feeder stock

Age - Two to three-year old animals with a body weight of 225 to 300

kg digest more efficiently. They eat a large variety of feed and roughages that are available.

Sex - Steers (castrated males) are preferred to heifers. Steers are easier to manage; they gain weight and grow faster.

Breed - Improved breed like crosses (mestisos) gain weight faster. They are adaptable to local climatic and feed conditions. Majority of Batangas farmers like to raise Batangas steers weighing 320 to 468 kilograms.

Health condition - A healthy animal is alert, active, has bright eyes, smooth haircoat, moist muzzle and have no physical defects. Be sure that the animal is vaccinated against foot and mouth diseases and/or hemorrhagic septicemia. The animal should be free from external and internal parasites.

2. Where to buy the stock

Farmer's farm

Livestock market

Private ranch at the onset of the dry season.

3. Feed requirements

Cattle can be fattened on an all roughages or grasses ration. Young fattener consumes about 22-25 kg of silage/day under ordinary conditions. Sources of fodder feeds are mostly grown on the farm.

Restrict animal movement at all times to gain weight quickly.

Provide clean drinking water at all times. Water helps in feed digestion and ensures nourishment.

Provide table salt (granulated) at the rate of 30-50 grams per head daily.

Force-feed (supak) concentrate mixture at least twice a day. They are mixed with pounded ipil-ipil leaves at the rate of 10-20 kg/day.

	RATION	
	1	2
Copra meal	60%	50%
Rice bran	39%	25%
Salt/powdered shell/ground limestone	1%	1%
Dried chicken manure	0	24%

4. Bathe the animal during hot weather to enable them to overcome heat stress.

5. Housing and equipment

Minimum housing space is 2.5 to 4 sq m per head for sheltered feeding. Others provide 5 meters/head for loafing area. A Cattle shed of local materials (bamboo, nipa wood) is enough to protect the animal from extreme heat and cold. Provide each animal its own stall, feed through or bunk, standing space and floor drain at the back. It is also advisable to use cement floor to ease cleaning and drainage. Place a rope halter on the head of the animal at all times.

6. Market fattened Cattle at the end of the fattening period (two to six months).



 **Livestock and Poultry Production (IIRR, 1992, 106 p.)**

 **(introduction...)**

 **Message**

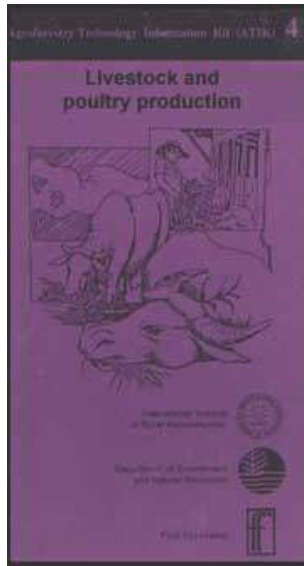

-  **Workshop to revise the agroforestry technology information kit (ATIK)**
-  **List of participants**
-  **Current program thrusts in upland development**
-  **Simple agro-livestock technology (SALT-2)**
-  **Intensive feed garden**
-  **Characteristics of forage grasses for IFG**
-  **Plant-based livestock medication**
-  **Small-scale cattle production**
-  **Forced-feeding technology (including Batangas cattle-fattening system)**
-   **Native pig production**
-  **Pig-feed garden**
-  **Low-cost goat housing**
-  **Improving the native chicken**

-  **Family Backyard Poultry project**
-  **How to raise ducks**
-  **Native bee production**



On-farm fodder sources in agroforestry (trees and grasses)

Off-farm fodder sources in agroforestry (trees and grasses)

Native pig production

Native pigs are important sources of income, food and manure on small farms. Native pigs are sold to friends and neighbors, used during special occasions or serve as a profitable part-time job for family members. These pigs are considered sturdy and are more resistant to various hog diseases. They can survive on kitchen wastes and farm-grown feeds or farm by-products.

Backyard swine raisers may prefer to raise native pigs than the imparted breeds of swine mainly due to the scarcity of capital resources to purchase initial stock and to build a house/pen and to provide commercial feeds.

Table 3. Comparison.

		UPGRADED	PURE BREED
Age (from birth to market) native	7-9 months	7 months	4.5-5.5 months
Carcass weight	40 kilos	50 kilos	60-70 kilos

Low-cost housing/pen of native pigs

Considerations:

- 1. Site - Elevated, near water source**
- 2. Orientation - East to west orientation; with this type of orientation, floor of the pen is kept dry.**
- 3. Roofing materials - Cogon, nipa, used G.I. sheets**
- 4. Flooring materials**
 - a. Cement**
 - Thickness: 3.5-4" (88.9-102 mm)**
 - Preparation: 1 part cement, 3 parts gravel, 2.5 parts sand, 2/3 parts water**
 - b. Wood slabs**
 - c. Bamboo**
- 5. Space requirement for two heads of pigs: 2 sq m**

6. Sidings: bamboo

Note: Gliricidia and Leucaena are not applicable since these could be eaten up by the pigs.

Height of sidings:

36" (914 mm) for fatteners and breeders

30" (762 mm) for weanlings and starters

7. Feeding and watering trough materials used:

a. cement

b. wood

c. bamboo

d. halved-tire

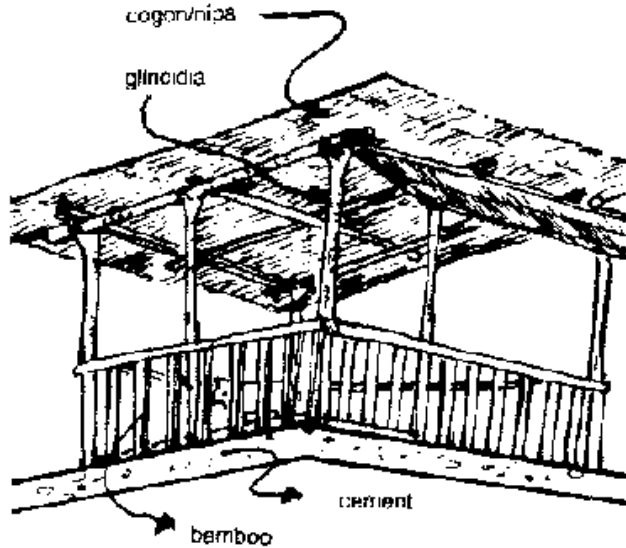

Low-cost housing/pen of native pigs

Feeds and Feeding

Common ways of preparing feeds

1. Grinding

This would depend on the age of the animal to be fed. Young animals do not have fully developed digestive system, hence, there is a need for

grains to undergo the process.

Example: Corn

2. Cooking

Through this process, the feeding value of some feed stuff is increased.

Likewise, calcium oxalate which causes itchiness is destroyed.

Examples: Beans and gabi

Table 4. Feeding management.

Weight	No. of Feeding time	Feeding System	Average Daily Intake
10 kgs (12.2 Ibs)	4x a day	Dry feeding	1-2 kgs a day
45 kgs (99 lbs)	3x a day	Wet feeding	2.2 kgs a day
55 kgs (121 lbs)	2-3x a day	Wet feeding	2.5 kgs a day

Considerations:

1. The number of feeding time presented would minimize feed wastage.

Note: Decrease the amount of feed given to animals with diarrhea.

2. Dry feeding is recommended for starters since they still have less feed intake; that way, spoilage of feeds is minimized.

Table 5. Examples of Feedstuff for native pigs

	Parts used
A. Protein sources	
1. Madre de Cacao	Leaves, stems,
Gliricidia sepium	flowers, fruits
Kakawat	
2. Ipil-ipil	Leaves, stems,
Leucaena leucocephala	flowers, fruits
3. Cowpea	Leaves, stems,
Visna sinensis	flowers, fruits
Paayap	
4. Hyacinth bean	Leaves, stems,
Dolichos lablab	flowers, fruits
Batao	
B. Energy sources	
	Grain

1. Corn	Grain
Zea mays	
Mais	
2. Cassava	Root
Manihot esculenta	
Kamoteng kahoy, balinghoy	
3. Sweet potato	Root
Ipomoea batatas	
Kamote	
4. Taro	Root
Colocasia esculenta	
Gabi	
5. Ubi	Tuber
Dioscora alata	
Ubi	
6. Arrow root	Root
Maranta arudinacea	
Uraro	
7. Tuqul	Root

Dioscorea esculenta	
C. Vitamin and mineral sources	
1 Malunggay	Leaves, stems, flowers, fruits
Moringa oleifera	
Malunggay, kalunggay	
2. Amaranth	Leaves
Amaranthas spinosus	
Uray, kulitis	
3. Sweet potato	Leaves, vines
Impomea batatas	
Kamote	
4. Gabi	Leaves, petiole
Colocassia esculenta	
D. Water sources	
1. Sweet potato	Leaves, stems,
Ipomea batatas	flowers
Kamote	
2. Kanakona (upland)	Leaves. stems

Ipomea aquatica	

Table 6. Examples of Feed Rations.

Starter (18% CP)	Grower to fatterer (14-16% CP)
1. Rice bran (D1) - 5.4 kgs. Com bran - 4.6 kgs	Rice bran - 7.2 kgs sapal - 2.8 kgs
2. Midlings - 6.3 kgs Com gluten - 3.6 kgs	2. Kamote (roots) - 5.0 kgs Ipil (leaves) - 5.0 kgs
	3. Cassava (roots) - 3.2kgs Rice bran - 6.8 kgs
	4. Com bran - 3.0 kgs Mollases - 2.0 kgs
	Tugui (roots) -1.5 kgs
	Fish washings -1.0 kgs
	Ipil (Leaves) - 2.5 kas

Table 7. Native pig diseases and Their Common causes and treatment

Disease	Transmission	Signs/symptoms	Treatment
A. Bacterial			
1. Swine	Dirty feeds, water and pen	Acute form - lameness, vomiting, diarrhea, reddening of skin in thighs and abdomen	Decoction of guava or caimito leaves
Erysipelas	Nose	Chronic form - recurring lameness	Penicillin Streptomycin
	Open wounds	Urticarial form - fever, anorexia, reddening of skin in abdomen, inner thighs, chest and back (diamond-shape)	
2. Colibacillosis	Dirty feeds and water	Whitish to yellowish diarrhea	Decoction of guava or caimito leaves
	Unsanitary condition of peo	Anorexia	Coco juice
	Spoiled	Swollen evelids	Antibiotic

	feedstuff		Trimethoprim
			Sulfa preparation
B. Viral			
Diseases due to virus are difficult to treat. There is no specific medication to combat the disease. Antibiotics, vitamins and minerals are given to fight secondary bacterial infections.			
1. Hog cholera	Contact with discharges from sick pig	Vascular discharge	Serum
	Dirty feeds, water and pen	High fever	Vitamin and minerals
		Diarrhea, then constipation	Tetracycline
			Coco juice
2. Foot and mouth disease	Contact with discharges from sick pig	Drooling of saliva	Gentian violet saturated with alum
		Anorexia (inappetence)	
		Vesicles in mouth hooves and	

vesicles in mouth, hooves and
udder

C. Parasitic

1. Mange/Scabies	Contact with infested pigs	Frequent scratching	Apply used motor oil all over the belly
		Alopecia (hair loss)	Extracts of kakawati
		Unthriftiness	
		Thickening of skin	
2. Lice (oftenly seen in less hairy areas of the body)	Contact with infested pigs	Unthriftiness	Raw seeds of kakawati
	Voracious eater but poor feed conversion	Thick, rough hair	Raw seeds of ipil-ipil
		Raw seeds of squash	

Note: Preparation and application of herbal medicines are presented in Plant-based Livestock Medication, Booklet No. 4.

Table 8. Vaccination program for native pigs

Vaccine	First dose	Next dose
1. Hog cholera	45 days old	after 6 months
2. FMD	1-2 months	after 6 months

Note: Consider disease incidence in the area as to which vaccine would ho given first

Table 9. Herbal medicine

Plant	Parts used	Indication	Preparation
1. Sambong Blumea balsamifera	Leaves	Colds	Boil leaves in water. Give 0.5-1.0 liter as drench 2x a day for 1-5 days.
		Fever	
		Diarrhea	

2. Ipi-ipil	Seeds	Roundworms	Grind and mix seeds into 5-8 oz of water. Given as drench.
Leucaena leucocephala Note: This is contraindicated with pregnant sows/gilt.			
3. Squash	Seeds	Tapeworms	Mix raw seeds in feeds.
Cucurbita maxima			
4. Starapple Chrysophyllum cainito	Leaves	Diarrhea	Boil 1 kg of leaves in 1 liter of water for 15 minutes Give 1 cup 2x a day for 1-3 days
5 Saba Musa sapiantum	Leaves	Diarrhea	Chop leaves and mix with feeds.
6 Madre de Cacao Gliricidia sepium	Seeds	Roundworms	Mix seeds with feeds.
7 Malunggay Moringa oleifera	Leaves	Anemia	Give 1 cc extract for day old pigs, once 9 day for 3-5 days (if necessary).
8. Guava Psidium guajava	Leaves	Diarrhea	Boil leaves and give 1-2 glasses of decoction 2-3x a day for 1-2 days.



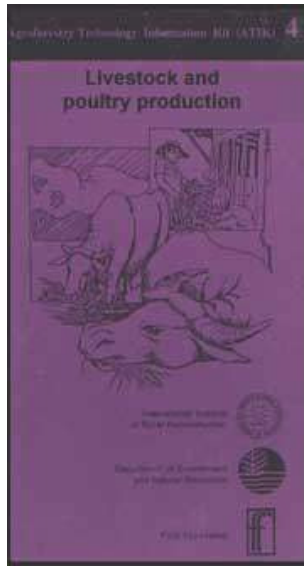

106 p.)

 **(introduction...)**

 **Message**

 **Workshop to revise the agroforestry technology information kit (ATIK)**

 **List of participants**

Current program thrusts in upland development

 **Simple agro-livestock technology (SALT-2)**

 **Intensive feed garden**

 **Characteristics of forage grasses for IFG**

 **Plant-based livestock medication**

 **Small-scale cattle production**

 **Forced-feeding technology (including Batangas cattle-fattening system)**





 **Native pig production**

 **Pig-feed garden**

 **Low-cost goat housing**

 **Improving the native chicken**

 **Family Backyard Poultry project**

-  **How to raise ducks**
-  **Native bee production**
-  **On-farm fodder sources in agroforestry (trees and grasses)**
-  **Off-farm fodder sources in agroforestry (trees and grasses)**

Pig-feed garden

Pig-feed gardening is the planting of rootcrops, vegetables, leguminous trees and nonconventional feedstuff on a piece of land, approximately 200 sq m. The garden can support 4-5 average-size pigs.

Table 10. recommended plants for the pig feed garden (PFG).

Plant	Parts used	Propagation
A. Protein sources		
Madre de cacao	Leaves, stems, flowers, young fruits	Seeds and cuttings
Gliricidia sepium		
Kakawati (Tagalog)		

Ipil-ipil	Leaves, stems, flowers, young fruits	Seeds and cuttings
Leucaena leucocephala		
Cowpea Visna sinensis Paayap (Tagalog)	Leaves, stems, flowers, young fruits	Seeds
Hyacinth bean Dolichos lablab Bataw (Tagalog)	Leaves, stems, flowers, young fruits	Seeds
Cassava	Leaves	Cuttings
Manihot esculenta		
Kamoteng Kahoy (Tagalog)		
Balinghoy (Bicol)		
B. Energy sources		
Corn	Grain	Seeds
Zea mays		
Mais (Tagalog)		
Cassava	Root	Cuttings
Manihot esculenta		
Kamoteng Kahoy (Tagalog)		
Balinghoy (Bicol)		

Sweet potato	Root	Cuttings
Ipomea batatas		Rootsprouts, root
Kamoteng (Tagalog)		
Gabi	Corm	Sucker, rhizomes, corms
Colocasia esculenta		
Ubi (white)	Tuber	Sucker, tuber
Dioscorea a/ata		
Ube (Tagalog)		
Arrowroot	Root	Sucker, Rootbits
Maranta arudinacea		
Oraro (Luzon, Visayas)		
Sago (Panay)		
Tugui	Tuber	Tuber
Dioscorea esculenta		
Tugui, tague (Luzon)		
Apali/Apari/		

Talipiso (visayas)		
Buri	Stem	Seed
Coreypa alata		
Sorghum	Grains	Seed
C. Vitamin and mineral sources		
Malunggay	Leaves, stems, flowers, fruits	Seeds and cuttings
Moringa oleifera		
Amaranth	Leaves	Seeds
Amarantus spinosus		
Ural (Ilokano)		
Kulitis (Bicol, Tagalog)		
Sweet potato	Leaves, vines	Cuttings, roots, rootsprouts
Ipomoea batatas		
Kamote		
Japanese malunggay	Leaves	Seeds, cuttings
Sauropus androgenus		
Gabi	Leaves, petioles	Sucker, rhizomes.

Colocasia esculenta		corms
D. Water sources		
Sweet potato	Leaves, stems, flowers	Cuttings, roots root sprouts
Ipomoea batatas		
Kamote		
Kangkong (aquatica)	Leaves, vines	Seeds and cuttings
Ipomoea aquatica		

Considerations:

1. Factors considered in the selection of plants are:

- a. availability
- b. nutritional content
- c. drought resistance
- d. disease resistance
- e. can be planted on a variety of soil
- f. perennial, annual plants

2. In areas where free water abounds, other feedstuffs like

Azolla, Galiang (*Alocasia macrorrhiza*) and kangkong (lowland) can be planted. Azolla is high in protein (17-28 percent CP). Galiang is a good source of energy while kangkong is also a good source of water, vitamin and minerals.

3. Other non-conventional feedstuffs can be used as pig feed (See Table 11)

TABLE 11 Other non-conventional feedstuffs

Plant	Parts used	Propagation
Talinum	Leaves, stems	Cuttings
T. triangulare		
Espinacas		
Ulasiman	Leaves, stems	Cuttings
Portulaca oleracea		
Alugbati	Leaves, stems,	Cuttings
Base/h alba	flowers, fruits	
Grana		
Nami	Tuber	Tuber
Dioscorea hispida		

Namo (Luzon)		
Kalut, Kurot, Kuwot (Visayas, Mindanao)		
Pongapong	Leaves, stems, corms	Cormels
Amorphallus campanulatus		
Bagong (Visayas)		
Banana	Stems, corms, body, leaves	Cormels
Musa sp.		
Saging (Tagalog)		
Batag (Bicol)		

4. Kitchen left-overs can be added to improve the nutritional value of the feed. These are:

- a. fish and rice washings**
- b. Egg shells**
- c. Fruit peelings**
- d. Over-ripe fruits**
- e. snails (Golden kuhol)**

5. Pig feed garden (PFG) provides a source of:

- a. less expensive and locally available feed ingredients**
- b. nutritious and palatable feedstuffs**
- c. green manure**
- d. alternative medications for pigs and other animals**
- e. extra income for the farmers**
- f. nutritious food for the family**

6. Management care

- a. A fence should be provided around the garden.**
- b. Apply compost and green manure to fertilize crops.**
- c. Provide drainage on waterlogged areas.**
- d. Plant insect-repellants.**
- e. Regularly weed and/or water the plants.**

7. The PFG can start feeding pigs from 3 weeks to 3 months, depending on type of plants used.

8. Feeding value of some common feedstuffs is influenced to a certain extent by the way they are prepared for feeding.

Table 12. Preparation of some common

Feed Stuff	Toxin	Preparation	Rationale
Cowpea Hyacinth bean	Trypsin- inhibiting factor	Cooking	Nutritional availability of protein is increased. Destroys anti- enzyme that depresses growth.
Cassava	Hydrocyanic acid	Washing	Toxic constituent is removed.
Gabi Tugui Ubi	Calcium oxalate	Cooking	Palatability is improved because itchiness is removed.
Buri	Pounding and drying of stem		Powder is collected.
Nami	Dioscorine	Sliced placed in sacks soaked in free flowing water for 3 days. Once snails are seen clinging to the sack,	To get rid of toxic substance



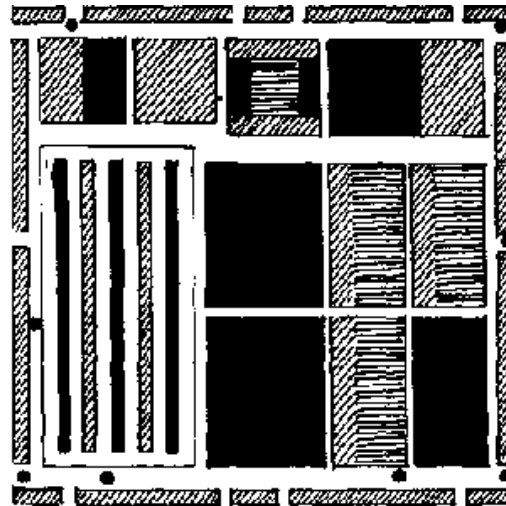

		it means toxic substance has been washed out and could then be used as feed.	
Snails		Pounding	To improve palatability and digestibility of protein and calcium
Pongapong	Calcium oxalate	Cooking	To improve palatability

Land Preparation and Planting

Land area should be cleared of all weeds before the bed preparation and planting. The fence line can be utilized for planting annual and perennial plants like horseradish tree, hyacinth bean, cassava, Gliricidia, Leucaena, ubi and tugui. Bio-intensive gardening (BIG) can be adapted for planting the other crops for the pig-feed garden.



PIG FEED GARDEN 200 Sq. ft.

-  - Water + Vitamins and Minerals
-  - Protein Source
-  - Vitamins and Minerals
-  - Carbohydrate Source

Pig feed garden

 **Livestock and Poultry Production (IIRR, 1992, 106 p.)**

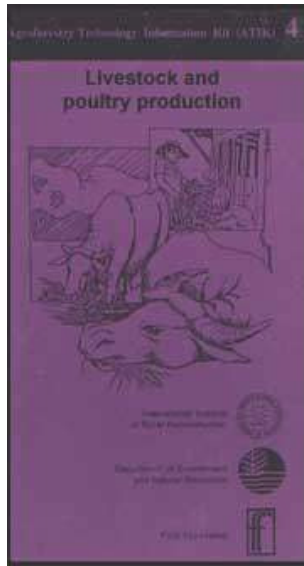

-  **(introduction...)**
-  **Message**
-  **Workshop to revise the agroforestry technology information kit (ATIK)**
-  **List of participants**
- Current program thrusts in upland development**
-  **Simple agro-livestock technology (SALT-2)**
-  **Intensive feed garden**
-  **Characteristics of forage grasses for IFG**
-  **Plant-based livestock medication**
-  **Small-scale cattle production**
-  **Forced-feeding technology (including Batangas cattle-fattening system)**
-  **Native pig production**
-  **Pig-feed garden**
-   **Low-cost goat housing**
-  **Improving the native chicken**
-  **Family Backyard Poultry project**
-  **How to raise ducks**



Native bee production



On-farm fodder sources in agroforestry (trees and grasses)



Off-farm fodder sources in agroforestry (trees and grasses)

Low-cost goat housing

Adequate housing provides conditions for good health and comfort of animals high reproduction and more efficient management. Housing also minimizes, if not eliminates, theft problems. Good housing is ideally cheap, yet it can protect the animals from strong winds, draft, heavy rains, wet grounds and attacks by predatory animals. It must also be wellventilated, well-drained and easy to clean.

Location

For good drainage, locate your goat house on a slight slope or on sandy soils; ideally, near the feed source. The goat house should be oriented in such a way that the greatest amount of sunshine and air enter the house.

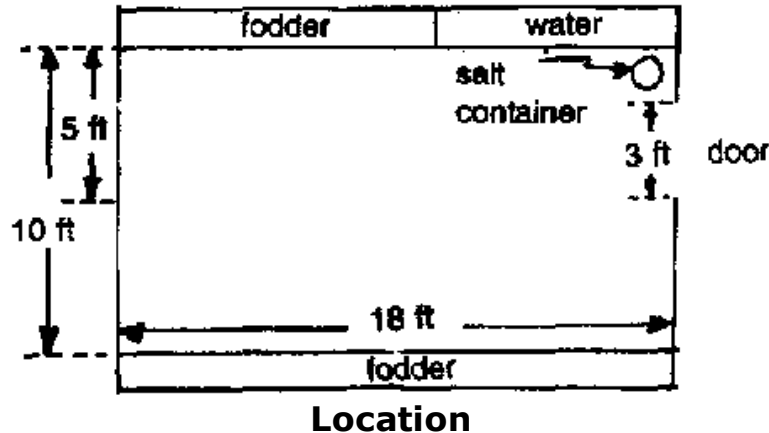

Housing specifications

Use indigenous materials available in the locality, such as round UMBER, bamboo and cogon or nipa.

1. Provide at least 15-20 sq. R. of floor space per adult goat. A separate housing is provided for the buck.
2. Raise the floor at least 3 feet above the ground to facilitate cleaning and removal of manure.
3. Do not nail the floor boards or slats closely; provide slits between

the boards so that manure can fall through them. This will keep the flooring clean and dry.

4. The house should be well-ventilated. The wall around the house can be made of bamboo slats spaced 44 inches apart.

5. Provide a sack cover on the windside of the house. This can be rolled up when not needed.

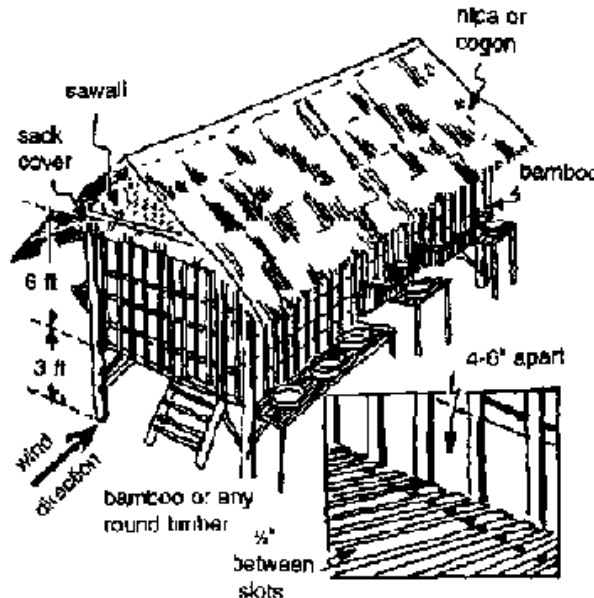

Housing specifications

Note: For two does and one buck raised together, the size of the goat house will be 6' × 8'.

Ipil-igil. Remove bark. Soak Umber in running water (river/stream) for 3 days to dissolve the carbohydrate content of the wood. Dry.

Bamboo. Mix 1 part crude oil: 2 parts kerosene. Paint this mixture on the split bamboo and season (sun-dry) for 4-7 days. Bamboo is more durable when harvested at the right time (mature, light green or yellow in color). Cut before the onset of the growing season, before the young shoots appear.

Feeding facilities

Provide the goat house with the following facilities:

- 1. Fodder rack. Elevate the feeder 1 1/2 ft above the floor and attach it to the goat house from outside.**
- 2. Water container. Plastic basins or pails can serve the purpose. Place this outside of the pen to avoid contamination with urine or manure.**

3. Salt container. A bamboo tube with 2 or more slits at the bottom can serve as container for the ordinary table salt for the goats to lick. Hang the bamboo tube inside the house.



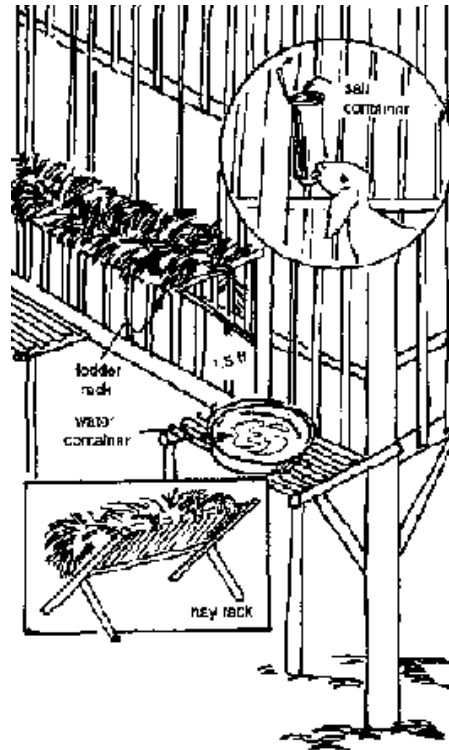





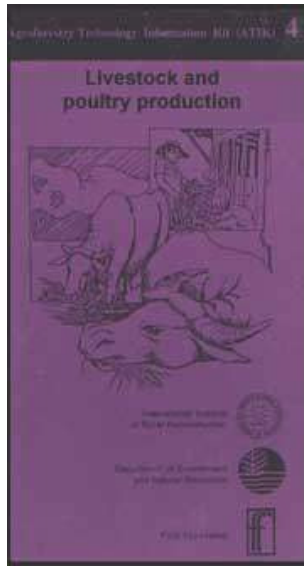

4. Hay rack. Store the fodder/forage in hay rack under a shade or shed adjacent to the goat house.



feeding facilities

 **Livestock and Poultry Production (IIRR, 1992, 106 p.)**



-  **(introduction...)**
-  **Message**
-  **Workshop to revise the agroforestry technology information kit (ATIK)**
-  **List of participants**
- Current program thrusts in upland development**
-  **Simple agro-livestock technology (SALT-2)**
-  **Intensive feed garden**
-  **Characteristics of forage grasses for IFG**
-  **Plant-based livestock medication**
-  **Small-scale cattle production**
-  **Forced-feeding technology (including Batangas cattle-fattening system)**
-  **Native pig production**
-  **Pig-feed garden**

-  **Low-cost goat housing**
-   **Improving the native chicken**
-  **Family Backyard Poultry project**



**How to raise ducks.
Native bee production**



On-farm fodder sources in agroforestry (trees and grasses)



Off-farm fodder sources in agroforestry (trees and grasses)

Improving the native chicken



Improving the native chicken

Majority of small and marginal farmers raise native chicken in their backyards. The native chicken are nondescript, mongrel birds that have evolved from jungle fowls interbred with domesticated ones brought into the country by early Chinese, Spanish and Dutch traders and settlers.

The native chicken have adapted themselves to adverse conditions in small farms - poor and scanty feeds, inadequate shelter, sudden changes of weather and rampant diseases. The birds are generally left to fend for themselves. As a result, they have acquired unusual hardiness.

These native birds supply the family with a few eggs and, occasionally, meat for home consumption, for barter or for sale. Their meat and eggs are claimed to be tastier and more savory than those of purebreds. Thus, inspite of their slow growth and small size, they are more costly. It takes them a year to obtain full size (1-1.5 kilograms). Under farm conditions, the hens give from 30-50 eggs in 34 cycles a year. The eggs are small and brown. The hens become broody for a long period after laying a clunch of 10-12 eggs. (farmers control the broodiness of native hens by soaking them in cold water, removing the laid eggs from their nests, or even placing some slat or powdered pepper on their cloaca and also by providing better feeds).

Some strategies in upgrading the native chicken

The government and agricultural universities as well as some private individuals have embarked on some strategies to improve the native chicken. In a majority of the villages where these programs have reached, the graded chicken have thrived and performed well by crossing the local chicken with purebreds and general purpose breeds like Rhode Island, Plymouth Rock, New Hampshire Australorp and Cantonese using the following strategies:

- 1. Introduction of purebred hatching eggs. Once the native bird starts to be broody after laying a clutch of 10-12 eggs, all its eggs are replaced with purebred hatching eggs. The purebred chicks will then be raised by the native hen.**
- 2. introduction of purebred chicks. Day-old purebred chicks are placed in the evenings with the broody native hen, which is also rearing day-old native chicks. Rubbing all the chicks (native and purebred alike) with some coconut oil prevents the mother hen from recognizing her "real" chicks from the others.**
- 3. Cockerel exchange program. The Bureau of Animal Industry (BAI) introduced this method as a means to upgrade local chicken by**

exchanging a local cockerel with a purebred one. Thus, all native cockerels in the flock are eliminated.

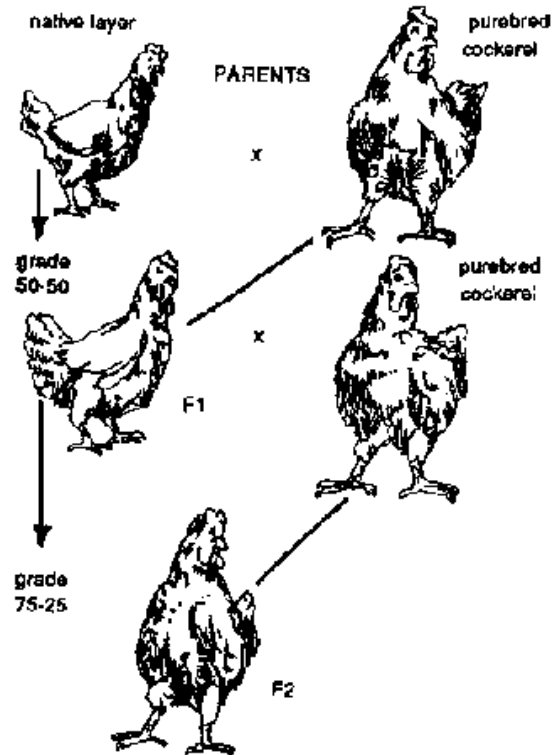

Cockerel exchange program

4. Local farmers buying male purebred broiler from small broiler raisers. These are then raised to become the breeders of the native chicken. Somehow, the farmers must eliminate also the native cockerels from his flock.

Coupled with these methods of upgrading, the farmer should also put up a poultry house of local materials as these purebred would not be able to roost on higher branches of trees. They also need protection during inclement weather.







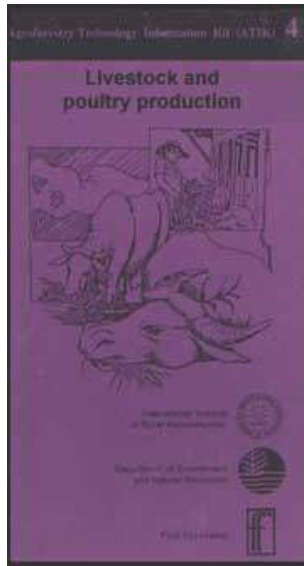







The offsprings of these are called mestizos or grades, whose size and egg production almost equal those of the purebred parents. Further mating of the graded females to purebred males produce birds that could be mistaken for purebreds.





White leghorn males are mated with native hens to produce grades for better egg production. The offsprings may give more eggs at the start, but they are not so hardy enough to sustain this under farm conditions. The same case goes for the White Leghorn males' performance. Given this limitation, providing proper feed, proper care and management can do a lot to augment the situation.





Livestock and Poultry Production (IIRR, 1992, 106 p.)

-  **(introduction...)**
-  **Message**
-  **Workshop to revise the agroforestry technology information kit (ATIK)**
-  **List of participants**
-  **Current program thrusts in upland development**
-  **Simple agro-livestock technology (SALT-2)**
-  **Intensive feed garden**
-  **Characteristics of forage grasses for IFG**
-  **Plant-based livestock medication**
-  **Small-scale cattle production**
-  **Forced-feeding technology (including Batangas cattle-fattening system)**
-  **Native pig production**
-  **Pig-feed garden**
-  **Low-cost goat housing**
-  **Improving the native chicken**

- ➔  **Family Backyard Poultry project**
How to raise ducks
-  **Native bee production**
-  **On-farm fodder sources in agroforestry (trees and grasses)**
-  **Off-farm fodder sources in agroforestry (trees and grasses)**

Family Backyard Poultry project

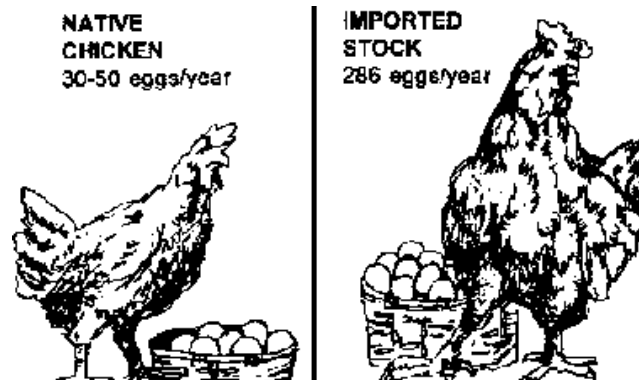

Family Backyard Poultry project

In the barangays, nearly every household keep some native chickens. Usually being left alone to fend for themselves, a hen produces 30-50

eggs per year as compared to imported stocks which can lay some 286 eggs per year. UPLB (1985) found that native birds, when given the same improved feed and management, could reach (at the first 180 days of lay) 48 percent of the egg production (or 137 eggs per year) of the commercial leghorn hybrids.

The care of a small backyard flock can help fill the family food requirements for eggs and meat. It can also be a source of additional income. A valuable by-product is the chicken manure which is a very excellent organic fertilizer for farm and home gardens.

Project scheme

- 1. Each participating family will start with two properly selected upgraded roosters and ten layers (inabin; five for egg production and five layers to produce chicks for meat production).**
- 2. A poultry house should be constructed using local materials for minimum expense. The house should have perch racks, roosts, nests, feedhoppers and waterers. The house should at least be 7 feet high, with a floor area of 10 fl x 12 fl. It can also be provided with a fenced area as run and a growing house for the chicks.**
- 3. The family could buy or raise the feed supplements like co., sorghum,**

ipil-ipil and others.

4. Recommended management practices on feeding and watering, brooding and rearing young chicks, culling and selection, record keeping, etc., should be followed.

5. Regular immunization (1-2 times a year against poultry diseases like avian pest, CRD, fowl pox, etc.)

Feasibility study

1. Expenses

10 layers x P 40/layer P	400.00
2 roosters x P 50/rooster	100.00
Housing and fence	1,000.00
Vaccines/veterinary drugs	25.00
Feed supplement	500.00 P 2,025.00

2. Egg Production Cycle

20 eggs/layer/month x 12 months = 240 eggs

240 eggs x 5 layers = 1,200 eggs/year

1,200 eggs/year x P 1.50/egg P 1,800.00

3. Meat Production Cycle

A. Growing period

Laying - 20 days

Incubation - 21 days

Brooding - 60 days

One production cycle = 101 days or 3 cycles per year

B. Production/Multiplication cycle

Survival rate of chicks/hen/cycle = 10 chicks

10 chicks x 3 cycles/year = 30 chicks

30 chicks x 5 hens = 150 chicks

Gross income from 5 hens/year

150 birds x P 30/bird P 4,500.00

4. Cost Analysis

Gross income from egg production P1,800.00

Gross income from meat production 4,500.00

02/11/2011

meister10.htm

Total income for 3 cycles (1 year) P6,500.00

Less: Expenses 2,025.00

Net income P4,275.00

Note: The roosters remain. To prevent broodiness of native chickens after laying, it is advisable to dip the birds in water.

Home-made chicken feeds

4 cans yellow co»» or broken rice (binlid)

1 1/2 cans rice bran (darak)

1 can dry fish meal or 2 parts fresh fish or ground snails

1 112 can copra oil meal

1/2 can copra oil meal

1/2 can ground mungo, sitao, patani or soy bean seeds

1/2 can dry ipil-ipil leaf meal

1 tablespoon salt 1 handful powdered shell/agricultural lime (apog)

Notes:

Use boiled gabi, ubi, cassava or camote as substitute for co»» meal.

Double the recommended amounts if ingredients are not in dry form.

Use dried azolla or dried filter cake to replace part of the rice bran.

A. Other Low-cost Poultry Feeds

- **bananas**
- **fly maggots**
- **fingerlings**
- **azolla**
- **snails**
- **filter cake (dried and good)**
- **termites**
- **earthworms**

Filter cake is the dark brown-black sediment after clarification and filtration during the manufacture of sugar.

B. Anti-nutrients in Some Feeds.

Kind	Anti- nutrient	Remedial measures
Sorghum	Tannin	Milling, use only the recommended amount
Leaume	Protease inhibitors	Boiling and toasting

	lectin	
Seed/beans Cassava	Cyanogen	Boiling, roasting, soaking
Ipi-ipil	Mimosine	Use recommended amount

C. Recommended Schedule of Vaccination (BAI).

Kind	Age of bird
Avian Pest Vaccine (Intranasal method)	1 day to 1-week old
Pigeon Pox Vaccine	One-month old
Roup Vaccine	Two-months old
Avian Pest Vaccine (Prick method)	Three-months old
Fowl Pox Vaccine	Four-months old
Fowl Cholera	Five-months old
Avian Pest Vaccine	Repeat after one year of laying

Muscovy ducks (bibe), pigeons and geese are hardy and could be raised in the backyard under adverse conditions. They do not require elaborate housing and can subsist on inexpensive feeds.

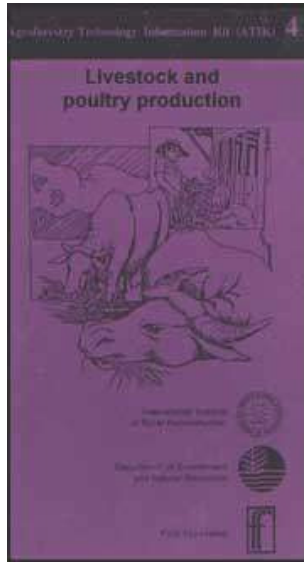

Livestock and Poultry Production (IIRR, 1992, 106 p.)

 ***(introduction...)***

 **Message**

 **Workshop to revise the agroforestry technology information kit (ATIK)**

 **List of participants**

 **Current program thrusts in upland development**

 **Simple agro-livestock technology (SALT-2)**

 **Intensive feed garden**

 **Characteristics of forage grasses for IFG**

 **Plant-based livestock medication**

 **Small-scale cattle production**

 **Forced-feeding technology (including Batangas cattle-fattening system)**

 **Native pig production**

 **Pig-feed garden**

 **Low-cost goat housing**



**Improving the native chicken
Family Backyard Poultry project**



How to raise ducks



Native bee production



**On-farm fodder sources in agroforestry (trees
and grasses)**



**Off-farm fodder sources in agroforestry (trees
and grasses)**

How to raise ducks



how to raise ducks

- 1. Buy your breeding stock from reliable duck raisers. The Pateros duck (native duck) is good for egg production and the Peking duck is good both for meat and egg purposes. You can also raise Muscovy duck or Pato. Muscovy has low egg production but is more selfsustaining than the Pateros and Peking ducks.**
- 2. Build your duck house in a quite, cool place and near as possible to a stream or pond. Local materials like bamboo, nipa and cogon are cool**

and cheap.

3. Provide each duck with at least 34 square feet of floor space. The floor should be covered with either rice hulls, corn cobs, peanut hulls or similar materials to make it dry and clean; and to help prevent the spread of pests and diseases.

4. You can provide a swimming pond for the ducks if you wish. One of 10 feet wide and 20 feet long is adequate for 50 birds. However, a pond is not really necessary in duck raising. The ducks can lay just as many eggs without it.

5. Pateros ducks start laying when they are about 4-6 months old. Peking and Muscovy ducks start laying at about 6-7 months old. In breeding, you need male for every five female ducks. Select breeders that are healthy, vigorous and without defects.

6. Ducklings need to be brooded or warmed until they are a month old.

a. The temperature required for brooding is 95°F for the first week, 90°F for the second week, 85°F for the third week and 80°F for the last week.

b. The behavior of the ducklings is a good indicator whether

brooding temperature is correct. The ducklings huddle close together toward the source of heat when temperature is low; scattered or spread evenly when the temperature is correct; but planting and moving away from the source of heat when the temperature is too hot.

c. A good brooding area is at least 1/2 square foot per duckling during the first week. The area should be increased by about 1/2 square foot every week until the fourth week.

d. When your ducklings show signs of sickness, add three tablespoons of Nexal for every gallon of water for 2-3 days. Skip or withdraw after 3 days. Then continue for another 3 days. Terramycin poultry formula can also be used Follow the instructions on the package carefully.

e. In order to prevent Avian Pest Disease, immunize your ducks with Avian Pest Vaccine which can be obtained free from the Bureau of animal Industry (BAI).

f. Sex your ducklings. If you desire to fatten the extra males, then grow them separately from the females.

g. When ducklings are six weeks old, they can be transferred

from the brooder to the growing house.

h. Transfer the layers to the laying house when they are four months old.

7. Feed your ducks the right kind of feed.

a. 1-day to 6-week-old ducklings should be fed with starter mash with 10-21 percent crude protein.

b. 6-week-old to 4 month old ducklings should be fed with growing mash with at least 16 percent crude protein.

c. 4-month-old ducks and above should be fed with laying ration with at least 16 percent crude protein.

d. Commercial feeds are good for your ducks. However, if you want to mix your own feed, here is a formula for a practical general purpose ration:

Ingredients

First class rice bran (darak) 55 kilograms

Ground corn or binlid 20 kiloarams

Shrimps or snails	25 kilograms
Wood ash or ground charcoal	1.5 kilograms
Ordinary table salt	250 grams
Ground limestone or shells	250 grams
Afsillin or Aurofac	250 grams

This general purpose ration may be fed to your ducks of any age.

e. Also, feed plenty of chopped green leaves of either kangkong, comfrey, camote, ipil-ipil and legumes as additional feed. Give at least 10 grams of chopped green leaves per duck per day.

f. You can grow and feed fresh water snails to your ducks. Giving one gallon of fresh snails a day to 24 duck layers will help increase egg production.

g. Provide your ducks plenty of clean fresh water all the time.

8. If you provide a swimming pond for your ducks, limit their playing in the water to 1-2 hours a day. Too much playing in the water will tire your ducks and make them eat more feeds.

9. Do not allow your ducks to get wet under the rain because they may

get sick.

10. Pateros ducks should weigh about 21/2 kilograms at 6 months. They should lay about 250-280 eggs in one year. On the other hand, Peking should weigh about 3 1/24 kilograms at 6 months old and lay about 180-200 eggs in, a year.

11. You may start growing your replacement ducks when your layers are in their second year of laying. Dispose of your pool layers and retain the good ones.

12. Duck eggs and meat are as nutritious as chickens'. Eat plenty of duck eggs and meat, they are good for you and your family.

Sources: Harold Watson and Warlito Laquihon. Mindanao Baptist Mission.



 **Livestock and Poultry Production (IIRR, 1992, 106 p.)**

 **(introduction...)**

 **Message**

 **Workshop to revise the agroforestry**

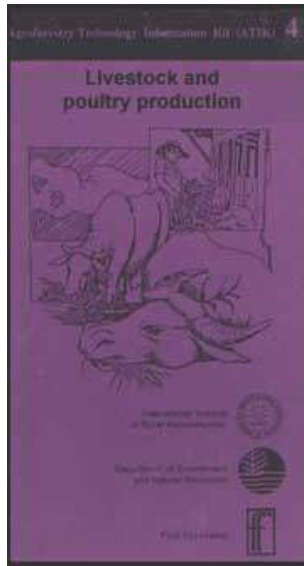

technology information kit (ATIK)



List of participants



Current program thrusts in upland development



Simple agro-livestock technology (SALT-2)



Intensive feed garden



Characteristics of forage grasses for IFG



Plant-based livestock medication



Small-scale cattle production



Forced-feeding technology (including Batangas cattle-fattening system)



Native pig production



Pig-feed garden



Low-cost goat housing



Improving the native chicken



Family Backyard Poultry project



How to raise ducks



Native bee production



On-farm fodder sources in agroforestry (trees



Off-farm feeder sources in agroforestry (trees and grasses)

Native bee production

Introduction

The native honey bee or the Asian honey bee (*Apis cerana*) are good pollinators of crops. They also produce honey, pollen and wax, all of which could be either directly used by farmers or sold in the market.

Compared with the exotic European honey bee (*Apis mellifera*), our native honey bees are more resistant to pest and diseases. Also, colonies of native bees are available everywhere and so it is easy to start with one or two colonies of this kind of bees. Being tropical, our native bees are smaller and could produce 2 to 6 kg of honey per year while the European bees could yield 50 kg of honey per year. Native honey bees also have greater tendency to abscond or leave suddenly, deserting their hive.

Since 1948, there have been attempts to rear the European honey bees due to several reasons; i.e. gentleness, high honey yield, lesser tendency to abscond, etc. But two major problems have limited the

culture of this species. These are: (1) lack of queens and (2) susceptibility to mites. Because of the limited number of mellifers colonies in the Philippines, a threeframe nucleus of this species may cost P 1,200!

Because of biological and economic considerations, native honey bees are more suitable to rear by small farmers. Less capital is needed in raising these honeybees. If farmers have enough resources and skills, they may try rearing the European honey bees.

Suitable areas for rearing native honey bees

Colonies of native bees could easily be established in areas where there are plenty of flowering plants throughout the year. Bees in these areas will practically yield more honey.

Having diversified farms, Cavite and Batangas provide good foraging grounds for bee colonies. In Quezon where coconut palms flower throughout the year, bee colonies under coconut plantations would just be alright. Mindanao is another good area to raise honey bees.

One practical method of assessing the suitability of an area for beekeeping is counting the number of wild bee colonies. If the density of bee colonies is high, it means that the area is suitable for bee

culture.

Materials needed in transferring wild colonies of bees

1. Wooden hive
2. Frames with wires
3. Nylon plastic
4. Knife
5. Bee veil
6. Bee brush
7. Smoker
8. Ax
9. Bolo
10. Plastic sprayer
11. Queen cage
12. Bee escape

How to transfer honey bees

Transferring wild colonies of bees to a wooden hive

Be sure that all materials are available.

Bolo or ax may be needed in exposing the colony of native honey bees. Determine the number of combs in the hive. Spray worker bees with small amount of water to prevent bees from flying. A little amount of smoke is needed to drive worker bees away from the first comb. By means of a sharp stainless knife, cut the base of the first comb. Oftentimes, this comb does not contain brood (immature bees) or

honey. Using water and smoke, do the same to the other combs.

Fix the comb with capped brood (pupal stage) on the center of the wired frame. To do this, cut evenly the base of the comb. Place the comb below the wired frame and cut through the middle section of the comb by using the wire as guide. Now, could push half of the comb through the wires. Tie the comb to the top bar by means of a plastic straw. Bees will begin to cluster outside the combs because of the disturbance. Occasionally, examine this cluster to see if the queen is with them. One or two combs with capped brood is enough for the new hive depending on the total population of the feral or wild colony. Be sure that the comb attached to the frame would be totally covered by bees after the operation.

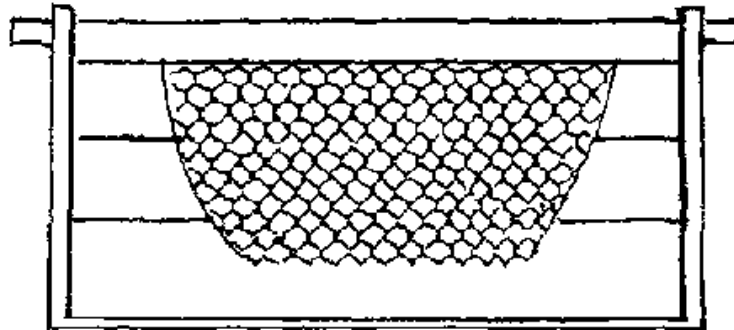

How to transfer honey bees

Now, look for the queen. Among the bees in the colony, she has the longest abdomen. If you find her, grasp her wings gently with you two fingers. Do not hold her on the abdomen. Put her on the cage together with five newly emerged worker bees. After covering the cage, tie it below the top bar adjacent to the comb. With the queen and two combs on the box, you are now ready to transfer all bees to the box. Give the queen a handful of bees. Some of these bees will guide the remaining bees to the new hive. Apply some smoke to the cluster of bees remaining in the old hive to facilitate the process of bee transfer. After all bees have transferred, bring the box to the desired location.

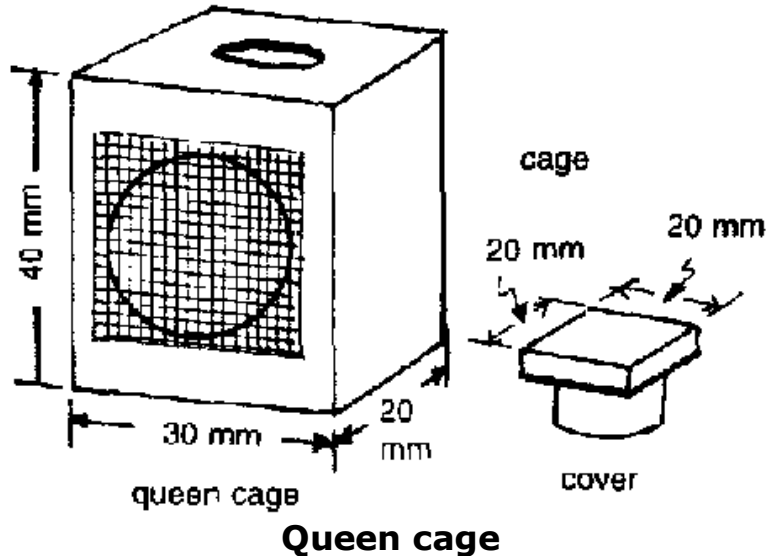

Transferring a swarm to the box

Bees on swarm are gentle because they have no honey and brood to protect. Wear a bee veil. One could not determine if bees are aggressive or not. Look for the queen and put her on a cage. Place the queen cage on the center of the box. Be sure that one or two frames have wax strip. You may release the queen after four days.

Swarm on leaves or small branches can be shaken into a box containing

frames with wax strips.

Transferring honey bees from concrete walls

Some bee colonies may be found in structures which could, not be moved or destroyed for some reasons. In this situation, bees could be forced to transfer to a box by means of a bee escape.

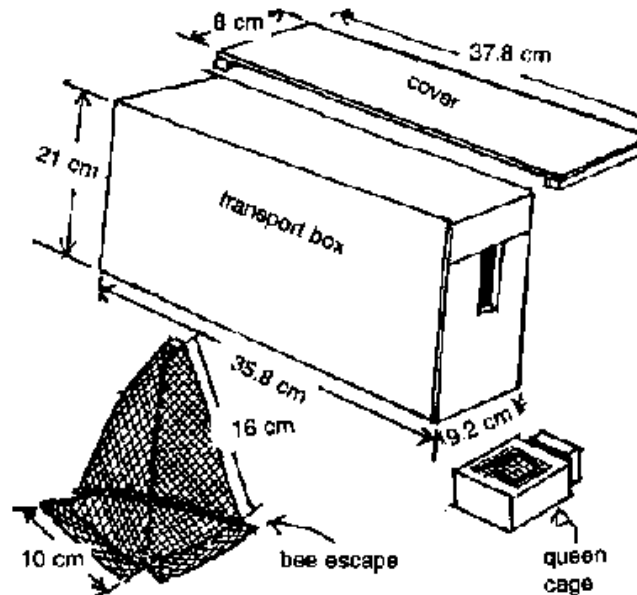

Transferring honey bees from concrete walls

Be sure that there is only one small hole in the feral colony. By means of a sealant, attach the bee escape to the wall to cover the entrance. Bees could get out but they could not get in. Place the box with frames near the entrance. One frame in the box should contain a piece of old comb to attract flying bees.

The queen may transfer to the new hive on or before the fifth day. She does not need to be confined in the cage.

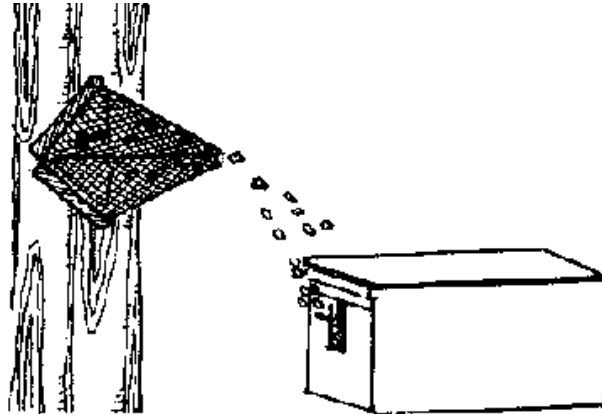

Transferring the bees in the transport box

Management of newly transferred colonies

Newly transferred colonies are always under stress because of disturbance. We could describe the colony condition as abnormal.

Place all boxes on wooden benches 18 inches or more from the ground. Shaded or partially shaded areas provide good location for bee colonies. Apply grease on the legs of benches to prevent ants from attacking or robbing bee colonies.

Immediately give sugar syrup (60:40 sugar-water ratio) to the colonies. This will enhance building of new combs.

Limit the entrance hole to prevent robbing or drifting of worker bees.

Release the queen after four days. By this time, new combs have already been built.

Examine all colonies for larvae of wax moth. This is the most common pest of brood. Newly attacked combs usually have small holes on their midrib. They may also contain tunnels of larvae. If any of these symptoms appear, remove all combs after putting the queen in a cage. Give the colony new frames with wax strips and continue feeding. Place the infested combs on a freezer to kill all eggs and larvae of the pest. After 72 hours, these combs could be given back to the bees.

Absconding (or desertion of the hive by bees) is usually caused by wax moth infestation of the brood. Absconding is a natural behavior of native honey bees. It is actually a defensive strategy of the bees. Be sure that swarm traps are always in their proper places. Once the colony becomes strong, they could guard the brood against wax moth.

At least three combs should have cells with sealed honey. The presence of sealed honey increases the morale of the colony.

Swarming

Swarming is normal among native honey bees. It is one way of increasing their colonies. Since you could not stop this annual activity of the bees, be sure that your swarm traps are hung on branches of nearby trees. Melted bees wax should be applied on these wooden traps to attract swarming bees.

Provide one or two combs of capped brood to the new hive. Shake the bees into the new hive. This could be done with a jerk to cause the bees to slide from the swarm trap.

Construction of bee hives

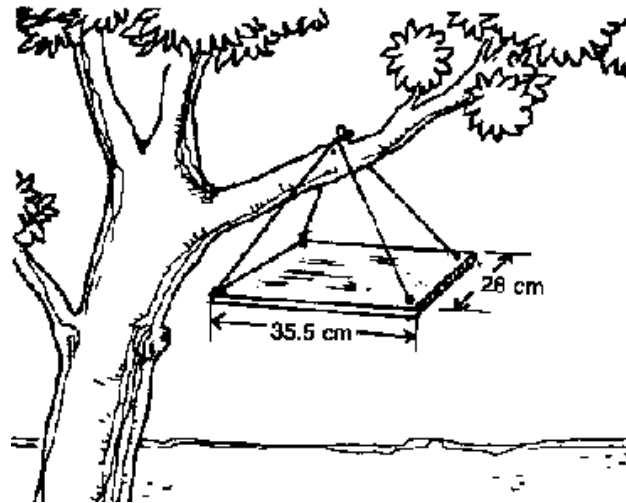

Construction of bee hives: the place

There are many kinds of bee hives. Traditional hives in the Philippines are usually made of hollow trunks of trees or palms. Ends of these hollow materials are usually plugged with stones or wood. The movable-frame hives are recommended for easier manipulation of combs. Oftentimes, combs have to be inspected to determine the condition of the hive.

Thickness of the wood or bamboo may vary but the internal dimensions must be followed strictly. The most important dimension is the distance

between side bars or top bars since the bees always maintain a natural distance between combs. This is called bee space. Width of side bars should be 27 mm.

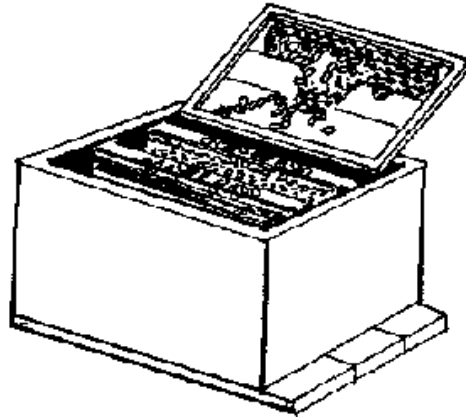

Construction of bee hives: the box

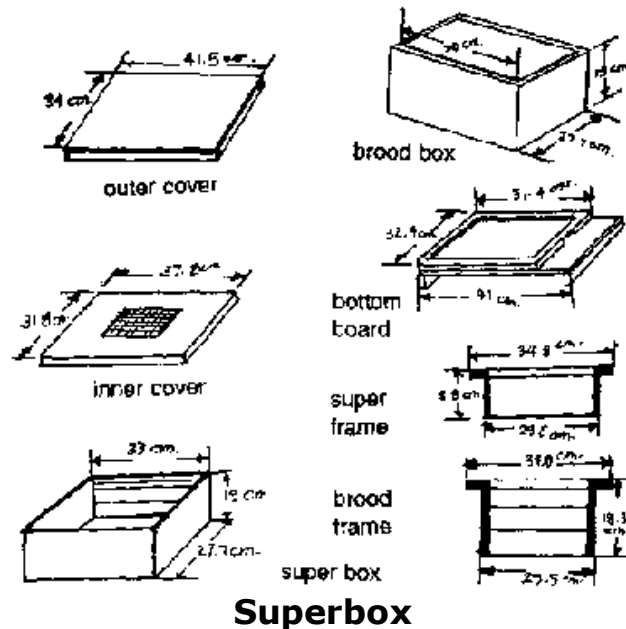

Top bars may be used instead of the standard frames. If the top their width should be 27.

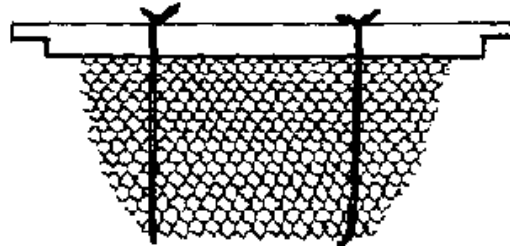

Top bars

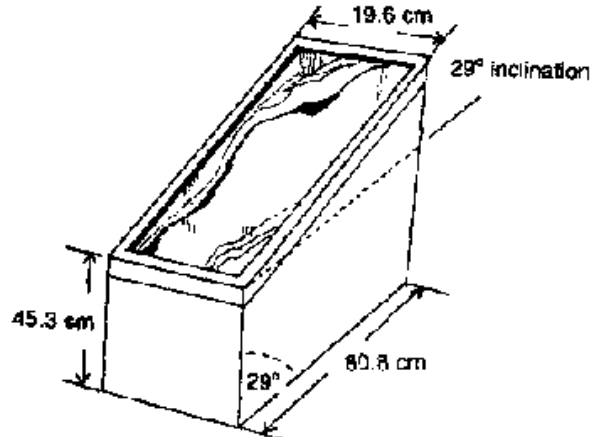

How to melt bees wax

How to melt bees wax

Wax should be extracted from old and new combs. A cheap solar wax

melter could be assembled for this

Wax strips instead of wax foundation

A locally assembled wax container is submerged in hot (but not boiling) water. Dip a marine plywood twice on the metal containing the melted wax. Be sure to moisten the plywood with soap solution before dipping. Peel off the wax after five seconds. Cut wax sheets into strips for future use.

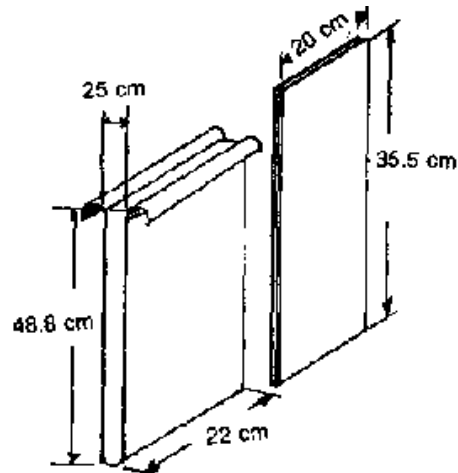

Wax strips instead of wax foundation

Embedding wax on the frame with coated wax on wire

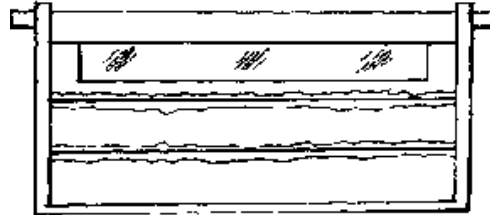

Embedding wax on the frame with coated wax on wire

Place the wax strip on the center of the top bar. Use melted wax to glue the wax strip on the bar. Embed wires with melted wax. Bees will position the midrib of their combs on wax-coated wires.

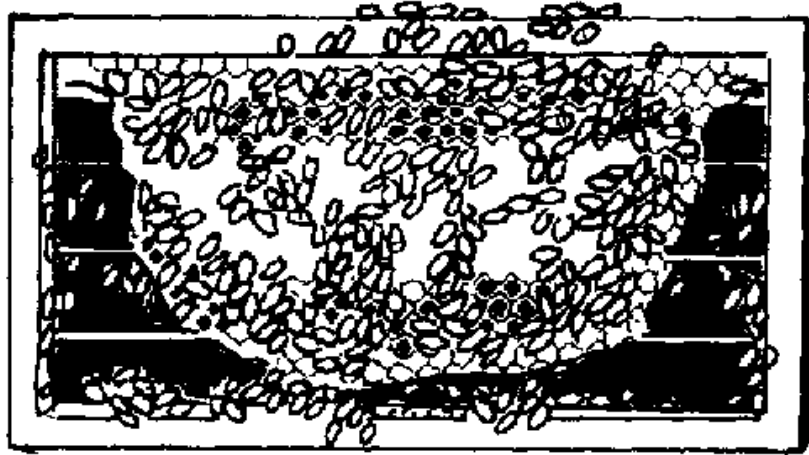

Figure

Do's and dont's when examining a hive

Always use a hand sprayer to calm the bees. Never use smoke as advised in temperate countries. Use of smoke is appropriate in dealing with European honey bees.

Do not stand in front of the hive. You may be blocking the pathway of bees.

Always wear bee veil. Bees tend to sting near the eyes. If you are

stung, apply weak acid after removing the sting from your skin.

Place uncapped brood near the center and capped brood towards the sides.

Cut old and brittle portions of the comb. Queens love to lay eggs on new combs.

Always examine for the presence of wax moth larvae, especially during the rainy season.

Remove combs not covered by bees. Store them in airtight containers containing moth balls.

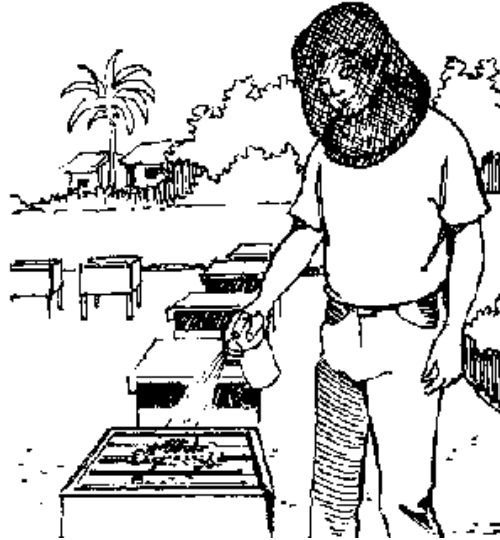

Do's and dont's when examining a hive

Splitting the colony

Strong colonies will divide naturally through swarming. You may divide a strong colony by placing the queen and four or five frames of bees in another box. Shake some bees into the second box. Transfer the second box to another location; the farther, the better. Older bees will return to the first box.

Without a queen, bees in the first box will build several queen cells. On the ninth day, destroy small queen cells and leave the biggest one. A young mated queen may start laying eggs at three to four weeks after splitting the colony.

How to harvest honey

Use of honey extractor

This is an expensive device for beginners. But if your group could not put up one extractor, harvesting of honey would be more efficient. Honey extracted through this method is clean. Also, combs could be returned to the hives after processing.

Squeezing of honey combs

By means of a hot knife, cut honey combs into small pieces. Combs with brood are tied to the top bar and returned to the hive. Combs with honey are squeezed by means of a clean muslin cloth. A metal press could also be of help.

Cutting of honey combs

Combs of honey could be cut nicely and wrapped in clean plastic bags.

Comb honey could also be stored in dean bottles.

Presentation of your product

Be sure to invest on good labels and clean bottles You may also send your honey samples to any of the following offices for analysis and finally for accreditation:

Bureau of Food and Drugs

Bee Program, U.P. at Los Baños

Department of Science and Technology

Advice to beekeepers

- 1. Sell only pure and natural honey. Report to the Bureau of Food and Drugs anyone who sells and processes unripe and/or adulterated honey to protect our consumers. Pure and natural honey may not harm diabetic patients while adulterated honey (with high sucrose) may kill them. Remember, selling of adulterated honey is against the law.**
- 2. Advise farmers about the proper timing of insecticide application on mango trees. While in bloom, mango flowers should not be sprayed**

with insecticide to allow honey bees and other beneficial insects to pollinate flowers.

3. Examine hives weekly for wax moth larvae.

For more information on native honey bees, contact:

Prof. Ray Lucero UPLB College of Forestry College, Laguna

The Director Bee Program U.P. at Los Baños College, Laguna

**The President Los Baños Beekeepers Association c/o Mr. Rufino Garcia
477 Bgy. Anos, Los Baños, Laguna**



 **Livestock and Poultry Production (IIRR, 1992,
106 p.)**

 **(introduction...)**

 **Message**

 **Workshop to revise the agroforestry
technology information kit (ATIK)**

 **List of participants**

Current program thrusts in upland

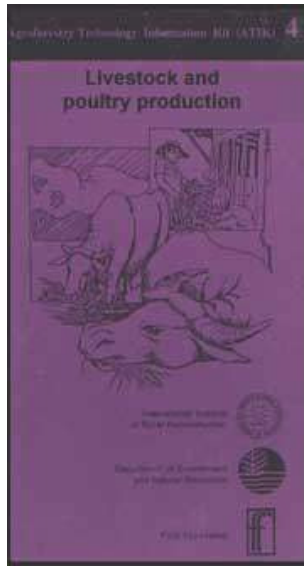

development

-  **Simple agro-livestock technology (SALT-2)**
-  **Intensive feed garden**
-  **Characteristics of forage grasses for IFG**
-  **Plant-based livestock medication**
-  **Small-scale cattle production**
-  **Forced-feeding technology (including Batangas cattle-fattening system)**
-  **Native pig production**
-  **Pig-feed garden**
-  **Low-cost goat housing**
-  **Improving the native chicken**
-  **Family Backyard Poultry project**
-  **How to raise ducks**
-  **Native bee production**
-  **On-farm fodder sources in agroforestry (trees and grasses)**
-  **Off-farm fodder sources in agroforestry (trees and grasses)**

On-farm fodder sources in agroforestry (trees and grasses)

Livestock production in most upland communities in the Philippines is concentrated in small, farms. Around 90 percent ruminants and 70 percent of non-ruminants are raised in small farms. Livestock provides draft power to different farm operations, transportation, food, additional income and manure for organic fertilizer.

Farm animals are mainly fed with the available fodder/forage within the farm. The fodder used by the farmers may be in the form of fresh or dried plant parts such as leaves and stalks/straws.

Natural grass/weeds

One of the common sources of fodder for livestock in the uplands for cut and carry, tethering and grazing feeding systems are either natural growing or cultivated grasses.

Table 13 Natural grass/weeds

Scientific name	Official common name
Rottboellia exaltate	Aguingay
Imperata cylindrica	Cogon
Saccharum spontaneum	Talahih

~~Saccharum spontaneum~~ Talang
 Chrysopogon aciculatus Amorseko

Paspalum conjugatum Kulape

Panicum stagninum Bungalon

Pennisetum purpureum Napier grass

Panicum maximum Guinea grass

Panicum purpurascens Para grass

Dicanthium aristatum Alabang

Fodder trees/shrubs

Fodder from trees and shrubs that are available in the farm provides nutritious and palatable feeds for livestock which can also supplement other forage grasses.

Table 14. Fodder trees/shrubs.

Scientific name	Official common name
-----------------	----------------------

Gliricidia sepium sepium	Madre de cacao kakawate
--------------------------	-------------------------

Leucaena leucocephala	Ipil-ipil
-----------------------	-----------

Calliandra calothyrsus	Calliandra
-----------------------------------	------------

Piemingia macropnyia	Piemingia
Desmodium rensonii	Rensoni
Piliostigma melabaricum	Alibangbang
Sesbania grandiflora	Katurai
Cajanus cajan	Kadyos

Other fodder sources

One of the most important feeds in small farms is the residue of various crops grown in the cropping systems. The most common residues are corn fodder/stover, rice straw, sugarcane tops and stem and leaves of leguminous crops.

Corn Fodder

It is grown mainly as forage for livestock. It may be harvested after the ears have appeared, although not yet fully developed. The whole plant is fed to animals Its palatability and nutritive value excel those of other soiling crops. The best condition for feeding is when the plant tassel and ears are in the glazing stage. Corn silage has a wide nutritive value. It should be supplemented with nitrogenous feeds to balance the ratio.

Corn Stover

It is a dried roughage that can be stored for livestock fodder. It is the portion of the corn plant left after the ears have been removed at harvest. The whole plant is air-dried in the field, then the stalks are cut and stored as feed. Corn stover is rich in carbohydrates and is very useful in maintaining the condition of work animals during the dry season. Corn stover should be protected from rain; otherwise, it will be affected by mildew and will disintegrate, making it unfit for feed. To make it more palatable, sprinkle salt over it. Dry Corn stover must be stored in a roofed animal shed or barn.

Sugarcane Tops

Sugarcane tops can be used as fodder whether green or dried. It is relished by carabaos and Cattle. It contains a large amount of digestible carbohydrates in sugar form.

Rice Straw

Rice straw is eaten by carabao and Cattle if other feeds are not available particularly during the dry season. To make it palatable, a small amount of salt is sprinkled over the feedstock. Dried rice straw may be stored in a coneshaped stacked called mandala supported by a bamboo pole, firmly anchored to the ground in an open field without

the danger of deterioration. The upper layer serves to protect the lower layer from getting wet. The straw should be stored when fairly dry or else, if wet, it will generate heat that will spoil its wholesomeness as fodder. The straw stack should be located on an elevated portion of the farm near the animal shed.

Leguminous dual-purpose crop residue

The leguminous residues of dual purpose crops such as cowpea, soybean, mungbean, bush sitao and batao have protein content of about 12 percent or more. The stem and leaves are good supplements to improve the feeding value of other on-farm fodder, especially during the dry season when feeds are very limited. They can also be fed to the livestock as soon as they are harvested without waiting for them to dry. Leguminous crop residues are seasonal and storage is one of the major problems. However, production in dry season makes sundrying practical. farmers only need to be taught to store and/or protect them from rain.

Sources:

**Resource Book on Sustainable Agriculture for the Uplands.
International Institute of Rural Reconstruction. 1990.**

FSSR '86. Crop Residues and Fodder in Rice-based Farming Systems by U.R Carangal and A.D. Calub. Agricultural Economics Department. International Rice Research Institute. Los Baños, Laguna, Philippines.



Figure

 **Livestock and Poultry Production (IIRR, 1992, 106 p.)**

 ***(introduction...)***

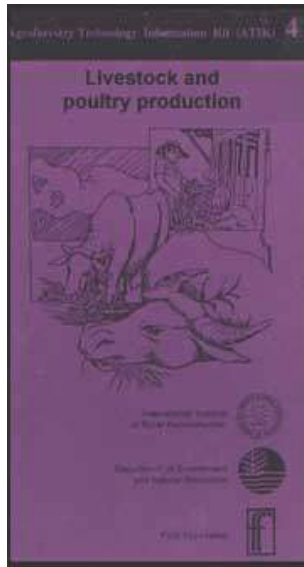

- ➔ **Message**
- 📄 **Workshop to revise the agroforestry technology information kit (ATIK)**
- 📄 **List of participants**
- ☐ **Current program thrusts in upland development**
- 📄 **Simple agro-livestock technology (SALT-2)**
- 📄 **Intensive feed garden**
- 📄 **Characteristics of forage grasses for IFG**
- 📄 **Plant-based livestock medication**
- 📄 **Small-scale cattle production**
- 📄 **Forced-feeding technology (including Batangas cattle-fattening system)**
- 📄 **Native pig production**
- 📄 **Pig-feed garden**
- 📄 **Low-cost goat housing**

- 📄 **Improving the native chicken**
- 📄 **Family Backyard Poultry project**
- 📄 **How to raise ducks**



Native bee production

On-farm fodder sources in agroforestry (trees and grasses)



Off-farm fodder sources in agroforestry (trees and grasses)

Message

Agroforestry, the land management system of incorporating crop production with tree and/or livestock production, evolved to become one of the most widely promoted tools for sustaining development in the uplands. To supplement the materials used by upland development extension workers in promoting agroforestry, a group of specialists, technicians and farmers from 11 government and nongovernment organizations met at the invitation of the International Institute of Rural Reconstruction in Silang, Cavite in November 1989 to develop the Agroforestry Technology Information Kit (ATIK). In November 1992, some of the specialists, together with some farmers and an additional number of specialists and technicians, met again at IIRR to revise the ATIK.

The updated kit is handy, easy-to-understand and full of illustrations. It widely uses indigenous technologies. With this kit, it is hoped that

extension workers and upland dwellers develop a better understanding and appreciation of agroforestry. The success of agroforestry as a tool for sustaining upland development, however, will depend on how this tool is introduced and implemented. Sustainable agroforestry systems can only be attained if upland dwellers are involved in the planning and establishment of such systems.

I commend all those involved in the production of this useful kit.

Angel C. Alcala Secretary Department of Environment and Natural Resources



 **Livestock and Poultry Production (IIRR, 1992, 106 p.)**

 **(introduction...)**

 **Message**

 **Workshop to revise the agroforestry technology information kit (ATIK)**

 **List of participants**

Current program thrusts in upland development

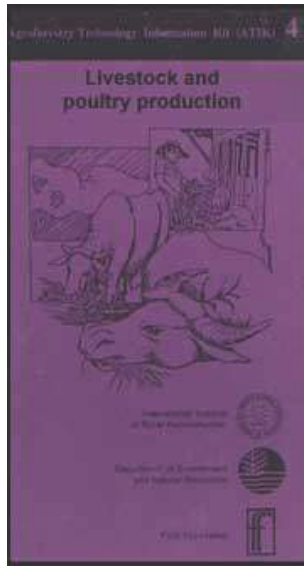

-  **Simple agro-livestock technology (SALT-2)**
-  **Intensive feed garden**
-  **Characteristics of forage grasses for IFG**
-  **Plant-based livestock medication**
-  **Small-scale cattle production**
-  **Forced-feeding technology (including Batangas cattle-fattening system)**
-  **Native pig production**
-  **Pig-feed garden**
-  **Low-cost goat housing**
-  **Improving the native chicken**
-  **Family Backyard Poultry project**
-  **How to raise ducks**
-  **Native bee production**
-  **On-farm fodder sources in agroforestry (trees and grasses)**
-  **Off-farm fodder sources in agroforestry (trees and grasses)**

Off-farm fodder sources in agroforestry (trees and grasses)



Off-farm fodder sources in agroforestry

As a point of reference, this paper will consider a cultivated or improved pasture of such grasses as *Pennisetum purpureum*, *Panicum maximum* and the like as the on-farm source of forage. In the main, this is the type of pasture the colleges of agriculture and the Department of Agriculture's animal breeding centers have or strive to have. These pastures provide a sustained supply of herbage to a large number of productive animals. This is the technology brought home from advanced countries where most of the Philippines' animal scientists and pasture agronomists were trained.

About 80 percent of Cattle and goats (99 percent for carabaos) are raised by small-holder farmers. In general, these farmers do not establish pasture. They raised cattle or goats because forage is available - from unused subdivision lots, wasteland, roadside, embankments, paddy bunds, etc., in the form of native grasses and trees, sometimes.

Fodder trees

The use of trees and shrubs as feeds is probably as old as the domestication of animals. Through experience, the backyard farmers have determined the tree fodder, useful for their livestock. A tree species maybe used as herbage in some places but not in others. For example, mamalis (*Pitiosporum pentandrum*) leaves are used by farmers as animal feeds in Cebu and Bohol but not in Bicol. Bometimes, the farmer may not be aware of fodder trees but the animal would pick at them along the way as it is led to wallow or work field; or as it chanced upon the trees or shrubs as in the case of grazing animal. In many places in the Philippines, it is the practice of farmers to give grasses only as green chops to their animals except when ipi-ipil is available. The use of *Leucaena* in forage feeding (kumpay) is now widespread so that this species will not be considered as an off-famm tree fodder in this paper.

Research on forage production from trees and shrubs is very meager compared with the massive research efforts on pasture grasses. The subject matter falls between traditional purviews of animal scientists and foresters and thus accorded limited attention by either. When large pastures are established, usually trees and shrubs are first cleared away. But the use of these plants as fodder source is very appropriate for the livestock production system in the Philippines and they deserve extensive testing of their productivity and utilization. Some trees and bushes such as *Desmanthus* species are reportedly free of toxic materials unlike *Leucaena* *Desmodium* species are accordingly so palatable and nutritious that they are termed "alfalfas of the tropics"; *Avicennia* leaves, especially *A. marina*, have been reported as more nutritious than the queen of forages - alfalfa.

Table 14 enumerates some trees and shrubs that have been reported to be used as forage. Only very few of them, however, have been studied for productivity, chemical composition and utilization. Table 15 shows some nutrient components of a number of fodder trees.

Although most of the trees are legumes, there are species from other families that are promising such as *Moringa* and *Morus* of *Moraceae* family. It can be seen in Table 15 that fodder trees can supply the protein need of numinants. Napier grass in dry season has only about 7

percent crude protein at 60 days old (Castillo and Gerpacio, 1976). Most of these trees are luxuriant even at the height of summer when grasses are dying and can, thus, provide the feed at this crucial period.

Table 14. Selected forage trees and shrubs.

Scientific name	Common name	Family
Mangifera indica	Mangga	Anacardiaceae
Avicennia sp.	Api-api	Avicenniaceae
Cordia dichotoma (Boraginaceae)	Anonang	Ehretiaceae
Albizia lebbek	Langil	Leguminosae (Mimosoideae)
Albizia lebbekoides	Malaghani	-do-
Albizia saman	Acacia, raintree	-do-
Calliandra calothyrsus	Calliandra	-do-
Desmanthus vergatus	Desmanthus	-do-
Pithecellobium dulce	Kamachile	-do-
Prosopis sp.	Prosopis	-do-
Caianus caian	Kadios	Leguminosae (Papilionoideae)

Derris indica		-do-
Desmodium gyroides	Karikut-rikut	-do-
Erythrina orientalis	Dapdap	-do-
Flemingia macrophylla	Malabalatong	-do-
Gliricidia sepium	Madre de cacao	-do-
Sesbania grandiflora	Katuray	-do-
Sesbania sesban	Sesban	-do-
Bauhinia monandra	Alibangbang	Leguminosae (Caesalpinioideae)
Baubinia variegata	Alibangbang	-do-
Cassia siamea	Thai shower	-do-
Cassia spectabilis	Antsoan-dilao	-do-
Cassia sturtii		-do-
Piliostigma malabaricum	Alibangbang	-do-
Tamarindus indica	Sampaloc	-do-
Hibiscus tiliaceus	Balibago	Malvaceae
Hibiscus rosa -	Gumamela	-do-
sinensis		
Azadirachta	Neem	Miliaceae

indica		
Melia azedarach	Paraiso	-do-
Antocarpus	Nangka	Moraceae
heterophyllus		
Morus alba	Mulberry	-do-
Ficus sp.	Fig, balete	-do-
Moringa oleifera	Malunggay	-do-
Cocos nucifera	Coconut	Palmae
Pittosporum pentandrum	Mamalis	Pittosporaceae
Sonneratia alba	Pagatpat	Sonneratiaceae
Theobroma cacao	Cacao	Sterculiaceae
Guazuma ulmifolia	Guazuma	-do-
Kleinhovia hospita	Tan-ag	-do-
Trama orientalis	Anabiong	Ulmaceae

Table 16. Chemical composition of some fodder trees percent

Species	Crude protein	Crude fiber	Ca	P
Albizia samar	20.69	20.33	1.20	0.14

Albizia falcata	17.42	13.33	1.43	0.23
Cajanus cejan	22.49	21.71	1.26	0.37
Ceiba pentandra	7.69	15.67	3.80	0.24
Delonix regia	15.21	8.10	2.65	0.24
Gliricidia sepium	17.11	10.96	-	-
Morus sp.	18.20	13.54	-	-
Sesbania sesbania	25.29	9.29	1.80	0.43
Tamarindus indica	13.32	21.97	2.54	0.23
Leucaena leucocephala	24.59	11.16	1.98	0.27

Source: Castillo L.S. (1986)

Abiria saman	24.12	36.84	0.92	0.22
Bauhinia monandra	15.15	41.70	2.36	0.17
Erythrina orientalis	23.67	31.50	1.45	0.23
Gliricidia sepium	22.98	24.43	2.04	0.28
Moringa olefeira	22.89	28.83	2.01	0.28
Pithecellobium dulce	24.16	29.72	1.59	0.27
Tamarindus indica	18.38	28.36	1.20	0.21

Source: Calub B.M. (1990)

Albizia lebbek	18.94	29.54	2.71	0.18
Bauhinia variegata	15.81	27.04	1.76	0.22
Moras alba	16.64	14.38	3.62	0.23
Leucaena leucocephala	15.22	15.02	2.99	0.19

Source: Samuel, C. (1990)**Off-farm grasses**

The main source of forage of the subsistent livestock farmer is the uncultivated or offfarm grasses which abound in his surrounding. Some of these grasses are promising in palatability and yield but have not been given emphasis in research. For example, barit or sacate (*Leersia hexandra*) and bungalon (*Panicum stegnum*) were described by Loosli et. al (1954) as very palatable and imparting unusual stamina to horses, yet they are more known as cropland weeds.

Table 16 presents the chemical composition of some selected Philippine forage grasses.

Table 16. Chemical composition of some selected forage grasses

percent

Grasses	Dry matter	Crude protein	Ether extract	Crude fiber	ASH
Aguingay (<i>Rottboellia exaltata</i>)	15.0	1.1	-	5.2	2.5
Alabana-X (<i>Dicanthium aristatum</i>)	36.6	3.1	1.2	12.8	3.0
Bamboo (<i>Bambusa</i> sp.)	42.0	7.6	1.5	12.1	5.2
Barit (<i>Leersia hexandra</i>)	34.2	2.5	0.8	10.6	5.3
Batad-batadan (<i>Sorghum helepense</i>)	19.0	2.4	0.6	6.3	2.6
Bungalon (<i>Panicum stagninum</i>)	19.3	1.3	0.4	6.5	2.3
Cogon (<i>Imperata cylindrica</i>)	23.3	2.3	0.5	7.7	2.0
Damong San Vicores (<i>Pennisetum setosum</i>)	24.1	1.4	0.4	9.6	2.5
Kulape (<i>Paspalum conjugatum</i>)	20.5	2.5	0.9	6.2	2.5
Molasses grass (<i>Melinis minutiflora</i>)	17.4	1.2	0.2	7.2	1.7
Pulang-pwet (<i>Echinochloa colona</i>)	8.6	0.8	0.1	3.1	1.6

Talahib (<i>Saccharum spontaneum</i>)	24.1	1.9	0.5	9.6	2.5
Guinea grass (<i>Panicum maximum</i>)	20.4	1.4	0.5	7.7	2.9
Napier grass (<i>Pennisetu purpureum</i>)	27.5	1.6	2.2	6.8	3.5

References:

Bagayan, R.L. 1991. Mamalis: A Lesser-used Species. Canopy International. 16(5): 2-5.

Calub, B.M. 1990. Evaluation of Local MPTS for Fodder Production. In Research on Multipurpose Tree Species in Asia, Taylor and MacGicken (eds.), 259 p.

Castillo, L S. and A.L. Gerpacio. 1976. Nutrient Composition of Some Philippine Feedstuffs. UPLB Technical Bulletin 21, 114p.

Catibog, C.S. 1978. Wild Plants for Food and Feeds. FORI, DENR. College, Laguna, 170 p.

Dichoso, WL. and R.P. Arcilla. 1991. Ficus: Current and Potential Uses

as MTS. Canopy International. 16(6): 4-11.

Hensleigh, T.E. and B.K. Holaway. 1988. Agroforestry Species for the Philippines. AJA Printers (Philippines), 404 p.

Loosli, J.K., V. Villegas and L.A. Ynalves. 1954. The Digestibility of Barit (Leersia hexandra) and Bungalon (Echinochloa stagnina) by Horses and Sheep. Phil. Agri. 38: 73-75.

National Academy of Sciences. 1980. Firewood Crops. Washington, D.C. 237 p.

Nitis, I.M. 1989. Fodder trees and Livestock Production Under Harsh Environment. Asian Livestock 14(10): 116120.

RISE. 1991. Reforestation Species. Vol. 3: Nos. 4,5,6 and 11. ERDB, DENR, College, Laguna, Philippines.

Samuel, C. 1990. Role of Fodder Trees in Livestock Production Under Harsh Environment. Asian Livestock. 15(1): 1 -9.



Livestock and Poultry Production (IIRR, 1992, 106 p.)

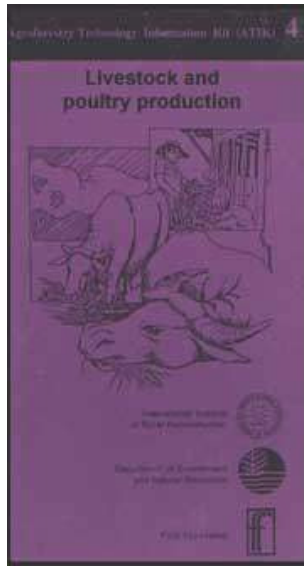

-  **(introduction...)**
-  **Message**
-  **Workshop to revise the agroforestry technology information kit (ATIK)**
-  **List of participants**
- Current program thrusts in upland development**
-  **Simple agro-livestock technology (SALT-2)**
-  **Intensive feed garden**
-  **Characteristics of forage grasses for IFG**
-  **Plant-based livestock medication**
-  **Small-scale cattle production**
-  **Forced-feeding technology (including Batangas cattle-fattening system)**
-  **Native pig production**
-  **Pig-feed garden**
-  **Low-cost goat housing**
-  **Improving the native chicken**
-  **Family Backyard Poultry project**
-  **How to raise ducks**



Native bee production



On-farm fodder sources in agroforestry (trees and grasses)



Off-farm fodder sources in agroforestry (trees and grasses)

Workshop to revise the agroforestry technology information kit (ATIK)

The first workshop to develop the Agroforestry Technology Information Kit- now more popularly known as ATIK - was conducted by the International Institute of Rural Reconstruction (IIRR) in its Silang Campus, Cavite, Philippines, on November 4-13, 1989. There were 39 participants to this workshop who came from 11 government and nongovernment organizations (GOs and NGOs).

ATIK was produced primarily for use by DENR technicians who have been implementing the Social Forestry Program nationwide. DENR conducted a nationwide survey among its staff who were involved in the implementation of its Integrated Social Forestry Program and also primary users of ATIK. A questionnaire was formulated, focused on the actual experiences of these technicians in using the ATIK and on specific revisions they proposed to make on the kit. A Planning Committee was created to study the technicians' proposed

modifications to the ATIK, as well as to plan for the workshop to revise it. The committee was composed of For. Domingo Bacalla of DENR, For. Moises Butic of DENR, Ms. Rowena Cabahug of UPLB College of Forestry, Dr. Romulo del Castillo of UPLB College of Forestry, Ms. Remedios Evangelista of DENR, Dr. Julian Gonsaives of IIRR, Mr. Scott Killough of IIRR and Mr. Jaime Ronquillo of IIRR.

The workshop to revise the ATIK took place also in IIRR's Campus in Silang, Cavite, on November 16-21, 1992, with 45 participants representing 13 agencies. These agencies included: the Department of Environment and Natural Resources; Farm and Resource Management Institute; Southern Mindanao Agricultural Programme; Mag-uugmad Foundation, Inc.; University of the Philippines at Los Baños; Upland Development Program/Sungay Upland Farmers' Golden Harvest Association; Soil and Water Conservation Foundation; Quirino Livelihood Concept and Development Resource Center, Inc.; Winrock International; Mindanao Baptist Rural Life Center; Visayas State College of Agriculture; International Rice Research Institute; and, IIRR.

In the workshop, the same process for materials production was followed. Old sheets and first drafts of new topics were presented by the authors in plenary sessions. These materials then underwent continuous improvements through the critiquing of the other workshop

participants. Communication experts (writers, editors, layout and design artists) were on hand to assist the authors in revising/preparing the texts, illustrations and designs of their papers. Before the materials were prepared in a camera-ready format, they were submitted to their authors for final review and revision to ensure that the additional corrections were incorporated.

The major revisions of ATIK are the following:

A. Format

- 1. From a set of loose-leaf single sheets in folder/binder to six, pocket-size (4" × 7") booklets, individually classified and bound according to major topics.**
- 2. Using simple, white, ordinary bookpaper, rather than the thicker, colored and more expensive bristol board.**
- 3. Using a thick binder to hold the six booklets, instead of an individual folder for each kit.**

B. Content

- 1. Some old topics which were found not relevant/useful**

from the survey were dropped from the kit.

2. Other topics were revised, focusing on the specific needs of the DENR technicians.

3. Additional, new topics were included, again to respond to the expressed needs of the technicians.

4. Many old topics - which were adapted by farmers - remained as they were.

The revised ATIK - with its new format and content - is expected to further facilitate the work of DENR's 1,200 technicians in its Integrated Social Forestry (ISF) Program nationwide. Ultimately, the kit will help enable DENR's ISF's program to give the Filipino uplanders access to forest lands for a tenure of 25 years or more.

**Workshop to revise the agroforestry technology information kit (ATIK)
November 16-21, 1992 IIRR, Silang, Cavite**



**Livestock and Poultry Production (IIRR, 1992,
106 p.)**



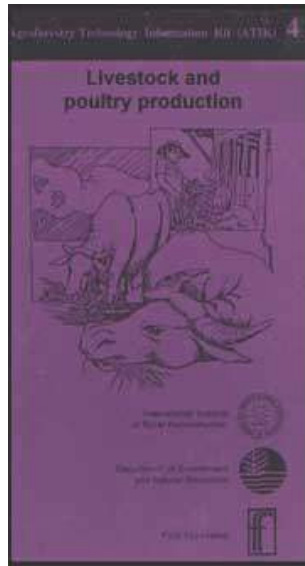

 **(*introduction...*)
Message**

 **Workshop to revise the agroforestry technology information kit (ATIK)**

 **→ List of participants**

 **Current program thrusts in upland development**

 **Simple agro-livestock technology (SALT-2)**

 **Intensive feed garden**

 **Characteristics of forage grasses for IFG**

 **Plant-based livestock medication**

 **Small-scale cattle production**

 **Forced-feeding technology (including Batangas cattle-fattening system)**

 **Native pig production**

 **Pig-feed garden**

 **Low-cost goat housing**

 **Improving the native chicken**

 **Family Backyard Poultry project**

 **How to raise ducks**





**Native bee production
On-farm fodder sources in agroforestry (trees
and grasses)**



**Off-farm fodder sources in agroforestry (trees
and grasses)**

List of participants

Authors/Resource Persons

- 1. Ms. Nita Abena Veterinarian, Appropriate Technology Unit
Intemational Institute of Rural Reconstruction (IIRR) Silang 4118,
Cavite**
- 2. Ms. Emma Aguilar, Community Development Officer DENR-CENRO,
Barotac Nuevo, Iloilo**
- 3. Mr. Pio B. Aposto, I CDA/Project Leader Patlabawon ISF Upland
Farmers Association, Inc. Patlabawon, Patnongon, Antique cio DENR
Region 6, Iloilo City**
- 4. Mr. Laurito Arizala, Crops Specialist IIRR, Silang 4118, Cavite**
- 5. Dr. Edwin Balbarino, Field Coordinator, Matalom Upland Dev't.**

**Project Farm and Resource Management Institute (FARMI) VISCA,
Baybay, Leyte**

**6. Mr. Carlos S. Basilio, Agricultural Administration Specialist IIRR,
Silang 4118, Cavite**

**7. Mr. Cristituto G. Bual, Assistant Section Chief, Extension Services
Division Southern Mindanao Agricultural Programme (SMAP) Bago
Oshiro, Davao City**

8. Mr. Agustín Calanao, Farmer, NISFFAI Nazuni Dingle, Iloilo

**9. Mr. Jose D. Cansancio, CDA II/Forest Community Organizer DENR-
Upland Development Program Region XI-4A, Digos, Davao del Sur**

**10. Mr. Lapu-lapu Cema, President, Mag-uugmad Foundation, Inc. (MFI)
39-2 Rodriguez Apartment, Pelaez St., Cebu City Tel. No. 220197**

**11. Dr. Roberto E. Coronel, Associate Professor, Institute of Plant
Breeding University of the Philippines at Los Baños College, Laguna**

**12. Mr. Ricardo El. S. Dayrit, Specialist, Livestock Production IIRR,
Silang 4118, Cavite**

13. Ms. Maxima Dandasan, Farmer UDP/Sungay Upland Farmers Golden Harvest Assn. Sungay, Alubijid, Misamis Oriental

14. Mr. Terrence E. Davis, Extension and Training Specialist Southern Mindanao Agricultural Program (SMAP) Department of Agriculture, Davao City Tel. No. 82-79767; Fax No. 82-62766

15. Dr. Reynaldo dela Cruz, Professor, Department of Forest Biological Sciences College of Forestry, UPLB, College, Laguna Tel. No 94-2725/94-2773; Fax No. 94-2721

16. Dr. Zosimo dela Rosa, Associate Professor, IARMI-VISCA Farmers' Village, VISCA, Baybay, Leyte Tel. No. 5212027

17. Ms. Ines Fehrman, Volunteer, Appropriate Technology Unit International Institute of Rural Reconstruction (IIRR) Silang 4118, Cavite

18. Dr. Pam Fernandez, Agronomy Department University of the Philippines at Los Baños College, Laguna

19. Mr. Rufino C. Garcia, Research Associate Department of Forest Biological Science UPLB, College, Laguna

20. Mr. Bill Granert, Managing Director Soil and Water Conservation Foundation P.O. Box 309, Ceba City Tel. No. 92312/95528; Fax No. 922312

21. For. Nick Iscala, Social Forestry Department Department of Environment and Natural Resources (DENR) Visayas Ave., Diliman, Quezon City

22. Ms. A \diamond da B. Lapis, Supervising Science Research Specialist Ecosystem Research and Development Bureau (ERDB), College, Laguna, Tel. No. 2269 loc. 267; Fax No. 6394-3628

23. Dr. Rodel Lasco, Assistant Professor UPLB Agroforestry Program College of Forestry UPLB, College, Laguna Tel. No. 2599/3657/2657 Fax No. (94) 32-06

24. Dr. Ulysses Lustria, Director of Extension and Assistant Professor University of the Philippines at Los Ba \diamond os College, Laguna Tel. No. 3358

25. Mr. Roger Magbanu, a International Rice Research Institute (IRRI) P.O. Box 933, Manila

26. Mr. Dominador A. Mart \diamond nez, Project Director Quirino Livelihood Concept and Development Resource Center, Inc. Aglipay, Quirino 3403

Tel. No. 076-692-5058

27. Ms. Ophelia Q. Naje, Community Development Officer 11 DENR-PENRO Suqui, Calapan, Oriental Mindoro

28. Mr. Armando M. Palijon, Assistant Professor UPLB College of Forestry College, Laguna Tel. No. 2599

29. Dr. Ben Parker, Institute of Animal Science University of the Philippines at Los Baños College, Laguna

30. Mr. Raquelito M. Pastores, Assistant Director/Agroforestry Specialist IIRR, Silang 4118, Cavite

31. Dr. Agustín Piñal, Supervising Science Research Specialist ERDB, College, Laguna Tel. No. 2229

32. Mr. Glorioso Quiñones, Farmer Liquicia, Caba, La Union

33. Ms. Rosalinda S. Reaviles, Science Research Specialist II ERDB, College, Laguna Tel. No. 2229/2269/2481

34. Mr. Gregorio D. Reyes, Chief, Science Research Specialist and Division Chief Upland Farms Ecosystem Research Division ERDB,

College, Laguna Tel. No. 348112269/2229 loc. 230

35. Mr. Nestor Roderno Appropriate Technology Unit IIRR, Silang 4118, Cavite

36. Mr. Romeo San Buenaventura Agroforestry Technician IIRR, Silang 4118, Cavite

37. Seed Science and Technology Division Staff Department of Agronomy University of the Philippines at Los Baños College, Laguna

38. Ms. Carol Stoney, Agroforester, Winrock Intemational c/o ARMP, P.O. Box 290, Bogor 16001, Indonesia, Tel. No. 62 (251) 323-325, Fax No. 62 (251) 328-4891325-251

39. Mr. Henrylito D. Tacio Staff Writer Mindanao Baptist Rural Life Center (MBRLC) Kinuskusan, Bansalan, Davao del Sur

40. Dr. Frederico Villamayor Professor PRCRTC, VISCA Baybay, Leyte Tel. No. 521-2027 (Pasay Office)

Steering Committee

41. For. Domingo Batalla Chief, Social Forestry Division DENR, Visayas

Ave., Diliman, Q.C.

42. For. Moises Butic Social Forestry Division DENR, Visajas Ave., Diliman, Q.C.

43. Ms. Rowena Cabahug Research Associate UPLB Agroforestry Program College of Forestry, UPLB, College, Laguna Te. No. 265713657

44. Dr. Romulo del Castillo Director, UPLB Agroforestry Program College of Forestry UPLB, College, Laguna

45. Ms. Remedios S. Evangelista Social Forestry Division DENR, Visayas Ave., Diliman, Q.C.

46. Dr. Julian Gonsalves Director Appropriate Technology Unit/Communication Department IIRR, Silang 4118, Cavite

47. Mr. Scott Killough Deputy Director Appropriate Technology Unit IIRR, Silang 4118, Cavite

48. Prof. Nestor Lawas Agronomy Department UPLB, College, Laguna

49. Mr. Jaime P. Ronquillo Assistant Director Communication Department IIRR, Silang 4118, Cavite

Artists

**50. Mr. Albert Bañez, UGSAD Editorial and Visual Arts Association, Inc.
Lincoln Bend, Parkwood Greens, Pasig, M.M.**

51. Mr. Boy Belardo, IIRR, Silang 4118, Cavite

52. Mr. Ric Cantada, IIRR, Silang 4118, Cavite

53. Mr. Henry Cruz

**54. Mr. Mitchell Doren, UGSAD Editorial and Visual Arts Association,
Inc.
Lincoln Bend, Parkwood Greens Maybunga, Pasig, Metro Manila**

**55. Mr. Bemabe Remoquillo, Institute of Development Communication
UPLB, College, Laguna**

Editors

56. Mrs. Lyn C. Doren, IIRR, Silang, Cavite

**57. Ms. Carmenia May Magno, IIRR, Silang, Cavite, Administrative
Support Staff**

58. Lhai Kasala

59. Jel Montoya 60. Gigi Naval 61. Angie Poblete 62. Ariel Madlangsakay
63. Secretarial, Support Services

Design and layout by Carmenia May Magno

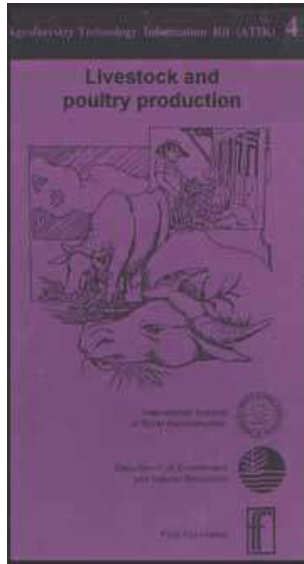

Livestock and Poultry Production (IIRR, 1992, 106 p.)

Current program thrusts in upland development

 *(introduction...)*

 **1. Integrated social forestry program (ISFP)**

 **2. National forestation program (NFP)**

 **3. Forest land management agreement (FLMA)**

 **4. Community forestry program (CFP)**

Livestock and Poultry Production (IIRR, 1992, 106 p.)

Current program thrusts in upland development

Human greed, abuse and misuse of the country's forest resources have resulted in the sad state of our uplands today. Resource depletion, environmental degradation, inequitable access to resources, tenurial issues, upland poverty and the continuous influx of lowland migrants into the uplands are among the current issues in natural resources management.

In recent decades, the Philippines witnessed an unprecedented commercial exploitation of the timber resources leading to an annual rate of deforestation reported to have reached an average of 119,000 hectares during the declining years of the timber boom between 1969 to 1987. From a leading exporter of precious "Philippine Mahogany", the Philippines has become a timber deficit country where the cost of a board foot of lumber is beyond the means of an average wage earner. The disappearance of forests has resulted in the loss of jobs and livelihood in neighboring communities; destructive floods and drought during wet and dry seasons, respectively; and, landslide and siltation of rivers and dams. Other consequences of deforestation have become common occurrences in many parts of the country.

Through the years, landlessness and unemployment have driven

hundreds of thousands of poor families in the lowlands to migrate and eke out a living in upland areas where they have become "squatters" by operation of law. In many cases, these have resulted in the total destruction of remaining forest vegetation in the area. The land has become marginally productive as the top soil continues to be lost through erosion brought about by improper agricultural practices. The result is poverty and a degraded upland environment affecting not only the people who subsist in these areas, but even the poor farmers in the lowlands who likewise suffer from the inevitable consequences of forest destruction. Latest estimates show that as much as 8.25 million hectares are now severely eroded.

In view of these problems, the government has in recent years formulated programs directed at arresting resource depletion and environmental degradation while searching for solutions to the issues of secured access to land, poverty alleviation and increased sustainable productivity. Among the major programs being implemented by the Department of Environment and Natural Resources are the Integrated Social Forestry Program (ISFP) in noncritical areas of the public domain that are under various forms of cultivation; the National Forestation Program (NFP) in degraded areas and in residual stands that are inadequately stocked; the Forest Land Management Agreement (FLMA) in newly reforested areas under the NFP that need to be

maintained and cared for; and, the Community Forestry Program (CFP) in residual forest lands occupied by farming families.

1. Integrated social forestry program (ISFP)

Initiated about a decade ago, the ISFP draws strength from the DENR Upland Development Program (UDP) started by the Bureau of Forest Development in 1980 which was aimed at distilling lessons and developing methodologies for participatory management of the uplands. The ISFP incorporates the best features of three people-oriented forestry programs implemented in the 1970's, i.e., Forest Occupancy Management, Communal Tree Farming and Family Approach to Reforestation. The major features include granting long-term tenurial arrangements to qualified applicants, technical and modest material assistance and institution building aimed at developing capability for community-based resource management.

ISFP addresses the twin problems of rural poverty and ecological stability in occupied forest lands. Through ISFP, forest land occupants are provided secure access to land as well as technical and material aid to make the land productive without depleting it. Secure land tenure comes through either the Certificate of Stewardship Contracts (CSCs) for individuals, or the Community Forest Stewardship Agreements

(CFSAs) for community organizations. In both cases, farm families are granted renewable 25-year leases on the public land which they occupy and cultivate. In the first years of the lease, the farmer receives technical assistance for developing selfsufficiency and sustainable farming practices.

The program provides assistance in the areas of agroforestry, land tenure and community organizing. Community organizing is applied to mobilize groups to obtain stewardship contracts, promote agroforestry and soil/water conservation and build local institutions. ISFP emphasizes improvement of existing farmer practices, not introduction of new ones except in situations where such may be necessary. Participatory strategies are used to gather data, diagnose field situations and monitor technical problems. Farm visits and training courses develop farmers' skills in agroforestry and organization. In the process, community leaders are prepared to take responsibilities for continued development after the end of the project, tentatively set at five years.

Recently, the implementation of the Local Government Code obligated the DENR to devolve to the Local Government Units (LGUs) the management of all ISF project sites except some of the "model sites" (one model site per province) and the UDP sites. These projects will

remain under the care of the DENR for use as learning sites where new technologies and approaches are expected to be generated. These sites will also be used as training areas for LGU technicians and other development workers as part of the outreach program of the DENR

2. National forestation program (NFP)

In 1988, the DENR implemented the NFP which consists of three major components, namely: reforestation, watershed rehabilitation and timber stand improvement. The reforestation component is concerned with the replanting of denuded forest lands with indigenous and exotic forest species, including fruit trees, bamboos and minor forest species. One of the reforestation strategies used is assisted natural regeneration (ANR) where augmentation planting of climax species is done to improve future yield at minimum cost. The timber stand improvement (TSI) involves the removal of over-mature and inferior trees to improve growth in logged-over areas. Reforestation, ANR and TSI are approaches used in rehabilitation of identified critical watersheds and catchment areas.

DENR enters into contract with upland settler families, community and civic/religious organizations, entrepreneurs, local and other government offices and other NGOs for any of the above NFP activities

in areas identified by DENR. The contract may be for survey, mapping, planning, community organizing/training, monitoring and evaluation or actual comprehensive site development of a given area.

3. Forest land management agreement (FLMA)

FLMA provides a long-term tenure to the people who plant and care for trees in newly reforested areas by granting farmers access to these areas for purposes consistent with sound ecological principles. When the reforestation contract terminates after three years, the contractor may apply for an FLMA if at least 80 percent of the trees planted are surviving and properly maintained. Family contractors must organize into associations or cooperatives covering a total of at least 100 hectares. DENR employs local NGOs to help organize communities and train them in forest management.

Like stewardship contracts under ISFP, FLMAs are for 25 years, renewable for another 25 years. The contractor may use the area to grow and harvest minor forest products or interplant cash crops, fruit trees and other agricultural crops using sound agroforestry practices. The contractor may also harvest, process and sell timber when the trees mature, following the principles of sustained yield forest management. In return, the contractor provides DENR 30 percent of the

total proceeds until the whole cost of reforesting the area has been recovered. The proceeds will be deposited into a "trust fund" for expanding reforestation activities.

4. Community forestry program (CFP)

The need to democratize access in the use of the forests and allow organized upland communities to benefit from the resource compelled the government to adopt policies that would enable communities to protect, manage and rehabilitate fragmented residual and old growth forests. CFP is emerging as a community-based approach in managing certain portions of abandoned, canceled and expired areas of Timber License Agreements (TLAs).

CFP makes upland dwellers stewards of residual forest areas. Communities are awarded 25year Community Forestry Management Agreement (CFMA). Again, these agreements are renewable for another 25 years it mutually agreeable to DENR and the community. The community organization can harvest, process and sell forest products from the area according to a management plan submitted to DENR beforehand. The plan must comply with prescribed rules and follow principles of sustained yield management.

Under the CFP, DENR assists the holder organization to set up and strengthen the community organization. This includes on-the job training in resource inventory, preparation of forest management and conservation plans and developing livelihood opportunities. For this assistance, DENR employs qualified NGOs.

Role of NGOs

Through the years, the NGOs have been doing a proactive role in upland development through advocacy, training and technical assistance. However, the latter part of the 1980s offered greater opportunities for their direct involvement in the implementation of government programs such as reforestation, social forestry and community forestry. In addition to their traditional roles, the NGOs are now involved in technical work such as survey and mapping; resource appraisal and planning; community organizing; reforestation; resource management; and, harvesting, processing and sale of forest products.

A Tool in upland development

Agroforestry is an important tool in the development of the uplands. If practiced properly, it helps promote soil and water conservation while increasing productivity and sustainability of upland farms to the benefit

of the people.

There are traditional astute agroforestry practices being employed mostly by indigenous people in the uplands. The great majority of the population, however, remains in need of improving their system of farming the uplands to increase income and protect the environment.

Meanwhile, the number of people being engaged in promoting appropriate agroforestry technologies has dramatically increased in recent years. They come from national government agencies, various nongovernment organizations and, more recently, technicians of local government units to whom the upland development functions have been devolved.

This Agroforestry Technology Information Kit (ATIK) has been developed for use by these types of development workers as a quick reference. It consists of simple, illustrated technologies being used in various parts of the country. It is a product of a week-long materials production workshop among agroforestry practitioners in the government and nongovernment organizations, farmer groups and the academe.

Table 1. Summary profile of DENR'S people-oriented upland

development programs.

PARTICULARS	ISFP	NFP	FLMA	CFP
Target areas	Occupied forest lands except national parks and critical watersheds	Denuded and understocked areas	NFP contracted areas	Fragmented residual and old growth forest areas
Target participants	Upland farmers and communities	pos, NGOs, LGUs and families	Community contractors with at least 80% survival after 3 years	Upland resident POs
Stewardship contract	25 years	3 years	25 year;	25 years
Funding source	DENR and CARP	ADB	ADB	ADB and USAID-NRMP
DENR office concerned	National ISF Secretariat/Social Forestry Division	NPCO	NPCO	CFP Secretariat

Project implementor	DENR,NGOs and LGUs	Contractors	FLMA awardees	Communities
Implementing strategies	CO-driven agroforestry intervention	Reforestation contract	Management contract	Management contract/agreement

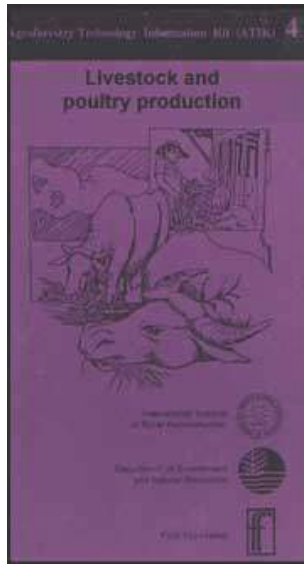

Livestock and Poultry Production (IIRR, 1992, 106 p.)

 **(introduction...)**

 **Message**

 **Workshop to revise the agroforestry technology information kit (ATIK)**

 **List of participants**













Current program thrusts in upland development

  **Simple agro-livestock technology (SALT-2)**

 **Intensive feed garden**

 **Characteristics of forage grasses for IFG**



-  **Plant-based livestock medication**
-  **Small-scale cattle production**
-  **Forced-feeding technology (including Batangas cattle-fattening system)**
-  **Native pig production**
-  **Pig-feed garden**
-  **Low-cost goat housing**
-  **Improving the native chicken**
-  **Family Backyard Poultry project**
-  **How to raise ducks**
-  **Native bee production**
-  **On-farm fodder sources in agroforestry (trees and grasses)**
-  **Off-farm fodder sources in agroforestry (trees and grasses)**

Simple agro-livestock technology (SALT-2)

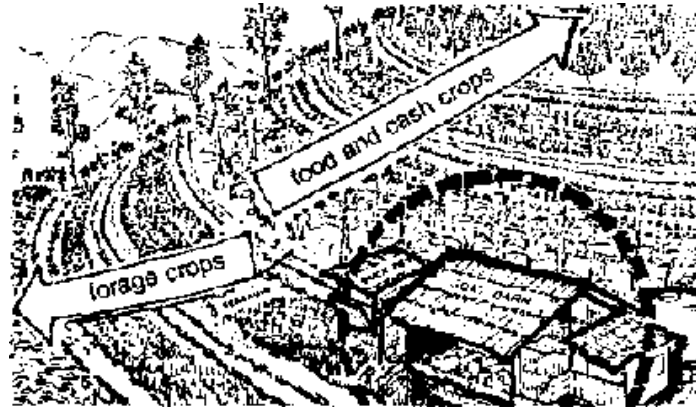

Simple agro-livestock technology (SALT-2)

SALT-2 is a half-hectare model of goat-based agroforestry with a land use of 40 percent for agriculture, 40 percent for livestock and 20 percent for forestry. The experience of Mindanao Baptist Rural Life Center in Bansalan, Davao del Sur, has shown that this technology can minimize erosion, improve soil fertility and generate a relatively better income for an upland family.

This information material will guide on how to establish SALT-2.

Upland residents in the Philippines are considered "the poorest of the poor" with an annual per-capita income of P 2,168, way below the average poverty cut-off for families belonging to the bottom 30 percent

income bracket. In addition, the diets of these uplanders are found to be inadequate in quality and quantity. Based on the studies done in Palawan, second and third degrees of malnutrition ranging from 40.746.9 percent are prevalent among the upland population.

To alleviate malnutrition in the uplands and increase the farm family income, the Mindanao Baptist Rural Life Center (MBRLC) developed an agroforestry system called the Simple Agro-Livestock Technology or SALT 2. It is classified under the agro-silvipasture scheme of agroforestry in the sense that it integrates production of fuelwood (from hedgerows), agricultural crops, livestock and forage.

Among the livestock that can be raised in this system are cattle, sheep and goats. Goats, however, are preferred. Goats are already an important component of small-farm systems in the Philippines. These animals have high fertility and short intervals of kidding. Although small in size, they are highly resistant to pests and diseases and are relatively inexpensive to stock. The goat manure is also a good source of fertilizer. More importantly, goats are good sources of meat and milk and have a potential to alleviate the malnutrition problem in the uplands.

Step 1: Locate and develop the contour lines. Find the contour lines of

your farm by using an A-frame.

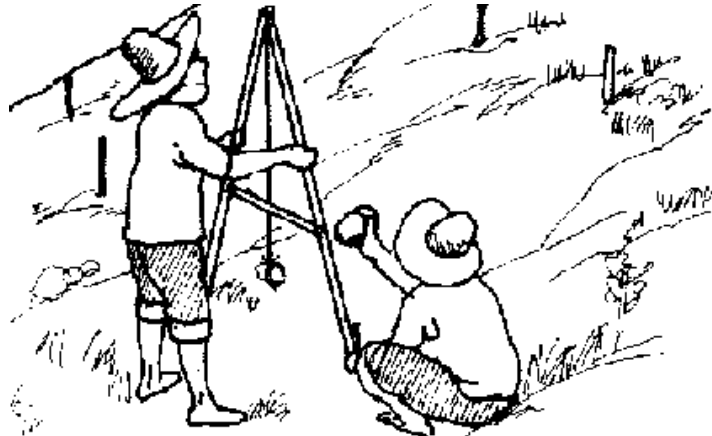

Step 1. Locate and develop the contour lines.

Step 2: Establish your hedgerows. Cultivate the contour lines thoroughly, forming raised beds, 1 m wide. Make 2 furrows, 1/2 meter apart, on each contour line. Plant thickly the nitrogen-fixing trees and shrubs (NFT/S) on the furrows. Plant NFT/S at the uppermost part and along the borders of the farm. Examples of hedgerow species are *Flemingia macrophylla*, *Desmodium rensonii*, *Leucaena leucocephala*, *L. diversifolia* and *Glicinia sepium*.

Step 3: Plant food and cash crops. Grow food and cash crops on the

upper half of the farm so that loosened soil due to cultivation is caught at the lower half portion by the forage crops. To avoid further disturbance of the soil, plant 3/4 of the agricultural area to longterm crops (e.g., black trellis, coffee and cassava) and the remaining 1/4 to short-term ones (e.g., beans and peanut).



Plant food and cash crops.

Step 4: Develop your forage garden. Plant the other half of the area to forage crops. This should be established six to eight months before bringing in the goats. Plant only palatable, high in protein, fast-coppicing and high-yielding forage crops. A suggested composition of

forage crops is 50 percent *Desmodium rensonii*, 25 percent *Flemingia congesta*, 20 percent *Glicinia sepium* and 5 percent grasses like napier.

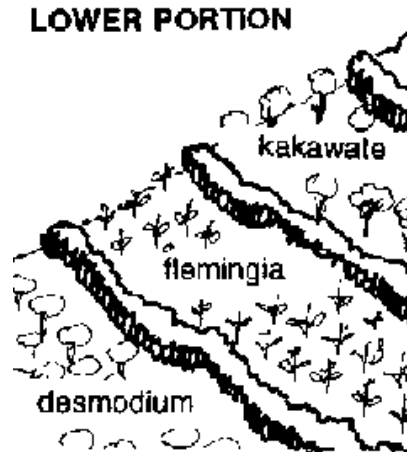

Develop your forage garden.

Step 5: Build the goat barn. Construct the goat bam at the middle of the farm between the boundary of the "forage garden" and agricultural area. This will save time and labor in hauling manure out to the farm and in carrying forage to the goats. Provide floor space of 2025 sq ft per goat using local materials. For convenient removal of manure, raise the floor 4 fl above the ground with floor slots nailed, 1/2 inch apart.

Essential divisions and fixtures in your goat house are kids' separation pen, milking stanchion, milkroom, storeroom, feeding trough, grass rack, waterer and salt trough.

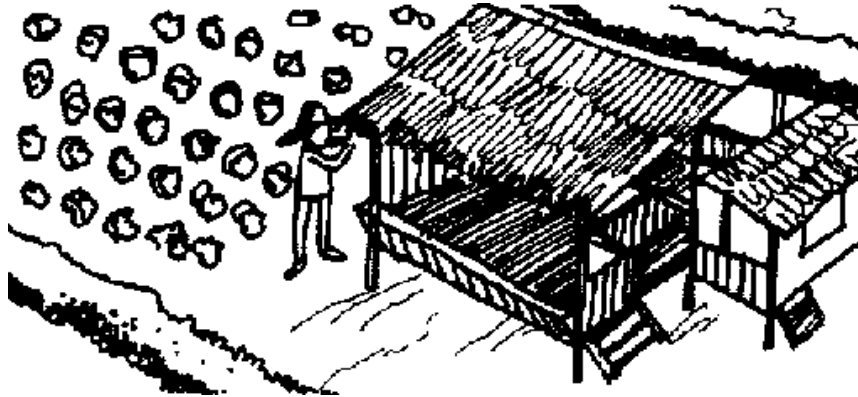

Build the goat barn.

Step 6: Bring in the breeding stock at the right time. Do this only when the "forage garden" has been fully established and is already capable of supplying sufficient forage for the goats. Bring in the goats six to eight months after planting the forage crops. The recommended breeds are either the purobreds, crossbreds or upgrades of Nubian, Alpine and La Mancha. Without these breeds, start with the biggest goat you can buy. A good stocking rate is 1 buck: 12 does per half ha of a well-developed agroforest farm.

Step 7: Feed the goats sufficiently. Dairy goats essentially need concentrates (high-energy feeds) aside from the forage (high-fiber feeds). Give them feeds in the morning and in the afternoon. A good concentrate consists of 18 percent first class rice bran, 23 percent com grain or rice middling, 21 percent copra meal, 36 percent Leacaena leacocephala (Ipil-ipil) leaf meal, 1 percent sait and 1 percent limestone. A good forage is a mixture of 50 percent Desmodium rensonii, 25 percent Flemingia macrophylla, 20 percent Gliricidia sepium and 5 percent grasses like napier. Goats should be given forage of at least 10 percent of their body weight per day. Provide your goats with salt and plenty of water everyday



Feed the goats sufficiently

Step 8: Breed the goats. Breeding too early will stunt the animal. A doe should not be bred until she weighs 45-50 kg or she is 10-12 mo old. Breed the doe in the second day of the heat period. If the doe is not pregnant after being bred over three heat periods, she could be culled or placed under close observation if she is a valuable breeding animal. Rebreeding may be done 2-3 months after the doe has given birth.

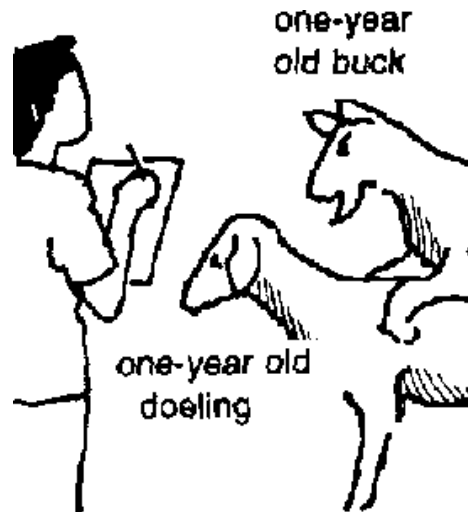

Breed the goats

Step 9: Market your products wisely. Milking, which is done daily, should have a definite procedure and time. A slight change in the

routine of feeding and milking will result in unfavorable milk yield. Pasteurize the milk first (at 74°C about 30 seconds) before selling it.

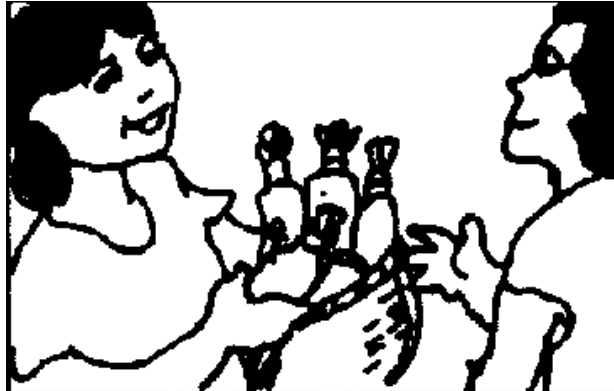

Market your products wisely

Do not delay marketing your other farm products. The kids of the goats can be marketed at the age of 10-12 mo or when they weigh from 35-55 kilograms.

Step 10: Maintain the SALT-2 farm regularly. Cut the hedgerows half to one-meter from the ground when they start to shade the field crops. Replant missing hilis of the hedgerows, weed and clean the crops and spray with chemicals only if necessary. Rotate the nonpermanent crops.



Maintain the SALT-2 farm regularly

Other features

The buck should be separated from the doe. A good set-up is to build another shed for the animal and to bring a doe to the buck house when the doe is in heat.

During the rainy season, a farmer may have more forage than he can give to his goats. When this occurs, the leguminous shrub cuttings can be used as green manure for the agricultural crops.

The goat manure should be utilized as fertilizer both for the agricultural crops and the forage.

Kids should be disbudded five days to one month after they are born. Adults can be dehorned using a dehorning instrument or by sawing off the horn close to the skull.

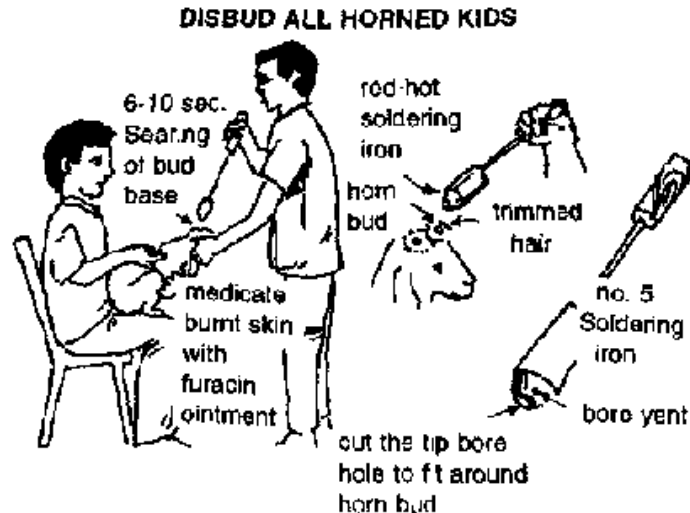

Deworming should also be practiced every month for five months and every three months thereafter.

The sideways of the boundary may be planted to fruit trees like lanzones, rambutan, durian and guava.

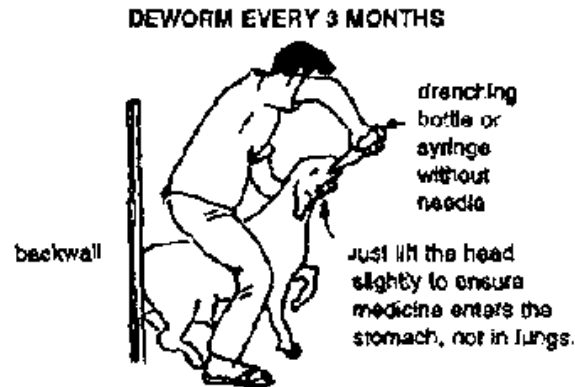

SALT-2 encourages Filipino farmers to integrate dairy goats into their upland farms, thus, increasing profitability without the fear that goats may destroy plants/crops.

In addition, the establishment of many SALT-2 projects throughout the country has been predicted to create new jobs (milk handling, selling and processing of milk products) in the long run.

As per the experience of the MBRLC, SALT-2 can provide a regular and

decent income to an upland farm family, improve soil fertility by using organic (animal manure, plant biomass) fertilizers and minimize soil erosion in the uplands.

This scheme, however, has two limitations: decent income could only be realized if there is a ready market for goat's milk; and, cold storage will be needed if milk handling is done by the family.

Economic benefits

Cost and return analysis for five years conducted at the MBRLC showed that SALT-2 can generate a monthly net profit of P 2,660.00/half ha. Its return on investment (ROI) is 38.71 percent.

But, on top of this financial benefit is a self-sufficient family (with diverse food crop supplies plus about 4,735 liters of goat milk yearly) and a protected and ameliorated soil (with about 16 tons of goat manure annually) which enhance productivity and sustainability of the uplands.

Increased farm productivity per unit time and area, generation of employment and increased milk/meat supply for the improvement of the nutritional status of the farming population may be the key solutions to the impending insurgency problems associated with harsh

**economic realities affecting almost every rural poor in the Philippines.
And SALT 2 meets all these demands.**

**Note: All the crops mentioned earlier are only suggestions.
Farmers can use any other crops suitable in their area.**

Sources:

Pagbilao M., W. A. Laquihon and H. R. Watson (1989). Simple Agro-Livestock Technology. Paper presented during the 2nd Regional Symposium on Research and Development Highlights of the Central Mindanao Agriculture and Resources Research and Development Consortium (CEMARRDEC).

Tacio, H. D. (1990). Raising goats under the SALT system. The PCARRD Monitor.



 **Livestock and Poultry Production (IIRR, 1992, 106 p.)**

 **(introduction...)**

 **Message**

 **Workshop to revise the agroforestry**

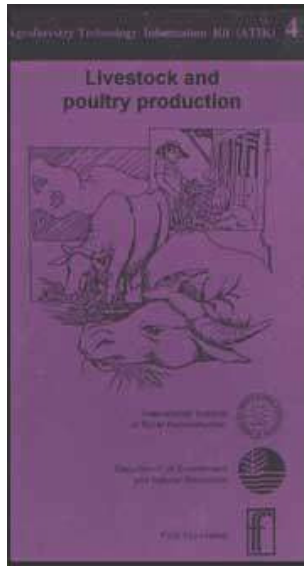

technology information kit (ATIK)

 **List of participants**

 **Current program thrusts in upland development**

 **Simple agro-livestock technology (SALT-2)**

  **Intensive feed garden**

 **Characteristics of forage grasses for IFG**

 **Plant-based livestock medication**

 **Small-scale cattle production**

 **Forced-feeding technology (including Batangas cattle-fattening system)**

 **Native pig production**

 **Pig-feed garden**

 **Low-cost goat housing**

 **Improving the native chicken**

 **Family Backyard Poultry project**

 **How to raise ducks**

 **Native bee production**

 **On-farm fodder sources in agroforestry (trees**



Off-farm feed sources in agroforestry (trees and grasses)

Intensive feed garden

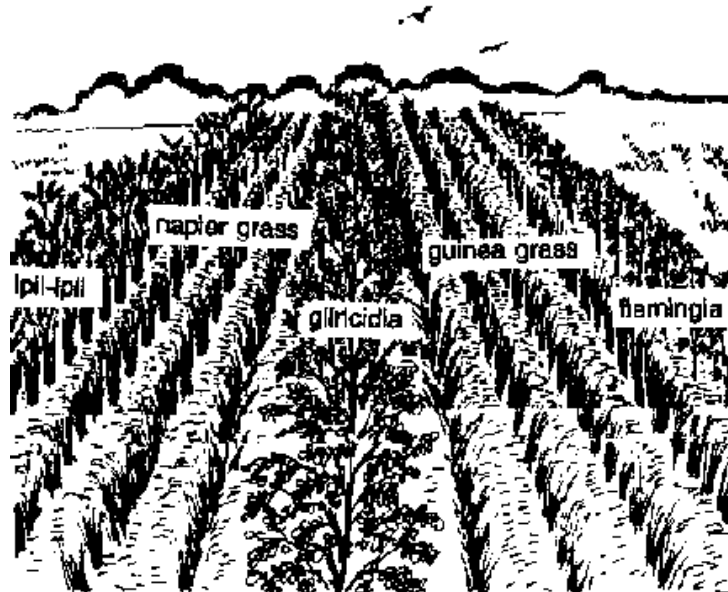

Intensive feed garden

Intensive Feed Garden (IFG) is the planting of forage and leguminous trees together on a piece of land as potential nutritional source of

animal feeds throughout the year. It requires 200 sq m of land to feed 5-6 heads of native goats and about 400 sq m to feed a cattle.

The concept of an IFG aims at maximizing the production of fodder in a limited land area (10m × 20m) through extensive cultivation of leguminous trees/shrubs and grasses. This technology is recommended where compound farming is practiced and livestock have to be confined. It is appropriate where feed is scarce and not readily available or for "cut-andcarry" system.

Benefits from an intensive feed garden

- 1. Provides renewable and inexhaustible source of nutritious and palatable fodder, fuel and green manure.**
- 2. Curbs soil erosion, conserves soil moisture and increases soil fertility**
- 3. Increases the productivity of a given piece of land by interplanting diverse species of fodder trees, shrubs and grasses**