

Village milk processing

[TABLE OF CONTENTS](#)

by
J.C. Lambert
Dairy Technology Specialist
Meat and Dairy Service
FAO Animal Production and Health Division



The designations employed and the presentation of material in this publication do not imply the expression of any opinion whatsoever on the part of the Food and Agriculture Organization of the United Nations concerning the legal status of any country, territory, city or area or of its authorities, or concerning the delimitation of its frontiers or

boundaries.

M-26

ISBN 92-5-102679-3

All rights reserved. No part of this publication may be reproduced, stored in a retrieval system, or transmitted in any form or by any means, electronic, mechanical, photocopying or otherwise, without the prior permission of the copyright owner. Applications for such permission, with a statement of the purpose and extent of the reproduction, should be addressed to the Director, Publications Division, Food and Agriculture Organization of the United Nations, Via delle Terme di Caracalla, 00100 Rome, Italy.

FOREWORD

The proposed study analyses the constraints normally encountered in milk marketing by isolated producers far from trade centres. As a study, it is not intended to reflect climatic, geographic and ethnic characteristics. It may, however, serve as a basis for improving the economic level of those livestock producers who usually are forgotten in development plans prepared by governments or institutions.

The illustrations presented in this study were drawn by Mr. G. Beccaloni (AGAD).

FOOD AND AGRICULTURE ORGANIZATION OF THE UNITED NATIONS Rome, 1988

© FAO

Hyperlinks to non-FAO Internet sites do not imply any official endorsement of or responsibility for the opinions, ideas, data or products presented at these locations, or guarantee the validity of the information provided. The sole purpose of links to non-FAO sites is to indicate further information available on related topics.

TABLE OF CONTENTS

Part 1: Village milk processing methods

I INTRODUCTION

II A village milk processing unit: why?

III A village milk processing unit: how?

IV A village milk processing unit: where?

V A village milk processing unit: what does it do?

VI A village milk processing unit: what it should be.

Part 2: The village milk processing unit: a general model

I The site

II The building

III Operation

IV Equipment:

1. For collection?

2. For processing

3. For marketing

V Additional equipment

Part 3 Organization and operation of the milk processing unit

- I Milk collection
- II Milk reception
- III Milk standardization:
 - 1. Acidity
 - 2. Fat content
 - 3. Calculation for milk standardization
- IV Heat-treatment of milk
- V Cooling milk
- VI Processing aids:
 - 1. Preparation of starter cultures
 - 2. Preparation of rennet

Part 4: Appropriate technology for the manufacture of dairy products

- I Cheese
- II Cream and butter
- III Buttermilk
- IV Yoghurt
- V Fermented milk
- VI Processed cheese
- VII Whey from cheese-making
- VIII Cleaning and disinfecting operations
- IX Organization of work
- X Layout of the unit

Part 5: Accounting and equipment costs

I Accounting:

1. Reception

2. Standardization

3. Cheese-making

II Study of cost price:

1. Cost of raw material

2. Collection costs

3. Processing costs

4. Packaging costs

5. Transport costs

6. Marketing costs

III Estimating equipment costs:

1. Milk collection equipment

2. Milk reception equipment

3. Laboratory equipment

4. Milk standardization equipment

5. Cheese-making equipment

6. Butter-making equipment

7. Equipment for preparation of processing aids

Bibliography



Part 1

VILLAGE MILK PROCESSING METHODS

I INTRODUCTION

In developing countries, it is quite common to find milk production areas at great distances from areas of heavy demand for dairy products. These areas of demand are usually concentrated in the capitals and major cities. In an attempt to meet this demand in part, developing countries have tried to establish dairy industries near urban consumption centres.

While there is overproduction in some parts of the country due to lack of outlets, dairy plants often work at only 20 percent of their capacity because of the long distances between the milk producing zones and the urban consumption centres where the plants are situated.

Costs of milk collection for plants located near the capital are very high due to fuel prices, poor road conditions (particularly during the rainy season), the cost of spare parts and the mileage required to be covered. For economic reasons, therefore, dairy plants have tried to restrict milk collection to nearby milk-producing zones, rounding out their daily output through the importation of dried milk and butter oil used for reconstituted milk.

The cost of milk collection represents approximately 30 percent of the processing cost of the finished product (packaged pasteurized milk).

The traditional demand in developing countries is for fresh milk in the cities and fermented milk in the countryside.

The dairy plant therefore primarily produces fresh and reconstituted milk, pasteurized, and

packaged in plastic bags. Governments generally consider milk a basic commodity and consumer prices are strictly controlled. Plant profits from milk sales are usually quite low, forcing the management to market another, more remunerative product not subject to price control. A frequent choice is yoghurt, which is sold to wealthier people and to expatriates.

Besides the market for local milk products, there is also a market for imported products which, in order of importance, are dried milk for babies, tinned milk and cheeses.

As a result, the problem in many developing countries is that while the small milk producer has no regular outlet for his milk, consumers pay high prices for imported dairy products.

II A VILLAGE MILK PROCESSING PLANT: WHY?

First of all, a dairy processing plant should offer producers a guaranteed daily outlet for their milk supply.

During the dry season, when domestic milk production is low, milk-pedlars are a common sight buying milk from producers who are far from urban consumption areas. However, during the rainy season, due to poor road conditions and increased milk production, this milk is not collected.

If a milk producer were guaranteed a regular, fair income, it would provide the incentive for him to move from a position of self-sufficiency in milk for the family into one of selling, thus boosting milk production in his area. Remote milk-producing areas are often good livestock production regions, but because of lack of commercial outlets they do not receive the necessary incentives for boosting milk production.

The introduction of a dairy industry, modelled on European systems, into a developing country

has only very rarely involved the producers themselves. And even when it has, usually only the big milk producers located near large towns have been involved. The introduction of a processing plant or unit, at village level, concerns principally the local producers themselves. The size and simplicity of the unit should allow participation by small producers who are aware that self-help is a more immediate prospect than Government or bilateral assistance.

III A VILLAGE MILK PROCESSING UNIT: HOW?

- **by forming associations, the small producers, who live directly on the meagre resources brought to them by their cattle, can set up the unit. Many big herds belong to “entrepreneurs” in cities who entrust their stock to the care of herdsmen, paying them only the equivalent of one day's milking a week.**
- **by presenting a type of project which suits their needs - simple, practical and which allows them to work together within their own environment.**

IV A VILLAGE MILK PROCESSING UNIT: WHERE?

- **The site should be in a remote, inaccessible, traditional milk-producing area. Such areas, where communications are difficult and cattle-raising is a normal component of the family livelihood, are very common in Latin America, Africa, the Near East and Asia.**
- **An area should be chosen where milk collection from the capital is not possible.**
- **In an area where cattle, and milk in particular, should be the main regular source of cash for purchasing the family's domestic needs such as clothing, sugar, etc.**
- **In an area where there is plenty of water to allow hygienic processing of dairy products**

which requires an average of five litres of water for each litre of milk processed.

- **In an area where the quantity of milk to be processed is available within a ten-mile radius since the time required for the transport of the milk should not exceed three hours. In tropical countries this is generally recognized as the upper limit beyond which milk cannot be pasteurized or heat-treated.**

V A VILLAGE MILK PROCESSING UNIT: WHAT DOES IT DO?

- **produces dairy products for which there is demand in the cities and in the villages;**
- **produces dairy products not supplied by dairy plants located near towns;**
- **produces dairy products which:**
 - **can easily compete with imported products;**
 - **do not require costly or sophisticated equipment;**
 - **require neither an expensive source of power nor a particularly complex infrastructure;**
 - **can be easily and cheaply moved without lowering the quality of the finished product;**
 - **can be sold in small unit sizes so as to reach a large number of consumers.**

Locally-produced dairy products, particularly those such as cheeses, butter and fermented products, are frequently considered by the more affluent consumers in the capital cities of developing countries as second-rate compared to imported products. In fact, locally processed

milk products are often considered even by the producers themselves as merely by-products, surplus to their family needs. The project needs to demonstrate that with appropriate technology the finished products can be just as good as, and often better, than imported products considering the time required to clear imports through customs. At a minimal cost their presentation can also be as good.

VI A VILLAGE MILK PROCESSING UNIT: WHAT IT SHOULD BE

- **as simple as possible;**
- **as clean as possible;**
- **as cheap as possible;**
- **as profitable as possible.**

The village dairy unit is a tool:

- **for a group, association or cooperative,**
- **for pooling resources so as to exploit their milk surpluses,**
- **to enable people to organize, and obtain the resources they need for improving their welfare.**



Part 2

THE VILLAGE MILK PROCESSING UNIT: A GENERAL MODEL

I THE SITE

The unit should be located as centrally as possible within a given milk-producing area, near a source of water, or in a place where water is available. The site should be cool and well-ventilated. Sometimes not all these conditions can be met. The most important factor is availability of water. It should be remembered that on average five litres of water are required to process one litre of milk.

II THE BUILDING

Milk and dairy products are biologically active substances which are influenced by their environment. Cheese quality and reliability depend largely on the surroundings in which cheese is manufactured. An unused building can be purchased or leased and adapted for milk processing operations, or a new building can be constructed. It is not uncommon to find in some remote milk-producing areas, abandoned milk collection centres which may be suitable.

For a new building, the following factors should be taken into consideration:

- the walls should be built of local stone and the inner walls lined with a lime-cement mixture for easy cleaning;
- the cement floor should have a 2 to 3 percent slope for draining water used in cleaning;
- windows should be sufficient to provide adequate ventilation.

For village cheese manufacture, the second component of the building is the ripening cellar.

The most important features of a ripening cellar are maximum moisture (80 percent relative humidity) and low temperature (8 to 12°C). To achieve or approach these standards, a room partly below ground level is recommended. It should be about 2.5 m high. The floor of the room should be dug to a level of some 1.5 m below ground, with windows or openings made in the upper walls to lower the temperature of the cellar by a circulating draught, particularly important during the night.

Building size will of course depend on the quantity of milk received during the peak production period. An average quantity of milk which can be processed by a small-scale unit amounts to 100 to 500 litres per day. For these quantities the building area should be some 50 sq. m.

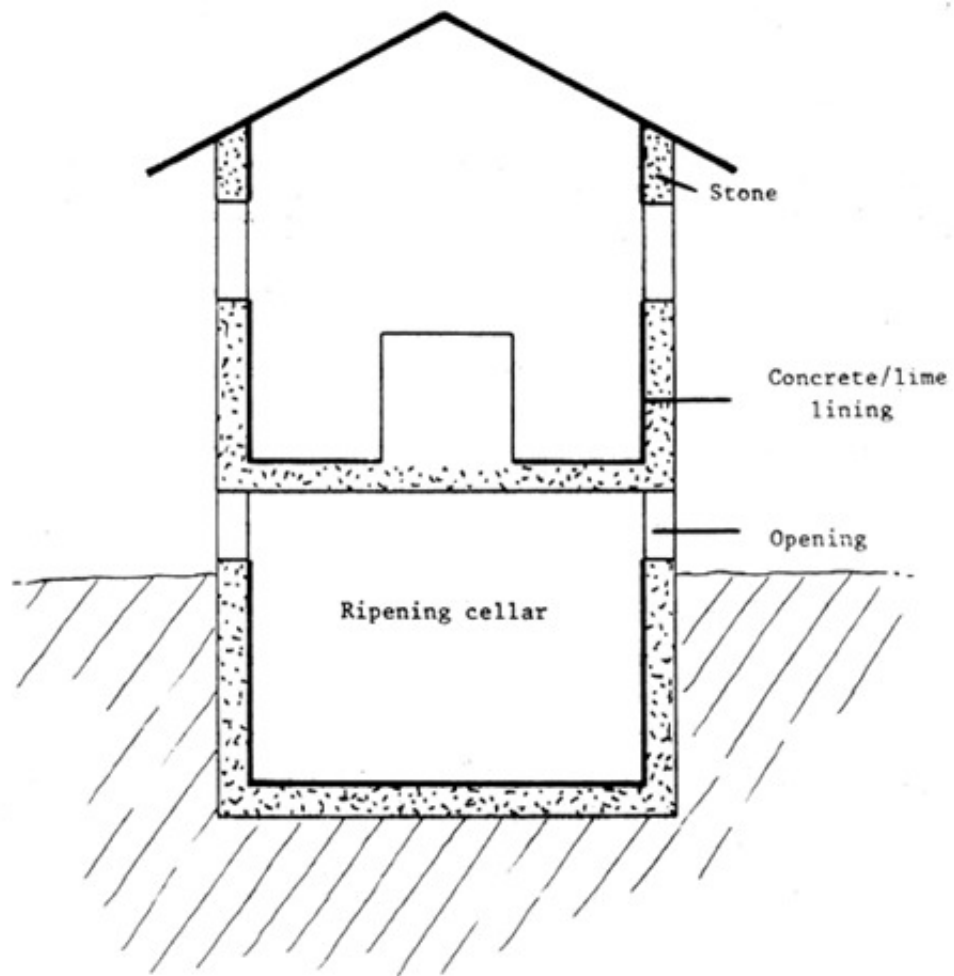

Section of the processing unit

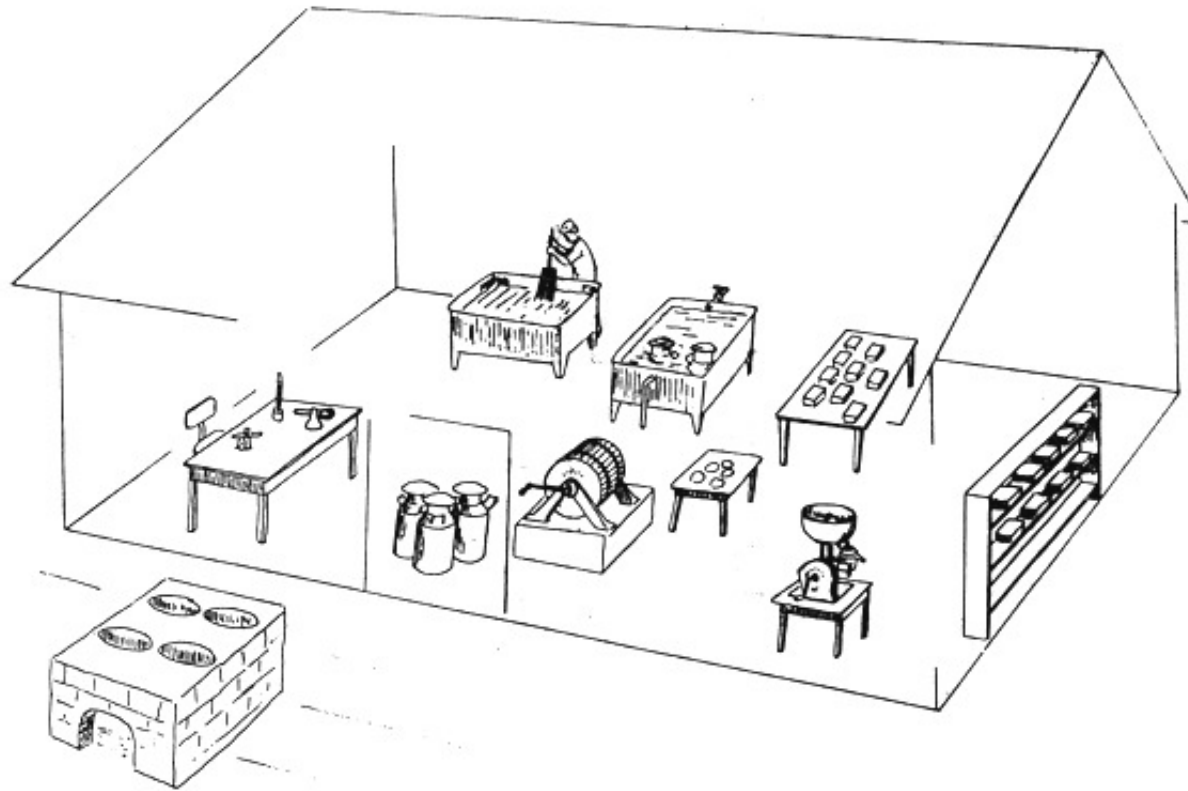
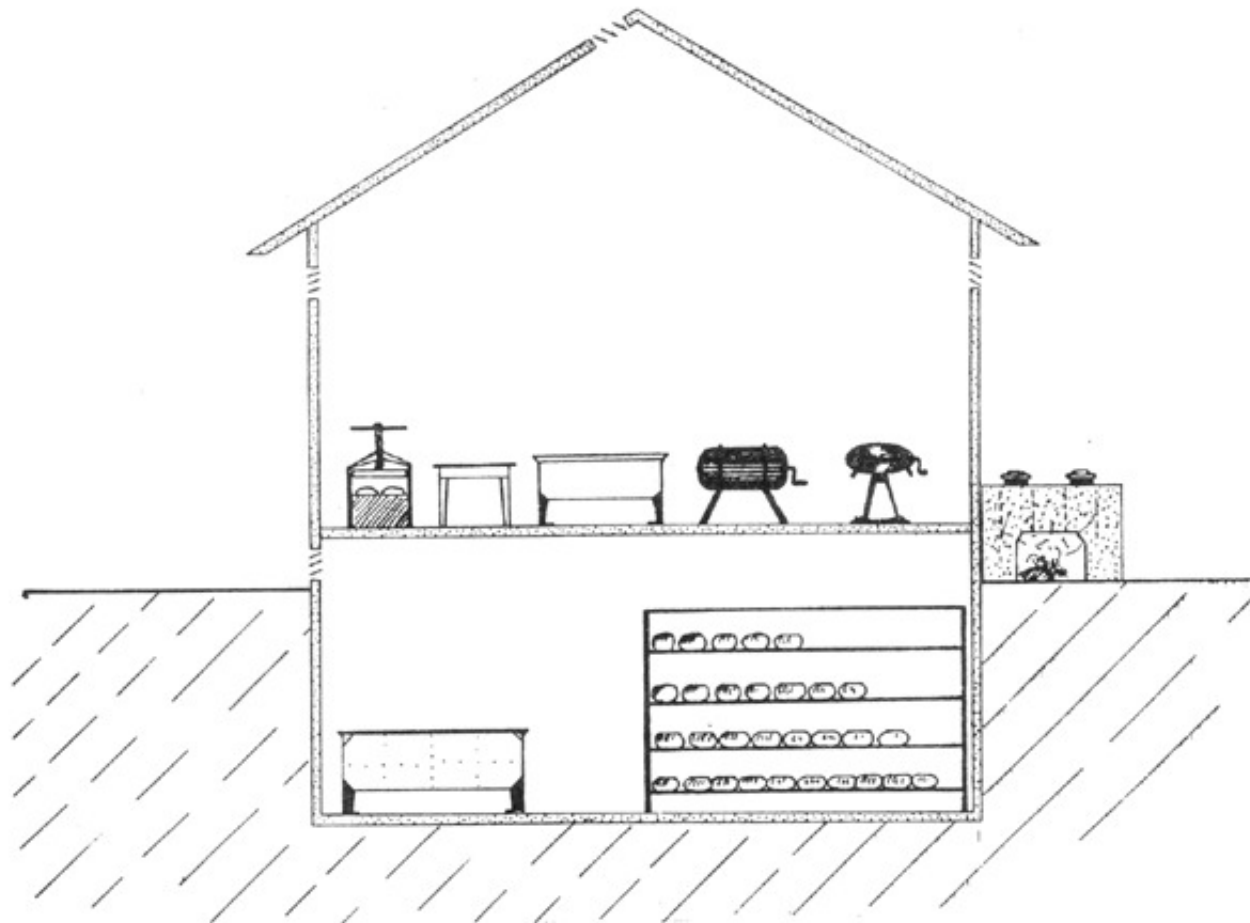

Diagram of building layout



Sectional diagram of processing unit and equipment

III OPERATIONS

As previously pointed out, milk processing operations will take place far from urban consumption centres. In these areas the quantities of milk hardly exceed an average of 500 litres per day.

The products made must be able to withstand long periods of transportation, often under difficult climatic conditions.

Milk products can be processed as illustrated:

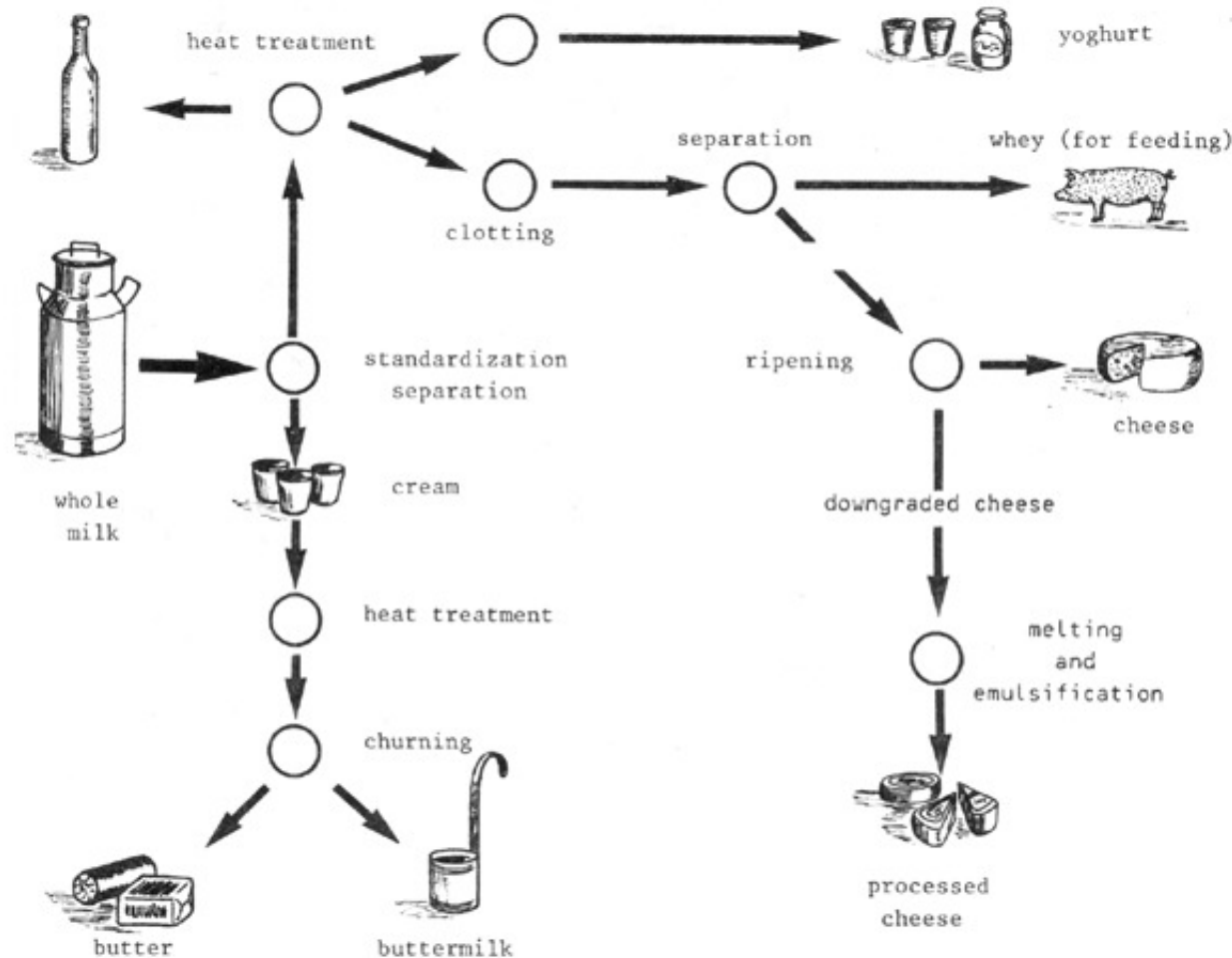

Butter, cheese and processed cheese may require lengthy transportation, given the distance from consumer centres, whereas buttermilk and yoghurt can be marketed in the vicinity of the

processing unit. The whey will be returned to the dairy farmers.

The main steps in obtaining the above products are:

- **Standardization**: Standardization is an operation producing milk with a constant butterfat content through partial, manual skimming. The operation makes it possible to standardize the composition of the finished product and to set aside part of the cream for butter.
- **Heat treatment**: Pathogenic germs in milk are destroyed by heating the milk to a minimum temperature of 63°C for 30 minutes.
- **Inoculation**: Due to heat treatment, which destroys a large number of lactic bacteria, cheese or yoghurt-making requires the addition of lactic bacteria to the milk. These bacteria are selected according to the type of finished product required.
- **Clotting**: Milk changes from a liquid to a solid state through the use of a coagulant: rennet.
- **Curd-Separation**: In cheese-making, the milk after coagulation is cut and separated into a liquid whey, and cheese curd.
- **Ripening**: This phase of cheese-making allows cheese texture to become homogeneous and the aroma to develop.
- **Churning**: In this operation, cream is churned to produce a semi-solid product which becomes butter.
- **Melting and emulsification**: Defective cheeses are melted and emulsified with salts to obtain a solid consistency and, after cooling forms processed cheese.

In addition to the eight steps mentioned above, milk collection, milk analyses and the marketing of the finished products should be equally regarded as important operations.

Each one of these important operations is described in the following chapter according to the five traditional operations: reception, standardization, processing, storage and distribution.

IV EQUIPMENT

The equipment needed to run the dairy processing plant depends on several factors: how much milk is to be collected, how far and how scattered are the milk producers, what kind of product is to be produced?

In the standard milk processing pattern, commencing with milk collection and ending with the sale of the dairy products, the following equipment would normally be required:

1. For collection

- Plastic milking pails are often an improvement on the utensils commonly used.**
- The producer should use small aluminium milk cans of 5–10 litre capacity for transporting the milk, while the collector should use 30–50 litre cans.**
- If the milk needs to be collected, the following will be needed: the use of a bicycle, a 50 litre milk can, a graduated cylinder lacto-densitometer and a measuring pail.**



The amount and density of the milk collected from each producer should be entered in a notebook. The following is a sample entry:

No.	Name of producer	Amount delivered (litres)	Density	Signature
1.	Esperanza Chavez	10	1.030	
2.	Juan Chamaro	5	1.029	
3.	Antonios Vargas	15	1.038	
4.	Musaline Chouco	12	1.030	
5.	Edgar Vasconez	5	1.032	

TOTAL:

47

2. For processing

- **Reception**: the following equipment is needed for the reception of milk brought in by producers themselves and by the collector: a milk scale and a pail.
- **Storage**: a milk funnel and 50 litre milk cans.
- **Standardization/Cream separation**: a manual cream separator has to be used to skim a portion of the milk received.



Milk scale and pail



milk funnels filter and milk can

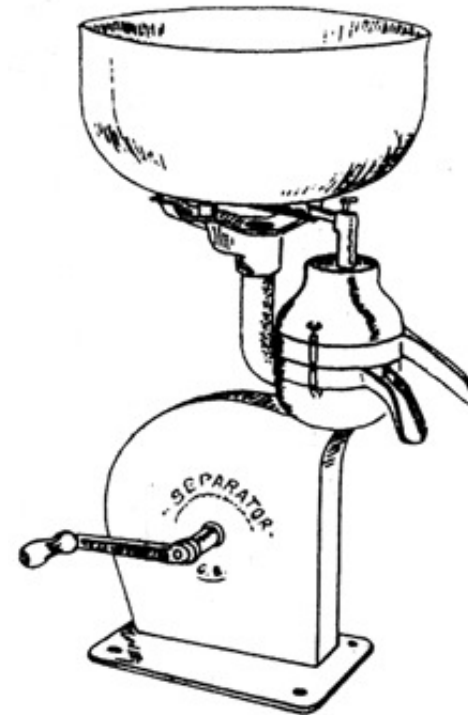

Standardization hand-operated separator

- **Heat treatment**: there are several possibilities for heat treatment, depending on the available power source. Under the least favourable circumstances, the sole available energy source is wood or peat. The best thing to use in this case is a “boiler/water bath” as in the model below:

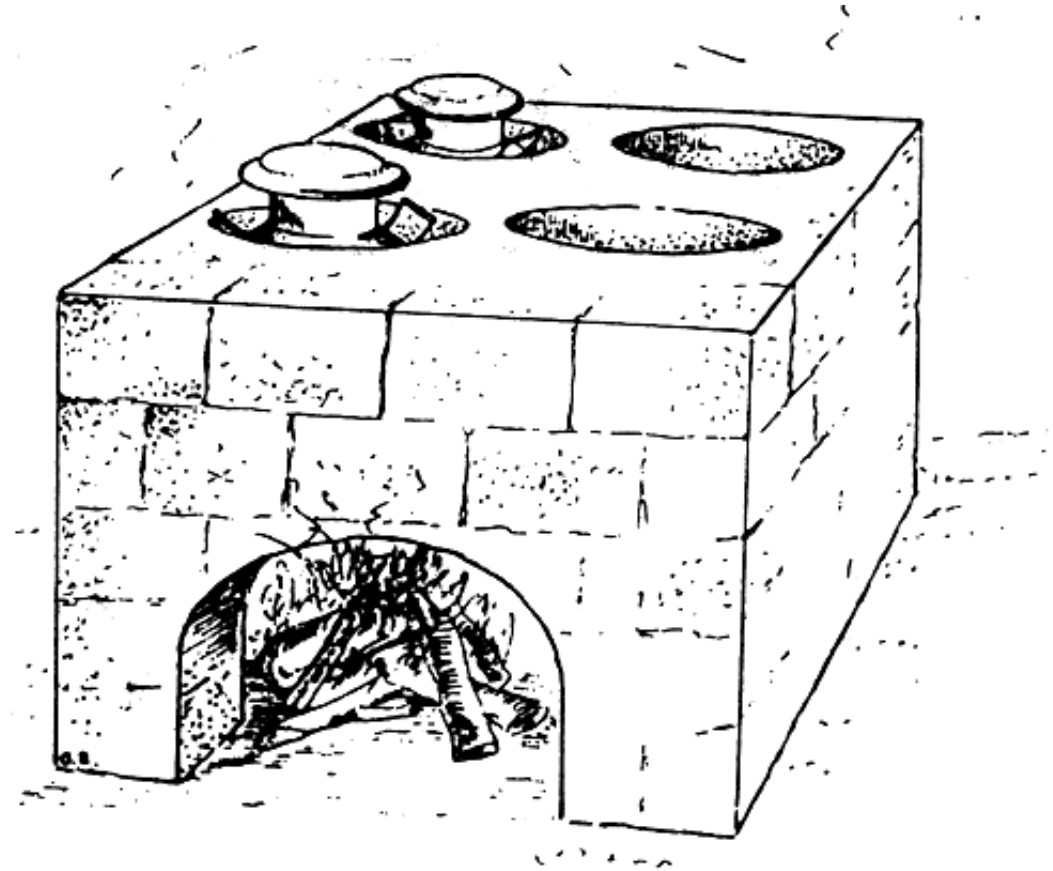

Cement-block boiler

More elaborate models can be built for wood or gas-fuelled heating (where bottled gas is available).

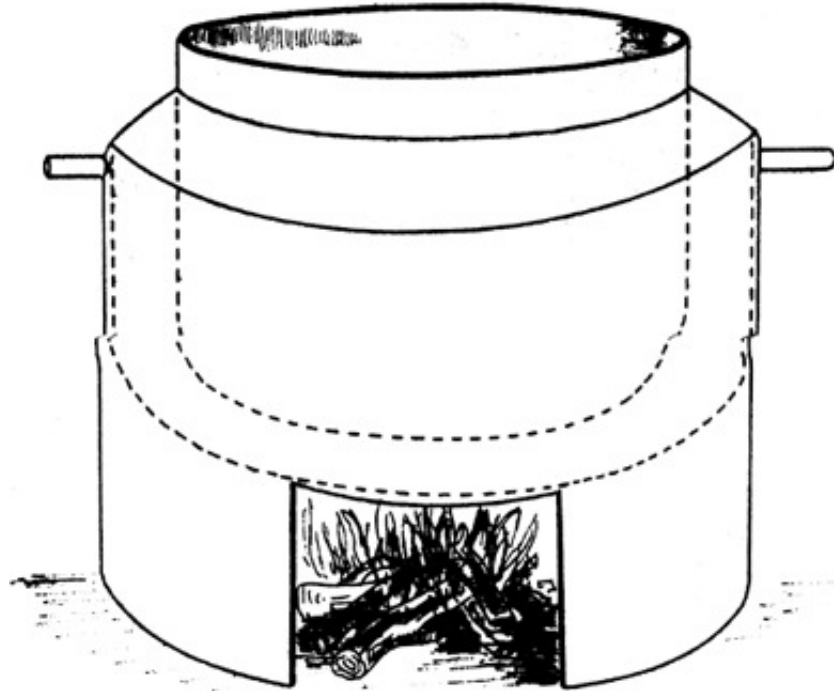

Wood-fuelled metal boiler

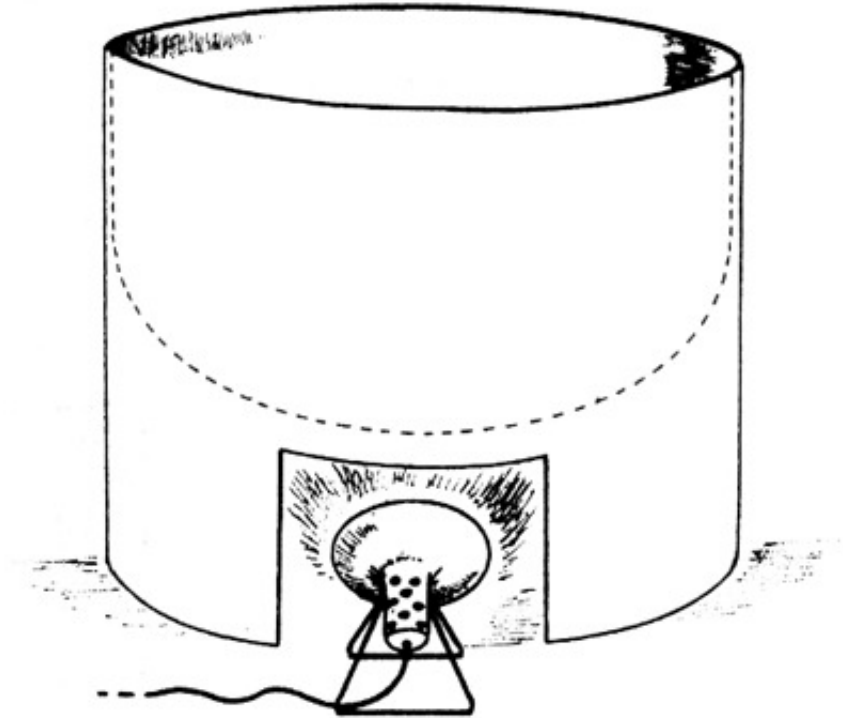

Gas-fuelled metal boiler

For 100–500 litre quantities of milk, milk pasteurization with a plate pasteurizer is not recommended.

- **Cooling: the milk is cooled with running water in a vat:**

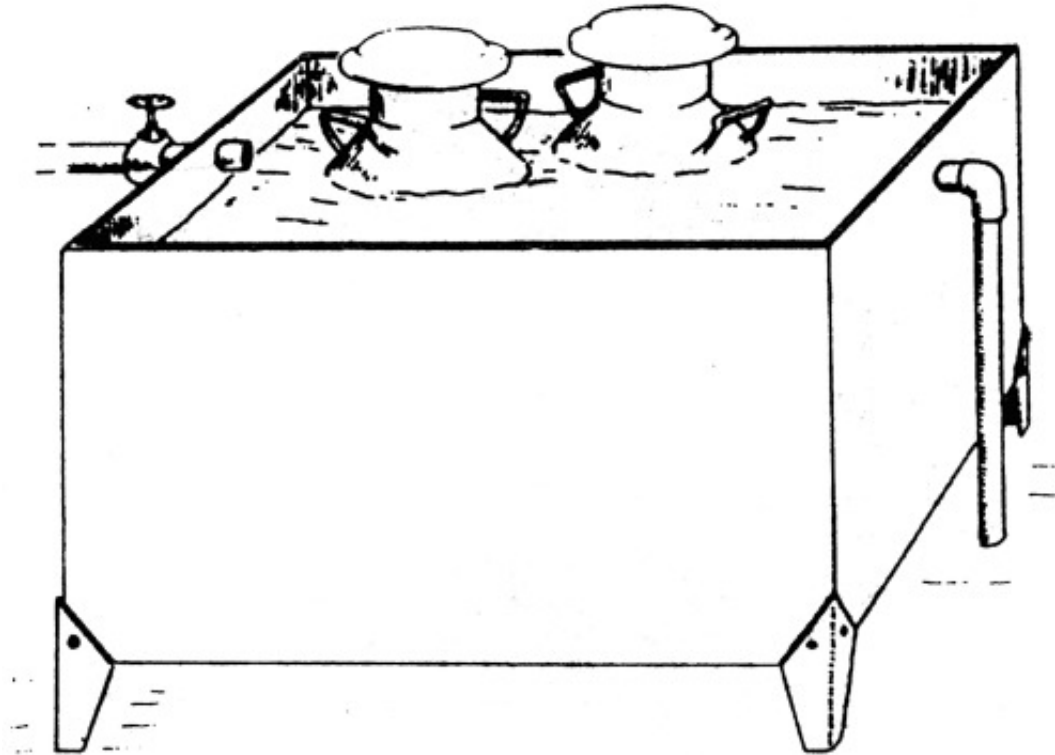

Simple cooling vat

or by water circulating in a jacketed vat.

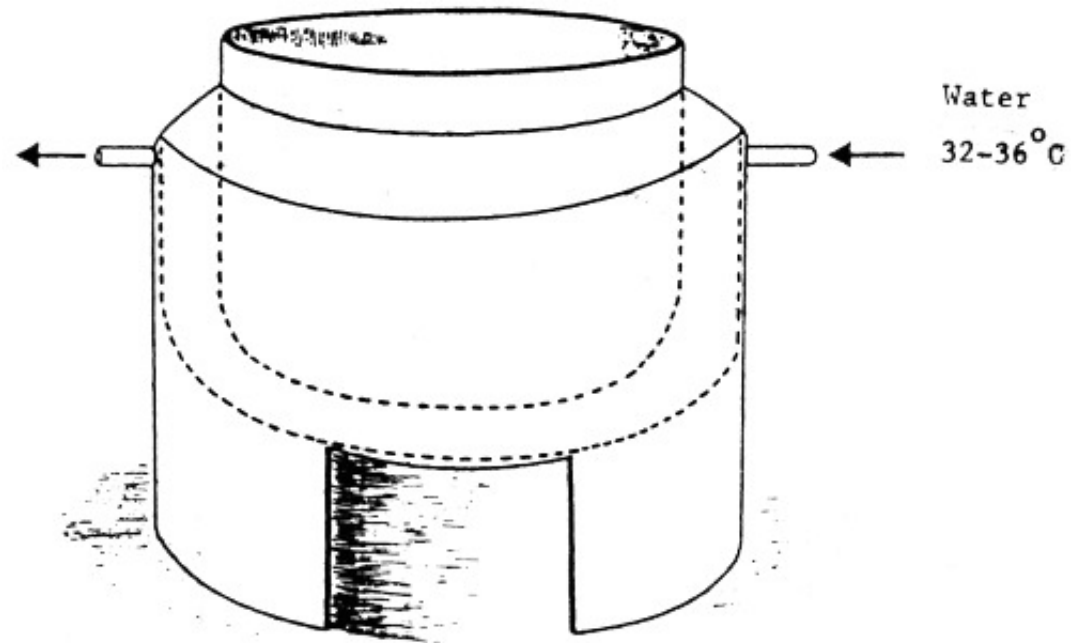

Jacketed cooling vat

- **Clotting**: The cheese vat can be of aluminium with a tap for draining the whey.

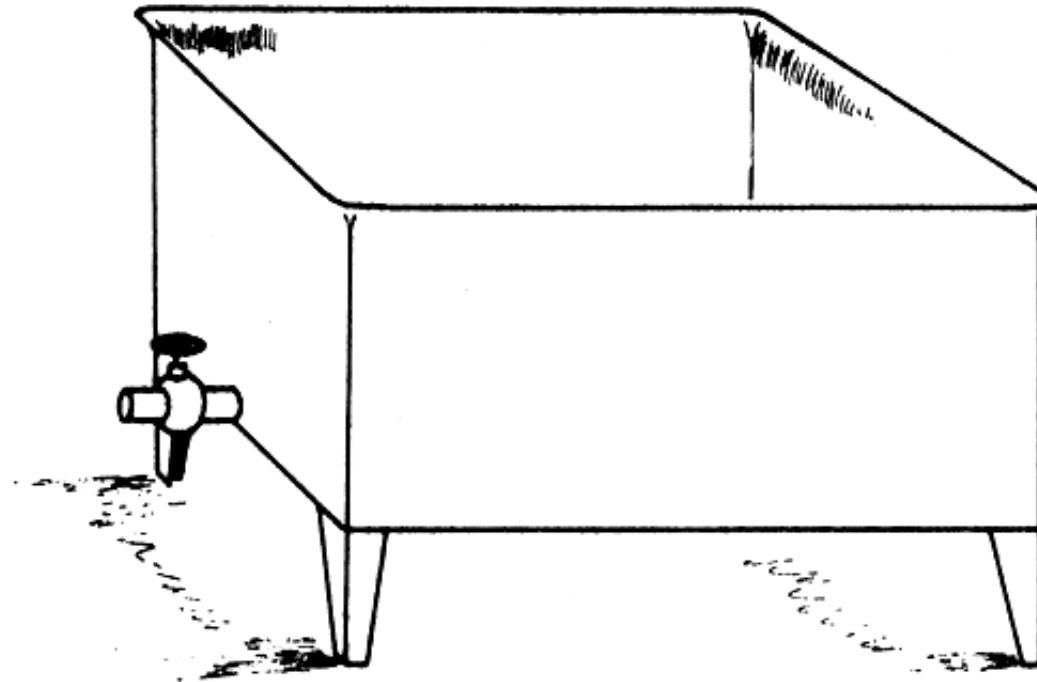

Simple milk clotting vat

A jacketed vat can also be used for milk clotting.

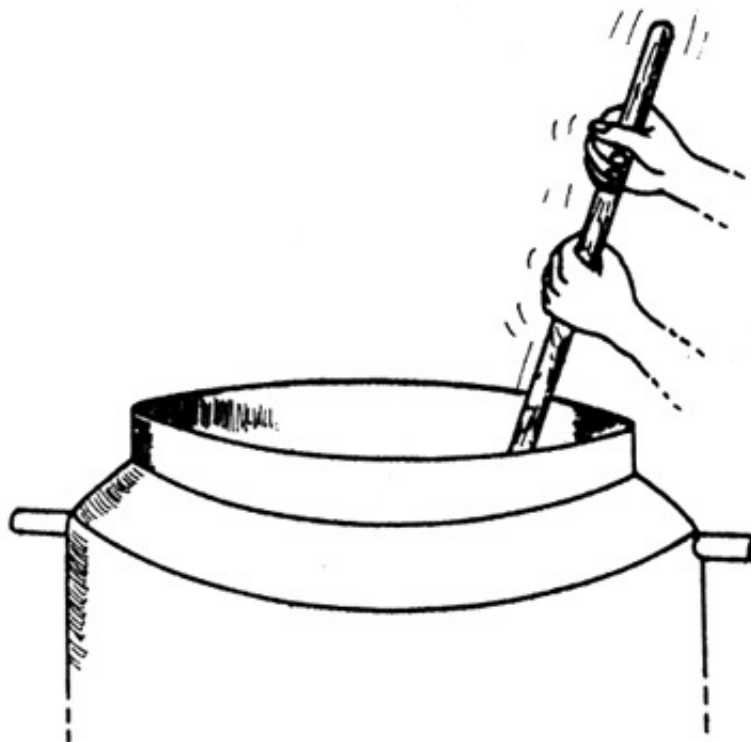

jacketed clotting vat

There are other possible types of cheese vats, depending on the resources available to dairy producers. The following are a few examples:

- **simple vat to process 50–100 litres of milk**

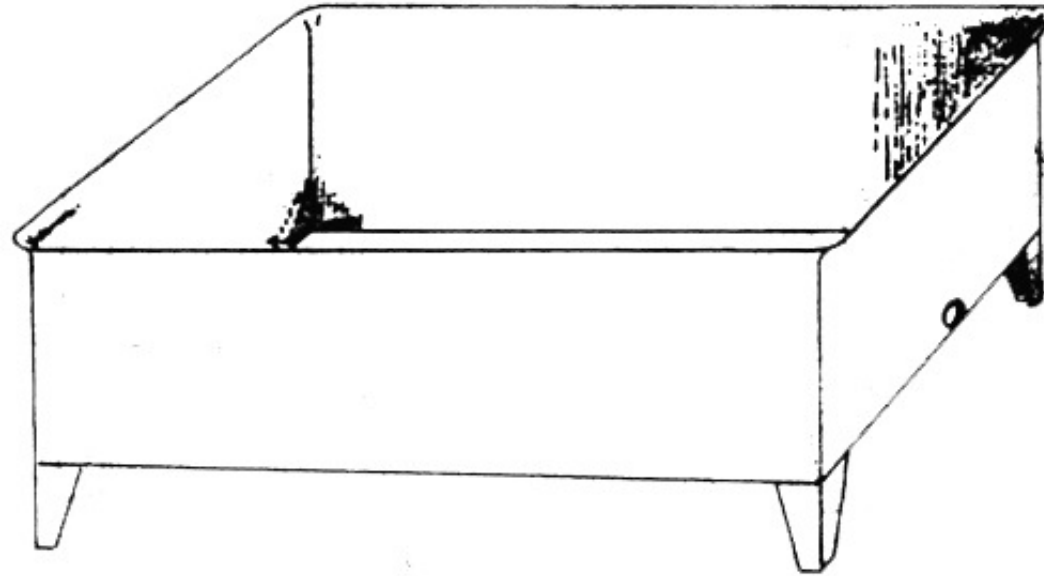

Low-walled clotting vat

- a more elaborate vat for processing 100–300 litres of milk: milk cooled by cold water circulating within its jacket:

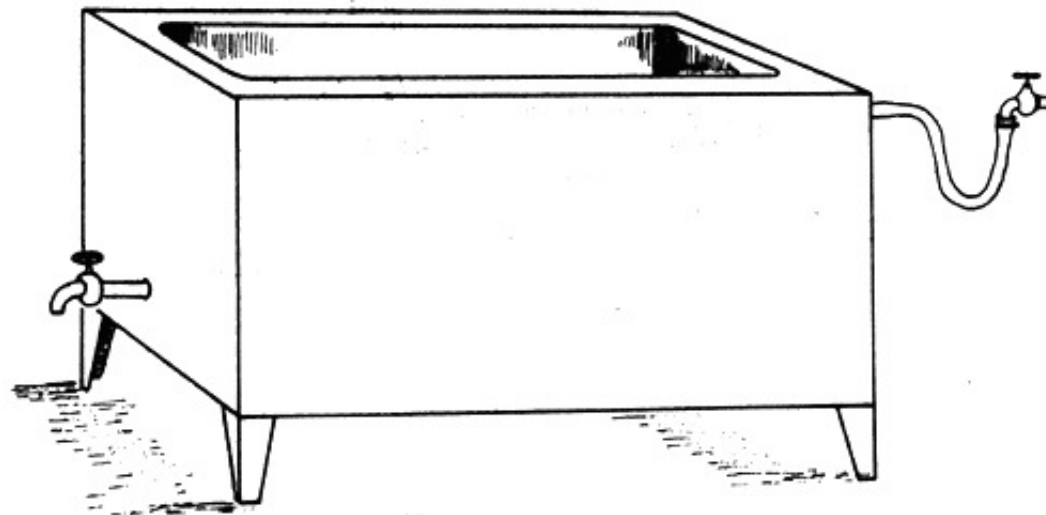

Clotting vat equipped for cooling

- for larger amounts of milk up to 500 litres, a vat equipped for heat treatment, cooling and clotting can be designed as shown in the following diagram:

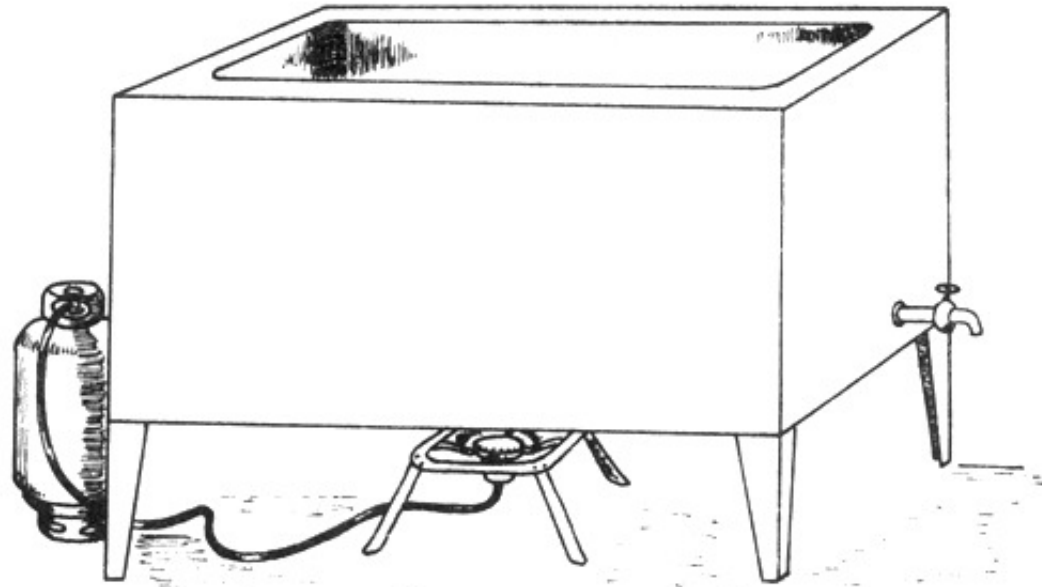

Multi-purpose vat

- **Draining:** the cheese is drained in moulds set on a slanting surface to drain the whey. The moulds, which give the cheeses their characteristic shapes, vary greatly in size and form.

The simplest way to make cheese moulds is to cut a plastic pipe generally used for drainage into 10 cm sections.



The resulting cylinders are perforated as in the model below:

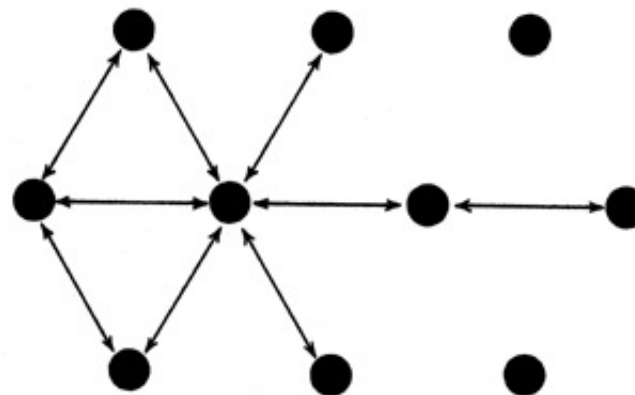
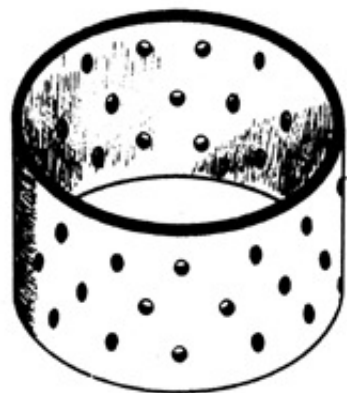

Bases and Lids are of wooden discs slightly smaller in diameter than the cylinders.

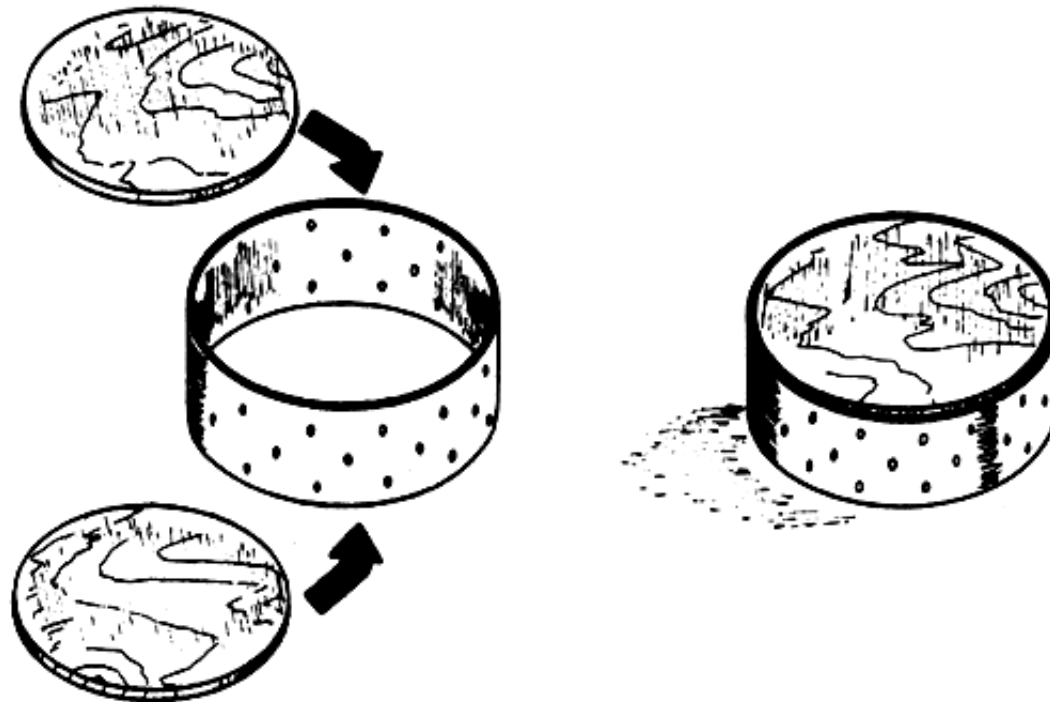

Moulds with bases and Lids

Cheese moulds may also be made of wood, their shape varying according to the type of cheese made.

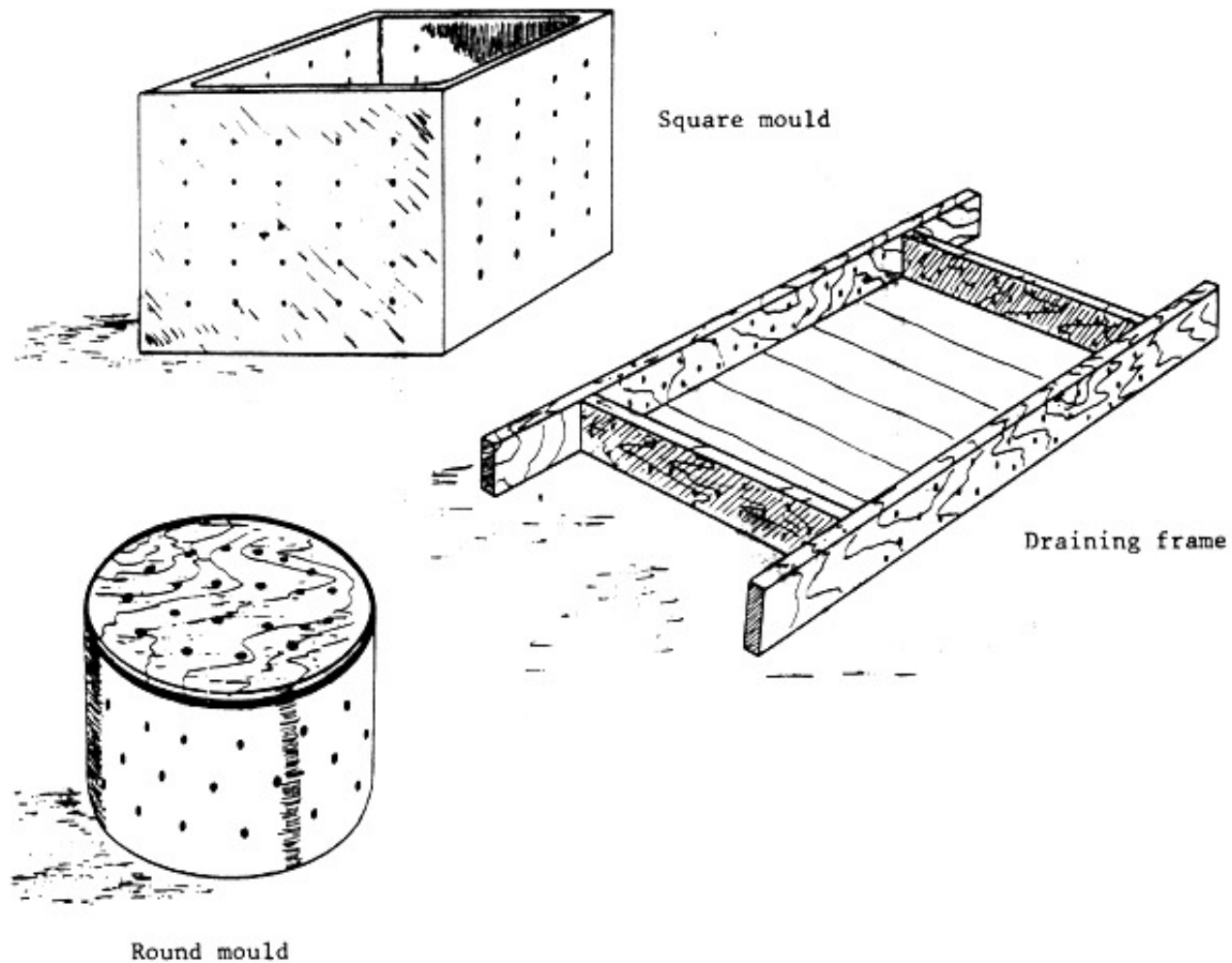

The cheese-draining table, slanted forwards to facilitate draining of the whey, is made of wood.

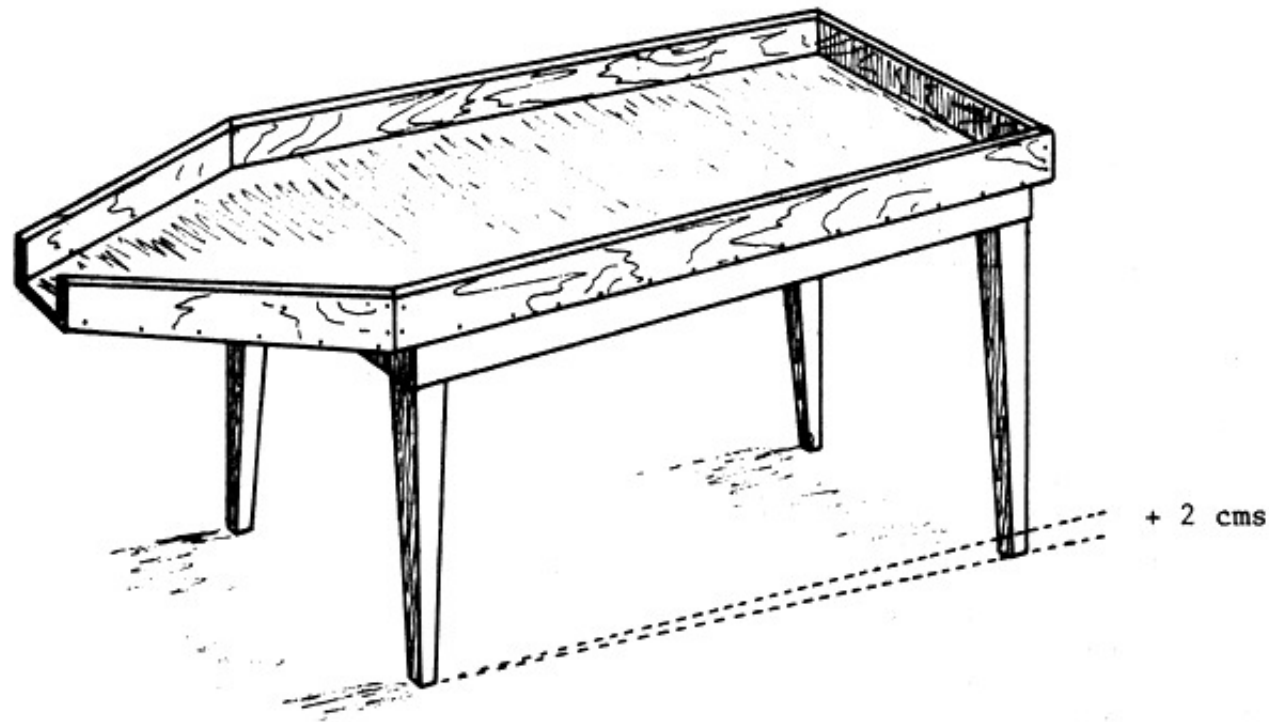

Wooden cheese-draining table

- **Pressing**: different kinds of cheese (curd) presses can be made. The simplest press is made by placing weights or cement block on the moulded cheese (curd) as shown in the following diagram:

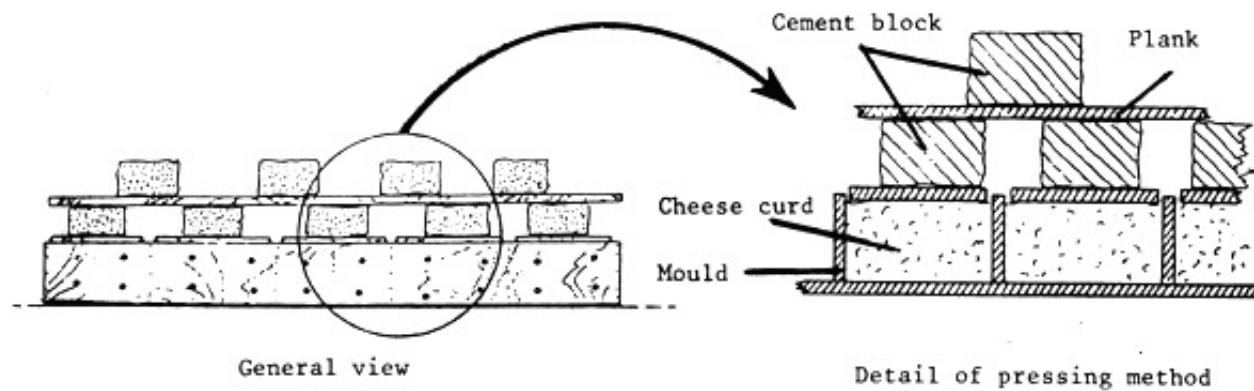

Simple press

Other presses can be constructed according to the following designs:

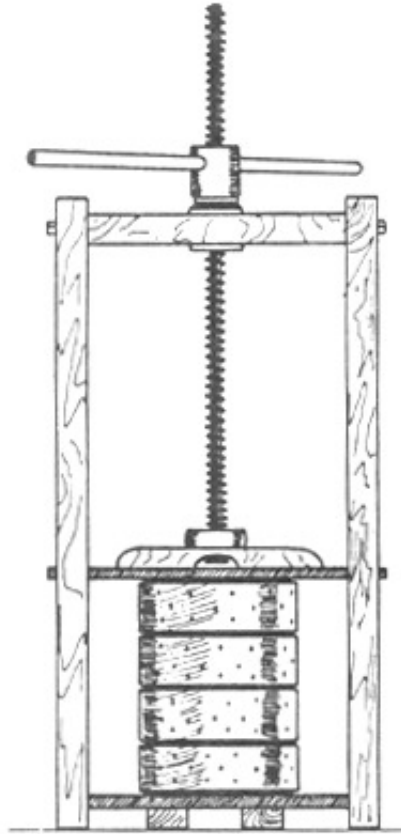

Vertical screw press

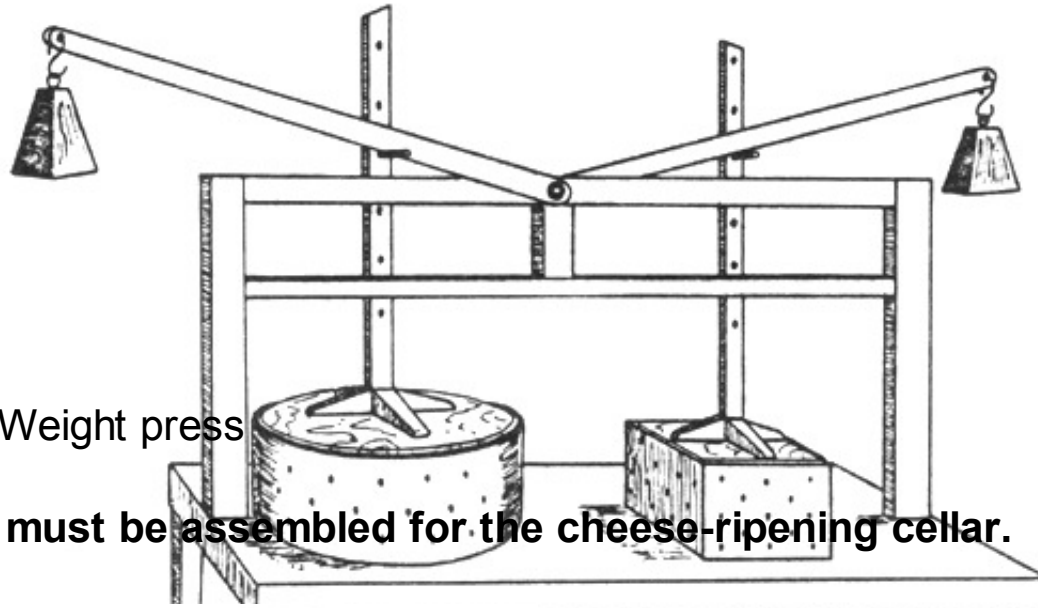

- **Ripening**: wooden shelves must be assembled for the cheese-ripening cellar.

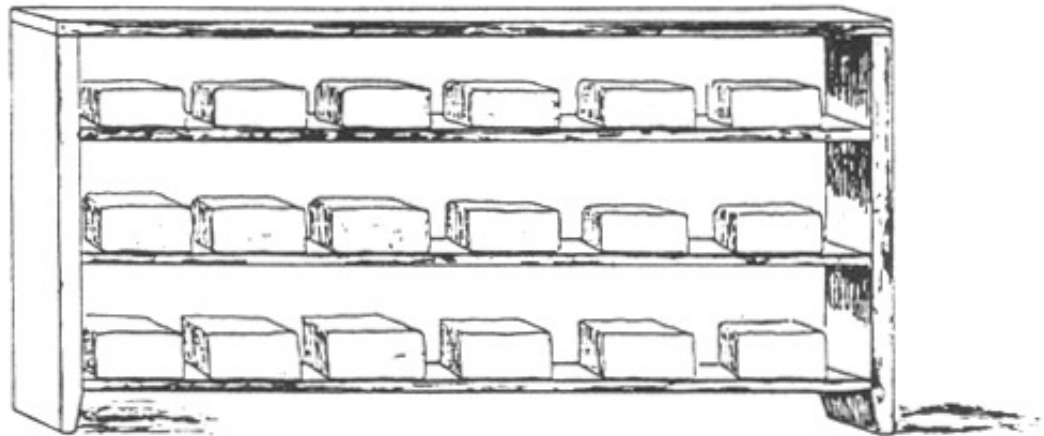

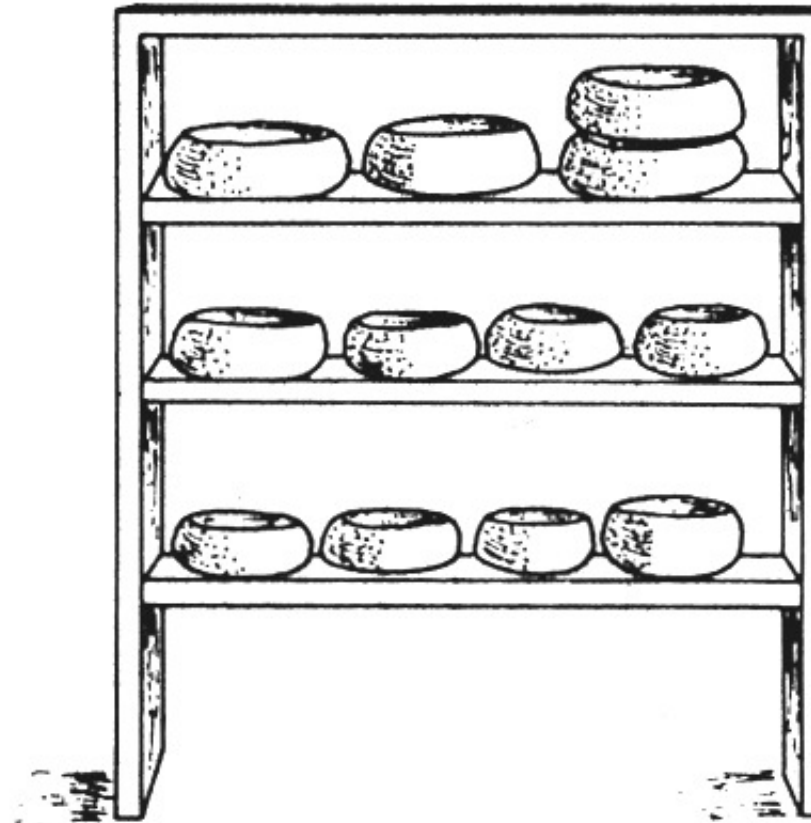

Ripening shelves

3. For marketing

Marketing, as previously mentioned, is a very important aspect of overall operations. Quality of presentation is important. Wooden boxes made to accommodate the specific cheese shapes are used to transport the cheese to consumer areas.

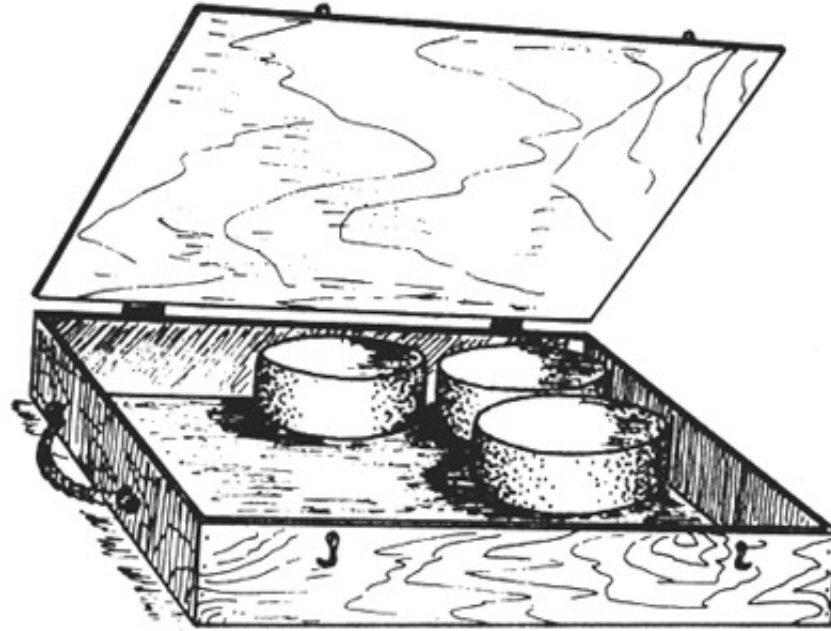

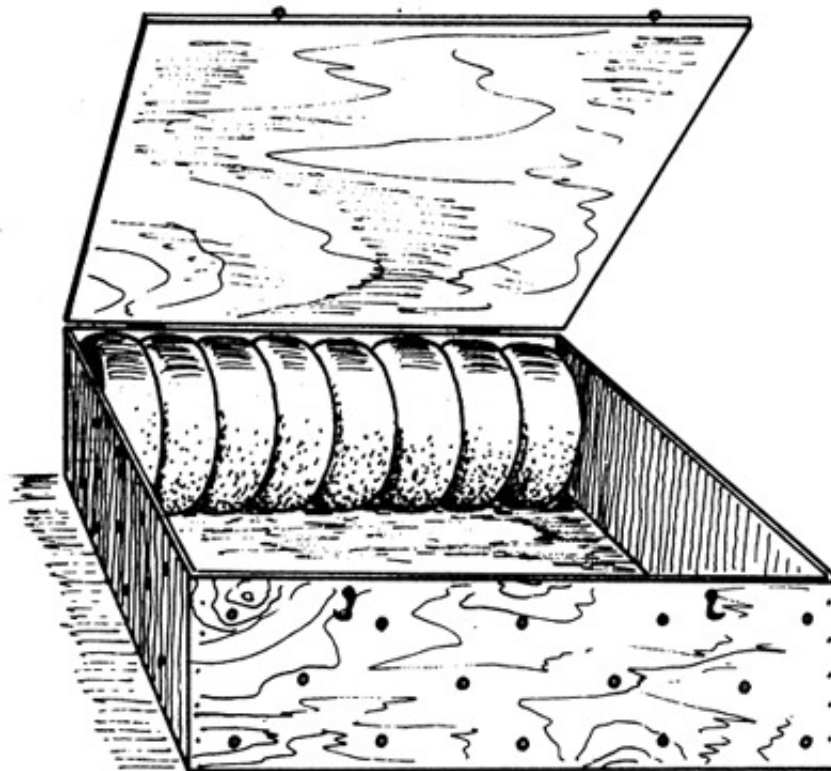

Wooden cheese boxes

V ADDITIONAL EQUIPMENT

An important component in a dairy processing unit, is the laboratory.

Laboratory equipment should include the following:

- **To measure milk density:**

Two or three lactodensitometers with glass cylinders

- **To test milk acidity:**

A Dornic acidimeter and the accessories shown below.

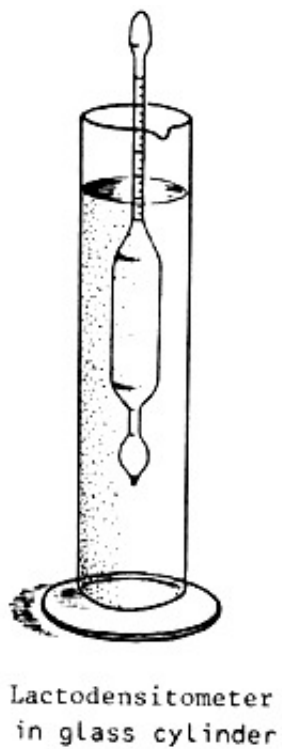

Dropper



Glass
beaker



Reagents

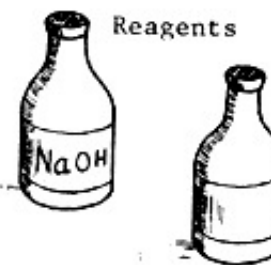

Pipette

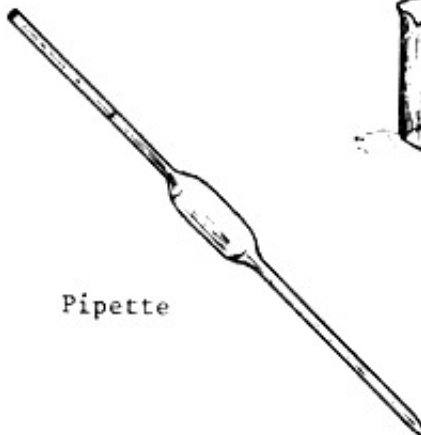

Dornic acidimeter
with NaOH $\frac{N}{9}$ solution



Salut acidimeter used for selective testing of milk acidity immediately after reception of

farmers' milk

- **Fat content of milk**



Butyrometer

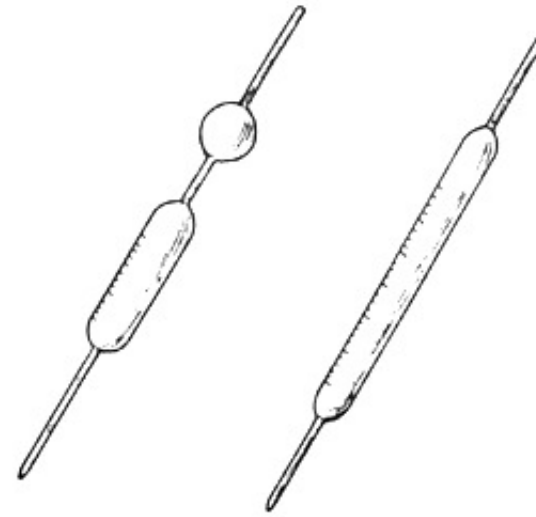

Pipettes

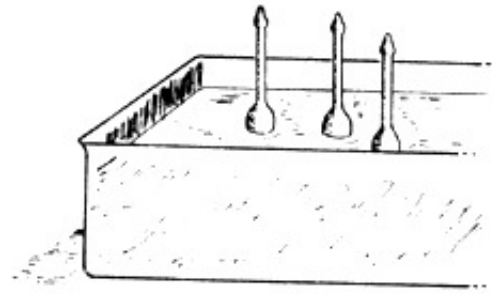

Water bath



Manual centrifuge



Reagents

• Preparation of cultures

To prepare mesophilic cultures for cheese-making or thermophilic cultures for yoghurt-making, a strain of starter culture is initially required. Culturing and sub-culturing is done in individual 5, 10 and 15 litre containers.



Part 3

ORGANIZATION AND OPERATION OF THE MILK PROCESSING UNIT

I MILK COLLECTION

A village milk processing unit usually involves a group of milk producers living within a given area near the unit. It is therefore reasonable that the majority of the producers will deliver their own milk in the morning direct to the processing unit. The milk from the evening milking is retained by the family for home consumption.

For producers who live further away or small farmers who do not wish to make the trip with a small quantity of milk, collection can be arranged within a radius of no more than 10 kilometres.

A milk collector on a bicycle picks up the milk at collection points, which are simple shelters within which the milk can be kept in the shade.

Village milk processing

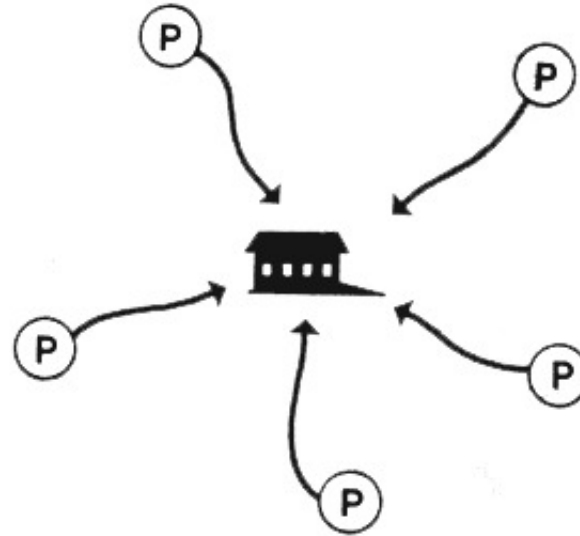

P = Producer

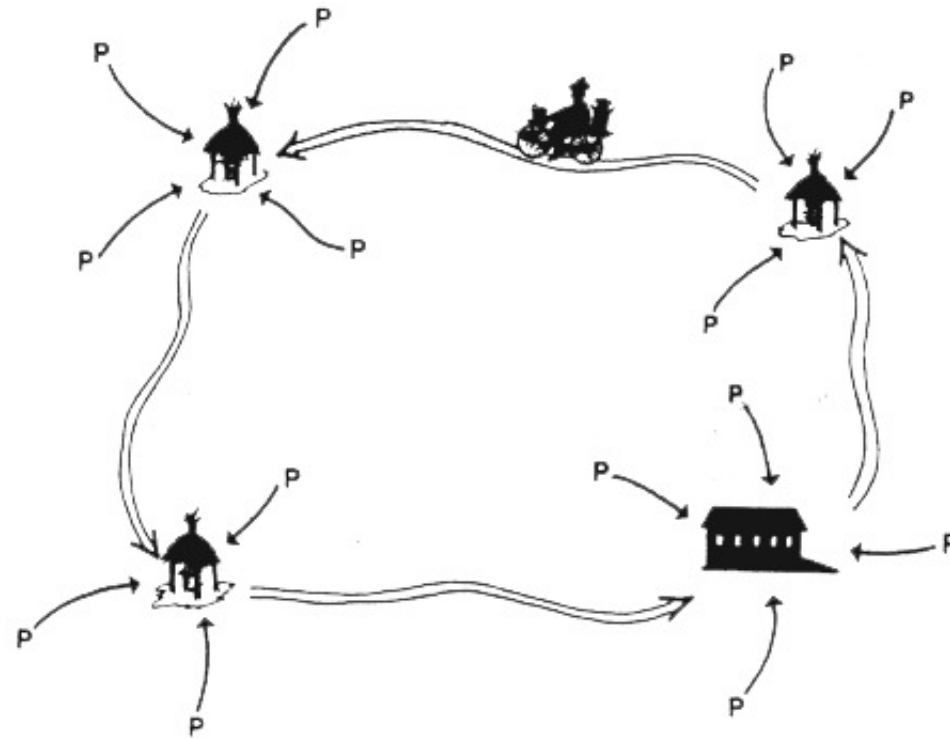

THE MILK COLLECTION POINT

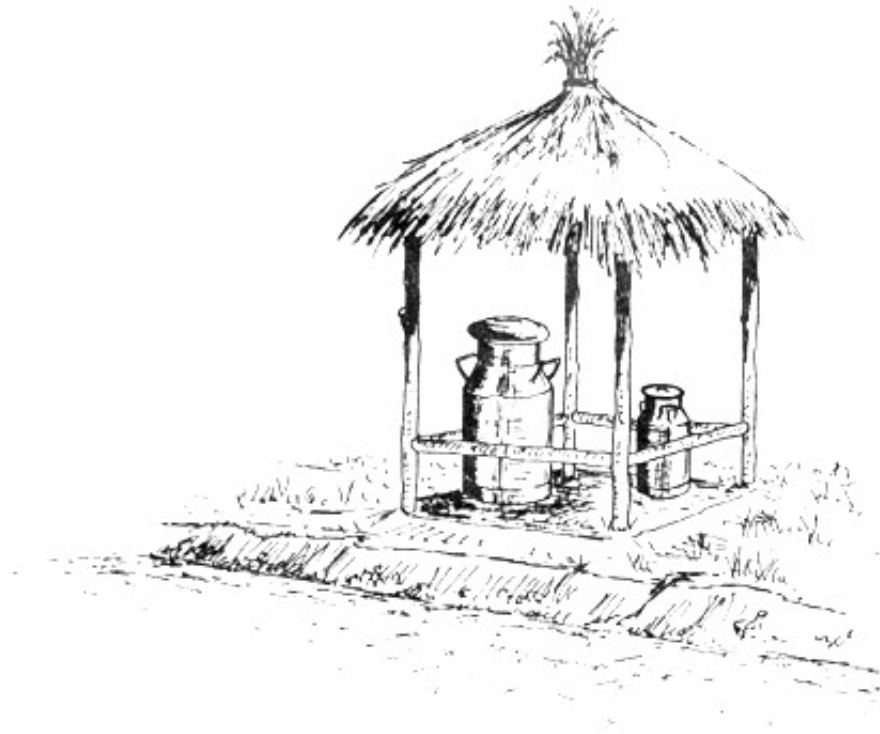

At the milk collection point, the milk collector tests milk density with the lactodensitometer, tests milk acidity, and measures milk volume using a measuring can. The milk is then filtered and poured into the milk can.

The entire milk collection round should take no longer than two hours.

The milk collector has a little notebook in which he enters the volume and density of the milk delivered by the producer. Payments for the milk are made twice a month.

The person responsible for milk collection may either be paid by the village cheese unit or by

the producers themselves. For purposes of simplification, the second choice is preferable.

II MILK RECEPTION

Reception of the milk delivered by the farmers themselves or by the collector should take place in the very early morning.

The producers' milk is weighed, density checked, the milk filtered, and then poured into milk pails.



Weighing milk

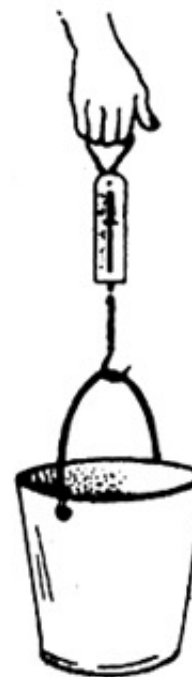

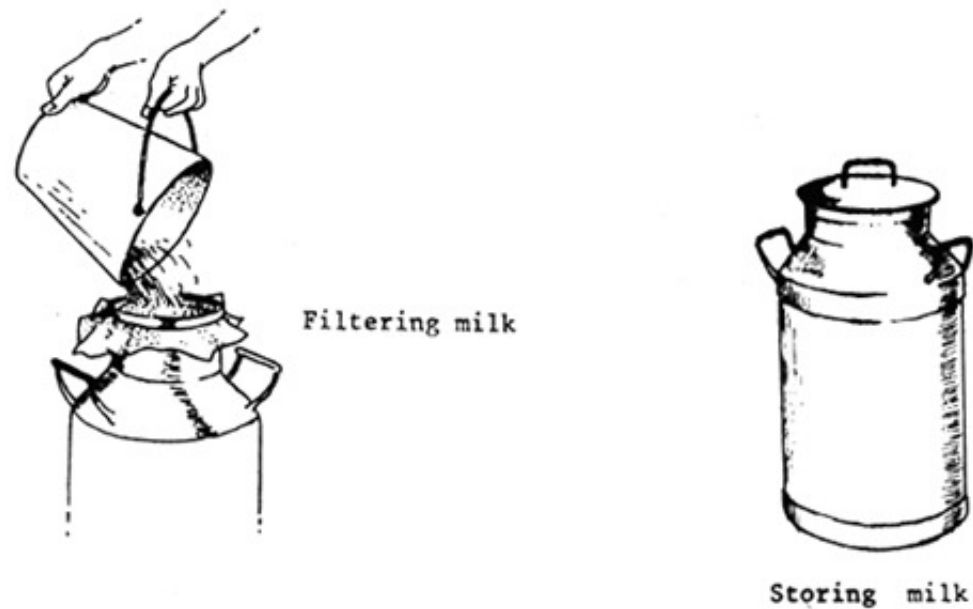

Milk density is measured as shown in the diagram below:

- **the producer's milk sample is poured slowly into a test-tube to avoid foaming;**
- **the lactodensitometer is introduced into the test-tube and, once the level is steady, the number is read:**

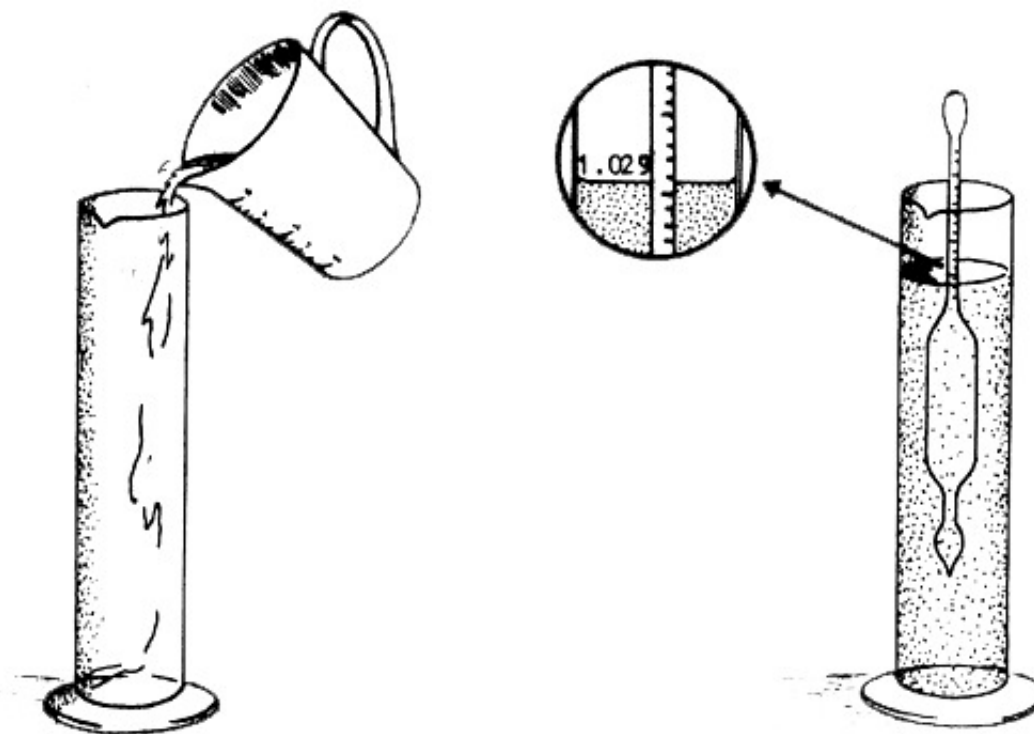

Interpretation of readings

For cow's milk an approximate estimation of density can be read as follows:

Lactodensitometer reading	Result
1.028 to 1.033	Normal milk
less than 1.028	Diluted milk
1.033 to 1.037	Skimmed milk

III MILK STANDARDIZATION

When milk from all the producers has been poured into the milk cans, a sample is taken from

each can and mixed together to obtain an average sample. This sample is tested for milk acidity and fat content.

1. Milk Acidity

Put 10 ml of the milk sample into a glass.

Add 3 to 4 drops of phenol-phthalein.

With the dropper, add the $\text{NaOH } \frac{N}{9}$ solution drop-by-drop into the glass until a stable pink colour results.

Read on the graduated column the number of ml used. This gives the acidity of the milk in Dornic degrees.

EXAMPLE: 15 ml of $\text{NaOH } \frac{N}{9}$ = 15 DORNIC DEGREES

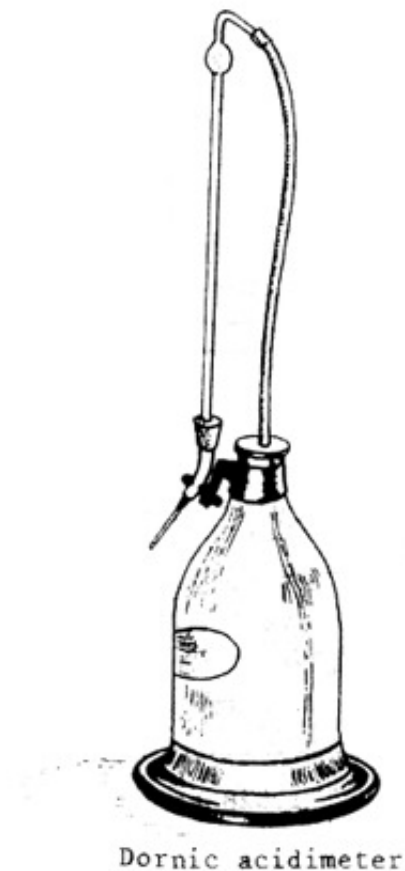
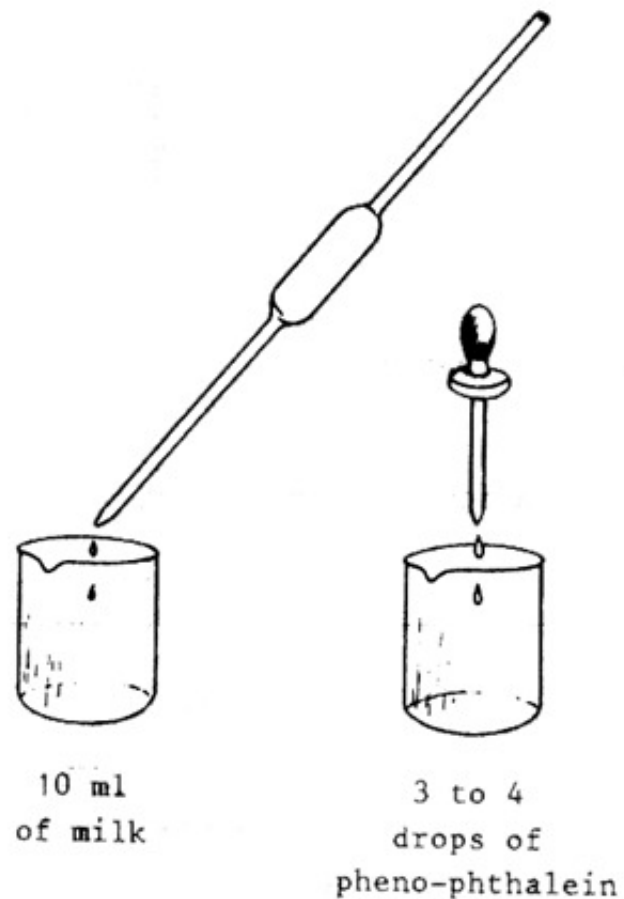

- 1°D is 1 mg of lactic acid in 10 ml of milk or 0.1 g/l

2. Fat Content

1. Put 10 ml of sulphuric acid in the butyrometer.
2. Add 11 ml of milk from the average sample.
3. Add 1 ml of amyl alcohol.

4. **Shake the butyrometer to dissolve the milk elements.**
5. **Put the butyrometers in the centrifuge. Centrifuging should continue five minutes.**
6. **Next plunge the butyrometers vertically, cork down, into a water bath, temperature 65°–70° C, and leave them for five minutes.**
7. **The butyrometer, cork down, should be perfectly vertical when taking the reading at eye level. Read the graduation mark at the base of the meniscus, i.e. at the base of the curved upper surface of the fat column. In the example that follows, the degree reading is 3.6. The milk fat content then is 3.6 percent, or 36 g of fat per litre of milk.**

The different stages of this test are illustrated on the following page.

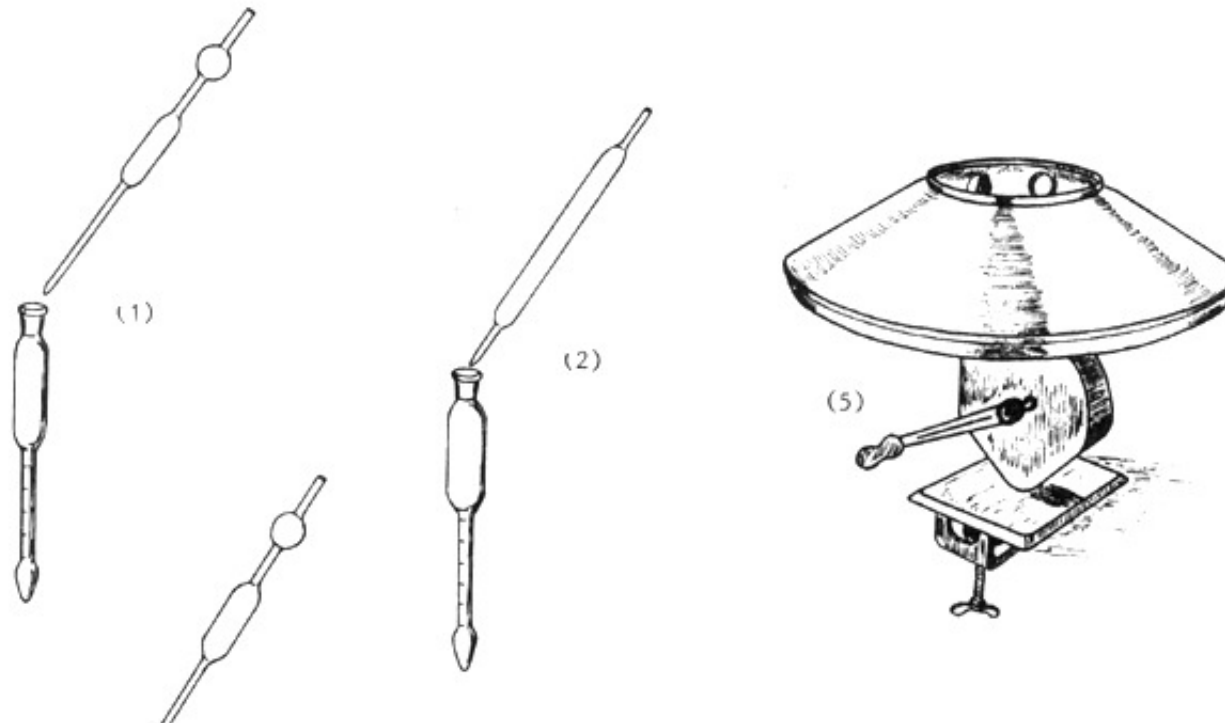

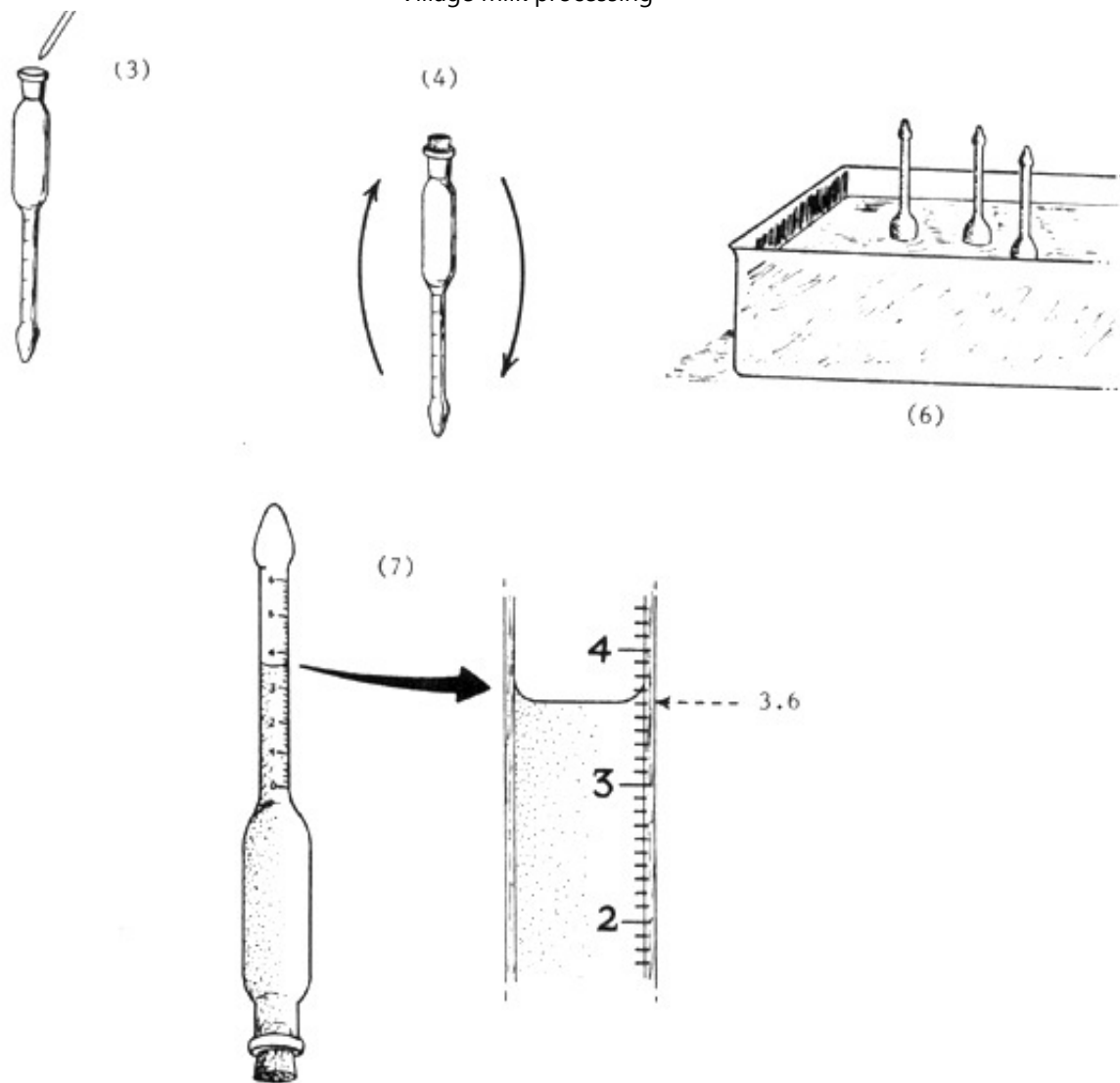

The laboratory will then enter the results in the milk analysis notebook.

“THE VILLAGE DAIRY”

Laboratory

Date	Quantity of milk received (litres)	Milk acidity	Average fat content %	Observation
12 February	385	22°D	3.6	-
13 February	405	21°D	3.7	-
14 February	395	21°D	3.6	-
15 February	372	22°D	3.8	-
16 February	387	20°D	3.7	-
17 February	384	21°D	3.9	-

We know therefore that on 17 February, for example, the dairy received 384 litres of milk with a butterfat content of 3.9 percent. In making Edam cheese, for example, milk with a fat content of 2.6 percent is required. By standardization, the fat content can be reduced from 3.9 percent to 2.6 percent. In order to do this, the amount should be calculated of the milk required to be skimmed and remixed with the milk received to bring the butterfat content to the desired amount.

3. Calculation for milk standardization: Pearson square method

The desired percentage of butterfat is written in the centre of the square and, in the two left-hand corners, the percentages of butterfat in the available ingredients.

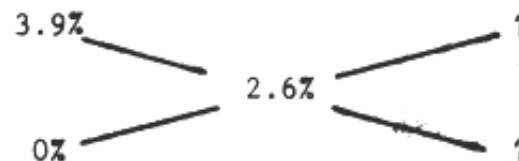

0 percent is the fat content of the skimmed milk.

3.9 percent is the fat content of the milk received. Subtraction along the diagonals will give

two values representing, respectively, the amounts of the ingredients to be used.

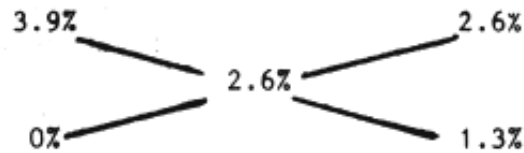

Thus by blending 2.6 litres of milk with a 3.9 percent fat content and 1.3 litres of skimmed milk with zero fat content, 3.9 litres of milk with a 2.6 percent fat content is obtained.

Assuming reception of 384 litres of milk on 17 February, with an average fat content of 3.9 percent, it would be necessary to skim:

$$\frac{384}{3.9} = 98 \text{ litres}$$

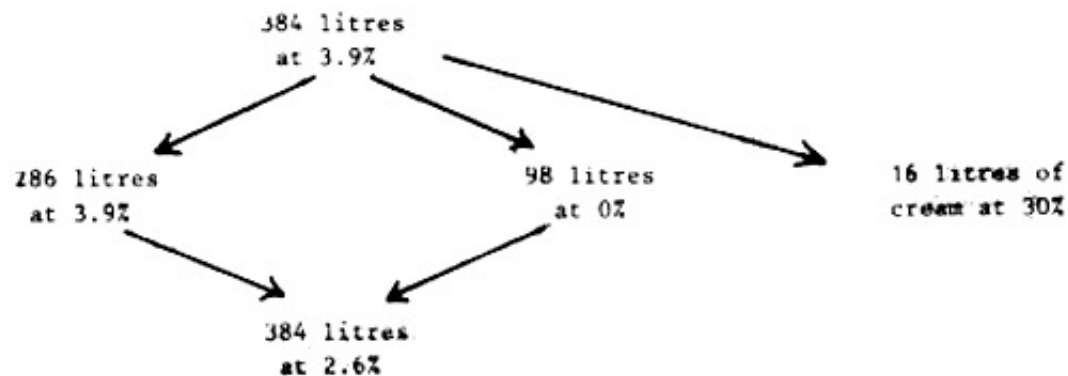

A hand-operated separator with an hourly capacity of 60–200 litres may be used for milk standardization.

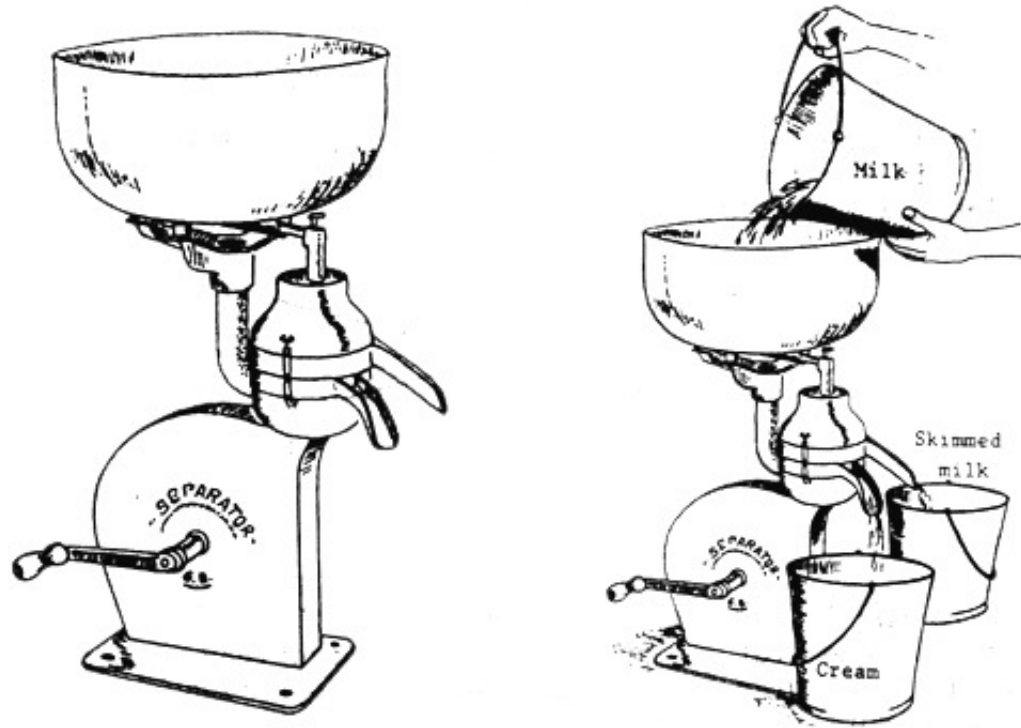

Approximately 100 litres of milk (98 litres, to be exact) are skimmed to provide 16 litres of cream, as shown in the above illustration.

IV HEAT-TREATMENT OF MILK

Heat-treatment of milk is a most important factor in the quality of the finished product.

After standardization, milk must be heat-treated. This means bringing it to a minimum temperature of 63°C for 30 minutes.

The various equipment suggested for heat-treatment can bring the temperature up to 63°C from between 40 to 60 minutes.

The diagram shows the heat-treatment profile:

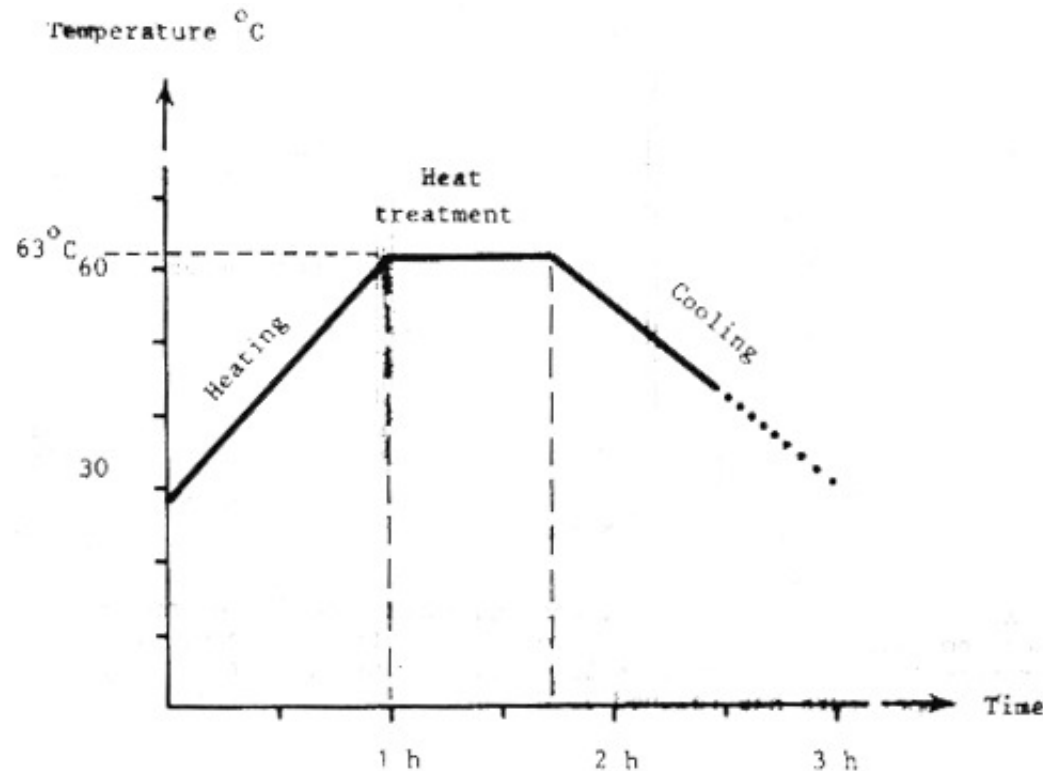

The milk must be constantly stirred to maintain a homogeneous temperature throughout the heating and heat-treatment stages. The milk stirrer and the thermometer are important items of equipment.

V COOLING MILK

When the milk has been kept at a temperature of 63°C for 30 minutes, it is then cooled down to bring it to a suitable temperature for cheese-making (approximately 35°C).

The milk is cooled either by immersing the milk cans in a tank with cold running water, or by

running cold water through the double sides of the cheese vat.

During the cooling, as during the heating period, the milk must be stirred constantly.

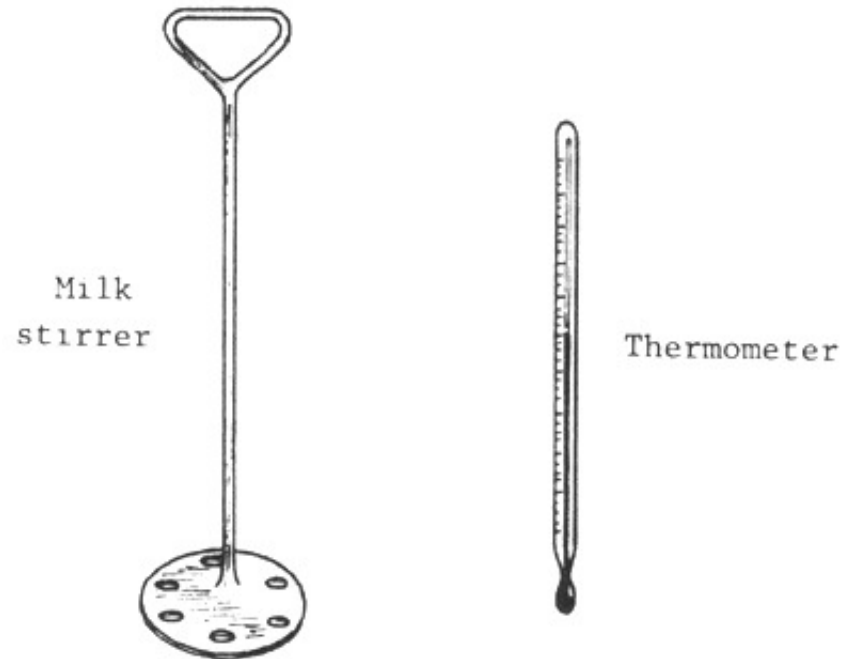

Bearing in mind heat losses, cooling water should be shut off before the desired milk temperature is reached. For instance, if the milk temperature for cheese-making is 32°C, cooling water must be shut off when the milk temperature has reached 35°C.

VI PROCESSING AIDS

1. Preparation of starter cultures

One person only must be responsible for the preparation of starter cultures.

The simple method for preparing starter cultures is illustrated.

The preparation of the starter cultures requires suitable strains of bacteria and a milk of good bacteriological quality.

The starter culture used should be a commercial lyophilized one. These strains keep relatively well and it is, therefore, advisable to maintain a three-months' supply.

Following the heat-treatment of milk for cheese-making, a certain amount of milk for the preparation of the starter culture is retained in the milk can or in the jacketed vat in order to maintain the heat-treatment of 63°C for an additional 15–30 minutes. The milk is then poured into one-litre bottles and into a 5-litre container and covered with a clean cloth.

a) Imported lyophilized starter culture

The contents of the vial are poured into a bottle of milk and shaken well to mix the powder and milk together.

b) Mother culture

In order to avoid contamination by air, both the bottle containing the mother culture and the 5-litre container of starter culture are placed in a small wooden cupboard.

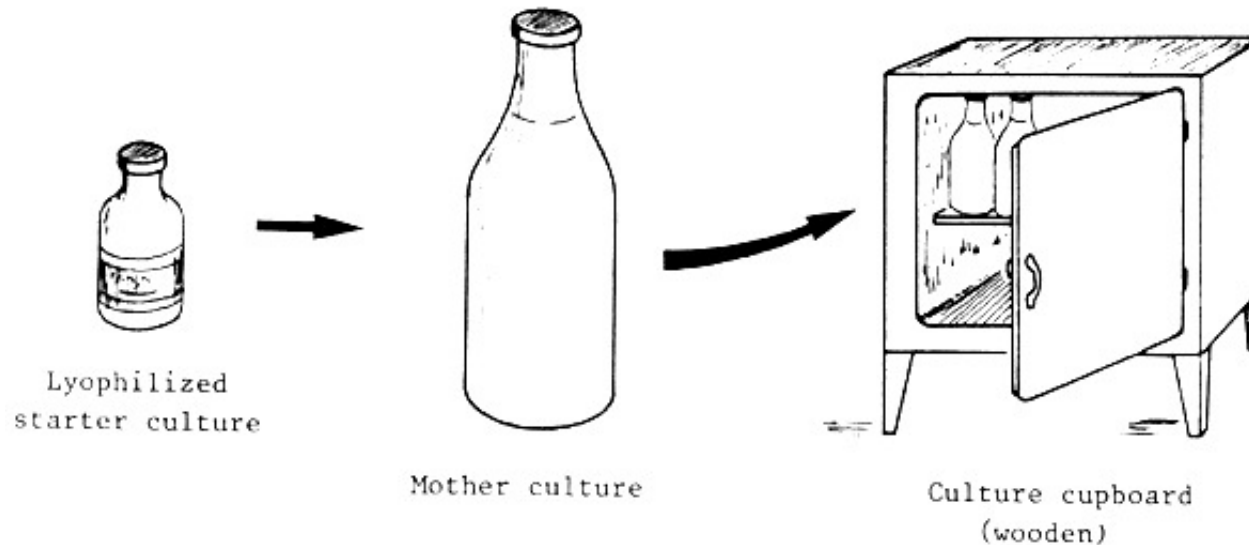

c) Starter culture for cheese-making

The mother culture to be used for cheese-making (mesophilic culture) is placed in the culture cupboard.

The incubation temperature should be 20 – 22°C for 15–16 hours.

The acidity of the mother culture will then be 80 to 90°D. Use the mother culture to inoculate, at 2 percent, a second mother culture and 5 litres of milk for cheese-making.

The preparation of starter cultures for cheese-making is shown below.

PREPARATION OF STARTER CULTURES

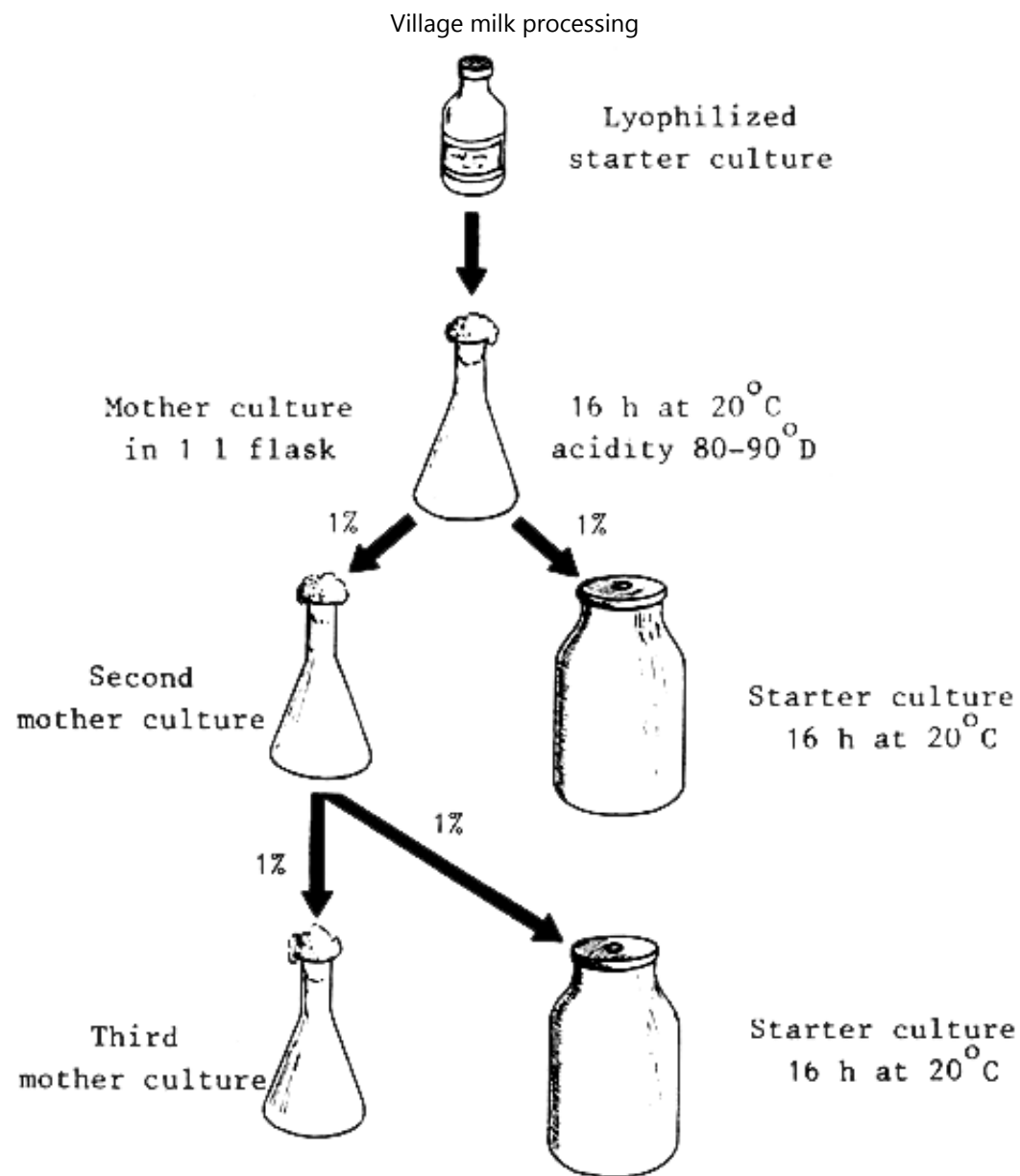

If the starter cultures are prepared with great care, one strain of commercial culture may be used for one to two months by means of successive subculturings.

d) Yoghurt-making cultures

Starter cultures for yoghurt-making are thermophilic bacteria. They must be cultured therefore at a temperature of 40 – 45°C for three to four hours.

After heat treatment of the milk to which the yoghurt bacteria are to be added, the milk is cooled to 45°C and then poured into 1 litre bottles. These are then set into a water tank at 45°C to stabilize the bottled milk temperature.

The lyophilized commercial strain for yoghurt-making is then put into the bottles.

The bottles of milk are left in the water bath at 45°C for three to four hours.

The preparation of cultures for yoghurt-making is shown below.

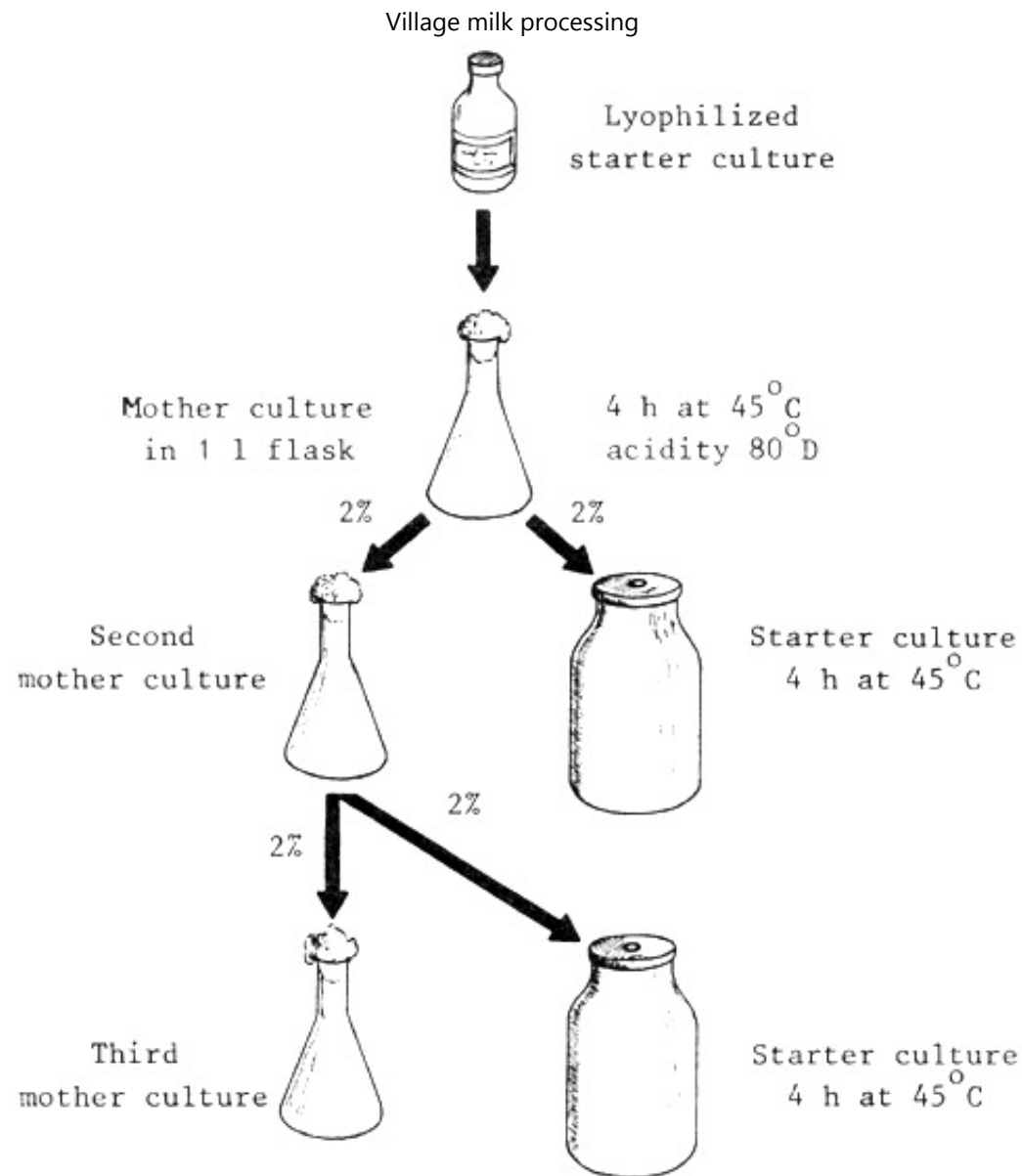

2. Preparation of rennet

Rennet, like starter cultures, may be imported. However, unlike commercial starter strains,

rennet can be made locally. Since laboratory equipment is needed for making rennet, it should therefore be undertaken with the advice of a laboratory in the capital city - that for example of a university.

a) Obtaining abomasa

Abomasa should be obtained from preferably unweaned calves.

Assuming that the annual amount of calf rennet to be obtained is some 120 litres of liquid rennet at a strength of 1/10 000 and a yield of approximately 2 abosama for 1 litre of rennet, 240 abosama will be required per annum.

b) Preparation of abosama

The abosama should be washed and the fat and veins removed.

The abosama are then inflated with air to avoid the two sides touching. They are then ball-shaped, the neck and the base being tied with string.

The inflated abosama are hung in a dry, well-ventilated area. Drying should be complete after approximately one month of storage. At this stage, the flattened abosama can be kept in a dry place for a long period without signs of deterioration (about one year).

c) Soaking

When required for use, the abosamum should be sliced into thin strips, 5 mm wide.

In an-easy-to-clean basin of plastic or stainless steel, soak the strips of abosamum in a 10

percent sodium chloride (salt) and 1 percent sodium benzoate solution.

To produce a three months' batch of 30 litres of rennet, 60 abosama should be soaked in 40 litres of this brine solution.

The pH of the solution is adjusted to 4.3 with benzoic acid, after soaking for 24 hours at a temperature of from 20 to 25°C. Pour the liquid off into a container. In the same soaking basin and keeping the same abosama strips, the brine solution may be renewed four to five times before the properties of the abosama strips are completely exhausted.

Each extract obtained in this fashion is treated as described above and the first and most concentrated extract is used to standardize the strength of the rennet.

d) Treatment of the liquid

To eliminate the mucilage in suspension in the extract, the solution is reacidified with hydrochloric acid to a pH of 4.8, and allowed to settle for two hours.

The pH of the extract is raised with disodium phosphate to pH 5.5 – 5.6.

Vigorous stirring must accompany these two actions. The liquid is then filtered over Watmann paper. Filtration may take a long time and probably will require distribution of the extract over several filters.

The crude rennet extract obtained is generally a golden-yellow colour.

e) Determination of strength

Definition: Rennet strength is the number of volumes of coagulated milk clotted by one volume of rennet in 40 minutes at 35°C.

If “v” equals one volume of rennet, and “V” one volume of milk and measuring the clotting time in seconds, the calculation is:

$$s = \frac{2400 \ v}{Tv}$$

In practice, liquid rennet strength should be 1/10 000 (1 litre of rennet clots 10 000 litres of milk at 35°C in 40 minutes).

Method

Put 500 ml of fresh milk in an Erlenmeyer flask and plunge it in a water bath at 35°C.

Remove 1 ml of the rennet to be standardized and dilute it in 10 ml of water.

When the milk in the Erlenmeyer flask reaches a constant temperature of 35°C, pour 10 ml of diluted rennet, stirring constantly, and start the timer. Keeping the Erlenmeyer flask in the water bath, slant it while rotating it gently so that a film of milk is formed on the sides of the flask. When the liquid begins to flocculate, stop the timer.

Rennet strength: $s = \frac{2400 \times 500 \text{ cc}}{T \times 1 \text{ cc}}$

If flocculation time is 60 seconds, for example, rennet strength will be:

$$s = \frac{2400 \times 500}{60 \times 1}$$

$$S = 20\ 000$$

f) Standardization

The strength of the four or five different batches, obtained by successive extractions of the rennet from the abosama is determined, thus enabling the rennet to be readjusted to a strength of 1/10 000.

For example, if 30 litres at a strength of 1/20 000 have been obtained, and the extract from the four preceding rennet mixtures gave a solution at a strength of 1/5 000, the volume of rennet at strength 1/5 000 required to prepare standard rennet at a strength of 1/10 000 is determined in the following way:

$$30\ \text{litres} \times 20\ 000\ \text{units} + \text{“Y” litres} \times 5\ 000\ \text{units} = (30 + Y)\ \text{litres} \times 10\ 000\ \text{units}$$

$$600\ 000\ \text{units} + 5\ 000\ Y = 300\ 000 + 10\ 000\ Y$$

$$Y = 60\ \text{litres.}$$

After mixing the two extracts, 90 litres of rennet will be obtained at a strength of 1/10 000.

g) Maintenance-storage

Rennet must be stored in opaque glass bottles or in dark (blue or black-tinted) plastic containers and placed in cold storage at a temperature of 5 to 7°C. Under these storage conditions, the rennet will remain active for three months.

h) Renneting the milk

It is recommended that coagulation tests be made first on small volumes of the cheese-milk. This is to redefine the amounts of rennet to use in order to obtain the same coagulation time as obtained previously with powdered rennet of 1/100 000 strength.

Rennet preparation is illustrated on the following page.

Preparation of rennet

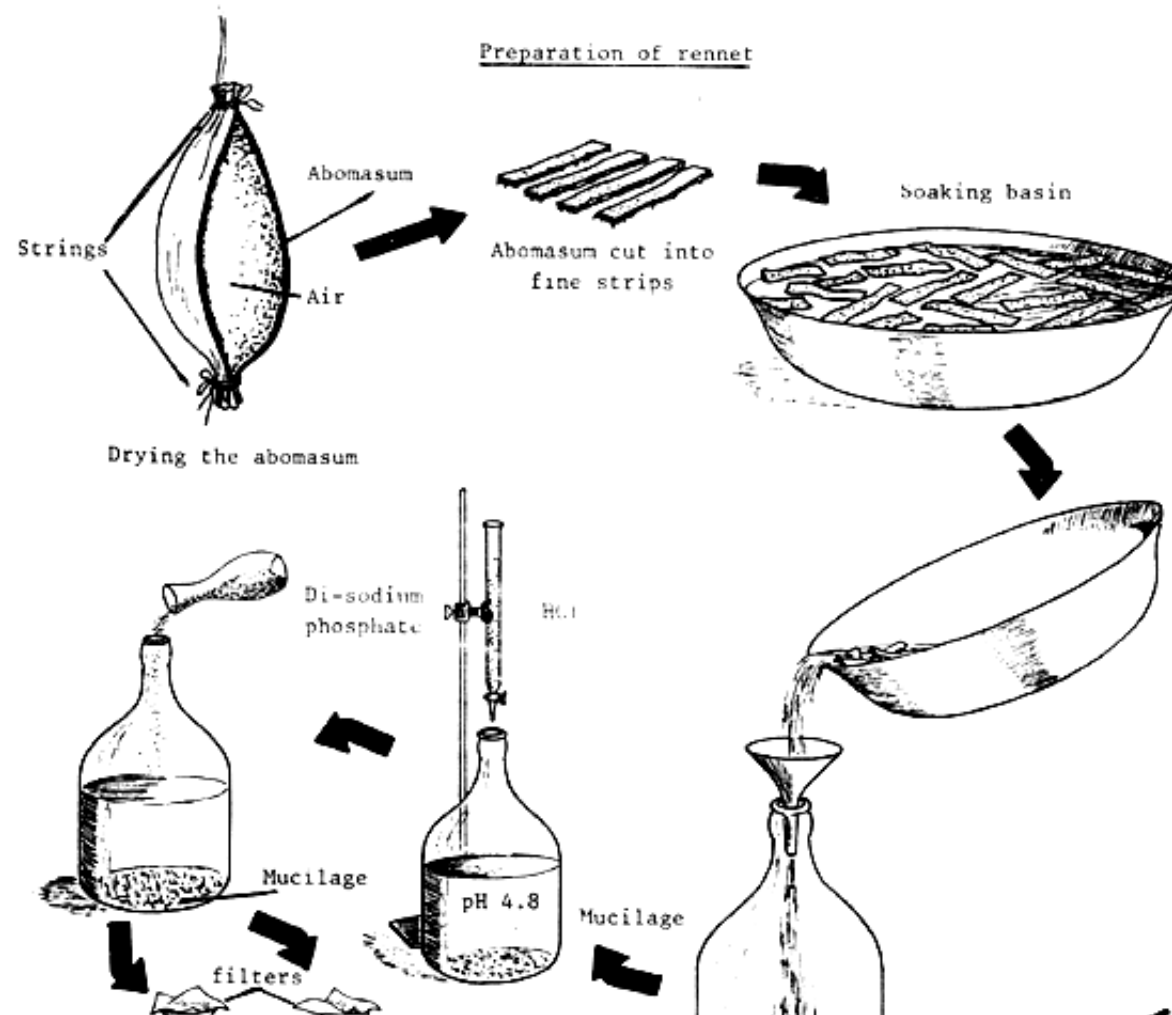

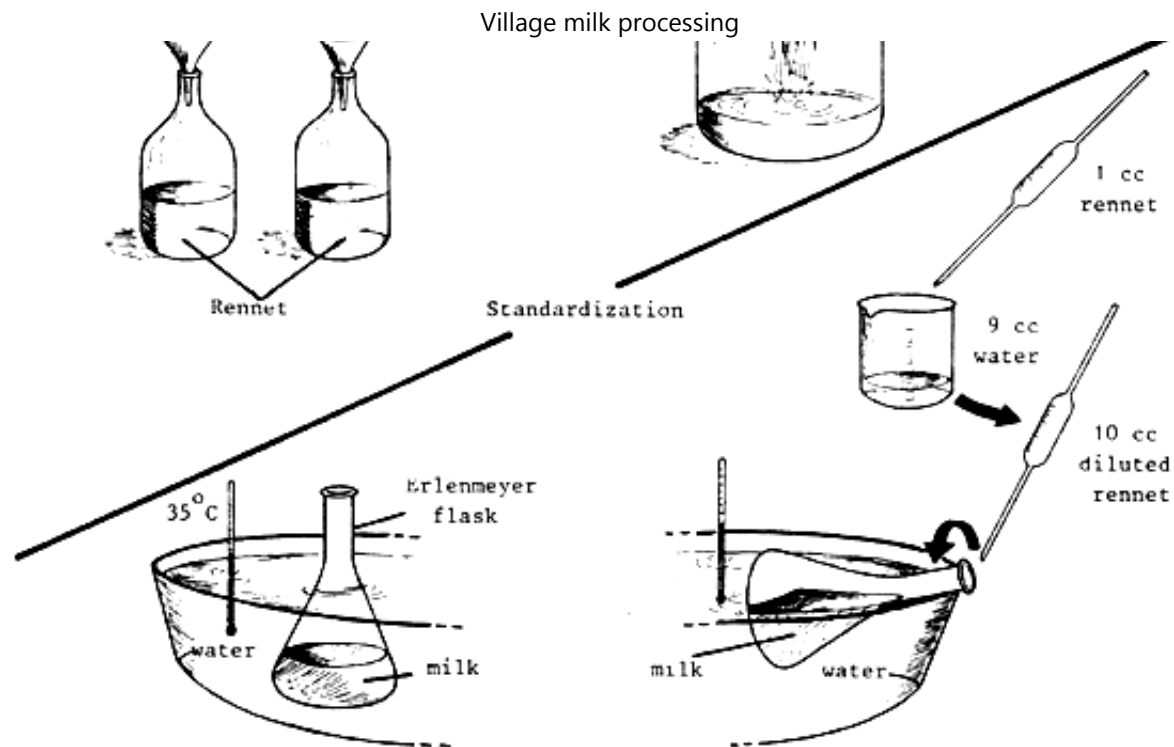

Part 4

APPROPRIATE TECHNOLOGY FOR THE MANUFACTURE OF DAIRY PRODUCTS

I CHEESE

The following cheese-making operations are for making a firm-bodied cheese (Saint Paulin or

Gouda type), a cheese most often produced in the developing countries and one which is relatively easily made to standard.

The various steps of the cheese-making process should be adapted to climate, equipment available and consumer preferences.

Steps in making a “Saint-Paulin/Gouda” type cheese

Equipment

- Hand-operated separator

- One vat for pasteurization and cheese-making

Operation

Reception - Filtering



Standardization



Pasteurization (63°C for 30 minutes)



Cooling (32 – 35°C)



Inoculation (rennet; starter culture; calcium chloride)



Cutting the coagulum and stirring



Drawing off part of the whey

Village milk processing



Addition of water or brine



Second stirring



Moulding



Pressing (1 to 5 hours)



Salting in brine



Turning and ripening (at least 2 weeks)

- Moulding table
- Press
- Brining tray
- Ripening cellar

The producers' milk is first filtered and then poured into the one-step “pasteurization/cheese-making vat”. After filtering, a portion of the milk is passed through the separator to remove the required amount of cream.

The milk used for cheese-making is standardized to a level of fat content of some 26 g/l. The separator can be a source of contamination, and it is therefore preferable to standardize before pasteurization rather than after.

The milk is pasteurized at low temperature in the double-walled vat at some 63°C for about 30

minutes. The source of heat can be gas or electricity or even fuelwood. The milk is then cooled to a temperature of 32–35°C by circulating cold water through the jacket of the vat.

The lactic acid bacteria should be added at a rate of 1 to 2 litres per 100 litres of milk 15 to 20 minutes before renneting.

The rennet (at a strength of 1/10 000) is added at a rate of 20 – 25 ml of rennet per 100 litres of milk. This is the time to add, if necessary, calcium chloride (5–50 g per 100 litres of milk).

Following this, flocculation time is from 10 to 15 minutes, and total clotting time is from 15 to 40 minutes.

The curd is cut into regular grain-sized pieces. The first stirring should be carried out with both the curd grains and the whey, and should last from 5 to 10 minutes.

Drawing off the whey (lactose removal) consists of extraction of a portion of the whey (from 20 to 60 percent), followed by the addition of an equal amount of water at a temperature of 30 to 35°C.

Potassium nitrate may be added at this stage of the cheese-making process.

The second stirring, with moderate shaking of the curd grains in the diluted whey, lasts 10 to 20 minutes.

The curd and some whey are then put into cloth-covered moulds. These moulds may be made of wood, stainless steel or plastic.

Mechanical pressing lasts from 1 to 6 hours. During this operation, the cheese mould will be

turned over 2 to 4 times.

The cheese is salted in saturated brine at a temperature of 10 to 14°C. Brining time varies according to the volume of cheese. A Saint-Paulin cheese weighing from 1.5 to 2 kg and with a diameter of 20 cm, is salted for about 8 hours.

Working out the curd lasts 2 to 3 days, at a temperature of 10 to 12°C and a humidity rate of 80 to 85 percent.

The cheese is placed on wooden shelves to ripen for at least 15 days at a temperature of 10 to 16°C with a humidity rate of 90 to 95 percent.

Prior to sale, the cheese can be covered with a protective film of wax.

If the cheese processing unit produces very large cheeses, they should be cut into 100 – 200 g slices prior to sale, and wrapped in greaseproof paper.

II CREAM AND BUTTER

a) When standardized milk is used to make cheese, there will inevitably be excess fat in the form of cream.

Often it is advantageous for the cheese unit to sell this surplus fat as fresh or acidified cream, both of which are more profitable than butter. In rural areas, however, the market for cream is often quite small and the cheese unit is obliged to make butter, a product of longer shelf life.

b) If the cream is to be sold as it is, it should be pasteurized before packaging. Experience has shown that a pasteurization temperature of approximately 95 – 98°C for 30 seconds

destroys germs satisfactorily and inactivates enzymes while preserving the organoleptic qualities of the cream.

After pasteurization, the cream is packaged in plastic bags or tubs and kept in a refrigerator.

The fresh cream is usually sold with a fat content of about 40 percent.

Acidified cream is sold with a lower fat content - 30 – 35 percent.

c) To make butter, cream is cooled to the lowest possible temperature. The cream is then stored until enough is obtained to make into butter. Cream stored in this way acidifies automatically, after which it is churned.

After filling the churn, the following steps are taken:

- The churn is rotated at 25 – 35 revolutions per minute (rpm) for 5 minutes.**
- The churn is stopped and if necessary the gases released.**
- The butter is churned again at 25 – 35 rpm for 35 to 45 minutes.**
- The buttermilk is poured off into plastic pails.**
- The same amount of cold water as the amount of buttermilk which has been removed is added, and the mixture churned at 10 – 15 rpm for 5 minutes.**
- Water is drawn off.**
- Rotation at 10 – 15 rpm for 10 to 20 minutes.**

- **The butter is removed.**
- **The butter is worked with a butter worker for 5 minutes, compressed into a butter mould, and packaged in greaseproof paper. Alternatively, after working, it is placed in plastic tubs.**

The butter can, if required, be salted as it is worked.

This operation may be regarded as the standard butter-making process since a number of variations are possible. Non-acidified cream can be churned, in which case the product is called sweetcream butter. Some butter-makers wash the butter twice and in some cases the butter is not worked at all.

The larger butter units usually pasteurize the cream, followed by the re-inoculation with selected lactic starter cultures for ripening. This method produces a cultured butter commonly called lactic butter.

Diagram of lactic butter-making

Cream

Pasteurization

Cooling

Inoculation with lactic starter culture

Ripening

Churning

Washing

Working

Packaging

Storage and marketing.

III BUTTERMILK

Buttermilk is a by-product of the butter-making process. It is highly nourishing, hence the interest in promoting the product for human consumption.

Buttermilk quality depends greatly on the butter-making technique used.

Buttermilk can be packaged after only one filtration. It should be packaged in plastic bags.

Buttermilk can also be ripened. While the buttermilk is still in the pail, cheese-making starter cultures (approximately 2 percent) are added, and the product left overnight at room temperature before packaging.

IV YOGHURT

Steps in yoghurt-making are as follows:

Skimmed or standardized milk



Pasteurization



Cooling to 42 – 45°C



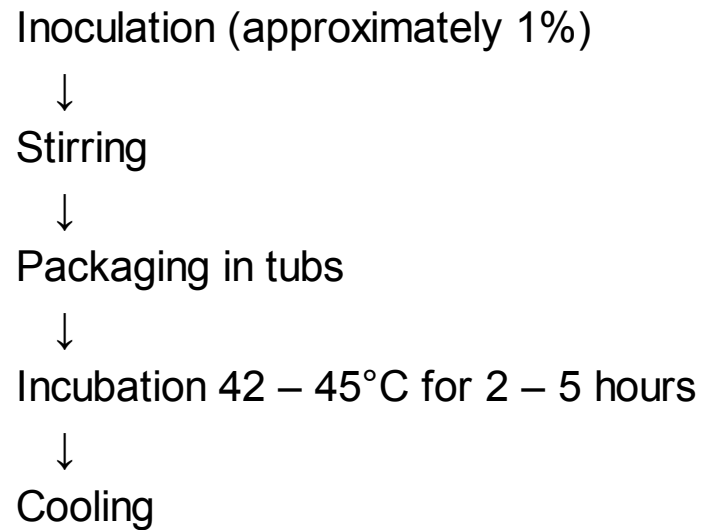

Pasteurization and cooling are done in the cheese vat, or in a pan for smaller quantities.

For yoghurt-making, the dairy unit needs to have a large refrigerator or small cold storage area - this also applies to cream and butter. Another essential investment item is an incubator, and perhaps a hand bottle-capper. Yoghurt is usually sold in plastic tubs or in cartons of 120 or 125 ml.

The yoghurt-making process increases the amount of cream available. Thus the decision to produce yoghurt should be preceded by a cost benefit analysis.

Another technique is to let the yoghurt clot in the vat. It is then stirred prior to packaging.

V FERMENTED MILK

The technology is very simple:

Standardization

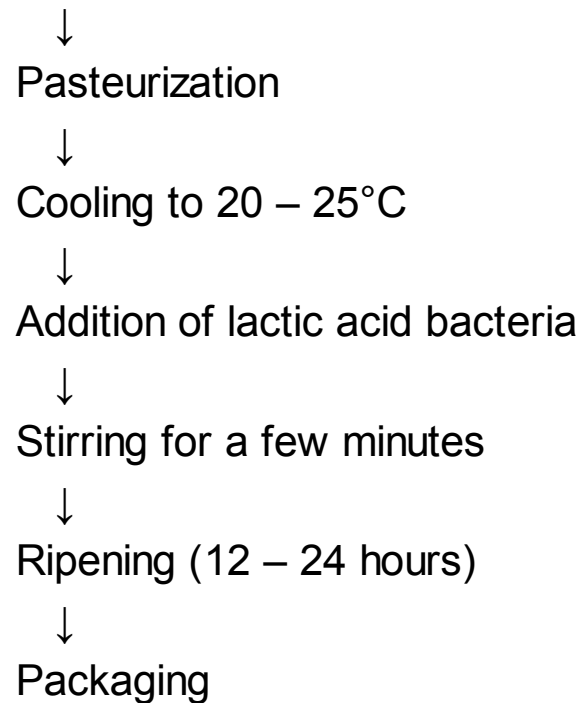

This technology corresponds to the traditional process, and the product is in demand as the base used in preparing “porridge”. The processing unit’s main consideration in this technique is that the milk is pasteurized and that both quality and hygienic standards are met.

Fermented milk being sold directly at the processing unit does not need to be packaged. The fermented milk is sold from the can, and is ladled into containers brought by local purchasers.

No specific equipment is required to make fermented milk. It is, however, advisable to allow for a large refrigerator.

VI PROCESSED CHEESE

Melting emulsification has traditionally facilitated the incorporation of sub-standard cheeses,

as well as cheese trimmings, into products for sale as processed cheese.

The usual presentation for processed cheese is as a spread, packaged in plastic rolls or aluminium-wrapped in bite-sized portions. While the latter requires costly equipment to mould and package the cheese, processed cheese spread in plastic rolls offers an attractive approach for small dairies where second-quality cheeses, or cheeses with a manufacturing defect are readily available.

The product can be packaged in glass or plastic tubs, or otherwise wrapped in aluminium.

Steps in processed-cheese making

Cheeses



Derinding or scraping



Cutting



Mixing



Addition of emulsifying salt



Cooking (10 min. of which 2 at 90°C; sometimes sterilization)



Cooling



Packaging when the cheese is still liquid



Final cooling.

Commercial processed cheese preparations are highly diversified, as it is possible to add a variety of ingredients: flavourings, mushrooms, nuts, meats, etc. Packaging while the cheese is liquid, allows great variety of shapes and weights in the finished product. No specific equipment is required to make processed cheese, the only indispensable item being a pot in which to melt the cheese.

VII WHEY FROM CHEESE-MAKING

The simplest solution is a feedback system to return this product to the milk producers or to industrial-scale pig farms.

The quantities available are usually not sufficient to justify processing the whey and using it for human consumption. However, the nutritional value of whey is such that it can be used as a drink or as raw material in making certain whey cheeses such as Mysost etc.

VIII CLEANING AND DISINFECTING OPERATIONS

Cleaning consists of removing all visible or invisible dirt from the surface. This surface can thus be described as clean.

Disinfection involves eliminating or killing micro-organisms.

Effective cleaning is absolutely essential for the equipment, installations and premises used for cheese-making, and the cheese-maker needs to pay special attention to this item.

After each use, all equipment and utensils: pails, cans, filters, pans, trays, tables, ladles etc., must be vigorously and meticulously cleaned. This is essential for successful cheese-making as the equipment is the main source of contamination by harmful germs. Simply rinsing with cold or lukewarm water is not sufficient. This is because a very thin film of residues or wastes from the clotting process sticks to the surfaces of the equipment which has come into contact with milk, whey or curd.

To eliminate these residues, an alkaline or acid detergent solution must be added accompanied either by vigorous brushing or agitation of the soaking solution to remove the residual film or wastes.

It is recommended that the equipment be soaked immediately after use in a vat filled with water.

Correct cleaning of dairy processing equipment should include the following operations:

- **Soaking the equipment in a vat filled with preferably warm water to help remove spots and stains;**
- **rinsing to remove any remaining spots and stains;**
- **brush cleaning with a hot water solution to which alkaline detergent has been added. An acid-based detergent should be alternated occasionally with the alkaline detergent, particularly in areas where the water used for washing is very hard;**
- **rinsing in chlorinated water to kill dangerous germs. With a glass 3/4 full of bleach (sodium hypochlorite solution) of 12° chlorine for every 10 litres of water, all germs can be destroyed by allowing adequate exposure time;**

- **the equipment and utensils are drained in a dust-free atmosphere to avoid contaminations.**

In remote parts of the country, it is sometimes difficult to find detergents. Where this is so, the utensils after cleaning can be dried in the sun to disinfect them.

IX ORGANIZATION OF WORK

The layout and design of the dairy unit should be planned in such a way as to allow those responsible for processing operations to work under the comfortable, safe and hygienic conditions.

Indicated below, as an example, are the times necessary for each operation involved in processing cheese from 150 litres of milk:

- | | |
|--|------------|
| • filtering, checking temperature, preparation of coagulation, renneting | 60 minutes |
| • moulding, turning | 80 minutes |
| • demoulding, salting, setting on trays | 60 minutes |
| • cleaning | 50 minutes |

To this total of approximately 4 hours, the time required for packaging, labelling and packing the cheese for sale should be added.

X LAYOUT OF THE UNIT

The dairy unit must be designed to provide a rational layout to allow the cheese-maker to work efficiently. The following diagrams show several floor plans for village cheese-making.

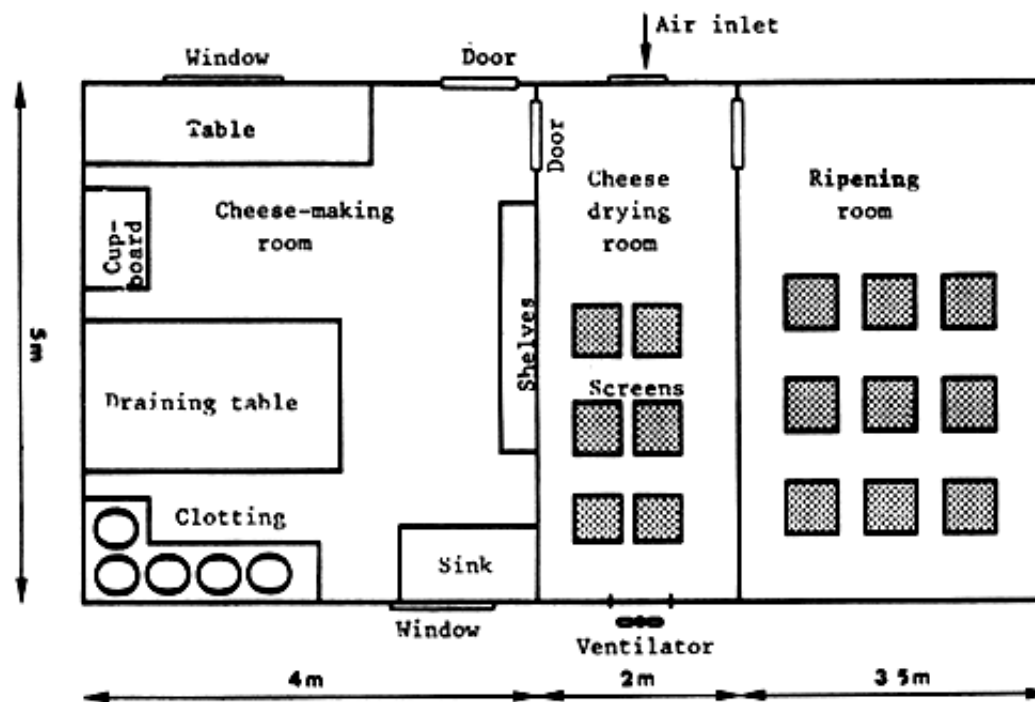
Plan No. 1

Cheese factory handling 500 litres of milk per day

Plan No. 2

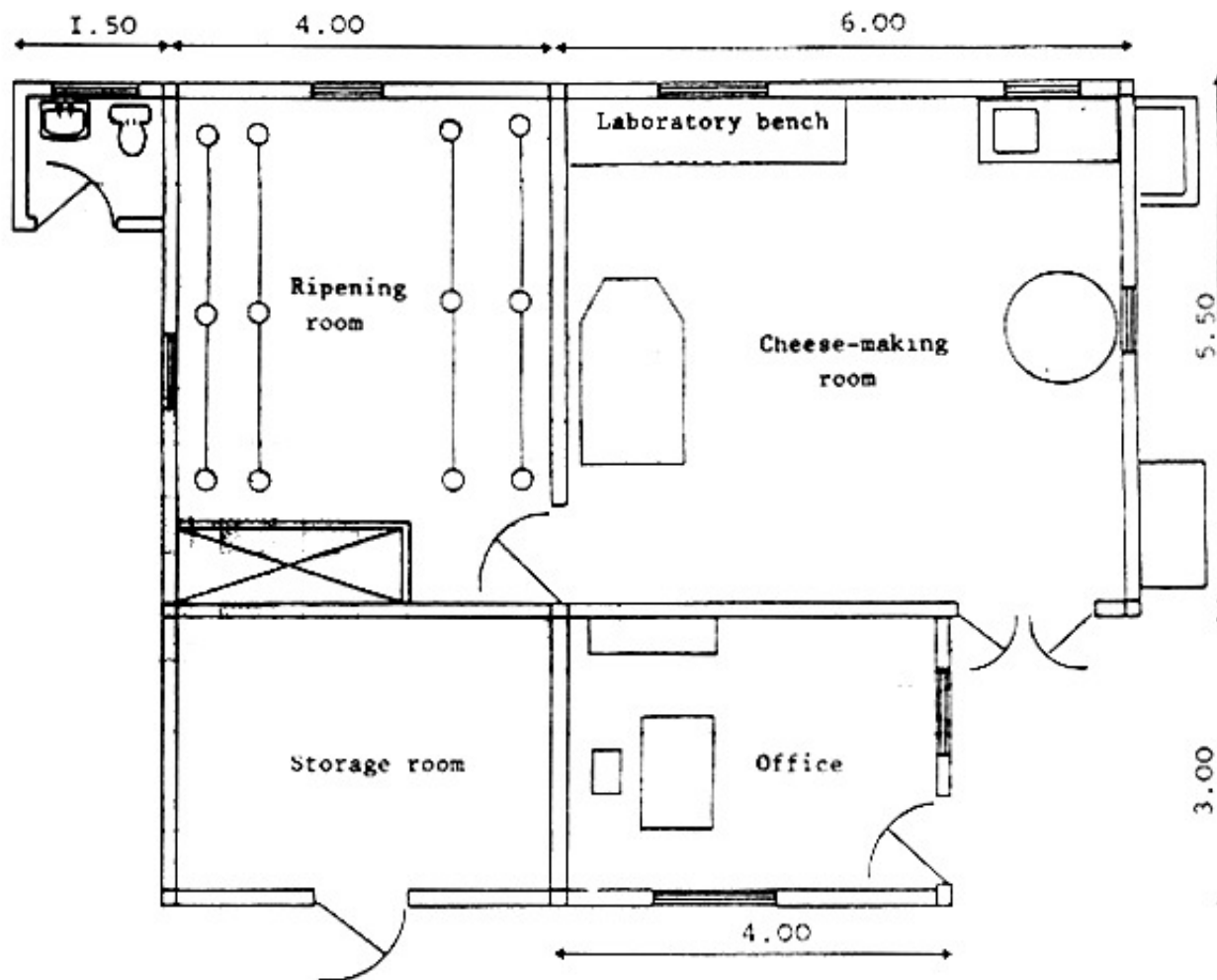

Cheese factory handling 600 litres of milk per day

Scale 1: 75

Cheese-making room : 33 sq.m

Ripening room : 22 sq.m.

Storage : 12 sq.m.

Office : 12 sq.m.

Plan No. 3

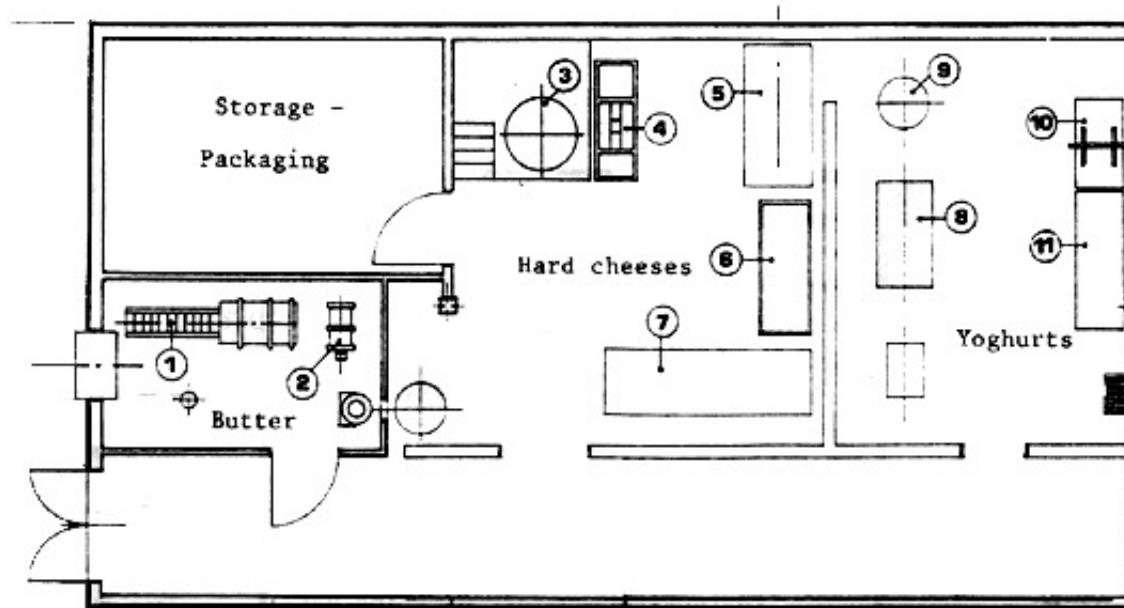

Legend

1. pressing, packaging butter
2. churn
3. cheese vat
4. clotting tank
5. moulding table
6. press
7. salting tank

8. draining table
9. fresh cheese vat
10. yoghurt filler
11. incubator

Plan No. 4

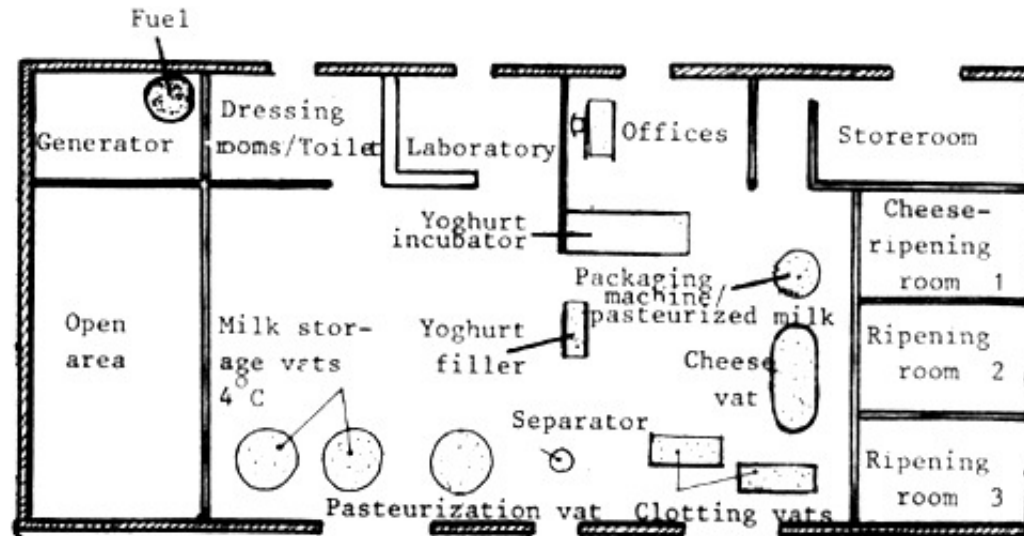

Dairy plant handling 2 000 litres per day



Part 5

ACCOUNTING AND EQUIPMENT COSTS

I ACCOUNTING

The keeping of accounts is of fundamental importance in knowing the cost price of the various finished products.

It is, therefore, essential to know each day the amounts of milk received and the products obtained.

1. Reception

For reception, the following data should be known.

“The village dairy”		
Date	Amounts of milk received	% of fat
12 February	385	3.6
13 February	405	3.7
14 February	395	3.6

2. Standardization

If the whole milk received at the dairy contains 40 g of fat per litre, and the milk for cheese-making has to be standardized to a fat content of 26 g per litre, the following balance is obtained:

$$\begin{array}{c}
 \text{Village milk processing} \\
 100 \text{ litres of milk at } 40 \text{ g/l} \\
 \hline
 \begin{array}{ccc}
 (x) \text{ litres of} & & (100 - x) \text{ litres} \\
 \text{milk at } 26 \text{ g/l} & + & \text{of cream at } 400 \text{ g/l}
 \end{array} \\
 \\
 100 \times 40 = 26x + 400(100 - x) \\
 4000 = 26x + 40000 - 400x \\
 374x = 36000 \\
 x = 96.25 \text{ litres.}
 \end{array}$$

Therefore, 100 litres of milk with a fat content of 40 g per litre will produce 96.25 litres of milk containing 26 g per litre of fat, and 3.75 litres of cream with a fat content of 400 g per litre.

3. Cheese-making

In the case of making a Gouda-type cheese, yield will be approximately 11 kg of cheese per 100 litres of milk.

According to the balance resulting from the standardization (see above), 96.25 litres of milk for cheese-making will give:

$$\frac{11 \times 96}{100} = 10.56 \text{ kg of cheese}$$

For butter, the yield is as follows. After standardization, 3.75 litres of cream at 400 g per litre are obtained. The total amount of fat content will be therefore: 1 500 g. The butter will have a fat content of 82 percent, and so the butter yield will be:

$$\frac{1\,500 \times 100}{82} = 1.8 \text{ kg of butter}$$

The breakdown, exclusively for butter and cheese-making, is therefore as follows:

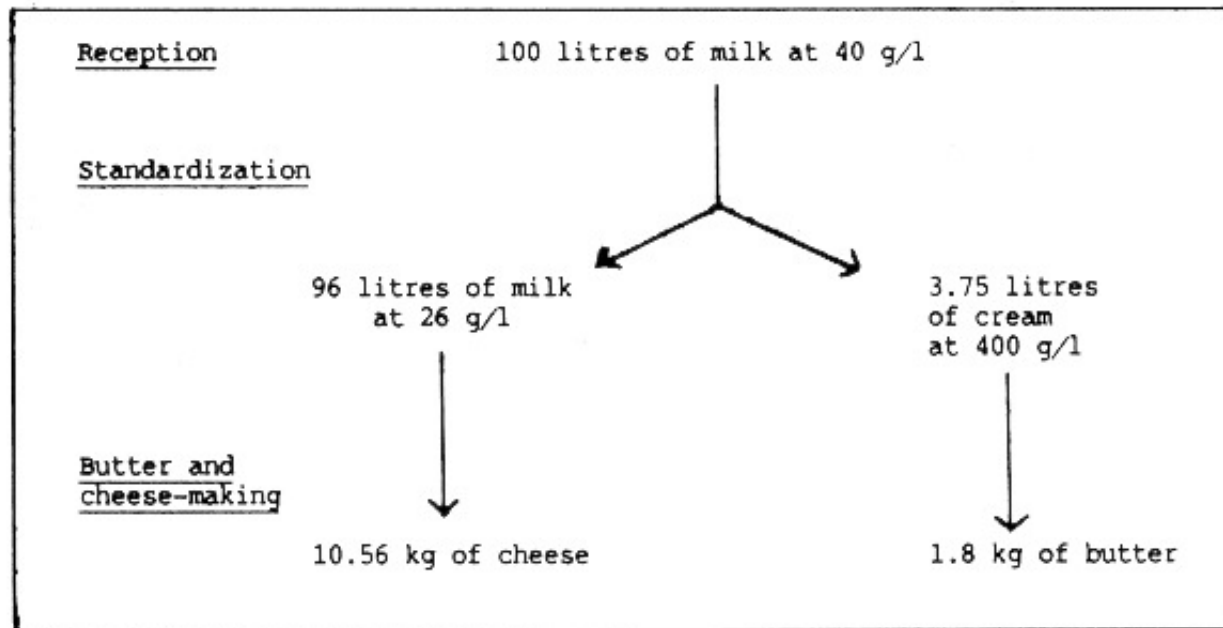

This represents a theoreticval breakdown - i. e. showing, in theory, the amount per product after milk processing. This, of course, needs to be compared with the amounts actually produced. If there is too great a difference, one must then proceed to ascertain just where the discrepancy lies; whether in the measurement of the volume of milk received, the determination of fat content, or in the quantities of milk and cream after standardization, etc.

II STUDY OF COST PRICE

Study of the cost price of each product is essential in order to determine the sale price for dairy products.

The calculation of cost price of dairy products is based on average daily production and actual

output obtained.

In the simple example already taken for the breakdown based on 100 litres of milk, the cost price of cheese and butter is established as follows.

1. Cost of raw material

Over one year the average of 100 litres of milk is received daily. From the outset of operations, this milk will be paid E per litre. The cost, therefore, of the raw material, is:

$$100 \times E$$

The usual consumption is that in 1 litre of milk the value of the fat content represents 50 percent of the price of the milk. It can therefore be concluded that the purchase price of 1 g of fat content, if the milk has an average rate of 40 g per litre, is:

$$E \times \frac{50}{100} \times \frac{1}{40} = \frac{1}{80} E$$

The butter contains 82 percent fat content and therefore the cost price of 1 kg of butter will be based on the cost of 820 g of fat content. This makes the cost price of 1 kg of butter:

$$820 \times \frac{1}{80} \times E$$

or again

$$10.25 E$$

The above example shows that 100 litres of milk with a fat content of 40 g per litre will supply 96 litres of milk with a fat content of 26 g per litre, for cheese-making.

The next step is to determine the value of the milk used for cheese-making. This milk is composed of:

milk solids	+	fat content of milk
(50% of the value of the milk)		(cost of the fat content at 26 g per litre)
$\frac{E}{50}$	+	$\frac{26 \times 1}{80} \times E$

The cost price of 1 litre of milk for cheese-making is therefore:

$$\frac{E}{50} + \frac{26}{80} E$$

The cheese yield of 100 litres of milk for processing is therefore approximately 11 kg of cheese.

The material cost, therefore, of 1 kg of cheese for accounting purposes is:

$$\frac{\frac{E}{50} + \frac{26}{80} E}{11} \times 100$$

As a further example, assuming that for milk 160 monetary units are paid in a local currency, the material cost price of the butter for accounting would therefore be for 1 kg of butter:

$$10.25 \times 160 = 1\,640$$

As for the material cost for 1 kg of cheese, the figure is calculated as follows.

The cost of 1 litre of milk for cheese-making, with a fat content of 26 g per litre, would be:

$$\begin{aligned} & \frac{160}{50} + \frac{26}{80} \times 160 \\ & = 3.2 + 52 \\ & = 55.2 \end{aligned}$$

The cost of 1 kg of cheese would be:

$$\begin{aligned} & \frac{55.2 \times 100}{11} \\ & = 501 \end{aligned}$$

The above data provides an approximate but adequate estimate of the cost of raw materials for making butter and cheese.

To obtain the total cost price per product, the processing costs also have to be added.

These costs are made up of fixed costs and variable costs.

The only cost involved in collection of the milk is the salary of the collector if employed by the village dairy.

In processing, salaries of the staff supervising and operating the dairy will have to be paid, as well as the expenses for fuel (wood, bottled gas, etc.) and the products used during processing (cleaning supplies, cultures, rennet, packaging materials).

All these costs are added to the cost of the unit of weight of the final product.

Using the above example, the following costs can be estimated:

2. Collection costs

If the collector's salary is 6 000 monetary units and he collects an average of 100 litres of milk per day (two 50-litre cans) the monthly collection will total 3 000 litres. The collection costs, therefore, for one litre of milk are:

$$\frac{6\ 000}{3\ 000} \text{ or } 2 \text{ (monetary units)}$$

25 percent of this will be earmarked for bicycle repairs and maintenance:

$$\frac{2 \times 25}{100} \text{ or } 0.5$$

Collection costs per litre of milk	
Expenditure	Monetary unit
Salary	2.0
Maintenance and repairs	0.5
TOTAL	2.5

Considering that some 10 litres of milk are needed to make 1 kg of cheese, the collection cost per kg of cheese is then:

$$2.5 \times 10 \text{ litres or } 25$$

3. Processing costs

Assuming the processing unit employs 4 people on a full-time basis, each at a salary of 36 000 (monetary units), the total payroll will come to:

$36\ 000 \times 4 = 144\ 000$ (monetary units).

Salary costs will then be broken down per kg of cheese. Knowing that the monthly average milk collection is 400 litres per day, or 12 000 litres per month, from which the cheese output is approximately 10 percent, then the salary costs per kg of cheese are:

$$\frac{144\ 000}{1\ 200\ \text{kg of cheese}} = 120 \text{ (monetary units)}$$

Knowing the monthly expenditure to be 36 000 monetary units for power (to heat the milk) and for processing aids such as starter cultures, rennet, cleaning supplies, etc., then the cost per kg of cheese can be broken down as follows:

$$\frac{36\ 000}{1\ 200\ \text{kg}} = 30 \text{ (monetary units)}$$

The cost of processing cheese from milk is therefore:

$$120 + 30 = 150 \text{ (monetary units)}$$

4. Packaging costs

Here again, the packaging materials required are estimated on a monthly basis (number of sheets of greaseproof paper; cost of a wooden crate for transporting cheeses, etc.) and the price in terms of the individual package. If the total monthly cost of the packaging is 6 000

(monetary units), for example, the packaging cost per kg of cheese will then be:

$$\frac{6\ 000}{1\ 200} = 5 \text{ (monetary units)}$$

5. Transport costs

The cost of transporting the products is also estimated on a monthly basis. If a vehicle is needed to transport the dairy products to town, depreciation of the vehicle needs to be taken into account. If the monthly transport cost is 24 000 monetary units, for example, the cost per kg of cheese is then:

$$\frac{24\ 000}{1\ 200} = 20 \text{ (monetary units)}$$

6. Marketing costs

As already mentioned, marketing, i.e. offering the product to the customer, is a highly important factor. Consequently, marketing may involve the use of a stand in town for direct sale. In this case, the marketing costs will include the rental of the stand plus the vendor's salary. If these monthly expenses amount to 60 000 monetary units, the sale cost per kg of cheese is then:

$$\frac{60\ 000}{1\ 200} = 50 \text{ (monetary units)}$$

SUMMARY

The following table summarizes all costs to be included in the sale price of 1 kg of cheese.

Village milk processing
Accounting service

Cheese-making cost price per kg of cheese	
	<u>Monetary units</u>
Raw materials	501
Milk collection	25
Production costs	
• salary	120
• supplies, power	30
Packaging	5
Transport	20
Marketing	<u>50</u>
TOTAL	751

This gives us a cost price of 751 monetary units for 1 kg of cheese.

The profit will depend on local market conditions, but should normally range around 30 percent of the cost price. This gives us a profit margin of:

$$\frac{751 \times 30}{100} = 225 \text{ monetary units}$$

This would make the sale price of the product (1 kg of cheese)

$$751 + 225 = 976 \text{ monetary units}$$

In this case the percentage of costs with respect to the sale price would be as follows:

Distribution of costs as % of sale price	
	%
Raw materials	51.0
Collection	2.5
Processing costs	15.0
Packaging	0.5
Transport	2.0
Marketing	5.0
Profit margin	24.0
TOTAL	100.0

III ESTIMATING EQUIPMENT COSTS

The suggested list of equipment primarily concerns equipment which is probably difficult to obtain locally. These are estimated costs, and are generally overestimated.

1. Milk collection equipment

	<u>Estimated cost in US\$</u>
• Chinese-type bicycle with spare parts	300
• Milk can with pressure cover	130
• Milk volume measuring can	100
• Funnel with filter	50
• Portable laboratory equipment including:	

Salut acidimeter	50
Glass cylinder	10
Lactodensitometer	15

2. Milk reception equipment

• 50 litre milk can (aluminium)	400
• Milk scales	60
• Funnel with filter	50
• Milk pail	60
• Milk stirrer	20
• Milk sampler	10

3. Laboratory equipment

• Laboratory wall cupboard used in determination of fat content	1 000
• Equipment and accessories for determination of milk acidity	50
• Glasswork	30
• Reagents for one year	60

4. Milk standardization equipment

• Hand-operated separator: 300 l/hour	1 600
• Cream bucket	60

- Milk can with pressure lid 50 litre capacity 20

5. Cheese-making equipment

- Stainless steel curd cutter 200
- Cheese stirrer 60
- Cheese thermometer 15
- Curd scoop 60
- Mould-filling tray 75
- Minor equipment such as brushes, aprons, cheese samplers, etc. 500

6. Butter-making equipment

- Hand-operated pinewood barrel churn: capacity 200
30 litres of cream

7. Equipment for preparation of processing aids

- Minor equipment used in the preparation of starter cultures and rennet 300



Bibliography

- J.C. Le Jaouen: La fabrication du fromage de chèvre fermier.
ITOVIC
- J.C. Belloin: Coût de production et de transformation du lait.
Etude FAO
- Jose Dubach: Para la quesería rural del Ecuador
- Bichsel: Equipment pour la petite fromagerie
- Gerault: Practice of milk industry in warm countries
- Gret: Le point sur les mini-laiteries
- FAO/Equipo regional de fomento y capacitación en lechería para América Latina:
- producción higiénica de la leche
 - cómo mejorar la eficiencia de su quesería
- FAO Regional Dairy Training Course:
- General accounting principles
- FAO-CENCAP: Manual de quesería artesanal
- J.P. Ramet: Technologie fromagère (divers documents)
- FAO/DGETA: Industrias rurales: Elaboración de leche
- Peter Meier/Francisco Rhon Davilà: Queserías rurales en Ecuador
- National Dairy Research Karnal Institute: Making milk powder in villages

FAO TECHNICAL PAPERS

FAO ANIMAL PRODUCTION AND HEALTH PAPERS:

1. Animal breeding: selected articles from World Animal Review, 1977 (C* E* F* S*)
2. Eradication of hog cholera and African swine fever, 1976 (E* F* S*)
3. Insecticides and application equipment for tsetse control, 1977 (E* F*)
4. New feed resources, 1977 (E/F/S*)
5. Bibliography of the criollo cattle of the Americas, 1977 (E/S*)
6. Mediterranean cattle and sheep in crossbreeding, 1977 (E* F*)
7. Environmental impact of tsetse chemical control, 1977 (E* F*)
- 7 Rev. Environmental impact of tsetse chemical control, 1980 (E* F*)
8. Declining breeds of Mediterranean sheep, 1978 (E* F*)
9. Slaughterhouse and slaughterslab design and construction, 1978 (E* F* S*)
10. Treating straw for animal feeding, 1978 (C* E* F* S*)
11. Packaging, storage and distribution of processed milk, 1978 (E*)
12. Ruminant nutrition: selected articles from World Animal Review, 1978 (C* E* F* S*)
13. Buffalo reproduction and artificial insemination, 1979 (E**)
14. The African trypanosomiases, 1979 (E* F*)
15. Establishment of dairy training centres, 1979 (E*)
16. Open yard housing for young cattle, 1981 (E* F* S*)
17. Prolific tropical sheep, 1980 (E* F* S*)
18. Feed from animal wastes: state of knowledge, 1980 (E*)
19. East Coast fever and related tick-borne diseases, 1980 (E* S*)
- 20/1. Trypanotolerant livestock in West and Central Africa, 1980. Vol. 1 — General study (E* F*)
- 20/2. Trypanotolerant livestock in West and Central Africa, 1980. Vol. 2 — Country studies (E* F*)
Le bétail trypanotolérant en Afrique occidentale et centrale. Vol. 3 — Bilan d'une décennie, 1988

- 20/3. (F*)
21. Guideline for dairy accounting, 1980 (E*)
 22. Recursos genéticos animales en América Latina, 1981 (S*)
 23. Disease control in semen and embryos, 1982 (E* F* S*)
 24. Animal genetic resources — conservation and management, 1981 (E*)
 25. Reproductive efficiency in cattle, 1982 (E* F* S*)
 26. Camels and camel milk, 1982 (E*)
 27. Deer farming, 1982 (E*)
 28. Feed from animal wastes: feeding manual, 1982 (E*)
 29. Echinococcosis/hydatidosis surveillance, prevention and control: FAO/UNEP/WHO guidelines, 1982 (E*)
 30. Sheep and goat breeds of India, 1982 (E*)
 31. Hormones in animal production, 1982 (E*)
 32. Crop residues and agro-industrial by-products in animal feeding, 1982 (E/F*)
 33. Haemorrhagic septicaemia, 1982 (E* F*)
 34. Breeding plans for ruminant livestock in the tropics, 1982 (E* F* S*)
 35. Off-tastes in raw and reconstituted milk, 1983 (E* F* S*)
 36. Ticks and tick-borne diseases: selected articles from World Animal Review, 1983 (E* F* S*)
 37. African animal trypanosomiasis: selected articles from World Animal Review, 1983 (E* F*)
 38. Diagnosis and vaccination for the control of brucellosis in the Near East, 1983 (Ar* E*)
 39. Solar energy in small-scale milk collection and processing, 1983 (E* F*)
 40. Intensive sheep production in the Near East, 1983 (Ar* E*)
 41. Integrating crops and livestock in West Africa, 1983 (E* F*)

42. Animal energy in agriculture in Africa and Asia, 1984 ([E/E*](#))
43. Olive by-products for animal feed, 1985 ([Ar*](#) [E*](#) [F*](#) [S*](#))
- 44/1. Animal genetic resources: conservation by management, data banks and training, 1984 ([E*](#))
- 44/2. Animal genetic resources: cryogenic storage of germplasm and molecular engineering, 1984 ([E*](#))
45. Maintenance systems for the dairy plant, 1984 ([E*](#))
46. Livestock breeds of China, 1985 ([E*](#))
47. Réfrigération du lait à la ferme et organisation des transports, 1985 ([E*](#))
48. La fromagerie et les variétés de fromages du bassin méditerranéen, 1985 ([F*](#))
49. Manual for the slaughter of small ruminants in developing countries, 1985 ([E*](#))
50. Better utilization of crop residues and by-products in animal feeding: research guidelines —
 1. State of knowledge, 1985 ([E*](#))
- 50/2. Better utilization of crop residues and by-products in animal feeding: research guidelines —
 2. A practical manual for research workers, 1986 ([E*](#))
51. Dried salted meats: charque and carne-de-sol, 1985 ([E*](#))
52. Small-scale sausage production, 1985 ([E*](#))
53. Slaughterhouse cleaning and sanitation, 1985 ([E*](#))
54. Small ruminants in the Near East: Vol. 1, 1986 ([E*](#))
Selected papers presented at Tunis Expert Consultation
55. Small ruminants in the Near East: Vol. II, 1986 ([E*](#))
Selected papers from World Animal Review
56. Sheep and goats in Pakistan, 1985 ([E*](#))
57. Awassi sheep, 1985 ([E*](#))
58. Small ruminant production in the developing countries, 1986 ([E*](#))

- 59/1. Animal genetic resources data banks, 1986 (E*)
1 — Computer systems study for regional data banks
- 59/2. Animal genetic resources data banks, 1986 (E*)
2 — Descriptor lists for cattle, buffalo, pigs, sheep and goats
- 59/3. Animal genetic resources data banks, 1986 (E*)
3 — Descriptor lists for poultry
60. Sheep and goats in Turkey, 1986 (E*)
61. The Przewalski horse and restoration to its natural habitat in Mongolia, 1986 (E*)
62. Milk and dairy products: production and processing costs, 1988 (E* F* S*)
63. Proceedings of the FAO expert consultation on the substitution of imported concentrate feeds in animal production systems in developing countries, 1987 (E*)
64. Poultry management and diseases in the Near East, 1987 (Ar*)
65. Animal genetic resources of the USSR (E***)
66. Animal genetic resources — Strategies for improved use and conservation, 1987 (E*)
- 67/1. Trypanotolerant cattle and livestock development in West and Central Africa — Vol. I, 1987 (E*)
- 67/2. Trypanotolerant cattle and livestock development in West and Central Africa — Vol. II, 1987 (E*)
68. Crossbreeding *Bos indicus* and *Bos taurus* for milk production in the tropics, 1987 (E*)
69. Village milk processing, 1988 (E*)
70. Sheep and goat meat production in the humid tropics of West Africa, 1988 (E/F*)
71. The development of village based sheep production in West Africa, 1988 (E* F* S*)
72. Sugarcane as feed, 1988 (E/S*)

Availability: November 1988

Ar — Arabic

C — Chinese

E — English

F — French

S — Spanish

*** Available**

**** Out of print**

***** In preparation**

The FAO Technical Papers are available through the authorized FAO Sales Agents or directly from Distribution and Sales Section, FAO, Via delle Terme di Caracalla, 00100 Rome, Italy.

