

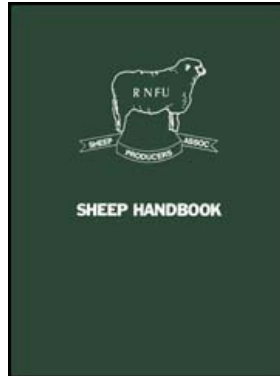

















Sheep Handbook

 **Sheep Handbook****Author(s):** *D. J. Donkin***Publication date:** *1973***Number of pages:** *156***Publisher:** *Rhodesia Sheep Producers' Association, Ministry of Agriculture***Contents:**

-  [Acknowledgements](#)
-  [Introduction](#)
-  [Foreword](#)
-  [Chapter 1. The Rhodesian Sheep Industry](#)
-  [Chapter 2. Sheep Breeds in Rhodesia](#)
-  [Chapter 3. Breeding and Selection](#)
-  [Chapter 4. Management](#)
-  [Chapter 5. Sheep Management Calendars](#)
-  [Chapter 6. Nutrition](#)

-  [Chapter 7. The Grazing Sheep](#)
-  [Chapter 8. Handling Facilities](#)
-  [Chapter 9. Marketing of Sheep](#)
-  [Chapter 10. Wool](#)
-  [Chapter 11. Economics](#)
-  [Chapter 12. Diseases and Parasites](#)
-  [Appendices](#)
-  [General Information](#)

Acknowledgements

[▲ Top](#)

Considerable assistance has been received from many sources in the preparation of this handbook and it is impossible to acknowledge everyone who has contributed with comment, constructive criticism, and other assistance. However, special thanks should go to those who have given major assistance, namely Dr. R. C. Elliott, all members of the Executive Committee of the Rhodesia Sheep Producers' Association, Mr. J. E. Robertshaw, Mrs. S. Loveridge, Mr. F. J. B. Atkinson, Mrs. H. Livings, and Rhodesian Farmer Publications.

November, 1973



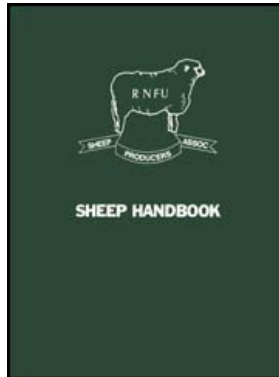

Sheep Handbook











Author(s): *D. J. Donkin*







Publication date: *1973*

Number of pages: *156*

Publisher: *Rhodesia Sheep Producers' Association, Ministry of Agriculture*

Contents:

-  [Acknowledgements](#)
-  [Introduction](#)
-  [Foreword](#)
-  [Chapter 1. The Rhodesian Sheep Industry](#)
-  [Chapter 2. Sheep Breeds in Rhodesia](#)
-  [Chapter 3. Breeding and Selection](#)
-  [Chapter 4. Management](#)
-  [Chapter 5. Sheep Management Calendars](#)
-  [Chapter 6. Nutrition](#)
-  [**Chapter 7. The Grazing Sheep**](#)
-  [Chapter 8. Handling Facilities](#)

-  [Chapter 9. Marketing of Sheep](#)
-  [Chapter 10. Wool](#)
-  [Chapter 11. Economics](#)
-  [Chapter 12. Diseases and Parasites](#)
-  [Appendices](#)
-  [General Information](#)

Chapter 7. The Grazing Sheep

[▲ Top](#)

D. J. DONKIN

In a hungry world the ruminants may well survive longer than other domesticated animals as producers of meat for human consumption. As an animal which is adaptable to intensive grazing and which has a high potential reproduction rate, the sheep is likely to remain an important ruminant on the farming scene. In Rhodesia, however, the intensive use of pastures by sheep is only in its infancy, and most sheep production is based on the more extensive use of grazing land. Under these circumstances the natural herbage forms all or most of the animal's diet for a large part of the year.

In this chapter, planted pastures - consisting usually of one grass species only - will be considered separately from natural veld, which normally includes a large number of species of grasses and herbs, some of which are legumes.

GRAZING BEHAVIOUR

Contrary to widespread popular belief, a sheep in the field that is not grazing at any particular moment in time is not necessarily ailing, nor even determined to reduce its own productivity to spite the farmer! When left to themselves, all ruminants have a characteristic daily routine of grazing, resting, ruminating and going to water. The main grazing periods appear to be in the early morning and late afternoon, with shorter snacks in between. Depending upon normal prevailing temperatures, sheep graze for about 60 to 70 per cent of the daylight hours, but the proportion may be decreased when very high temperatures favour more night grazing. Shade is particularly important for resting sheep in areas prone to high day temperatures. Generally, sheep in a flock will all follow the same activity at the same time.

Du Toit (1972) studied the grazing behaviour, and the effects of sheep and goats grazing either continuously or in an eight-camp rotation in the thornbush-encroached grassland at Döhne in the eastern Cape. Some of his results are given in Table 7.1.

Table 7.1 Grazing habits of individually observed sheep and goats (Du Toit, 1972)

Action	Sheep			Goats				
	CG*		RG*		CG*		RG*	
	No of	%	No of	%	No of	%	No of	%

	NO. OF observations	%	NO. OF observations	%	NO. OF observations	%	NO. OF observations	%
Graze grass	379		479		479		282	
Graze bush	21	38	79	47	504	53	284	36
Graze unidentified	249		308		264		282	
Stand	655	38	595	25	397	17	554	23
Walk	148	9	236	9	228	9	272	12
Lying down	239	14	438	18	483	20	680	29
Total	1 691		2 135		2 355		2 354	

*** CG = continuous grazing; RG = rotational grazing**

The sheep and goats were grazing separately in camps in which *Acacia karroo* thorn-scrub had been allowed to coppice. Rotationally grazed camps were stocked at a density eight times greater than that of the continuously grazed camps for one week in every cycle of eight weeks.

Quite a lot can be learned from this table. Sheep devoted only six to ten per cent of their grazing time to browsing, although the effect of grazing pressure

under rotational grazing led to a larger browse intake. Goats spent about 50 per cent of the grazing time in browsing.

It is interesting to note the proportion of time spent loafing - which includes chewing the cud as well as merely resting. Whereas sheep on continuously grazed pastures loafed for about 60 per cent of the time, those on the rotated pastures did so for only 50 per cent of the time, probably because the grazing pressure forced the animals to search harder to meet their feed intake requirements.

It was also observed that in the absence of cattle, sheep indulged in a very marked *area* selection, grazing certain patches of the camp almost to the exclusion of others. This was particularly severe under rotational grazing, but under continuous grazing the flock was so small that damage was restricted to smaller areas. When cattle graze with sheep, the problem is never so serious since cattle graze down the taller, rank grass making otherwise untouched areas more attractive to sheep.

Watering requirements

In Australia, Lynch (cited by Durand 1971) has also made further interesting observations of grazing sheep in very dry country - less than 200 mm rainfall per year. He noted that when the grass was green and abundant and maximum temperatures around 30°C (86°F) most of the flock watered only once every three to four days. He also noticed that even in the dry summer when

temperatures were up to 40°C (104°F) most sheep drank only two or three times a week if grazing was abundant.

During periods of relatively abundant grazing, sheep stayed in large groups and grazed well away from the only source of permanent water. Conversely, during a drought, the flock broke up into small groups which scattered all over the paddock. The poor quality of the feed at this time, coupled with the high temperatures seemed to induce a need to drink daily.

In an area where sheep grazed mainly on Saltbush, the intake of salt was very high and they needed to drink at least six litres (1,3 gallons) water per day, in two waterings. Under these circumstances they would never graze more than 2,4 kilometres (1,5 miles) from water.

Shy feeders

A further study during the supplementary feeding of drought stricken sheep revealed that there was always a proportion (as much as 10 to 15 per cent) of shy feeders that hung back and appeared reluctant to take any food. Even when trough space was adequate and all animals had had a chance to become accustomed to the supplement, there were still some that would not eat. This appeared to be an aspect of social behaviour, because when these non-feeders were penned separately from the rest of the flock, they soon learned what the supplement was for.

Herding

Many flocks in Rhodesia have to be herded to grazing each day. How much will this interfere with their natural grazing inclinations?

First, it should be ensured that the sheep go out early each morning and are returned in the evening only shortly before sunset. Secondly, the shepherd should be interested in his sheep and ensure that they are not unduly restricted in their grazing areas. Thirdly, the night kraal should be within a radius of about two kilometres from grazing sufficient for the whole flock.

With these provisos, sheep will certainly adapt themselves to a routine of night kraaling. If some feed is provided in their kraals at night, there is no reason why they should not do almost as well as sheep on permanent free range.

2. GRAZING SHEEP AND CATTLE TOGETHER

When considering stocking rate and pasture utilization for sheep, the value of cattle should not be overlooked. Cattle and sheep, particularly ewes and young sheep, often consume different types of grasses and more complete utilization will be achieved if both classes of stock are run together. There is much research information to confirm this from all over the world, both on improved pastures and on natural grazing.



When cattle and sheep are together, run one beast per six sheep.

Photo D. J. Donkin.

Stocking rate is critical in this regard, because when grazing is in short supply, the sheep, which can graze closer than cattle, get not only their own share of the shorter palatable fresh growth available to them but, apparently, get the cattle's share also. Under these circumstances cattle may suffer even while the sheep still thrive.

One circumstance under which sheep in Rhodesia do not appear to do well is

when a high-intensity short-duration grazing rotation is operating on veld. I would suspect that the reason for this is that first, the ratio of cattle to sheep is unbalanced. One beast to six sheep is normally considered satisfactory, whereas the ratio for SDG grazing systems is often two or three head of cattle to one sheep. Secondly, when large numbers of cattle are confined in a relatively small area, the sheep probably feel (and are) crowded out from the best grazing. Thirdly, as the sheep have still to be kraaled at night - owing to the lower expenditure on fencing for cattle - they are at yet a further disadvantage when competing with the intensively grazing cattle for the high quality forage normally selected by sheep.

Generally, however, because taller grasses are more common in our veld, sheep should either follow cattle in the grazing system or else be grazed in areas that can be mowed if necessary.

3. VELD MANAGEMENT

It is now accepted policy in Rhodesia that, under most circumstances, a suitable system of rotational grazing of veld is desirable, both for the long-term advantage of the grazing animals and for the maintenance of vigour of the best natural grasses. Basically, this approach to grazing means that, within the overall stocking rate, the flock is confined for a short period and then moved on to the next camp, leaving the previous camp to rest for a period sufficiently long to allow the grasses to grow out again.

As mentioned in the previous section, sheep do not always do well when run with cattle, particularly in the high rainfall areas. As an alternative they should either follow the cattle herd, grazing the camp the cattle have just left, or graze in an area of their own where surplus growth can be mowed off and stored as a forage reserve. Both alternatives have their drawbacks. In the first the rest period allowed for the grass is reduced by subjecting it to sheep for an extra period of grazing. In the second, many of our veld grasses will not persist under a management regime that continuously prevents them from growing out, setting seed, and storing up root reserves. To sum it up "sheep don't like tall grass and tall grasses don't like sheep".

In the medium and lower rainfall areas, the problem is less acute because the grasses do not generally grow so tall and are less dense on the ground. Under these conditions the hardier breeds of sheep will manage very well if the flock is not too big. However, in areas where Speargrass is common, only the hair-coated breeds can be run.

Owing to the expense of effective sheep fencing, as well as the threat of predators or stock-thieves, most sheep flocks grazed on veld are likely to be herded by day and kraaled at night. Although this may be expensive in terms of labour, it does permit some form of alternate grazing and resting of the veld to be practised.

In addition to the short-graze long-term rest pattern, certain other practices should be adopted. Sheep should be confined to topland grazing and should be

kept away from vleis and other wet areas during mid-summer. In winter they will do well on crop residues and, in late winter and early spring, they can graze in vleis and wetter areas to take advantage of any early "green bite" before the rains set in.

4. PASTURE MANAGEMENT

Wool-bearing sheep in Rhodesia cannot be run under most of our veld conditions and this means that planted pastures of some kind will be necessary for them. Of course, the improved productivity of pastures, if properly used, makes them suitable for the intensive production of any breed of sheep.

Improved pastures in Rhodesia can be divided into four main types:

(i) Low or moderately fertilized dryland pastures

These are often leys and are usually found in a tobacco rotation. As they are usually grown on arable land, are densely planted and benefit from a residue of fertility from the previous crop, they are usually about twice as productive in terms of dry matter production as the adjacent natural veld. Generally, they do not "come away" very early in the season (Lovegrass is a noted exception), but they can be useful in diverting some grazing pressure from the veld at this critical time of the year. Certain species, notably Sabi Panicum and Giant Rhodesgrass, need a late summer rest if they are to persist. Winter growth is negligible and foggage grazing usually needs some form of protein

supplement to make up for seasonal deficiencies.



A flock in a small moveable fold on a tobacco ley.

Photo Shell Farmer.



Fertilizer is not usually applied, particularly nitrogen in tobacco rotations, but a dressing of single superphosphate (90 to 180 kg/ha) and light dressings of nitrogen (50 to 90 kg/ha) will greatly enhance productivity,

(ii) Highly fertilized dryland pastures

Extremely high levels of dry matter have been produced on highly fertilized dryland pastures at the Henderson Research Station. The best grasses are mainly runner types which must be vegetatively propagated. Despite its seasonal prussic acid levels and associated goitre troubles in sheep, No. 2 Star grass, *Cynodon aethiopicus*, is still the most favoured species, particularly since a suitable mineral lick has been devised at Henderson to correct the induced iodine deficiencies. The Henderson lick consists of 25 g potassium iodate in 45 kg of a salt monocalcium-phosphate lick mixed either 1:1, 2:1 or 1:2, depending on intake. Sheep should take in eight grams of this lick per head per day.

Other grass species that have adapted well to intensive sheep grazing include Victoria Falls Panicum, *Panicum repens*, also known as Torpedo grass, on the wetter soils; Kikuyu grass, *Pennisetum clandestinum*, in high altitude, high rainfall areas; and Paraguay paspalum, *Paspalum notatum*, in the high altitude medium rainfall areas (more than 750 mm rainfall per annum). This latter species can be established from seed, but seedling growth is slow. Once established however, it can be grazed frequently and closely without loss of vigour, both in the growing and in the dry season. It is noted for being the least goitrogenic of all the pasture grasses (Rodel 1972). Wintergreen Paspalum, *Paspalum guenoarum*, is similar to Paraguay, but has a less turf-like character. It stays green well into winter, especially after late rains.

These pastures usually require a season to become fully established, and during this period need relatively little fertilizer. Once established however,

liberal dressings of nitrogen are required if good production is to be achieved.

On heavy soils, 200 to 400 kg N/ha gives good results. Single superphosphate should be applied late in the dry season before growth recommences. Use 200 kg single superphosphate/ha when N applications are up to 100 kg/ha. This application should be doubled for higher levels of N. Since no evidence of potash (K) requirements is available, only maintenance dressings of K (50 to 100 kg K₂O/ha) are recommended.

At Henderson, 30 ewes and their lambs have been run per hectare on dryland Star-grass pastures on a year-round basis. The area was divided into eight. Four camps were grazed, one week in and three weeks out; the other four camps were reserved for the mowing off of surplus growth in summer, for storage as hay or silage. After the mow these four camps were then grazed and the other four rested. This stored forage was fed after pasture growth had ceased in winter. The sheep were dosed monthly and this, and the rotation, appeared to keep worms down to a manageable level. Supplements of cottonseed cake and maize meal were fed during late pregnancy and early lactation.

An alternative practice used at Henderson was to graze the dryland Stargras pastures intensively during summer and rest them in winter. During the summer months, 75 ewes and lambs per hectare (150 head per hectare) have been run in this way.

The major drawback of highly fertilized dryland pastures is the unreliability of rainfall. When growth and carrying capacity of the pastures is reduced in poor seasons, the farmer has to find alternative grazing for some or all of his flock.

(iii) Highly fertilized irrigated pastures

Research work with irrigated pastures at Henderson Research Station arose naturally out of their investigations into dryland pastures, particularly as a means of countering the limitations mentioned in the previous paragraph.

Owing to the longer growing season that can be enjoyed, far higher nitrogen applications have resulted in even greater dry-matter yields of grass. Generally, the same grasses used for highly fertilized dryland pastures will thrive under irrigation, but Star No. 2 and Kikuyu are the most commonly irrigated varieties.

Fertilizer levels of up to a tonne of N per hectare have been tested, but 500 to 700 kg/ha are likely to be the most practical levels of nitrogen application. At these levels 450 kg single superphosphate/ha (90 kg P₂O₅) and 120 kg muriate of potash//ha (70 kg K₂O) will also be necessary. The nitrogen application should be divided into several split-dressings applied at intervals of four or five weeks throughout the season.

Up to 1 250mm (48in.) of irrigation might be necessary, depending upon the season.

Provided the mineral supplementation of ewes is satisfactory, irrigated highly fertilized pastures have effectively carried 100 ewes and their lambs per hectare (40 per acre) over the eight-month period, September to April.

It should be borne in mind that sheep are extremely prone to roundworm infestation, and that the warmth of summer combined with the constant moist conditions on irrigated pastures provide ideal conditions for roundworm multiplication. To avoid sheep deaths, a regular dosing routine alone will not be sufficient; some form of rotational grazing of the pasture will be necessary. Owing to the rapid growth of grass under irrigation, production under a prolonged rotation will be lost unless a mower or, better still, cattle are introduced to make use of this prolific growth.

(iv) Irrigated winter cereals and grasses

The only pastures that will actually grow during winter are the winter cereals such as oats and wheat, and European grasses such as Italian ryegrass. Although winter oats and ryegrass are mainly grown by dairy farmers to provide a "green bite" for their cows in winter, they could be used very efficiently by ewes with lambs at heel in winter.

Unless such pastures can be produced very cheaply, experience on most dairy farms appears to indicate that the same quantity of succulent forage can be produced from maize silage at lower cost.

Shepherds and shepherding

(Note: In this section I have drawn heavily on articles by W. Aitcheson and D. K. Worthington in the publication "Sheep in Rhodesia").

Because most sheep in Rhodesia are kraaled at night, they have to be herded out to grazing every day. Under such circumstances the shepherd has a tremendous influence on the well-being and profitability of the flock. In this country, unfortunately, no tradition of good shepherding is passed on from father to son, and most shepherds have to be employed from a "raw" state and trained up. This aspect of sheep production is so important that in many cases it is one of the root causes of problems in the sheep flock.

A farmer who likes and who understands sheep is likely to pass this on to his shepherds, but he must ensure that the employees he selects for training as shepherds should be physically and temperamentally capable of doing the job well. For this reason, old men or young boys are equally unsuitable in most instances, for a shepherd must be strong and active and intelligently interested in the well-being of his flock. Incentive bonuses based on the number of lambs born and weaned are a great help. Probably equally important is the prestige attached to the job of head shepherd, the acknowledgement that good shepherding is a full-time job, the provision of suitable relief shepherds, time off and so on. A further important aspect is the size of the flock. At no time should this be so big that the shepherd is *unable* to carry out all the duties allocated to him. Usually 100 to 150 head of ewes is optimal, but extra assistance is necessary at lambing time.

Unless the farmer himself is familiar with the training and use of sheep dogs, he should not normally permit his shepherds to use dogs. A well-trained, well-used sheep dog is a marvellous asset in handling a flock but, conversely, a bad dog over-used, can seriously reduce the overall productivity of the flock.

The shepherd should know how to dose, inoculate and shear - if he has wool sheep; when and how to help a ewe in lambing difficulties and how to assist weak or orphaned lambs; how to catch and up-end a sheep for examination, and how to trim hooves. In this modern day, it is also a considerable advantage to know how to read and write simple notes, to tag, weigh and record lambs, and to recognize and report on certain disease symptoms.

Very often a shepherd is blamed if things go wrong, but in many instances, part of the fault at least must rest with the farmer who has either given incomplete instructions or has failed to ensure that his instructions have been fully understood. Probably even more serious from the flock's point of view is the situation of uninterested, bored monotony that exists where the "shepherd" is no more than someone who has been "told off" to keep an eye on the sheep, and whose personal interest extends no further than that.

Mr. D. K. Worthington (Rhodesia Sheep Producers' Association, 1967) has provided a useful list of subjects on which the shepherd should be specifically and clearly instructed.

1. The time at which the flock is to be let out in the morning and yarded

in the evening. Counting the sheep out and in.

2. Where and when the sheep are to graze.

3. Length of the midday break.

4. Where the flock is to be during the break.

5. Particular areas to be avoided.

6. Where the flock is and is not to drink.

7. Action in the event of heavy rains.

8. Action in event of light rain.

9. Action in event of heavy thunderstorm.

10. Action in the case of a sick animal.

11. Action in cases of tick clusters, devil-thorns, burrs and sore feet.

12. Methods of identifying ewes which abort, which have twins, whose lambs die or which rear poor lambs.

13. Identification and eradication of noxious weeds and poisonous plants.

- 14. The need to avoid grazing the flock in reaped but ungleaned maize lands.**
- 15. The need to collect and bury discarded bits of wire, tins and bottles.**
- 16. How and why drinking troughs must be kept clean.**
- 17. How to maintain fences, gates and pens.**
- 18. Who is to act as relief shepherd.**
- 19. Action to be taken against jackals and snakes.**
- 20. The rationing and protection of supplements and salt licks.**



Sheep Handbook

Author(s): *D. J. Donkin*

Publication date: *1973*







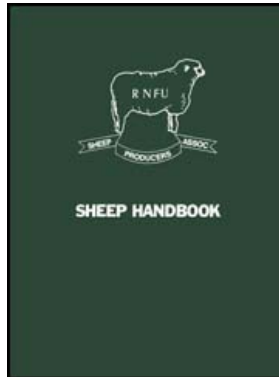









Number of pages: *156*

Rhodesia Sheep Producers'

Publisher: Association, Ministry of Agriculture



Contents:

-  [Acknowledgements](#)
-  [Introduction](#)
-  [Foreword](#)
-  [Chapter 1. The Rhodesian Sheep Industry](#)
-  [Chapter 2. Sheep Breeds in Rhodesia](#)
-  [Chapter 3. Breeding and Selection](#)
-  [Chapter 4. Management](#)
-  [Chapter 5. Sheep Management Calendars](#)
-  [Chapter 6. Nutrition](#)
-  [Chapter 7. The Grazing Sheep](#)
-  [**Chapter 8. Handling Facilities**](#)
-  [Chapter 9. Marketing of Sheep](#)
-  [Chapter 10. Wool](#)
-  [Chapter 11. Economics](#)
-  [Chapter 12. Diseases and Parasites](#)
-  [Appendices](#)
-  [General Information](#)

Chapter 8. Handling Facilities

[▲ Top](#)

D. J. DONKIN

Good handling facilities and good management of sheep are almost synonymous terms. Not so much because you cannot have good management without good facilities, but rather because you never meet a good flock manager who does not have a set of smooth-working effective handling facilities to aid him in his work.

There is no "ideal" plan for sheep handling facilities, although examples of suitable basic designs are given in the Appendix. The reason for this is that requirements and conditions, both of flock and site, vary so much from farm to farm that no simple design would suit all circumstances. The following discussion on various aspects of handling facilities will enable the farmer to use or modify the basic plans according to his own requirements.

1. SITING

When siting handling facilities, a number of points should be considered.

(a) *Central position:* It is obvious that, to avoid unnecessary trekking, the facilities should be as central and as convenient to the other centres of sheep activity as possible. If there are night kraals, a shearing shed or sheep pens, it is very often convenient to construct the handling pens adjacent to them,

although this is not always so. The creation of dust near a shearing shed for example, should be avoided whenever possible. At the same time, the footbath or dip tank, if necessary, are usually part of the overall facilities, and it is convenient for these to be near the night kraals or shearing shed.

If the farm is a large one and sheep grazing areas are far apart, it is often desirable to have a smaller, simple set of facilities constructed away from the central one, and so avoid long unnecessary treks for such routine practices as dosing or inoculating.

(b) *Site drainage:* Sheep handling facilities must be constructed on a well-drained site. This is essential. A slight (not too steep) slope is desirable, and a gravelly soil which has better natural drainage characteristics than heavy clays. Places where the subsoil is relatively impervious must be avoided.

Where facilities are set up on a sloping site, an adequate storm drain constructed up-hill of the site is essential. The construction of earth banks or bolsters, across the most frequently used sheep tracks to and from the site is also important.

(c) *Aspect:* This can also be very important. Sheep appear to move more readily on a slight uphill grade, and even if the rest of the facilities are on the level, it helps if the race and forcing pens run up a slight incline.

The prevailing wind should also be considered in some areas. The facilities should be sited downwind of the homestead or shearing shed and, in very

exposed areas preferably behind some form of windbreak. At the same time, the facilities should be so oriented that the holding pens - where most dust is generated - are not upwind of the main working area (the race and sorting gates).

(d) *Shelter and shade:* Where possible, advantage should be taken of existing trees - a clump or plantation - to form a shelterbelt, and of isolated shade trees where they can be incorporated in the holding yards. Even after the facilities have been built, suitable shade trees (such as quick-growing *Acrocarpus*) can be planted in the holding area and suitably protected until they are too big to be damaged by the sheep.

(e) *Water supply:* If a dip tank or footbath is included within the facilities, a good water supply is essential. Even in simple handling yards the provision of a water trough is a good idea, especially if flocks have to be brought from long distances and, in some cases, held in the pens overnight.

Where wool sheep are run, it is usually desirable to use a hose to sprinkle the dusty areas before the sheep come in. This minimizes dust contamination of the wool.

2. SIZE OF FACILITIES

Two aspects have to be considered here, the cost and the size of the flock likely to be handled at any one time.

As far as cost is concerned, the nucleus of the facilities (crush pens, drafting race and sorting gates) should preferably be well-constructed of good quality materials. Holding pens of suitable size may simply be fenced off until, at a later date, funds for more permanent enclosures become available.

The size of the flock will affect the area of the receiving and holding yards. As a general rule, allow 0,3 m² to 0,45 m² (3,2 to 5 sq. ft.) per head, depending on the size of the sheep. Fat-tailed sheep usually come at the smaller end of the scale, while wool sheep in full fleece - especially those with large frames such as the South African Mutton Merino - need the larger space per head.

A crush pen 1,2 m (4 ft.) wide and 7 m (23 ft.) long can hold approximately 40 animals.

3. GENERAL LAYOUT

The most difficult decision when designing handling facilities is to select a suitable general layout. Any farmer who tries to "read up" the subject will find himself presented with a wide range of plans, all of them near the ideal in the eyes of their respective authors. His best approach is to break down the different sections of the handling facilities into component parts according to their various functions, decide which he needs to meet his own requirements, and then modify some basic plan to suit himself. Figure 8.1 is a diagram (not a plan) of a sheep yard, showing its main components.



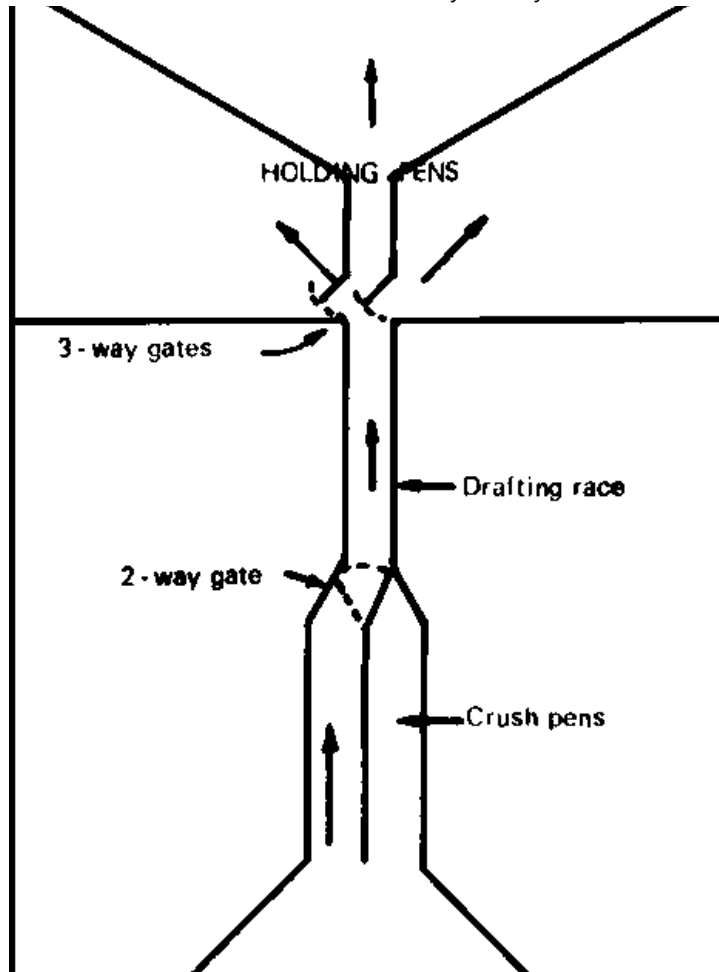

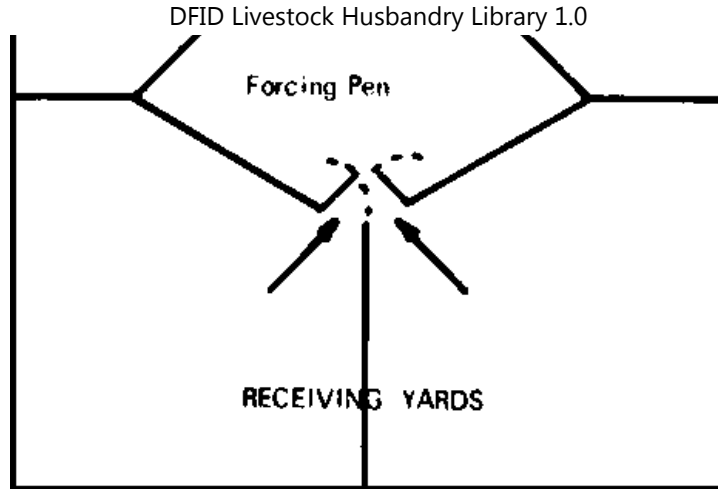

Figure 8.1. Diagram of typical sheep handling facilities.

It is usual and very convenient to have one or two small holding paddocks alongside the handling pens. These have many uses and also mean that the receiving and holding pens do not have to be so big.

It is important to remember that "sheep like to follow sheep". All layout plans should therefore be made with clear paths where you wish the sheep to go, and solid walls or partitions where you do not want them to go. In general, the following sequence of components in a set of handling facilities is found in large-scale enterprises. Where smaller flocks (under 200 head) are run, some of these components will probably be omitted.



An Australian sheep handling layout.

Photo J. W. Hayward.

(a) *Receiving pens:* the sheep enter these from the paddock and they must therefore be large enough to hold the biggest flock of sheep likely to be dealt with at one time.

(b) *Forcing pen:* This is much smaller and is designed to guide more manageable small groups of sheep into the crush pen(s).

(c) *Crush pen(s):* These are either one or two small but long pens, often tapering at one end; an internal angle of 60° is satisfactory. Where two are parallel, one may be narrower and be used as a dosing race 450 mm (18 in.)

wide; the other is made wider, 1,0 to 1,6 m (3 ft. to 5 ft.), so that it can be used for sheep classing, and also serve as a forcing pen to guide the sheep into the drafting race.

If a footbath or dip tank is necessary, it can be situated in one of the parallel crush races - unless it is not wanted as an integral part of the main handling facilities.

As sheep do not like being dipped, the dip should preferably be sited so that it is out of the sheep's sight until the last minute.

(d) *Drafting race:* This race should have smooth solid sides to minimize damage to skins and fleeces by corners and projections. It should be just wide enough, 450 mm (18 in.), for the sheep to pass along in single file. Its purpose is to divide a mixed flock of sheep into different classes for selection - for example, sucking lambs, weaners and ewes, or sick and healthy and so on. To achieve this, the race is fitted with a one metre (3 ft.) two or three-way sorting gate at the far end, from which the sheep are directed into different holding pens.

(e) *Holding pens:* These should correspond in size to the receiving pens, and serve to hold the animals that have been dealt with until the task on the whole flock has been completed. It can be very useful to have one holding pen the same size as the deck of the usual vehicle used for transporting the sheep. Such a holding pen could also conveniently lead on to a loading ramp.

Other facilities such as a loading ramp or weighing crate can also be incorporated into the design. Where the nature of the site or the area of land available necessitates a less orthodox layout, remember THAT THE ALTERATION OF THE EXTERNAL SHAPE OF THE YARDS MUST NOT BE ALLOWED TO ALTER THE SEQUENCE OF THE DIFFERENT COMPONENTS.

It will simplify construction to have as many straight unbroken sections of fence as possible. This reduces the number of corner posts, strainers and stay anchors required.

4. CONSTRUCTION

Initially the site should be fully cleared and levelled, and the plan pegged out on the ground.

Fences for forcing pens, crush pens, dosing and drafting races should be soundly constructed from board, split poles, piping or walls built of brick; the latter is one of the cheapest and most durable materials available for use under Rhodesian conditions. Wire and wire-netting are not very suitable for these pens because not only is wire less able to stand the strain of large numbers of animals pressing against it, but also, the sheep can easily see through it - a factor that will make them less inclined to progress forwards and more inclined to attempt to escape. The solid walls or divisions should be about a metre high so that the sheep cannot see out, but the men handling them can step over fairly easily.

Treated poles and well-strained plain wire or wire netting are suitable for outer fences, which should be about 1,2 m (4 ft.) high, and for inner fences about 1,0 m (3 ft.) high.

The floors of all races and pens that get the most wear should ideally be paved. Concrete is the most suitable paving, although grouted stone-pitching is also satisfactory if soundly constructed.

5. GATES

Effective gates are an important part of any set of handling facilities. Swing gates are usually most suitable for camps and holding pens and solid gates are preferable to ones through which the animals can see.

The position from which the gate is hung is important. It should preferably not be a fencing strainer post, and it should be so positioned that its opening or closing is not hindered by the presence of animals when the facilities are in use. It is for this reason that sliding gates (either "up and down" or "side to side") are sometimes included in certain parts of the sheep handling facilities.

6. SHEEP FENCING

Although the expense of sheep-proof fencing is relatively high, it is always advisable to have certain fenced paddocks and holding pens, even on farms where night-kraaling and herding is practised.

A seven- or eight-strand wire fence, 1,2 m (4 ft.) high is effective for sheep. The top strand and, maybe, one or two others should be barbed, but smooth steel wire is preferably for the other strands if well strained.

If a sheep is able to push through a slack spot in a barbed wire fence, others will follow where they see hanging from one of the barbs a tell-tale piece of wool from the back of the absconder.

The lowest four strands should be 75 mm (3 in.) apart, with the first strand 50 to 75 mm (2-3 in.) above ground level. The next strand should be spaced 150 mm (6 in.) higher and the uppermost strands about 225 mm (9 in.) apart.

To ensure that the wires remain taut enough to prevent the sheep from squeezing through, the standards should be no further than 10 m apart with four droppers between, each no more than two metres apart.

One often sees the lower half of sheep fencing consisting of a half-metre high band of "pig netting". Although this is effective and does not need much straining, it is much more expensive than a plain seven-strand fence.

(a) Corner posts, strainers and fence anchors

Sheep fencing has to be taut and this means that the corner posts and strainers must be well anchored. Details of suitable anchor designs are illustrated in the Appendix.

Steel corner posts or strainers should be of substantial piping or railing and at least two metres in length. Preserved gum-poles or indigenous hardwood poles should have butts at least 250 mm in diameter. The indigenous trees listed below provide durable fencing poles:

<i>Common or vernacular names</i>	<i>Botanical names</i>
Mopane:	<i>Colophospermum mopane</i>
muTsviri, Hardekol:	<i>Combretum imberbe</i>
muKarati, umNondo:	<i>Burkea africana</i>
muPaka, muNyati, Tree wisteria:	<i>Bolusanthus speciosus</i>
muWanga, umBanga:	<i>Pericopsis angolensis</i>

7. DIP TANKS FOR SHEEP

In some areas of Rhodesia, sheep need to be dipped regularly to control ticks. In such cases the sheep are usually run through the cattle dip or spray race with satisfactory results. However, there are certain situations where separate dipping facilities for sheep are necessary, either because of the need for a specific sheep-dip mixture not suited to cattle, or because the sheep themselves will either get very dirty or will not immerse properly in a cattle dip.

The plans listed below are printed in the Appendix.

(a) *Circular dip tank:* This is a relatively cheap structure that nevertheless ensures complete wetting of the animal. Experience shows that this dip tank is awkward to construct and use.

By a series of pens and gates, the sheep are brought to the edge of the tank and then manhandled in. They then swim round to the steps and climb up into the draining pens.

(b) *Walk-through dip tank:* This tank is used where complete immersion is not necessary; when the only ticks to be controlled are the Bont tick and Bont-legged tick which attach themselves to bare patches of skin on the sheep's underline,

(c) *Plunge dip:* This tank uses the same principle as the cattle plunge dip in which complete immersion of the animal is sought. Although more expensive than the circular dip, it has the advantage that less physical labour is necessary to dip the sheep,

As a final point, it should be noted that no sill or ledge should be built above fluid level in a dip tank for sheep. Where these ledges exist, the sheep will attempt to emulate a mountain goat, and avoid its cold plunge by skipping from side to side.

(d) *Spray races:* Spray races are widely used for cattle in Rhodesia and have

also been developed for sheep in other countries, notably Australia. In Rhodesia no spray races have been designed specifically for sheep since the walkthrough and plunge dip tanks appear quite satisfactory.

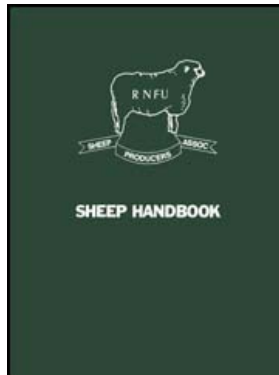

Sheep Handbook







Author(s): *D. J. Donkin*







Publication date: *1973*

Number of pages: *156*

Publisher: *Rhodesia Sheep Producers' Association, Ministry of Agriculture*

Contents:

-  [Acknowledgements](#)
-  [Introduction](#)
-  [Foreword](#)
-  [Chapter 1. The Rhodesian Sheep Industry](#)
-  [Chapter 2. Sheep Breeds in Rhodesia](#)
-  [Chapter 3. Breeding and Selection](#)

-  [Chapter 4. Management](#)
-  [Chapter 5. Sheep Management Calendars](#)
-  [Chapter 6. Nutrition](#)
-  [Chapter 7. The Grazing Sheep](#)
-  [Chapter 8. Handling Facilities](#)
-  [**Chapter 9. Marketing of Sheep**](#)
-  [Chapter 10. Wool](#)
-  [Chapter 11. Economics](#)
-  [Chapter 12. Diseases and Parasites](#)
-  [Appendices](#)
-  [General Information](#)

Chapter 9. Marketing of Sheep

[▲ Top](#)

F. J. B. ATKINSON

Sheep are not a controlled product in Rhodesia and producers have considerable freedom of choice in their disposal of their slaughter as well as their breeding stock.

It is Government's declared policy to encourage sheep production to the extent of attaining self sufficiency within the local market. At present, demand appears to exceed supply and for this reason the open market absorbs a large

proportion of the annual kill.

However, the Cold Storage Commission provides stability for the industry by maintaining a basic price schedule and, by offering monthly premiums additional to its basic price, will probably increase its proportion of the national offtake.

1. SLAUGHTER SHEEP

Certain parts of Rhodesia are prescribed areas within which the carcasses of all livestock slaughtered for sale must be graded immediately after slaughter by Government graders in accordance with specified standards. Inspection of meat is also carried out to ensure that it is fit for human consumption.

The carcasses are then roller marked to indicate their grade to the consumer. The current grading regulations are set out on page 9.4.

Abattoirs are operated by the Cold Storage Commission, by some municipalities and by private enterprise.

The CSC, operating as a wholesaler, supplies retail outlets as do some of the private abattoirs. Municipal abattoirs do not purchase sheep but slaughter them on a service basis for butchers.

A producer wishing to dispose of slaughter sheep has the following alternatives:

(a) Sale to the Cold Storage Commission

The CSC, a statutory body, undertakes to purchase all sheep offered for slaughter at its abattoirs in Salisbury, Bulawayo, Fort Victoria and Umtali. Payment is made by reference to the cold dressed mass of the carcass and to the grade and price schedule.

The basic guaranteed prices are reviewed annually by producer representatives, the Agricultural Marketing Authority and Government. The current schedule is contained in Table 9.1.

From the 1st September, 1973, the CSC will publish each month a premium which it will pay in addition to the basic price schedule referred to previously. The premium will operate on a monthly basis and may vary according to circumstances and grades. The premium will be announced in the Rhodesian Farmer at the end of each month for the ensuing month, and will apply to the four CSC abattoirs mentioned.

When sheep are sold to the CSC, the fifth quarter (skin, offal, head) becomes the property of the Commission. It is advisable to make advance booking for slaughter at CSC works by telephoning or writing to the respective abattoir so as to avoid possible delays in slaughtering.

(b) Sale to private abattoirs

Some privately owned abattoirs publish prices for slaughter sheep either on a

live or dressed mass basis. In other cases prices are negotiated between the producer and the abattoir and separate arrangements should be made in advance if the producer wishes to process the skins himself.

(c) Sale to butchers

Butchers trading in the prescribed areas may buy wholesale from the CSC or from private abattoirs. They may also negotiate direct with producers and have their purchases slaughtered, graded and inspected through a service slaughtering arrangement with an abattoir.

Purchase is arranged between the producer and the butcher and can be on a live or on a dressed mass and grade basis. Purchase agreements should be explicit so as to avoid subsequent confusion. By negotiation, producers can arrange to recover the skins which, in the case of woolled sheep, are a worthwhile by-product after subsequent processing by the producer. Mass and grade sheets are made out for each consignment and are sent to the owner of the sheep. The farmer is advised to arrange with the butcher to have access to these so that he can adjust his management in the light of results.

Butchers outside the prescribed areas would normally purchase sheep on a live mass basis for slaughter by themselves.

2. GRADING

Producers, wherever possible, should be present when their sheep are being

graded so as to be better able to assess the effects of their management on the finished product. The ability to relate appearance on the hoof and on the hook is an invaluable aid to good husbandry.

Should the seller disagree with the Government grader's assessment of his sheep carcasses, provision has been made for him to lodge an official appeal. This must be done by notifying the grader at the time of grading and before the carcasses are removed. This makes attendance at grading even more important. Written notification must then be sent to the Secretary for Agriculture together with a deposit of \$20 within 72 hours of lodging his appeal. The carcasses are then regarded and if the objection is upheld the deposit is returned



**SHEEP PRODUCERS!
THE CSC NEEDS
YOUR SUPPORT**

The CSC has an obligation to
supply its customers with good



quality mutton and lamb as well as with Rex beef.

It offers you a guaranteed market at competitive prices.

It will accept all the sheep and lamb you can send.

So contact the CSC — the marketing experts: Salisbury, Bulawayo, Ft. Victoria, Umtali.

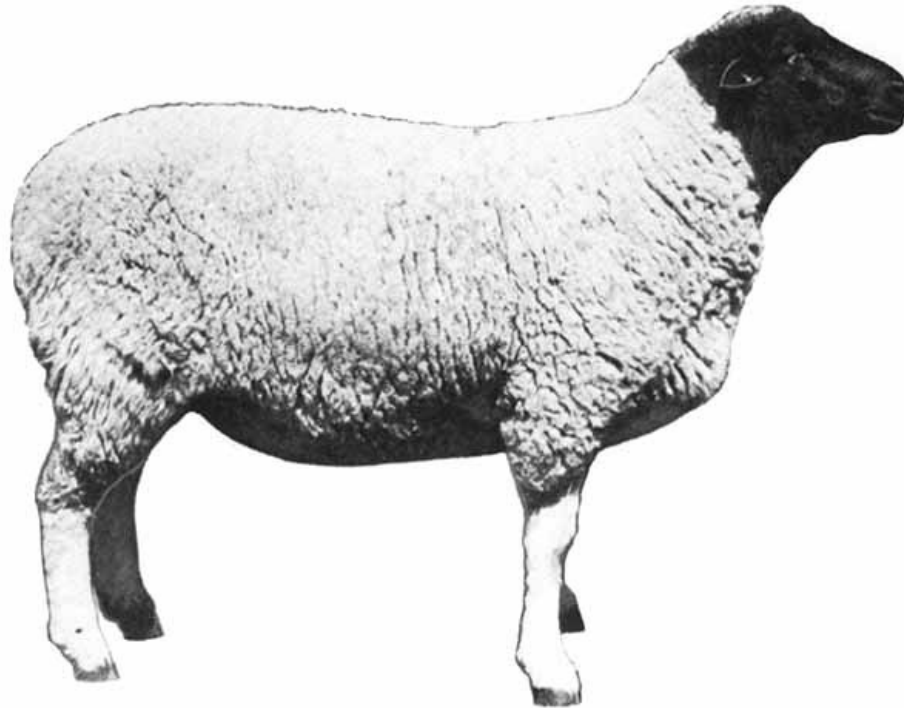

Lintas CSC/29

3. STORE SHEEP AND BREEDING STOCK

In Rhodesia non-slaughter sheep are customarily sold by private treaty or public auction.

The Livestock Improvement Committee of the Ministry of Agriculture publishes a bi-annual list of pedigree and grade breeding stock available for sale; these lists are available for perusal at RNFU branch offices.

*Contributed by F. J. B. Atkinson
(5.9.73.)*



RHODESIAN MEAT SUPPLIERS

(PRIVATE) LIMITED

P.O. BOX 356, MARANDELLAS TELEPHONE 269112

PRODUCERS OF "DELLAS" QUALITY PRODUCTS

WE HAVE PAID CONSISTENTLY THE HIGHEST
PRICES FOR LAMB AND MUTTON

4. GRADE DEFINITIONS OF SHEEP CARCASSES

(Government Notices 1209 of 1972, and 828 of 1973)

- 1. SUPER LAMB - Well finished carcasses of good conformation and high quality, with an even distribution of fat, derived from wether, ewe or ram lambs with no permanent incisors. Ram lambs showing secondary masculine characteristics shall be graded as Inferior. Excessively fat carcasses shall be graded as Lamb 1.**
- 2. LAMB 1 - Moderately finished carcasses of fairly good conformation, with a reasonably even distribution of fat, derived from wether, ewe or ram lambs with no permanent incisors, Ram lambs showing secondary masculine characteristics shall be graded as Inferior.**
- 3. LAMB 2 - Carcasses of fair conformation and finish, derived from wether, ewe or ram lambs with no permanent incisors. Ram lambs showing secondary masculine characteristics shall be graded as Inferior.**
- 4. LAMB 3 - Carcasses of poor conformation and finish, derived from wether, ewe or ram lambs with no permanent incisors. Ram lambs showing secondary masculine characteristics shall be graded as Inferior.**
- 5. CHOICE MUTTON - Well finished carcasses of good conformation and quality, with an even distribution of fat, derived from wethers or ewes having not more than four permanent incisors. Excessively fat carcasses shall be graded as**

Choice Mutton 2.

6. CHOICE MUTTON 2 - Carcasses of fairly good conformation and moderate finish, with a reasonable distribution of fat, derived from wethers or ewes having not more than four permanent incisors.

7. PRIME MUTTON - Well finished carcasses of good conformation and quality with an even distribution of fat, derived from wethers or ewes with six or more permanent incisors. Excessively fat carcasses shall be graded as Prime Mutton 2.

8. PRIME MUTTON 2 - Carcasses of fairly good conformation and moderate finish, with a reasonable distribution of fat, derived from wethers or ewes with six or more permanent incisors.

9. MUTTON 3 - Carcasses of fair conformation, finish and quality, derived from wethers or ewes of any age.

10. INFERIOR - Carcasses of very poor conformation and finish derived from wethers or ewes of inferior quality and carcasses derived from rams. This grade shall include carcasses which fail to qualify for the lamb grades.

**TABLE 9.1. GRADES AND PRICES OF LAMB AND MUTTON
As at 1st September, 1973**

Grade	Sex**	Conformation	Finish	Fat	Permanent	Basic	Roller
-------	-------	--------------	--------	-----	-----------	-------	--------

		and quality		distribution	incisors	price c/kg cdm ***	marking and colour
Super Lamb	W,E,R*	Good	Good	Even. Excessive fat downgraded to Lamb 1.	Nil	75	SUPER LAMB(Purple)
Lamb 1	W,E,R*	Fairly good	Moderate	Reasonably even	Nil	70	LAMB 1111 (Brown)
Lamb 2	W,E,R*	Fair	Fair		Nil	60	LAMB 2222 (Red)
Lamb 3	W,E,R*	Poor	Poor		Nil	40	LAMB 3333 (Black)
Choice Mutton	W,E	Good	Good	Even. Excessive fat downgraded to Choice Mutton 2	Up to 4	65	CHOICE MUTTON (Purple)

Choice Mutton 2	W,E	Fairly good	Moderate	Reasonable	Up to 4	63	CHOICE MUTTON 2222 (Brown)
Prime Mutton	W,E	Good	Good	Even. Excessive fat downgraded to Prime Mutton 2	6 or more	60	MUTTON 1111 (Black)
Prime Mutton 2	W,E	Fairly good	Moderate	Reasonable	6 or more	50	MUTTON 2222 (black)
Mutton 3	W,E	Fair	Fair	-	All classes	30	MUTTON 3333 (Black)
Inferior	W,E,R	Very poor	Very poor	-	All classes including lambs	15	4444 (Black)

*** Ram lambs showing secondary masculine characteristics shall be graded as Inferior.**

**** W denotes wether (Hamel), E denotes ewe, R denotes ram.**

***** These are the CSC basic prices to which are added the monthly premiums as published in the Rhodesian Farmer on the last Friday of each month.**

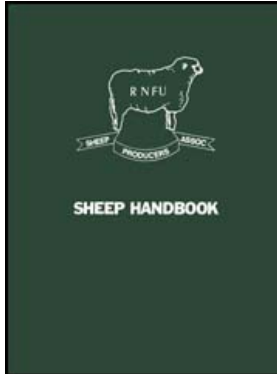

Sheep Handbook





Author(s): *D. J. Donkin*

Publication date: *1973*













Number of pages: *156*

Publisher: *Rhodesia Sheep Producers' Association, Ministry of Agriculture*

Contents:

-  [Acknowledgements](#)
-  [Introduction](#)
-  [Foreword](#)
-  [Chapter 1. The Rhodesian Sheep Industry](#)
-  [Chapter 2. Sheep Breeds in Rhodesia](#)



-  [Chapter 3. Breeding and Selection](#)
-  [Chapter 4. Management](#)
-  [Chapter 5. Sheep Management Calendars](#)
-  [Chapter 6. Nutrition](#)
-  [Chapter 7. The Grazing Sheep](#)
-  [Chapter 8. Handling Facilities](#)
-  [Chapter 9. Marketing of Sheep](#)
-  **[Chapter 10. Wool](#)**
-  [Chapter 11. Economics](#)
-  [Chapter 12. Diseases and Parasites](#)
-  [Appendices](#)
-  [General Information](#)

Chapter 10. Wool

[▲ Top](#)

D. J. DONKIN

Ancient inscriptions and records indicate that sheep were among the earliest of the domesticated animals and that they were kept mainly for their wool. In Rhodesia today, sheep are regarded primarily as a source of meat, but because there are several flocks of dual-purpose (wool/mutton) sheep in the country it is well to take a closer look at this wonder fibre that man has used for his clothing and protection over so many centuries.

Over 100 sheep breeds are recognized in the world today, and one of the main distinguishing features of each breed is the wool it produces. The Karakul has a very coarse wool that is best suited for blankets and carpets, but the outstanding characteristic of this breed is the exquisitely coloured, delicately soft pelt that can be obtained from the new-born lamb. At the other end of the wool-sheep scale is the superfine Merino, whose wool fibres can be manufactured into the most delicate and, at the same time, most durable fabrics.

Pure wool breeds of sheep should have no hair in the fleece, but the breeder can be sure that some hair will be present in the fleece of a sheep crossbred between woolled and non-wool parents. Hair is undesirable in wool because it lacks the elasticity of wool, and furthermore it cannot be spun. Generally, some hair will be found in the fleece of lower grade individuals within wool breeds, usually in the region of the britch (hindquarters). One type of hair that is particularly objectionable is kemp. Kemp is a hair fibre that does not grow continuously, but detaches itself from the skin in 15 mm lengths; it has a staring white colour that does not absorb dyes and it will not bind with wool in spinning or weaving.

1. THE CHARACTERISTICS OF WOOL

Over recent years the vast expansion of the man-made fibre industry has brought a whole range of new words into our everyday speech - nylon, terylene, orlon, courtelle, to name but a few. These very wonderful technical

achievements have developed fibres which drip-dry, are uniform, shrink-proof, relatively cheap and can be produced to order in virtually unlimited quantities. It was assumed by many of the new technocrats that these characteristics of artificial fibres would lead to the progressive elimination of natural fibres such as wool from the world textile scene. That, in an expanding market, wool consumption has remained essentially static while prices have fluctuated considerably, has appeared to lend some support to their ideas. Nevertheless, wool has certain essential and unique characteristics that no artificial fibre has yet attained and these are bringing about a reappraisal of the uses and value of wool.

These characteristics can be listed as follows:

(1) Serrations A wool fibre is made up of a series of scale-like cells, which catch or "hook" on to adjoining fibres. These give wool its strong yarn-making characteristics, and protect it from chemical action, for example, from detergents.

(2) Crimp The wave, or crimp, in wool is plainly visible. The crimp number varies between breeds and the degree of *fineness* (fibre diameter) of the wool. Generally, the more crimps per unit length the finer the wool, but this is not an absolute relationship. Nutritional or other stress, such as during a drought or when the sheep is sick, can reduce fibre thickness and thus the tensile strength or *soundness* of the wool. Wool affected in this way is described as tender and will

break when put under tension.**Table 10.1 The Duerden standards for spinning count, crimp and fibre diameter (Hugo 1966)**

Spinning count	No. of crimps per 25,4 mm (1 in)	Fibre diameter microns ($\mu = 0,001$ mm)
150	28 to 30	14,0 to 14,7
120	25 to 27	14,7 to 15,4
100	22 to 24	15,4 to 16,2
90	20 to 21	16,2 to 17,0
80	18 to 19	17,0 to 17,9
70	16 to 17	17,9 to 18,9
66	14 to 15	18,9 to 20,0
64	12 to 13	20,0 to 21,3
60	10 to 11	21,3 to 23,0
58	8 to 9	23,0 to 25,5

The crimp of wool is usually described by the term *spinning count*. This is a numbering system derived in Bradford to indicate the number of hanks 560 yards in length that can be spun from one pound of carded wool. Thus, a spinning count of 60s indicates that, after washing and carding, about 60 hanks can be spun from one pound of wool.

The relationship between spinning count, crimp and fibre diameter is indicated in Table 10.1. In the leading wool markets of the world a more scientific measurement of fibre thickness is superseding the traditional visual assessment of spinning count.

(3) Elasticity Wool can return to its normal length after being stretched, and this makes for firmness and strength in knitted and manufactured fabrics.

(4) Length Wool grows continually and is usually shorn from a sheep once a year. The length of a year's growth depends on the sheep itself, its breed, the level of feeding and the part of the sheep's body from which it was shorn.

The length of the fibre determines the best use to which it can be put. Typical average 12-month staple lengths of breeds common in Rhodesia are as follows:

Pure Merino	80 mm (3 in.)
Mutton Merino	70 mm (2¾ in.)
Corriedale	100 to 120 mm (4 to 4½ in.)
Suffolk	50 to 60 mm (2 to 2½ in.)

(5) Non-conductivity of heat Wool has always been popular as a means of insulating man from the colder extremes of his environment, in garments, blankets and rugs. At the other, hotter extreme, woollen car-seats are becoming increasingly popular and make motoring more pleasant in hot weather.

(6) Hydrosopic properties Wool has the ability to absorb moisture up to 33 per cent of its dry mass.

(7) Non-inflammability Wool does not burn readily and this valuable characteristic makes it of particular value in carpets, suits for airmen, racing drivers and so on.

(8) Felting properties No other textile fibre can compare with wool in its ability to *felt* or entangle to form a dense compact fabric. Felt hats provide a common example of the use of wool felt. Fine wools show a greater readiness to felt than strong wools.

(9) Durability Woollen textiles are very durable for their mass. Generally the coarser or thicker the wool fibre - *stronger* in wool terminology - the more durable it is, but of course this limits its use.

(10) Softness This is one of the most important selling points of woollen products.

(11) Colour Most commercially produced wool is naturally white and this is important in indicating the degree to which dye can be absorbed.

Modern wool technology has also developed processing methods that virtually eliminate the tendency of wool to shrink when washed.

2. THE PROCESSING OF WOOL

The purpose of this section is to indicate briefly to the producer what happens to his wool clip after it is sold and why it is in his own interest to class his wool.

(i) Sorting After purchase, the wool is sorted according to its potential uses. Therefore, the producer should aim to class his wool into even *lines* so as to raise the price. If the lines are uneven and mixed they will take longer to sort and furthermore, the buyer will pay less to protect himself.

(ii) Scouring After sorting, the wool is washed or *scoured* to remove all grease, dirt and sand. The amount of wool left is known as the *clean yield*, and is expressed as a percentage of the mass of the original grease wool. The clean yield can vary by as much as 40 to 70 per cent. Wool in a *heavy condition* - much grease and dirt and a low clean yield - will require more scouring and therefore, will fetch a correspondingly lower price.

(iii) Carding Once the scoured wool has been dried, it is *carded*. In this process the wool is stripped through opposing sets of fine wire bristles backed on cards. This has the effect of disentangling and aligning the fibres so that they can be spun into yarns. Some burrs and grass seed are also removed in this process. In the trade, carded wool is known as *top* and is used for woollens.

(iv) Combing Following carding, certain longer wools may then be combed to make the fibres even more parallel; these long wools are used in worsted manufacture.

(v) Carbonizing Wools that are heavily contaminated with grass seed and other vegetable matter that cannot be removed during the previous processes must be treated with hot acids. These reduce the grass seeds to carbon which can then be crushed with rollers and shaken out. It is obvious that such techniques will be expensive.

(vi) Spinning The clean top or combing wool is then spun into yarn which can be dyed or otherwise treated.

(vii) Weaving Spun yarns are woven into cloths of varying patterns and textures.

From the foregoing outline it is obvious that the producer should class his wool according to three main criteria, namely length, fineness and condition (clean yield), since these factors affect what has to be done to the wool before it is ready for use and the use to which it can be put once it is processed.

3. ELEMENTARY WOOL CLASSING

Wool is best classed immediately after shearing, so that wools of similar lengths - having a maximum difference of 25 mm between classes - fineness (strong wools and fine wools) and degrees of condition are put together in even lines. See Figure 10.1.

Wool is sorted in the following sequence - the common abbreviation is printed at the start of each section:

(1) BRANDS: This is short wool permanently marked with branding paint, tar or worm remedies. As these wools cannot dye evenly, they have very little use and should be trimmed off the sheep before shearing commences.

(2) LOX: The term *lox* includes all sweat, dung-and urine-stained wool, brisket wool, topknots, leg trimmings, cheek wool and sweepings. All very inferior, very short pieces are downgraded further and termed LOX 2. Lox may form 10 to 12 per cent of the clip by mass.

(3). BP: The *bellies* and *pieces* often comprise 12 to 14 per cent of the clip. Belly wool usually lacks staple and is over-short and dirty; the pieces comprise all the fleece *skirtings*, that is the deviating portions that are removed when the fleece is on the wool classing table to ensure that the main fleece is of a uniform type.

(4) BKS: The *back* is removed from the rest of the fleece if it is markedly dirty, weathered or *tender*, that is, it is weakened by stress and breaks when put under tension. Wool that is not tender is described as *sound*. Backs can comprise 15 to 30 per cent of the clip.

For the more detailed information necessary for selling wool on the open market, wool producers should obtain a copy of the booklet *Classing Standards* published by the National Wool Growers' Association, P.O. Box 1378, Pretoria, Republic of South Africa. The price is 25c, plus postage.

4. SHEARING SHEEP

Several different techniques of shearing sheep may be adopted, all of which are highly effective when used by an experienced shearer. In Rhodesia, hand

shears are still used by most shearers and are all that are warranted where flocks of wool sheep are normally 200 or less. For larger flocks the capital expenditure on a shearing machine - over \$200 per unit - is perhaps warranted, but a supply of good-quality hand shears is still necessary in case of mechanical breakdown, or for odd jobs such as crutching or general trimming. Good-quality sheep shears are available from certain veterinary equipment suppliers at prices of about S3 per pair. Several inferior types of so-called sheep shears are also on the market.

(a) The shearing shed

Owing to the smallness of Rhodesian sheep flocks and the multiple enterprises of most farms, there are no specially designed shearing sheds in this country. Nevertheless, it will be useful to know certain principles of shearing-shed design so as to choose wisely when selecting and modifying an existing farm structure for shearing.

Floor This should be dry and dust-free and kept swept and clean during shearing operations. A clear uncluttered area of at least two metres × two metres should be allowed for each shearer.

Natural light Good light is essential for shearing, but more particularly for classing the wool. Natural light is always preferable, provided either by roof-lights or large windows.

Ventilation Shearing is hard work and is usually done during the hotter time of

the year; a good through-draught is therefore essential for the comfort of the shearers and the sheep.

Catching pen Shorn sheep and those immediately due to be shorn should be held in a small pen, close enough to each shearer to avoid any undue waste of time and energy in removing a shorn sheep from the shearing area and bringing on an unshorn one to replace it. The catching pen should be cleared of shorn sheep and re-stocked with unshorn sheep by an assistant who is not himself involved with shearing.

Holding pen Sheep to be shorn should be penned the night before in a roofed area. This is necessary because wet sheep cannot be shorn and overnight rain or even heavy dew and wet grass can delay shearing in the morning.

Equipment In addition to effective shears or a shearing machine, a good wool-skirting table is a great aid to effective wool classing. To hold a full size fleece from a mature sheep, such a table should be about one metre high, 1,5 metres wide and 2,1 metres long. The top should be slatted to allow dirt and second cuts to fall through.

Sufficient wool bins should be available for each of the wool classes to be taken out. A suitable size is 1,0 metre wide, 1,3 metres deep and 1,7 metres high, open along part of the front.

Wool should be packed in jute or paper woolpacks or clean new grainbags. Bales should be neatly and tightly pressed and weigh between 125 and 145

kg. Smaller quantities should be packed in grainbags or alternatively separated within a bale by a clearly marked paper division,

(b) The shearing sequence - for a right-handed shearer.

The most important single skill when shearing sheep is the ability to hold the animal so that it does not struggle and, at the same time, permit the shearer free use of his hands for the job of removing the fleece.

(i) Stand on the left side of the sheep with the left hand under its jaw. Bend over the body and, with the right hand, grasp the animal's left hind leg (or right flank if it is a big sheep) and pull the sheep into a sitting position with its back against the shearer's knees.

(ii) Clip an opening down each side of the belly, lifting the front legs out of the way with the free hand. Then clear the wool off the brisket down to the belly.

(iii) Shear the belly latitudinally in sweeps 30 mm wide across from right to left. Pull the skin tight using the left hand. Especial care should be taken to avoid snipping the penis of rams and wethers and the teats of ewes. Remove and pack the belly wool separately.

(iv) Carefully remove the lox in the crutch and around the tail.

(v) Push with the left hand into the groin to make the hind leg stretch

out straight to facilitate shearing the leg wool. Repeat with the other hind leg. Then allow the animal to fall back further to enable the wool to be clipped completely from both legs and right around the tail. This wool is part of the fleece and should not be removed.

(vi) Sit the sheep up again. Trim the *shankings* off the front legs and, on each leg clip the wool back to the upper joint.

(vii) Now change position by sitting the sheep sideways to the shearer using his left leg as a back/side support; his right foot is positioned on the floor between the sheep's hind legs. In this position the free hand is used to push the animal's head to the left over the shearer's left thigh, thus stretching the skin along the neck. Clean off the cheek wool and top-knot and then commence shearing the neck, starting from the right shoulder and opening up to the base of the right ear. Successive "blows" or sweeps with the shears follow the longitudinal pattern around the front of the neck until the left shoulder is reached. Then change position so that the sheep is now sitting facing the shearer supported by its upper forelegs between his knees and his left hand behind its neck. Then continue shearing off the fleece latitudinally until both shoulders are free.

(viii) At this stage the "blows" around the sheep's back become too long, so a common practice is to continue shearing down the sheep's left side (to the shearer's right) going only up to the centre line of the

back. When this side is cleared the other side of the back is cleared similarly, dropping the sheep forward progressively on to its knees as the shearer moves down the back and finally joins up with the cleared area over the tail.

In this way the fleece will stay together and can be removed progressively from the sheep, so that at the end the animal may stand up and be led away from its fleece which is lying "skin-side up" on the floor.

Any cuts should be treated with healing oil or powder immediately after shearing, before the sheep is put back into the catching pen.

(c) Throwing the fleece

The fleece on the floor should then be pulled into shape and picked up in layers or folds rather like a concertina, so that when it is thrown it falls spread out on the table with the desired side upwards. The region of the britch (hind-end) is grasped first and held firmly between the thumb and index finger of each hand while the fleece is gathered. Stand about one metre from the table and throw the fleece "up and away" across the table.

Normally the fleece is thrown with the skin-side down, but where fleeces contain a lot of feed particles, grain and dust it is often preferable to throw the fleece skin-side up so that much of this dirt will fall out through the table top.

(d) Skirting the fleece

Once the fleece is well spread the wool classer should commence *skirting*, that is, removing all atypical wool along the fringe of the fleece. See Figure 10.1. Particular attention should be paid to the britch area and to the neck folds. Skirtings should be separated broadly into lox and atypical fleece wool.

The back should then be separated out if necessary, and finally, the fleece should be tested for soundness and typed into one of the fleece lines according to its length and fineness.

Any such written description of shearing and wool classing is bound to be inadequate; novices and new producers are advised to contact their Conex Animal and Pasture Specialist for an on-farm demonstration. In addition, Conex courses in shearing and elementary wool classing are run from time to time when the demand arises.

5. MARKETING OF WOOL

Rhodesian wool producers have the opportunity to sell their product in two alternative ways, either to the various local handweaving cottage industries or via the open market.

The convenience, and the stability of prices in local industries ensure that the bulk of the country's wool clip is marketed locally; it is possible that the proportion sold locally will increase in the future, depending on the

development of local industries.

Local wool industries

Several "cottage" industrial centres in Rhodesia now buy raw wool and convert it into hand-made rugs, car-seat covers and homespun materials. Most of these organizations have fairly simple equipment and, although they manage to wash and dye wool effectively, they are not equipped for carbonizing. In consequence, they are extremely reluctant to accept wool that is heavily infested with burrs or grass seed.

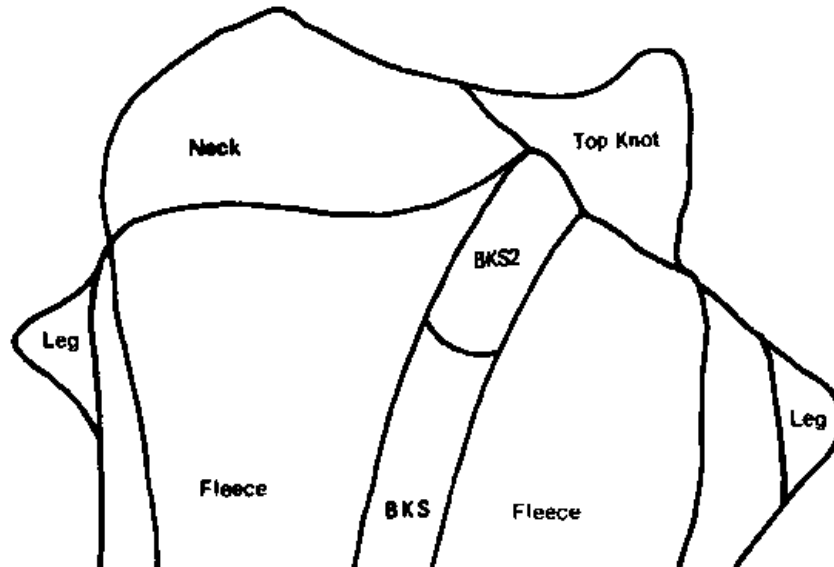

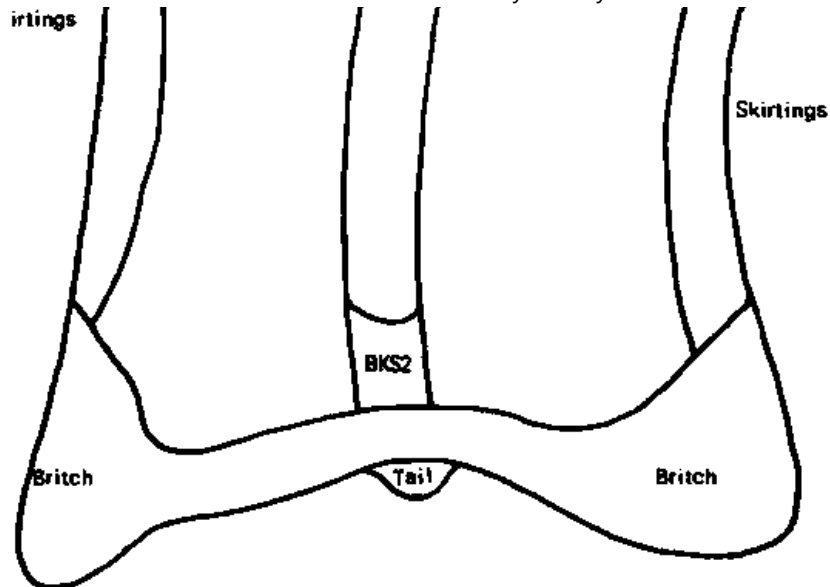

FIG. 10.1. DIAGRAM SHOWING SITES OF DIFFERENT WOOL TYPES IN A SHORN FLEECE

Length of staple is important in rug making and in the spinning of yarns, while the condition determines not only how many times the wool will have to be washed and rinsed, but will also affect the final clean yield.

Bearing these conditions in mind, local industries base the prices they pay for raw wool mainly on length and condition (cleanness) of the wool.

Producers who intend to sell wool on the local market are advised to grade their wool into the following classes at shearing:

LOX (LOX 2)

BP

BKS

A fleeces

B fleeces

Any very heavy-conditioned fleeces (e.g. rams) should be kept separate, as should any that contain a heavy burden of grass seeds.

For the information of farmers who wish to know where to sell their wool, the Livestock Department of the Rhodesia National Farmers' Union maintains a list of organizations that purchase wool in Rhodesia.

The open market

Producers who wish to make use of the open market must, in the first instance, get in touch with a wool broking firm. The broker will then supply sufficient approved wool packs to transport -the clip, as well as information about the necessary documents that must be dispatched with the clip.







Very strict conditions must be adhered to when marketing wool by auction. These are detailed in the Classing Standards booklet mentioned at the end of

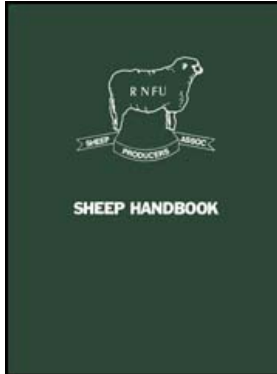









Section 3 of this chapter. Where the clip is big enough to warrant separate bales for each wool class, the wool must be properly classed according to approved standards. Most clips in Rhodesia are too small to meet this criterion however, and in such cases the main classes are separated by a layer of paper within the bale which is then marked BIN. This means that the wool broker will open the bale and blend the different classes of wool into similar lots of wool from other sources. The producer will then be paid the average price realized when each blended lot has been sold. The broker charges a binning fee of about 0,5c per kilogram of wool dispatched to him in this way.

For more detailed information on wool production and marketing, farmers are advised to contact the Animal and Pasture Section of CONEX through their local extension officer.



The correct way to hold a sheep to start shearing.**Photo Ministry of Agriculture.** **Sheep Handbook****Author(s): D. J. Donkin****Publication date: 1973****Number of pages: 156****Publisher: Rhodesia Sheep Producers' Association, Ministry of Agriculture****Contents:**

-  [Acknowledgements](#)
-  [Introduction](#)
-  [Foreword](#)
-  [Chapter 1. The Rhodesian Sheep Industry](#)
-  [Chapter 2. Sheep Breeds in Rhodesia](#)
-  [Chapter 3. Breeding and Selection](#)

-  [Chapter 4. Management](#)
-  [Chapter 5. Sheep Management Calendars](#)
-  [Chapter 6. Nutrition](#)
-  [Chapter 7. The Grazing Sheep](#)
-  [Chapter 8. Handling Facilities](#)
-  [Chapter 9. Marketing of Sheep](#)
-  [Chapter 10. Wool](#)
-  **[Chapter 11. Economics](#)**
-  [Chapter 12. Diseases and Parasites](#)
-  [Appendices](#)
-  [General Information](#)

Chapter 11. Economics

[▲ Top](#)

B. B. WILSON

Comparatively little information is available on the profitability of sheep production in Rhodesia. This chapter seeks to throw some light on the subject by, firstly, examination of the results obtained by farmers participating in the RNFU Management Accounting Service and the Economics and Markets Branch of the Ministry of Agriculture Recording Scheme and, secondly by means of a theoretical costing of one of the management systems put forward in Chapter 5 of this book.

1. FARMER RESULTS

Results are available from 65 farmers who made use of the two recording schemes during the 1970/71 season. Of these, 34 or over 52 per cent were shown to have made losses, and only 19 achieved profit margins of \$2 or more per ewe.

The reasons for this sorry state of affairs are not entirely clear and will have varied from case to case. In general, it appears that low productivity rather than high costs was behind the failure to make profits, although there were a number of exceptions. The low productivity, in turn, appears to be linked to poor lambing percentages and high mortality.

From the flock sizes, it seems likely that the sheep enterprise was very much a sideline on most farms and that the level of management probably suffered on this account.

A more encouraging picture is obtained from the top third of the combined sample, and these results are shown in Table 11.1. Even among these above-average farmers, there is a very wide range both of input costs and of profitability, but some of the figures appear rather dubious.

The average gross margin of \$3,88 per ewe, while not very exciting, goes some way towards achieving the budget figure of over \$5 per ewe put forward in the next section of this chapter.

2. THEORETICAL MODEL OF 200-EWE FLOCK

The model is put forward as a basis for discussion rather than as an authoritative statement of what will happen, and constructive comments would be welcome. It is intended to revise the model in the light of such comments and of further experience and information.

Basic assumptions

- (i) Spring lambing.**
- (ii) Sales consist of pen-fattened lambs, plus cull ewes and rams.**
- (iii) No wool income.**
- (iv) Effective lambing (weaned and sold) taken as 100 per cent arising from an actual lambing of 115 per cent, assuming the balance to have been lost.**
- (v) Mortality of ewes taken as five per cent.**
- (vi) Replacement rate of ewes taken as 20 per cent.**

TABLE 11.1: Combined result: Top third of recorders 1970/71

	Per ewe
--	---------

Item	Av. \$	Range \$	Remarks
Labour	2,47	0,34 - 6,13	
Tractor expenses	0,04	0,00 - 0,65	Only in 7 cases
Purchased feed	0,38	0,00 - 2,51	
Home-grown feed	0,59	0,00 - 5,89	
Veterinary medicines, dips	0,55	0,00 - 1,36	
Other	0,38	0,00 - 2,47	
Total direct costs	4,41	0,44 - 10,37	
Gross income	8,29	2,31 - 21,08	
Gross margin	3,88	1,73 - 12,89	
Labour days	5,38	1,70 - 10,48	From 13 farms only
Av. no. of ewes	146	12 - 316	
Av. no. of head	256	43 - 649	
Births as % of ewes	123	6 - 228	Extremes suspect
Deaths as % of head	11,75	0 - 37	

No. in sample.	22	-
----------------	----	---

NOTE: Of the 22 flocks summarized above, only two produced a total gross margin in excess of \$1 000, and a further three in excess of \$750.

The Cotton Co-op.





**FOR ALL
SHEEP FARMING
REQUIREMENTS**

Efficient service • Value for money

**BULAWAYO : P.O. Box 1531 UMTALI : P.O. Box 225 GATOOMA : 206A Rhodes Street UMVUKWES : P.O. Box 91
SINOIA : P.O. Box 99 GWELO : A.A.A. (Pvt.) Ltd., P.O. Box 404 BARKET : Raffingora Agency, P.O. Box 164
HARTLEY : Hartley Land & Estate, P.O. Box 99**

TABLE 11.2: Budgeted results for 200-ewe flock

	200 Ewes	Per Ewe
	\$394	\$1,97
Tractor expenses	20	0,10
Purchased feed	610	3 05
Home-grown feed.	424	2,12
Veterinary, medicines, dips	200	1,00
Other	120	0,60
Total direct costs	\$1 768	\$8,84
Gross income (Trading profit)	2,805	14,02
Gross margin	\$1 037	\$5,18

BUDGETED COST ITEMS (TABLE 11.2)

Total direct costs for the flock are estimated at \$1 768 or \$8,84 per ewe.

These are derived as follows:

(a) Labour

One shepherd at, say, \$20 per month, including rations	\$240
One assistant at, say \$12 per month, including rations	144
Casual labour, 20 days, at say, 50c	10
	\$394 =
	\$1,97
	Per ewe

(b) Feeds

(i) Maintenance and supplementary

July-August

Whole flock 248 head for 60 days at 50 g cotton seed cake per day = 744 kg CSC*

September-November

40 Ewe replacements: for 90 days at 50 g CSC = 180 kg CSC

Pre-lambing

200 ewes for 42 days at 340 g CSC = 2 856 kg CSC

and 200 ewes for 30 days at 200 g maize = 1 200 kg maize

Post-lambing

200 ewes for 50 days at 340 g CSC = 3 400 kg CSC

200 ewes for 50 days at 370 g CSC

= 3 700 kg CSC

and 200 ewes for 50 days at 300 g maize

= 3 000 kg maize

Pre-service

**Eight rams for 60 days at 1,5 kg per day 1:10 mixture of CSC and corn and cob;
Maize equivalent at 90 per cent: 600 kg; CSC: 65 kg.**

* CSC = Cottonseed cake.

(ii) Pen feeding

To fatten lambs from 25 kg to 42 kg at \pm 1,5 kg per week will take + 11 weeks.

Using a mixture of one part 64 per cent protein concentrate: nine parts snapcorn at an average of 1,2 kg per day

77 days x 1,2 kg =

92 kg of mix

160 lambs x 92 kg =

14 720 kg of mix

of which 64 per cent protein concentrate is

1 472 kg

Maize equivalent at 80 per cent is

10 598 kg

Total feed costs

CSC 7 245 kg at \$67,53/tonne	\$489,25
64 per cent protein concentrate	
1 472 kg at \$81,60	120,12
Total purchased feed	\$609,37
	say \$610
Maize (home-grown) 15 398 kg at \$27,50/tonne	\$423,44
	say \$424

(c) Veterinary expenses

(i) Roundworms

Say, 250 head adult sheep x 10 doses at 5 cent	\$125,00
Say, 200 lambs x 3 doses at 3 cents	18,00

(ii) Wireworms

Say, 250 head x 1 dose at 0,5 cent	1,25
------------------------------------	------

(iii) Tapeworm

Say, 200 lambs x 1 dose at 3 cents	6,00
------------------------------------	------

(iv) Pulpy kidney

Sav. 250 adult stage x 1 = 5 bottles at \$1.25	6.25
--	------

Say, 200 lambs x 3= 12 bottles at \$1,25	15,00
--	-------

(v) Blue tongue

Say, 450 head x1=9 bottles at \$0,75	6,75
	\$178,28

Plus - Miscellaneous costs to \$200 or \$1,00 per ewe.

(d) Tractor expenses

An arbitrary figure of \$20, or \$0,10 per ewe, is allowed to cover on-farm transport.

(e) Other

An arbitrary figure of \$120, or \$0,60 per ewe, is allowed to cover expenses for which provision was not otherwise made.

TRADING ACCOUNT (Table 11.3)

The trading account shows a gross income (Trading profit) of \$2 805 or \$14,02 per ewe.

Sales income is assumed to be derived as follows:

Lambs: Average 20 kg c.d.m.: "Super lamb" at 75c/kg, \$15 each.

Cull ewes: Average 27 kg c.d.m.: "Mutton 1 and 2" at average 63c/kg, \$17 each.

Rams: Average 50 kg c.d.m.: "Inferior" at 15 c/kg \$7,50 each.

TABLE 11.3: Trading account for model 200-ewe flock

	Opening stock			Closing stock	
8	Rams at \$50	\$400	8		\$400
200	Ewes at \$15	3 000	200	Ewes	3 000
40	One-Year ewe lambs at \$10	400	40	One-Year ewe lambs	400
248		\$3 800	248		\$3 800
	Births			Deaths	
230	Lambs		30	Lambs	
			10	Ewes	
			40		
	Purchases			Sales	

2	Rams at \$60	120	160	Fat lambs at \$15	2 400
			30	Cull ewes at \$17	510
			2	Cull rams at \$7,50	15
Gross income (Trading profit)		2 805	192		\$2 925
480		\$6 725	480		\$6 725

DISCUSSION

The budget shows an estimated gross margin per ewe of over \$5, which compares favourably with the average result for the top third of the recorded farms.

The level of costs, particularly for feeds and veterinary expenses, is just on double the average recorded figure for these farmers, and it seems likely that with good management the income could be increased.

Every extra lamb reared and sold will increase the flock margin by approximately \$12, that is, a selling price of \$15, less marginal costs of say, \$3, mainly for pen feeding.

Thus, an increase of five per cent in the effective, sold, lambing rate would give 10 extra lambs in the 200 ewe flock and would increase the margin by approximately \$120 or \$0,60 per ewe.

Working on the basis that any enterprise should produce a margin of at least \$1 000 to make it worthwhile, the budget suggests that at least 200 ewes should be kept.

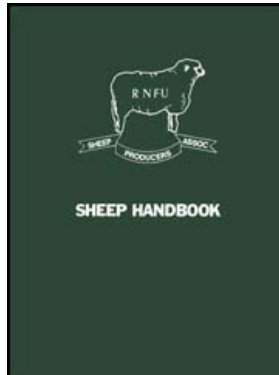

Sheep Handbook







Author(s): *D. J. Donkin*











Publication date: *1973*

Number of pages: *156*

Publisher: *Rhodesia Sheep Producers' Association, Ministry of Agriculture*

Contents:

-  [Acknowledgements](#)
-  [Introduction](#)
-  [Foreword](#)
-  [Chapter 1. The Rhodesian Sheep Industry](#)
-  [Chapter 2. Sheep Breeds in Rhodesia](#)
-  [Chapter 3. Breeding and Selection](#)

-  [Chapter 4. Management](#)
-  [Chapter 5. Sheep Management Calendars](#)
-  [Chapter 6. Nutrition](#)
-  [Chapter 7. The Grazing Sheep](#)
-  [Chapter 8. Handling Facilities](#)
-  [Chapter 9. Marketing of Sheep](#)
-  [Chapter 10. Wool](#)
-  [Chapter 11. Economics](#)
-  [**Chapter 12. Diseases and Parasites**](#)
-  [Appendices](#)
-  [General Information](#)

Chapter 12. Diseases and Parasites

[▲ Top](#)

R. L. McKENZIE

Control of parasites and vaccination against certain diseases are essential for satisfactory sheep production.

The sheep producer must be prepared to vaccinate against these diseases and to control internal parasites by regular and systematic dosing. If he is not prepared to recognize these facts and take the necessary preventive action, he had better not contemplate keeping sheep.

Sheep, like cattle, are ruminants but here the similarity ends. Their husbandry is entirely different and has to be of a high standard if satisfactory financial returns are to be made.

1. Viral and Rickettsial diseases

Blue tongue

This disease is prevalent throughout Rhodesia and as the disease is transmitted by midges, it occurs only during the rainy season when the insect vectors are most numerous.

Sheep of all ages are susceptible. The Blackhead Persian and indigenous sheep are resistant with varying degrees of resistance in cross breeds. The highest incidence of the disease occurs in exotic breeds.

Symptoms: The animal has a fever with a temperature up to 41°C. The fever continues for 4 or 5 days. About two days after the temperature rises the eyes and nose show a discharge which may become purulent. The gums, lips and tongue become very red and a frothy saliva is present around the lips. The tongue, cheeks and ears are swollen and ulcers appear on the tongue, palate and gums and there is an offensive smell from the dead tissue. The feet are very hot and in unpigmented hooves a red band can be seen around the top of the hoof. Because of the inflammation in the feet, affected animals are disinclined to stand. The head is often held to one side back against the shoulder. Deaths usually occur in severely affected animals about one week

after the initial illness. Deaths may occur as a direct result of the virus or from secondary causes such as pneumonia.

Diagnosis: A tentative diagnosis can be made from the clinical picture presented by the affected animal.

Post-mortem findings: Apart from the clinical signs mentioned above, there may be secondary complications such as pneumonia.

A certain method of confirming the disease is to open up the large blood vessel which leads from the right side of the heart to the lungs. If a blood-stained area, very often about the size of a 2 ½ cent piece, is present in the wall of the blood vessel, then the cause of death was Blue Tongue.

Treatment: No drug is effective against the causal agent. A course of antibiotics may be given in an effort to prevent the secondary complications. Good nursing in the form of shade, clean water and tempting food assist the animal's recovery. The mortality rate is not high although a considerable number of animals may be affected at one time.

Control: Exotic breeds and their crosses should be vaccinated annually in the spring. A febrile reaction usually follows about one week after vaccination. Pregnant ewes should not be vaccinated as they may abort. Rams should not be vaccinated during the mating season as the temperature reaction following vaccination may lead to temporary sterility.

It is difficult to obtain a satisfactory response to vaccination in young lambs. Protection of spring lambs thus presents a problem. If lambs under the age of six months are vaccinated, it is advisable to repeat the vaccination when they attain this age.

The vaccine is available from the Veterinary Research Laboratory, Borrowdale Road, Salisbury. The cost is 75 cents for 50 doses. The vaccine must be stored in a refrigerator prior to use. The injection is given under the skin behind the elbow or on the inside of the thigh. Syringes and needles should be boiled before use. Disinfectants or methylated spirit must not be used for sterilisation as the vaccine is a live attenuated virus.

Rift Valley Fever

This disease occurs sporadically in Rhodesia. It is spread by insects in a similar manner to Blue Tongue, thus it is also seasonal in occurrence. The country may be free of the disease for several years between outbreaks. It is suspected that the virus builds up in wild antelopes and when the infection reaches a certain level in the game it is liable to be transmitted to domestic stock. Wesselsbron Disease is very similar to Rift Valley Fever and the two diseases often occur concurrently.

Symptoms: The disease causes a mortality rate of about 95 per cent in lambs under the age of one week. The lambs may appear to be healthy when born but die quite suddenly a day or two later. Sudden deaths may also occur in

ewes and rams but the mortality rate is much lower. Pregnant ewes abort, more abortions occurring with Rift Valley Fever than with Wesselsbron Disease.

Diagnosis: The disease should be suspected when abortions occur in ewes, or lambs die shortly after birth. The disease can be confirmed by the examination of sections of liver under a microscope.

Post-mortem findings: In lambs very little can be seen except possibly small yellow patches on the liver or the whole liver may be discoloured. In ewes and rams there are usually pin-point size haemorrhages throughout the body. Large quantities of blood may be present in the abomasum (true or fourth stomach).

Treatment: Nil.

Control: Vaccination in the spring prior to the rains when the flock will be at risk. Sheep can be vaccinated against Rift Valley Fever and Wesselsbron disease at the same time by mixing both vaccines prior to injection. Pregnant ewes and lambs under the age of one month must not be vaccinated.

The vaccine can be purchased from the Veterinary Research Laboratory, Borrowdale Road, Salisbury. The price is 75 cents for 50 doses.

Contagious pustular dermatitis, Orf, Sore-mouth

This condition causes the formation of crusts and scabs on the lips and muzzle. Sometimes sores may be seen in the feet between the hooves or on the udders of ewes if the suckling lamb is affected. The condition is more common in lambs than older animals.

Diagnosis: The presence of sores around the lips.

Treatment: Affected animals should be isolated and the sores bathed with a mild antiseptic solution (e.g. Dettol).

Control: Vaccination of all sheep. The vaccine can be easily prepared by a Veterinary Surgeon using the crusts from an infected animal. Vaccination is carried out by scarifying the skin on the inner aspect of the thigh in a similar manner to that used for vaccinating humans against smallpox. Examination of the site of vaccination should be carried out one week after vaccination to ensure that there is a high percentage of "takes".

It may be necessary to repeat the vaccination two or three months later. Care should be taken when handling affected sheep because the disease is transmissible to man.

Heartwater

This disease is transmitted by the bont tick (*Amblyomma hebraeum*). The causal agent is *Rickettsia ruminantium*. The bont tick is only found in the lowveld of Rhodesia so the disease distribution is confined to that area.

Symptoms: The first sign of the disease is a marked rise in temperature up to 42,5°C. The animal may appear normal in other respects for a day or so. Thereafter it goes off its food, stops ruminating, assumes an anxious expression and responds excessively to external stimuli. It walks with a high stepping, stiff, unsteady gait, turns in circles, blinks its eyes and makes chewing movements. The animal collapses in convulsions making galloping movements with the legs and death soon supervenes.

Post-mortem findings: The presence of large quantities of fluid in the heart sac is the most striking lesion and gives rise to the common name of the disease. The spleen may be enlarged as is also the liver. The lungs are heavy with fluid and when cut the fluid oozes from the tissues. The air passages are filled with froth.

Diagnosis: Based on symptoms and detection of organism in smears made from the brain.

Treatment: Intravenous injection of tetracy-clines at a dosage level of 10 mg per kilogram is effective when administered in the early stages of the disease.

Control: Dipping.

2. Bacterial diseases

Enterotoxaemia, Pulpy kidney

Large numbers of sheep die annually from this disease. Outbreaks may occur at any time of the year in any breed of sheep. Mortality is heaviest in lambs in good condition. This is one condition against which regular vaccination is essential in all flocks.

The causal organism *Clostridium welchii* type D is commonly present in the bowel of healthy sheep. When the contents of the bowel change suddenly, this organism multiplies rapidly resulting in deaths from enterotoxaemia. This most commonly occurs after a sudden change in diet or after dosing for internal parasites. Death occurs from toxaemia as a result of the absorption of the toxin produced by the rapidly multiplying bacteria.

Symptoms: The animal is very rarely seen to be ill. The course of the disease is very rapid, sheep being found dead with very little evidence of struggling prior to death.

Diagnosis: Sudden death, especially in lambs in good condition points to enterotoxaemia.

Post-mortem examination: If the carcass is fresh, very few changes may be seen in the internal organs. When examination is carried out some hours after death, the following lesions will be noted. The wool can be easily plucked from the skin and the carcass is distended due to gas formation in the stomach and intestines. The blood vessels under the skin will be distended with blood and very obvious. There is excessive fluid in the heart sac and there may be small

haemorrhages on the surface of the heart muscle especially over the blood vessels. The true stomach (abomasum) may be reddish in colour. The kidneys are soft in consistency and this post-mortem change gives rise to the common name for the disease - pulpy kidney. Sugar is present in the urine. If it is suspected that a sheep has died from this condition, a small quantity of urine, two or three drops, should be collected from the bladder. This sample can then be tested for the presence of sugar. This test is routinely used by veterinary surgeons to confirm the disease. Another method of diagnosis is the collection of bowel contents. Biological tests are then carried out to detect the presence of the toxin. This method is involved and unreliable and is not indicated for use in the field.

Treatment: Nil.

Control: All breeds of sheep must be vaccinated. The vaccination cover required varies with the husbandry practised. The following programme is given as the minimum requirement. Annual vaccination of all ewes and rams. If the ewes are vaccinated two weeks prior to lambing, this will protect young lambs against the disease. Lambs should be vaccinated at 2 months and receive a further vaccination about one year later. Any sheep purchased should be vaccinated, preferably before they are moved onto the property.

The vaccine can be purchased from the Veterinary Research Laboratory, Borrowdale Road, Salisbury. The price is \$1,25 per 50 doses. The vaccine is also available from commercial firms.

Pneumonia and pleurisy

This disease appears in various forms. The animals most commonly affected are lambs which are in poor condition, or lambs which have been subjected to "stress" such as a sudden change in weather conditions. Several different bacteria can cause pneumonia in sheep.

Symptoms: The animal may be found dead. In less acute cases the affected animal may be noticed hanging behind the rest of the flock when driven. Respirations are rapid and the temperature is raised up to 41°C. A cough, and discharge from the nose and eyes may be observed.

Treatment: Affected animals should be isolated and carefully nursed. A course of antibiotics such as penicillin, streptomycin, or the new antibiotics should be administered.

Prevention: An adequate level of nutrition to ensure that ewes and lambs are in good condition and thus have more resistance to disease. If sheep are housed, ensure that there is plenty of ventilation. Where possible, especially with spring lambs, provide some protection from sudden changes in weather. Cull any animals which have recovered but do not thrive as they are a potential danger to the rest of the flock.

If outbreaks of pneumonia are due to infection with the bacteria known as *Pasteurella*, a vaccine is available. Vaccination should be carried out twice with an interval of four weeks between injections. If a vaccination programme

is introduced it can be rendered valueless unless the fault in management predisposing the sheep to this condition is also rectified.

Mastitis, Blue-bag

This term is used for inflammation of the udder. Many different bacteria can cause the condition. It is not known how the infection gains entry in many cases but injury to the udder is a contributory factor.

Only odd cases of this disease occur in this country and it is not a flock problem.

The signs displayed by the ewe vary according to the severity of the infection. In acute cases the ewe may be obviously ill and when the udder is handled, it may be either very hot and red in colour or bluish and cold. One or both quarters may be affected.

In less acute cases, no illness may be observed in the ewe and it is only by observing that the lamb is not thriving or has died that the condition is detected in the ewe.

Diagnosis: Based on symptoms described above. Milk samples can be taken for bacteriological examination.

Treatment: In acute cases treatment is usually of no avail. Antibiotics may be given by injection or infused into the quarter.

Control: Ewes' udders should be palpated prior to mating and any ewes showing any hardness or nodules in the udder should be culled. In certain types of mastitis, a measure of success may be achieved by the use of a vaccine.

Arthritis in lambs, Joint ill, Navel ill

The symptoms of this disease vary depending on the part of the body affected. Several different types of bacteria can be responsible for the condition. The condition usually occurs in lambs under the age of one month. The disease always arises as a result of infection from a wound or in young lambs through the navel.

Symptoms: The lambs may die a few days after birth from a generalized infection. This may or may not be associated with an abscess on the navel. The infection may be localized in the liver, lungs or other internal organs, the lamb often does not thrive and on post-mortem examination an abscess is found in the affected organ. The infection may travel through the blood stream to the joints and infection in the joints gives rise to an arthritis.

Diagnosis: This is usually only possible in the live animal when the joints or navel are infected. One or more joints may be affected. The lamb suffers from an acute lameness with swelling and heat in the affected joints. Infection in the internal organs can only be diagnosed on post-mortem examination.

Post-mortem findings: Depends on the site of the infection.

Treatment: Not usually indicated or successful.

Control: Avoid infection of open wounds. If the condition occurs in young lambs, ensure that lambing occurs on clean ground and treat the navel cord of newly born lambs with tincture of iodine. Ensure that docking and castration are carried out in a hygienic manner.

Tetanus, Lockjaw

The organism which causes this condition lives in the soil and is called *clostridium tetani*. This condition always occurs as a result of a wound that has been contaminated with soil or dust. The bacteria causing the disease can only multiply when a wound is infected and there is no direct contact with air. The organism produces a very potent toxin (poison) which affects the nervous system.

Symptoms: The nervous signs produced are quite characteristic. They usually occur about 5 or 6 days after exposure to infection. Affected animals may be observed walking with a stiff gait with the head elevated. On examining the eye, it will be noticed that the third eyelid is drawn across the eyeball like a shutter. Any sudden noise or excitement will cause the animal to become completely rigid and fall on its side. The legs are extended and the head thrown back. Considerable pressure is required to bend the joints. The jaws are tightly closed and the mouth can only be opened with difficulty. This sign gives rise to the common name of the disease - "lockjaw".



Tetanus: Note the rigid stance. Infection was via elastrator on the tail.

Photo R. L. McKenzie

Diagnosis: Based on typical clinical signs and the presence of a wound.

Post-mortem findings: Negative except for the presence of an infected wound.

Treatment: Not usually indicated except in valuable animals. Large doses of tetanus antitoxin, antibiotics and cleaning of the wound with an antiseptic. The cost of the large doses of anti-toxin that must be administered usually preclude its use in sheep.

Control: Ensure that accidental wounds are adequately cleaned and disinfected as soon as possible after their occurrence. Carry out inoculations and surgical

procedures such as castration and docking in a hygienic manner. If elastrators are used for castration and docking, remove the rubber ring 3 to 4 days after application by cutting off the scrotum or tail close to the ring with a sharp knife or scalpel. Tetanus anti-toxin or toxoid may be given. Tetanus vaccine is often combined with other vaccines such as Pulpy Kidney.

Foot-rot

This disease is caused by infection of the foot by the organism *Fusiformis nodosus*. Infection gains entry to the hoof through a wound. The condition is not nearly such a problem in this country as it is in other parts of the world where sheep are kept under muddy conditions.

Symptoms: An affected animal will be observed to be lame. On examination of the affected foot, it will be noticed that the foot is hot and pressure is resented. The skin between the claws may be red and the skin at the top of the hoof may be separated from the horns. If the horn is pressed, a small quantity of a greyish fluid with an objectionable smell may ooze from the wound.

Diagnosis: Based on clinical findings.

Treatment: Overgrown horn must be removed and the feet trimmed. Antiseptic dressings, of which many are effective, should be applied. A copper sulphate and Stockholm tar dressing can be used. Chloramphenicol, either as a tincture or as an aerosol, is commonly used. The number of dressings or treatments required depends on the severity of the condition.

Control: Isolation and treatment of affected sheep. The use of foot baths containing 5 per cent copper sulphate solution or 10 per cent Formalin.

Ovine brucellosis, Epididymitis in rams

This is a disease which causes infertility in rams. The causal organism belongs to the Brucella group of bacteria and is called *Brucella ovis*. This bacterium is specific to sheep. Another member of this group, *Brucella abortus*, causes contagious abortion in cattle. The epidemiology of the two diseases is very different. *Br. abortus* mainly affects cows, whereas with *Br. ovis* the organism is mainly responsible for epididymitis in rams, a resultant sterility and a drop in the lambing percentage.

Symptoms: The epididymis is a cord closely attached to the posterior border of the testicle. Epididymitis is the term used for inflammation and swelling of this cord and is usually due to infection. The epididymis is divided into three parts, the tail at the lower end, the body or middle part, and the head or upper portion. Abnormalities can be detected by palpation of the testicle and epididymis. Swellings most commonly occur in the tail of the epididymis. If swellings are detected on the epididymis, this does not necessarily mean that the ram is infected with brucellosis as other bacteria can cause epididymitis.

Infected rams rarely show systemic evidence of disease. When infection has been introduced to the flock, the only noticeable sign is a drop in the lambing percentage. Where several rams are used in a flock and only one ram is

infected, the infected ram often displays increased libido and may prevent the other normal rams from serving the ewes.

The ewe is infected following service by an infected ram. Young rams contract the infection following mating with infected ewes. There is also some evidence that ram to ram transmission of the disease may occur.

Diagnosis: Three methods of diagnosis of infection in rams are available:

- 1. scrotal palpation;**
- 2. bacteriological examination of the semen; and,**
- 3. complement fixation tests (blood tests).**

The vast majority of infected rams display lesions in the epididymis that are readily detected by palpation of the scrotal contents. One or both epididymi may be affected and there may also be atrophy of one or both testicles. The organism can be fairly easily detected in semen smears prepared in the same manner as a blood film. The organism can be grown from semen samples on artificial media in similar manner to that used for most bacteriological cultures. Negative bacteriological findings do not mean that a ram is not infected and repeated sampling may be necessary to detect rams that are shedding the organisms intermittently but are free from clinical evidence of disease. Serological tests can be useful to detect the presence of anti-bodies in the blood of infected rams.

Post-mortem findings: Lesions are confined to the testicles and epididymi. The organisms can be grown from these organs on bacteriological plates.

Control: Ensure that rams purchased are free from evidence of disease prior to introduction to the flock. In an infected flock, culling of the affected rams and their replacement with vaccinated rams will usually control the disease. Non-breeding ewes will be eliminated in the annual culling programme. Ram lambs should be vaccinated at the age of 4 months with *Brucella ovis* vaccine (Rev. 1). It is essential that ram lambs be vaccinated early in life to ensure that they are protected prior to their displaying sexual activity. The disease can usually be controlled by vaccination of the rams only; although in some countries ewe lambs are also vaccinated. *Brucella ovis* vaccine (Rev. 1) is available from the Veterinary Research Laboratory Salisbury at a cost of \$2 per 50 doses.

Actinobacillus seminis infection in rams

This disease is similar to *Brucella ovis* infection in that it is a disease which affects the genital organs of rams.

The clinical picture is different in that this disease affects younger rams from weaning to 2 years of age. Infected rams are very obviously ill, run a high temperature, there is an acute inflammation of the testicles and epididymi, the scrotum is swollen and hot and palpation is resented. Once the acute stage passes, the tissue damage remaining is similar to that of Brucellosis.

Symptoms: Young lambs may show the acute signs described above. Once this

acute phase has passed, the chronic lesions which develop are the same as those described for *Brucella ovis* infection. Some badly affected lambs may die from toxæmia. Affected rams are either sterile or have a lowered fertility and there may be a drop in the lambing percentage. Ewes are not affected and the female plays no part in the transmission of the disease. Work to date indicates that the disease is contagious but the exact method of spread is unknown. Attempts to infect ewes and transmit the disease venereally have been unsuccessful.

Diagnosis: Clinical findings. Recovery of the organism from semen samples. Growing the bacteria on culture media. Agglutination tests on blood samples can be carried out. This test is more complicated than with *Br. ovis* as there are at least four different strains of *A. seminis*.

Post-mortem findings: Lesions as described above in epididymi, testicles and also accessory sexual organs.

Control: This is extremely difficult. Blood testing, semen checks and regular clinical examination of rams help to reduce the incidence. This disease is mainly a problem of stud breeders where numbers of ram lambs are kept in confinement. No vaccine is available to assist in the control of the disease.

Quarter evil, Black-leg and Malignant oedema

***Clostridium chauvoei* and *Cl. septique* are the bacteria responsible for these diseases. These organisms are present in the soil in the form of resistant**

spores which can survive in the soil for many years. *Cl. chauvoei* is the germ which causes Quarter Evil in cattle. In sheep, the disease appears in a different form from that in cattle and is nearly always associated with a contaminated wound. The bacteria multiply rapidly in the muscle at the site of infection. A potent toxin is produced and death occurs from toxæmia.

Symptoms: One or several sheep may be found dead with no prior signs of illness. When the disease is not so acute the affected animal may be observed to be lame. In cattle only the muscle of one leg is affected but in sheep very often more than one big muscle mass is affected. When the muscle is palpated, the swelling over the area will pit on pressure.

The skin over the affected muscle may be discoloured. In some cases this is black and in others a deep purple in colour.

Treatment: Nil.

Post-mortem findings: When the carcass is skinned, it may be noticed that there is discolouration of several of the larger muscles e.g. neck, back and hind leg. When those discoloured swollen muscles are cut into, the tissues will be found to be infiltrated with bloodstained fluid and gas. The carcass decomposes rapidly after death and varying changes may be found in the internal organs.

Diagnosis: The disease must be confirmed by isolating the causal organisms from the affected muscle. This may be done:

- 1. by a direct smear from the affected muscle;**
- 2. small strip of muscle dried like biltong; and,**
- 3. portion of muscle placed in preservative such as glycerine saline.**

Control: The use of vaccine either singly for this condition or as a combined vaccine. The vaccine is available from commercial sources.

Caseous lymphadenitis, Cheesy glands

This is a chronic disease of sheep, the main symptom being enlargement of the lymph nodes in front of the shoulder or the hind leg although other superficial lymph nodes may be affected by abscesses. The organism responsible for this disease is called *Corynebacterium ovis*. This bacteria can live for several years in the soil under favourable conditions. After the bacterium gains entry to the sheep it multiplies in its predilection site in the lymph nodes. This disease does not cause ill health in the sheep and is mainly a meat inspection problem, especially if the node above the achilles tendon in the hind leg is affected. Whichever node is affected, results in trimming and the subsequent down grading of the carcase.

Symptoms: The organism gains entry through the skin by a wound which may be the result of trauma or wounds inflicted at shearing. The organism moves along the lymphatic vessels and is arrested in the first lymph node it comes to in the lymphatic drainage system. A chronic inflammation is set up as a result

of the infection and pus is formed in the substance of the node. This process continues and the node may increase in size to that of an apple before the skin ruptures. The pus discharging from the abscess is thick and has a cheesy consistency, hence the common name of the disease. The abscess shows little tendency to heal and even with surgical drainage and antiseptic treatment may continue to discharge for a considerable period. Contamination of shears with this discharge readily spreads the infection to other sheep.

Diagnosis: The presence of a persistent sinus discharging thick pus in front of the shoulder or the hind leg. The isolation of the causal organism by bacteriological culture. Less advanced cases are only diagnosed at slaughter when the enlarged nodes can be observed after the carcass is flayed.

Treatment: Nil apart from adequate drainage and disinfection of the abscess cavity.

Prevention: Cleanliness and disinfection of instruments and shears to prevent contamination of wounds.

Balano-posthitis, Sheath-rot, Fizzle-rot

This disease mainly affects lambs but can occasionally be a serious problem in rams.

It nearly always occurs in sheep on a high plane of nutrition either on lush pastures or on high energy rations. The opinion is generally held that the

condition is likely to occur when feeds are rich in protein and calcium and the alkaline urine contains large quantities of urea. This alkaline urea-rich urine is irritant to the sheath and penis and this results in ulceration and the formation of dead tissue especially on the end of the penis.

The ammonia produced when the urea is hydrolyzed by fermentation, is extremely irritant and is responsible for the initial ulceration. Work in Australia has indicated that the infection may be transmitted venereally in rams via the ewe. This work is not conclusive and in many outbreaks there is no possibility of venereal transmission. Other workers have stated that the disease is due to a specific organism.

This condition causes a severe mass loss even in animals which are only mildly affected and can greatly upset feeding programmes.

Symptoms: Unfortunately the condition is usually fairly well established, with considerable tissue damage, before symptoms are observed. The animal is uncomfortable and restless - closer examination reveals that the sheath is swollen. Small quantities of strong-smelling urine may dribble from the sheath. Attempts are made to kick the affected area with the hind legs. The back is arched, affected animals walk with a stiff, straddled gait and very often lie down.

On close examination, scalding and ulceration will be seen at the end of the sheath and this extends up inside the sheath. Foul smelling tissue and pus are

present in the sheath.

It is very difficult to examine the penis. In many cases it is also ulcerated and areas of dead yellow tissue are observed which can be quite extensive. In advanced cases there may be a complete blockage of the urinary passage. This obstruction often leads to uraemia and rupture of the bladder.

Diagnosis: Based on symptoms.

Post-mortem findings: As described above.

Treatment: Antiseptic and antibiotic solutions can be infused into the sheath. Response is often poor due to the presence of pus and necrotic material. Surgical opening of the sheath to allow more effective topical treatment is the treatment of choice. This operation cannot be employed in rams as they are then useless for service.

Prevention: The diet can be adjusted to reduce the alkalinity of the urine.

Enzootic abortion, Stamp's disease

This disease is caused by a Chlamydia which is an organism which is classified between viruses and bacteria. This disease has been known to occur in Great Britain for many years. The condition was originally investigated by Stamp in Scotland and is sometimes referred to for this reason as Stamp's Disease. The disease was first diagnosed in South Africa in 1972 when it assumed epizootic

proportions and resulted in the death of large numbers of lambs and a very high percentage of abortions in ewes.

IMPROVE WEIGHT GAINS WITH COOPER HELMATAAC



**The most effective sheep
and goat worm remedy
you can buy**

RESULTS SPEAK FOR THEMSELVES

WORM SPECIES	EFFICACY		
	IMMATURES		ADULTS
	3rd stage larvae	4th stage larvae	
Wireworms	A	A	A
Brown stomach worms	A	A	A

COOPER HELMATAAC

- Increases carcass yield.

- Improves quality and yield of woolclip.
- Is absolutely safe when used as directed.
- Needs no double-dosing against hookworm, nodular, brown stomach and long-necked bankrupt worm.

Brown stomach worms	A	A	A
Bankrupt worms	A	A	A
Longnecked Bankrupt worms	A	A	A
White bankrupt worms	A	A	A
Nodular worms	A	B	A
Hookworms	A	A	A
Large-mouth worms	A	A	A

Class A = More than 80% effective in more than 80% of the treated flock.

Class B = More than 60% effective in more than 69% of the treated flock.

Class C = More than 50% effective in more than 50% of the treated flock.

Keep *your* flocks healthy and profitable — switch to **COOPER HELMATAc** today!

Available in 25 litre, 5 litre and 1 litre packs.



COOPER RHODESIA LIMITED

P.O. Box 2699 Salisbury

P.O. Box 489 Bulawayo

A
'WELLCOME'
Company

The organism has also been isolated from cattle, horses and wild antelope. The disease has not been confirmed in Rhodesia.

Transmission: Spread from ewe to ewe is most probably by ingestion. The herbage is contaminated by aborted fetuses, foetal membranes and discharges. Infected sheep may also pass the organism in the faeces. Non-

infected ewes grazing pastures infected with the organism contract the disease in this manner.

Symptoms: When the infection is originally introduced to a flock the incidence of abortion may be low and may go unobserved. The following year, the infection builds up and a very high percentage of ewes abort or produce weakly or dead lambs.

Ewes do not show any signs of ill health when they abort. When abortion occurs early in pregnancy, the only evidence may be a blood stained vaginal discharge and soiling of the wool around the crutch. When resorption of the foetus occurs in very early pregnancy, the ewe will display no signs of infection and the resultant low lambing percentage is the only pointer to the presence of disease. When ewes which are three months or more pregnant abort, many of the foetuses will be seen to be dried up with the skin closely adherent to the bones (mummification).

As lambing approaches, larger dead foetuses may be dropped which appear to be normal and the ewe may retain the afterbirth. Premature weak lambs may be born, a number of which will survive, others dying a day or two after birth.

Research workers at Onderstepoort in South Africa, describe trembling and change of the wool fibre in a certain percentage of lambs as being due to Chlamydiosis. These lambs are described as "hairy-shakers". Workers overseas state that this condition is more likely to be a manifestation of

Border B. disease which is caused by a virus.

Diagnosis: Based on history of flock and the detection of the organism from aborted fetuses or the afterbirth.

The afterbirth is the best specimen from which to isolate the organism. This organism can be detected in smears from the cotyledons when examined under a microscope, or the organism can be grown on incubating eggs or tissue culture. Serological tests can also be carried out on blood from ewes which have aborted.

Post-mortem findings: Very little abnormality may be detected in many of the fetuses apart from mummification. In others there may be a blood-stained infiltration of fluid between the skin and underlying tissues. Patches of pneumonia may be present in the lungs.

Treatment: Nil.

Control: Vaccination of ewes one month prior to tupping. The vaccine can be purchased from the Veterinary Research Laboratory. The vaccine gives 80 per cent protection, so infected flocks will continue to have a certain number of empty ewes, or ewes which abort. The ram plays no part in transmission.

Anthrax

This disease attacks all warm-blooded animals including man. Its distribution

is world-wide. The causal organism is *Bacillus anthracis*. Outbreaks of the disease in Rhodesia are usually confined to cattle.

The disease in grazing animals is contracted by ingestion of the sporulated stage of the organism.

Symptoms: Animals are rarely seen ill and are usually found dead. Prior to death there is a short period when the affected animals show a very high temperature and the usual signs associated with pyrexia.

Post-mortem findings: A post-mortem examination must not be carried out on an animal which is suspected to have died of anthrax. A blood stained discharge usually occurs from the natural orifices.

Diagnosis: A small incision should be made on the ear and a blood smear made. The disease can be confirmed by the presence of large numbers of the anthrax bacilli detected on microscopic examination.

Treatment: Antibiotic therapy is successful. Affected animals are rarely noticed to be ill.

Prevention: The disease is specified under the Animal Health Act 1960 and suspected cases of the disease must be reported to the nearest Veterinary Office. Control of the disease is undertaken by the Department of Veterinary Services. Carcasses of affected animals are burned or buried in lime. Cattle, sheep, goats, pigs, horses and donkeys on the infected property are

vaccinated. The property is placed in quarantine and only animals vaccinated in the previous 12 months can be moved off. This vaccination is carried out annually for three years.

3. Metabolic diseases

Acidosis

This condition occurs when the pH (Acid/Alkaline balance) of the rumen is upset. The condition usually occurs shortly after sheep are allowed access to a diet high in carbohydrate. Fermentation takes place in the rumen as the animal is unable to digest the large quantities of carbohydrate. Lactic acid is formed and the pH of the rumen drops as also does that of the blood. The condition often occurs when sheep are allowed prolonged access to old maize lands where large numbers of pips have been left on the ground. The production of the acid in the rumen draws fluid from the body into that stomach and causes dehydration of the body.

Symptoms: These are displayed about 8 to 12 hours after the ingestion of the food. The animals are dull, do not chew the cud, may grind their teeth and are obviously ill. The rumen may be distended; this is due to the increased fluid content and not to gas as in the case of bloat. The temperature is usually subnormal, the eyes are sunken, the skin is tensed as a result of the dehydration. There is usually a change in the consistency of the dung, pellet formation is depressed and only small quantities of foetid droppings may be

passed or there may be a profuse diarrhoea. In acute cases, death may ensue 24 hours after the first signs. In less severe cases they may linger on for several days. Animals which are not treated but survive may take a long period to recover ruminal function or they may die from a secondary bacterial infection as a result of their lowered resistance.

Diagnosis: Based on symptoms.

Post-mortem findings: The very fluid contents of the rumen and the presence of large quantities of cereal food are the most prominent findings. Animals may be in poor or good condition. When the ruminal fluid is tested, it is found to be very acid.

Treatment: This must be commenced shortly after the illness starts if it is to be successful. Antacids e.g. magnesium hydroxide, sodium carbonate or sodium bicarbonate, should be administered by mouth. One of these chemicals is usually available on most farms, the common names being respectively milk of magnesia, washing soda and baking soda. The doses for adult sheep are two tablespoonsful of milk of magnesia, about one teaspoonful of washing soda or three teaspoonful of baking soda. Whichever chemical is used, it should be dissolved or suspended in water and given carefully as a drench. The treatment may have to be repeated depending on the severity of the illness and the response to the initial treatment. Antibiotics may be given by injection into the rumen to arrest the fermentation process. A course of antibiotics by injection should always be given since the animal's resistance to

bacterial infection is lowered and the antibiotics should control secondary complications. In valuable animals, a rumenotomy may be indicated to remove the fermenting ingesta from the rumen.

Control: Ensure that any change to a high energy diet is gradual. Allow sheep access to old maize lands for short periods only, unless the lands have been gleaned.

Pregnancy toxæmia, Twin lamb disease, Lambing paralysis

This disease occurs in ewes close to lambing and is characterized by impaired nervous function and loss of muscle tone.

The primary pre-disposing factor is a drop in nutrition in late pregnancy. Ewes carrying twins are most commonly affected, hence the common name "Twin Lamb Disease". Stress factors such as storms, transport and excessive heat also play a role in the causation of the disease. The disease is due to a sudden drop in the blood sugar level. The liver of the pregnant ewe is unable to produce sufficient glucose for herself and the rapidly growing foetuses. This is especially the case where liver function is depressed as a result of conditions such as cirrhosis.

Symptoms: Early clinical signs are vague and difficult to detect. The course of the disease in untreated cases usually lasts 2 to 5 days. Affected ewes separate themselves from the rest of the flock and can usually be easily approached by men or dogs.

This symptom is due to blindness. The animal may prop itself against objects and there may be grinding of the teeth. The muscles about the head twitch and this gradually extends to involve the whole body. The animal goes down and coma and death supervene.

Diagnosis: Based on the symptoms and the history of the flock. Pregnancy toxæmia must be differentiated from milk fever, or parturient paresis which produces similar symptoms but deaths are usually more rapid in milk fever.

Post-mortem findings: The liver is bright yellow in colour due to fat deposits and the lungs are congested. Twin foetuses are usually present.

Treatment: This is aimed at counteracting the drop in blood sugar. Once the condition is advanced there is little hope of a satisfactory response to therapy. In these cases the damage to the brain has progressed too far and is irreversible. Glucose, sugar or molasses can be given by mouth. About 110 g of sugar or 250 g of molasses dissolved in water should be administered twice daily. Glucose can also be administered by injection. Some cases respond to insulin therapy and there have also been reports of response to cortisone injections.

Supplementary feeding of the flock should be commenced immediately, particular attention being given to an increase in carbohydrate intake.

Prevention: Ensure that ewes in the last 6 weeks of pregnancy are not subjected to a drop in nutrition; avoid stresses due to environmental

conditions where possible.

Post-parturient paresis, Milk fever

This condition may occur any time from one month before lambing to 2 months after lambing. The disease is due to a sudden drop in the blood calcium level. The disease is commonest in older ewes and is usually associated with a stress factor such as a sudden change in food.

Symptoms: These appear suddenly, the animal moves with a stilted gait and the breathing may be accelerated. Muscular tremors affecting the whole of the body may be observed. The animal becomes recumbent, often lying on its brisket with the head and hind legs extended, or in some cases the head may be turned round towards the flank in the typical posture assumed by a cow with milk fever.

Diagnosis: Based on symptoms but must be differentiated from pregnancy toxæmia. A dramatic response to calcium therapy is a feature of this disease and serves to differentiate it from pregnancy toxæmia.

Post-mortem findings: Usually negative with the exception of a blotchy appearance of the liver.

Treatment: The administration of 50-100 ml of calcium borogluconate solution given in two or more sites under the skin, or a portion of it may be given intravenously. The solution of calcium, magnesium and dextrose commonly

used to treat milk fever in cows can be used in sheep at the same dosage rate recommended for calcium borogluconate.

Prevention: Avoid subjecting pregnant and lactating ewes to conditions which may trigger off the condition.

Iodine deficiency, Goitre

This is a condition which manifests itself in newborn lambs. It is due to either too low an intake of iodine by the pregnant ewe or an interference with iodine metabolism. The condition occurs more commonly on sand veld than on red soils. The disease is more likely to occur on improved star grass pastures than on veld grazing.

Symptoms: Lambs may be weak or dead at birth. The neck is grossly enlarged and the two enlarged lobes of the thyroid can be readily palpated. Affected lambs are often hairless or woolless at birth and may show abnormalities of the limbs and joints.

Diagnosis: Based on clinical signs described above, ascertaining the mass of the enlarged thyroid, and microscopical examination of the thyroid for the typical changes in the glands.

Post-mortem findings: Abnormalities described under symptoms.

Treatment: Affected lambs do not respond well to treatment, though a drop or

two of Lugol's iodine diluted with water daily for a week can be tried.

Prevention: Provision of iodine in a mineral lick, especially to ewes in later pregnancy, provides an easy solution to the problem.

Copper deficiency

This condition has not been diagnosed in Rhodesia. It appears that the level of this trace element is adequate in both herbage and fodder crops. The daily intake of copper required for an adult sheep is in the region of 2 milligrammes per day. Copper should not be included in mineral licks for sheep as the level in the foodstuffs is usually adequate and supplementation may lead to chronic copper poisoning.

Cobalt deficiency

This trace element is necessary for optimum growth and health. In cases of cobalt deficiency an anaemia results with an associated loss of appetite, retarded growth and loss of condition in adult sheep. It is a difficult condition to diagnose. In many cases, the supplementation of cobalt and the animal's response to this is the only means of confirming that there is a deficiency of this element.

Sulphur supplementation

It has been recommended for many years that sulphur should be made

available to sheep. This recommendation was based on the fact that the proteins from which wool and hooves are made up contain a high percentage of the sulphur-bearing amino acids methionine, cystine and cysteine. Recent work has shown that sulphur supplementation may actually interfere with metabolism of the trace element selenium, and this can result in a selenium deficiency which can cause serious problems in a flock. For this reason sulphur supplementation is no longer recommended. When a diet includes ample quantities of protein there is no risk of a sulphur deficiency.

Phosphorus

Research work on this mineral has shown that a deficiency of phosphorus is unlikely to occur in sheep under normal grazing or fattening conditions. Phosphorus supplements such as bone meal or di-calcium phosphate were recommended for sheep, this practice being based on the response of cattle to these supplements. This difference is explained by the fact that sheep are more selective feeders than cattle, choosing the grasses that have a high mineral content. The bones of sheep constitute a smaller percentage of their body mass than is the case with cattle; and sheep, mass for mass, eat more than cattle.

Care must be taken that the phosphorus content of a diet is not too high. If it is high, problems with urinary calculi composed of phosphates may arise.

Manganese

This trace element is essential for fertility in sheep. It should be included in a mineral supplement.

Zinc

Lambs fed a zinc-deficient diet have displayed evidence of a deficiency by slipping of the wool, swelling and lesions around the hooves, excessive salivation, disinterest in food and poor growth rates. Zinc levels in most foodstuffs are adequate so a field deficiency is unlikely to occur.

Selenium deficiency

This element was traditionally known for its toxicity to animals. The condition is common in North America where animals graze plants which have an affinity for selenium. Certain plants require selenium for their growth and contain high concentration of this element. These plants are referred to as "accumulators". The disease is referred to as "alkali disease" or "blind staggers". Selenium poisoning has also been reported from Ireland, Israel and the northern parts of Australia.

Recent research has proved that a deficiency or interference phenomenon with the metabolism of this element is a serious problem in young lambs in Rhodesia.

A selenium deficiency can manifest itself in three ways:

- **ill-thrift in suckling lambs, Selenium Responsive Unthriftiness (S.R.U.);**
- **sudden deaths in lambs as a result of heart failure; and,**
- **lowered fertility in ewes.**

A deficiency of this element causes the muscle fibres to break down and to become pale in colour like fish flesh. This muscular change, which may occur in the heart or skeletal muscles, gives rise to the common name for the condition viz. white muscle disease. The disease can be confirmed by histological examination of sections of muscle. Examination of blood samples reveals a high level of a muscle enzyme serum glutamic oxalacetate transaminase (S.G.O.T.).

When young lambs do not thrive, selenium deficiency may be the cause. Before tests for this disease are made, it is essential to rule out the possibility that other conditions, such as a low level of nutrition, lack of milk from the ewe or verminosis are not responsible or at least major contributory factors to the problem.

Sudden deaths may occur in young lambs one to two months of age. This condition is difficult to diagnose as there may be very little indication as to the cause of death on postmortem examination. Congestion of the lungs may be the only finding as a result of death due to heart failure. The typical white muscle lesions are not obvious to the naked eye. Diagnosis rests on the

examination of muscle sections and the testing of blood samples from other lambs in the flock. It has not yet been proved that a selenium deficiency is responsible for lowered fertility in ewes in



III thrift is a common symptom of many diseases. These lambs are all of the same age.

Photo R. L. McKenzie

Rhodesia, but as ill thrift and lamb deaths are known to occur, it is probable that a low lambing percentage in certain flocks will also be found to be due to

a deficiency of this element.

Treatment: Where ill thrift occurs the young lambs should be injected with selenium and Vit. E at 2 weeks and again at one month of age. Oral administration of selenium is not reliable as it is poorly absorbed from the digestive tract. The injectable compound can be obtained from commercial sources on prescription.

Cerebro-cortical necrosis, Polioencephalomalacia, Thiamine, Vit. B1 deficiency

Ruminants are capable of synthesizing the vitamins of the B group and for this reason, it was assumed that a deficiency of these vitamins could not occur. Under certain conditions thiaminases are produced during digestion and these break down thiamine or Vitamin B₁, and make it unavailable to the animal.

This condition is commonest in adult sheep. The disease is characterized by nervous symptoms. These are due to a decrease in the blood supply to certain areas of the brain and the formation of fluid between the skull and the brain causing compression of the latter and the resultant nervous symptoms. The nervous symptoms vary, ranging from dullness, blindness, the pressing of the head against objects, to paralysis of the fore or hind legs with inability to stand and intermittent convulsions. Coma followed by death occurs 1 day to 3 days after the appearance of the symptoms.

Diagnosis: This is based on the clinical symptoms and spectacular response to

treatment, or post-mortem examination and histological findings.

Treatment: In early cases there is an immediate and spectacular response to injections of Vit. B₁.

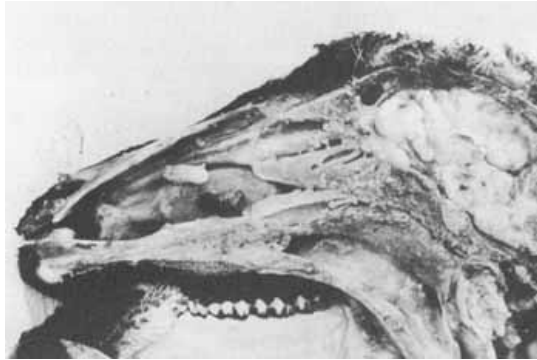

Nasal worm in sheep. The worms are clearly visible in the nasal passages in this section through a sheep's head.

Photo R. L. McKenzie

**PULPY KIDNEY
and**



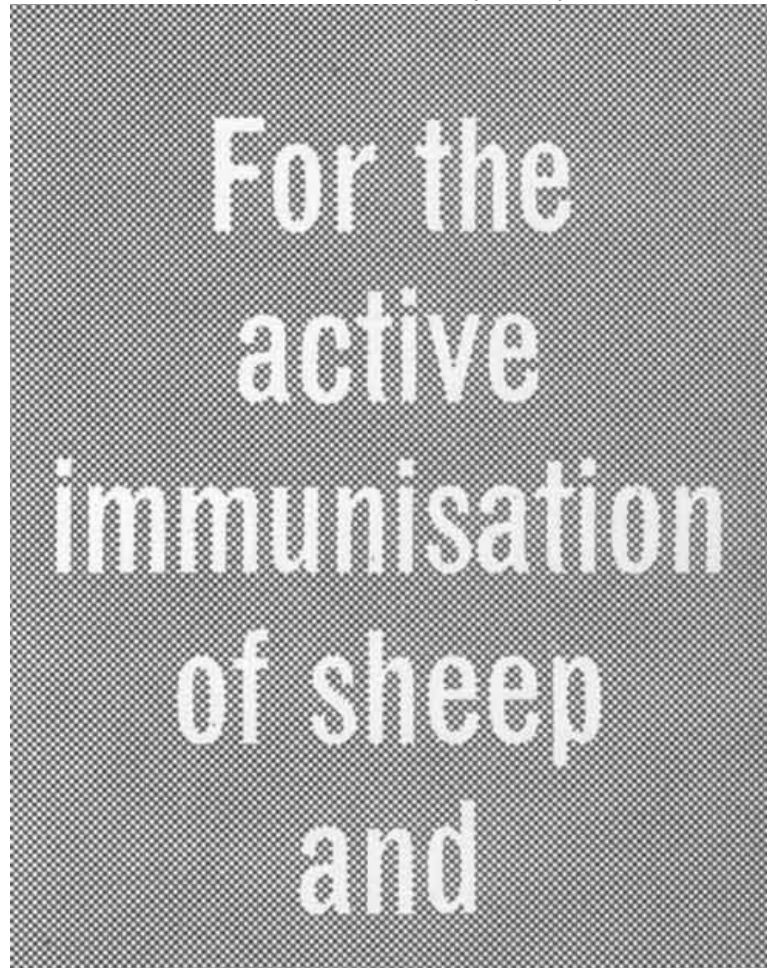

lamb.

**2.3 CENTS PER
2 ML. DOSE**

HOECHST

**BEHRINGWERKE AG.
MARBURG-LAHN**
S. Behring



LB/HR/2131/9-51

4. Miscellaneous conditions

Tick paralysis

This disease occurs in young spring-born lambs, which become infested with Rhipicephalid ticks usually the red-legged tick (*Rhipicephalus evertsi*).

The condition is due to a neurotoxin (nerve poison) produced in the salivary gland of the tick and injected into the animal while the tick feeds. The disease is characterized by a flaccid ascending paralysis. The first symptom noted is inco-ordination of the hind legs followed by paralysis and then paralysis of the forelegs. Death is due to respiratory failure as a result of paralysis of the chest muscles. The affected animal's legs can be easily flexed (flaccid) unlike tetanus where the limbs are rigid.

Diagnosis: Based on clinical findings and presence of ticks.

The ticks may be found anywhere on the body but are most commonly seen around the hooves where they may be present in large numbers.

Post-mortem findings: Nothing obvious is seen except the presence of numbers of ticks.

Treatment: Removal of the ticks either manually or by the application of an insecticide results in a spectacular recovery.

Prevention: Do not allow lambs to become tick infested. As the ticks are usually present on the lower extremities of the legs, the use of a foot bath containing an insecticide will usually give effective control.

Urinary calculi, Urolithiasis, Bladder-stones

This condition is commonest in castrated males and rams. The condition is caused by concretions formed in the urinary tract by the precipitation of salts which are normally excreted in the urine. Calculi may be found anywhere in the urinary tract, in the kidney, ureter (tube from kidney to bladder), bladder or the urethra. The commonest site for the lodging of calculi are below the anus at the pelvic flexure of the penis or at the end of the urethra in the urethral process or worm. Male sheep are more susceptible as the urethra is narrower, much longer and more tortuous than in the female.

Cause: This is usually due to a mineral imbalance and the composition of the calculi depends on whether the urine is acid or alkaline. The commonest

calculi of sheep are calcium, magnesium or ammonium phosphate or silicates.

Symptoms: No symptoms are noticed until one of the stones becomes lodged somewhere in the urinary tract. The animal is restless and frequent attempts are made to pass urine. It becomes dull and listless, off its food, walks with a straddled gait and may show evidence of pain by kicking at the belly or stamping its hind feet. Death ensues as a result of the blockage, the bladder becomes distended with urine eventually rupturing with the release of urine into the abdominal cavity.

Post-mortem findings: Presence of a calculus lodged in the urinary tract and rupture of the bladder.

Diagnosis: Based on symptoms and post-mortem findings. The disease must be differentiated from *Balano-posthitis* in which the symptoms are similar.

Treatment: If the calculus is in the urethral process this may be amputated. If in any other site surgery may be attempted.

Prevention: Avoid mineral imbalances in feeds, especially a high level of phosphorus. If phosphorus is high, counteract this by the addition of calcium. Wheat germ oil is very high in phosphorus and care must be taken if it is incorporated in a diet.

Photosensitization, Facial eczema

This condition occurs when the animal is rendered more sensitive to the rays of the sun. It is usually due to the ingestion of a plant or a fungus. Animals with unpigmented faces and ears are most susceptible. Redness, itching and swelling of the affected area occurs with eventual peeling of the unprotected area of the skin such as the ears and face.

In addition to these superficial lesions, the more serious forms of the disease may result in liver disorders and death from jaundice.

Treatment: Provide affected sheep with shade and application of ointments to the affected areas.

Prevention: Avoid consumption of sensitizing agents by sheep.

Mycotic dermatitis, Lumpy wool

This condition is due to a fungus *Dermatophilus dermatonomus* which attacks the wool and the hair follicles. The heaping up of the scales produced results in the binding together of the wool fibres (lumpy wool).

Symptoms: The disease is difficult to spot and it is only by the careful examination of affected animals that the disease can be detected. If the lower limbs are affected, the clumping together of the hairs may give rise to the fairly typical "paint brush lesions".

Diagnosis: Demonstration of the fungus in stained macerated portions of the

crusts.

Treatment: Single injection of a large dose of penicillin and streptomycin is usually effective.

Prevention: Avoid introduction of affected sheep to a clean flock.

5. Poisoning

Urea poisoning

This occurs when animals accidentally gain access to large quantities of urea, or are fed large quantities when they are not accustomed to it. The provision of adequate quantities of carbohydrates is essential if deaths from urea poisoning are to be avoided. Lambs are particularly susceptible to urea poisoning, as they will consume foods containing urea before their rumens are adequately developed.

Symptoms: Severe abdominal pain, muscular tremors, inco-ordination, bloat and violent struggling. Death occurs in a few hours.

Post-mortem findings; Variable, smell of ammonia from ruminal contents. pH high due to presence of alkali-ammonia.

Treatment: Administration of acids (e.g. vinegar) and sugar (e.g. molasses). It may be necessary to relieve the ruminal tension by trocharization. The

antidote may be administered by mouth or in severe cases, which are unable to swallow, by injection directly into the rumen.

Prevention: Take necessary precautions when feeding urea.

Chronic copper-poisoning, Toxaemic jaundice

Sudden deaths occur in older sheep associated with a marked jaundice.

This condition is due to the ingestion of excessive quantities of copper over a prolonged period. A trigger factor of unknown aetiology causes the sudden release of the copper stored in the liver. This excess of copper in the blood stream leads to a haemolytic crisis, the breakdown of red blood cells and an ensuing jaundice.

Symptoms: Death is usually rapid and sheep may not be observed to be ill as the course of the disease is only a few hours.

If sheep are observed prior to death it will be noticed that they breathe rapidly, holding the head low in a dejected manner. The mucous membranes of the eye are a dirty yellow colour and the skin may be discoloured yellow. Some sheep may recover but never thrive.

Post-mortem findings: The carcass decomposes rapidly. There is a yellow appearance throughout the carcass. The liver is a dark orange colour and is very friable. The kidney fat is yellow and the kidneys themselves are swollen

and black in colour. The contents of the large bowel are hard and black and covered with blood-stained mucus. The spleen is often swollen. The lungs may be greyish in colour. The urine is very dark in colour.

Diagnosis: Based on history and post-mortem findings. Copper analysis can be carried out on portions of the liver. Normal copper levels are less than 350 ppm dry matter but rise to above 1 000 ppm in chronic copper poisoning.

Treatment: The disease is too acute for treatment of individual cases. When deaths have occurred in a flock it must be assumed that many animals have reached a level of storage of copper in the liver which may result in a haemolytic crisis. Molybdenum can control the storage of copper in the liver. The flock can be treated with sodium molybdate mixed in the foodstuffs. This will reduce the blood copper levels and the storage of copper in the liver. Checks should be carried out on animals sent for slaughter to ascertain when liver copper levels have returned to normal.

Prevention: Ensure that dietary copper levels are not too high. Do not incorporate copper in mineral licks, as levels in feedstuffs are usually high enough for the animal's needs.

Plant poisoning

Dichapetalum cymosum, and Gifblaar or Umkauzaan

This plant is confined to the lower areas of Rhodesia. It has an extensive root

system. Young shoots appear in spring and at this time it is most toxic. The younger the growth the higher the content of the poison monofluoroacetic acid.

Symptoms: Animals that have consumed the plant drop dead due to heart failure shortly after drinking water.

Diagnosis: Based on history.

Treatment: Keep animals away from water and as quiet as possible.

Prevention: Avoid grazing of areas where the plant is common during the spring.

Gousiekte

This condition can be caused by several plants. The toxic principle causes damage to the heart muscle. Deaths may occur several weeks after the animals have been removed from the affected pastures. Deaths occur rapidly from heart failure especially after the animals have been driven or subjected to stress. The disease is confirmed by the laboratory examination of the heart muscle.

***Lantana camara*, Tickberry or Cherrypie**

This shrub causes liver damage and photosensitization. The lesions are

confined to unpigmented areas of the skin which becomes swollen, cracks and portions of skin may peel away. The muzzle is commonly affected and becomes covered with a crust. Jaundice may also be present. All animals should be denied access to the affected area. This shrub has been declared a noxious weed.

Urginea sanguinea, Slangkop

Several members of the lily family are toxic but *U. sanguinea* is the commonest. The leaves of these plants appear with the first rains. They may be grazed by sheep as they are often the first green shoots to appear after rain.

These plants contain glucosides which have an irritant action on the digestive system. The symptoms and mortality rate depend on the quantity of the leaves that are consumed.

Sheep should be denied access to known affected areas. The plants can be easily identified when they are in flower and can be dug up.

Prussic acid poisoning, Geilsiekte

Several plants contain prussic acid and may cause death in certain circumstances. Two of the commonest plants are sorghum and star grass and sorghum is particularly dangerous in its early growing stages. Regrowth usually has a high prussic acid content. Lush growths of star grass are

dangerous, especially if wilted or frosted.

Prussic acid prevents the red blood cells from taking up oxygen. The animals die due to the lack of supply of oxygen to the tissues, the brain being the first organ to be affected. Death is rapid and the venous blood is bright red instead of the normal blue colour. Treatment is usually not possible as deaths are too rapid. Injections of sodium thiosulphate (hypo) are very effective if administered in time. Deaths can be confirmed by testing the rumen contents or herbage for prussic acid.

6. Protozoal diseases

Tick-borne protozoal parasites occur in sheep but the symptoms produced are entirely different from Redwater, Gallsickness and Theileriosis which occur in cattle.

The protozoal blood parasites occurring in sheep are:

Anaplasma ovis

Ehrlichia ovis

Eperythrozoon ovis

Theileria ovis

All these parasites cause a mild anaemia especially in lambs. It is only when two or more infections are superimposed on each other that symptoms are

produced.

Symptoms: Lambs do not gain mass satisfactorily. There is a mild anaemia which may not be obvious clinically and can only be determined by laboratory analysis of blood samples. Deaths do not occur from these protozoal infections but as the animals' resistance is lowered, deaths may occur from secondary conditions such as enteritis or pneumonia.

Post-mortem examination: This can often be negative apart from the poor condition of the carcass and the mild anaemia. Death may be attributed to enteritis or pneumonia where these conditions are present as secondary complications.

Diagnosis: This is based on the findings following blood analysis and the demonstration of the parasites. Lack of thrift due to protozoal infections must be differentiated from selenium responsive unthriftiness.

Treatment: These parasites are generally susceptible to antibiotics of the tetracycline group. Therapy is not usually indicated due to the cost and the numbers of animals involved. Ensuring that the animals are on a high plane of nutrition assists in their recovery.

Prevention: Tick control. Dipping at monthly intervals is usually adequate.

7. Internal parasites of sheep

Regular dosing of sheep for internal parasites is one of the most essential aspects of management.

Sheep are the most susceptible of all farm livestock to the ravages of internal parasites.

There are several very effective worm remedies available to the farmer for the control of parasites and with these modern drugs deaths from verminosis should be minimal. Large numbers of deaths from internal parasites occur annually despite the availability of these products. This is usually as a result of too long an interval between dosing to control the parasites effectively when climatic conditions are favourable for their rapid multiplication. Apart from mortality there is also the unthriftiness which results from sublethal levels of infestation and subsequent loss in production or death from secondary conditions such as pneumonia.

Sheep should never be allowed access to natural water supplies for heavy mortality always results from infestations with parasites which have a snail as their intermediate host viz. liver fluke, conical fluke and bilharzia. No sheep venture can be successful unless precautions, such as the provision of a piped water supply, are provided to avoid infestation with these parasites.

Roundworms

***Haemonchus contortus*, Large stomach worm, barber's pole worm or wire worm.**

This worm is one of the most spectacular killers amongst the common roundworms.

This parasite occurs in the fourth stomach or abomasum, it is about 25 mm long and the female worm is characterized by the red and white spirals which are the blood-filled intestines coiled around the ovaries. When these worms are present in large numbers the sheep literally bleed to death as a result of the large quantity of blood sucked by the worms from the bowel wall, and even animals in very good condition succumb rapidly to anaemia. Lambs are more susceptible than adult sheep. This parasite lays enormous numbers of eggs and one female wire worm can lay up to 10 000 eggs daily. An infected ewe with a moderate infestation can contaminate the pastures with 500 000 eggs daily and this indicates the enormous potential available for the build up of this parasite if weather conditions are favourable.

Hot humid conditions are most favourable for the development of the egg into infective larva so this worm can be a serious problem during the rainy season in Rhodesia.

Under optimal conditions this worm can complete its life cycle from egg to adult worm in about three weeks. Short interval dosing at not more than three weeks is therefore essential to control this parasite. All the modern broad-spectrum anthelmintics are effective against the mature and immature stages of wire worm so the choice of drug presents no problem. Rotational grazing will also assist in the control of this parasite.

Worm egg counts cannot be entirely relied upon as a guide to the level of infestation as massive numbers of immature worms may be present but have not yet reached the egg-laying stage.

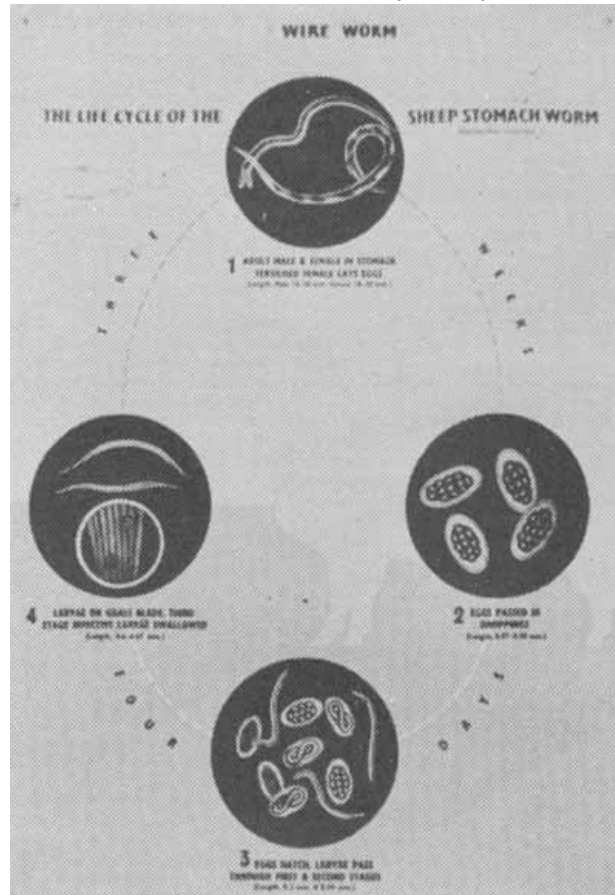

Lifecycle of wireworm.

Photo Cooper Rhodesia Limited.

***Ostertagia* spp., Brown stomach worm**

This parasite is only about half the size of the wire worm and can be seen as thin brown strands about 12 mm long. It is not such a serious killer as *Haemonchus* but can cause severe unthriftiness and loss of mass.

Again all the broad-spectrum anthelmintics give effective control of the adult and immature stages.



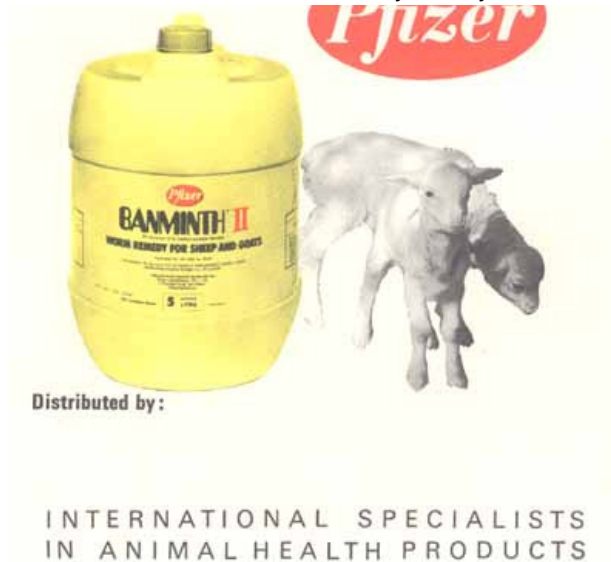

Trichostrongyle spp., Cooperia spp., Bankrupt worms

These worms occur in the first part of the small intestine. They are very small, only about 5 mm long, and not easily visible to the naked eye. The easiest method of detection is by scraping the bowel wall and then squeezing the mucus between two blood smear glasses; the worms can then be seen as small fine strands. Adult and immature stages are effectively controlled by the new anthelmintics.

Oesophagostomum columbianum, Nodular worm

This is a common parasite in Rhodesia and can be a serious cause of unthriftiness. The immature stage of this worm spends part of its life cycle in the wall of the bowel mainly the large intestine. The invaded tissues react by forming nodules around the immature worms and this characteristic gives rise to the common name. When severe infestations of this parasite have occurred the resulting damage to the bowel wall interferes with the animal's ability to absorb food from the bowel and results in chronic unthriftiness. The adult stage of this parasite is present in the large bowel, mainly in the caecum. The adult worm is quite thick, about 20 mm long and obvious to the naked eye, has a hook at one end giving the appearance of a walking stick.

Animals carrying a fairly heavy worm burden may show intermittent bouts of diarrhoea.

Most of the modern worm remedies with one *notable exception* are effective against this parasite.

Life cycle of Roundworms

All the parasites mentioned above have a similar direct life cycle. The eggs pass out in the droppings and then develop into infective larvae which crawl up the blades of grass to be ingested by the grazing sheep. The ingested larvae pass to their appropriate site in the bowels and then develop into adult worms and commence egg laying.

The eggs produced by the helminths described above are very similar in

appearance so it is not possible to identify the different species when routine worm egg counts are carried out. See Table 12.1.

***Trichuris ovis*, Whipworm**

Occurs occasionally in Rhodesia. This worm, which is 50-75 mm long, lives in the blind gut or caecum. It is easily identified as the anterior portion of the worm is thin and about three times as long as the posterior part, this gives the adult parasite the appearance of a whip. This worm is not very pathogenic and is not a serious problem.

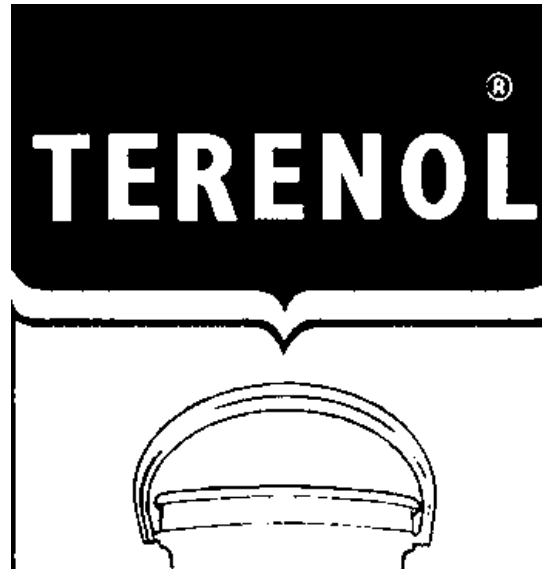



**Effective tape
worm and
conical fluke
remedy for
sheep, goats**

and cattle.

TERENOL®

® Registered trademark of
Farbwerke Hoechst AG

HOECHST RHODESIA
Company (Pvt) Ltd.
Box 3229 Salisbury. Tel. 700063

LB/HR/2080/9,51

The eggs have a typical appearance and can be easily identified when carrying out worm egg counts.

***Bunostomum trigonocephalum*, *Chabertia ovina*, Hookworms**

Two hookworms occur in sheep but do not appear to be at all common in Rhodesia.

***Bunostomum*, or the common hookworm, is about 20 mm in length and the thickness of a fine sewing needle. The parasite occurs mainly in the last part of the small intestine. These worms attach themselves to the wall of the bowel and feed by sucking blood from their host.**

***Chabertia ovina*, or the large-mouthed bowel worm, is about the same size as *Bunostomum* but it occurs in the large intestine. When examined under the microscope the mouth parts of this worm are larger than those of *Bunostomum*, hence the common name.**

The hookworms have a different life cycle from the roundworms described previously. The eggs hatch out into larvae, the infective larvae gain access to the sheep by penetrating the skin and not normally by ingestion. After penetrating the skin the larvae are carried in the blood stream to the lungs where they rupture the small blood vessels. The larvae are then coughed up into the mouth, are swallowed and thus reach the intestines.

To control this parasite a specific remedy would have to be used, in some

cases it would be necessary to dose at double the rate recommended for other round worms.

***Moniezia* spp., Tapeworms**

Milk tapeworms are very commonly seen in lambs. This worm is about 5 metres long and is very obvious. Segments of the worm break off and pass out with the dung. The segments break up liberating very small eggs which are ingested by mites. The lambs are infested by picking up these mites whilst grazing.

These parasites can be a problem when several worms are present in an individual lamb.

***Stilesia hepatica*, Liver tapeworm**

***Stilesia*, or the liver tapeworm, occurs in the bile ducts of the liver and has a similar life cycle to the bowel tapeworm.**

This is a very common parasite and it is doubtful if any ill effects can be attributed to it. There is one remedy on the market specifically for use against this worm.

Lungworms

Lungworms do not occur in Rhodesia so no mention need be made of them.

Flukes

***Fasciola gigantica* Liver fluke**

This large liver fluke is the only one of the species which occurs in Rhodesia and has cattle as its primary host.

Liver fluke infestation in cattle is usually a chronic debilitating disease. In sheep the vast majority of outbreaks are characterized by sudden deaths. In sheep the disease usually appears in late winter or early spring when animals are herded near a dam or natural water supply. At this time of the year large numbers of liver fluke larvae may be present at the edge of a dam.

The life cycle is briefly as follows. The adult fluke lays eggs which pass down the bile ducts into the intestine and are voided in the dung. Only those eggs which are dropped on or near water survive. These eggs mature and a free-living form or a small ciliated larva (a miracidium) develops which swims about in the water seeking its next host, a snail. In the snail multiplication takes place and the next stage is released into the water as cercariae which resemble miniature tadpoles. This free-living stage, encysts on grass or water plants at the edge of the water and waits to be consumed by its host. The small flukes which develop in the intestine of the host migrate through the wall of the bowel to the liver. They burrow through the capsule of the liver and eventually into the bile ducts where they reach maturity. Deaths from liver fluke occur in sheep when large numbers of immature flukes migrate into

the liver at the same time. This results in such severe damage to the liver capsule that the sheep bleeds to death into the abdomen.

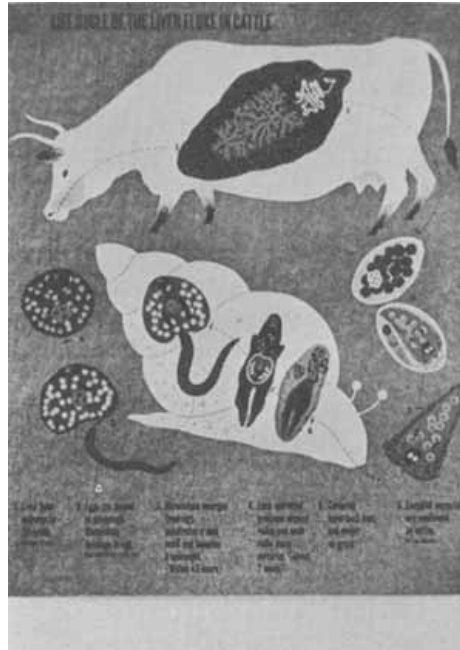

Lifecycle of liver fluke in cattle and sheep.

Photo Cooper Rhodesia Limited.

For the reasons given above it is not necessary to dose sheep at regular intervals for liver fluke as is the case with cattle. The condition can be prevented by denying sheep access to natural water bodies. In the event of an acute outbreak several drugs can be used for treatment.

***Schistosoma mattheei*, Bilharzia**

This parasite has a similar life cycle to liver fluke but the adult flukes live in the blood vessels of the intestine. Sheep are infested when the immature stage burrows through the skin. Research in Rhodesia has shown that a moderate infestation has a marked depressant effect on live mass gains. Over a period of one year infested lambs gained 20 kg less than non-infested controls. The infested sheep were also anaemic with haemoglobin levels much lower than non-infested controls. Control of this parasite, as in the case of liver fluke, can be obtained by denying sheep access to natural water. Treatment is possible but the drugs are expensive.

***Paramphistomum cervi*, Conical fluke**

Paramphistomiasis, or conical fluke infestation, occurs occasionally in sheep.

The life cycle of this parasite outside the sheep is similar to the liver fluke. The immature stage however develops in the first part of the small intestine, thereafter migrating forward to the rumen where the adult flukes are found, usually on the folds of the groove at the front of that organ.

This parasite can cause trouble when large numbers of immature flukes are present in the bowel at the same time. These flukes attach themselves to the wall of the bowel and the resultant damage caused by the large numbers of immature stages produce the condition commonly called strawberry gut. Sheep, usually lambs, infested with the immature stage of this parasite have a persistent diarrhoea.

Coccidiosis

This disease is caused by a protozoan parasite which attacks the cells of the intestine.

There are at least twelve different species of coccidia which may be found in sheep.

The animal ingests the infective stage (oocyst). In the bowel these oocysts liberate sporozoites which enter the cells on the surface of the bowel. This is followed by a complicated process of multiplication during which many cells are parasitized. Finally oocysts are again produced which pass out in the faeces.

Symptoms: This disease is only a problem in housed sheep, mainly lambs. Persistent scouring, with dark blood-stained faeces is the main symptom. The lamb becomes weak and may die after a few days.

Post-mortem findings: The lamb is in poor condition and the contents of the

bowel are very liquid. Small white areas may be seen on the lining of the bowel.

Diagnosis: This must be based on the clinical picture and the post-mortem findings. Oocysts are commonly found in the faeces of normal sheep so the detection of these parasites in faeces samples is of no significance unless related to the clinical picture.

Treatment: Several drugs can be used to treat the disease.

Prevention: Ensure that lambs are in good condition and free from worm infestation which would lower their resistance.

Table 12.1 Dosing programme for roundworms

October	Dose at intervals of three weeks
November	
December	
January	
February	
March	
April	Dose at intervals of six to eight weeks.
May	
June	
July	

August

September

This programme may have to be varied depending on climatic or management factors.

8. External Parasites

The three common external parasites are lice, ticks and scab mites.

Lice

The most common louse is the sheep body (biting) louse, *Damalinia ovis*. It is a small wingless insect about 1 mm in length and can only be detected by the use of a magnifying glass. The head and thorax are darker in colour than the rest of the body. This louse is found very close to the skin and moves rapidly among the wool fibres.

The louse spends the whole of its life cycle on the sheep and does not leave it unless it transfers from one animal to another. Eggs are laid by the female and are referred to as "nits". The eggs are small, barrel-shaped and attached to the wool by a glue-like substance. The eggs hatch in about 2 weeks and take about 3 weeks to develop into adults. Because of the small size of the parasite the fleece of infested sheep must be carefully examined with the assistance of a magnifying glass to detect the presence of lice.

Diagnosis: The adult lice feed on skin debris. When feeding close to the skin they cause intense irritation which causes the animal to bite and pull the wool or to rub itself against posts and other objects. The biting and rubbing causes considerable damage to the fleece. The disease is confirmed by the detection of lice.

Treatment: As the lice spend all their life cycle on the host one dipping in an insecticide with a reasonable residual effect is usually sufficient to eradicate the parasite. The sheep must be totally immersed. As the insecticide does not affect the eggs it is safer to dip again 14 days later to ensure destruction of the immature lice which hatch from the eggs.

The dipping should be carried out after shearing and all the sheep must be dipped to ensure that no reservoir of the parasite remains on an undipped sheep.

Ticks

Four species of ticks commonly infest sheep.

The brown tick -

Rhipicephalus appendiculatus.

The red-legged tick-

Rhipicephalus evertsi.

The bont tick -

Amblyomma hebraeum.

The bont-legged tick -

Hyalomma rufipes.

Hyalomma truncatum.

The brown tick

This tick does not transmit any sheep disease in Rhodesia. They may be found in large numbers, especially in younger sheep, on the lower extremities of the legs. In East Africa this tick transmits Nairobi Sheep disease.

The red-legged tick

Certain strains of this tick cause tick paralysis in lambs. They may be found on several sites, around the anus, in the inguinal grease gland or on the lower parts of the limbs. The larval and nymphal stages of this tick can be very troublesome in young lambs. The immature stages are sometimes present in

large numbers deep down in the ear. This infestation can cause a severe *otitis externa* (infection in the outer ear). The irritation can be so severe as to cause the lambs to stop suckling and die of starvation. Treatment consists of the application of an insecticide and a course of antibiotics where indicated.

The bont tick

This tick transmits Heartwater.

The bont-legged tick

On cattle this tick is commonly found on the hairless parts of the body around the anus and vulva. In sheep the converse applies and the tick is found on the hairy or woolled parts of the body, often on the chest or back. Only the adult stage of this tick is found on livestock; the immature stages have hares and ground birds as their preferred host.

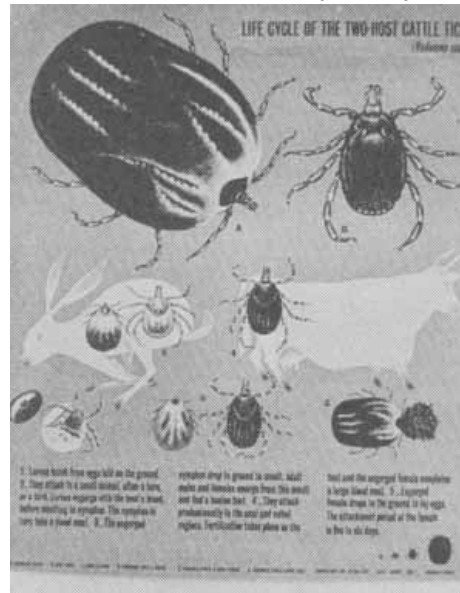

Lifecycle of a bont-legged (two host) tick of cattle and sheep.

Photo Cooper Rhodesia Limited.

This tick does not transmit disease but due to its large mouth parts it causes considerable irritation at the site of attachment. The discomfort caused by the tick, especially if more than one is present on sheep, can interfere with the animal's nutrition and live mass gains.

Control: Dipping at monthly intervals in an organic insecticide gives satisfactory control. A much longer residual effect is obtained with sheep than cattle due to the retention of insecticide in the fleece.

Scab

This condition is due to infestation with the Scab mite, *Psoroptes communis* var. *ovis*.

This disease has been eradicated in several countries overseas by regular dipping. Sporadic outbreaks still occur in Rhodesia.

This disease is specified and the mite is a specified pest under the Animal Health Act, 1960.

The mite lays its eggs at the edge of a lesion (affected area of skin); the larval and nymphal stages last about 2-4 days each and a life cycle is completed in 8 to 9 days. All stages of the mite are capable of survival away from the host for up to 10 days and adult females may survive for 3 weeks.

The mites may be found on any part of the body but on badly affected sheep the lesions are commonest on the sides. The mites puncture the skin and feed on lymph; this causes local inflammation which results in itchiness.

The early lesions are small, about 6 mm in diameter, and consist of small papules which ooze serum. In older lesions scabs are formed and the wool is

bound into a mat. The sheep bite or scratch and rub against objects. Large areas of bare skin may be present due to the shedding of the wool.

Diagnosis: The disease is confirmed by the recovery of mites from scrapings taken from affected areas of skin. The disease must be differentiated from other skin diseases, especially lice infestations.

As the disease is specified under the Animal Health Act 1960, any owner who suspects his flock to be affected must report the fact to the nearest veterinary officer.

Treatment: The disease is fairly easy to treat. Two dippings at an interval of 10-14 days with benzene hexachloride (B.H.C.) will usually be sufficient to eradicate the disease.

Prevention: Dip newly purchased sheep if there is any evidence of ectoparasite infestation.

Siphonaptera, Fleas

Heavy infestations of fleas on young lambs and kids can contribute to mortality, especially if they are in poor condition.

The female flea lays up to 400 eggs in her lifetime. These eggs are laid in dust and dirt. The rate of development varies according to the suitability of the site and the climatic conditions. When temperatures and humidity are high the life

cycle may be completed in about 6 weeks but if temperatures are low the imago (adult stage) may remain in its cocoon for several months. This explains the heavy infestations which may occur when temperature and humidity rise in October and November.

Diagnosis: Is based on the presence of large numbers of the parasite.

Treatment: Most insecticides give effective control.

***Oestrus ovis*, Nasal worm**

This parasite is not a worm but is the larval stage of the sheep nasal fly. The fly is grey in colour, about the size of a blue bottle, and has small black spots especially on the middle part of the body. The adult flies are active throughout the year. They deposit larvae around the nostrils of their hosts. When flies are around trying to deposit larvae the sheep are greatly disturbed and the animals become restless and huddle in a circle with their heads to the ground. The larvae crawl up the nostrils of the sheep, their hooks causing considerable irritation. The first stage of development (instar) takes place in the nasal passages of the host. The second and third stages are found in the frontal sinuses. The fully grown larvae crawl out and pupate in the ground developing into the adult fly. The larvae spend approximately 5-6 weeks in the nasal sinuses and the adult fly takes 3-6 weeks to develop from the pupa to the adult fly.

The larvae with their hooks and spines irritate the sensitive lining of the sinus

and cause the secretion of a thick mucus. Infected sheep therefore have a constant thick nasal discharge and sneeze frequently. The irritation interferes with the animal's appetite and live mass gains.

Treatment: A new remedy has just come on the market which is highly effective against all three larval stages.

Prevention: Dosing as required. Where sheep are housed the placing of a few chickens or bantams in the run will reduce the number of larvae surviving to pupate.

9. Post-mortem examination of sheep

- 1. A wheelbarrow covered with a piece of steel mesh makes a convenient examination table and the instruments required are: a hacksaw; a pair of scissors; a sharp knife; a few microscope slides and several plastic bags for specimens.**
- 2. Before any incision is made, a careful examination of the outside of the body should be carried out, looking for obvious wounds or the presence of external parasites, such as ticks, scab mite or lice.**
- 3. The nostrils should be carefully examined for any evidence of a mucus discharge which may indicate a nostril-fly infestation or pneumonia. If the former is suspected then the head should be cut through, from front to back, down the centre using the hacksaw. If nostril flies are present, the larvae will**

show up as white or black maggots in the cavities of the nose.

4. The lips and mouth are examined to check that there are no abnormalities.

5. The throat is examined for enlargement of the thyroid gland, commonly called goitre. This shows as a large swelling just below the lower jaw, and is commonest in new-born lambs. The two swollen lobes can be felt easily.

6. The ears should be examined for the presence of ticks.

7. In young lambs, special attention should be given to the scrotum and tail to check for the presence of an elastrator ring or subsequent infection. This could be the cause of tetanus.

8. The lower portions of the legs, the armpits and the groin should be checked for the presence of red-legged ticks, which could cause paralysis and death in younger sheep.

9. Scorch marks on the hair or wool, extending down the legs as fairly thin lines, would indicate that the animal had been struck by lightning.

10. Now the skin must be removed from the whole carcass, taking care to keep the initial cuts shallow, through the skin only, and not to go too deep and so cut through the body wall as well.

11. The inner surface of the skin, and the carcass itself, should now be

examined for damage by bruising or by grass-seeds.

12. A swelling in front of the shoulder or hind leg may be due to an infection in the gland, commonly called "cheesy gland".

13. Lay the carcass on its right side.

14. Cut through the muscles which hold the fore-limb in place, and lay it back clear of the ribs.

15. Cut into the groin, sever the ligaments of the hip joint, and lay the hind leg back.

16. Cut away the side of the abdominal wall from the groin to the chest and thence along the last rib and the backbone. Remove this flap of flesh.

17. During and after the removal of the abdominal wall, examine the content of the abdominal cavity (normally small amount of clear, serous fluid). If blood tinged, it may indicate peritonitis or inflammation of the intestines. Abdominal fluid is also excessive when an anaemia is present.

18. The abdominal organs are held in place mainly by thin membranes which tear easily. Use the knife carefully in removing them, so as to avoid cutting the stomach and large veins.

19. Remove the organs in the following order: spleen (attached to the

stomach); left kidney (attached to the backbone); stomach and intestines; liver; right kidney.

20. Next remove the left chest wall by cutting the ribs along the breastbone and along the back with the hacksaw.

21. Remove the lungs and heart. Care should be taken not to damage the heart sac. If fluid is present in the heart sac, this may indicate that death has been due to Pulpy Kidney.

22. The heart is then opened, exposing the two upper and two lower chambers. The valves and the interior of the heart can now be examined, together with the big blood vessels. Where death has been due to Blue Tongue, a dark, blood-stained area can always be seen in the wall of the vessel carrying blood to the lungs.

23. The windpipe is now opened using scissors, and the cut should be continued down into the two small air passages entering each lung.

24. Now the liver is examined. If the surface is uneven, this may be the result of Bilharzia or of Liver Fluke infestation.

The substance of the liver is examined by making a cut through the middle of the organ. The consistency should be friable, almost crumbly, breaking up easily under light pressure. Liver tapeworms are found in nearly all sheep livers.

25. The kidneys are next examined by making a cut right through the substance of both these organs. The most common change in kidneys is due to Pulpy Kidney, when the substance of the kidney becomes soft and pulpy.

26. The stomachs and bowels are now examined. The paunch, or rumen, is cut from end to end, starting at the gullet, and the contents and wall are examined. Adult conical fluke may be seen attached to the wall of the rumen where the gullet enters this organ. The honeycomb or reticulum, is now opened and examined. Sand is often found in here, but is of no significance. The manyplies, or omasum is now opened; the contents of this stomach are always dry and abnormalities are rarely found.

The abomasum or true stomach, is now opened - this is the stomach where wire-worms may be found.

27. The bowel is released from the fine supporting tissue - the mesentery - and is now examined by splitting it down with scissors. In the first part of the bowel the small bankrupt worm may occur - these are too small to detect easily as they lie in the intestine, and these worms are more easily seen if the inner surface is scraped with one glass slide and the mucus then spread and trapped with a second slide, and the slides then held up to the light. Tapeworms also occur in the small intestine and are quite obvious. The nodular worm is another common parasite. The immature stages of this worm cause nodules in the outer surface of the bowel wall. The blind gut itself is now opened - the adult nodular worms can easily be seen if they are present.

28. Samples of any diseased organs found during the examination should be placed, fresh, in separate plastic bags and taken to the nearest veterinary officer, as soon as possible, for advice.

The RSPA film demonstrating a post-mortem examination of a sheep is available from the Department of Conservation and Extension for public showing.

10. VACCINATION PROGRAMME

Essential vaccinations

Pulpy Kidney vaccination

Lambs	Two months of age
Older sheep	Annually
Purchases	Prior to movement on to farm.

Blue Tongue

Vaccination September/October annually
Pregnant ewes must not be vaccinated
Rams should be vaccinated prior to mating.

Ovine Brucellosis

Vaccination of ram lambs at four months of age
Ensure that any ram purchased has been vaccinated.

Vaccinations which may be necessary

Rift Valley Fever/Wesselsbron

Vaccination required if disease present in the country.

The two vaccines can be combined.

Pregnant ewes and lambs under the age of one month must not be vaccinated.

Quarter Evil/Malignant Oedema

Vaccination as required for individual flocks on veterinary recommendation.

Tetanus

Vaccination as required for individual flocks on veterinary recommendation.

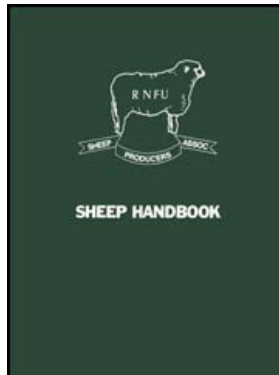

Sheep Handbook











Author(s): *D. J. Donkin*

Publication date: *1973*

Number of pages: *156*

Publisher: *Rhodesia Sheep Producers' Association, Ministry of Agriculture*

Contents:

-  [Acknowledgements](#)
-  [Introduction](#)
-  [Foreword](#)
-  [Chapter 1. The Rhodesian Sheep Industry](#)
-  [Chapter 2. Sheep Breeds in Rhodesia](#)
-  [Chapter 3. Breeding and Selection](#)
-  [Chapter 4. Management](#)
-  [Chapter 5. Sheep Management Calendars](#)
-  [Chapter 6. Nutrition](#)
-  [Chapter 7. The Grazing Sheep](#)
-  [Chapter 8. Handling Facilities](#)
-  [Chapter 9. Marketing of Sheep](#)
-  [Chapter 10. Wool](#)
-  [Chapter 11. Economics](#)
-  [Chapter 12. Diseases and Parasites](#)
-  [**Appendices**](#)
-  [General Information](#)

Appendices

[▲ Top](#)

APPENDIX I

Tables of feed requirements

Table A1 gives details of the daily nutrient requirements of sheep according to the *NRC of America (1968). It will be noted that sheep are grouped according to sex, size and stage in the production cycle.

In the USA, requirements for metabolizable energy are not listed as it is felt that any extra precision accruing from this system is likely to be lost when the farmer estimates the size of his sheep, the fibre content and digestibility of his feeds and the daily feed intake. In other words, in many practical circumstances little error may be incurred by using the TDN system when assessing the energy needs of sheep.

However, it has been considered desirable to include the **ARC tabulations in this publication (Tables A2, A3 and A4) because it is likely that in time the ME system will gradually replace the TDN system in the practical formulation of diets for ruminants. Farmers and advisory workers should therefore, familiarize themselves with the new concepts.

The two determinants of the production attained in a fattening animal of a given age are firstly, the concentration of the diet as a whole (Mcal ME per DM of feed) and secondly, the amount of the feed that is given each day.

NOTE:

1 Megacalorie (Mcal) =4,1868 Megajoules (Mj).

*** NRC - National Research Council of America.**

****ARC = Agricultural Research Council of Britain.**

Table A1 Daily Nutrient Requirements of Sheep (NRC 1968)

Body mass (kg)	Gain or loss (g)	DM Intake (kg)	TDN (kg)	DE (M cal)	Protein (g)	DP (g)	Ca (g)	P (g)	Salt (g)	Vit A (IU)
EWES										
Non-lactating and first 15 weeks of gestation										
45	32	1,08	0,59	2,6	95	54	3,2	2,5	9	935
54	32	1,26	0,68	3,0	109	59	3,3	2,6	10	1100
64	32	1,35	0,77	3,4	122	68	3,4	2,7	11	1320
73	32	1,53	0,86	3,8	136	73	3,5	2,8	12	1485
Last 6 weeks of gestation										
45	168	1,53	0,91	4,0	145	82	4,2	3,1	10	2320
54	168	1,71	1,00	4,4	154	86	4,4	3,2	11	2720

54	168	1,71	1,00	4,4	154	86	4,4	3,5	11	2720
64	168	1,89	1,09	4,8	163	91	4,6	3,5	12	3160
73	168	1,98	1,13	5,0	168	91	4,8	3,7	13	3640

First 8 to 10 weeks of lactation

45	- 36	1,89	1,24	5,4	181	100	6,2	4,6	11	2320
54	- 36	2,07	1,33	5,8	190	104	6,5	4,8	12	2720
64	- 36	2,25	1,40	6,2	200	109	6,8	5,0	13	3160
73	- 36	2,34	1,43	6,2	209	113	7,1	5,2	14	3640

Last 12 to 14 weeks of lactation i

45	32	1,53	0,91	4,0	145	82	4,6	3,4	10	2320
54	32	1,71	1,00	4,4	154	86	4,8	3,6	11	2720
64	32	1,89	1,09	4,8	163	91	5,0	3,8	12	3160
73	32	1,98	1,13	5,0	168	91	5,2	4,0	13	3640

Replacement lambs and yearlings

27	136	1,08	0,68	3,0	136	73	2,9	2,6	8	765
36	91	1,26	0,73	3,2	127	68	3,0	2,7	9	1065
45	64	1,35	0,77	3,4	118	61	3,1	2,8	10	1260

54	32	1,35	0,77	3,4	109	59	3,2	2,9	11	1530
RAMS										
Lambs and yearlings										
36	181	1,26	0,91	4,0	145	82	3,0	2,7	9	1035
45	136	1,53	0,95	4,2	145	82	3,1	2,8	10	1260
54	91	1,71	0,95	4,2	145	82	3,2	2,9	11	1530
64	45	1,89	1,04	4,6	145	82	3,3	3,0	11	1800
73	45	1,98	1,09	4,8	145	82	3,4	3,1	12	2025
LAMBS										
Fattening										
27	159	1,08	0,68	3,0	145	82	2,9	2,6	8	500
32	181	1,26	0,82	3,6	154	86	2,9	2,6	8	660
36	204	1,35	0,95	4,2	163	91	3,0	2,7	9	770
41	204	1,53	1,04	4,6	163	91	3,0	2,7	9	825
45	181	1,62	1,09	4,8	163	91	3,1	2,8	10	935

Table A2 Energy Requirements of Growing Lambs (ARC 1965)
(Mcal metabolizable energy per day)

Live mass (kg)	Ration Concentration (Mcal/kg DM)	[Daily gain grams/day				
		0	50	100	200	300
20	1,8	1,00	1,58	2,35		
	2,2	0,97	1,42	1,88	3,42	-
	2,6	0,93	1,29	1,69	2,70	4,20
	3,0	0,87	1,20	1,52	2,32	3,37
30	1,8	1,31	1,91	2,79	-	-
	2,2	1,27	1,76	2,32	3,88	-
	2,6	1,22	1,60	2,06	3,15	4,63
	3,0	1,17	1,51	1,89	2,74	3,82
40	1,8	1,59	2,30	3,20	-	-
	2,2	1,54	2,14	2,71	4,25	-
	2,6	1,48	1,92	2,41	3,54	5,00
	3,0	1,42	1,80	2,21	3,11	4,22

As a rough thumb rule, all good roughages have a dietary energy concentration of 2,2 Mcal/kg DM. Half roughage half grain mixtures have 2,6 Mcal/kg DM and high grain, low roughage mixtures have 3,0 Mcal/kg DM.

Table A3 Energy requirements of a ewe (weighing 70 kg and walking 3,2 km/day) when neither lactating nor pregnant and at four different stages of its lactation (ARC 1965)

Conc. of diet M cal/kg DM	Neither lactating nor pregnant M cat ME/day	Month of lactation			
		1	2	3	4
1,8	2,02	-		5,10	3,80
2,2	1,95	-	6,04	4,52	3,46
2,6	1,87	6,01	5,37	4,18	3,25
3,0	1,80	5,72	5,15	4,06	3,16

Table A4 Efficiency of utilization by ruminants of metabolizable energy for maintenance, for body gain and for lactation (ARC 1965)

ME of diet Mcal/kg DM	Efficiency of utilization of ME		
	for Maintenance	for Growth	for Lactation

1,6	66	33	62
1.8	67	36	64
2,0	68	40	66
2,2	70	44	68
2,4	71	47	69
2,6	72	51	70
2,8	74	55	70
3,0	75	58	68
3,2	76	62	64
3,4	78	66	61

The ARC (1965) also lists minimum requirements for protein and certain major minerals which have been tabulated in tables A5 to A8. It should be stressed that these are minimum requirements which should be exceeded under most feeding regimes. The ARC also recommends that, in order to maintain voluntary intake, the dry matter of the total diet should have a minimum of nine per cent crude protein.

Table A5 Minimum daily requirements of digestible crude protein (DP in

grams/day) for maintenance and growth of sheep (ARC 1965)

Live mass (kg)	DM* Intake (kg)	Rate of gain			
		grams/day	grams/day	grams/day	grams/day
		50	100	200	300
15	0,7	32	47	72	92
20	0,9	35	50	75	95
25	1,1	39	54	79	99
30	1,3	42	57	82	102
40	1,6	52	62	87	112
50	1,8	55	70	90	115
60	2,0	64	74	99	119
70	2,1	65	75	100	125

*** DM intake assumed to range from 4,5% of livemass for small lambs to 3,0% of livemass for larger sheep.**

Table AS Minimum daily requirements of digestible crude protein (DP in

grams/day) for maintenance and wool production (ARC 1965)*

Live mass (kg)	Assumed DM feed intake (kg)	Shortwool breeds	Longwool breeds
30	0,9	31	40
40	1.1	37	45
50	1,3	43	52
60	1.5	48	57
70	1.7	53	62

*** Table A6 applies to mature wethers (hamels) and ewes which are otherwise non-productive.**

Table A7 Supplementary daily requirements of digestible crude protein (DP in grams/day) to be added to minimum requirements in the case of pregnant ewes (ARC 1965)

Stage of pregnancy (months)	Assumed daily DM feed intake (kg)	Single lamb (6 kg)	Twin lambs (10 kg)
3	1,5	28	34

4	2,0	48	64
5	2.1	85	105

Table A8 Supplementary daily requirements of digestible crude protein (DP in grams/day) to be added to minimum requirements in the case of lactating ewes (ARC 1965)

Stage of lactation (months)	Assumed daily DM feed intake (kg)	Est. milk yield in 16 week lactation			
		80*	100	120	140
1	2,5	137	157	182	207
2	2.3	114	134	154	174
3	2,1	90	105	115	130
4	2,0	69	74	84	94

*** As a guide, un-supplemented ewes on veld at Matopos produced 76 kg milk over 16 weeks.**

Table A9 Minimum daily requirements of Calcium and Phosphorus (in grams) of growing sheep (ARC 1965)

Livemass (kg)	Daily gain (grams)							
	50		100		200		300	
	Ca	P	Ca	P	Ca	P	Ca	P
5	0,8	0,5	1,4	0,8	2,5	1,4	3,6	1,9
10	1,2	0,8	1,8	1,0	3,1	1,6	4,4	2,2
20	2,3	1,3	3,1	1,6	4,7	2,2	6,3	2,8
30	3,3	1,9	4,2	2,2	6,0	2,9	7,7	3,5
40	4,1	2,5	5,0	2,8	6,8	3,4	8,5	4,0
50	5,4	3,5	6,4	3,8	8,4	4,5	10,4	5,2
60	6,3	4,8	7,3	5,2	9,2	6,0		
70	7,2	5,5	8,2	5,9				

It will be noticed that certain differences exist between the standard feed requirements drawn up by the NRC in the United States and the ARC in Britain. These differences have arisen as a result of the varying techniques used to arrive at the standards in the two countries, as well as the differences of feeds, climate, management and so on. For farmers living outside these two

countries there is no option but to select the best from the two. The main objective in feeding sheep is the adequate nutrition of each class of animal to ensure optimum economic production. Even a slight deficiency in any one nutrient can affect the efficiency of digestion of the others. With pastoral animals there is always a certain degree of guesswork in assessing just what nutrients the animal is obtaining while grazing. Field experiments and experience provide the best guides to the most suitable supplements.

APPENDIX II

Composition of some rhodesian sheep feeds

Table A10 provides some analyses of feeds commonly available in this country. For convenience, the concentrates and near-concentrates have been divided up into groups according to the major nutrient each provides (cereals for energy; legume seeds and cakes and animal products for protein) while other feeds have been classified as dry roughages and succulents. It should be noted that these last groups may vary considerably from one set of growing conditions to another.

- Except for Metabolizable Energy (In Mcal/kg) and Vitamin A (IU per gram) all analyses are on a percentage basis. Where several analyses are available, an average has been taken after the exclusion of obvious extremes.**
- The Digestible Crude Protein (DP) of high protein feeds has been**

calculated where necessary from the Crude Protein figure, using the regression formula described by Steenkamp and Le Roux (1972):

$$\text{DP} = (0,998 \text{ CP}) - 4,886$$

For low protein feeds the method described by Bushnell (1964), or the digestion coefficients cited by Morrison (1956), whichever seems most appropriate, have been used.

- **Energy has been expressed**

(i) as Total Digestible Nutrients (TDN) based on the proximate analysis described by Bushnell (1964): $\text{TDN} = (\text{DP}) + 2,25$ (Digestible Fat) + (Digestible Crude Fibre) + (Digestible Carbohydrates)

(ii) as Metabolizable Energy (ME) where information on this is available.

- **Figures for the Calcium (Ca), Phosphorus (P) and Vitamin A contents have been included where this information is available.**

- **The source of each analysis is indicated by a code letter or group of letters in the right-hand column. The sources are as follows:**

B = Bushnell (1964);
C = Branch of Chemistry and Soil Science;
G = Grasslands Research Station;
M = Morrison (1956);
N = NRC (1968);
S = Standards Association of Central Africa;
T = Tracey (1945).

It should be noted that roughage feeds can vary considerably in quality depending on such factors as leaf to stem ratio, time of cutting, greenness and amount of dust. The figures given in section (e) of Table A10 can only be considered as a guide.

Table A10 Average Composition of some Rhodesian Feeds

FEED	DM %	CP %	DP %	TDN %	ME Mcal/ kg	Ca %	P %	Vit A IU/g	Source
(a) Cereals and other energy concentrates									
Butu (from munga/nyouti)	91	11,9	6,6	75*	-	-	-	-	B
Corn and cob meal	88	7,6	3,9	73	2,63	-	0,35	-	SN

Maize grain - white	88	8,0	6,5	85	2,88	-	0,40	-	SN
Maize grain - yellow	88	9,0	7,0	85	2,88	-	0,40	4,4	SN
Maize bran	90	7,0	4,0	68	1,40	0,03	0,50	-	S
Maize germ	90	10,0	7,5	87	3,57	0,04	0,50	-	S
Masese	93	11,9	8,1	62	-	-	-	-	CB
Molasses	75	3,2	0,0	54	1,95	0,89	0,08	-	N
Munga/nyouti (millet)	92	10,5	7,6	80	2,88	0,05	0,40	-	S
Oats grain	89	11,8	9,2	67	2,41	0,10	0,35	-	N
Rapoko	88	7,2	3,8	82	-	-	-	-	B
Snapcorn (corn, cob & husk)	88	7	4,8	72	2,51	-	-	-	G
Sorghum grain	90	10,0	8,1	79	2,82	0,04	0,30	-	S
Sugar (Canex)	90	-	-	97	-	-	-	-	S
Wheat grain	89	12,7	10,0	78	2,83	0,05	0,36	-	N
Wheat bran	90	14,0	9,5	65	2,20	0,10	1,10	1,0	SN
Wheat pollard	90	16,0	12,0	76	2,60	0,10	1,00	1,0	SN

*** Estimate may be high.**

FEED	DM %	CP %	DP %	TDN %	ME Mcal/ kg	Ca %	P %	Vit A IU/g	Source
(b) Legume seeds and oil seeds									
Cowpeas	89	23,4	19,2	76	-	0,10	0,46	-	M
Cottonseed (whole)	92	22,2	16,4	88	3,18	0,14	0,68	-	CM
Groundnuts (kernels)	94	30,0	27,6	138	-	0,06	0,44	-	BM
Groundnuts (in pods)	94	24,9	20,2	103	-	-	0,33		M
Jackbean	90	24,7	20,7	82	-	-	-	-	M
Jackbean and pod meal	90		13,0	72		-	-	-	T
Soyabean seed	91	39,8	35,4	84	3,03	0,25	0,59	1,4	BCN
Soyabean meal (full fat).	90	31,7	37,0	90	3,47	0,22	0,52	0,53	S
Sunflower seed (kernels)	! 95	27,7	25,2	116	-	0,20	0,96	-	M
Sunflower seed (with hulls)	94	14,0	19,1	71	-	0,17	0,52	-	CM
Sunflower head (entire)	93	8,9	3,7	60	-	-	-	-	G
Sunn hemp seed	92	29,4	24,0	78	-	-	-	-	C

Velvet beans	90	23,4	19,0	82	-	-	-		M
Velvet beans in pods	90	18,1	13,4	74	-	0,24	0,38		M
(c) Oil-seed cakes and meals									
Cottonseed cake I	93	41,3	32,8	72	2,30	0,20	1,20	0,3	BS
Cottonseed cake II	92	36,0	28,1	72	-	0,20	1,20	0,3	BC SM
Groundnut cake I	94	46,7	42,4	85	2,75	0,16	0,80	0,3	CS
Groundnut cake II	93	52,0	46,7	85	2,75	0,16	0,80	0,3	S
Soyabean meal (exp.)	90	43,8	39,4	85	2,76	0,25	0,60	0,3	S
Soyabean meal (Solv.)	89	45,8	i 41,3	71	2,52	0,32	0,67	-	N
Sunflower cake	94	50,7	46,2	72		0,26	1,22	-	BM
(d) Animal protein feeds and by-products									
Blood meal	88	80,0	56,7	60	2,68	0,28	0,22	-	BNS
Feather meal (hydrolysed)	91	87,0	61,0	62	-	-	-	-	CM
Fish meal (white)	91	65,0	60,8	75	2,50	3,00	2,50	-	SM
Meat and bone meal	93	48,0	40,0	65	2,45	12,50	5,50	-	SBN

Poultry manure (battery)*	90	30,0	14,4	-	-	-	-	-	G
Poultry manure (litter)*	90	26,0	13,0	-	-	-	-	-	G
Skim milk powder	93	33,5	30,1	81	2,92	1,26	1,03		BNS
Whole milk - cow's	12	3,1	3,0	16	-	0,12	0,10	-	NM
Whole milk - ewe's	19	6,5	6,2	26	-	0,21	0,12	-	M
Whole milk - goat's	13	3,6	3,4	17	-	0,13	0,11	-	M
*Estimate may be high.									

(e) Dry roughages

Cottonseed hulls	90	3,9	0,4	51	1,86	0,14	0,09	-	N
Cowpea hay	91	18,3	1,20	52	1,87	1,21	0,25	-	CN
Cowpea straw (seed harvested)	92	6,8	2,0	38		-	-	-	M
Dolichos hay	90	14,8	9,6	51	-	0,87	0,26	-	M
Groundnut hay (tops)	93	9,6	5,0	48	_	1,12	0,13		CM
Groundnut shells	94	4,9	1,2	19	-	0,25	0,06	-	CM
Jackbean-hay	92	17,0	11,7	51	-	-	-	-	C

Lucerne - early cut	93	18,5	13,0	52	1,89	1,22	0,33	74,5	CMN
Lucerne - good, average	91	14,1	10,2	50	1,85	1,20	0,22	30,0	MN
Lucerne - mature, stemmy	93	9,2	4,7	43	1,59	0,82	0,13	12,0	MN
Maize, cobs	90	2,5	0,6	44	1,60	0,11	0,04	1,0	N
Maize, leaves	83	7,7	3,5	50	1,79	0,57	0,21	-	M
Maize, sheath (husk)	85	3,4	0,4	40	1,42	0,15	0,12	-	M
Maize, stalk	83	4,7	0,8	41	1,46	0,32	0,23	-	M
Maize, stover	87	5,1	2,7	54	1,96	0,43	0,08	-	N
Maize, mill screenings	90	9,2	5,6	78		-	-	-	C
Rhodes grass (Giant) hay	91	8,3	3,7	51	-	-	-	53,0	CM
Soyabean hay	93	14,3	9,6	49	1,74	1,10	0,22	-	CN
Soyabean straw	88	4,8	1,4	38	1,36	1,39	0,05	-	N
Sunnhemp hay	92	11,4	6,4	50	-		-	-	C
Sweet potato vines	91	12,6	8,9	52	-		-	-	M
Velvet bean hay	90	12,5	7,3	49	-	-	0,24	-	CM
Weld hay	90	2,0	0,5	45					

Feed Hay	30	2,0	0,5	45					
(f) Green roughages and succulents									
Cactus leaves (prickly pear)	17	0,8	0,4	9	0,33	1,08	0,01	-	N
Clover (Ladino-T. repens)	17	4,1	3,3	12	-	0,21	0,07	92	M
Kale - marrow stem	14	2,2	1,8	10	-	-	-	-	M
Lucerne - immature	21	4,3	3,4	13	0,47	0,48	0,06	103	M
Lucerne - in bloom	25	4,3	3,2	14	0,51	0,39	0,07	90	NM
Majoda melon	6	0,7	0,5	5	-	-	-	-	M
Napier fodder	15	1,6	1,0	8	0,29	0,09	0,06	-	N
Oats - before heading...	14	3,2	2,4	9	-	0,06	0,09	100	M
Oats - headed out	27	2,5	1,8	17	-	0,09	0,09	100	M
Paspalum - Paraguay	20	1,6	0,6	11	-	-	-	-	G
Paspalum - wintergreen	20	2,0	0,8	8	-	-	-	-	G
Potato tubers	24	2,2	1,4	21	0,75	0,01	0,05		NM
Pumpkins	10	1,7	1,3	9	-	-	0,04	?	M
Rapoko grass (Elusine)	20	2,1	1,0	11	-	-	-	-	G
Star grass (Mogusa)	20	2,0	0,0	11					G

Star grass (maguga)	20	2,0	0,9	11	-	-	-	-	G
Sudan grass	23	2,0	1,4	14	0,50	0,12	0,10	80	NM
Sugar cane tops	26	1,3	0,6	13	-	0,09	0,07	-	M
Sweet potato leaves	17	2,8	1,9	11	-	-	-	-	B
Sweet potato tubers	32	1,6	0,2	26	-	0,03	0,04	-	M
Veld grass - immature	32	3,5	2,3	21	0,75	0,20	0,05	115	N*
Veld grass - mature	71	3,2	0,8	49	1,78	0,28	0,08	-	N*
(g) Silages									
Citrus pulp	20	1,4	0,4	17	0,62	0,40	0,03		N
Maize, good, high DM	40	3,2	1,8	28	1,00	0,11	0,08	-	N
Maize, average quality	28	2,3	1,3	19	0,69	0,08	0,06	-	N
Maize, poor quality	27	2,0	0,7	15	0,53	0,10	0,05	-	N
Maize and legume	26	2,6	1,8	19	0,68	0,28	0,12	-	N
Sunflower	23	2,1	1,6	12	-	0,39	0,04	-	M
Sweet sorghum	26	1,6	0,4	15	0,55	0,09	0,05	-	N

*** An American analysis of *Andropogon* spp., which has been included as it provides a good illustration of the sort of changes that can occur in natural grazing over the season.**

Table A11 Mineral Supplements (macro-elements)

SUPPLEMENT	Ca %	P %	Fe mg/kg	Mn mg/kg	Salt %	Zn mg/kg
Bonemeal	22,00	9,00	500	30	0,80	425
Dicalcium phosphate	22,00	18,00	-	700		-
Monocalcium phosphate	16,00	20,00	-	-		-
Monosodium phosphate	-	22,00	-	-		-
Limestone flour	37,00	0,04	-	600	0,10	-

APPENDIX III

Balancing rations and supplements

A knowledge of the feed requirements of a particular class of sheep, together with an analysis of the available feeds is all that is necessary for the farmer to ensure that his sheep are adequately fed. The foregoing sections provide

sufficient information for the simple formulation of balanced rations and supplements. It should, however, be borne in mind that there may be considerable differences in the composition and feeding value of two different lots of the same kind of feed. Also, individual animals may differ somewhat in their ability to digest and utilize feed. Any balanced ration on the farm should therefore provide a sufficient margin of safety to take care of these differences.

(i) FEED FORMULATION: FIXED SUPPLEMENT METHOD

This is usually the best method to use, particularly when more than two component feeds are to be included in the diet. For simplicity only the dry matter (DM), digestible crude protein (DP), total digestible nutrients (TDN), calcium (Ca) and phosphorus (P) will be considered in the example.

The first step is to set out the requirements of the animal (in this example, from Table A1) and then, bearing in mind the total dry matter intake of an individual, set up the relevant inclusions of the constituent feeds using the analyses given in Table A10.

Example 1

In this example, we will prepare a ration for ewes weighing 54 kg (120 lb.) on average, in early lactation, grazing on maize stover which has been well gleaned. The farmer has ample maize (as corn and cob meal), and his fixed supplement is provided by a limited amount (5 tonnes) of good average

quality lucerne hay. He intends to purchase cottonseed cake as a protein supplement, if necessary. He has 168 ewes in the flock, which means that $5\ 000 \div 168 = 30$ kg of lucerne hay is available for each ewe. This would permit him to feed 0,5 kg lucerne hay to each ewe every day during the critical first 60 days of lactation.

Daily requirement	DM (kg)	DP (g)	TDN (kg)	Ca (g)	P (g)
54 kg ewe, early lactation	2,07	104	1,33	6,5	4,8
Analysis of available feeds	DM %	DP %	TDN %	Ca %	P %
Lucerne hay	91	10,2	50	1,20	0,22
corn and cob meal	88	3,9	73	-	0,35
Daily supplement	DM (kg)	DP (g)	TDN (kg)	Ca (g)	P (g)
0,5 kg lucerne hay	0,45	51	0,25	6,0	1,1
1 kg corn and cob meal	0,88	39	0,73		3,5
1,5 kg supplement	1,33	90	0,98	6,0	4,6

Each animal has a capacity for approximately 0,74 kg DM more. As the stover is 88 per cent DM each ewe will consume approximately

$$\frac{0,74 \times 100}{88} = 0,84 \text{ kg stover}$$

	DM (kg)	DP (g)	TDN (kg)	Ca (g)	P (g)
0,84 kg stover provides	0,74	23	0,45	3,6	0,07
Total average intake	2,07	113	1,43	9,6	4,67

When the total average intake is compared with the requirements, it will be noted that the daily ration is likely to provide a surplus of all nutrients except phosphorus. This can be rectified by the provision of a salt/phosphate lick. Obviously, in this example, no cottonseed cake will be necessary: When the lucerne hay runs out a new supplement should be formulated.

(ii) FEED FORMULATION: PERCENTAGE METHOD

This method is particularly applicable when formulating a complete diet or concentrate mixture in which a desired total composition is sought. Calculations are speeded up when experience indicates the approximate proportions of the ingredients which are likely to be needed in the mixture.

Example 2

In this example, we shall prepare a concentrate ration as a supplement to 54 kg ewes in late pregnancy that are on a very poor quality grazing. This means

that all the protein and some of the energy must come from the supplement but, at the same time, this supplement must be sufficiently concentrated:

- (i) to allow some surplus gut capacity for a limited grazing intake;**
- (ii) to minimize transport costs of the feed.**

Daily requirement	DM	DP	TDN	Ca	P
	(kg)	(g)	(kg)	(g)	(g)
50 kg ewe, late pregnancy	1,71	86	1,00	4,4	3,3

The farmer has maize grain and sorghum grain he wants to use in approximately similar quantities. He has purchased cottonseed cake as his protein concentrate and intends to incorporate a small amount of molasses to reduce dust and improve palatability.

Analysis of available feeds	DM	DP	TDN	Ca	P
	%	%	%	%	%
Sorghum	90	8,1	79	0,04	0,30
Maize	88	6,5	85	-	0,40
Cottonseed cake	93	32,8	72	0,20	1,20
Molasses	75	0.0	54	0.89	0.08

The farmer wishes to restrict the daily intake of the supplement to 0,5 kilogram per ewe and under this restricted condition the supplement must have a digestible crude protein (DP) content of no less than 17,2 per cent. This last figure is calculated as follows:

To provide 86 g DP in 500 g, the mixture must be:

$$\frac{86 \times 100}{500} = \frac{86}{5} = 17,2\% \text{ DP}$$

Ration (first attempt)

		DM	DP	TDN	Ca	P
Sorghum	25%	22,5	2,02	18,8	0,01	0,07
Maize	25%	22,0	1,62	21,3	-	0,10
Cottonseed cake	40%	37,2	13,12	28,8	0,08	0,48
Check						
Total	90%	81,7	16,76	69,9	0,09	0,65

Now let us examine the result of the first attempt.

Note 1. The percentage (extreme left) column does not total 100 per cent. This is to give us some flexibility.

Note 2. The DP percentage total is lower than our target of 17,2 per cent by about 0,5 per cent. Neither the sorghum nor the maize can be used to raise this as their protein content is too low. On the other hand, 2 per cent of cottonseed cake will provide

$$\frac{2 \times 328}{100} = 0,656\% \text{ DP}$$

Note 3. The calcium and phosphorus levels are a bit low in the concentrate, so we must add about 1 per cent of a mineral such as monocalcium phosphate (MCP). See Table A.11 for analysis.

Note 4. A further 1 per cent of salt can be added as an appetizer and molasses can be used to make up the balance of the concentrate.

Ration (final)

		DM	DP	TDN	Ca	P
Sorghum	25%	22,5	2,02	19,8	0,01	0,07
Maize	25%	22,0	1,62	21.3	-	0,10
Cottonseed cake	42%	39,1	13,78	30,2	0,08	0,50
MCP	1%	1,0	-	-	0,16	0,20
Salt	1%	1,0	-	-	-	-
Molasses	6%	1,5	-	3,2	0,05	0,00

01/11/2011
PROGRESS

	DFID	Livestock	Husbandry	Library	1.0	
	0,70	4,5	17,40	0,30	0,87	
	100%	90,1	17,40	74,5	0,30	0,87

Thus, 0,5 kg of
above provides

This mixture should prove satisfactory in practice since it provides all the required protein and phosphorus and yet still leaves sufficient gut capacity for the ewe to consume 1,8 kg of mature veld grass. A quick check with the analysis for mature veld grass in Table A10 (f) indicates a TDN content of 49 per cent and Ca content of 0,28 per cent. Sufficient energy and calcium will theoretically be available in the 1,8 kg of grazing and thus enable the ewes to meet all their requirements.

In practice, of course, this is not always the case. Particularly where the concentrate ration has a high energy component (e.g. the maize and sorghum) ewes often reduce their grazing intake below the maximum. It is for this reason that supplement rations should always err on the side of generosity.

(iii) FEED FORMULATION: THE SQUARE METHOD

This method is a very simple one to use when only two ingredients are to be included in the ration, and only one nutrient, say protein, is critical. It can often be used as an intermediate or preliminary stage in one of the two previous methods.

Example 3

Let us assume that the basic supplement in a ewe's ration provides all but 54 g of her DP requirements, and that we wish to feed about 0,30 kg (300 g) of the supplement to each ewe daily. This means that each kilogram of supplement will have to contain

$$\frac{1000 \times 54}{300} = 180\text{g or }18\% \text{DP}$$

Assuming the two ingredients of the supplement are cottonseed cake (32,8 per cent DP) and maize meal (6,5 per cent DP), draw a square as in Fig. A1 and with broken diagonal lines. Set down the percentages of the two components of the mixture at the left-hand corners of the square, and the desired percentage in the centre.

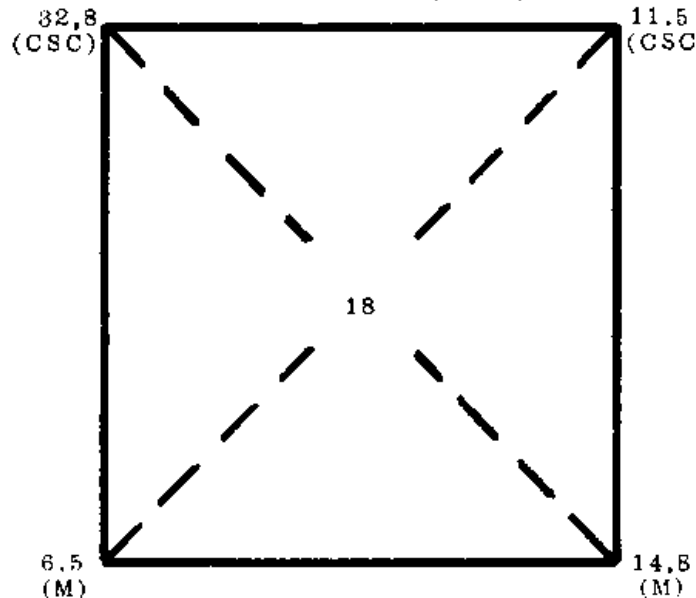

Fig. A1

Then follow the diagonal lines and set down in the opposite right-hand corner the difference between the figure in the left-hand corner and the figure in the centre. The figure in the top right-hand corner refers to the amount of cottonseed cake that must be mixed with the amount of maize in the bottom right-hand corner to give a mixture containing 18 per cent DP. For example a mixture containing 11,5 parts of cottonseed cake to 14,8 parts of maize would have a DP of 18 per cent.

The percentage of cottonseed cake in the mixture is found by dividing (11,5 x 100) by 26,3 = 43,75 per cent. The balance (56,25 per cent) is maize meal. In practice, a mixture of 44 parts of cottonseed to 56 parts of maize meal would be sufficiently accurate.

(iv) RATION FORMULATION: USING ARC ME SYSTEM

Although this system has a precision that is of particular value in scientific research work, it can be used at a more practical level if the various steps are followed through in a logical order.

Example 4

In this example let us consider the feeding of a ewe in early lactation which is on veld, grazing the early spring grass flush. The farmer has maize meal and cottonseed cake as supplements.

Analysis of available feeds

	DM %	DP %	ME Mcal/ kg	Mcal/ kg DM	Ca %	P %
Immature veld grass	32	2,3	0,75	2,3	0,2	0,05
Maize	88	6,5	2,88	3,3	0,2	0,40

Cottonseed cake	93	32,8	2,30	2,5	0,2	1,20
-----------------	----	------	------	-----	-----	------

The minimum requirements are defined in Table A12 and enable us to test whether the ewe can obtain sufficient from grazing alone.

	DM (kg)	ME (Mcal)	DP (g)	Ca (g)	P (g)
--	------------	--------------	-----------	-----------	----------

6,5 kg

young grass	2,08	4,9	150	13	3,2
-------------	------	-----	-----	----	-----

This diet has an energy concentration of 2,3 Mcal ME/kg DM and it is obviously too low in energy, protein and phosphorus. Let us now test the effect of a supplement of 0,5 kg maize meal.

	DM (kg)	ME (Mcal)	DP (g)	Ca (g)	P (g)
--	------------	--------------	-----------	-----------	----------

500 g Maize	0,44	1,4	32,5	-	2,0
-------------	------	-----	------	---	-----

5,2 kg

Young grass	1,66	3,9	119,6	10,4	2,6
-------------	------	-----	-------	------	-----

	2,10	5,3	152,1	10,4	4,6
--	------	-----	-------	------	-----

Table A12 Requirements: 70 kg ewe during first two months of lactation walking 3,2 km/day.

			Requirement	Source of information
	DM kg		2,1	3% of livemass
Energy	at dietary	1,8		Table A3 - mean
Mcal	concentrations	2,2	6,0	levels for first
ME/day	(in Mcal ME/kg DM)	2,6 3,0	5,7 5,5	two months
DP g 53 + 126 =			179	Tables A6 and A8
Ca g			8,2	Table A9
P g			5,9	

Even with its improved energy concentration of 2,5 Mcal ME/kg DM (i.e. 5,3 ÷ 2,10) this diet is still short of energy, protein and phosphorus, so let us add 250 g cottonseed cake, which we know is rich in protein and phosphorus and has a fairly good energy content.

	DM	ME	DP	Ca	P
	(kg)	(Mcal)	(g)	(g)	(g)

500 g Maize	0.44	1.40	32.5		2.0
-------------	------	------	------	--	-----

250 g Cottonseed cake	0.23	0,58	82,0	0,5	3,0
4,4 kg Young grass	1,40	3,30	101,2	8,8	2,2
	2,07	5,28	215,7	9,3	7,2

It will be noticed that the energy level is still low, but as it is likely to be uneconomic to feed more than 750 g (1,65 Ib) per day of the 2 maize: 1 cottonseed cake supplement to each ewe, it must be accepted (as does the NRC) that this ewe will have to lose a certain amount of condition during early lactation. This will have to continue until such time as the energy status of the grass improves and while the lactational strain is declining.

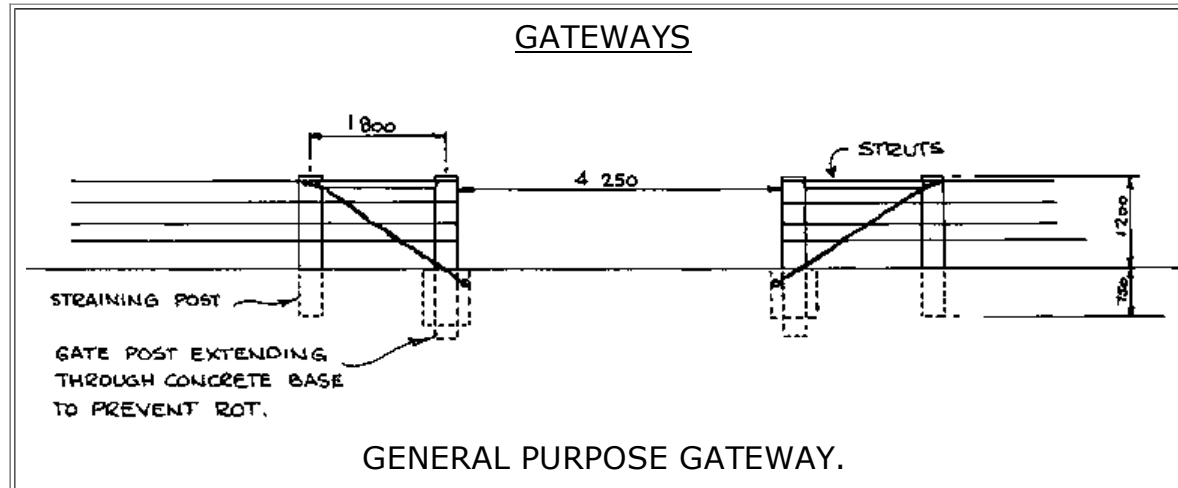

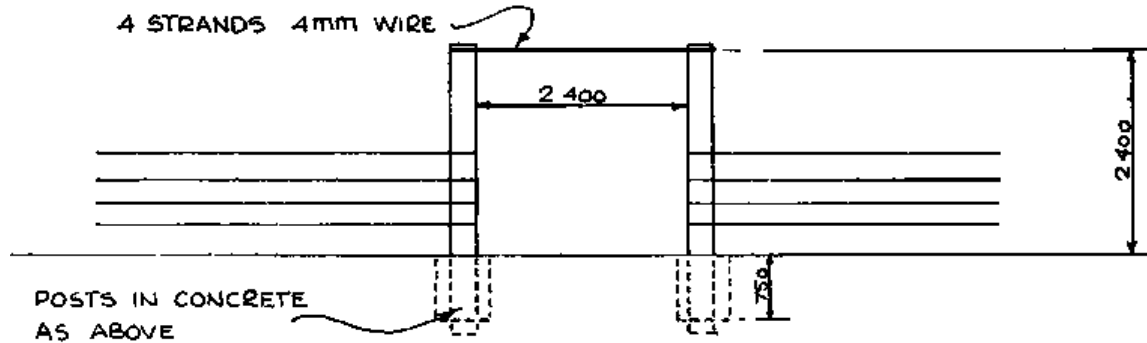

SIMPLE GATEWAY NOT FOR REGULAR VEHICLE TRAFFIC.

All measurements in millimetres.

DEPARTMENT OF CONSERVATION & EXTENSION, SALISBURY, MAY, 1973.

CORNER POSTS & STRAINING POSTS.
(USING ROCK ANCHORS)

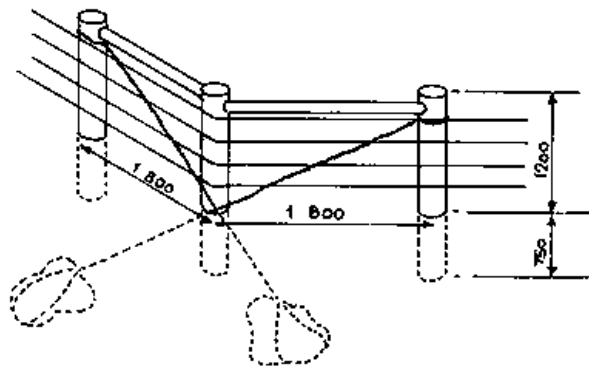

TYPE I.

CORNER POSTS.

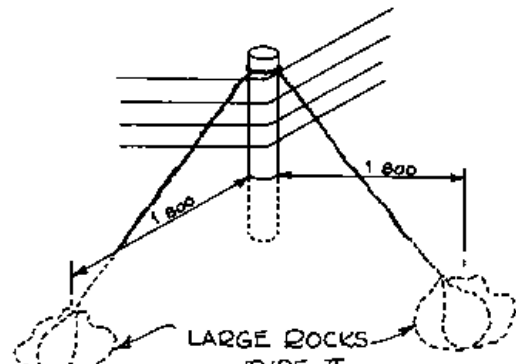

LARGE ROCKS

TYPE II.

CORNER POSTS.

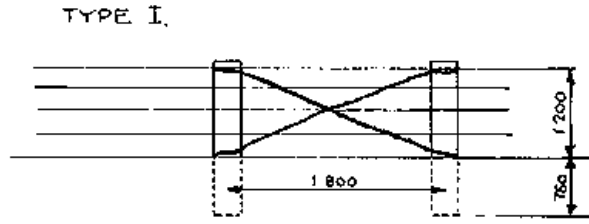

TYPE I.

TYPE I.

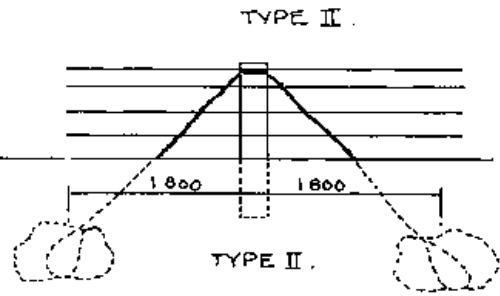

TYPE II.

TYPE II.

STRAINING POSTS.

All measurements in millimetres.

DEPARTMENT OF CONSERVATION & EXTENSION, SALISBURY, MAY, 1973

CORNER POSTS & STRAINING POSTS.

USING STRUTS & CONCRETE ANCHORS.

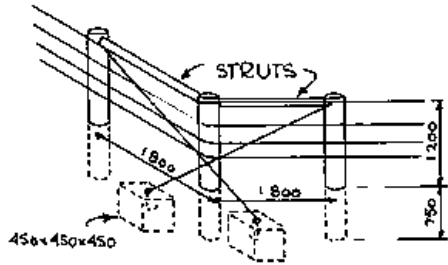

TYPE I.

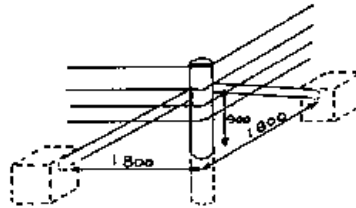

TYPE II

CORNER POSTS.

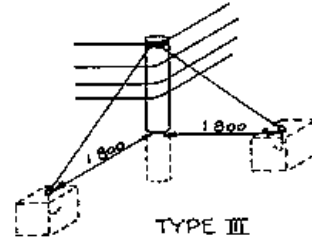

TYPE III

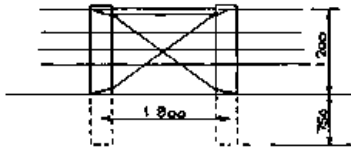

TYPE I

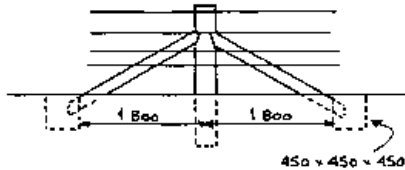

TYPE II

STRAINING POSTS

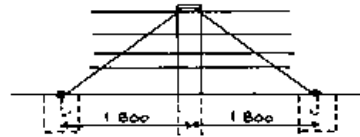

TYPE III

All measurements in millimetres.

DEPARTMENT OF CONSERVATION & EXTENSION, SALISBURY, MAY, 1973



HANDLING FACILITIES FOR 200 EWES

NOTES:

1. Shed allows 1m² for each ewe and her lambs.
2. Pens are large enough for sheep to escape if shed is burnt.
3. Fences should be 1m high.
4. Footbath floor is corrugated to open sheeps' feet, and sides are sloped so that they must walk through bath.

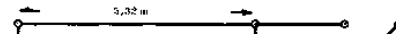

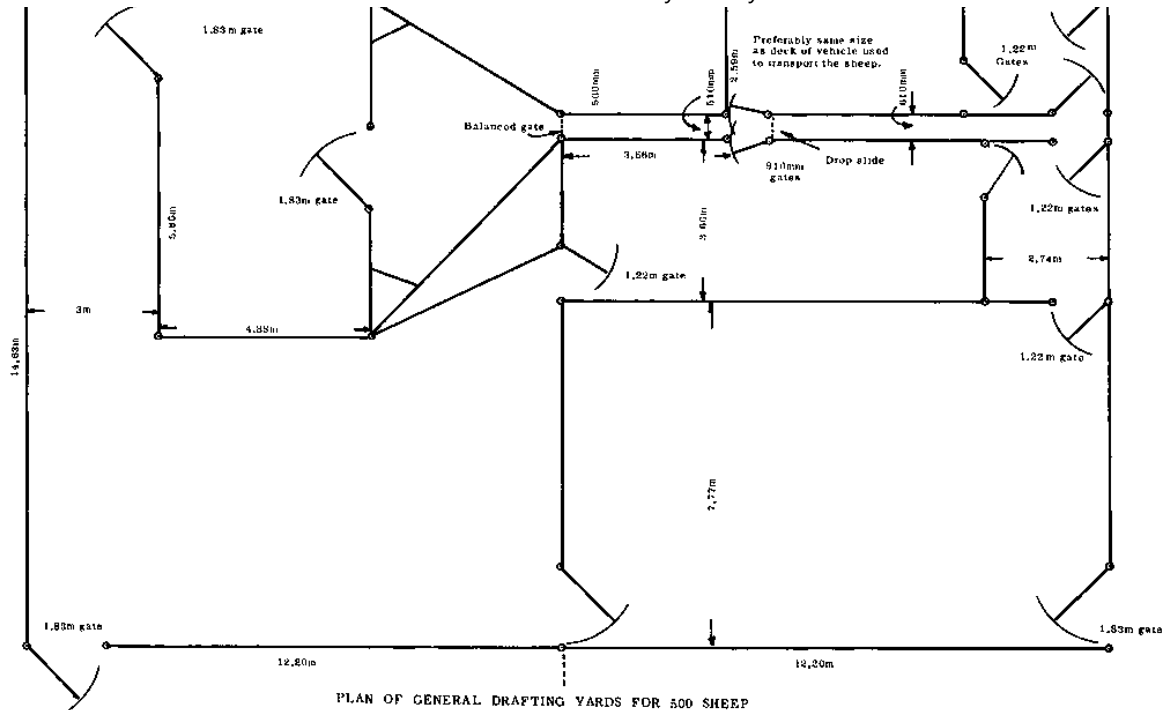

PLAN OF GENERAL DRAFTING YARDS FOR 500 SHEEP

Sheep Management and Diseases p244 - Department of Agriculture, New South Wales.

DFID Livestock Husbandry Library 1.0

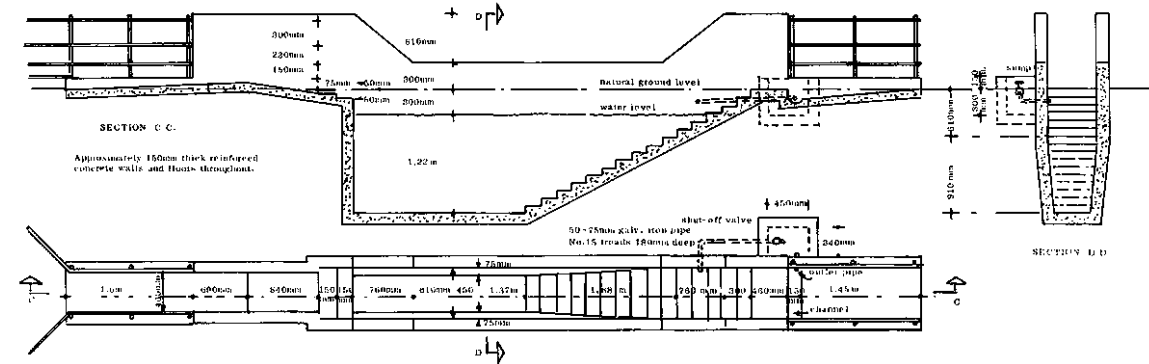
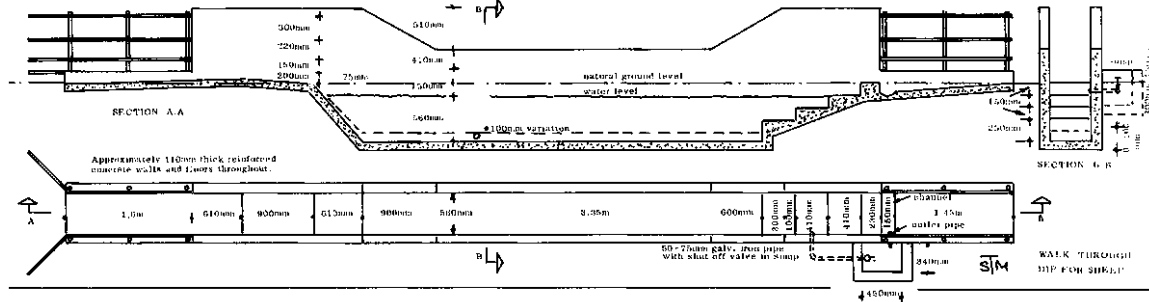

PLUNGE DIP FOR SHEEP

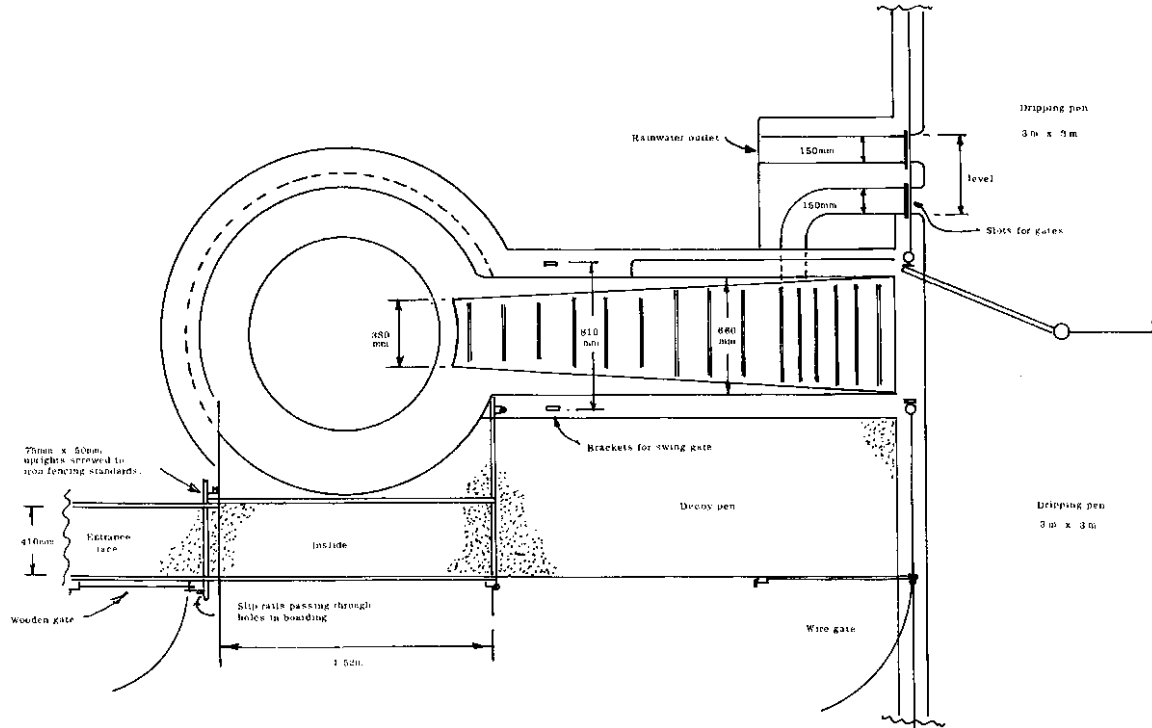

CIRCULAR DIP TANK PLAN.

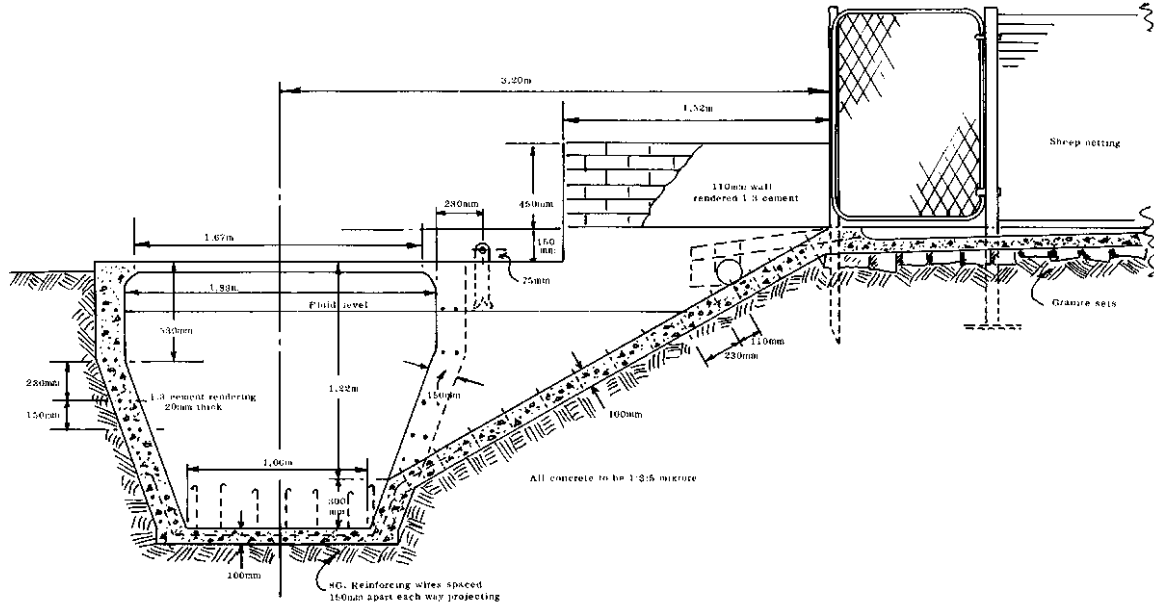

CIRCULAR DIP TANK SECTION.

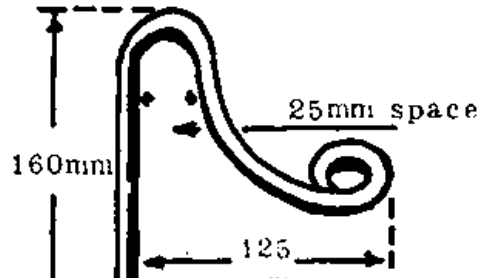

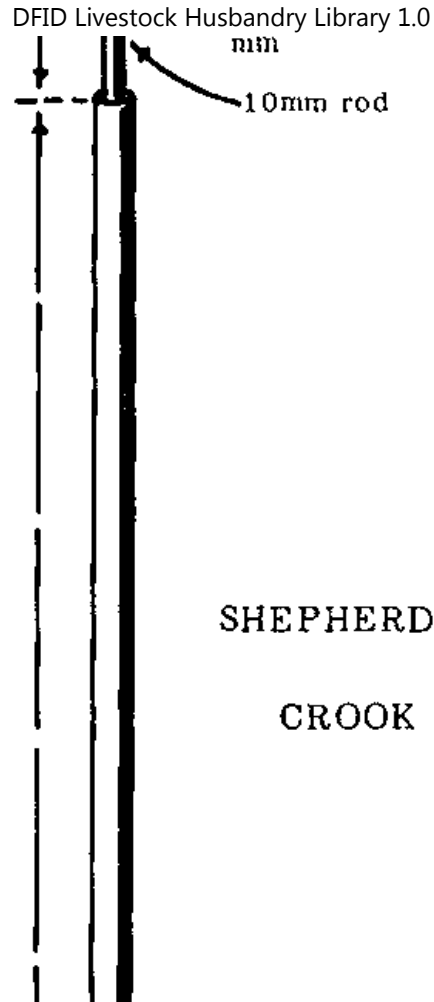

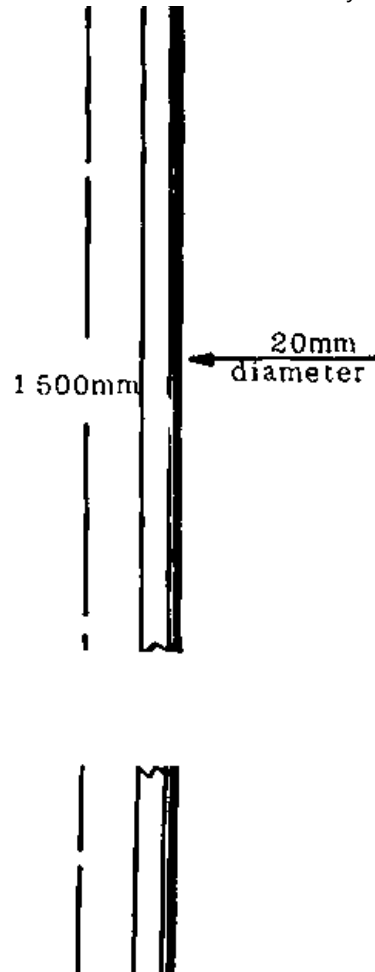



APPENDIX X

Flaying and curing sheep skins

Many sheep are slaughtered on farms in Rhodesia, or die from natural causes. Usually, the skins are discarded instead of being sold to hide and skin merchants or tanned for home use. However, since grass-seed infestation can greatly reduce the value of a sheepskin, the skins of sheep from bad grass-seed areas may be worth very little. On the other hand, a good size sheepskin

free from grass-seed and well cured, may be worth up to \$1,20 depending upon the world market. To enable use to be made of this potential resource, the following notes outline the correct procedures for the flaying and curing of sheepskins.

A. Slaughter and removal of the skin

- 1. Slaughter in the cool time of the day.**
- 2. Slaughter under conditions where the blood can drain away and not contaminate the skin, wool or carcass.**
- 3. Use a proper flaying knife with a rounded end - a sharp point often nicks the skin.**
- 4. Make the correct opening lines as follows:**

(i) *Start the main opening line* at right angles to the transverse cut which was made across the animal's throat for bleeding. Continue this line along the centre of the neck, breast and belly up to the anus.

(ii) *Do not flay the cheek portions.* No part of the skin on the head is normally left on the skin.

(iii) *When opening up the forelegs,* follow lines starting at the

knees, thence moving upwards along the front of the legs to where they join the torso, and then slightly to the inside, downwards along the sides of the breast to join the main opening line at the apex of the breastbone.

(iv) The opening lines for the *hindlegs* follow lines starting at the heels and thence continuing in a straight line upwards, along the back of the legs to the anus.

5. Use the flaying knife sparingly and with care to avoid unnecessary damage to the skin by cuts or marks. This kind of damage reduces quality and hence the value of the skin. Once the opening cuts have been made, "peel off" the skin using the knife handle or a clenched fist. In this way damage by cuts and nicks will be avoided.

6. Remove the skin immediately after killing while the carcass is still warm. After removal, allow the skin to cool in a clean place out of the sun and off the ground.

7. Avoid soiling the wool with blood, manure or soil, as woolled skins preferably should never be washed before curing. Wash hairy sheepskins thoroughly on both sides before curing.

8. If the flayed skin contains layers of flesh or fat, remove these carefully because they interfere with the removal of moisture during

curing. Fat which penetrates the skin during curing, also impedes the subsequent tanning process and results in grease stains in the finished leather. Remove fat, using a blunt knife with the skin spread over a curved scudding board (about the size of a 200 litre drum).

9. After cleaning off the fat, wash down the flesh-side before curing.

B. Curing

Cure the skin as soon as possible after it has been cleaned of flesh and fat and has lost body heat. There are three recommended methods, namely shade-drying, wet-salting and dry-salting.

1. Shade-drying

This is the least satisfactory method of curing sheepskins. Spread the skin out, using strong string within a frame of poles standing or suspended vertically in an airy shady place. If the skin is not tied in a frame hang it flesh side up, symmetrically along the line of the backbone, over a horizontal pole with a diameter of not less than 40 mm and not more than 80 mm. At regular intervals, open curled-up side and leg portions to prevent putrefaction which would be encouraged by insufficient circulation of air. Also, turn or move the skin regularly to prevent putrefaction along the line of contact with the poles. After about four or five days, when the skins are dry enough, remove them from the frames. Do not allow them to dry out completely; remove them while

they are still flexible. As a protection against insect attack, brush or dust the skins with a weak insecticide or cattle dip solution.

Although shade-drying can produce nicely cured skins under ideal conditions, this method is *not* satisfactory unless the weather is dry enough for the skin to cure in three or four days. If there is too much moisture in the air, the skin - particularly one with a dense wool covering - could take weeks to dry out, during which time rotting could easily render the skin worthless. It is for this reason that wet- or dry-salting is usually preferred for sheepskins.

2. Wet-salting

This is very effective, but adequate salt *must* be used (two to four kilograms) to prevent spoilage after cleaning. Lay the skin flesh side up on a table and rub in sufficient good, clean small-grained salt all over. The rubbing-in of the salt is very important and must be thorough. Then fold the skin, wool or hair side downwards, taking care no salt escapes.

Stack the wet-salted skins folded in this way for at least four days and then despatch them to the merchants as soon as possible thereafter. This is particularly true of wool sheepskins which may heat up if left in a wet-salt pile for more than four days. Since this will speed up putrefaction, it is imperative that they be opened up promptly and dried as indicated below if they cannot be sold immediately.

3. Dry-salting

Treat the skin as for wet-salting, but after it has been left rolled up and covered with wet sacks for four or five days, stretch it out flat and allow it to dry in the sun. Lay it out, flesh side up for the first four hours and then hair or wool side up until drying is completed. A fully salted skin should be resistant to insect attack.

February, 1975

Home tanning of sheep skins

On many farms the skins of sheep that have been slaughtered for home consumption, or have died from natural causes, are merely thrown away. This is a waste of a potential source of income. A sound well-cured sheepskin may be worth up to \$1,20 from a hide and skin merchant. Alternatively, the skins may be tanned on the farm for home use, for sale as mats or seat covers or for many other uses.

1. Flaying

The skin should be removed properly as soon as possible after slaughter. Contamination of the wool with blood or dirt should be avoided. Any such contaminated areas should be rinsed clean immediately. The flesh side of the skin should be scraped clean of all pieces of flesh and fat using a blunt putty knife.

2. Removal of hair

The fleece is an attractive feature of a wool skin, but it is sometimes desirable to remove the hair from non-wool sheepskins before tanning. This is achieved by what is basically the start of decomposition. The skin is immersed in a thin mixture of bran and soft (rain) water. It is then taken out, folded up wet and placed in a tub for 24 hours, after which it should be possible to scrape off the hair.

3. Washing

Make a good lather of soap (or detergent) and washing soda in hot water. Allow to cool until lukewarm. Then plunge the skin into it and wash thoroughly to remove all dirt.

Repeat with a fresh warm solution of soap (or detergent) and water, this time without washing soda.

Finally, rinse the skin in clear, cool water. Then shake out as much as possible and allow to drain.

4. Tanning

(a) Mix 500 g salt plus 500 g alum in 10 litres of hot water (or a pound each of salt and alum in two gallons hot water).

Allow to cool. If the skin is very large, a greater quantity of the same mixture may be required.

Soak the skin in the cooled solution for 12 to 24 hours, moving it about from time to time. Then remove and hang the skin over a 70 mm (3 in.) diameter wooden rail, flesh side inwards, to drain.

When well-drained, stretch the skin out to dry, lying it flat and smooth on a clean floor, board or wall, or in a frame, stretching it several times in the process of drying. The skin should be tacked or pegged wool-side downwards so that air can pass all around it. It should be placed in an airy place out of direct sunlight.

(b) While the skin is still slightly damp, rub some paraffin into the flesh side and leave for a few hours. This helps produce a softer pelt.

Then sprinkle the flesh side with a mixture of 30 to 50 g (one to two ounces) each of alum and saltpetre and rub this in well.

Tack the pelt out to dry once more, stretching it at intervals, as this ensures a good flat mat and gives a thin, even pelt.

5. Braying

Just before the skin is quite dry (usually after three to five days) scrape the flesh side with a blunt putty knife and rub it with pumice stone or fine sandpaper.

Frequent stretching, rubbing and working with the hands is then necessary to

get the skin soft and pliable. The process is continued until the desired softness is obtained.

The skin must be completely dry when the final braying is completed or it will go hard and buckle.

If the skin tends to be fatty when dried, the flesh side can be rubbed with flour, which is left on for a day or two and then scraped off.

6. Finishing

To clean and brighten the skin it can be tumbled and worked in warm bran or non-resinous sawdust. The wool is cleaned by shaking, brushing and combing. Irregularities in the wool can be trimmed.

This "home recipe" is not quite as good as the permanent finish provided by the chrome process used in commercial tanneries, but it is cheap and relatively straightforward once the routine has been established.

Exports of sheep

by

G. RUMSEY

Secretary,

Livestock Improvement Committee

- 1. Permits are not required for the export of sheep.**
- 2. The exporter must, however, obtain from his bankers a form C.D.I., the use of which the bank will explain,**
- 3. All exports will be subject to an animal health inspection. Arrangements for this must be made with the exporter's nearest Provincial Veterinary Officer, who will issue the necessary health certificate which must accompany the animals to their destination.**
- 4. Animals travelling via Botswana require an "In Transit" permit which will be issued by the Provincial Veterinary Officer when he signs the Animal Health Certificate.**
- 5. Animals may not be exported for slaughter purposes.**

MELARA
S.A. MUTTON MERINO STUD

FERTILITY - MOTHERING ABILITY - MILK PRODUCTION - RAPID GROWTH
CONFORMATION:
(99% of our slaughter lambs have achieved super lamb grade)
RAM LAMB — 4 MONTHS OLD



**This Stud is registered with the S.A. Mutton Merino Breeders' Society
in South Africa**

**All our foundation stock is imported and contains top
German and South African bloodlines**

MAVURA FARM BOX 65 RUWA	D. R. HINDE	Phone 5077321, Salisbury Visitors welcome
--	--------------------	--

Sheep imports

by

G. RUMSEY

Secretary

Livestock Improvement Committee

1. POLICY

Sheep importation is restricted to registered breeding stock only. First and second selection sheep are accepted as 'registered'. The only exception to this rule applies to immigrants (details below).

2. PROCEDURE

(i) Applications

Application for permission to import is made to the Secretary, Livestock Improvement Committee, P.O. Box 8117, Causeway, on the appropriate form which is obtainable from offices of the Department of Conservation and Extension.

The following conditions govern importations:

(a) Permits issued for this purpose are "Not Negotiable".

(b) Animals imported may not be sold or otherwise disposed of for a period of one (1) year from the date of import without the prior consent of the Committee.

(c) In the case of a company making application a representative of the company must be named in Box 1 of the application.

(d) The word 'Registered' means that the animals must have been entered, or accepted for entry, in the Herd Book of the appropriate breeders' club or society and in the register of the South African Stud Book Association.

(ii) Applications for foreign exchange

Provision is made in the application form for requests for foreign exchange allocations to cover the FOB or FOR cost of the animals. The amount of foreign exchange available is limited.

No part of an allocation may be used to cover transportation or insurance costs. Where imports are made from the Republic of South Africa, such costs must be arranged to be paid in Rhodesia. In the case of stock purchased overseas it is the responsibility of the importer to apply through his bankers for funds for freight and insurance purposes.

(iii) Allocations of foreign exchange

When an allocation of foreign exchange has been approved by the Committee a 'Letter of Intent' is issued to the applicant. This document is in two parts, one of which advises the applicant of the maximum amount made available to him. The second part is in the form of a certificate stating that an allocation (amount not specified) has been made to the applicant; this enables him to make his purchase. He is then required to submit the bill to the Livestock

Improvement Committee for its information. A currency certificate' is then issued by the Committee's Secretary who also arranges for the issue of import permits by the Ministry of Agriculture and the Department of Veterinary Services. These are forwarded to the importer with instructions as to their disposal.

3. IMPORT LICENCE

Included with the documents issued to the importer, and attached to the 'Currency Certificate' is a blank form, an 'Application for Licence to Import'.

This should be completed and submitted together with the Currency Certificate and the Veterinary Import Permit, to the nearest Import/Export Controller of the Ministry of Commerce and Industry. These are located at

11th Floor, Colray House,
Central House, Fort Street/9th Avenue,
Central Ave., and **Bulawayo**

Salisbury P.O. Box 696,
P.O. Box 8107, Bulawayo.
Causeway.

On receipt of his 'Licence to Import' the importer can then make arrangements, through his bank, for the transfer of funds, details of which will be endorsed by the bank on the back of the licence

4. 'NO CURRENCY INVOLVED' IMPORTS

When an intending importer has foreign funds he wishes to use for the purchase and importation of stock this fact must be shown on his application to the Livestock Improvement Committee.

It is the applicant's responsibility to obtain *and submit for the view of the Livestock Improvement Committee*, a certificate signifying that Exchange Control approval has been given to the intended transaction. These certificates are available from commercial banks.

If the application is then approved by the LIC, the Secretary will arrange for the issue of relevant documents. Procedure for obtaining an 'Import Licence' is as set out above.

A 'Letter of Intent' is not issued in these cases.

***NOTE:* A delay of two to three weeks may be expected in obtaining the required approval of the Exchange Control authorities.**

5. IMPORTS VIA BOTSWANA

When imports of livestock are to enter Rhodesia through Botswana an "In Transit" permit will be required. This will be issued by the Director of Veterinary Services, under authority from the Director of Veterinary Services, Botswana, at the same time as the Import Permit.

South African Railways will refuse to load in the absence of this permit which MUST accompany the animals through Botswana.

6. IMPORTS VIA BEITBRIDGE

Sheep may be imported into Rhodesia via Beitbridge, subject to the approval of the Director of Veterinary Services and under such conditions as he may impose. *It is the importer's responsibility to obtain such approval and details of conditions* from the Director of Veterinary Services.

7. IMPORTATION BY AN IMMIGRANT

A *bona fide* immigrant may import into Rhodesia such animals as are his property at the time of his entry into this country. Such animals must remain in his possession for a period of six months thereafter.

(i) Application by an immigrant

Application for permission to import is made on a form obtainable from the Secretary, Livestock Improvement Committee, at the address given above.

CONDITIONS OF IMPORTATION AS REQUIRED BY THE DIRECTOR OF VETERINARY SERVICES

1. At the time of issue of an Import Permit, the necessary Animal Health Certificate is issued in duplicate. These certificates must be completed and signed by a government veterinarian in the country of origin of the animals being imported.

(i) One copy of the Health Certificate must be sent by post to:

**The Provincial Veterinary Officer,
P.O. Box 572, Bulawayo.**

(ii) The other copy of the Health Certificate must accompany the animals to their destination.

(iii) The Animal Health Certificate must certify that the sheep:

(a) are healthy, free from any evidence of infectious or contagious disease, including scab, and are fit to travel;

(b) originate from an area free from quarantine restrictions for diseases of sheep and goats, including foot and mouth disease;

(c) have not crossed, on foot, any area under such restrictions,

within 60 days of departure;

(d) have been examined and found to be free from any clinical evidence of Infectious Epididymitis (*Brucella ovis*)

(e) that the semen of any ram being imported has been examined microscopically and been found to be free from *Brucella Ovis* infection;

(f) that the sheep come from a farm on which there has been no case of Scrapie or Johne's disease during the previous five years; and are free from Louping ill;

(g) the animals are from a farm which has no known history of Chlamydial infection, Enzootic abortion;

(h) all bedding and fodder accompanying the animals originate from an area that has been free from foot and mouth restriction for the past six months.

2. While en route

The animals must not come into contact with any other animals.

If travelling through Botswana the animals may not be off-loaded during that

period and no bedding or fodder may be taken on board.

3. Due care and attention will be exercised by Government officials dealing with the animals at the port of entry, but no responsibility for loss or damage which might occur during testing or detention will be accepted.

4. Any animal which, in the opinion of the Director of Veterinary Services, is likely to transmit an infectious or contagious disease may be returned to the country of origin or be destroyed without compensation.

