

# ***A Guide to Creating Self-learning Materials***

(GN1-02)

DAN R. MINNICK



INTERNATIONAL RICE RESEARCH INSTITUTE

# ***A Guide to Creating Self-learning Materials***

(GN1-02)

DAN R. MINNICK

1989  
INTERNATIONAL RICE RESEARCH INSTITUTE  
Los Baños, Laguna, Philippines  
P.O. Box 933, 1099 Manila, Philippines

1st edition, 1988.  
2nd edition, 1989.

*Correct citation:*  
Minnick, D.R. 1989. A Guide to Creating Self-  
Learning Materials. International Rice Research  
Institute. Los Baños, Laguna, Philippines.

# Contents

FOREWORD.....	7
PREFACE .....	8
WHAT this guide is about.....	8
WHO this guide is for - the intended users .....	8
WHY this guide - a case history .....	8
ACKNOWLEDGMENT .....	10
INTRODUCTION.....	11
New challenges and trends .....	11
Parts of a self-study program .....	11
The content.....	12
Style: a different approach .....	12
PART I - A/I OR SELF-LEARNING INSTRUCTION AS A LEARNING METHOD:	
SOME RELEVANT THEORIES AND CONCEPTS .....	14
CHAPTER 1. The Communication Process.....	14
Objectives .....	14
Berlo's Model .....	14
Communication modes .....	18
Feedback exercise.....	22
Answers to feedback exercise.....	23
References and information of interest.....	24
CHAPTER 2. The Self-study Option: How It Got Started, What It Can Do.....	24
Objectives .....	24
Tutorial, audiotutorial, autotutorial .....	25
- How autotutorial learning developed .....	27
- A module.....	29
Questions about self-learning instruction .....	29
- How well does it teach? .....	29
- How much does it cost?.....	30
- What are the advantages and disadvantages of the autotutorial? .....	32
The new role of the teacher .....	33
Autotutorial Instruction (A/I): our working definition .....	34
Feedback exercise.....	35
Answers to feedback exercise.....	37
References and information of interest.....	39
CHAPTER 3. A New Philosophy.....	40
Objective .....	40
Andragogy: adult-to-adult teaching.....	40
Interline .....	43
- Interline example.....	44
Feedback exercise.....	44
Answers to feedback exercise.....	45
References and information of interest.....	45
CHAPTER 4. Memory and Whole Brain Learning .....	45
Objectives .....	46
The human brain: center of learning and memory.....	46
- The left brain .....	47
- The split brain .....	48
- The right brain .....	48
- The whole brain .....	49
- The brain and A/I programs .....	50
Memory .....	51
- Where it's stored .....	51
- Memory gatekeepers .....	52
- Types of memory .....	54
- Storage sequence.....	54
Chunking, subsumers, and concept maps .....	55
- Chunking.....	55

- Subsumers.....	56
- Concept maps.....	58
Feedback exercise.....	59
Answers to feedback exercise.....	60
References and information of interest.....	60
CHAPTER 5. Learning Styles .....	61
Objective .....	61
How people learn.....	61
Learner personality types .....	65
A strategy for Learning Style 2 .....	73
References and information of interest.....	73
PART II - A/I OR SELF-LEARNING MATERIALS: CREATION AND USE .....	75
CHAPTER 6. Performance/Instructional/Objectives .....	75
The learning domains .....	75
Exercise 1 .....	76
Performance objectives .....	77
- Preamble.....	77
- Verb.....	77
- Object.....	79
Exercise 2 .....	79
- Qualifiers and quantifiers .....	80
- Chunk.....	81
Prospectus and rationale.....	83
Exercise 3: Writing objectives.....	83
Answers to Exercise 3 .....	84
Feedback exercise.....	86
Answers to feedback exercise.....	87
References and information of interest.....	87
CHAPTER 7. The Script.....	88
Objectives .....	88
The technical storyteller.....	89
Writing style .....	90
- Focus .....	90
- Tone .....	90
Arriving at a style .....	91
The frame format .....	94
- Editing the number of frames.....	96
- Editing time/frame .....	97
Organizing information.....	97
- The storyboard.....	98
Feedback frames .....	99
Transitions .....	100
Feedback exercise.....	101
Answers to feedback exercise.....	102
References and information of interest.....	102
CHAPTER 8. Visuals.....	103
Objectives .....	103
How visuals assist learning.....	108
Visuals and the storyboard .....	109
- Ready-made visuals .....	110
- Create your own.....	110
Visual style.....	110
Types of visuals .....	111
- Title or word slides .....	111
- Graphics.....	112
- Photographs.....	123
- Combination slides.....	124
Photographic equipment and slide copying.....	125
References and information of interest.....	127
CHAPTER 9. The Tape.....	128

Objectives .....	128
Components of a quality tape .....	129
Recording the narration .....	130
Editing the tape .....	135
Cues.....	135
Feedback exercise.....	136
Answers to feedback exercise.....	137
References and information of interest.....	137
CHAPTER 10. How to Use Feedback and Evaluation.....	138
Objectives .....	138
Repetition and A/I .....	139
Constructing feedback exercises.....	140
Referencing instruction .....	141
- Norm-referenced instruction .....	142
- Mastery-referenced instruction .....	144
Feedback exercise.....	146
Answers to feedback exercise.....	146
References and information of interest.....	147
CHAPTER 11. Creating A/I Programs: Problems and Shortcuts.....	147
Objectives .....	148
Problem 1: Hardware .....	148
Problem 2: Graphics .....	149
Problem 3: Time .....	150
Problem 4: Tape duplication .....	150
Problem 5: Photography .....	151
Problem 6: Updating programs.....	151
Problem XYZ.....	152
References and information of interest.....	152
CHAPTER 12. Managing A/I Programs: Problems and Shortcuts.....	152
Problem 1: The new instructor/student responsibility .....	153
Problem 2: Space .....	153
Problem 3: Using hardware .....	154
Problem 4: A check-out system.....	155
Problem 5: Demand for accessibility .....	156
Problem 6: Hardware that doesn't work .....	157
APPENDIX .....	159

## FOREWORD

The International Rice Research Institute has published this *Guide to creating self-learning materials* to assist trainers and communicators engaged in transferring knowledge and information on rice.

One of IRRI's primary responsibilities is to train scholars from developing nations in the rice sciences. For more than two decades it has conducted a training program in fulfillment of that responsibility.

IRRI recognizes that constraints exist in training and communication because of the explosive progress in information on the one hand, and the inherent difficulties in cross-cultural communication on the other. Thus, it is advantageous to continuously develop and explore learning methodologies that complement the well-established instructional methods of lecture, seminar, and laboratory/practicals, to expedite learning and cross-cultural communication.

The self-study approach to learning changes the role of the trainer/trainee, by placing greater responsibility for the learning process on the trainee. The method is deemed appropriate for IRRI trainees, who are established junior scientists and professionals.

This two-part *Guide to creating self-learning materials* for both trainers and potential trainers has been prepared in response to a widely felt need. It is intended to help training and communication practitioners understand the merits and limitations of using self-learning materials, create quality self-learning materials suited to the trainees' needs, and manage the use of self-learning materials effectively.

It is hoped that this publication will serve to provide a means of transferring knowledge and information on rice.

  
**KLAUS J. LAMPE**  
Director General

March 1989

# PREFACE

The first question the reader of any book asks is, "Does it fit me and will the information satisfy my needs?"

In answer, let's see what information is contained in this book.

## **WHAT this guide is about**

### **Creating self-learning materials**

This guide describes the concepts, principles, and processes used in constructing self-study training materials. However, before we go on, let's look at the word "create" in the title, *A guide to creating self-learning materials*.

When designing quality self-study materials, it will be necessary to create nonverbal visuals as well as verbal communication. They will be valuable tools to assist learning. You can learn how to create these new learning packages, but it will require practice, patience, perseverance, and commitment.

## **WHO this guide is for - the intended users**

### **Those who want to design self-study materials**

Although you can use this guide by yourself, it is most effective during a workshop which allows practice, dialogue, and immediate feedback.

This guide is written for adults who have

- a BA or BS in a scientific or technical field,
- some teaching experience,
- training responsibility,
- little or no experience in instructional design and development, and
- a need and desire to develop self-instructional materials.

The guide assumes that you have had little exposure to the concepts and vocabulary of educational technology or psychology, but that you want to discover how people learn.

It will provide technology to help you conduct training by packaging and transferring information.

## **WHY this guide - a case history**

### **A learning option**

### **A training program**

The International Rice Research Institute (IRRI) has more than 20 years experience in teaching people from developing nations about rice science.

One type of short-term training, from 2 weeks to 5 months, is called nondegree training. These courses about advances in rice technology update professionals from various nations.



The exercises that follow are practical, problem-solving, and field-oriented. The information is given through lectures; the medium of instruction is English.

### **An adjunct approach**

The nondegree training courses faced certain problems. Because the courses were short and intense and the trainees had different levels of English skills, they needed a supplementary method of learning. In 1976, IRRRI piloted the slide/ tape self-study option.

The system

- organized and sequenced the information,
- documented the lecture material in a written *and* pictorial format,
- enhanced oral and written English proficiency simultaneously,
- made information available at any time,
- packaged information so that instructors could transfer and use it in other training programs, and
- allowed the information to be readily translated into other languages.

Instructors used this important tool to train people from many countries. Its success was evident in the trainees' use of the programs at IRRRI and the demand for training modules in other nations.

### **An increase in technology**

Technology continues to increase and become more complex. As a result, it has become necessary to increase the number of training courses and programs. With this development comes the need

- for more self-study systems so that students can learn independently, and
- to adapt these learning packages so they can communicate with technology users in the different regions of the world.

If you think that this guide meets your needs so far, read on.

If you're not sure, read the introductory sections on content, objectives, and style.

If you don't think it meets your needs, please pass it on to a colleague who you think might be interested.

### **Training in self-learning methodology**

To meet these demands, IRRRI is expanding its instructional programs and training staff to produce self-learning messages.

Hundreds of conversations with trainers in developing nations show they need new training approaches and materials for adults. This handbook will help you develop autotutorial methods that introduce new training approaches.

## **ACKNOWLEDGMENT**

The International Rice Research Institute wishes to thank the IRRI staff, the committee on nondegree education, academic council members, and educators throughout the world for their constructive comments and assistance in fashioning this publication.

Special acknowledgments are extended to Dr. Katherine Steele, Dr. Jeannine Webb, and Dr. M. M. Murphey of the University of Florida who encouraged the author in the pursuit of innovative instructional techniques contained in this book.

This manual is dedicated to you, if you find it useful; to the national staff of the Training and Technology Transfer Department; but especially to Dr. Robert N. Hurst of Purdue University who introduced the self-study concept at IRRI.

# INTRODUCTION

## **New challenges and trends**

Whether we like it or not, the world is rapidly advancing into a new era. This time in human history has been called the information revolution. It is a time of expanding population and communication. Information presently doubles within 7 to 10 years, and that time is decreasing.

This information explosion presents new challenges to those responsible for sharing information.

- To keep up, we must transfer more information to more people in less time.
- With advances in agricultural science and industry, information has become more technical and complex.
- To be useful in a world community, we must share information with cultures of different languages.
- To solve complex problems, we must find methods to increase communication between people of different disciplines.
- To prepare people for responsible positions in a technological society, we must transfer complex information to a younger population.
- At the same time, older adults must learn the new techniques so that they can keep up with technological developments.

Therefore, we must find new methods to share information.

One solution to information diffusion has two parts:

1. *Teach people to find information and teach themselves.*
2. *Prepare materials that will encourage people to teach themselves.*

This educational technology requires information preparation, packaging, and referral. These are the focus of this guide.

## **Parts of a self-study program**

### **Objectives**

### **Content**

### **Feedback**

Educational research shows that effective self-study material should include

- the standard of performance expected from the learners,
- information to be learned, and
- exercises that allow learners to evaluate their performance.

Therefore, this guide will teach you how to write

- learning objectives,
- a self-study program, and
- self-evaluation exercises.

The end product will be a self-learning package made up of these three parts.

However, in transferring technology, we often forget an important point. We need to explain why the technology has been successful and why people should adopt it. This explanation is important because scientific investigation convinces and motivates both trainers and trainees.

Therefore the guide also will

- explain the evolution of the scientific research that has led to this modern self-study instructional methodology, and
- introduce new vocabulary and concepts.

## **The content**

### **Part I - Why**

Two parts make up this book. Part I discusses some relevant theories and concepts related to autotutorial instruction as a learning method.

- Chapter 1 introduces the basics of communication. It presents a communication model that helps to explain what happens during information transfer.
- Chapter 2 contains a brief history of the learning theory, the evolution, and design of this methodology.
- Chapter 3 continues with a more detailed discussion of adult education.
- Chapter 4 highlights both the old concepts and the theory of whole brain learning.
- Chapter 5 explains the various learning styles.

### **Part II - How**

Part II is the task-oriented part.

- Chapters 6 to 11 explain how to create autotutorial packages.
- Chapter 12 discusses how autotutorial programs are to be managed.

## **Style: a different approach**

This guide differs from most manuals in several ways:

1. It has two distinct but related sections. One will tell you **why** we use the self-study option, the other will show **how** to design self-study materials. You can alternate between sections or use whatever sequence you like.
2. We designed the guide for self-study. Each chapter will contain objectives, topics to learn, and self-evaluation exercises so that you can measure what you learned. Read the objectives before and after you study the program.

3. Main points are accentuated and enclosed in frames or boxes.
4. The lessons also contain drawings and written information for you to read in sequence.
5. Lessons are written in a conversational tone.

**If you want to begin by understanding the theory behind the creation of self-learning materials, how this methodology works and came to be, advance to Part I and read Chapters 1 to 5.**

**If you're not interested in theory and want to begin creating self-study materials, turn to Part II and read Chapters 6 through 12.**

**If you like to approach things in sequence, read Chapters 1 to 12.**

**If you're now sure you're not interested in any option, please give this publication to someone who might be. There's nothing as useless as an unused book.**

# PART I - A/I OR SELF-LEARNING INSTRUCTION AS A LEARNING METHOD: SOME RELEVANT THEORIES AND CONCEPTS

## CHAPTER 1. The Communication Process

### *Objectives*

The information in this chapter is not essential for you to create objectives and a self-study module, or write self-evaluation exercises. Nevertheless, it will help you attain the following objectives:

- Discuss the 5 parts of the communication model.
- List 2 primary methods of human communication.
- Relate 6 avenues of visual communication.
- Describe 2 channels used in verbal communication.

**Remember each chapter has a self-study format with objectives, content, and self-evaluation exercises.**

Objectives are the main points to learn. You may want to refer to them again after reading the chapter.

If you can now perform the objectives or want to create a module, go to page 100. Do you think you can answer the questions, but you're not sure? If so, turn to page 20 for a self-evaluation on the 4 objectives of this chapter.

Are you curious about the objectives? Do you want to learn more? Read on. Content comes next.

### *Berlo's Model*

Let's first discuss a basic communication model called Berlo's Model. In doing so, let's use pictures. Pictures are important in the communication process because they help us visualize verbal concepts. As we talk about ideas, we often automatically fashion pictures in our minds relating the words to past visual experiences.

Pictures are important for storing and recalling information. So whenever possible, try to communicate visually as well as verbally. By doing this, you assist people to understand concepts. For instance, let's divide our communication model in 7 parts, corresponding to 7 steps.

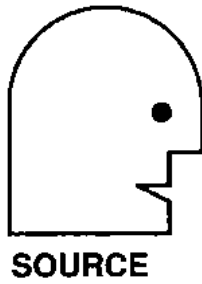

## SOURCE

Part 1 is called the communication **SOURCE**.

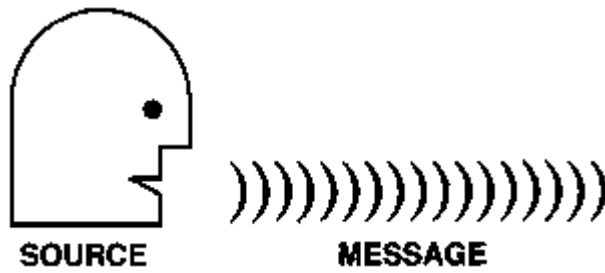

## MESSAGE

Part 2 The source sends a **MESSAGE**.

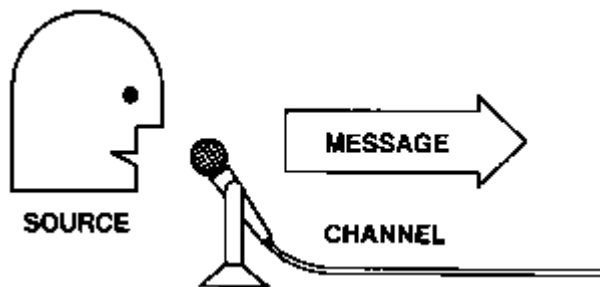

## CHANNEL

Part 3

The source sends a message by some **CHANNEL** or communication method, such as a microphone.

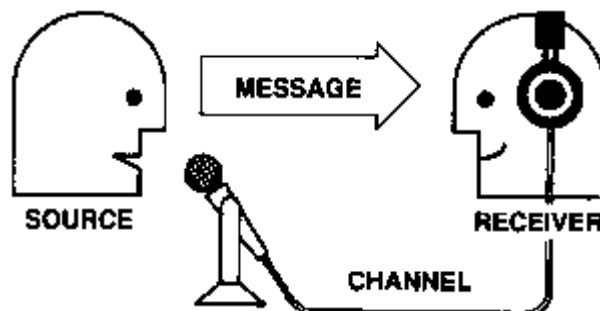

## RECEIVER

Part 4

The source sends a message by this channel to a **RECEIVER**.

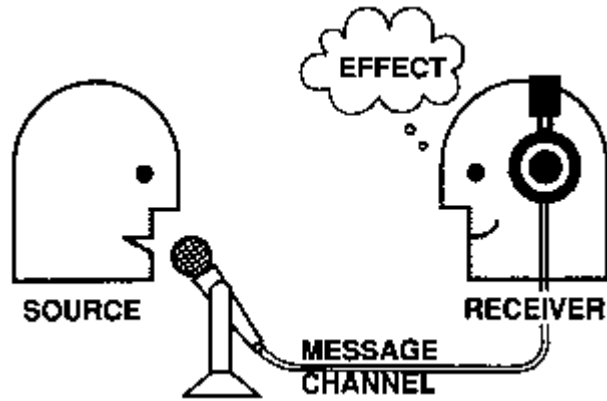

## EFFECT

### Part 5

The source sends the message by some channel to the receiver to produce some **EFFECT** or change in behavior.

Now let's put these components together and diagram our model.

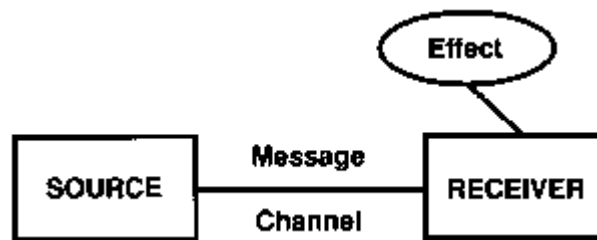

For example, this guide is a **source** to convey a **message** about self-learning methods through a print/picture **channel** to you, the **receiver**, to produce a change or **effect** in your behavior.

Although Berlo, a communication expert, did not develop all parts of the model, people refer to it as *Berlo's Model*.



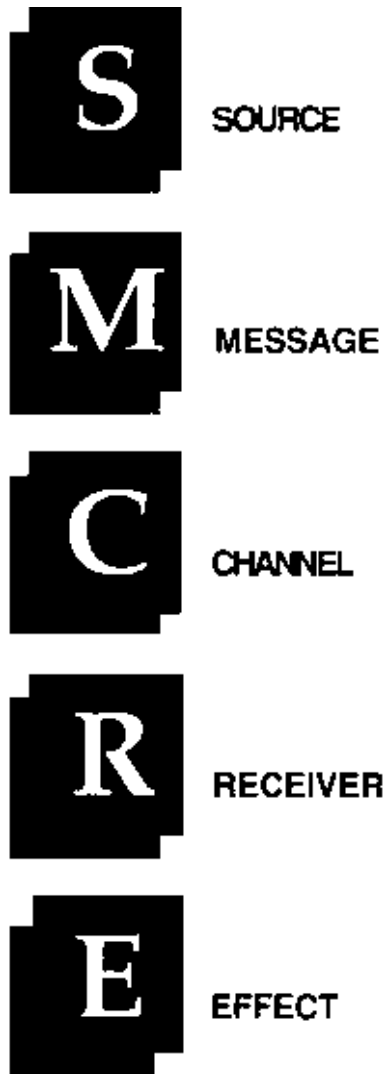

Many communication professionals also refer to the process as SMCRE which stands for source, message, channel, receiver, and effect.

However, when using this acronym, there's one more extremely important step in the communication process that's left out. In fact, effective dialogue and group communication is impossible without FEEDBACK.

For this reason, let's add another important step to our model.

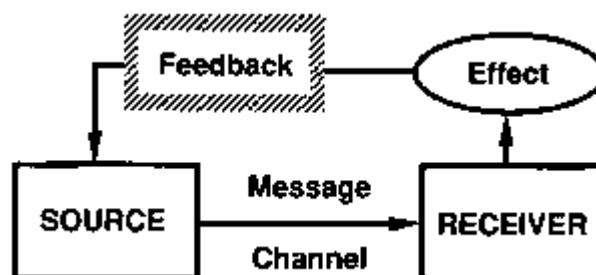

## FEEDBACK

### Part 6

**FEEDBACK** is an important product of the communication process.

Feedback from student questionnaires and tests is an important part of designing self-study instruction. Feedback tells you (the source) how effective the selected message and channel are upon the receiver. It allows you to adjust the communication process so that it is more effective. Let's add another step to the model.

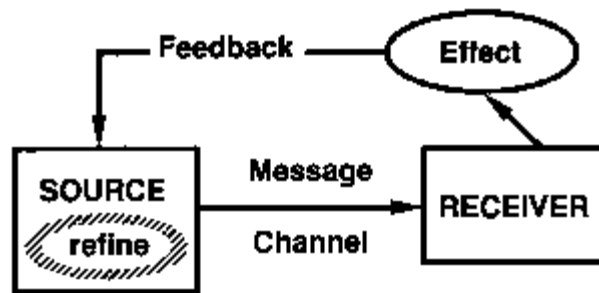

### REFINED MESSAGE

Part 7

**REFINE** the message.

Conversation or dialogue is stimulating communication because the model constantly rotates between two people. It is an active participation process.

One challenge you face when designing self-study instruction is to build in active student participation and feedback.



### *Communication modes*

Humans have two primary modes or means of communication, **nonverbal** and **verbal**.



## Nonverbal

Nonverbal pictures are a very powerful tool in the communication and learning process. Even verbal communication depends on the arrangement of the conceptional building blocks of letters... words ... sentences.

The sense of vision, the major nonverbal communication vehicle in humans, is responsible for more than 80% of learning. Nonverbal communication is powerful.

Some of the more important nonverbal visual channels used to communicate are the following:

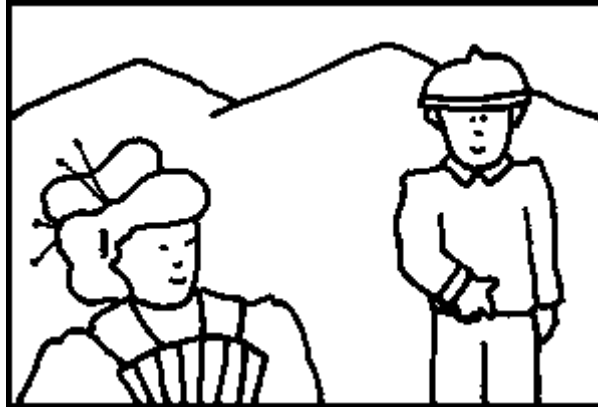

### DISTANCE

- **Distance**, particularly human distance or our proximity to one another, has culture-bound meanings.

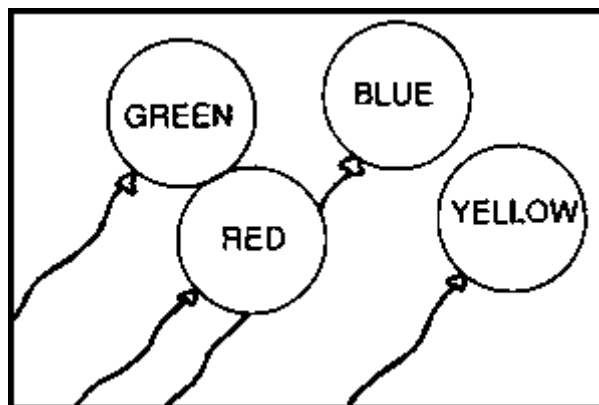

### COLORS

- **Colors** evoke certain responses and emotions depending on the culture:

white >>> cool, red >>> hot, blue >>> sad.

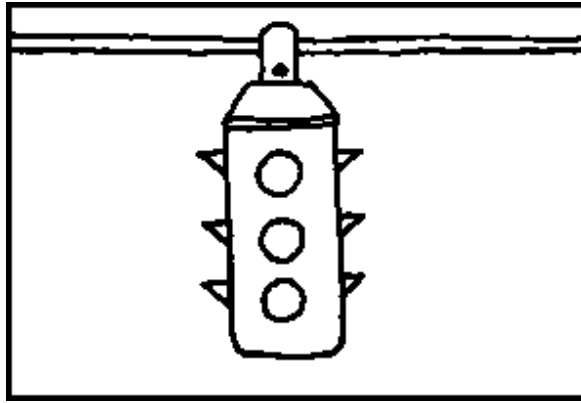

## LIGHTS

- **Lights** are used as signal devices, guides, warnings, and announcements.



## PICTURES

- **Pictures** include art, logos, and other designs used to communicate messages. “A picture is worth a thousand words.”

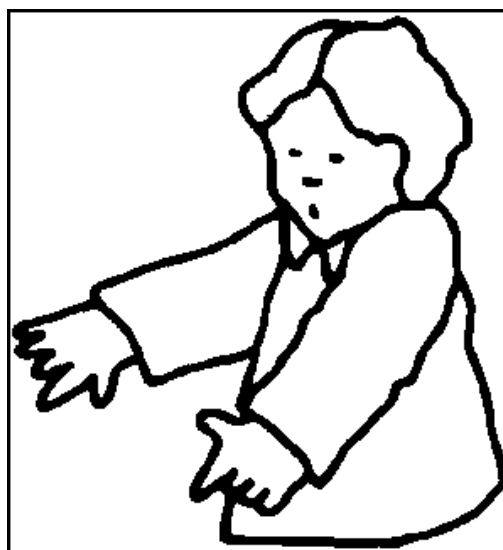

## GESTURES

- **Gestures** are an important part of oral communication.



## DRESS

- **Dress** (uniforms, jeans, native costumes, heels, necklaces, rings, ties, hair, and other attires and accessories) communicates a message.

Other nonverbal senses such as smell, touch, and taste contribute to communication especially in lower animals. But the sense of vision is especially important in nonverbal communication of humans and higher animals.

## Verbal

And then, somewhere in time, came words, meanings, and languages. It's estimated that there are more than 70,000 different languages and dialects in the world. However, all communicate verbally in just two methods.



## ORAL MESSAGE

**Method 1.** A source sends a message to the receiver by speaking; it is received by listening.

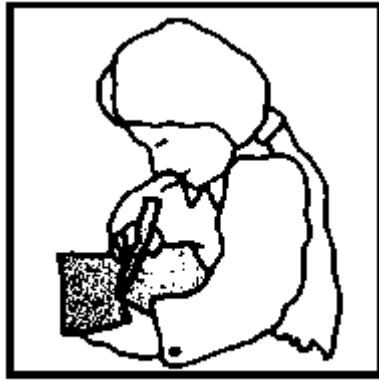

**WRITE**

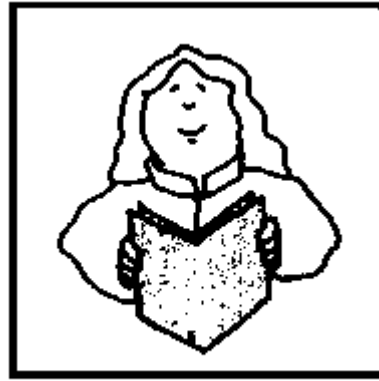

**READ**

**WRITTEN MESSAGE**

**Method 2.** A source sends a message to the receiver by writing; it is received by reading.

*A Summary*

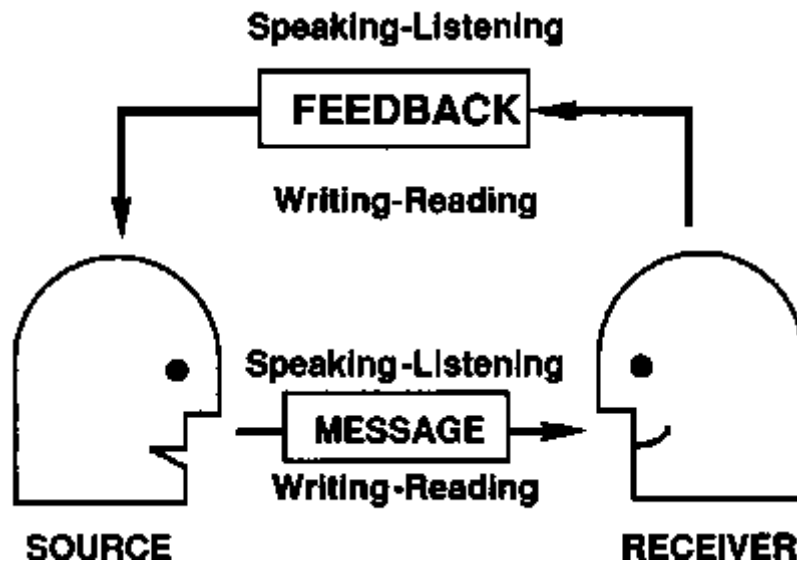

Of course, feedback in our communication model may also have two methods of verbal communication.

Speaking of feedback, it's time for a feedback exercise. This manual has been the **source** in a communication process. The **message** has been about the communication model. We have communicated to you, the **receiver**, through both verbal and nonverbal **channels** to produce an **effect**.

Did this communication process cause an effect in you? Did it cause you to learn? Only **feedback** can tell us the effect of our message.

**Feedback exercise**

Answer these questions to evaluate your learning so far.

- Diagram and label Berlo's Model.
- List the 2 primary communication channels in humans.
- List the 6 channels of nonverbal communication.
- List and discuss the 2 interactive channels of verbal communication.

*Answers to feedback exercise*

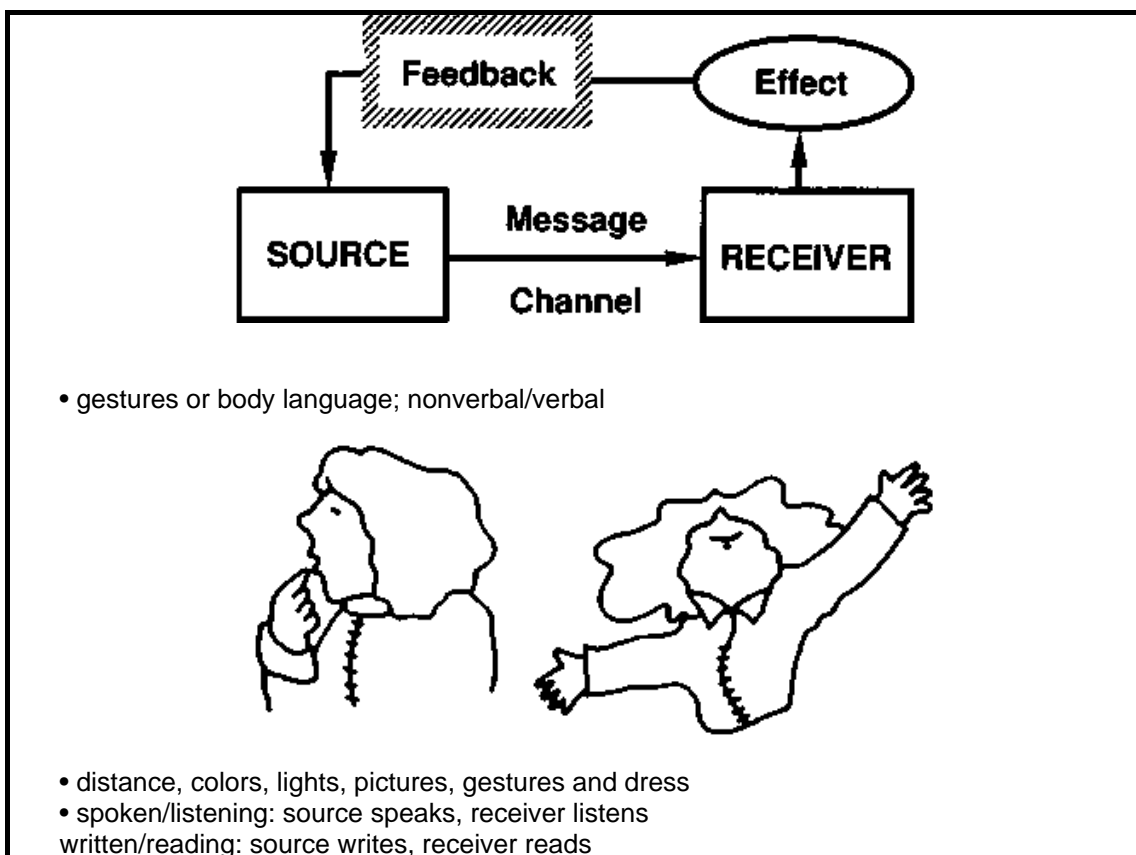

We hope that you answered all the questions correctly, because the objective of this chapter is to effectively communicate these principles to you, the receiver. If you missed a question, there was a breakdown in the model.

By design, the chapter was very short. There was little repetition of concepts and no participation until the very end. Thus, we omitted two important learning tools: **repetition of material** and **immediate feedback**.

**More on this in our next chapter, *Self-study option: how it got started, what it can do.***

### ***References and information of interest***

Berlo D K (1960) *The Process of communication*. Holt, Rinehart and Winston, New York.

Brislin R W (1981) *Cross-cultural encounters: face to face interaction*. Pergamon Press, Inc., New York.

Geschwind N (1979) Specialization of the human brain. Pages 108-117 *in* *The brain*. W. H. Freeman and Co., San Francisco.

Hall E T (1959) *The silent language*. Doubleday and Co., Garden City, New York.

Hall E T (1969) *The hidden dimension*. Doubleday and Co., Garden City, New York.

Hindhawa B S, Coffman W E (1978) *Visual learning, thinking, and communication*. Academic Press, New York.

Laborde G Z (1984) *Influencing with integrity*. Syntony Publishing, Palo Alto, California.

McQuail D, Windahl S (1981) *Communication models*. Longman, London.

Mag-uyon M (1976) *Communication for effective extension work*. Department of Development Communication, University of the Philippines at Los Baños, Laguna, Philippines.

Rogers E M (1983) *Diffusion of innovations*. The Free Press, New York.

## **CHAPTER 2. The Self-study Option: How It Got Started, What It Can Do**

How did self-study start? What kinds are there? What can they do? We'll talk about those topics in this chapter. If you're more interested in how to begin designing a self-study project, skip this and the next three chapters and start with Chapter 6.

**BUT**, you will find this chapter extremely valuable in focusing your goals and justifying your project to **YOURSELF**, **YOUR STUDENTS**, and **YOUR MORE CONVENTIONAL COLLEAGUES**.

When talking about new ideas, skeptics will repeatedly ask you for facts and reasons for changing your methods. That's why we'll talk about theory as well as process.

To be prepared for these questions, you will need facts as well as a desire to create autotutorial programs. The facts will allow you to answer questions and increase your credibility as you share new learning techniques with others.

### ***Objectives***

After you finish reading this chapter, you should be able to

- Distinguish between tutorial, audiotutorial, and autotutorial instruction.
- Discuss the development of the autotutorial approach as a teaching method.
- Relate and distinguish between autotutorial research terms and methods
  - programmed instruction



- audiotutorial instruction
- personalized instruction

- List and describe 4 principles of programmed instruction.
- List the 4 major reasons why students like self-learning instruction.
- Compare the efficiency of self-learning instruction and lectures.
- Compare the cost of autotutorials and lectures.
- List and discuss 10 advantages of learner-driven instruction.
- List and discuss 4 major drawbacks of using autotutorial instruction.
- Explain how the instructor can overcome these drawbacks of autotutorial instruction.
- Explain the teacher's new role when using the self-learning approach.
- Define hardware, software, and courseware.
- Describe how students compare autotutorial and lecture methods.

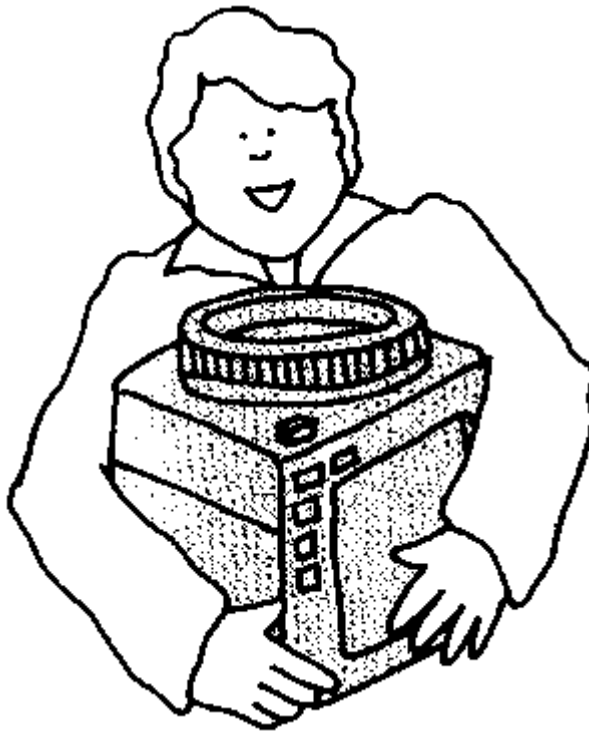

**You can see there's a wealth of information in this chapter. We have condensed it to give you an overview and insight but save time. Refer to the list of references at the end of this chapter if you want more information.**

***Tutorial, audiotutorial, autotutorial***

What's the difference between these three kinds of instruction?



**Tutorial** instruction generally means one-to-one teaching with a private teacher.

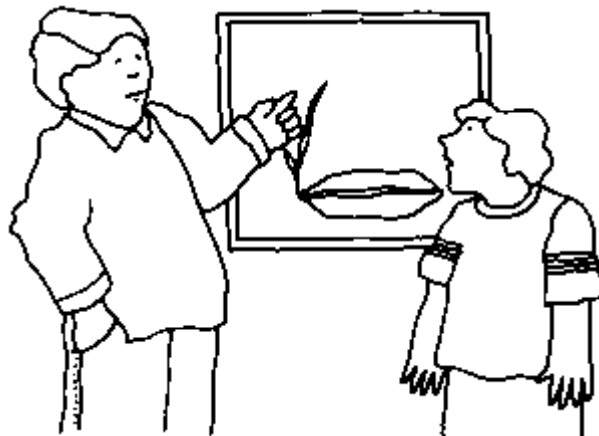

**Audiotutorial (A-T)** literally refers to using sound, usually a tape recording, as a private teacher. However, you will soon see that A-T can use much more than sound.

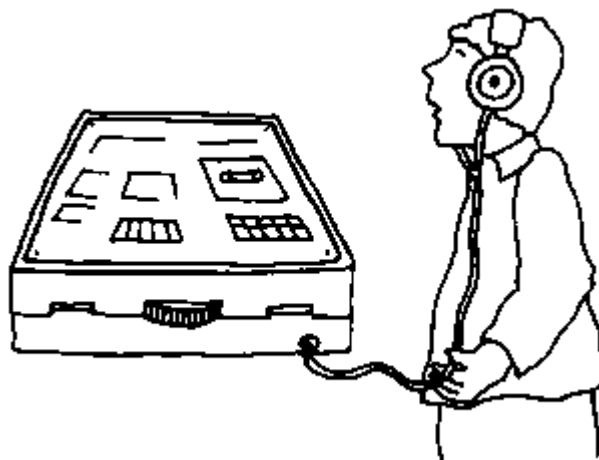

**Autotutorial** means learning materials that allow students to teach themselves. They may include any medium such as print, sound, pictures, slides, or television.

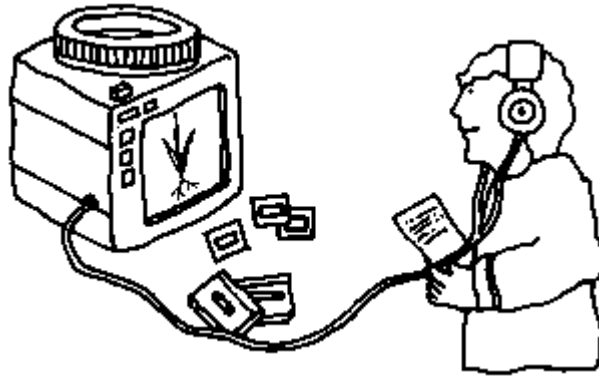

*How autotutorial learning developed*

### **STIMULUS/RESPONSE (S-R)**

Much early research on learning involved the behavior of an organism, usually a small animal, in response to some stimulus such as food, shock, or light. Theories from this research were known as **stimulus/response**, abbreviated as **S-R**.

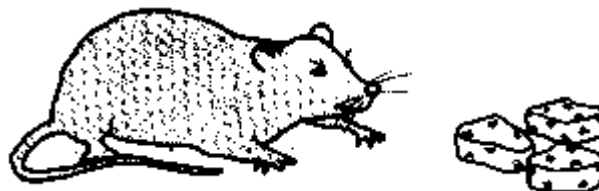

### **OPERANT RESPONSE (OR)**

In the late 1930s, B. F. Skinner, a psychologist at Harvard University, started investigations to learn what animals (rats and pigeons) would **do** to receive a reward. Because some experiments required the animal to operate a bar, disk, lever, or similar apparatus, it became known as the **operant (conditioning) response** or **OR** theory.

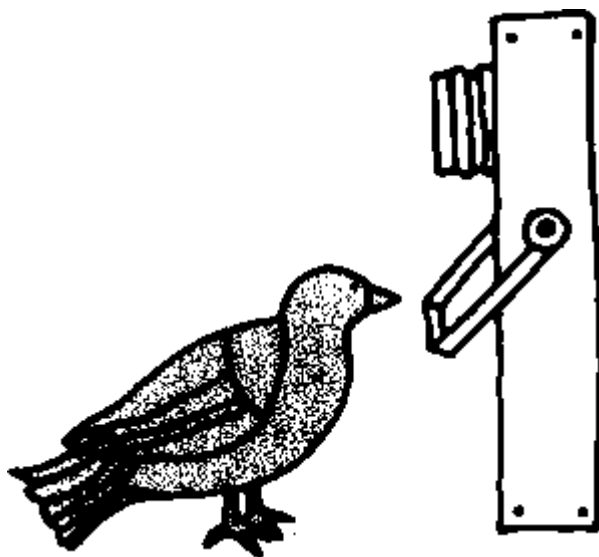

Those who advocated these theories were referred to as the *behaviorist* school in psychology, because they were interested in **external behavior** or **responses**. Although tutorial or individual instruction had always been prevalent as a learning method, this new behavior research helped develop new learning principles applicable to tutorial and especially autotutorial instruction.

The research showed that through a stimulus (reward), an animal could learn a behavioral program. It was possible to teach pigeons to hop up and down twice, turn around three times, and flap their wings before they received their reward.

### **PROGRAMMED INSTRUCTION (PI)**

The learning principles from these experiments eventually became known as **programmed instruction, PI**. Skinner characterized PI as having

- small steps or units of content to be learned,
- active student involvement,
- immediate feedback,
- positive reinforcement, and
- self-pacing.

Elementary schools in the United States began using this personalized PI concept in the early 1950s, and it gained wide acceptance.

### **AUDIOTUTORIAL (A-T)**

In 1961, PI graduated from the elementary schools and went to college. Dr. S. N. Postlethwait used the PI principles in an **audiotutorial** mode (**A-T**) to supplement a beginning botany course at Purdue University. He centered personalized learning in a self-study desk or carrel. The materials consisted of

- learning objectives,
- a programmed audio tape,
- printed study guides,
- visual aids,
- actual biological specimens, and
- a tutor for personalized instruction.

The method quickly gained international recognition. Today, a formal definition of A-T includes all of these elements.

### **PERSONALIZED SYSTEM OF INSTRUCTION (PSI)**

Also in the 1960s, Dr. F.S. Keller, a psychologist at the University of Brazilia in Brazil, developed a similar approach to teaching science courses. He referred to his autotutorial packages as a personalized system of instruction or **PSI**.

PSI, or the Keller packages, contain

- primarily written instructional material,
- self-paced lessons,
- explicit objectives, and
- feedback evaluation.

The Massachusetts Institute of Technology (MIT) in the U.S. used PSI successfully in a beginning physics course, and the method gained international recognition in science instruction.

*A module*

Do you remember the parts of our autotutorial package in the Preface and Chapter 1? They came from this list. The standard for a module consists of these 9 parts advocated by the CUEBS.

Since then, the modular or programmed autotutorial instructional approach has gained recognition as a viable option in the instructional process.

As a result, a group of distinguished educators, the Commission on Undergraduate Education in the Biological Sciences (CUEBS), published guidelines for modular instruction. They include

- a statement of purpose,
- entry or prerequisite skills,
- instructional objectives,
- a pretest,
- implements (equipment, supplies),
- the program (printed A-T),
- related or repetitive experiences,
- a post-test, and
- assessment by student peers.

### **Summary**

**Two models of successful programmed instruction at the college level are Postlethwait's A-T and Keller's PSI.**

**An educational commission of the Biological Sciences has advocated 9 guidelines for modular instruction. Can you name them? If not, look again.**

### **Questions about self-learning instruction**

There are three major questions you'll want to answer about self-learning or autotutorial instruction:

1. How effective is the autotutorial method as compared with the lecture?
2. How much does it cost?
3. What are its advantages and disadvantages?

*How well does it teach?*

#### **Effectiveness**

#### **Cost**

#### **Advantages/Disadvantages**

One of the most favorable aspects of self-learning instruction is student acceptance. Student questionnaires show that they overwhelmingly prefer autotutorial instruction to lectures as a means of inputting information. Some studies show acceptance as high as 97% in favor of self-learning instruction. Students say they like it because of

- a feeling of self-sufficiency in learning,
- self-pacing and freedom from rigid time constraints,
- active participation in the learning process, and
- better organization of material.



In western cultures, 15% of students will be extremely positive, 15% will be extremely negative; but 85% prefer this method to lectures. Those with negative feelings say that autotutorial instruction is extremely inhuman.

Student performance on written content exams confirms that autotutorial instruction is equal to, and in most cases superior to, the lecture method. There are indications that autotutorial methods may be vastly superior to lectures in long-term recall of content. We need more research in this area.

### **Summary**

**Most students prefer autotutorial instruction to lectures. Those who don't, feel very strongly about their objections. Autotutorial instruction is equal to, and in most cases superior to, the lecture.**

*How much does it cost?*

Cost depends on the medium you use. If you use a print/picture format, it can be relatively cheap. Graphics or pictures can consist of rough but informative sketches on inexpensive paper stock. You can print the autotutorial message by hand. You do not even need a typewriter, only a pencil, paper, and creativity.

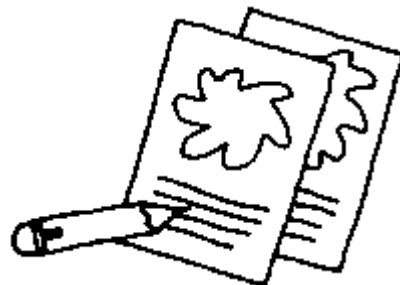

However, if you want to use computer-aided instruction (CAI), the machine alone will cost hundreds of dollars.

Let's pause here for more explanation.

**Hardware, software.** Much self-learning instruction is created to be used on teaching machines. The machines are slide/tape devices that show a slide and play a tape at the same time. They look like a small TV screen. Many are capable of automatic slide-tape synchronization.

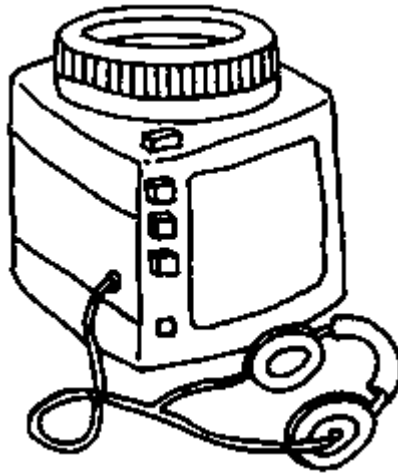

There are other programs which need only a tape recorder. The most recent autotutorial approach uses the computer where verbal and graphic messages appear on a TV screen.

The machines or equipment to run these programs are called **hardware**. The programs that run on these machines are called **software**.

Even though some software programs have very attractive presentations, it's important to remember that you can create effective programs without using expensive hardware and software.

**A-T costs.** However, cost evaluation of slide/ tape lessons show the autotutorial method to be economical as compared with conventional instruction. Initial costs are extremely high and the break-even point is about three years.

The initial investment is mostly in human resources to document, organize, and implement the programs for graphics, photography, and audio personnel. Hardware and space are another major investment. If you can purchase instructional software directly, it is even more economical. Then you eliminate expensive development costs.

Major publication companies are increasing their range of slide/tape, video, and computer programs for sale.

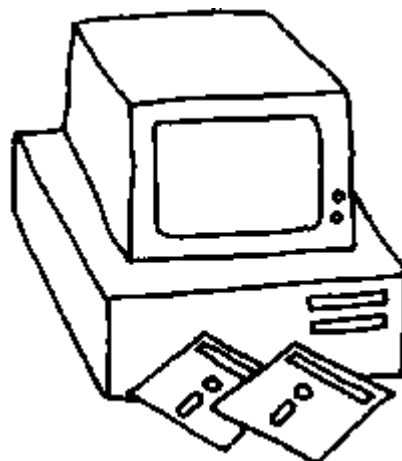

Most university autotutorial designs and products deal with science and technology.

As you look for educational technology aids, remember that many educators refer to instructional materials as **courseware**. They often call autotutorial materials or software a courseware package.

*What are the advantages and disadvantages of the autotutorial?*

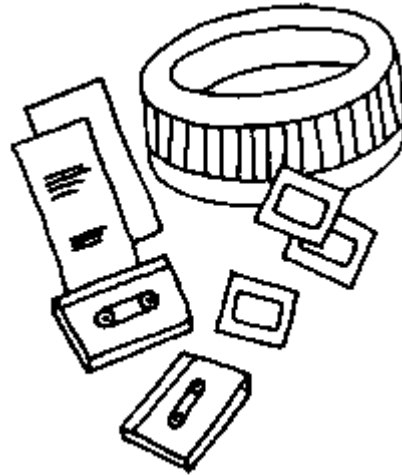

Its *advantages* are

- Students are **active** rather than passive in the learning process.
- Students control the **pace** of learning.
- Students control the **time** and **interval** of learning. The program is available when students want it.
- Content is tightly **organized**.
- Students are **responsible** for their own learning.
- **Repetition** of content material is possible.
- Students can **skip** familiar information and concepts.
- The frame format of documenting material content and sequence facilitates **peer review**.
- Module documentation can be treated as **creative works** and scholarly publications by the academe, much as chapters in a book.
- Materials are **exportable** for use at home and for sharing with other institutions.
- Students can **explore** materials on their own, because they are self-learning and independent of a teacher.

Its *disadvantages* are

- Some students feel **isolated**.
- Students with extreme negative feelings say autotutorial instruction (especially machine taught) is **inhuman**.



- Autotutorial methods make it more difficult to **emotionally motivate** students.
- It is harder to show **attitudes** about content.
- **Immediate feedback** or question periods may not be available.

However, a new active role by the instructor can overcome these drawbacks.

### ***The new role of the teacher***

**Manager**  
**Designer**  
**Facilitator**  
**Counselor**

In the old lecture role, the lecturer/teacher is a broadcaster of information, sometimes a performer or entertainer.

The role of a teacher using self-learning instruction is entirely new. It is that of a **manager** and **facilitator**. The teacher acts as a resource person, a humanistic tutor that diagnoses, prescribes, and motivates an individual or small group. Students still need the teacher, but the teacher's role is different.

The instructor's first task in this new role is to create or design autotutorial instructional software or materials for the student.



The second part is the shifting of roles from that of a teacher to that of a tutor. By moving the primary teaching of *content* information to the software package, the teacher can now concentrate on the new dimensions of student *attitudes* and *problem-solving*.

Teachers can now direct creativity into designing and guiding instruction in a humanistic, individual manner, by being an education or learning counselor.

### ***Autotutorial Instruction (A/I): our working definition***

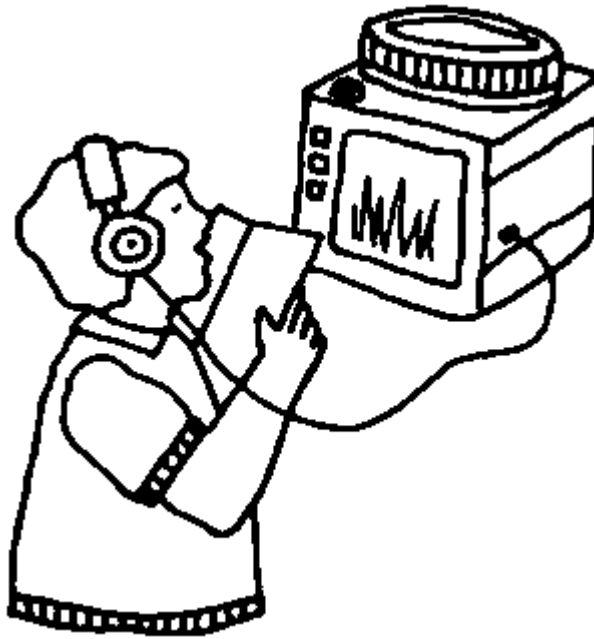

After looking at the research history, concepts, and principles of autotutorial instruction, it's time to formulate a working definition.

For our purposes it will involve 8 concepts:

1. It will be self-study.
2. It will be a module in that it will have
  - performance objectives,
  - a self-learning program, and
  - feedback or self-evaluation exercises.
3. The feedback exercises will be related to the objectives.
4. The self-learning program will consist of small learning steps or frames.
5. The steps will contain visuals, such as graphics, pictures, or specimens.
6. The script will be in print and on tape.
7. It will be self-paced for individual instruction.
8. The instructor will be an information counselor.

### **A/I**

We will call the courseware Autotutorial Instruction as it will prevent confusion with the A-T acronym.

In the next chapter, we will get to know a new learning philosophy that is changing training methods. In fact, it is one of the reasons for this guide, because self-learning materials are essential in implementing the training methods that are part of this new learning philosophy.

The following feedback exercise will help you review this material. You may also want to review certain parts of this information periodically as you create your A/I program. Perhaps, you can list those pages for future referral.

**Feedback exercise**

- Define autotutorial.

- The Behaviorist School first developed:  
(Check one).

A-T  
 A/I  
 PSI  
 PI

- Place the following acronyms associated with autotutorial instruction in their order of discovery (Sequence by number).

OR  
 Tutorial  
 PI  
 A-T  
 SR

- There are 4 principles associated with PI. List and define two.

1. \_\_\_\_\_  
\_\_\_\_\_  
2. \_\_\_\_\_  
\_\_\_\_\_

- What 2 A/I models are associated with university instruction? (Check two).

PI  
 PSI  
 OR  
 A-T  
 SR

- Which of the above is also called the Keller Plan?

\_\_\_\_\_

- One element of Postlethwait's audiotutorial model was use of the speaking/listening communication through the use of audio tapes.

List 5 additional components.

1. \_\_\_\_\_  
2. \_\_\_\_\_  
3. \_\_\_\_\_  
4. \_\_\_\_\_  
5. \_\_\_\_\_



- In what major component do PSI and A/I differ?

\_\_\_\_\_

\_\_\_\_\_

- Most autotutorial instruction is received favorably by students. What are some of their reasons? (Give four).

\_\_\_\_\_

\_\_\_\_\_

\_\_\_\_\_

\_\_\_\_\_

- Most objective comparisons of the lecture and autotutorial methods revealed which to be vastly superior? (Check one).

Neither one vastly superior

A-T

Lecture

Almost similar

- Is A/I cost effective? (Check one).

YES  NO

- How long does it take to break- even in an A/I investment? (Check one).

one year

two years

three years

four years

five years

- List 5 advantages and 2 disadvantages of A/I (Answer briefly).

Advantages

1. \_\_\_\_\_
2. \_\_\_\_\_
3. \_\_\_\_\_
4. \_\_\_\_\_
5. \_\_\_\_\_

Disadvantages

1. \_\_\_\_\_
2. \_\_\_\_\_

- Describe, in your own words, the role of an A/I teacher.

\_\_\_\_\_  
\_\_\_\_\_  
\_\_\_\_\_  
\_\_\_\_\_

- Identify which of the following are hardware and which are software. (Write H for hardware and S for software.)

- \_\_\_\_\_ paper
- \_\_\_\_\_ slide
- \_\_\_\_\_ computer
- \_\_\_\_\_ video cassette
- \_\_\_\_\_ computer disk
- \_\_\_\_\_ projector
- \_\_\_\_\_ videotape recorder
- \_\_\_\_\_ pencil

- The working definition of A/I advocated in this guide has 8 concepts. Fill in the missing concepts in the list.

1. self-instruction
2. \_\_\_\_\_
3. feedback exercises in pace with performance objectives
4. \_\_\_\_\_
5. nonverbal communication through pictures, visuals
6. verbal learning through tapes
7. \_\_\_\_\_
8. \_\_\_\_\_

- Define performance objective.

\_\_\_\_\_  
\_\_\_\_\_

**Answers to feedback exercise**



- individual or small group instruction
- PI
- Tutorial, S-R, OR, PI, A-T
- small steps in learning  
active participation in learning  
immediate positive reinforcement in learning  
self pacing in learning
- PSI, A-T
- PSI
- 1. objectives  
2. printed study guides  
3. visual aids  
4. hands-on work with actual specimens  
5. a tutor or assistant
- PSI mostly written channel  
A-T mostly audio channel
- self-sufficiency  
self-pacing  
active participation  
organization of material
- neither - none is vastly superior; A/I as good as lecture or slightly better
- yes
- three years
- Advantages of A/I:
  - active learning process
  - pace student-controlled
  - time and interval of study student-controlled
  - information super organized
  - student responsible for learning
  - repetition of material possible
  - option of skipping familiar material
  - facilitates peer review
  - documentation a creative work
  - material exportable
  - random exploration of concepts available
- Disadvantages:
  - feelings of isolation by some students
  - to some students, machine teaching is inhuman
  - conveying attitudes difficult
  - ineffective in affective attitudinal domain
  - immediate feedback difficult
- The A/I teacher is
  - a facilitator and manager

- a humanistic empathizer and counselor in the learning process
- a tutor
- a courseware designer
- S, if programmed
- S
- H
- S, if programmed
- S, if programmed
- H
- H
- H
- - modularized with
  - performance objectives
  - autotutorial program
  - feedback exercises
- increment learning steps
- self-paced
- altered instructional role
- learning goal; or student/teacher learning contract

***References and information of interest***

Anderson C (1969) Current research on instruction. Prentice-Hall, Inc., Englewood Cliffs, New Jersey.

Bigge M L (1964) Learning theories for teachers. Harper Row, New York.

Brewer IM (1974) Recall comprehension and problem solving. J. Biol. Educ. S(2):101-112.

Commission on Undergraduate Education in the Biological Sciences, (1971) The use of module in college biology. G. Creager and D. L. Murray, eds. CUEBS, Washington, D.C.

Fincher C (1977) What research says about learning. NACTA J. 21(4):18-23.

Kemp J E (1968) Planning and producing audio visual materials. Chandler Publishing Co., Scranton, Pennsylvania.

Mager R E (1962) Preparing instructional objectives. Fearon Publishing, Belmont, California.

Matheny E L, Minnick D R, Webb J R, and Steele K L (1980) Methodology of developing an autotutorial program for teaching entomology. Bull Entom Soc Amer 26 (2): 115-116.

Minnick D R, Steele K L (1978) Autotutorial instruction in Entomology: principles of Entomology (orders). Bull Entom Soc Amer 24 (2): 161-163.

Minnick D R, Webb J (1977) Autotutorial instruction in Entomology: insect identification. Bull Entom Soc Amer 23 (3): 205-207.

### CHAPTER 3. A New Philosophy

This chapter will discuss the student/teacher roles available through a philosophy of adult-to-adult teaching called **andragogy**. It will explain how A/I and self-instruction contribute to this philosophy.

The A/I method is one way to cope with the information explosion and specialization of a technological society. We can also use it to humanize teaching and create new teacher-student relationships.

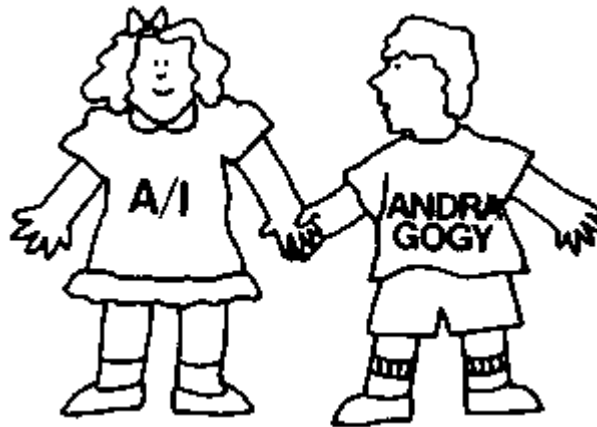

#### *Objective*

At the end of this chapter, you will be able to

- Discuss the teacher's new role relative to A/I and adult-to-adult teaching.

#### *Andragogy: adult-to-adult teaching*

#### **Changing times**

When one correlates life expectancy, culture, and technology change with time, the graph looks like this.

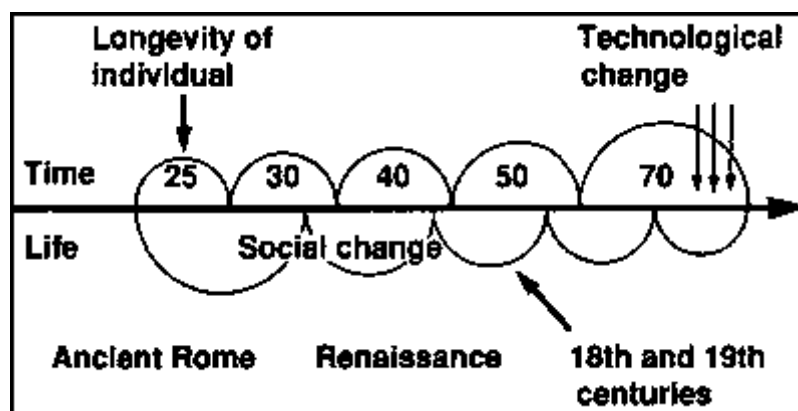

ADAPTED FROM: M. Knowles. 1972. *The Modern Practice of Adult Education: Andragogy vs. Pedagogy*. New York Assn. Press.



The graph shows that, at one time, people spent their whole lives experiencing little social or technical change. Today, however, we spend our whole lives in a social environment bombarded by technological change.

It also means that the educational tools we acquire in our professional lives may become obsolete soon after we leave school. It is therefore essential that educators find methods that allow **people to teach themselves**. And, more importantly, that educators **teach people how to teach themselves**. There are two basic steps in this process:

1. Create self-learning materials.
2. Re-allocate the responsibility of learning to the learner
  - *from* dependent
  - *to* independent.

Another word for education is **pedagogy** which means “to teach children.” It indicates an adult/ child relationship in the learning process, where the student depends on the teacher for most aspects of learning.

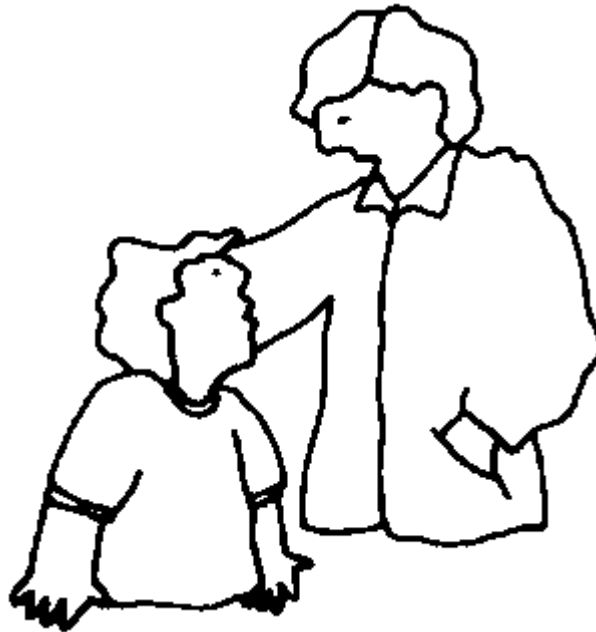

Educators are now forming a new word, **andragogy**, for a certain type of teaching. Andragogy literally means “to teach man.” It has come to mean **adult teaching**. Some of the elements in this new type of learning are

- self-instruction by the learner,
- adult-to-adult relationship between the teacher and the student,
- student selects learning materials,
- student explores learning materials,
- student auto- or self-evaluates rather than takes tests,
- student uses practical problem-solving exercises.

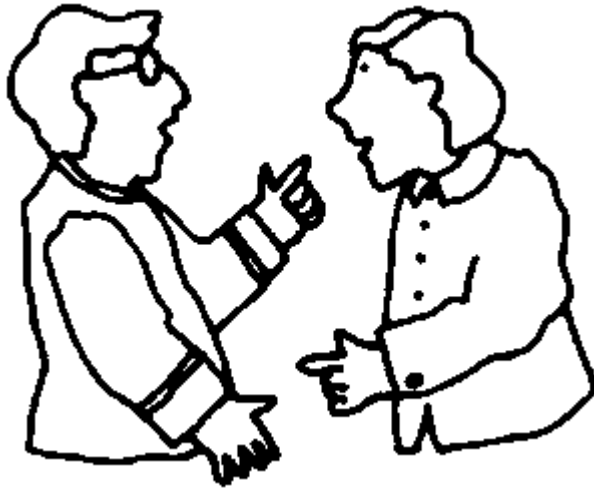

Due to academe postures, it is presently impossible to introduce many of these things at most higher educational institutions. Nevertheless, we can introduce some through A/I instruction. We talked about this change in the teacher/student role in the introductory chapters. Let's focus on it again.

The instructor becomes a

- facilitator,
- counselor,
- humanist,
- director,
- motivator,
- information specialist,
- attitude adjuster, and
- personal tutor.

This is an **important** concept in the evolution of information transfer because of the shift in

- responsibility and
- role.

**YOU ARE  
RESPONSIBLE  
FOR YOUR  
LEARNING.  
I will not spoonfeed you!**



The A/I program may teach content (cognitive information), but what about the humanistic aspects of learning in the affective (emotions) domain?

***Interline***

The teacher's new role in A/I includes the responsibility of an interline agent. That is, the instructor fills in between the lines of information in the A/I program.

**A NEW  
METHODOLOGY.**



You don't create the program and leave. You assume a new responsibility that focuses on the emotional and problem-solving areas. You are a new type of instructor involved in human/group dynamics.

### *Interline example*

You have a class of 30 people to lecture to on Monday, Wednesday, and Friday for 50 minutes. You

1. Create A/I for your course.
2. Divide the group of 30 into 3 groups of 10. Group 1 meets Monday, Group 2 meets Wednesday, Group 3 meets Friday.
3. Assign them a specific block of information modules 1-3.
4. Then they will attend class only 1 time a week but will have studied and be ready to use the information from modules 1-3 when they meet.
5. At the class, you have a group of 10 people, all of whom know common information.
6. You have 50 minutes.
7. Now it's up to you to create a problem-solving experience for them which uses and reinforces that information affectively.
8. Question, discuss, demonstrate, encourage, problem-solve, or tell stories to affect attitudes about the subject matter. Play that group like a fine-tuned instrument but make them **use** that information in some type of **active** process. Interline; fill in the lines of the content information with experiential exercises. It's a new and challenging role!

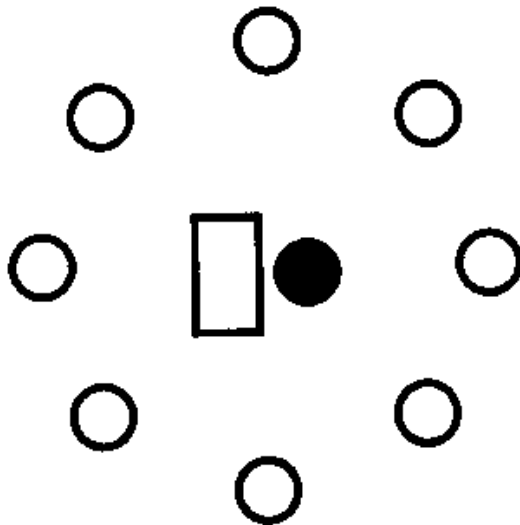

It demands that you assume a new creative role in two respects:

- You create the A/I courseware.
- You create new hands-and-heads activities that work and emphasize in a new domain—that of problem-solving. That's ultimately what learning is about—giving people information to solve personal and societal problems.

### **Feedback exercise**

- Discuss the new role of A/I and andragogy in instruction and information transfer.

### **Answers to feedback exercise**

A/I and andragogy -

- Create A/I programs to teach content.
- Shift responsibility for learning content to the student.
- Teacher becomes a
  - facilitator,
  - motivator,
  - counselor,
  - humanist,
  - director,
  - information specialist,
  - attitude adjuster, and
  - personal tutor.
- Focus instruction on problem-solving and learning attitudes about content information.

If you're not interested in learning theory or additional ways in which A/I works, go on to Chapter 6. Have fun! If you would like to delve into some of the latest concepts of educational theory and learning frontiers, read the next chapter.

### **References and information of interest**

Knowles M (1972) The modern practice of adult education: Andragogy vs. pedagogy. New York Association Press, New York.

Knowles M (1978) The adult learner: a neglected species. Gulf Pub. Co., Houston, Texas.

Knowles M et al (1984) Andragogy in action. Jossey-Bass, London.

Lowe M C (1976) Value orientations. Carrol Press, Cranston, Rhode Island.

Marshak R (1983) What's between pedagogy and andragogy. Training Dev. J. 37(10):80-81.

Pierce C, Carol J (1986) On communication among "unequals". Int. J. Intercultural Relations 7:263-283.

White G, Coscarelli W (1986) The guided design guidebook: Patterns in implementation. West Virginia University, Morgantown, West Virginia.

### **CHAPTER 4. Memory and Whole Brain Learning**

Space exploration, gene-splicing, communication information processing, and the functions of the human brain are some of today's most important frontiers.

You may need the information in this chapter to explain A/I to your colleagues or to convince some of them who are hesitant about A/I techniques.

## **Objectives**

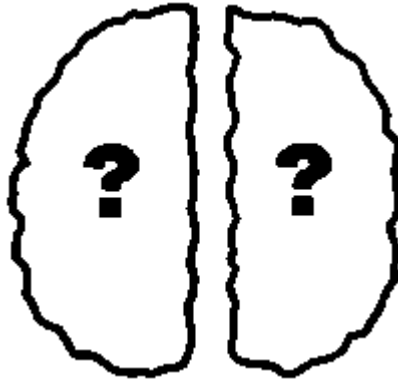

At the end of this chapter, you will be able to

- Evaluate the complexity of brain function and memory storage in learning.
- Compare the functions of the brain hemispheres in learning and behavior.
- Interpret the importance of the limbic system in learning and behavior.
- Discuss the quadrispheres' functions in whole brain learning.
- Relate the importance of the hippocampus and amygdala in retaining memory.
- Recall and describe the interrelationships of the 3 types of memory.
- List and discuss 3 additional concepts related to memory storage and recall:
  - chunking
  - subsumers
  - concept mapping

### ***The human brain: center of learning and memory***

Recently, there has been a flood of research associated with brain anatomy, organization, chemistry, memory, and learning.

There is still much that is mysterious about this 1.3-kilogram structure that makes us each unique human beings.

However, recent research has revealed more about how our brain functions as we learn.

To most people, the word “brain” involves an image of a single, wrinkled structure enclosed in a protective bony skull. Actually, the brain is not single but has two halves or hemispheres.

These hemispheres communicate with each other by several distinct bundles of nerve fibers.

**LEFT  
Hemisphere**

**RIGHT  
Hemisphere**

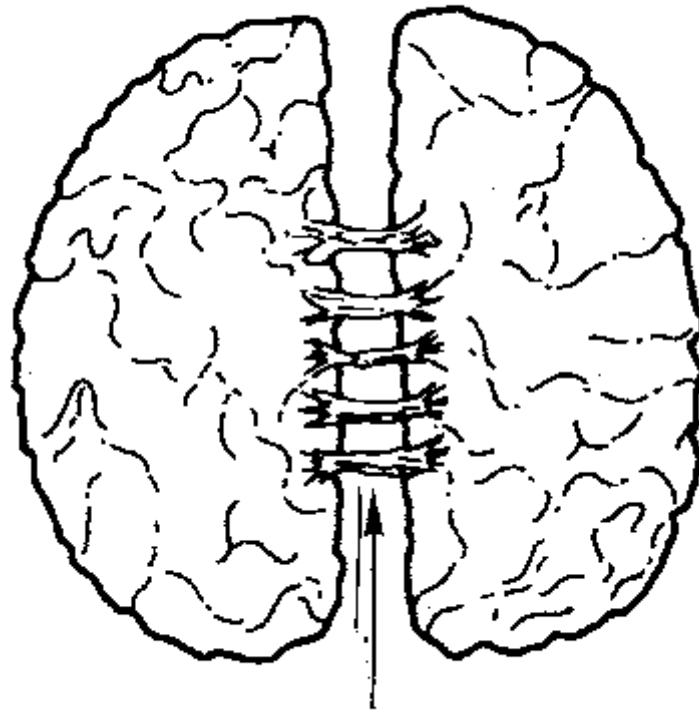

**connective nerve bundles**

### **THE BRAIN HEMISPHERES**

*The left brain*



**language  
verbal**

### **LEFT BRAIN**

In the 1930s, Wilder Penfield and his colleagues at Montreal Neurological Institute in Canada used electrical stimulation to map areas of the brain that controlled speech and language. Subsequent research has shown that the left hemisphere controls words and language.

He also pioneered research on how the brain stores memories (more on this later), although some scientists disagree with his interpretations. Other researchers found that the left brain had enlarged areas and was dominant.

*The split brain*

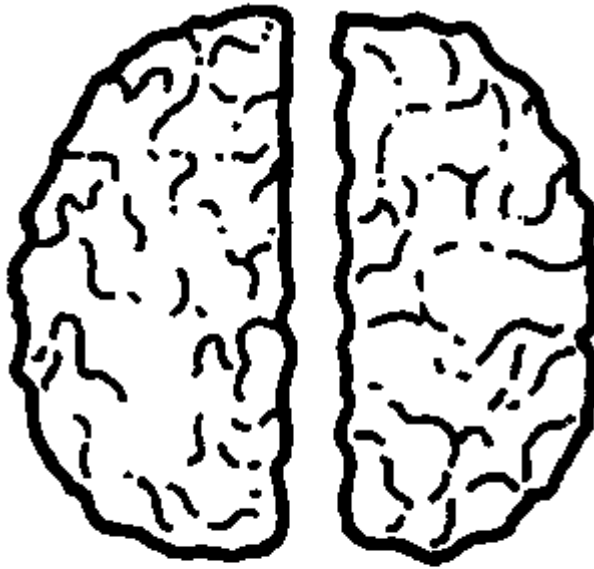

**dependent**  
**independent**

#### **SPLIT BRAIN**

In the 1940s, a New York neurosurgeon, William van Wagenen, cut the fibers between the two brain hemispheres of patients, splitting them apart in an effort to cure uncontrollable epilepsy. In some cases, it cured the epilepsy and there was little change in the everyday activity of the patients.

Later research by Rodger Sperry, Eran Zaidel, and others shows that each hemisphere functions somewhat independently. However, they work together when using learning, memory, and survival skills.

*The right brain*

**spatial**  
**nonverbal**





## **RIGHT BRAIN**

Further investigations by this group and others discovered that while the left brain processes verbal language, the right brain deals with visual and nonverbal information. That is, each hemisphere is specialized. Some researchers now say that because our technological society concentrates on verbal skills and analytical thought processes, the right brain is relatively dormant. They say we should find ways to free its dormant power for learning and problem-solving.

### *The whole brain*

As research progresses, it shows that brain function on any level is an intricate process without simple answers. However, scientists continue to study what they call whole brain teaching and learning.

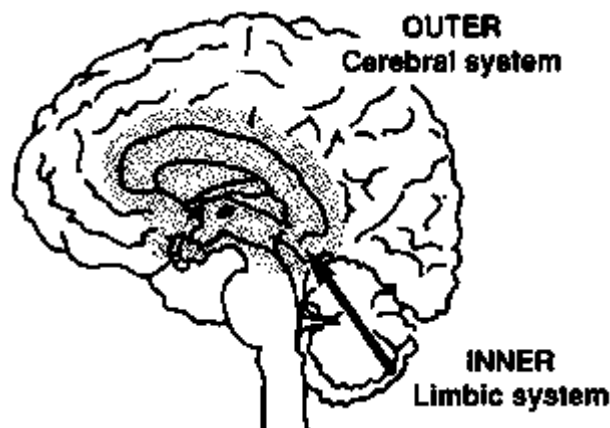

## **BRAIN, SIDE VIEW**

In this concept, the brain not only has a left and a right hemisphere but an inner and outer brain as well. Each hemisphere has an upper outer cerebral area and an inner limbic system. In each of these 4 parts, division of labor exists among the specialized areas that process and deal with different types of information. Thus, a brain profile map of areas and functions would look like this:

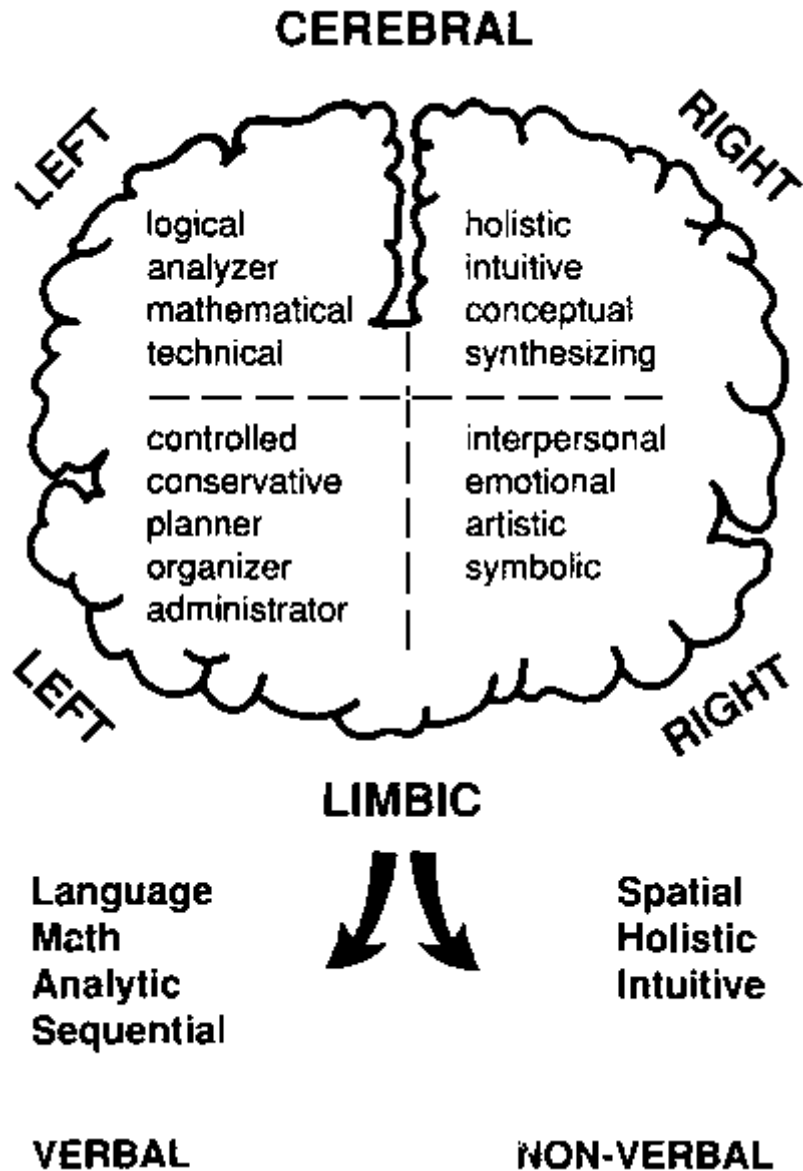

**CEREBRAL**

About now, you're probably asking what all this information has to do with creating A/I programs.

*The brain and A/I programs*

All this explains **why** slide-tape (A/I) programs are powerful tools in the learning process. The left brain processes the words on the tape and slides; the right brain interprets the pictures on the slides and associates the music and pictures on the tape, thus reinforcing learning by use of both.

Two other reasons why A/I works are memory and operant conditioning (as explained in Chapter 2).

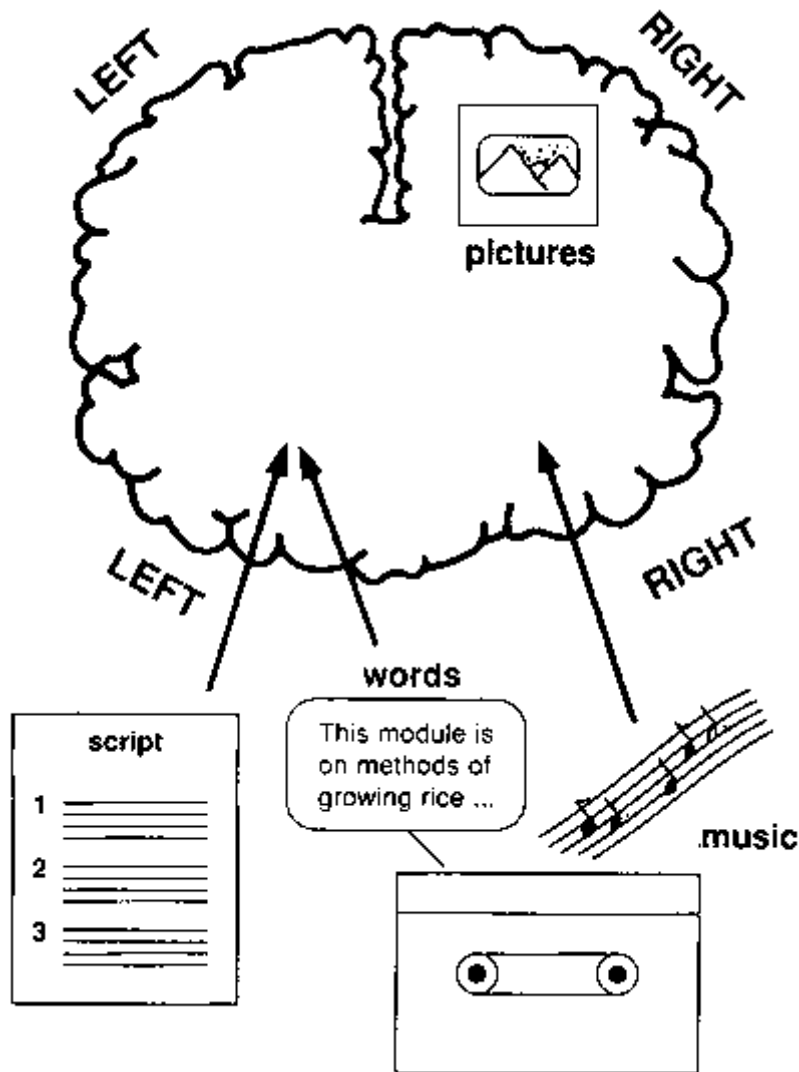

## Memory

Today's research supports the hypothesis that memory actually makes physical changes in the brain. Some scientists contend that memory storage is linked to RNA encoding. Memory research continues in three important areas which help us understand learning.

### *Where it's stored*

When Wilder Penfield, our neurosurgeon of brain mapping, applied electro-stimulation to the side or **temporal lobes** of the brain cortex, his subjects would not only remember past experiences but would "relive" them in a multisensual mode. They could smell, hear, see, or feel the things that surrounded them as if reliving the experience.

This and other research led us to discover where the memory storage centers are located in the brain, and that it is in an intricate sensory package.

Further research on memory has indicated that perhaps storage is related to pictures, and recall is dependent on a pictorial memory file (idetic recall).

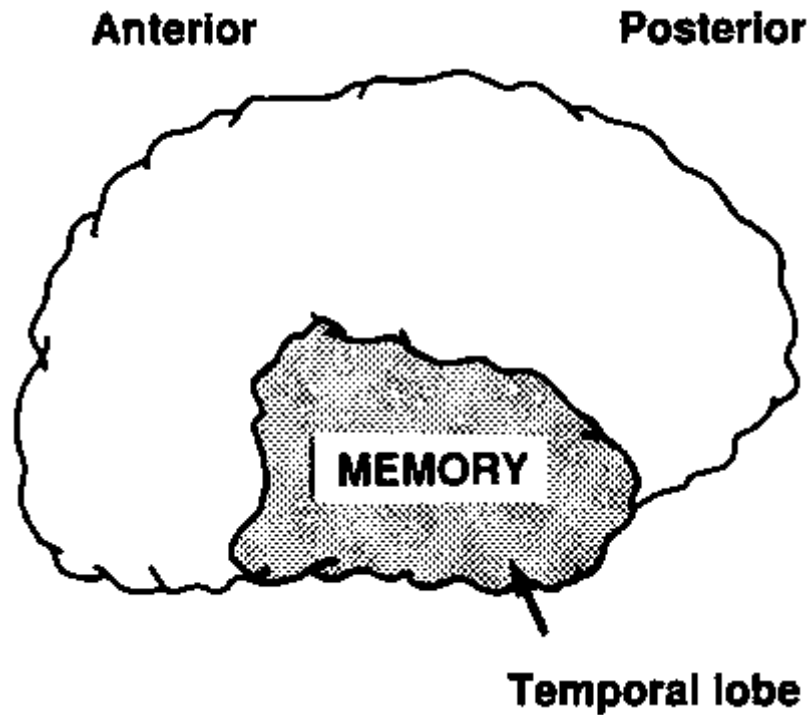

#### *Memory gatekeepers*

In 1953, neurosurgeons removed part of the limbic system (internal brain), including the **hippocampus**, from a young man, again in an attempt to cure epilepsy. This cured the disease, but he was then unable to remember or form a single lasting memory from the day of his operation.

Later research revealed that the hippocampus and another organ, the **amygdala** of the limbic system, are connected and both act as gatekeepers or central processing units for memory storage. Through some biochemical mechanism, memory passes from the sense organs through the limbic system and finally into the temporal cortex for permanent storage. The hippocampus acts as a screen for memory storage and the amygdala acts as the attitudinal screen.

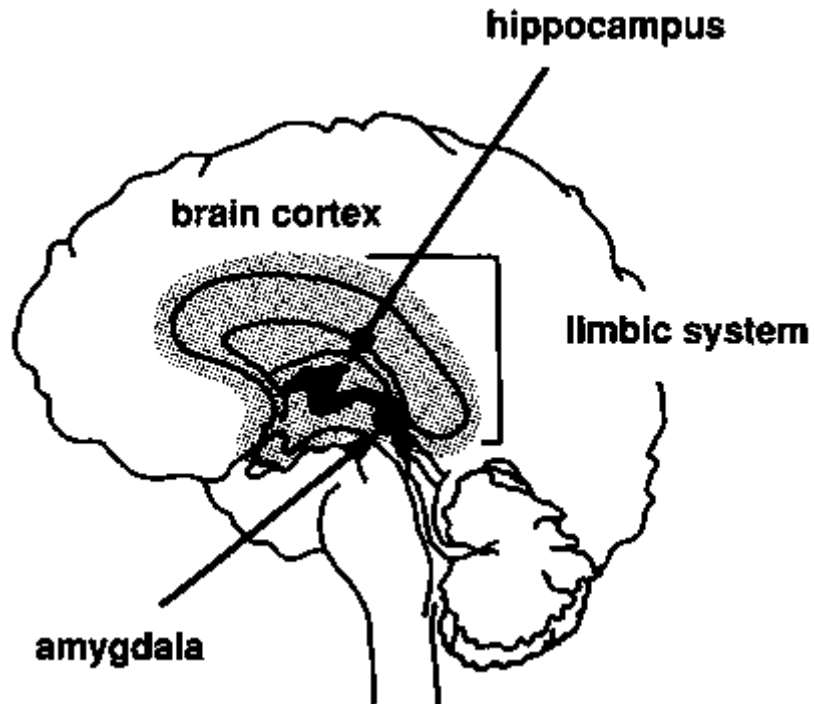

**Memory: Summary I**

The hippocampus of the limbic system, in the inner brain, is the gateway to memory storage.

The amygdala of the limbic system indexes information with emotional and attitudinal codes such as joy, grief, fear, positive, and negative.

Attitudes are important to the learning process. Depending on the subject, 30% or more of lecture time treats the attitude or emotions about the subject material. In fact, the first 3 chapters of this guide do just that - help you form attitudes about A/I slide-tape modules.

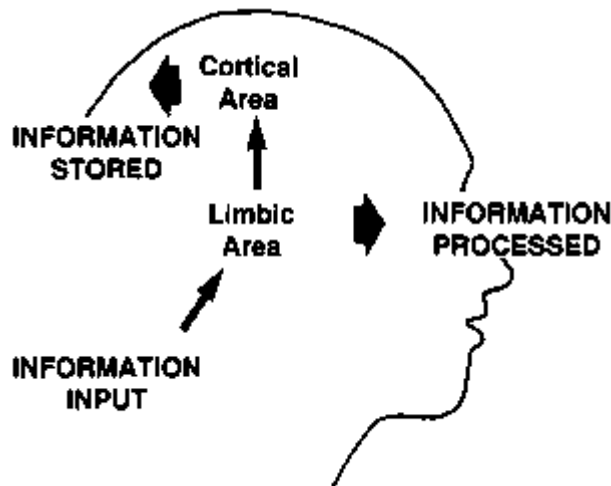

Information inputted from the 5 senses is processed in the limbic area and stored in the cortical area of the brain.

## Types of memory

There are three types of memory that have been identified:

- **Sensory memory.** Of course, we could store no memory without input from the 5 senses. When stimulated, the senses evoke a response called **sensory memory** that usually lasts about 1 second before fading.

Briefly look at the words in the box below. Now close your eyes and watch the words and outline disappear. This is an example of sensory memory.

### **SENSORY MEMORY**

- **Short-term memory.** The second type of memory is called short-term, or working memory. It lasts from 1 to 30 seconds. Short-term memory is limbic in origin.

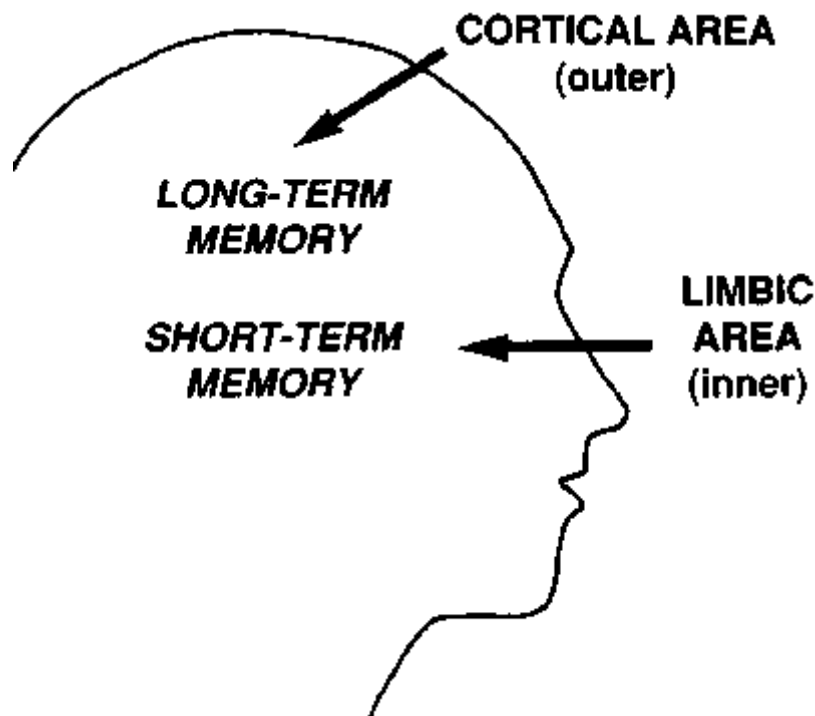

Short-term memory is stored in the limbic area in the inner brain.

- **Long-term memory.** And finally, there is long-term memory where we store knowledge from minutes to a lifetime. Long-term memory is stored in the temporal lobes of the cortex.

## Storage sequence

Another recent finding, important to the learning process, shows that we store knowledge in a certain sequence. Knowledge first goes through the senses into the short-term memory. Then, it passes through short-term memory, and the limbic system (hippocampus) sifts it before the temporal lobe stores it as long-term memory.

Thus, the hippocampus and its associated short-term memory are gatekeepers to long-term memory storage.

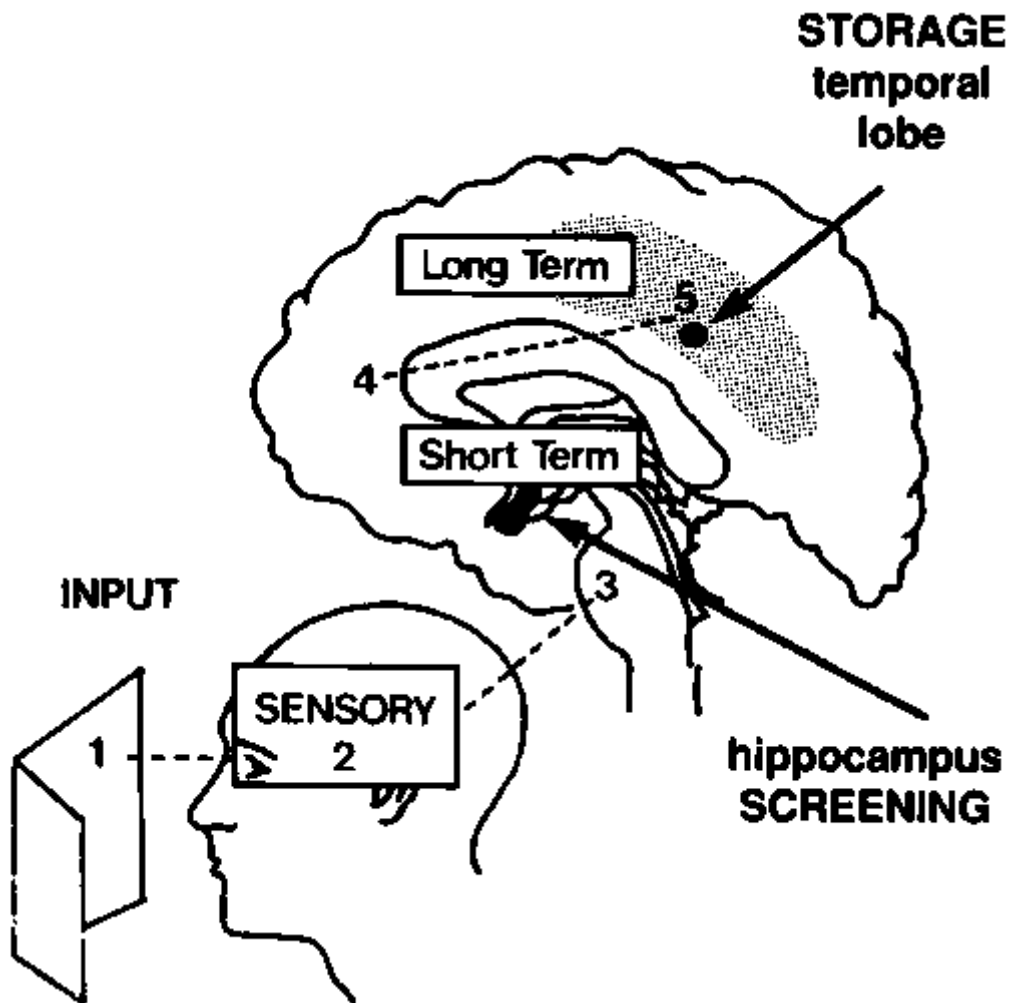

YOUR AI PROGRAM

Memory: *Summary II*

Memory Sequence	
	Duration
Long-term memory	minute to life
Hippocampus gate	
Short-term memory	1-30 sec
Sensory memory	1 sec

**Chunking, subsumers, and concept maps**

Associated with memory storage are three additional discoveries that help us understand how memory and recall work.

*Chunking*

One discovery is that during processing, information must be broken down into **chunks** or memory units. Of course, the units depend on our past learning and cultural experience.

7 ± 2

Chunks are the capability of an individual to process information in the short-term memory at any one time. The  $7 \pm 2$  rule states that the range of information bits that can be held in short-term memory at any one time is 5-9, or  $7 \pm 2$ . Therefore, most people can only process 5-9 chunks of information in their short-term memory at a time. Due to their different exposures, individuals vary in chunk size and speed by which they can deal with information, and therefore in their ability to process such information.

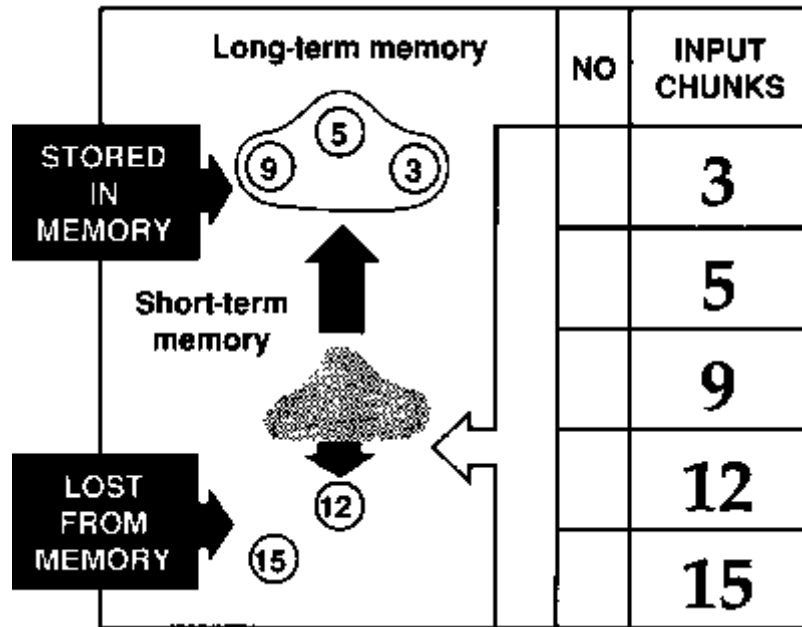

Let's say we want to help a learner store long-term information for problem-solving. Long-term storage must go through short-term storage, and short-term storage can only cope with 5-9 chunks of information. Thus, we must give the learner only 5-9 chunks of information at a time. Application of the  $7 \pm 2$  rule in information exposure would help learners input information for long-term storage. The principle is to use small organized steps to aid learning.

*Subsumers*

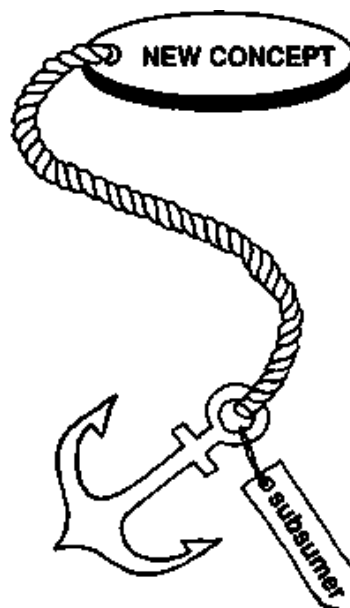



Research shows that we can learn and store new concepts more efficiently if we can link them with some already stored **previous concept** or **subsumer**. Our role as teacher and creator of instructional materials is to find common subsumers stored in students' minds and use them to lead students into new concepts.

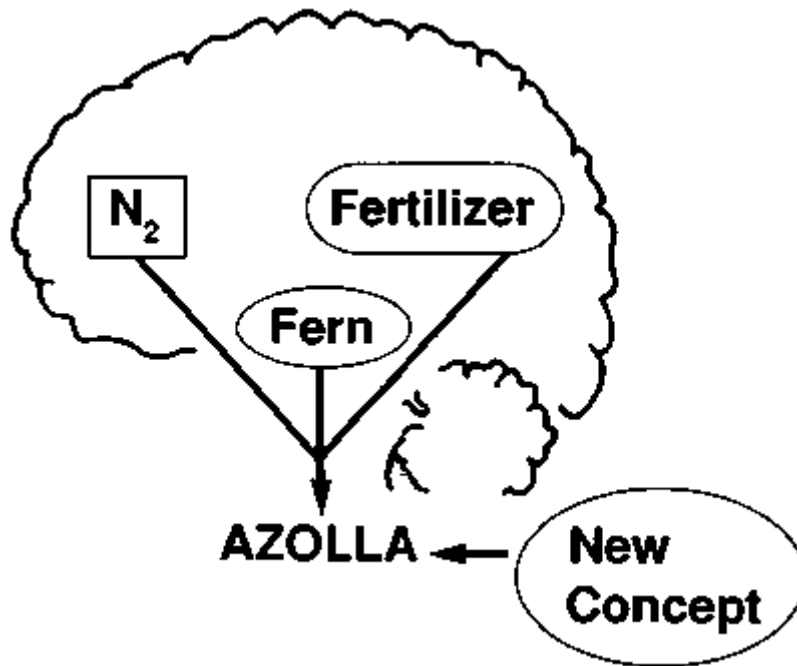

**Step 1.** Find common existing concept (subsumer).

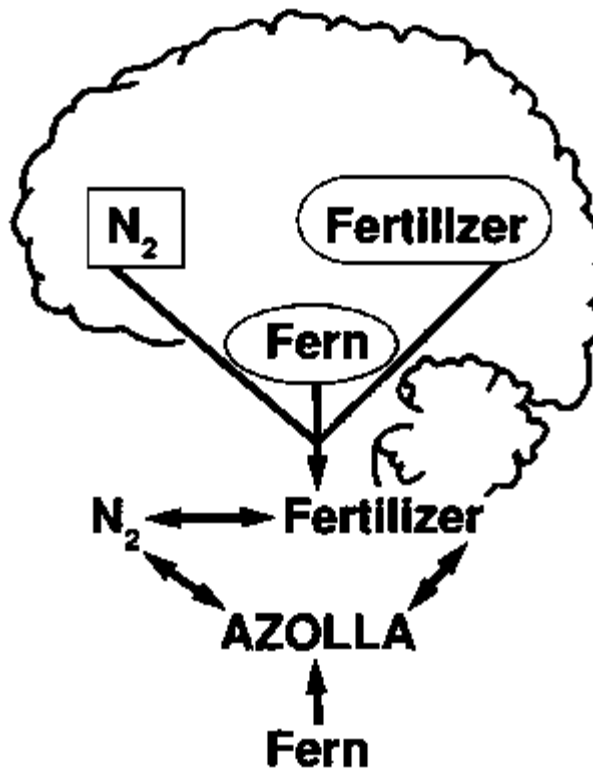

**Step 2.** Associate new concept with subsumer.

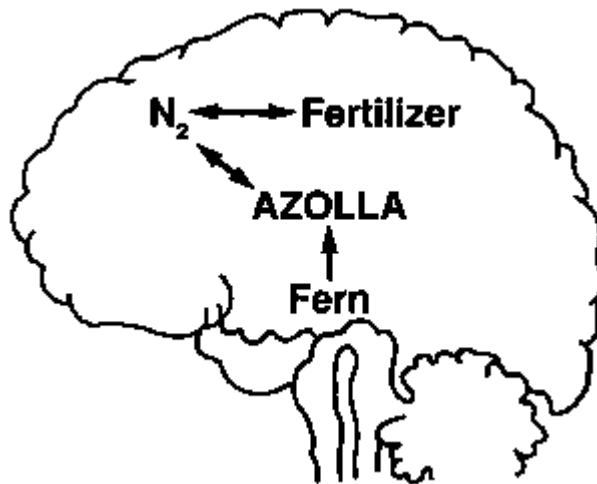

**Step 3.** Design a learning task to help link new concepts to existing subsumers.

The first step, getting the teacher and the learner to agree on the existing concept, is often difficult. It depends on the learner's prior exposure to the concept. Feedback is essential here to determine these levels of exposure to create relevant learning experiences that relate to stored subsumer menus or maps.

The dialogue or interview is useful in determining subsumers because it is faster than written exams and has more feedback opportunities.

Communication through the written/reading channel is more difficult but is easier if you use verbal words and nonverbal pictures. Left brain = words. Right brain = picture.

*Concept maps*

Learning research has given us another helpful instrument to assess the level and associations of a learner's concepts. It is called a **concept map**.

Concept maps and their subsumers can help determine the appropriate information level for creating learning materials. They are also valuable to create and measure instruction.

We asked a farmer to draw his concept map of the word "rice." Notice the associations or subsumers.

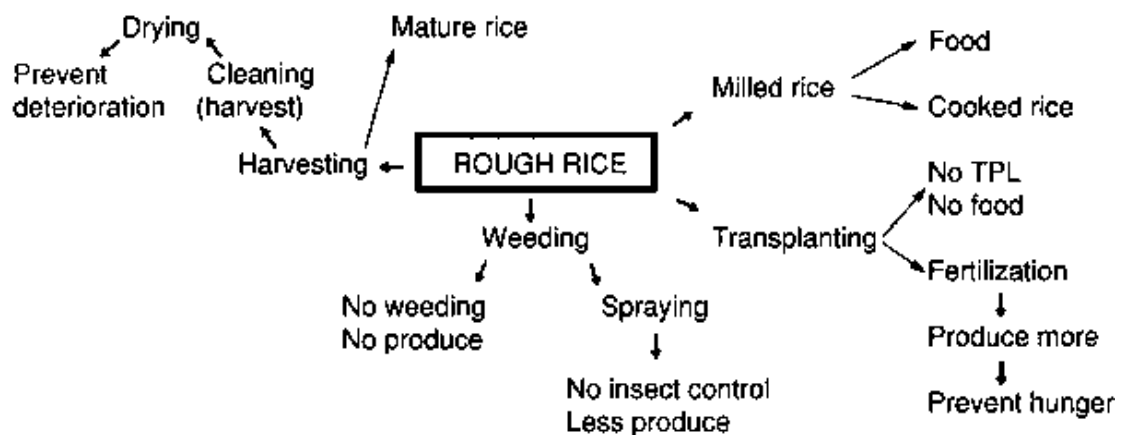

**RICE: A CONCEPT MAP**

**Memory: Summary III**

**AIDS TO LEARNING**

Chunk	=	meaningful unit 7 + 2 short-term memory
Subsumer	=	association anchor
Concept map	=	method of assessing subsumers

**Feedback exercise**

• Usually, the left brain performs \_\_\_\_\_ functions while the right brain is \_\_\_\_\_ oriented.

• Match the terms with the brain hemisphere function.

Function	Hemisphere
_____ intuitive	A. left
_____ sequential	B. right
_____ mathematical	
_____ holistic	
_____ analytical	

• Match these terms with the limbic hemisphere function.

_____ emotion	L. left
_____ organization	R. right
_____ conservative	
_____ artistic	
_____ interpersonal	

• In which brain lobe is memory actually stored?

\_\_\_\_\_

• List and describe the importance of the two brain organs of the limbic system.

HINT: One starts with an A and looks like an almond. In fact, the word means almond-like. The other's prefix is similar to an animal.

1. \_\_\_\_\_ , \_\_\_\_\_

2. \_\_\_\_\_ , \_\_\_\_\_

• List in sequence and relate the time duration of three types of memory.

Memory sequence    Type    Time

1. \_\_\_\_\_

2. \_\_\_\_\_

3. \_\_\_\_\_

- Look at the last objective on page 57 of this chapter. What two memory devices are included in this chapter?

\_\_\_\_\_ , \_\_\_\_\_

- List and discuss an additional device to assist in preparing learning resources.

\_\_\_\_\_

**Answers to feedback exercise**

- Speech - verbal, visual
- A, A, A, B, A
- R, L, L, R, R
- Temporal
- amygdala - emotion, attitudes hippocampus - memory screen
- Sensory, 1 second  
short-term, 1 second to 1 minute  
long-term, 1 minute to lifetime
- Chunking, subsumers
- Concept map - map of subsumer relationships stored in memory.

**References and information of interest**

Begley S (1983) How the brain works. Newsweek February: 34-41.

DeBono E (1970) Lateral thinking. Penguin Books, New York.

Hermann N (1981) The creative brain. Training Dev. J. 35(10):11-16.

Ironson D (1984) Your brain: using both halves for enhanced communication. Int. TV. July, 18-21.

Janes J (1976) Origin of consciousness in the breakdown of the bicameral mind. Houghton Mifflin Co., Boston.

Keeton W, McFadden C H (1983) Elements of biological science. W. W. Norton and Co., New York.

Muller G A (1956) The magical number 7 plus or minus two; some limits on our capacity for processing information. Psychol. Rev. 63:181.

National Society for Study of Education (1976) The psychology of teaching methods. University of Chicago Press, Chicago, Illinois.

Novak J D (1977) A theory of education. Cornell University Press, Ithaca, New York.

Novak J D (1980) Learning theory applied to the biology classroom. Am. Biol. Teacher 42(5):280-295.

Novak J D, Gowin D B (1988) Learning how to learn. Cambridge University Press, Cambridge, England.

Olson D R (1972) On a theory of instruction: why different forms of instruction result in similar knowledge. *Interchange* 3(1):9-24.

Randhawa B S, Colffman W E (1978) Visual learning, thinking, and communication. Academic Press, New York.

Sagan C (1977) *Dragons of Eden*. Random House, New York.

*Scientific American* (1979) The brain. W. H. Freeman and Co., San Francisco.

Simon H A (1974) How big is a chunk? *Science* 183:482.

Springer S P, Deutsch G (1981) Left brain, right brain. W. H. Freeman and Co., San Francisco.

Stevik E W (1976) Memory meaning and method. Newbury House Publishing, Inc. Stewart, Rowley, Massachusetts.

Van Kirk J T, Rowell R (1979) Concept maps: a tool for use in biology teaching. *Am. Biol. Teacher* 41(3):171.

## **CHAPTER 5. Learning Styles**

### ***Objective***

After reading this chapter, you will be able to

- Explain the different ways by which people learn and classify the different types of learners and learning strategies.

### ***How people learn***

#### **People learn differently.**

In an approach to a new learning strategy such as self-learning, we would be remiss if we did not relate it to learning/teaching styles.

Researchers from varied disciplines have identified four basic personalities in relation to learning. One researcher, Dr. David Kolb, found that some people learn by **doing**, others by **sensing and feeling**, some by **watching**, and some by **thinking**. Now, of course, a person does not rely on one of these ways all the time but shows a preference for one over the others.

Kolb found two basic variables in the learning preferences of people:

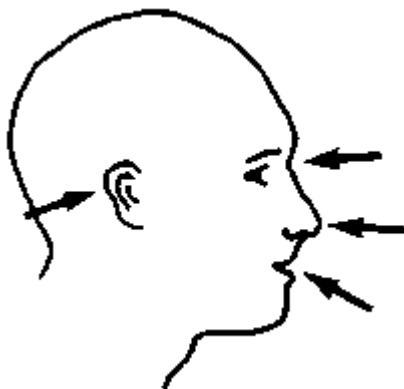

perception

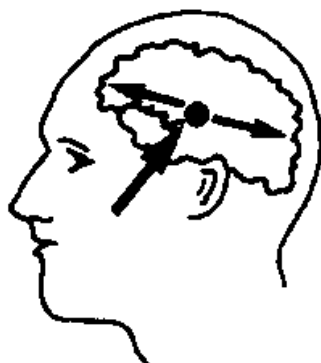

process

That is, people **perceive** in a continuum between concrete and abstract points.

concrete	
↑ ↓	perception perception perception perception
abstract	

Those at the concrete end of the spectrum **sense** and **feel** their way. They are called sensors/feelers.

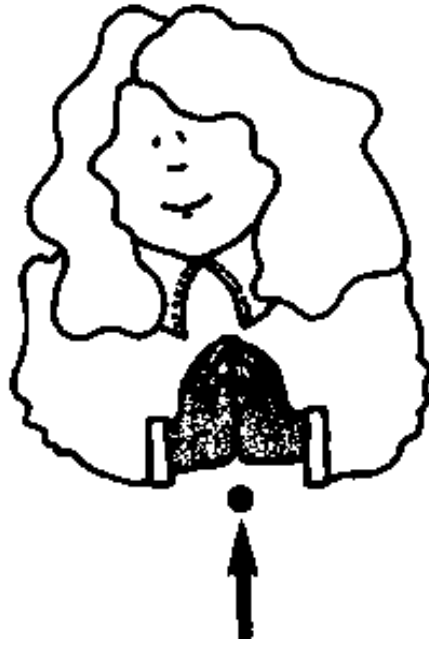

**concrete = sensors/feelers**

Others at the abstract end would rather think than feel.

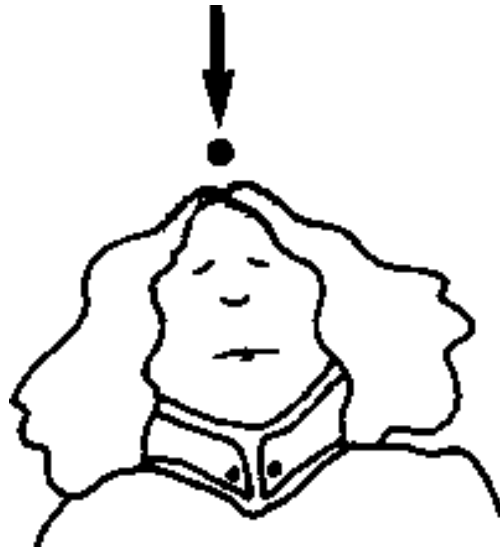

**abstract = thinkers**

Hence, the continuum-

**concrete = sensors / feelers**

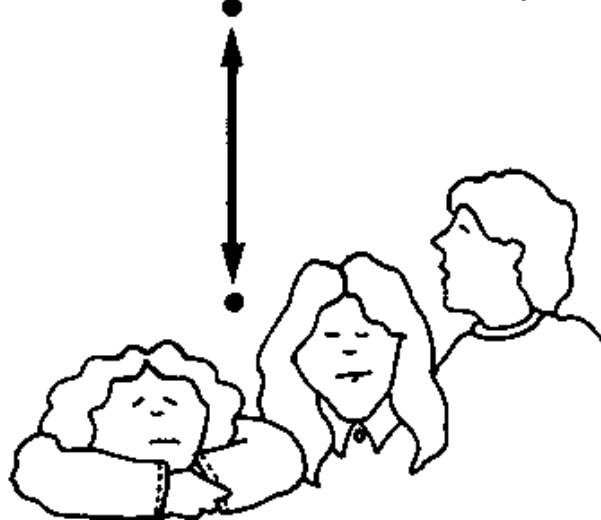

**abstract = thinkers**

As for **processing** information there is, again, a continuum between those who like to **act** or **do**,

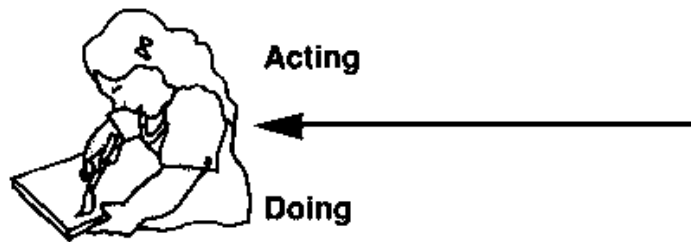

and those who would rather watch.

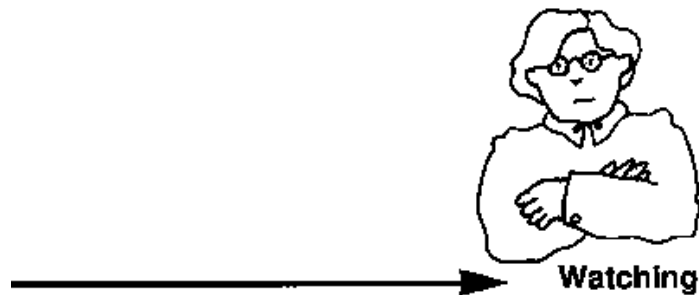



By coordinating these preferable perception and processing variables, educational researchers have identified 4 learning styles:

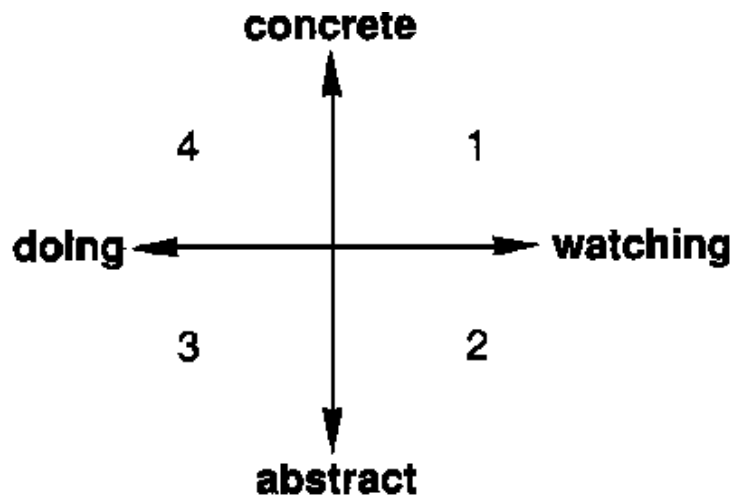

#### ***Learner personality types***

Another learning style researcher, Dr. Bernice McCarthy, has labeled the 4 types of learners. Type 1 learners are *innovative learners*.

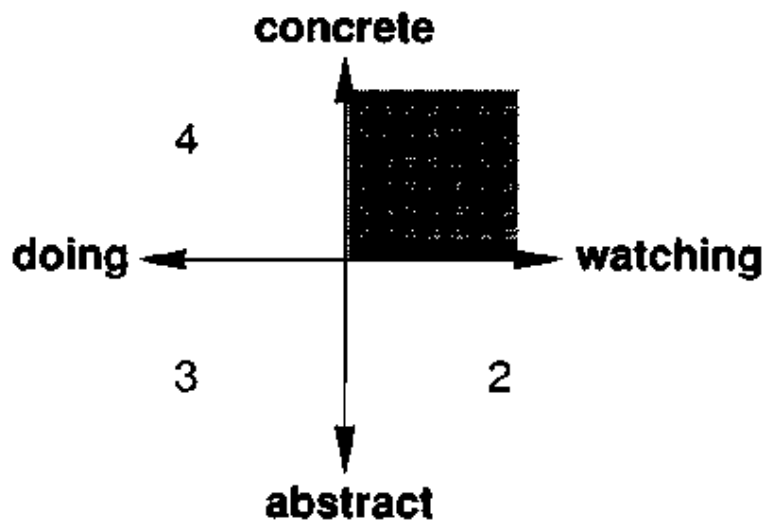

#### **Type 1 Innovative Learners**

Some brief descriptors of Type 1 learners are:

- Perceive concretely, process reflectively
- Social interactor
- Feeling
- Innovative
- Learn by listening
- Divergent thinkers



By comparison, Type 2 learners are called *analytic learners*.

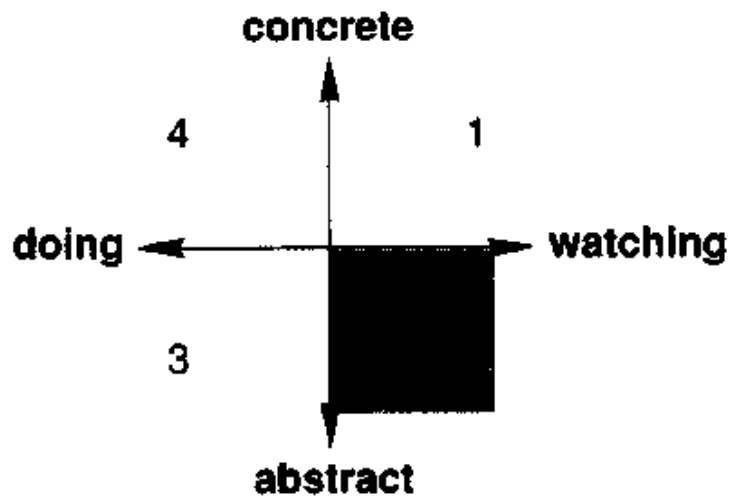

Type 2 Analytic Learners

The descriptors of Type 2 learners are:

- Perceive abstractly, process reflectively
- Consider what the expert thinks
- Idea-oriented
- Data collectors
- Seek sequential information
- Intellectuals



Those who prefer the third type of learning style are called *common sense learners*.

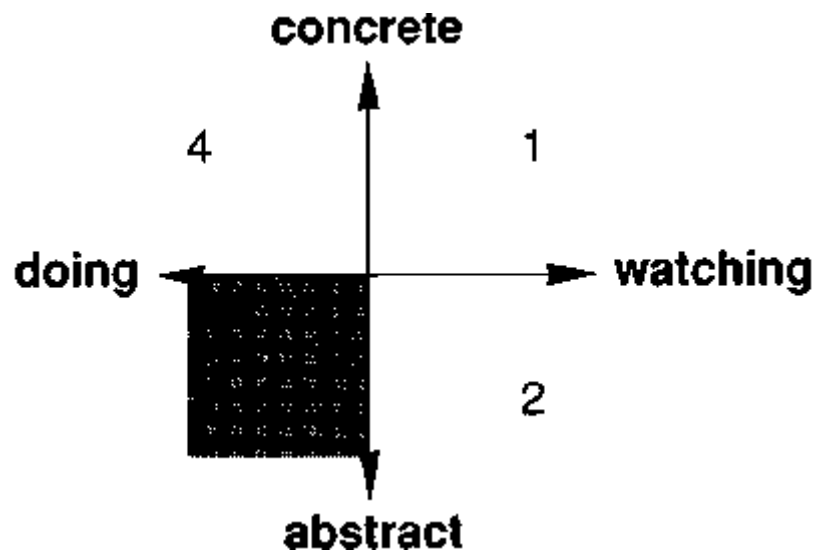

Type 3 Common Sense Learners

They can be described as:

- Perceiving abstractly, processing actively
- Practical
- Hands on
- Reality-oriented
- Problem solvers
- Interested in application/making things work



Type 4 learners are called *dynamic learners*.

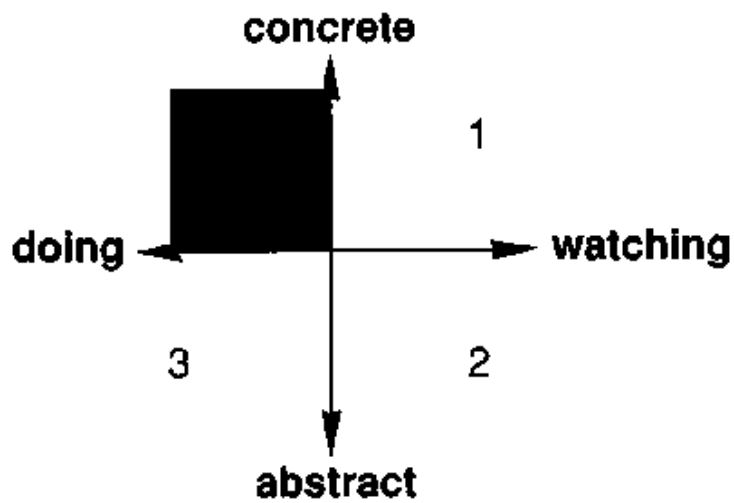

Type 4 Dynamic Learners

They are characterized as:

- Perceiving concretely, processing actively
- Intuitive
- Unstructured
- Experimental
- Changeable
- Risk takers

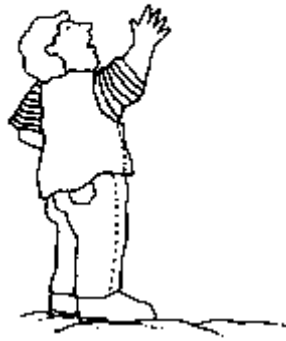
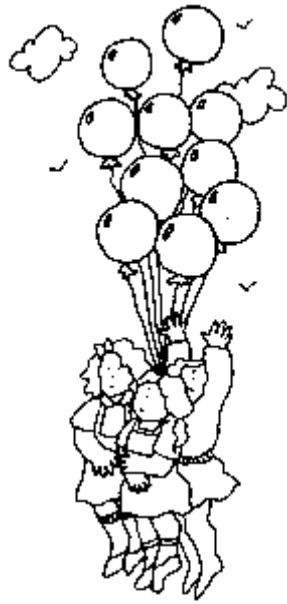

So in summary, there are 4 learning styles and each is related to a variable personality type in a training population.

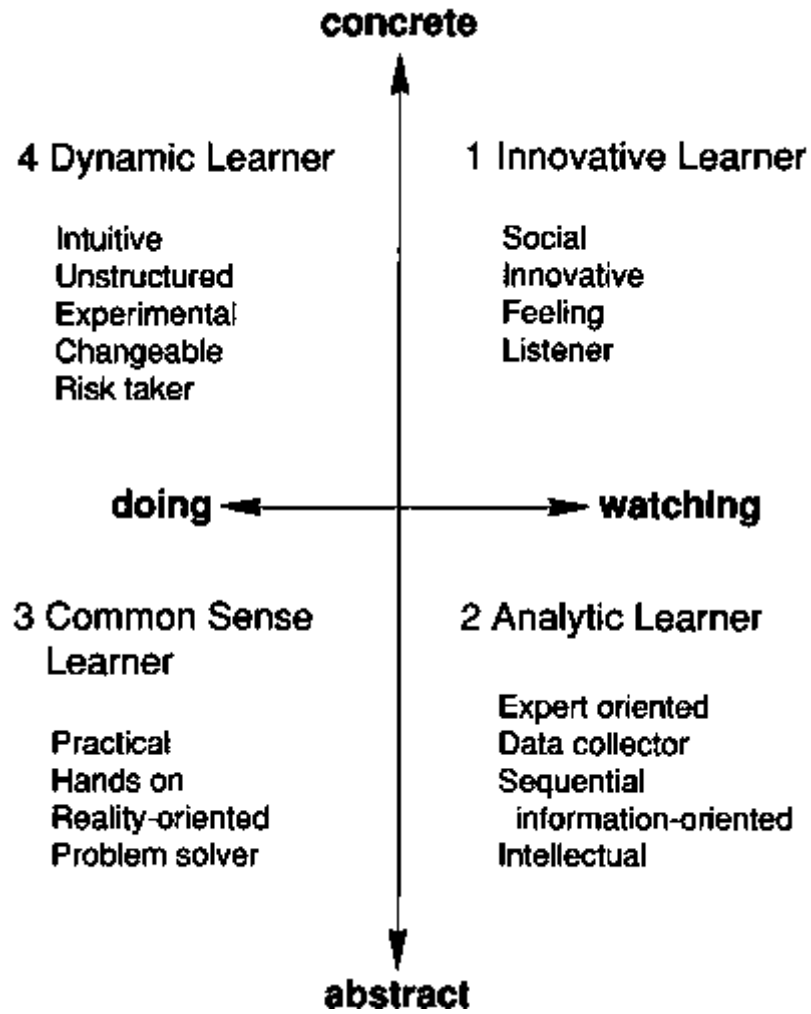

If these 4 learning styles emerge from inborn natural tendencies associated with the senses, what are the teaching styles that serve to communicate with these learning styles?

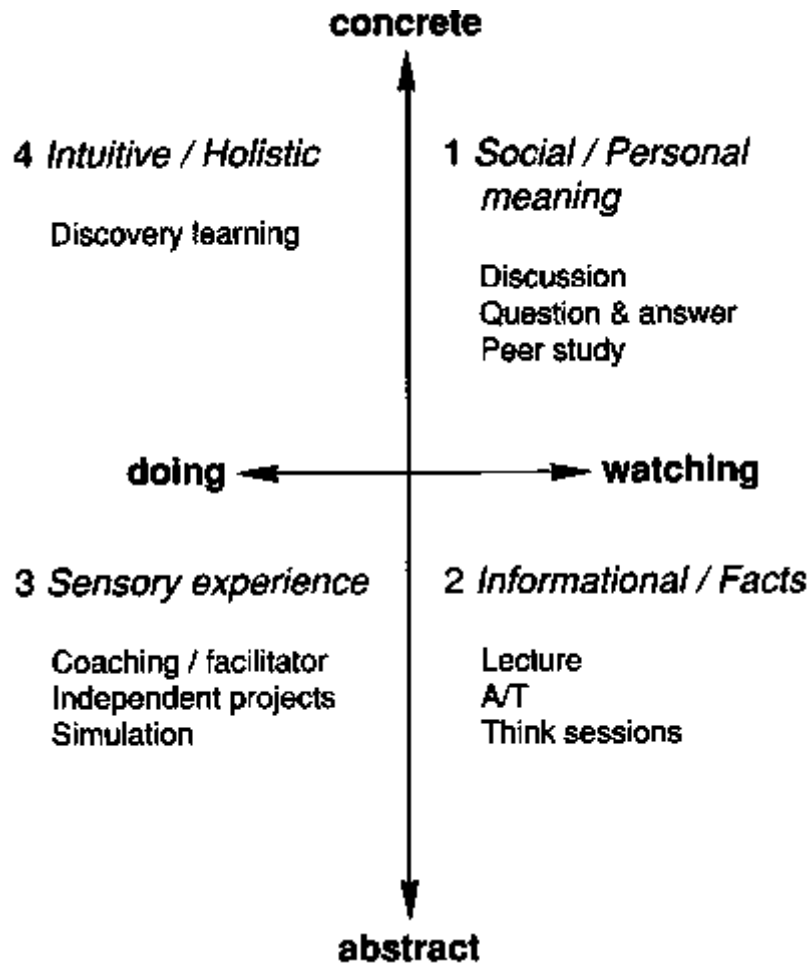

Again McCarthy's research has shown that most training is directed at a **Type 2** learning style which addresses information, facts and concepts, but that only 28-30% of the population learn best in Style 2. So 70% of the learners could learn more efficiently if taught with teaching styles other than No. 2.

Yet, facts and concepts - cognitive information - are extremely important to communicate in the scientific disciplines.

- |  |
|--|
| <ul style="list-style-type: none"> <li>• INFORMATION</li> <li>• FACTS</li> <li>• CONCEPTS</li> </ul> |
|--|

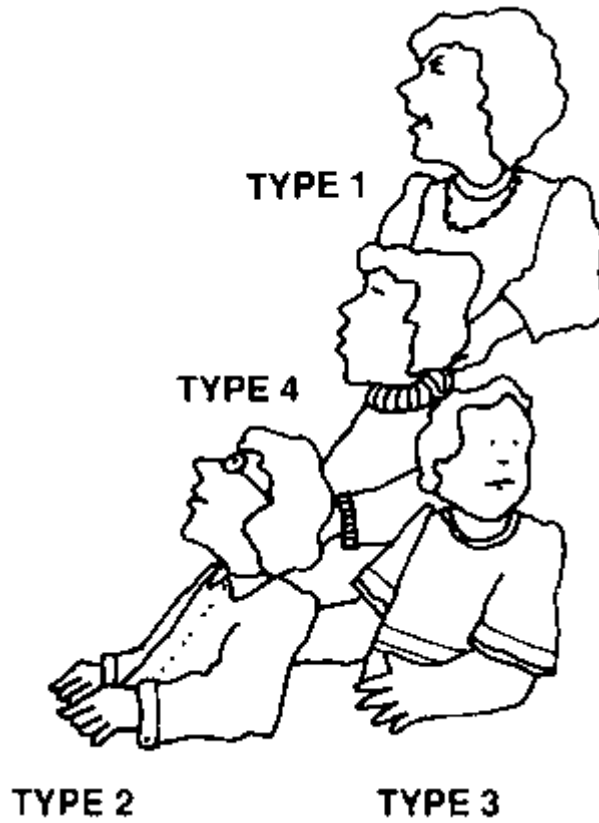

If traditional training is focused on Teaching Style 2 of which the **lecture** predominates, if traditional training is passive, what about

- Projects**
- Problem solving**
- Creativity**
- Other learning styles**

Often in traditional instruction, there is not enough time to *do*, to *apply* these important aspects of learning.

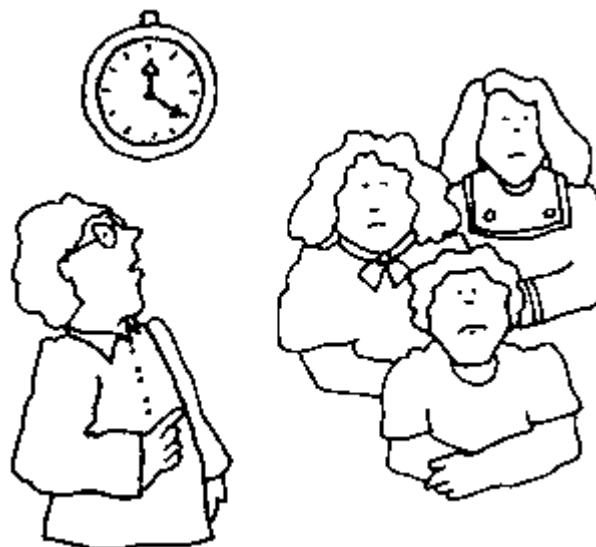



## ***A strategy for Learning Style 2***

Thus, one strategy is to create self-learning materials for Learning Style 2 (and eventually for all learning styles). By relegating cognitive information to a self-learning strategy, the educator is *free* from being a standup purveyor of facts, *free* to explore and create, *free* to develop learning strategies in the other learning styles - experiences that focus on problem solving. For, again, what use is knowledge if it can't be used to solve problems for the betterment of mankind?

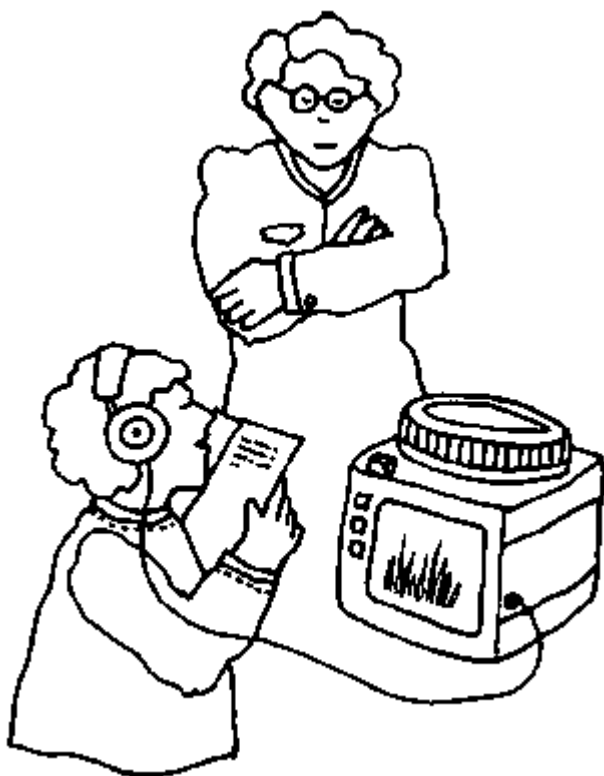

## ***References and information of interest***

American College Testing Program (1977) Promoting student learning in college by adapting to individual differences in educational cognitive style: Final evaluation report. Princeton, New Jersey.

Button C B (1977) Teaching for individual and cultural differences: a necessary interaction. 435-438 *in* Educational Leadership. Vol. No. 34.

Dunn R, Dunn K (1974) Learning style as a criterion for placement in alternative programs. Practical applications of research. Phi Delta Kappan 56(4):275-278.

Dunn T, Dunn K (1978) Teaching students through their individual learning styles: a practical approach. Reston Publishing Co., Inc., Reston, Virginia.

Fischer B B, Fischer L (1979) Styles in teaching and learning. Educational Leadership 36(1): 245-254.

Gagne R M, ed. (1967) Learning and individual differences. Charles E. Merrill, Columbus, Ohio.

Gregorc A F (1979) Learning/teaching styles. Student learning styles: diagnosing and prescribing programs. National Association of Secondary School Principals, Reston, Virginia.

Hunt D E (1979) Learning styles and student needs: an introduction to conceptual level. Student learning styles: diagnosing and prescribing programs. National Association of Secondary School Principals, Reston, Virginia.

Jung C G (1976) Psychology types. Princeton University Press, New Jersey.

Kolb D A (1979) Organizational psychology: an experiential approach. 3d ed. Prentice-Hall, Englewood Cliffs, New Jersey.

Lawrence G D (1982) People types and tiger stripes. 2d ed. Center for Applications of Psychological Type. Gainesville, Florida.

McCarthy B (1979) Learning styles: identification and matching teaching formats. Unpublished doctoral dissertation, Northwestern University, Illinois.

McCarthy B F (1981) The 4 MAT system: teaching to learning styles with right/left mode techniques. Mark Anderson and Associates, Arlington Heights, Illinois.

Merril D W, Reid R H (1976) Style awareness text. Personnel Predictions and Research, Inc. The Tracom Corp., Denver, Colorado.

Myers I B, McCaulle M H (1985) A guide to the development and use of the Myers-Briggs type indicator: manual. Consulting Psychologists Press, Palo Alto, California.

Renzulli J, Smith L H (1978) Learning styles inventory: a measure of student preference for instructional techniques. Creative Learning Press, Inc., Mansfield Center, Connecticut.

Torrance E Your style of learning and thinking, Form C. Interpretation report. Department of Educational Psychology, University of Georgia, Athens, Georgia.

## PART II - A/I OR SELF-LEARNING MATERIALS: CREATION AND USE

### CHAPTER 6. Performance/Instructional/Objectives

#### *The learning domains*

Remember, a principle of learning is that repetition aids retention. That's one reason for the objective and feedback exercises in A/I. Now that you have the A/I definition in mind, let's explore the areas of learning.

If you skipped the first two chapters, please go back in Chapter 2 and *review* the 8 parts of a module. While you're in this chapter, it's even more important to *learn* our working definition of A/I including the 8 concepts.

Repetition aids retention  
Repetition aids retention  
Repetition aids retention  
Repetition aids retention  
Repetition aids retention  
Repetition aids retention  
Repetition aids retention  
Repetition aids retention  
Repetition aids retention  
Repetition aids retention

For our purposes, we can classify all learning materials into three areas called **learning domains**.

1. **Cognitive** means knowledge or mental ability.

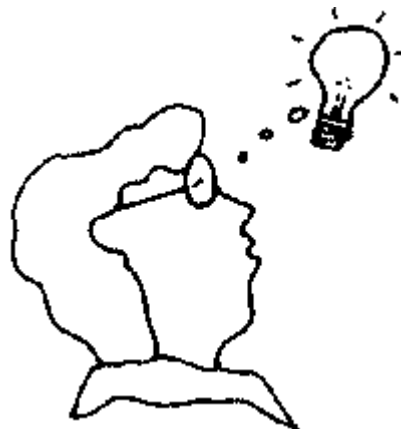

2. **Affective** means attitudes or emotional commitment.



3. **Psychomotor** means skills or physical ability.



### **Exercise 1**

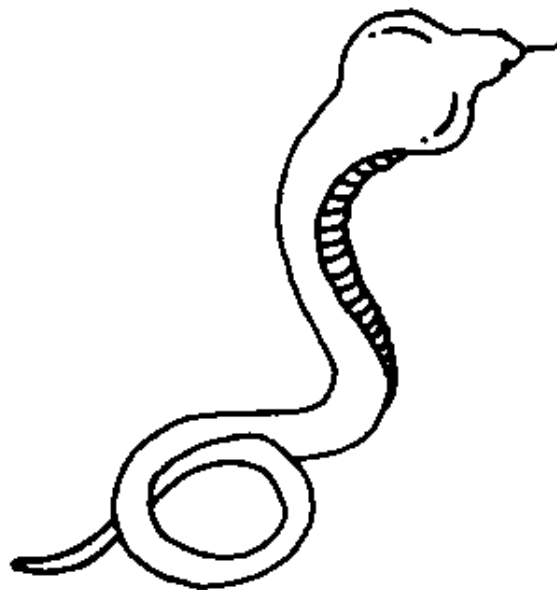

Here are some examples of information. Can you classify them into their respective domains?

- A. In the yoga position, the serpent rests in the human body at the base of the spine. Positioned with its head up, it slithers up the spine and passes the third eye in the forehead and comes to rest in the person's head.
- B. When killing a poisonous snake, be sure to stay at least the distance of the snake's body length away. With a strong implement, strike it on the back of the head.
- C. Cobras are especially bad snakes.

The first example, A, is **cognitive**, providing information about the thought processes associated with yoga. It also describes the location of the third eye which eastern cultures associate with intelligence.

The second, B, explains skills involved in killing a snake and is, therefore, **psychomotor**.

And the third, C, relates an attitude (**affective**) information about cobras. Someone who makes a livelihood with performing cobras might have a different attitude!

We purposely used the emotion-laden subjects of religion and snakes as well as the word “slithers” to challenge your ability. Did you do well on the exercise? We’ll return to learning domains a little later in this chapter.

First, we must write performance objectives. Even Skinner’s rats and pigeons had a goal. We call these goals **performance objectives**.

### ***Performance objectives***

Performance objectives are tools to explain the material you want to teach. They simply tell what the instructor wants the student to learn.

#### *Preamble*

There are 4 major parts of an objective. We call the first part the preamble. These are the words at the beginning of the objective that set the stage for the action to follow. For example, “At the end of this module, you will be able to...” is a preamble to the expectations you have of your students.

*Note:* Each learning domain has its own verbs. This manual contains information on writing objectives in the cognitive domain because it is the major domain in which the self-learning process is successful.

#### *Verb*

The second part of an objective is the verb. The verb tells students precisely what you want them to do. Let’s use the preamble from our first example and then add a verb. At the end of this module, you will be able to “write...”

***Open vs closed verbs.*** When selecting verbs to use in writing objectives, remember that there are two kinds: **open** and **closed**.

Open verbs are open to different interpretations by different people. Because they are confusing, do not use them. For example, “to appreciate the plight of the subsistence farmer...” means many different things and is open to discussion.

Closed verbs are specific and convey common meanings to people. They close the door on misinterpretation. Here is a partial list of closed verbs grouped in categories. You can use this list to write objectives in the cognitive domain. As you design your courseware, you may want to refer to page 101 often.



A verb list for stating cognitive objectives.

(Classification based on Bloom's taxonomy of educational objectives - cognitive domain).

<b>Knowledge</b>	<b>Comprehension</b>	<b>Application</b>
define	translate	interpret
repeat	restate	apply
record	discuss	employ
list	describe	use
recall	recognize	demonstrate
name	explain	dramatize
relate	express	practice
underline	identify	illustrate
	locate	operate
	report	schedule
	review	shop
	tell	sketch
<b>Analysis</b>	<b>Synthesis</b>	<b>Evaluation</b>
distinguish	compose	judge
analyze	plan	appraise
differentiate	propose	evaluate
appraise	design	rate
calculate	formulate	compare
experiment	arrange	value
test	assemble	revise
compare	collect	score
contrast	construct	select
criticize	create	choose
diagram	setup	assess
inspect	organize	estimate
debate	manage	measure
inventory	prepare	
question		
relate		
solve		
examine		
categorize		

*Object*

The third part of an objective is the **object**. Let's continue with the same example using the preamble, the verb, and then the object. "At the end of this module, you will be able to write a **performance objective**." The object, a performance objective, is the object of the verb write. It clearly shows students what you want them to learn or do.

<b>PREAMBLE</b>	<b>The student will be able to</b>
<b>VERB</b>	<b>write</b>

<b>PREAMBLE</b>	<b>The student will be able to</b>
<b>VERB</b>	<b>write</b>
<b>OBJECT</b>	<b>a performance objective.</b>

**Exercise 2**

Now let's take a break from inputting information and practice.

1. Write two variations of a preamble.

Example: At the end of this chapter, you will be able to:

- a. Preamble \_\_\_\_\_
- b. Preamble \_\_\_\_\_

**Look at the verb list for stating cognitive objectives for some ideas. Maybe you can think of a new one.**

2. Now let's tie these preambles to verbs. Look at the list on page 101 and select different verbs to go with your preambles.

Example:

**PREAMBLE** At the end of this chapter, you will be able to  
**VERB** write

- a. preamble \_\_\_\_\_  
verb \_\_\_\_\_
- b. preamble \_\_\_\_\_  
verb \_\_\_\_\_

3. Now connect the preamble and the verb with an object. Think of two objects or contents from your teaching experiences and place them with the preambles and verbs.

Example:

**PREAMBLE** At the end of this chapter, you will be able to  
**VERB** write  
**OBJECT** performance objectives.

- a. preamble \_\_\_\_\_  
verb \_\_\_\_\_ object \_\_\_\_\_.
- b. preamble \_\_\_\_\_  
verb \_\_\_\_\_ object \_\_\_\_\_.

**Congratulations! You have just written two learning objectives which clearly show students what you expect them to do.**

*Qualifiers and quantifiers*

We can be more exact about what we want students to do by adding explanatory words called **qualifiers** and **quantifiers**. They show restrictions, allowances, or givens.

A. **Qualifiers**. You can put the **qualifiers** before or after the preamble, but be consistent in their use. In these examples, verbs are in italics and qualifiers are boldfaced.

1. At the end of this chapter you should be able to *identify* the 5 insects **without the aid of a microscope**.
2. When you finish reading this, you can *draw and label* the parts of the rice seed **with the aid of your microscope**.

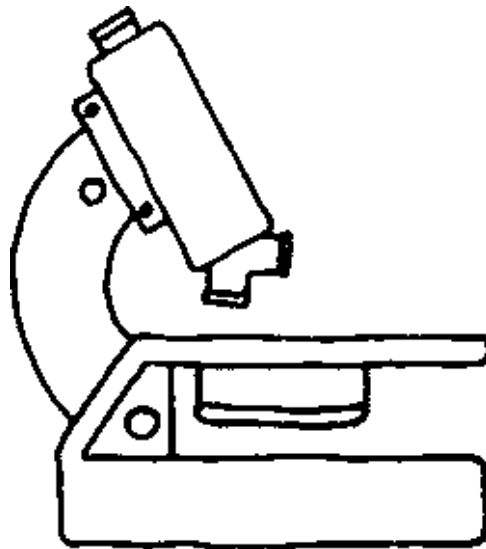

3. In the next exercise, *answer* the 20 exam questions **in 15 minutes**.

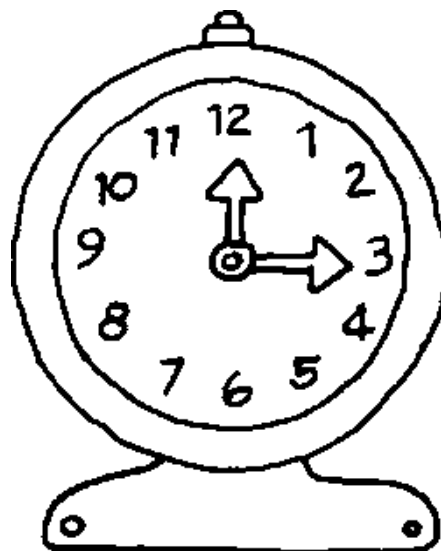



B. **Quantifiers**, or numbers, make the directions more explicit and help your learners remember better. Note the numbers in the previous objectives: Identify 5 insects. Answer 20 exam questions.

**NUMBERS  
ARE EXPLICIT:  
1, 2, 3 ...**

Turn to Chapter 2, and study the objectives. Notice the explicit quantifiers. It is better to use numerals (1,2,3,...) rather than written numbers because they are easier to see in the text.

For example, there are 4 major steps in writing objectives:

1. Select and write a preamble.
2. Select and write a verb.
3. Select and write an object.
  - Select and write a qualifier.
  - Select and write a quantifier. AND
4. Chunk. We'll study this one next.

*Chunk*

Another element that we can include in a learning objective is the chunk. The process of chunking is detailed in Chapter 4. Chunking is making a block or “chunk” of information that makes the objective even more explicit. It also provides immediate feedback. You place it underneath the objective.

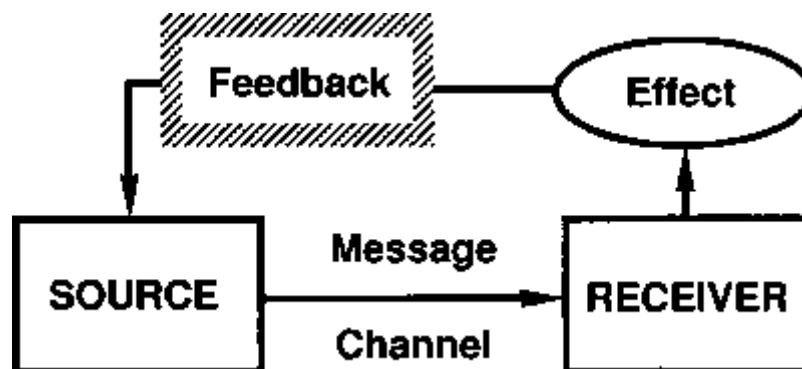

For example:

- Objective - List the 4 major parts of a performance objective:  
Chunk-  
1. preamble  
2. verb  
3. object  
4. chunk

Notice that the chunk

- is underneath the objective,
- gives a short answer to the objective,
- provides immediate feedback, and
- makes the objective explicit.

Try to include graphics, diagrams, or pictures in the chunk to help students remember the information.

For example, here's a diagram of the parts of an objective.

**1 PREAMBLE / 2 VERB / 3 OBJECT**

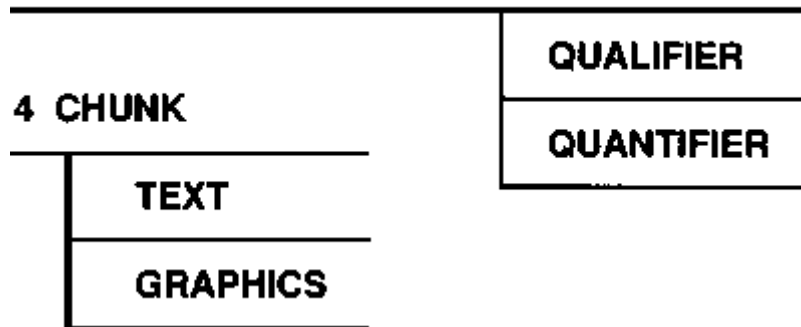

The objective would read, "The trainee will be able to list and relate the 4 primary parts and any subparts of a performance objective."

In the chunk, the positions of the words on the diagram help show the parts and their relationships with each other. The positions of the words are especially useful in showing relationships in statistical formulas, sentence diagrams, machinery parts, life cycles, morphology, and geography.

Here are two more examples:

Objective: Describe the life cycle of a rice stem borer.  
 Chunk:

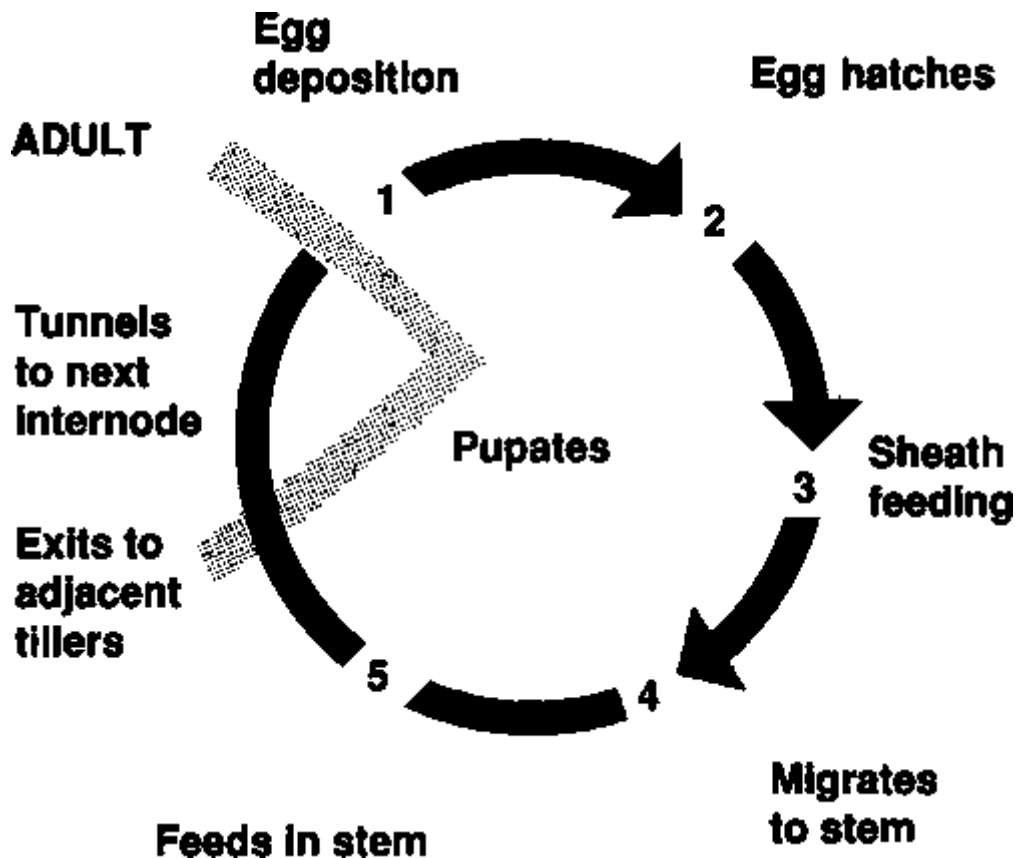

Objective: Name the parts of the rice floret.  
Chunk:

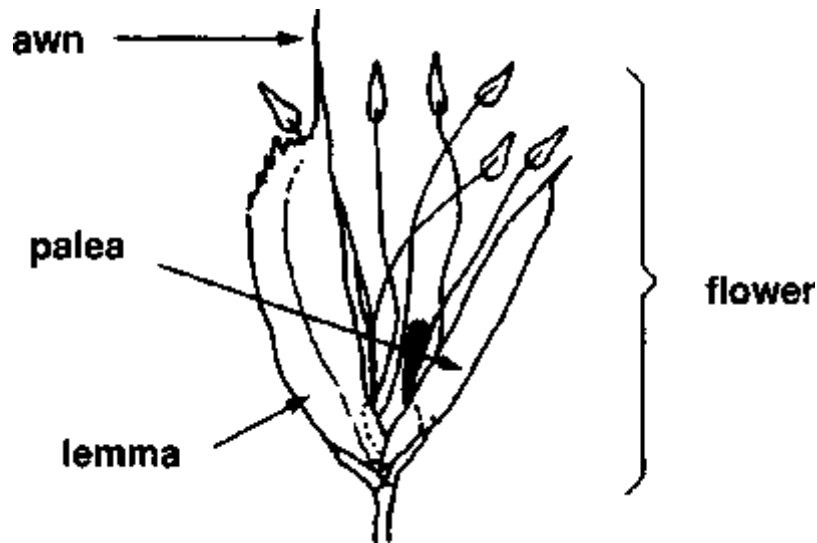

Thus, chunks can be either verbal or visual (pictorial). Try using a lecture handout to practice writing objectives.

### ***Prospectus and rationale***

#### **What and Why**

Two other concepts that tell the student what the lesson is about are the **prospectus** and the **rationale**.

The **prospectus** tells *what* is the overall goal of the module. For example, the prospectus of this module is that it contains information that will prepare you to write performance objectives.

The **rationale** explains *why* the subject matter is important. For example, instructional objectives provide an important tool in the learning process by

- defining acceptable student behavior,
- making a contract between the instructor and learner,
- organizing information,
- allowing the learner to self-evaluate,
- explaining concepts,
- reducing learning time, and
- providing the means for feedback.

### ***Exercise 3: Writing objectives***

Now please turn to the performance objectives at the beginning of this chapter.

If you didn't find any, don't be alarmed; your guide is all in one piece. We left the performance objectives for you to write as a practice exercise. Using your verb list, go through this chapter from the beginning, writing and chunking objectives from the content material.



Using a sheet of paper, write at the top:

Prospectus: already written

Rationale: already written

Objectives: At the end of this module, you will be able to

- \_\_\_\_\_
  - \_\_\_\_\_
  - \_\_\_\_\_
  - \_\_\_\_\_
- etc.

The answers follow, but please don't peek until after you've had a try.

Perhaps you arranged your objectives in a different order. Your chunks may be different. The focus of your objectives may be narrower or broader.

When **you** write the objectives, **you** can choose the material you want the student to learn. **You** are creating the contract with the student. It's your intent! Your focus! Your power! Use it to teach!

If you feel you still need more information about objectives, read about norm-referenced and criterion/mastery-referenced instruction in Chapter 10.

### **Answers to Exercise 3**

Objectives: At the end of this chapter, you will be able to

- List and define the 3 learning domains.

cognitive  
affective  
psychomotor

- Define in your own words the concept of performance objective.

desired outcome  
contract  
intent  
focused behavior change

- List 2 words associated with student behavioral action and instructional objectives.

Do  
Verb

- Write 2 preambles.
- Relate the learning domain addressed by this guide.

cognitive

- Compare open and closed verbs associated with objectives.

open - ambiguous; should not be used  
closed - explicit; should be used

- List in sequence the 4 primary parts of an objective.

preamble  
verb  
object  
chunk

- Describe qualifiers and quantifiers.

make objective explicit  
qualitative  
quantitative

- Define a qualifier.

givens  
allowances  
restrictions/limitations

- Discuss a quantifier.

numbers

- Relate a rule in using quantifiers in objectives.

use numeral notation

- Review 2 types of chunking.

verbal  
pictorial

- Associate 2 words that describe the intent of prospectus and rationale.

prospectus - what  
rationale - why

**Study example of a rationale on page 109.**

- Relate 7 advantages of using instructional objectives in the learning process.
- Write behavioral, performance, instructional objectives for Chapter 6.



**Feedback exercise**

- Match the learning domains with the term that best exemplifies their meaning.

___ psychomotor	A. quantifier/qualifier
	B. skill
___ cognitive	C. knowledge
	D. chunking
___ affective	E. emotional

- What word would best define the concept of a performance objective?  
\_\_\_\_\_

- What part of speech is best associated with writing a performance objective?  
\_\_\_\_\_

- The first portion of an objective is referred to as the \_\_\_\_\_.

- Place the 4 primary parts of an objective in their correct sequence.

1 object  
2 verb  
3 chunking  
4 preamble

- In objective writing, use of numerical notation is associated with a \_\_\_\_\_.

- Describe a chunk.

- Statement of purpose in a module is made of 2 parts - defining the general intent and the advantages. Name these 2 parts.  
\_\_\_\_\_  
\_\_\_\_\_

### ***Answers to feedback exercise***

- B, C, E
- Contract
- Verb
- Preamble
- 4,2,1,3
- Quantifier
- Last part of objective giving student verbal or pictorial feedback associated with the objective contract
- Prospectus  
Rationale

### ***References and information of interest***

Anderson R and company, eds. (1969) Current research on instruction. Prentice-Hall, Inc., Englewood Cliffs, New Jersey.

Bloom B S, ed. (1956) Taxonomy of educational objectives; handbook I. Cognitive domain. David McKay, New York.

Commission on Undergraduate Education in the Biological Sciences (1971) The use of modules in college biology teaching. J. G. Creager and D. L. Murray. CUEBS, Washington, D.C.

Fisher K M (1976) A-T science teaching: how effective is it? Biol. Sci. 26:691-697.

Friesen P A (1973) Designing instruction. Miller Publication, Sta. Monica, California.

Gueulette D G (1982) Microcomputers in adult learning. Follet Publication Co., Chicago, Illinois.

Anonymous (1973) Individualized instruction goes to college. Mosaic NSF 4(l):10-15.

Johnson R B, Johnson S R (1971) Assuring learning with self instructional packages. Self Instructional Packages, Inc., Chapel Hill, North Carolina.

McKay R (1971) Is programmed instruction for extension? J. Ext. 9(3):18-23.

Mager R E (1962) Preparing instructional objectives. Fearon Publishing, California.

Schom C B (1978) Teaching techniques: do results differ between approaches? AIBS Educ. Rev. 7(1):15.

John A, Barnes R D (1978) A cost analysis of audiotutorial and conventional instruction. AIBS Educ. Rev. 7(l):10-11.

## CHAPTER 7. The Script

Now that you know about writing the prospectus, rationale, objectives, and chunks, we will change the style of the chapter introductions to fit this learning technique.

### Prospectus

**What:** This chapter will help you create the script for your program.

### Rationale

**Why:** The script is an essential part of an A/I program. It provides the basis for both written and oral communication. You also use it as a blueprint as you create and apply learning techniques and decide on visuals.

### Objectives

At the end of this chapter, you will be able to

- Explain why learning materials often fail to communicate.
  - written to satisfy peer and colleagues rather than students
- Relate 4 rules that will help you communicate better and focus your writing style:
  - dismiss peers
  - assume role of student
  - use teaching principles
  - assume students have no prior knowledge of your material
- List 5 guidelines to develop a good writing tone for the narrative script.
  - informal
  - conversational
  - humor
  - questioning
  - reward
- Discuss a simple method to find the best style and tone to fit your audience.
  - pilot feedback studies of different styles and tones
- Appraise the 3 parts of a frame format.
  - visuals - verbal and pictorial
  - script - verbal and narrative
  - comments - evaluative and direction notes
- Restate the order in which you should develop visuals and script.
  - script first
  - disregard visuals initially
- Discern the constraints of slide trays when deciding how many slides to use in your program.
  - 80 slides
  - 120 slides



- Specify the maximum length of time for narration during each slide.

15-20 seconds  
30 seconds

- Discuss the reasons for the narrative time/slide suggestions.

learner becomes passive

- List and discuss 5 approaches used in generating script for PI.

outline  
lecture narrative  
direct frame narrative  
instructional objectives  
vocabulary

- Describe the storyboard approach in organizing a modular A/I program.

focus content material from general to specific using material reference cards (frames) in a sequential process

- Explain why the storyboard is popular.

presents whole view of material

### ***The technical storyteller***

Essentially much of our learning-formal, informal, or technical-has evolved in a storytelling format. In technical learning, the teacher acts as a well-informed storyteller presenting information at a rate determined by the subject matter.

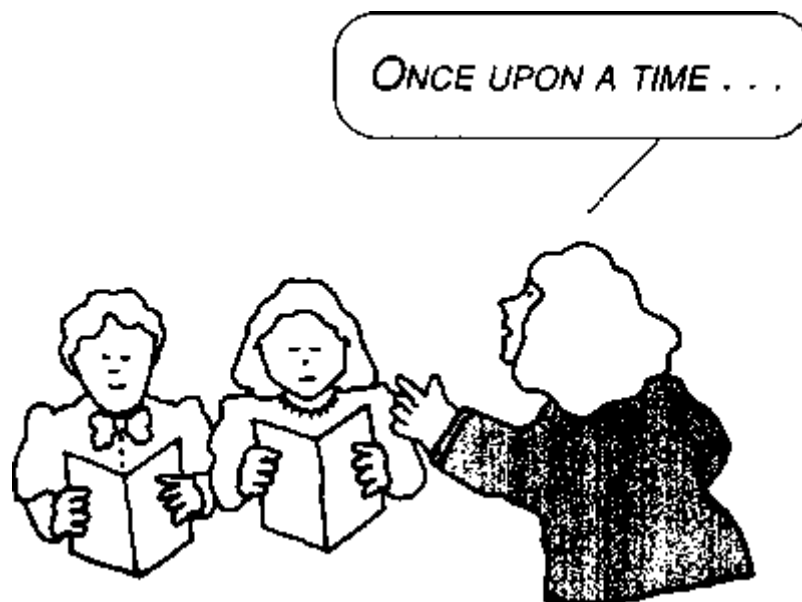

## Writing style

### Focus

Some technical writing guidelines have evolved because of their efficiency in communicating between professional peers.

Because most authors are professionals, they often use this technical writing style. As a result, much of the learning materials written for students are extremely formal, stilted, and ineffective.

Because the learning material is written for peers and colleagues rather than students, the material does not communicate with the intended audience.

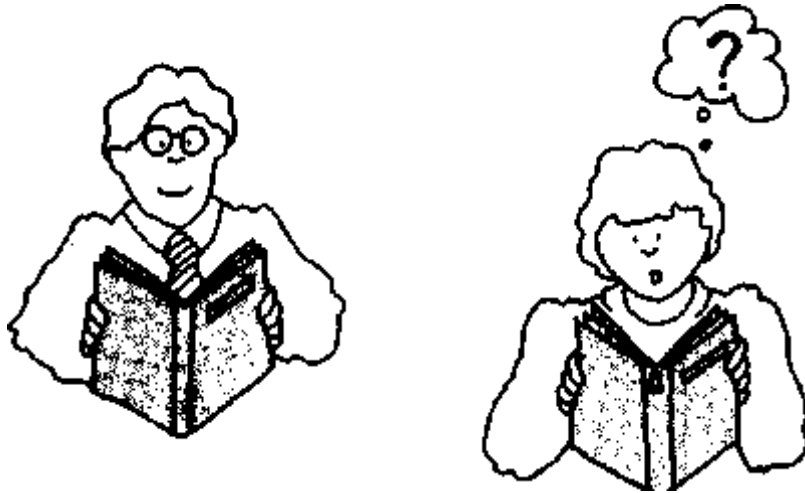

The **vocabulary** is very important and should fit the student level. Although it may be difficult with technical information, keep it simple. In fact, let the student level dictate the writing style you use.

Use effective teaching principles:

- small steps
- feedback
- repetition
- reinforcement

Start at the beginning and assume that the student knows nothing about your subject. The challenge in creating A/I modules is to make the complex simple in a creative way.

It starts with the script.

**Note: Be careful that your humor does not offend any of your students. For example, if you are a lecturer, see page 192. Some might be offended by this example.**

### Tone

Students learn faster if you adopt a particular writing tone. Often the tone may seem contrary to the formal methods of teaching.

Here are some **tone guidelines**:

- informal (relaxes)
- conversational (more action)
- humor (pauses for mental refreshment)
- questioning (enhances learning by the repetition principle)
- reward system (use of encouraging remarks)

### ***Arriving at a style***

Objective feedback from your students is one method of developing a style that communicates effectively with them.



Develop and pilot several experimental styles and test them on your students with a simple attitude questionnaire.

For example, here is the start of a simple attitude questionnaire:

Read the 3 samples of information labeled A, B, and C.

1. Which sample did you enjoy reading most?

A \_\_\_\_ B \_\_\_\_ C \_\_\_\_

Why? \_\_\_\_\_

2. Did you enjoy the conversational tone used in sample A?

Yes \_\_\_\_ No \_\_\_\_

3. Did you find the humor entertaining?

Yes \_\_\_\_ No \_\_\_\_

4. etc.

When you become a script writer, you will find that writing for a spoken presentation is much different than writing for a publication.

After writing your script, **read it aloud** and listen to how it sounds. Read it to a few of your students and get feedback.

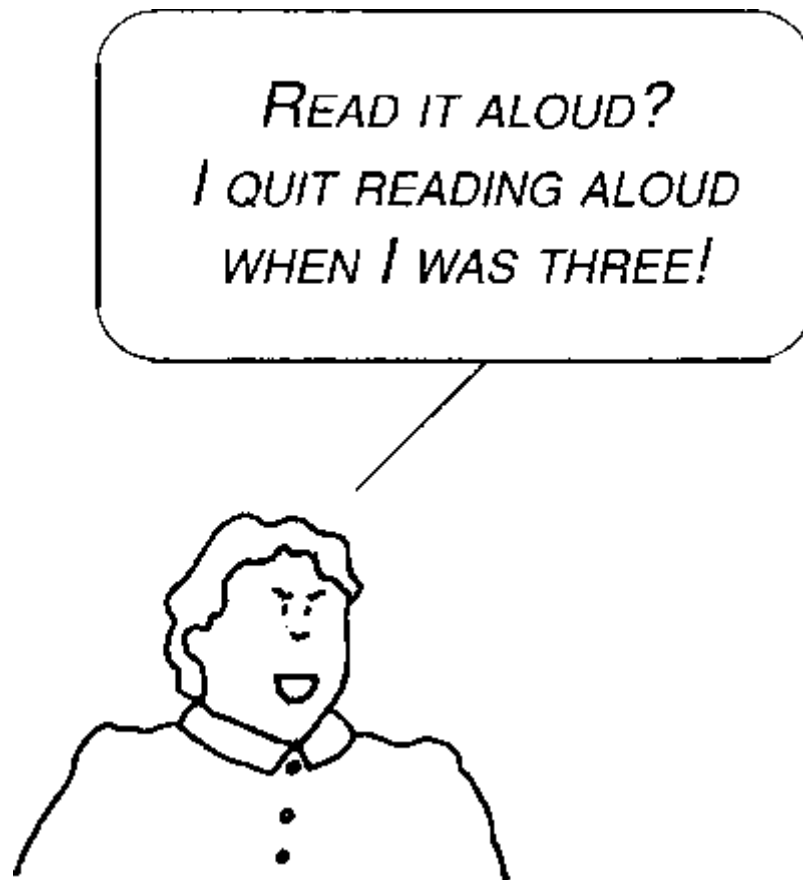

Use contractions such as isn't, don't, and doesn't. Don't hesitate to use phrases that you use in conversation but usually don't write down. Avoid putting words together that start with the same letters and form tongue twisters!

Remember to focus on the spoken word.

After you determine what style appeals to your audience, you may find that you feel awkward writing this way at first. The style may feel contrary to your professional training and values. Some of the comments of professionals attempting this for the first time sound like this.

*"IT BELITTLES MY PROFESSIONAL SKILLS."  
"IT'S AN ABDICATION OF MY  
PROFESSIONAL RESPONSIBILITY."  
"IT'S AGAINST ACADEMIC STANDARDS."  
"IT'S BENEATH ME."*



We must weigh these feelings against the responsibility of helping students learn the knowledge, attitudes, and skills we have to offer. We can view this as a new professional opportunity to deviate from the formal technical writing style and make learning enjoyable.

Whatever your feelings, the objective data from your pilot research with your script will help you balance and justify your style of communication to yourself and your colleagues.

### ***A Summary***

**When creating your script, an essential step is one of attitude and role playing. Some rules of the role are to forget your peers and colleagues. They already know the information. As you create, pretend that you are a student.**

Another method of arriving at a style and tone is to **tape your lectures** or an actual tutoring session with a student. If you teach a laboratory class, tape the session while you are actually using and explaining the specimens.

Later, when you transcribe and edit the tape, you are actually writing the script.

What if you don't have a tape recorder, typewriter, or typist? You can still use the script writing and role playing approach.

**Note:** As mentioned in the preface, the intended audience of this guide is primarily professionals with a scientific or technical background who desire to create an A/I module for student learning.

### ***The frame format***

Keeping to your style, create your story (module, lecture, information) by breaking it down into small units called **frames**.

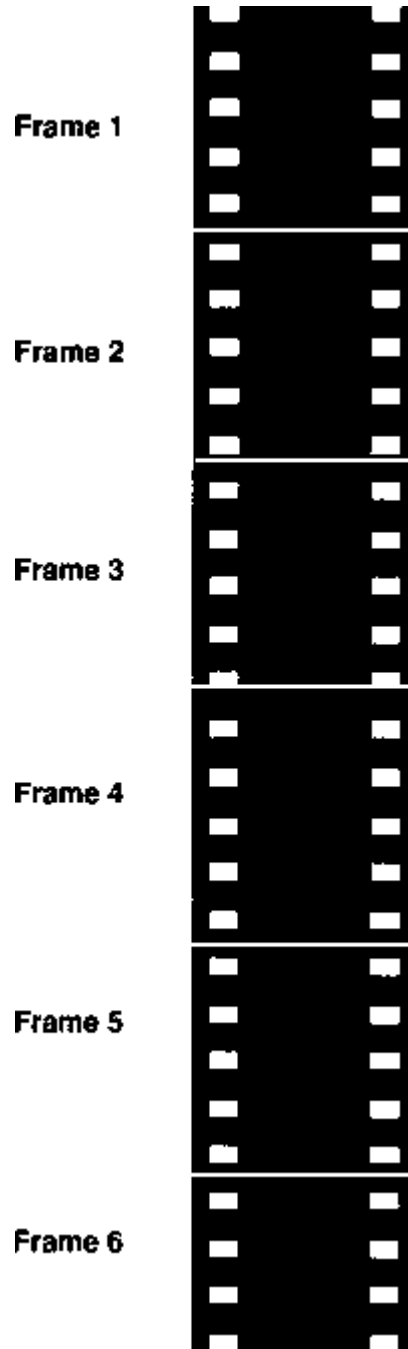

There is nothing magic about the frame format! It's just a convenient method of organizing information. You begin by making frames on strips of paper, index cards, or other materials that you can deal, stack, arrange, and rearrange. Divide each frame into thirds. One space will be for visuals, another for the **written script**, and the third for **comments**, instructions for graphics, sound or other production techniques.

<b>VISUAL</b>	<b>THE WRITTEN SCRIPT</b>	<b>COMMENTS</b>					

Make a row of small blocks horizontally across the top of the comment space. Use these to renumber the sequence if you want to rearrange your story.

For example, we have rearranged this frame from position 6 to 8 to 12 in the process of creating a story.

		<b>6</b>	<b>8</b>	<b>12</b>			
		<b>COMMENTS</b>					

An example frame:

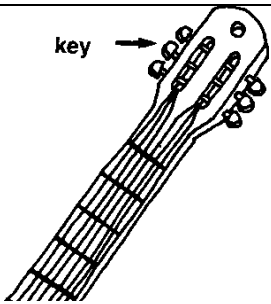
<b>VISUALS</b>	<b>SCRIPT</b>	<b>COMMENTS</b>					
	<p>Tune a guitar string by twisting the <i>keys</i> which are attached to the strings.</p> <p>By twisting the <i>keys</i>, the strings will be either tightened or loosened making a higher or lower <i>tone</i>.</p>						
		<p>Make strings and frets stand out.</p> <p>Make the keyboard of a different color than top.</p> <p>Accent underlined words.</p>					

It is best to create your story in words first, and then match your picture story as a support element later.

Here is an example of a **script** written in the frame format:



		<b>1</b>					
	Welcome to Module Seven in our series of modules on A/I production.						

		<b>2</b>					
	This module will provide you with information that will help you create the script of your A/I program.						

		<b>3</b>					
	The script is also the blueprint for exposing the learner to content information.						

		<b>4</b>					
	The script is an essential part of a module. It provides the basis for both the written and oral communication,						

		<b>5</b>					
	and for applying learning techniques.						

		<b>6</b>					
	It also forms the backdrop for visual communication.						

Of course, we have just repeated the introduction of this chapter using a framing technique. Notice that we have broken the introduction down into 6 frames. Each frame focuses on some important aspect of the script.

You continue to write your script in this manner.

*Editing the number of frames*

As you use frames to tell your story, you will discover that presenting your modules in the frame format also has limitations. One of these is the number of frames that will fit into a slide tray for viewing. Most popular slide trays hold 80 or 120 slides.

For management purposes, it is best not to split modules into two slide trays. Therefore, keep your story within the maximum limits of 80 frames if possible at all, or no more than 120 frames. Since our introduction example already used up 6 frames, it would be better to save some of these frames for more important content information. **Remember, limit your story to 80 or 120 frames.**

Here's an edited version of our 6-frame script.

		<b>1</b>					
	Module Seven will provide you with information to create the script, an essential part of your A/I program.						



		<b>2</b>					
	It provides the basis for both your written and oral communication, for applying learning techniques, and forms the backdrop for visual communication.						

Note how we edited the 6-frame example we had earlier. The script from frames 1,2, and part of 3 are now condensed into frame 1. Frames 3, 4, 5, and 6 are condensed into frame 2 of the sequence.

*Editing time/frame*

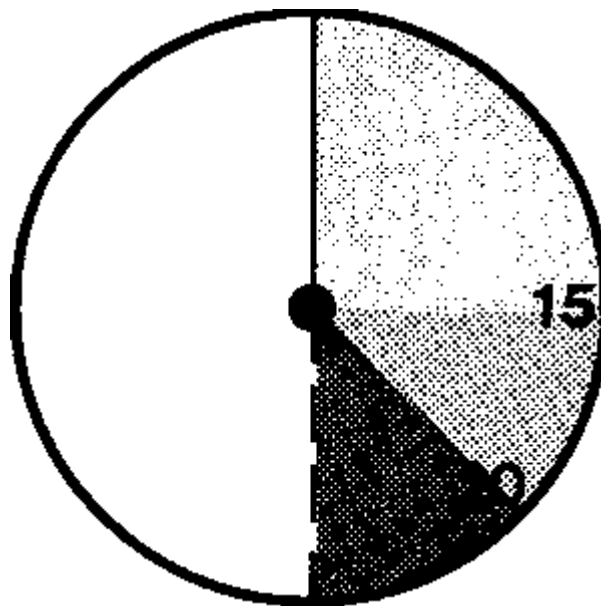

script or narration time per frame

Script time per frame should run from **15 to 20 seconds**, 30 seconds on rare occasions. One reason that modules are very effective is that students are involved with adjusting to the frames and story movement. When there is too much talk per frame, they are on the screen too long, and the student becomes passive.

To check on the length of narration per frame, read the script slowly out loud and record the number of seconds. If it is longer than 15-20 seconds, simplify your thoughts, reduce the number of words in the script, or break it into extra frames.

***Organizing information***

One of the creative challenges of developing A/I programs is trying to organize information into sequential frames, putting content in the right order, keeping the script within the time limits, and limiting the presentation to 80 frames. Super-organization and prioritizing of material are essential.

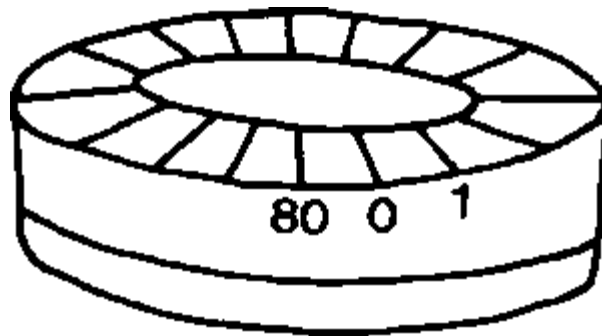

Here are some tips on how to do it.

- Some people first develop an outline and then write the story from the outline.
- Others write materials in the form of a lecture and then translate the lecture to frame format.
- Still another method is to create the narration or script directly from memory as you progress.
- Another option is to break a lecture into instructional objectives and then construct frames from the objectives.
- We have mentioned that you can tape lectures and work from them.
- If there are many introductory vocabulary words, you can create your story from a prioritized list of vocabulary words.

**Note:** There isn't really any correct method; use whatever method works best for you based on your past experiences.

### *The storyboard*

One approach that has been devised is called a **storyboard**. It is similar to an activity calendar. It is a large board made up of numbered squares. You also can use a table top or floor.

You can fold the frame strips so that the narration is on the outside so that you can see it. Then you can *deal the strips like cards* on the storyboard, table, or floor. You can pin the frames to each square in the order that you want the material to appear. With the narration on the outside, it will be easy to see if you have them arranged in the right order. You can also rearrange them easily. The storyboard gives you a good overview of the story.

Start with an outline of the story. Sequence the outline on the board and number each square with Roman numerals. Then address each outline point in sequence and add squares of paper containing the subpoints or tasks. Put these on the board in the desired sequence.



THE STORYBOARD					
1	2	3	4	5	6
7	8	9	10	11	12
13	14	15	16	17	18
19	20	21	22	23	24
25	26	27	28	29	30

After the main outline point, you may have to number and remove the squares because the whole story will not fit on the board. Finally, break each subpoint into frames. Place these on the board in the order set by the outline.

### **Summary**

#### **Steps in storyboarding:**

1. Write outline on paper squares.
2. Pin on storyboard.
3. Observe sequence.
4. Rearrange and confirm sequence.
5. Number slips and remove.
6. Write subpoints associated with Roman numeral I of your outline.
7. Repeat steps 2-5.
8. Write information frames associated with each subpoint.
9. Repeat steps 2-5.

Now is a good time to edit the length of your script to 80 or 120 frames. Just staple or pin frames together in sequence; then rewrite the story to include all the frames of outline points, subpoints, and associated frames not to exceed 80 or 120.

### **Feedback frames**

Periodic processing and recall of information assists retention. To help students learn through review, try to highlight the major points in a module by reserving some frames for review or feedback.

Construct a feedback exercise every 16-20 frames. This will

- organize and separate concepts,
- give a break or pause in instruction or a stopping point in the program,
- provide reinforcement through drill and practice, and
- involve students in active learning.

Be sure to reserve 6-8 frames for feedback questions or review and about 4 for introduction, ending, and credits. That reduces the program to 70 slides for content.

**Progressive disclosure** will also use up frame space. More on this later.

No matter which approach you use in creating your story or program, the storyboard is an invaluable tool in getting an overview and organizing the program.

## REVIEW FRAME

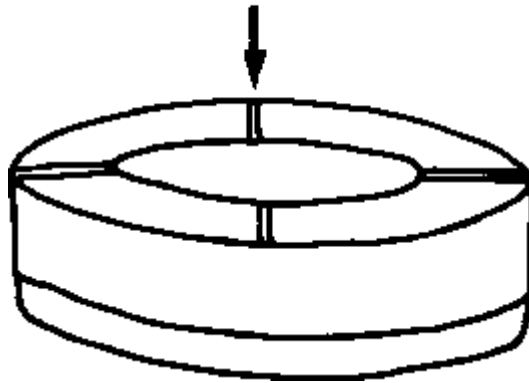

### *Transitions*

Transitions are crossover words or phrases that tie concepts together. After cutting and editing your frames to achieve the proper length for your program, the right number of frames, and the right length of time/frame, your script will sound disjointed.

### **Concept 1**

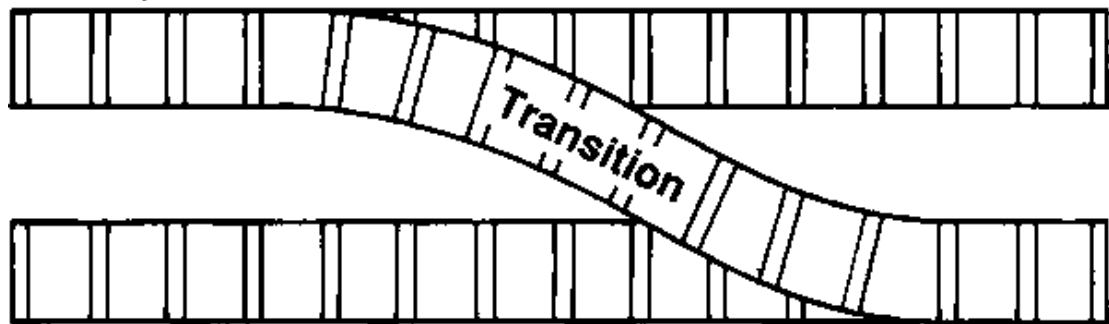

### **Concept 2**

When rewriting the narration, use transitions to smooth the verbal flow and tie frames together. Transitions also provide a way to repeat information. Here are a few:

- subsequently
- because of
- finally
- accordingly
- for example
- however
- in addition to
- is divided into
- is made of

In creating our module so far, we have worked only with verbal information. The next step is to create and correlate visuals to accompany the verbal script. We'll do that in the next chapter.

In the meantime, let's review the material presented in this chapter. The following feedback exercise will help you!

**Feedback exercise**

- In your opinion, is there any validity to the proposition that

A significant amount of scientific and technical learning materials is written for peers rather than for students?

- What process can help the scriptwriter focus on the intended audience when writing student learning materials?

- Match the writing tone guideline with the intended goal.

- |                      |                                |
|----------------------|--------------------------------|
| _____ informal       | A. Promotes active mode        |
| _____ humor          | B. Relaxes audience            |
| _____ questioning    | C. Provides mental pauses      |
| _____ conversational | D. Aids learning by repetition |

- What is an objective method of ascertaining the right writing style for your intended audience?

- What are the 3 parts of a frame format and what is each used for?

1. \_\_\_\_\_
2. \_\_\_\_\_
3. \_\_\_\_\_

- In the initial development of an A/I program, state a rule of relationship between visuals and script.

- Check the numbers below that indicate the maximum number of slides an A/I program should have to keep within the constraints of a small slide tray.

- |          |           |          |
|----------|-----------|----------|
| _____ 60 | _____ 70  | _____ 80 |
| _____ 90 | _____ 120 |          |

- To keep students from becoming passive, what is the suggested length of narrative time per frame? (Encircle one.)

- 5-10 seconds
- 7-15 seconds
- 10-15 seconds
- 15-20 seconds

- Check which methods you prefer to use in generating your script.

- \_\_\_\_\_ Outline
- \_\_\_\_\_ Lecture narrative
- \_\_\_\_\_ Direct frame narration
- \_\_\_\_\_ Instructional objectives
- \_\_\_\_\_ Vocabulary
- \_\_\_\_\_ Storyboard
- \_\_\_\_\_ Tape recording

- Why has the storyboard evolved as a mechanism for generating an A/I program?

### ***Answers to feedback exercise***

- No correct answer - it's your opinion
- Role playing; assuming the role on tape
- B, C, D, A
- Pilot studies of narrative style(s).
- Visuals - slides  
Script - narrative  
Comments - information, direction to artists, yourself, etc.
- Forget visuals, concentrate on narrative of teaching principles.
- 60,70,80
- 15-20 seconds
- No correct answer; individual preference
- Facilitates holistic approach to organization, sequential arrangement

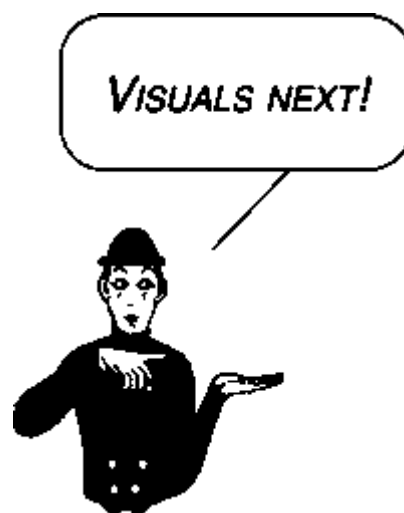

### ***References and information of interest***

American Association of Agricultural College Editors (1976) Communications handbook. 3d ed. Interstate Printers & Pub., Danville, Illinois.

Dwyer F (1972) A guide for improving visualized instruction. Learning Services, Pennsylvania State University, State College, Pennsylvania.

Eastman Kodak Company (1973) Legibility - artwork to screen. Rochester, New York.

Eastman Kodak Company (1972) Effective lecture slides. Pamphlet S-22. Rochester, New York.

Ertel R E (1979) The multi-image production. WTI Corporation, California.

Friesen P A (1973) Designing instruction. Miller Publication, Sta. Monica, California.

Frio A S (1977) Preparation and use of audiovisual communication media and materials. Department of Development Communication, University of the Philippines at Los Baños, Laguna, Philippines.

Grabow J, Wesley F (1982) Resources for teaching. NACTA J. 26(l):27-28.

Kemp H E (1968) Planning and producing audiovisual materials. Chandler Publishing Co., Scranton, Pennsylvania.

Minor E (1978) Handbook for preparing visual media. 2d ed. McGraw-Hill, Inc., New York.

Minor E, Frye H (1977) Techniques for producing visual instructional media. McGraw-Hill, Inc. New York.

Salmons N (1959) Planning and producing visual aids. National Photographer 10 (8 & 9) and Kodak (Pamphlet S-13). Rochester, New York.

Xuan Vo-Tong (1976) Visual aids, International Rice Research Institute workshop on field experiments (VII-4). International Rice Research Institute, P.O. Box 933, Manila, Philippines.

## **CHAPTER 8. Visuals**

### **Prospectus**

This chapter will help you create visuals for your A/I program.

### **Rationale**

- Our A/I program uses visuals in both nonverbal and verbal learning.
- Visuals help students understand, retain, and remember information by uniting words with pictures (See Chapter 4).
- Visuals promote understanding in all of the learning domains.

### **Objectives**

After the last few chapters, objectives may seem redundant. However, they provide a focus, and with chunking, can

- give a shorthand outline of the material
- measure the extent of your knowledge before you read the material, and
- provide a quick reference source.

At the end of this chapter, you will be able to

- List 6 situations where visuals assist learning.
  1. magnifying/reducing
  2. simplifying the complex
  3. instructing through a visual vocabulary
  4. motion demonstration
  5. communicating in the affective domain
  6. encouraging right brain learning

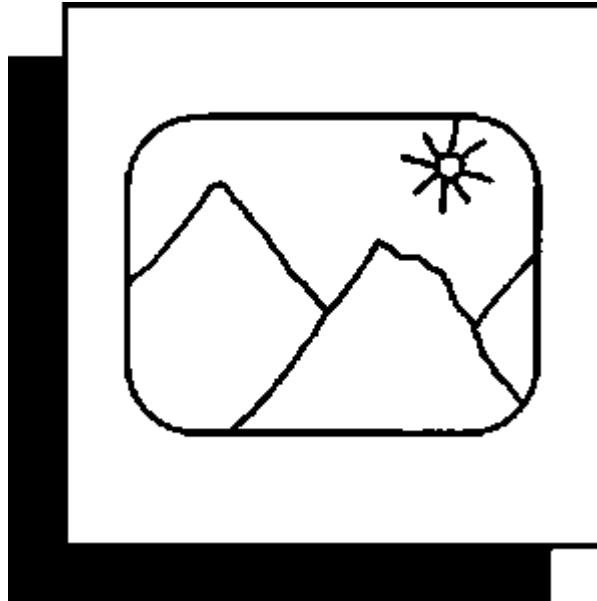

- Define an A/I slide

35 mm film mounted on a 2 × 2 in frame

- Describe the 4 types of visuals used in A/I modules.

word slides  
graphics  
photographs  
combinations

- Give 5 reasons why titles are important on all types of visuals.

1. condensed verbal code
2. advanced organizer
3. cognitive bridges (verbal/visual)
4. subsumers
5. continuity of concepts

- Describe a task analysis of storyboarding visuals.

association of narration and visual  
conceptualize visual  
document visual and unite with narrative  
search for ready-made visuals  
create your own visuals

- Define visual style

consistent pattern of colors, contrast, and visual arrangements

- Recall 2 instances where word visuals are advantageous.

introducing abstract concept that doesn't provide convenient visual reinforcement  
itemizing information



- List 3 rules of lettering.

use plain bold lettering  
make discretionary use of capitals  
avoid vertical lettering

- Recall 4 principles of letter spacing.

15-20 word limit (25-30 data)  
abbreviated style  
capital letter size or larger space between lines  
maximum of 9 lines per slide

- Explain progressive disclosure.

sequential concept building

- Define a graphic slide.

diagrammatic or illustrative drawing of information

- Compile a list of mediums and techniques used in graphics.

pencil  
ink  
crayon  
chalk  
water color  
paper cut-outs  
direct use art (clip art, collage art)  
dyes

- Relate and describe 4 elements of composition layout.

balance  
emphasis / contrast  
harmony  
color

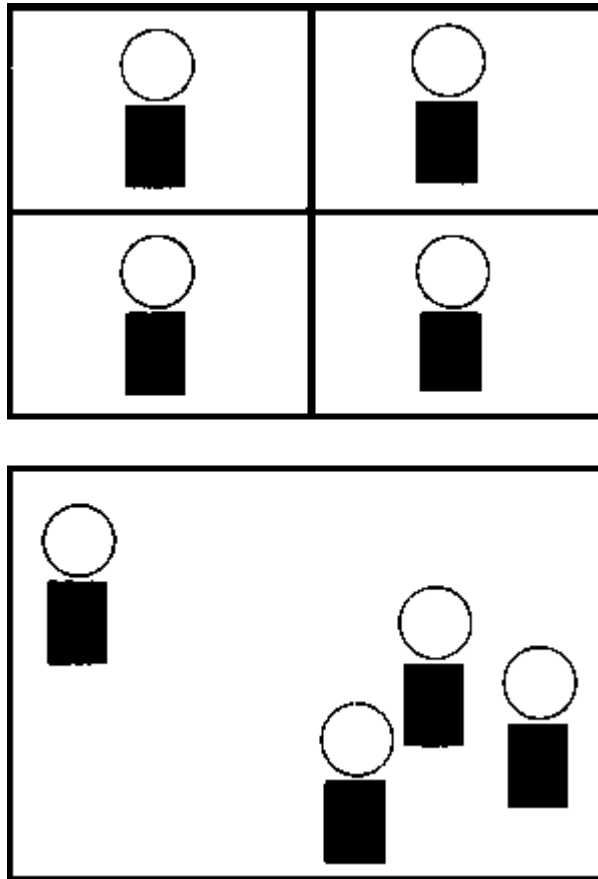

- Discuss 4 components of emphasis and contrast.

background  
grouping  
separating  
integrating

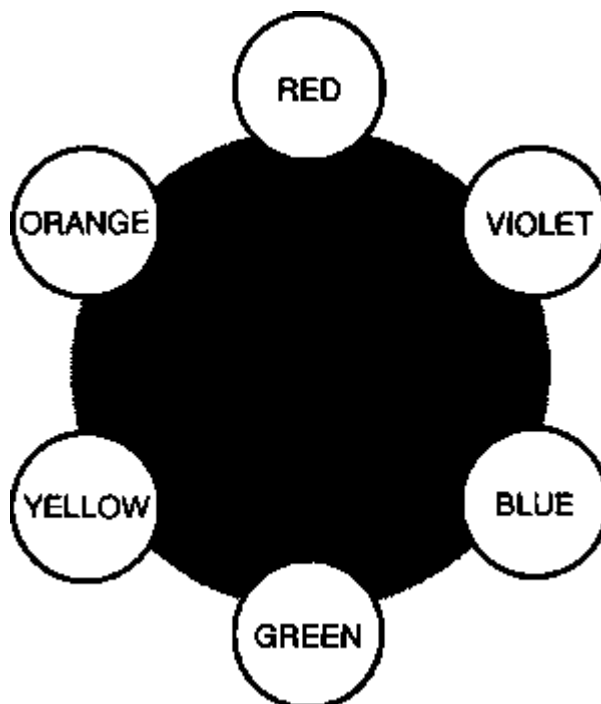

- Discuss 6 principles in communicating with colors.

2-3 colors best  
 cool colors -> recede  
 warm colors -> emphasize  
 adjacent use:

similar = blend; NO  
 light/dark = contrast; YES

light colors on dark increase visibility

- Define 4 color systems.

self-tone  
 complementary  
 analogous  
 triad

- Recall the areas and standard dimensions for preparing graphic copy.

outer area = 10 × 12 in (250 × 300 mm)  
 neat area = 7 × 10 in (178 × 250 mm)  
 information area = 6 × 9 in (150 × 225 mm)

- Explain the Rule of Seven.

rule for readability:

length of longest line × 7 = viewing distance

- Recall principal considerations of using photographic slides.

detail  
 composition

- Restate a simple rule concerning photography.

film is cheap  
 time is not

- Recall 5 rules of labeling slides.

concise/simple  
 5 words maximum  
 special focus on primary visual  
 precise association of verbal/visual indicators (lines, etc.)  
 titles unify labels and make a concept map

- Describe the equipment necessary to produce slides.

camera  
 lens  
 flash  
 tubes  
 tripod  
 release cable  
 film  
 copystand

### ***How visuals assist learning***

The next step in creating your A/I program is to produce key word (verbal) and/or pictorial (nonverbal) visuals to accompany **each frame** of your program.

Visuals are an exciting creative opportunity to help students learn. They use pictures to amplify, clarify, and reinforce the verbal narrative of your program.

We learn in two major ways. **One is by sound, the other is by sight.** Visuals relate to the world of sight. Research shows sight contributes to more than 80% of our learning. Sight lets us read words and distinguish figures and colors.

Visuals assist learning in 6 areas by

- magnifying or reducing the size of a subject so that it will fit into a classroom teaching situation (example: microphotography).
- simplifying a complex concept (example: diagram of nitrogen cycle).
- showing visually as well as verbally what the student needs to learn (example: morphology).
- showing motion or time lapse (example: dissections).
- showing verbal concepts.
- encouraging whole brain learning by requiring right brain participation (see Chapter 4).
- showing color changes (example: plant sickness).

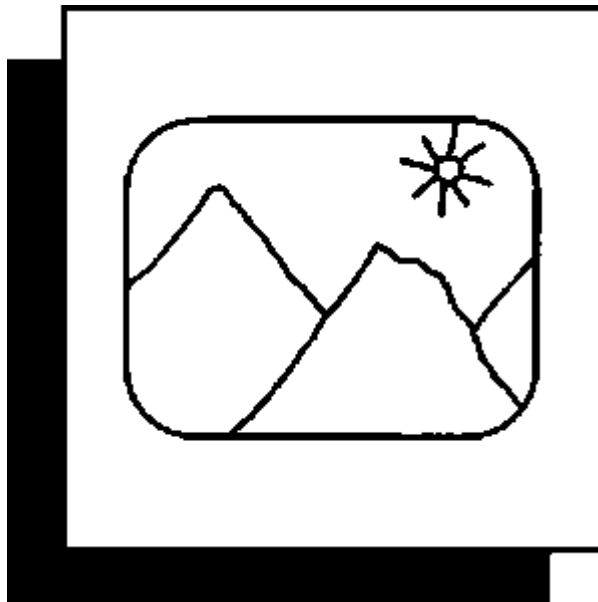

In this chapter we will emphasize slide production.

However, you can use the same principles to produce all types of visual media.

You can create pictures

- on paper
- on a transparency, as a slide, or filmstrip
- on a video tube.

Let's define a slide as a 35 mm transparency in a 2 x 2 inch frame to be projected on a screen by a slide projector.

*Note:* The creation of visual aids as learning devices is a vast subject area, a complete discipline. We offer the following simple guidelines to help you create slides for an A/I program.

**Visuals and the storyboard**

A/I programs use 4 basic types of visuals:

1. title or word frame slides
2. graphics
3. photographs
4. combinations of 1 and 3, or 1 and 2

Now for the creative challenge of visuals! You have written your script on frames and put it in order using a storyboard. So far you have not put any visuals with your script.

		sequence
	SCRIPT	

Now, one frame at a time, using your script for cues, **visualize your program**. Decide which type of visual, words, graphics, or photographs will best illustrate each frame. As you plan, draw rough sketches in the visual third of each frame and make corresponding notes in the comments section.

VISUAL	NARRATIVE	COMMENTS
<p>Step 2 MESSAGE</p>  <p>SOURCE</p>	<p>Step 2 in which the source sends a message.</p>	<p>Highlight message component graphics</p>

Be sure to use simple one- or two-word titles and subtitles as headings at the top of each frame.

They are important because titles

- condense the script,
- connect verbal and visual concepts,
- organize the information around key words or anchors (subsumers-see Chapter 3), and
- give continuity and organization to the

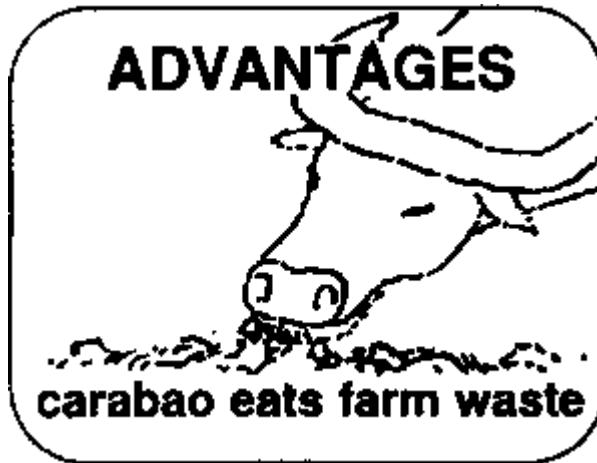

### *Ready-made visuals*

As you plan visuals to support your script, try to remember slides or photographs from your existing collection. Since you don't have to work to create them, these are **ready-made visuals**.

Perhaps you can find pictures or diagrams from books or magazines. If so, either attach the picture to the frame, or make a note on the frame about the visual to help you begin to unite visuals with the script.

If visuals are not readily available from your own sources, attach a note describing what you need. Then look through library books, colleagues' slide files, and other resources to find the materials. **If possible, obtain visuals from ready-made sources.**

Be sure to heed the copyright laws. Most government materials do not possess copyright restrictions. Often a note to the publisher will obtain a release for local instructional purposes. Regardless of the source, give credit for any visuals you use.



### *Create your own*

However, if off-the-shelf pictures are not available, then make your own. Perhaps you have plans to publish and distribute your program. If so, it is better to make your own visuals.

### **Visual style**

Establish a visual style by using a consistent pattern of colors, contrasts, and design. Some variety is desirable, but large swings in style may make your program seem bizarre.

Consult with artists and colleagues and get feedback from pilot surveys with students. Pretend that you are a student. What visuals would best explain the script?

If you have the resources, employ an artist to create visuals. However, many times these resources are not available, so we offer these guidelines to help you produce your own visuals.

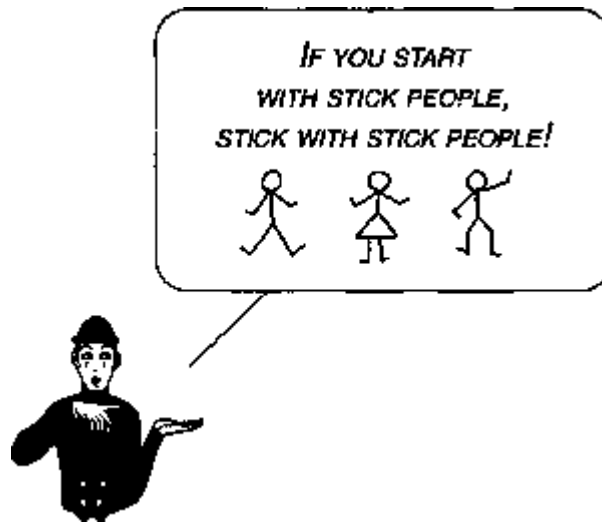

### ***Types of visuals***

#### *Title or word slides*

A book uses titles, headings, and subheadings to organize and introduce concepts. The same principle applies to the moving book of frames in your module. Also, we can use word slides when it is difficult to explain abstract concepts with pictures. Word slides also help us with review and summary information.

Whenever possible, reinforce the script with visuals. If more than 30% of your frames become word slides, perhaps you should reject the slide format and use written handouts or a tape.

1. **Lettering.** Word slides need good lettering. How do you begin?

- Select plain bold gothic letters without serifs or tails.
- Use lowercase letters which people can read faster than uppercase. Use capitals for emphasis and to lend variety.
- Avoid vertical lettering.



2. **Lettering sources.** What types of lettering materials are available?

- The most common is the typewriter.
- Burnish or rub-on letters of various sizes are available at art stores.
- Removable plastic letters
- Cut-out letters
- Hand lettering
- Lettering machines such as the Leroy and instant print. **Consult an art catalog. Ready-made letters are convenient.**

3. **Spacing letters.** In spacing letters, remember these tips:

- Limit each slide to 15-20 words (25-30 for data) and include no more than necessary.
- Allow a space between lines at least the size of a capital letter. Use more space if there is room.
- To prevent crowding, never put more than 9 lines on a slide. This allows 2 lines for a title and subtitle and 7 lines for an itemized summary. If you need more than 7 lines, use 2 slides.

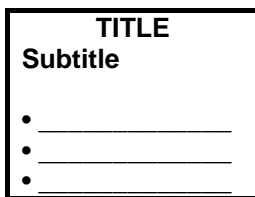

See pages 12-14 for an example of progressive disclosure.

4. **Progressive disclosure.** Progressive disclosure means to add each new point to those already presented. For example, if you want to present 4 points, the title and subtitle appear on slide 1, the title and subtitle plus point one on slide 2, the title and subtitle plus point one and two on slide 3, and so on until all points are covered.

As you disclose each new point, highlight it by using a different color. For example, the title and subtitle on slide 1 may appear in red. On slide 2, the title and subtitle could be green, and point 1 a contrasting color like red. On slide 3, the title, subtitle, and point 1 could be green and the new point 2 red.

You can use progressive disclosure with graphics as well as with word slides.

*Graphics*

Graphic slides include charts, graphics, cartoons, or any diagrammed drawings that instruct without using an actual photo. Depending on the style you want and your artistic ability, you can make them simple, detailed, or very realistic. In many cases, graphics are more effective teaching aids than photographs.



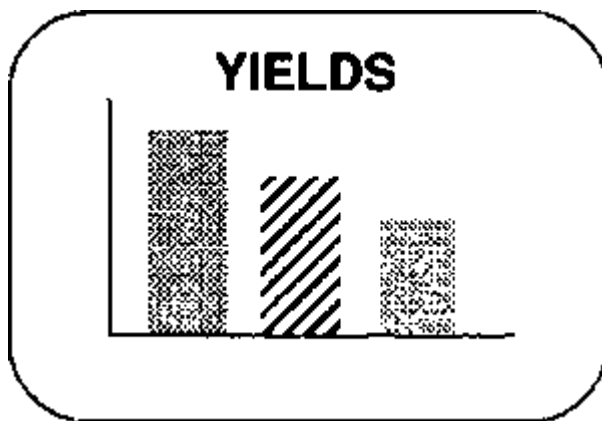
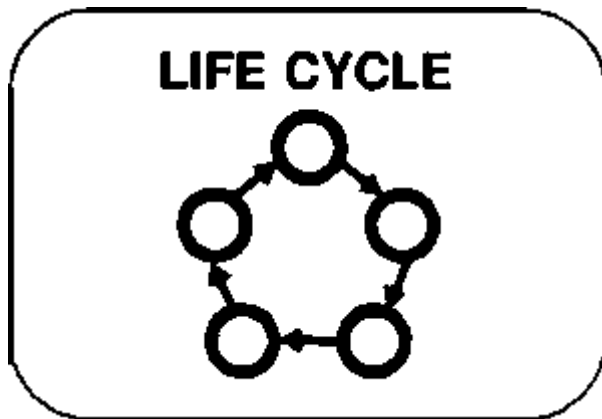

1. **Mediums and methods.** Try these to create your own graphics.

- Use colored pencils, crayons, chalk, or pen and ink for line drawings and fill-in areas.
- With a little practice, watercolor is another fill-in medium that is fast and easy to use.
- To produce special effects, make cutouts from colored panels, velour, gummed corrugated paper, or plastic sheets.
- Rolls of adhesive-backed paper and plastic tape of various widths and colors are available for making lines and shading graphic art.

For example,

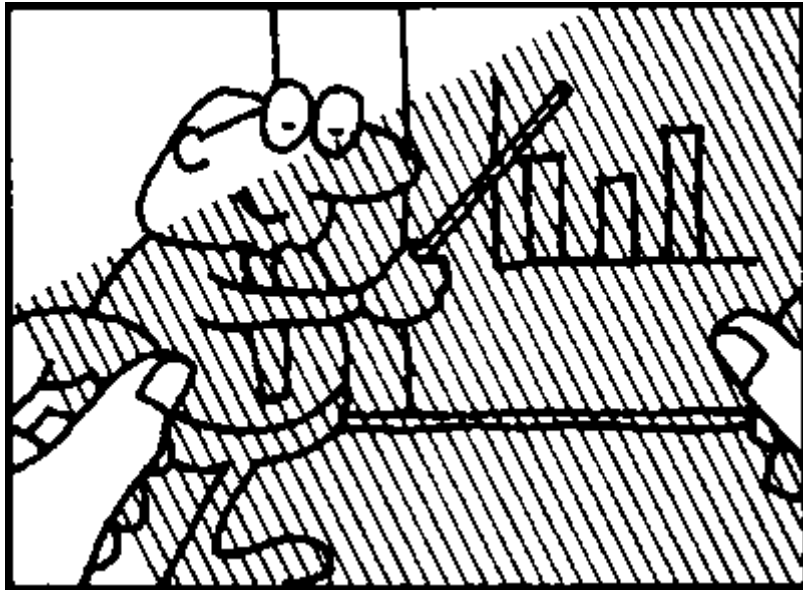

a. Make a line drawing.

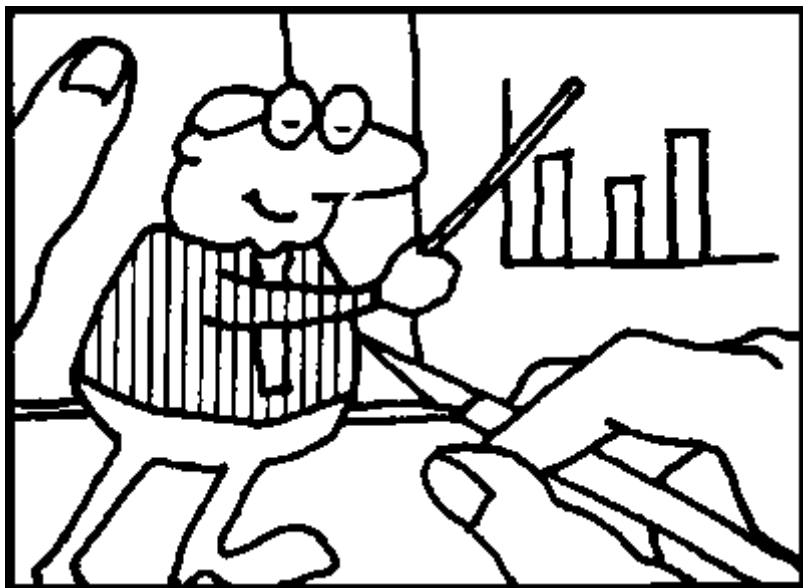

b. Cover with shading film, and cut around lines.

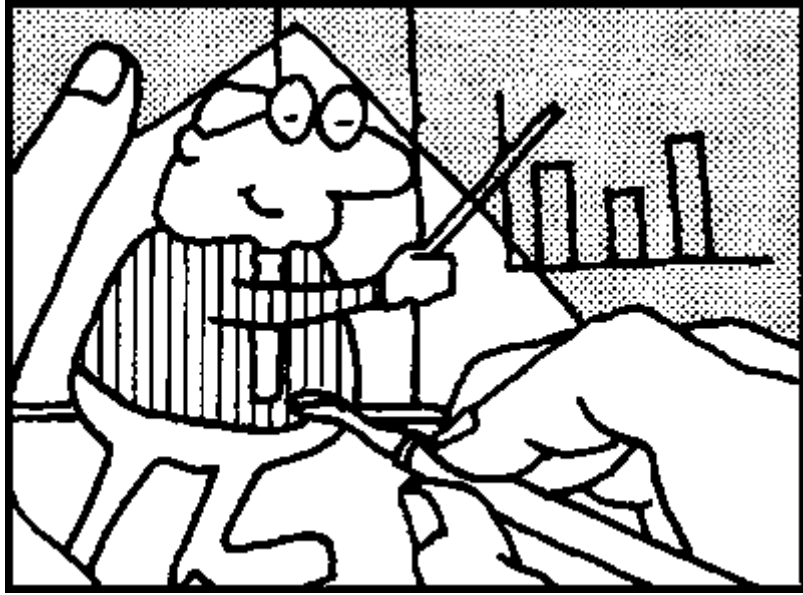

c. Rub with a burnisher or cloth to make the shading film stick to the line drawing.

- You can combine shading film with “direct use” images that eliminate the preparation of line drawings. One type is called **clip art**. You can buy a book that contains ready-to-use line images, symbols, and borders for every practical subject. You can cut out the image and paste it onto the design you are creating. To save the book, you can also trace or xerox it and use the copy. Be sure the copy is clear.

People from other countries should try to modify clip art visuals so that they look like people or objects from their own countries. This will add a great deal of credibility to their modules.

Other direct images are available in acetate, module form, and dry transfer acetate medium.

You can also use another type of art called the **collage** technique, where you cut parts of pictures out of magazines and reassemble them to portray a new concept.

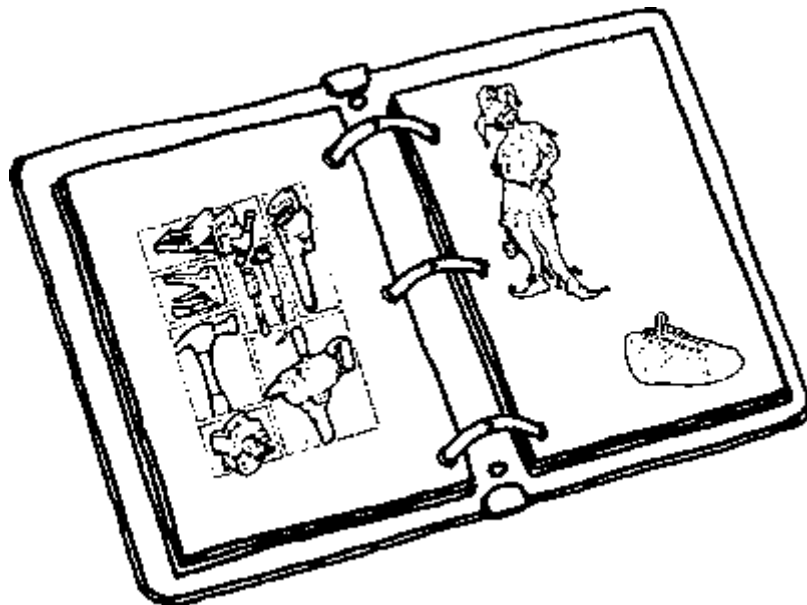

2. **Layout and composition.** The way you arrange images in the visual space can help communicate your messages more clearly. We call this arrangement *composition*, and it has 4 important elements: **balance, emphasis and contrast, harmony, and color.**

- Balance - If you divide your slide into quadrants, **balance** refers to the way you distribute items within the quadrants. Balance may be formal, distributed equally, or informal with an unequal distribution. Informal balance is much more normal and pleasing to the eye.

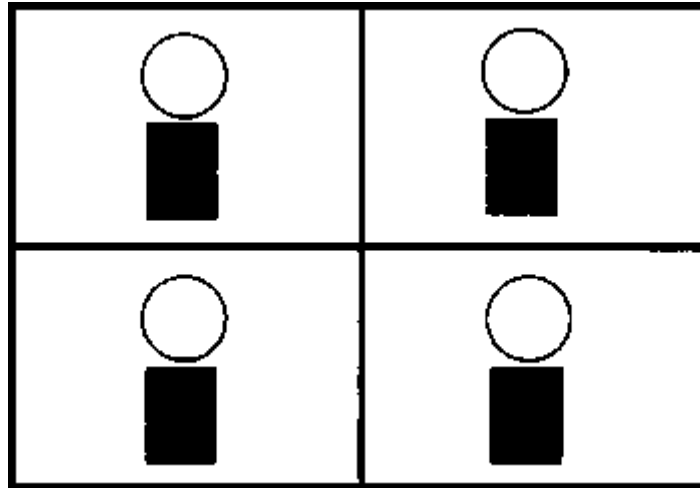

**FORMAL BALANCE**

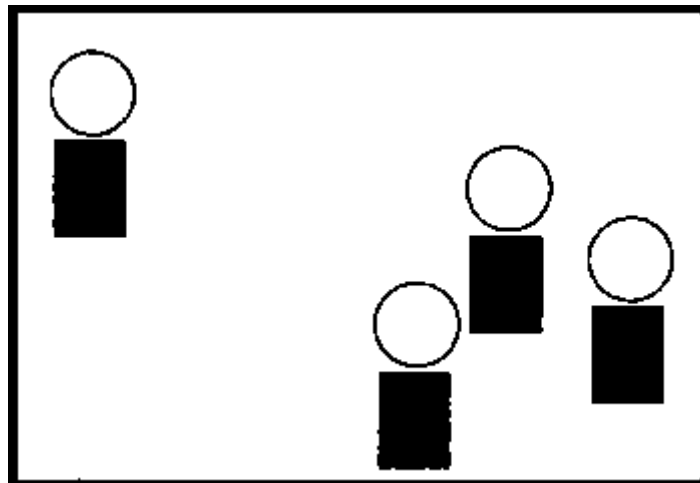

**INFORMAL BALANCE**

- Emphasis and contrast - There are 4 major ways by which you can **emphasize and contrast** elements within your slide. You can adjust the
  - a. background
  - b. grouping
  - c. separation
  - d. integration

The **background** of a slide is important. It forms the backdrop and contrasts with the other images.

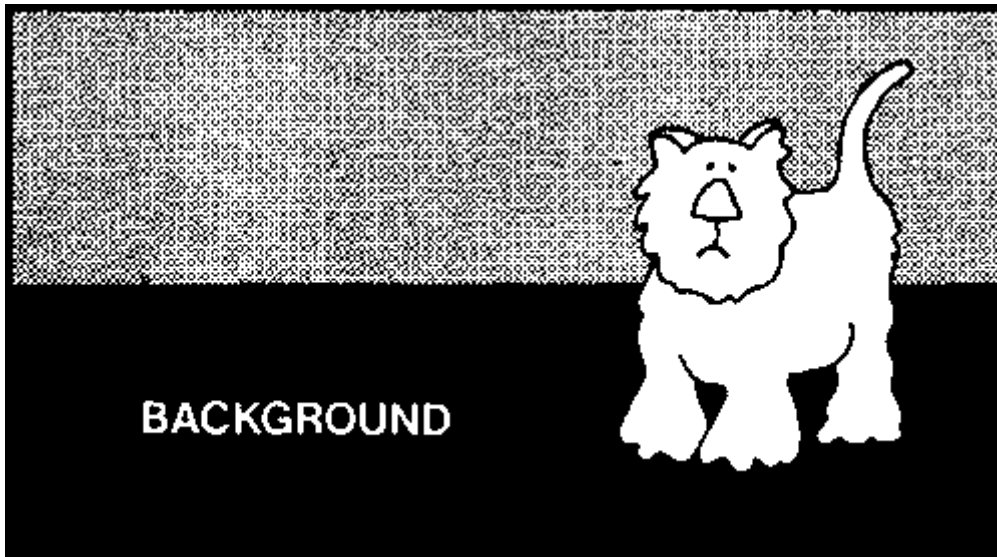

You can **group** items together to show proximity, similarity, continuity, closure, or common movement.

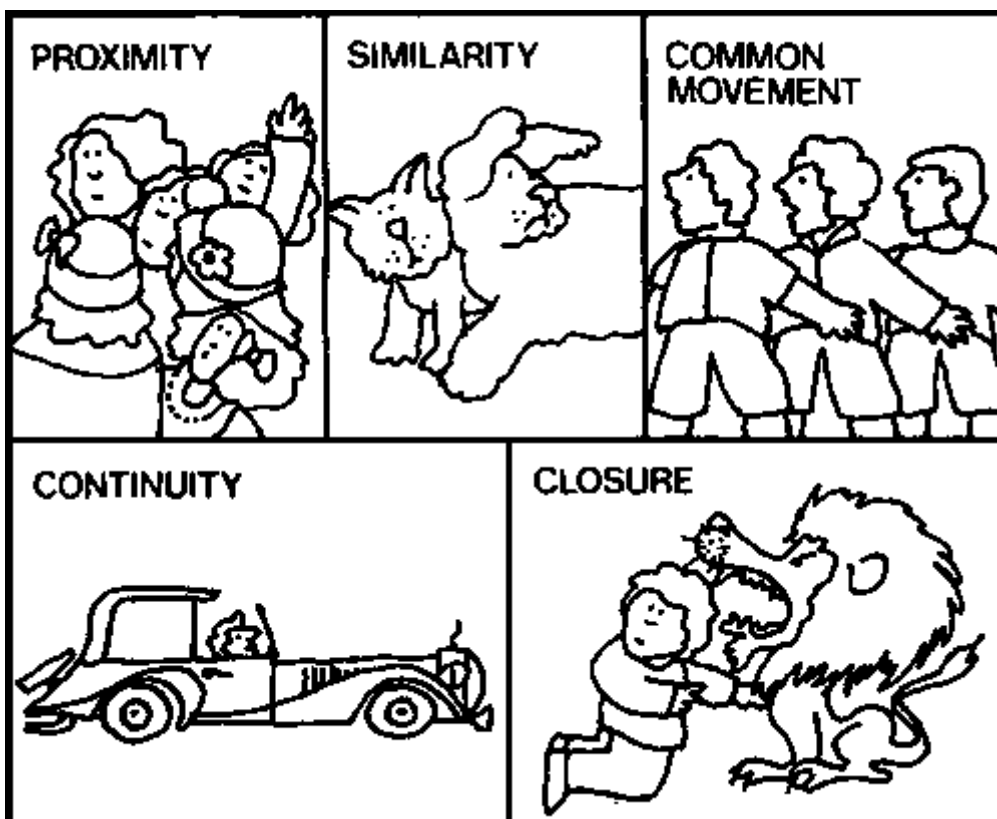

You can also use **separating techniques** to show visual elements as separate parts. To separate items you can contrast their size and shape. You can change their depth, figure-ground, or overlap them.

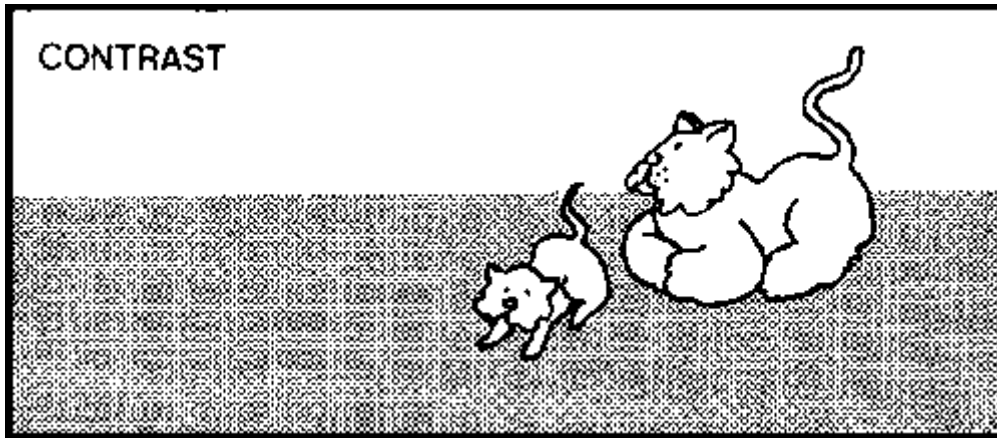

**Integrating techniques** combine several individual elements into a single concept such as a landscape or complete picture.

- Warm colors, such as red, yellow, and orange, emphasize subjects.
- Dark colors that are next to each other are difficult to see.
- Dark and light colors next to each other are easy to see.
- White letters on a dark background are very easy to see.

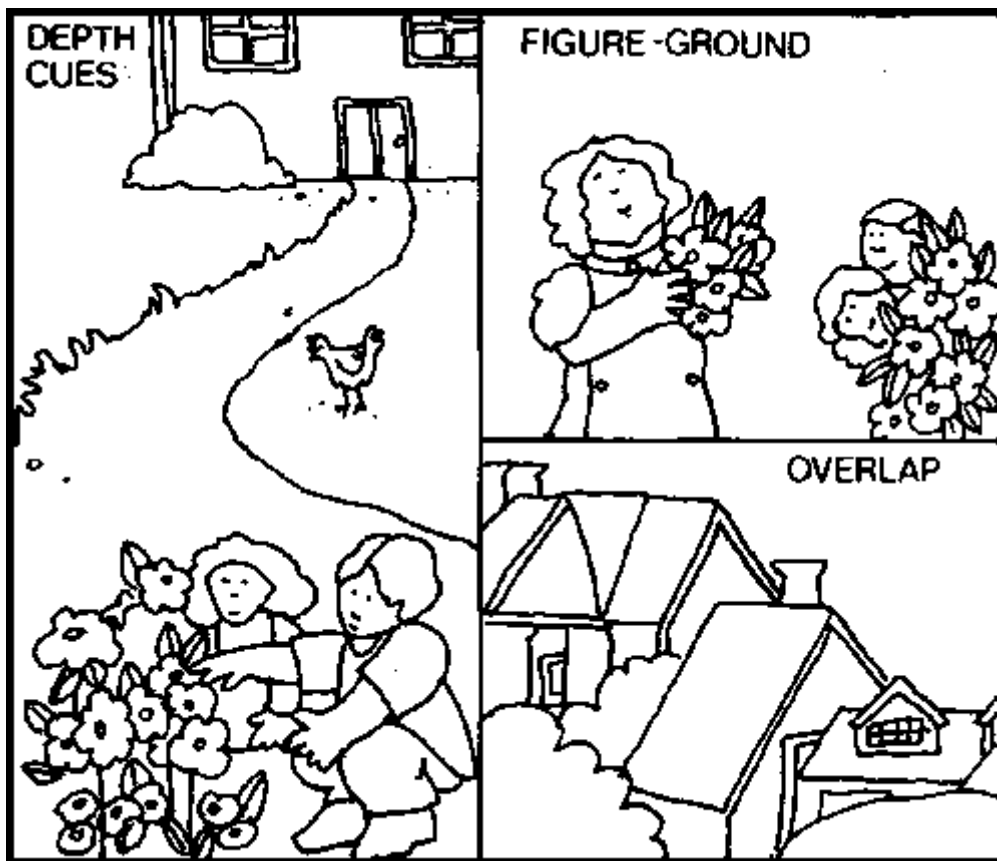



You can easily **change black and white negatives to color**. Add a drop of vinegar to food coloring and swab it on the entire negative with a piece of cotton. By using a tiny brush and a magnifying glass, you can also paint parts of the negative with different colors.

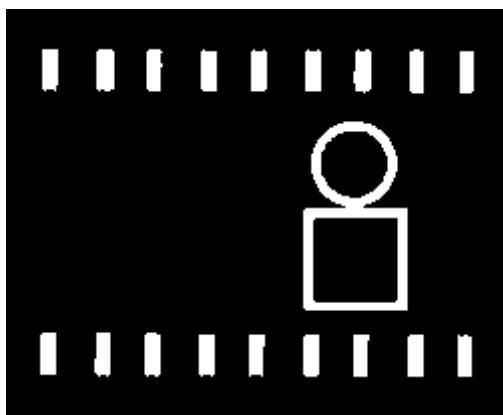

You can also buy special gels and dyes for this process, called Webster photocolors.

- Harmony - An effective slide has all the visual elements of lettering, color, material, texture, and style blended together to show a concept.
- Color - Color is an important component in graphic composition. Colors affect size, shape, contrast, attitudes, and texture of visuals and give nonverbal cues in learning (See Chapter 1, The Communication Process). Colors are also useful diagnostic tools of science.

Pay attention to these *color tips*:

- a. Use only two or three colors in a visual.
- b. Cool colors, green, blue, and gray, recede and are best for backgrounds.
- c. These *color systems* make pleasing combinations:

Self-tone - variations of one color: for example, light, medium, and dark blue

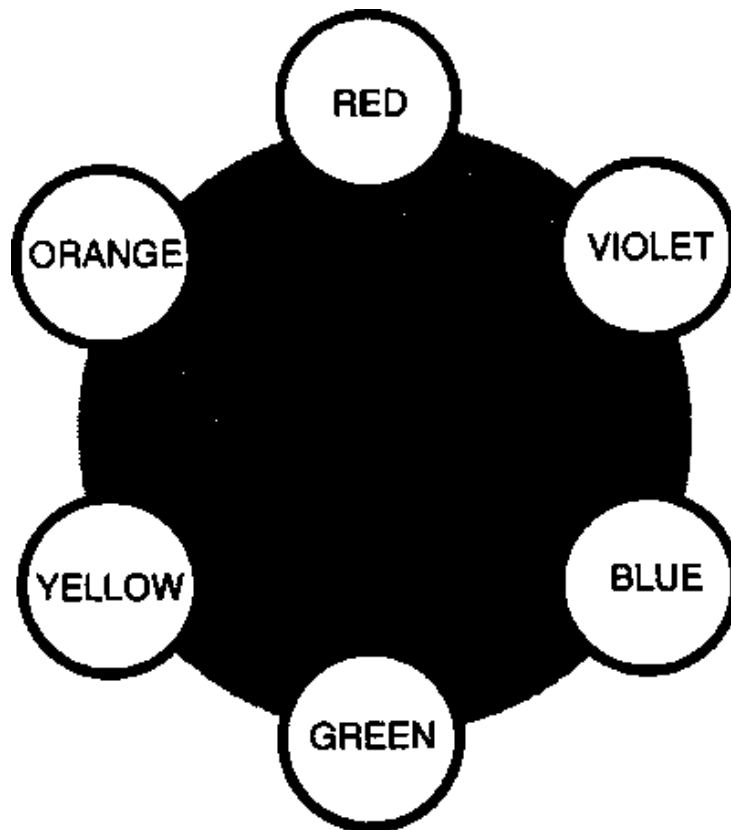

#### THE COLOR WHEEL



Complementary - colors opposite each other on the color wheel.

Triad - 3 colors equidistant from each other on the color wheel: for example, red, yellow, and blue.

There is a relationship between *color and legibility*. Some color combinations make messages  
• easier to read than others. These combinations enhance legibility:



Letters	Background
brown	
green	
blue	white
black	
black	yellow
red	
yellow	black
white	red
white	green

These are only general guidelines. Create your own combinations.

### 3. *How to make camera-ready copy:*

- Typewriter copy - You can use a typewriter as a speedy method of making word slides. However, a slide of a standard size paper will *not* work. It will make your slide too crowded and busy.

Here's how to make a typing template for slides. Cut a horizontally rectangular window in the middle of a piece of paper. The dimensions are given below. Draw a solid line along its perimeter. Lay this over your typing paper and type your copy within the window.

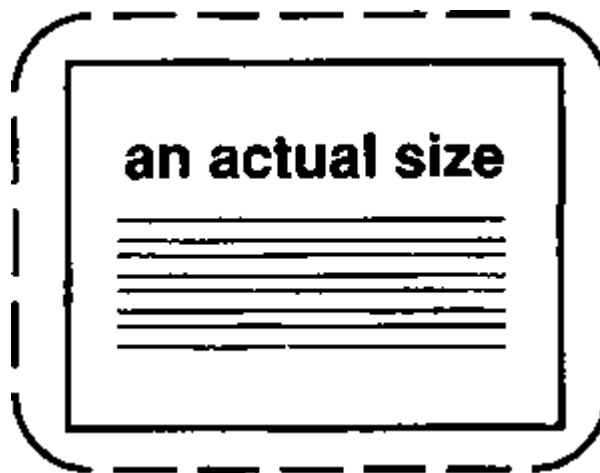

All copy should fit within the inner *solid line*.

The camera viewfinder should just include the *dotted line*.

- Standardizing copy - Most 35 mm slides have a height-to-width ratio of 2:3 in a horizontal format.

Therefore, try to **standardize** the size of all your artwork to make the photocopy process easier.

Here are recommended dimensions:

Area

- 250 × 300 mm is an outer area used for handling, production notes, etc.
- 178 × 250 mm is a good or safe area for the photograph. It should include the background.
- 150 × 225 mm is the information area.

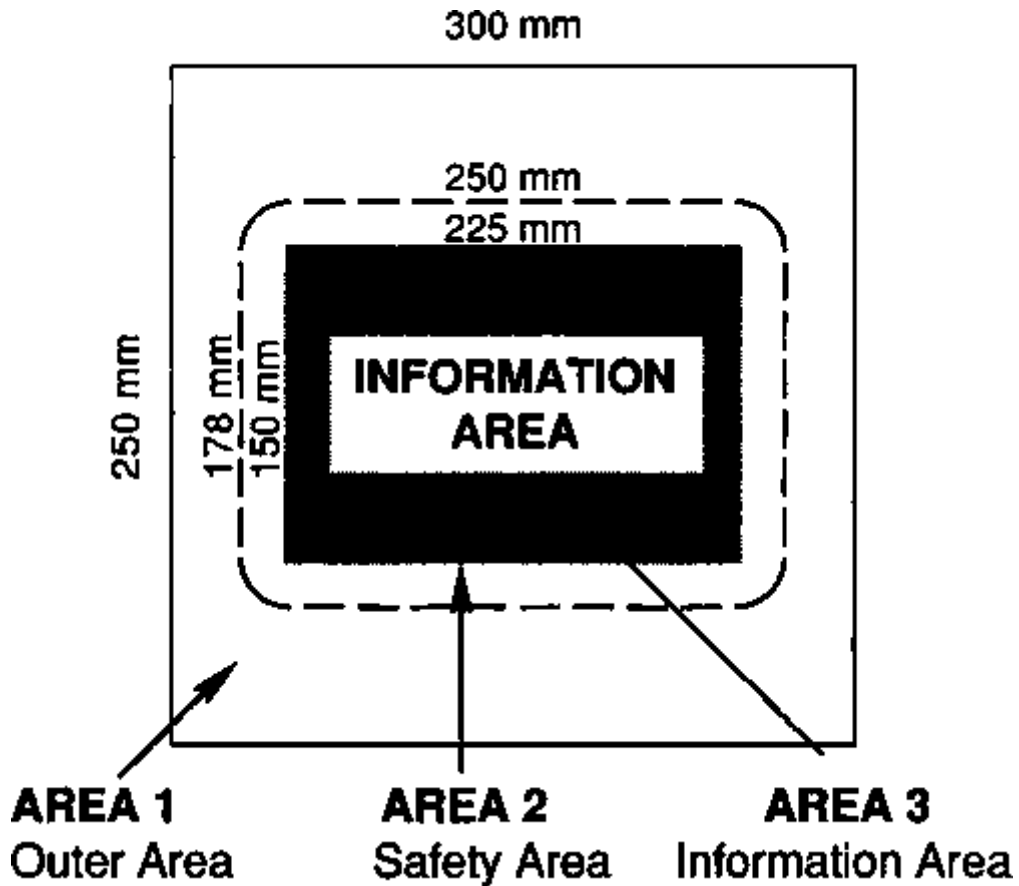

The Rule of 7: Length of longest line  $\times 7 =$  viewing distance

The **Rule of Seven** is one way to judge if written material will be readable. The steps are

- Measure the length of the longest dimension of the finished art.
- Multiply the length by 7.

Example: The longest title is 6 in long.  
 Multiply that number by 7.  
 Thus:  $7 \times 6 = 42$  or 3 ft 6 in.

- Place the graphic that distance away and if you can read it clearly, it will be readable on the screen.

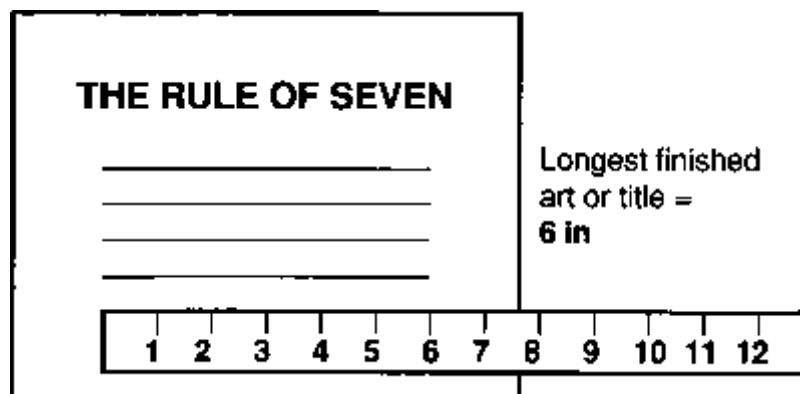

Longest finished art or title = 6 in

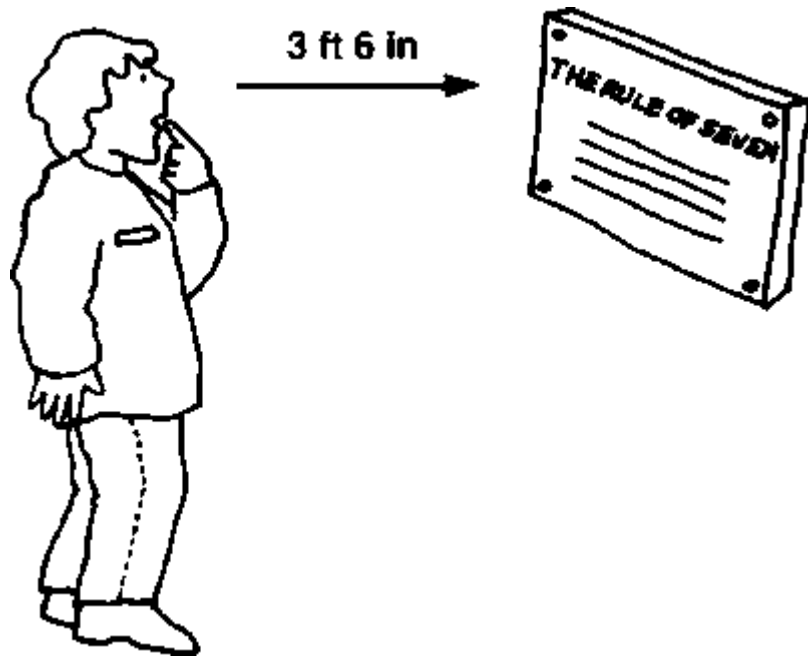

### *Photographs*

Photographs are an effective method of communication. Although photography is a professional discipline, anyone can take pictures, especially with the new automatic cameras.

With a little practice and experimentation, you will be able to take suitable photographs for your A/I program.

### ***Simple Guidelines***

1. ***Detail.*** Photographs should contain the items necessary to communicate your subject matter. They should include sufficient **detail** so that students can see the points you want to make. Overall surroundings and panoramas are often distracting. Sometimes you need both an overall view *and* a close-up to communicate effectively. For example:



**LONG SHOT**

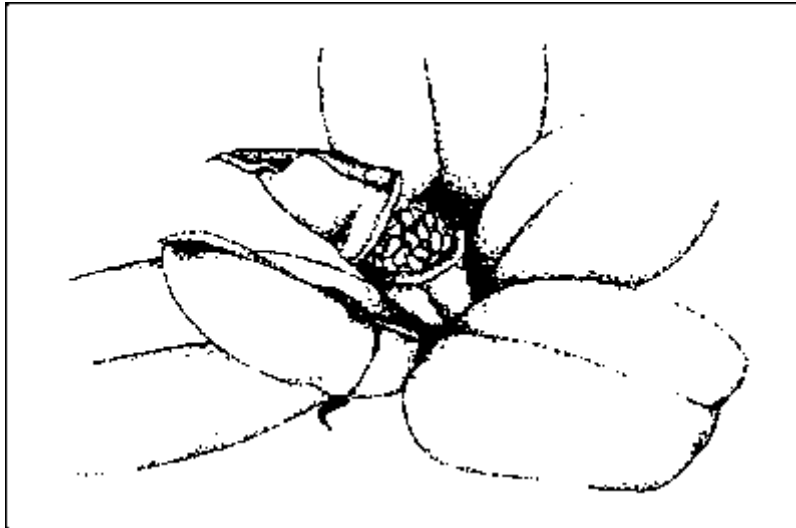

### **CLOSE-UP**

***A rule:***

**Film is cheap. When in doubt, take another picture.**

**The investment of time and travel costs more than the film, and you may have only one opportunity.**

2. **Composition.** Use good composition in photographs. The same rules of balance, emphasis, contrast, and harmony used for graphics also apply to photographs.

3. **Color.** The natural setting usually commands the color composition of photographs. Unless you are looking for a special effect, use color film. It may cost a little more, but it lends another dimension to visual communication. Humans evolved with colored vision for a reason - color communicates.

Use your creativity in taking photographs. When looking through the viewfinder, go forward, back, up, and down with the camera as you compose your pictures. Pretend that you are the grand artist designing a picture to make the greatest possible impact on your audience - your students!

#### *Combination slides*

Remember that words on slides reinforce the abstract verbal concept with a concrete visual image. You can accomplish this by using titles to introduce the visual and labels to identify its different parts. You'll want to use these verbal codes on both graphics and photographs whenever possible.

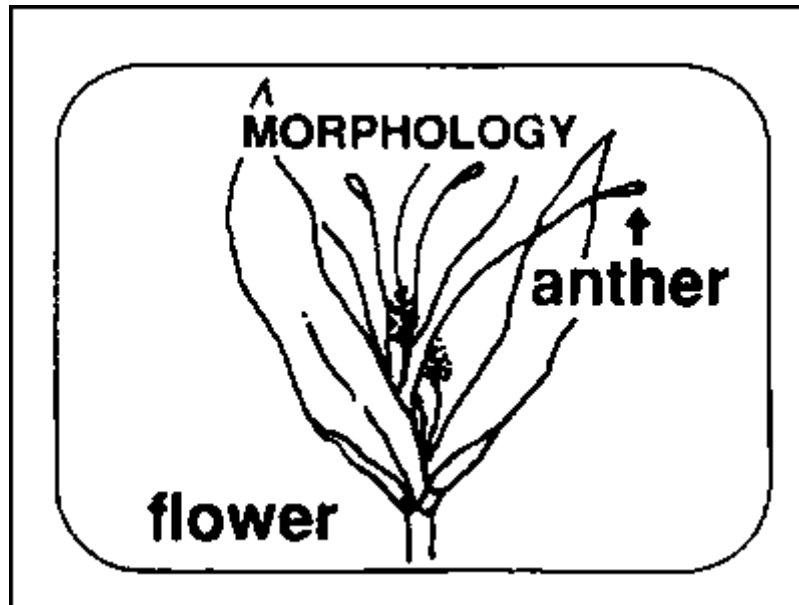

The principles in the section on titles and word slides also apply to words on graphic and photograph slides.

Here are a few more guidelines:

- Make labels concise and simple, 1-2 words.
- Too many labels are confusing. Use only 5. Use more slides if more than 5 labels are necessary.
- Often, main visuals will require supporting words. You can highlight the most important element with color. This especially applies to progressive disclosure slides.
- When you use lines or arrows to point from words to pictures, they should be precise.

### ***Photographic equipment and slide copying***

#### **The camera**

These are the best camera specifications:

size - standard 35 mm single lens reflex

lens - 50-55 mm micro (1:1)  
lens tubes with 2 extension rings

flash - rechargeable battery  
extension cable

features - built-in exposure  
focal plane shutter

## Accessories

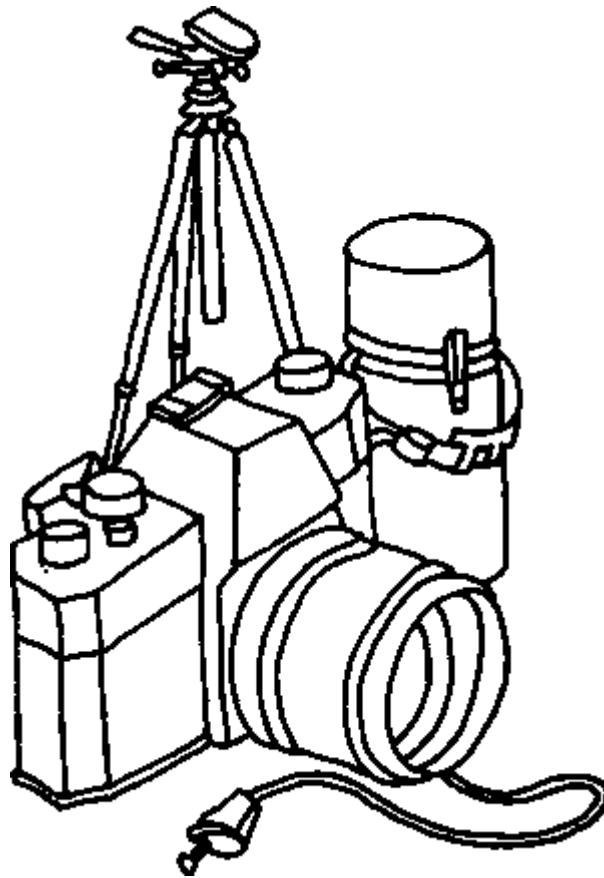

The following are necessary accessories for photography:

tripod  
shutter cable release

### Film

Two kinds of film may be used for slides:

color - Ektagraphic (ASA or ISO) 64 and 100  
black and white - positive 25

negative 25  
high contrast

### Copystand

A copystand is helpful in producing slides and to

- photograph camera-ready graphics
- affix titles and labels to photographs, and
- copy photographic prints and slides.

Ready-made copystands are available from manufacturers. However, with a little effort and ingenuity, you can construct your own practical version (See Appendix 1).



To conclude, this was a very long detailed chapter which will take some time and study to completely understand so that you can remember the information well enough to use it.

A participation exercise can help. Chapter 10 will show you how to write feedback exercises, and we already gave you objectives at the start of the chapter. After this long chapter, the author is very tired, so it will help us both if you practice using this information by writing your own feedback exercise. You will be surprised at how much you have learned!

However, hurry because in the next chapter we do the tape and then try out the program!

#### ***References and information of interest***

American Association of Agricultural College Editors (1976) Communications handbook. 3d ed. Interstate Printers & Pub., Danville, Illinois.

Dwyer F (1972) A guide for improving visualized instruction. Learning Services, Pennsylvania State University, State College, Pennsylvania.

Eastman Kodak Company (1973) Legibility - artwork to screen. Rochester, New York.

Eastman Kodak Company (1972) Effective lecture slides. Pamphlet S-22. Rochester, New York.

Ertel R E (1979) The multi-image production. WTI Corporation, California.

Friesen P A (1973) Designing instruction. Miller Publication, Sta. Monica, California.

Frio A S (1977) Preparation and use of audiovisual communication media and materials. Department of Development Communication, University of the Philippines at Los Baños, Laguna, Philippines.

Grabow J, Wesley F (1982) Resources for teaching. NACTA J. 26(1):27-28.

Kemp H E (1968) Planning and producing audiovisual materials. Chandler Publishing Co., Scranton, Pennsylvania.

Minor E (1978) Handbook for preparing visual media. 2d ed. McGraw-Hill, Inc., New York.

Minor E, Frye H (1977) Techniques for producing visual instructional media. McGraw-Hill, Inc., New York.

Salmons N (1959) Planning and producing visual aids. National Photographer 10 (8 & 9) and Kodak (Pamphlet S-13). Rochester, New York.

Xuan Vo-Tong (1976) Visual aids, International Rice Research Institute workshop on field experiments (VII-4). International Rice Research Institute, P.O. Box 933, Manila, Philippines.

## **CHAPTER 9. The Tape**

### **Prospectus**

This chapter will explain how to tape your program.

### **Rationale**

Oral communication humanizes the autotutorial process, allowing students to become emotionally involved with the voice on the tape.

The human voice has musical qualities and tones and imparts an additional dimension to the message that is not available if it is written.

### **Objectives**

At the end of this chapter, you will be able to

- Recall 5 components of a tape.

- learning  
message  
pace  
voice quality  
music

- Describe the 11 sequential steps in taping a narrative.

- produce copy  
load slides  
determine pace and time  
record notes  
link narrative with slide titles and labels  
locate recording space  
practice script  
record  
repeat and redo sections  
edit mistakes  
produce a master copy

**If you intend to produce a print/ picture program on paper only, skip this chapter as it discusses how to produce a slide/tape or picture/tape module.**

- List 6 considerations of creating a script or copy that assist in recording efforts.

- standard paper  
type in capitals  
use larger type  
double space narrative  
triple space between frames  
number frame narrative to coincide with visual frames



- Define and associate the following terms:

cold cuts  
gingerbread  
presence tape  
dead spot  
master

- Discuss 3 methods of producing gingerbread.
- Compare 3 variations of advance signals.

recorder inaudible  
recorder audible  
narrator audible

### ***Components of a quality tape***

As with graphics and photography, broadcasting or communicating with the human voice is also a profession.

Voice, tone, pitch, harmonics, pace, inflection, and volume all work together. They create an atmosphere that affects attitudes and enhances the effectiveness of the message.

For these reasons, it's best to get a professional broadcaster to record your tapes. However, time, money, availability, and other resources often make professional assistance impossible.

**Message**  
**Pace**        =        **Quality**  
**Voice**                **Tape**  
**Music**

But don't despair! You can produce your own tapes. In fact, you can even be your own voice. Before you begin, consider these components of a quality learning tape:

- The message should be appropriate to the audience (See script creation, Chapter 7).
- Pace/cues to advance the slides should be at a consistent speed but slow enough for students to understand.
- Voice quality should modulate with the script and be enthusiastic.
- Music or gingerbread, as it is called in the trade, adds variety.



Your program will also have more variety if one voice introduces and summarizes the program, and a different voice explains the content of the module.

### ***Recording the narration***

Let's go through the recording process step by step.

#### **Step 1. Create a script.**

- Type your script from the storyboard frames onto standard paper.
- Type the script in capitals.
- Use large type if possible.
- Double space as you type.
- Leave 3 or 4 spaces between texts of script for different frames.
- Number each section of script to correspond with the accompanying slide.

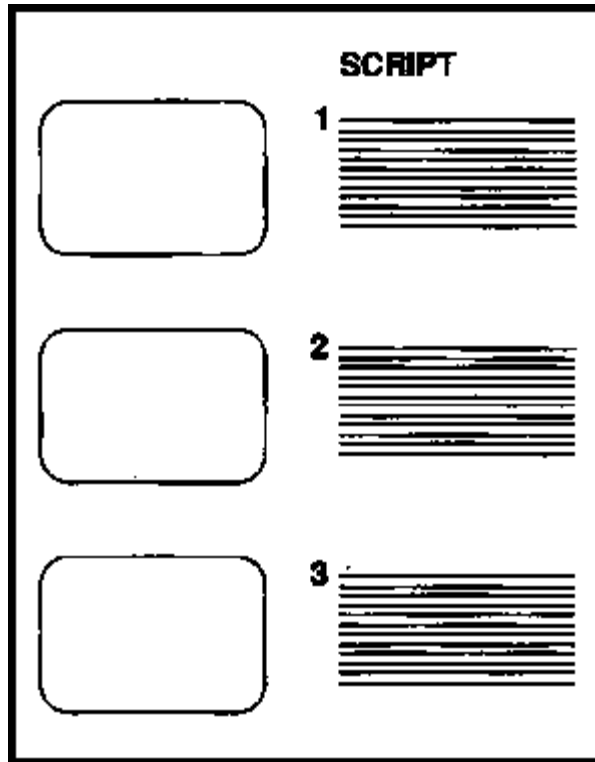

An example of a script using these guidelines would look like this:

9 ALLOW ME TO EXPLAIN. EVERY 7 TO 10 YEARS, INFORMATION DOUBLES. OF COURSE, MUCH OF THIS INFORMATION IS SCIENTIFIC.

10 WHAT WE HAVE IS A LITERAL TECHNOLOGY GENERATOR THAT IS PRODUCING ALL TYPES OF TECHNOLOGY AT AN UNPRECEDENTED PACE.

11 THE PROBLEM WE MUST SOLVE IS NOT ONLY HOW TO TRANSFER THAT TECHNOLOGY SO THAT IT IS AVAILABLE TO ALL NATIONS BUT ALSO HOW TO ADAPT THAT TECHNOLOGY TO LOCAL CONDITIONS.



**Step 2. Load your slides into a carousel.**

**Step 3. Read the narrative aloud as you look at your slides and time the length of the presentation.**

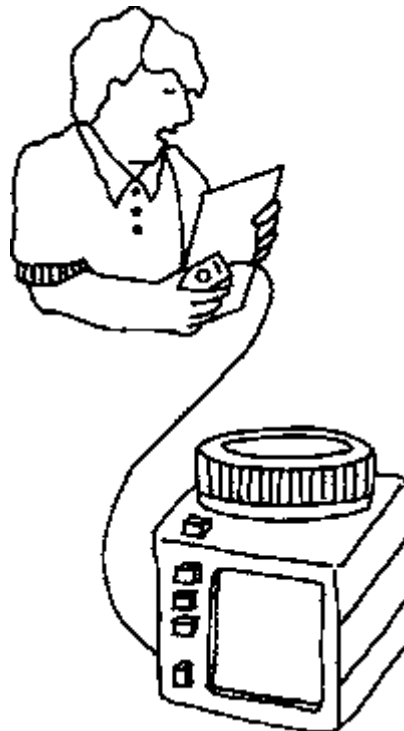

Remember you have seen the entire program many times, but it's new to the student. Go slow and leave ample time for slide changes. If it is done at the right tempo, it will seem too slow to you. Initially, you'll tend to speak too fast because of the excitement of talking into the recorder. Here's an excellent way to achieve the correct pace. Use student volunteers. Allow them to look at the slides with you as you read the script.

**Step 4. Once you have determined the correct pacing, read the copy through again.**

Make any notes or cues in the margin of your script that will help you record.

**Step 5. Check your script against the slide titles to be sure they are consistent.**

It is distracting to students to hear one thing and see something different on the slides. Be sure the narrative fits the slide.

**Step 6. Find a quiet room.**

If you don't have a sound room, recording at nighttime works best. Beware of motors and buzzing light fixtures. You will need a cord extension to advance the slide and avoid the sound of the slide projector on your tape.

**Step 7. This is it!... Almost... Read your copy through aloud one more time as a final practice.**

Read with inflection, a pleasing tone, and enthusiasm, but do not ad lib. This is a live practice!

Practice placing your used copy gently on the floor. This method helps prevent the microphone from picking up paper rustle.

**Step 8. Do it once more but this time, record.**

**Step 9. If you're recording on a reel-to-reel recorder, you can splice out mistakes - if you know how.**

If you're recording on a cassette, you may have to record several times to get a satisfactory copy. The quality is up to you! Your finished voice recording is called a cold cut.

**Step 10. If you're using a reel-to-reel recorder and plan to have someone splice or edit the tape later, allow several minutes of blank tape to run.**

This is called "presence" tape. It sounds more natural when spliced in pauses than if you use unrecorded tape which will have a discernible "dead spot."

**Step 11. After recording or cutting a successful tape, make a copy and use it for the next step. Save the master or cold cut.**

**Step 12. Gingerbread.**

Radio people call music or other special effects gingerbread. Gingerbreading a cold cut is not essential to presenting the message, but it does add another dimension. Here are 3 ways to do it.

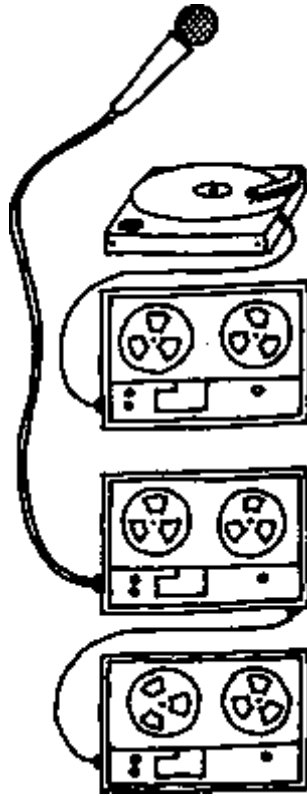

## **Methods of Taping**

### ***Method 1 - using 2 recorders***

1. Read and time your presentation.
2. Select music to go with the narration.
3. Record the music, or use a record of the music if available.
4. Play the music as background as you record your narration.

### ***Method 2 - using 3 recorders***

1. Time the already recorded narration.
2. Select music.
3. Play the music and the narration simultaneously while recording on the third recorder.

### ***Method 3 - using 1 recorder***

Of course, if you have access to a sound-on-sound recorder which has the ability to put one recording on top of another, you can dub or record music right over the voice.

No matter which method you use, be sure to make a copy of your original or master. Save the master as a back-up in case the copy gets lost or destroyed.

Most students feel that you should use music or sound effects sparingly. They work best as cues to introduce and end the program or to introduce and end breaks in the middle of the program.

Students also say that music is distracting when used as a background during learning. However, recent research has shown advantages of inputting particular types of information with particular types of music. This method of learning via music is called superlearning (See references at the end of this chapter).

### ***Editing the tape***

If you are using a reel-to-reel recorder, you can edit the tape by removing or adding sections to it. You need an inexpensive splicing machine to do this. The procedure is very simple, and the instruction comes with the machine.

Editing eliminates bad “takes” or mistakes in the program narration and is helpful in achieving precise timing between slides. We do not recommend editing cassette tapes.

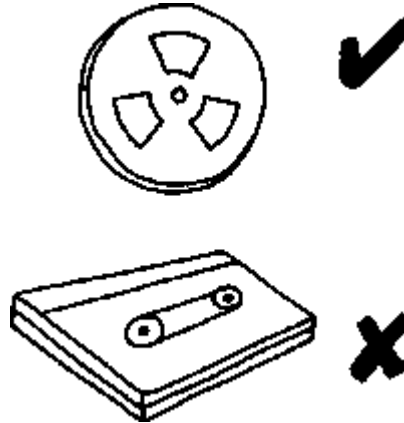

Editing and using gingerbread and multiple recordings are fine if you have the available materials. However, **you can make good, practical instructional tapes by simply recording the narration on an inexpensive cassette recorder.**

### ***Cues***

Of course, students need some cues on when to advance the slide projector to synchronize the slides and tape. Some recorders have a device that makes either a sound or a silent advance signal on the tape. The signal is part of the other track of the tape so that you cannot record on side two.

#### **Inaudible advance**

If you use a silent or inaudible advance, use a cable to attach the recorder to the slide projector. The recorder will then automatically advance the slide projector when it receives the inaudible cues on the tape.

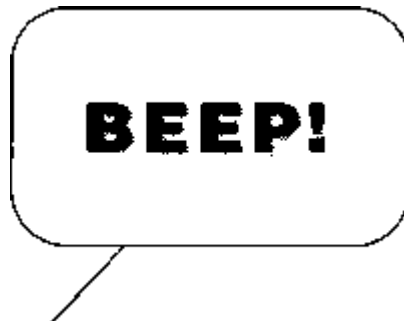

#### **Audible advance**

If the tape has an audible advance cue, the recorder and the projector run independently. At the sound of the cue, the student manually advances the projector.

### **Narrator audible**

If you do not have access to a recorder with advance signals, you can make your own advance cues. Use a light bell, or tap on a water glass (different water levels make different sounds), or some device that makes a pleasing tone. When you are recording the script, simply sound the tone between each frame. The sound will signal to the student to manually advance the projector.

There! We finished Chapter 9 on making tapes. Our feedback exercise will be brief because most of the material consists of your psychomotor skills. Therefore, your feedback will really be in the form of your finished tape.

#### ***A reminder:***

**These are simple guidelines for taping your program. We purposely omitted intricate technical details and devices. You can “cut” or make effective instructional tapes with your voice, cue signals, and if you want, use background music that fits your culture and student population. You can do this all at one time on a single, inexpensive tape recorder.**

**However, if you do have the resources, professional quality tapes are desirable.**

#### ***Feedback exercise***

- You should always use a professional broadcaster to make tapes.

\_\_\_\_\_ YES \_\_\_\_\_ NO

- Music and pace are two important components of a quality tape. What is another primary part?
- Fill in the blanks to complete the 6 requirements in creating copy.

Script copy should use

1. standard copy
2. \_\_\_\_\_
3. larger type for reading ease
4. \_\_\_\_\_
5. \_\_\_\_\_
6. matching script with visual

- The task analysis of tape production in sequence is

1. Produce copy/script
2. Load slides
3. \_\_\_\_\_
4. Record notes for speaking
5. \_\_\_\_\_
6. \_\_\_\_\_
7. Practice
8. \_\_\_\_\_
9. \_\_\_\_\_
10. Edit mistakes
11. Master copy
12. Gingerbread



- Match the following terms:

A. recorded narration	___ good recording
B. original copy	___ presence tape
C. tape recorded without sound	___ gingerbread ___ cold cut
D. musical filler for narration and pauses	___ cue ___ master
E. pause with different sound than recorded tape	___ dead spot
F. advance signal	
G. take	

- Explain the process of putting narration with music using two recorders.
- Why don't we recommend putting background music with the narration?
- Discuss the types of cues.

### ***Answers to feedback exercise***

- No
- voice/message
- all capital type  
double space narrative  
triple space between frames narration
- 3 pace  
5 link narrative and visuals  
6 locate quiet space to record  
8 record  
9 re-record segments with mistakes
- G, C, D, A, B, F, E
- Play music as you record narration.
- It distracts.
- Two types:
  - audible advance
  - inaudible advance

### ***References and information of interest***

American Association of Agricultural College Editors (1976) Communications handbook. 3rd ed. Interstate Printers & Publication, Danville, Illinois.

Ertel R E (1979) The multi-image production. WTI Corporation, California.

Ostrander S, Ostrander N, Schroeder L (1979) Superlearning. Dell Publishing Co., Inc., New York, New York.

## CHAPTER 10. How to Use Feedback and Evaluation

### Prospectus

In this chapter, we will learn how to construct feedback and self-evaluation exercises and find out why they are important in A/I.

### Rationale

Since self-evaluation exercises are a major part of the A/I concept it is important to know how to fit it in with the other parts. Self-evaluation exercises are important because they provide feedback to the learner on the learning process.

### Objectives

At the end of this chapter, you will be able to

- List and discuss 6 methods of repeating information in an A/I module.

- objectives
- advanced organizers
- examples
- visuals
- chunking
- feedback exercises

- List 7 types of drill and practice items that can be used in feedback exercises.

- multiple choice
- short answer
- completion
- matching
- draw and label
- short essay
- true or false

- Discuss the relationship between objectives and feedback exercises.

- objectives are a source of questions

- Compare and contrast norm referenced and criterion/mastery-referenced instruction.

	<b>Norm</b>	<b>Mastery</b>
distribution	Central limit (bell distribution)	No curve (mastery point)
material focus	Broad subject matter focus	Broad and specific matter focus
student focus	Group	Individual
reward	Competitive award system: (ABCDE)	Individual award system pass/ fail/extra materials for group competition

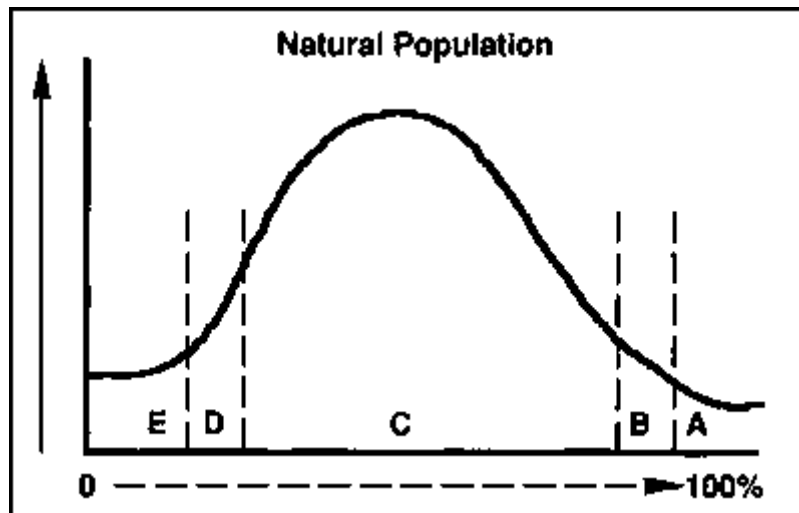

NORM REFERENCED

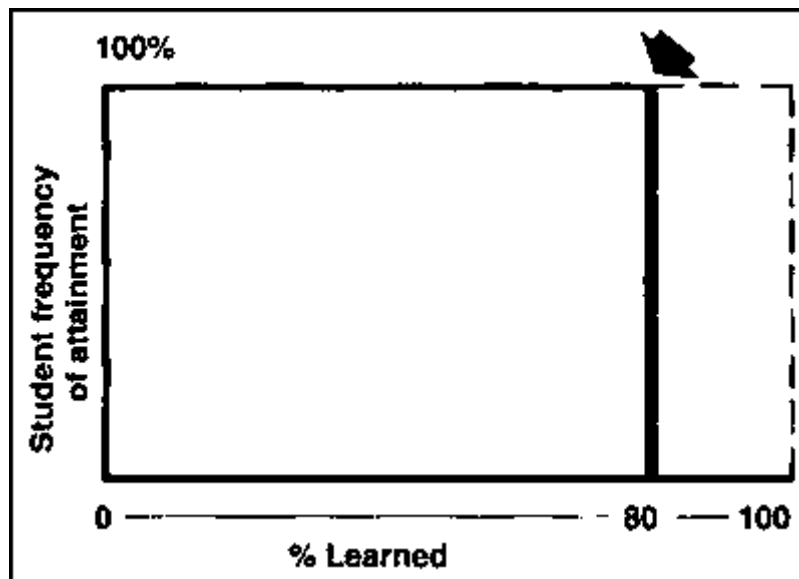

MASTERY REFERENCED

*Repetition and A/I*

Repetition is a major learning device. Finding methods to repeat information without boring the learner is one of the major challenges of creating self-learning programs.

- The use of **objectives** is one major method of repetition.
- **Advanced organizers** or titles focus the information to be learned. Then you can restate the title in the content script (See Chapter 2).
- **Examples** are another form of repetition.
- Written descriptions followed by words or portions of the script inserted in **visuals** such as tables, pictures, or graphs are other methods of varying repetition.
- **Chunking** information under objectives is still another method.
- And finally, **participatory** or self-evaluation exercises or questions are most important.

### ***Constructing feedback exercises***

Once you have written your objectives, feedback exercises are easy to construct. Simply restate the objectives in the form of questions or statements using the standard testing methods of

- multiple choice
- short answer
- completion
- matching
- draw and label
- short essay
- true or false

***FEEDBACK—  
AN IMPORTANT OUTCOME  
OF SELF-LEARNING  
INSTRUCTION.***



It is not necessary to include all the information associated with an objective in the question. Perhaps a sample will be enough to assume that the student has mastered the skill and can perform the objective.

***WHY NOT AN  
INDIVIDUAL ORAL  
FEEDBACK EXERCISE?***



For example:

Objective = List the 8 parts that form the definition of the A/I program.

Feedback exercise = The first part of the A/I program is the objective. Others are a change in the instructor's role, self-pacing, linkage of objectives to evaluation, and print/tape media.

Can you name 4 additional parts?

1. \_\_\_\_\_
2. \_\_\_\_\_
3. \_\_\_\_\_
4. \_\_\_\_\_

Evaluation and writing valid tests is a discipline in itself, one too large for the scope of this guide. However, you *can* write simple questions that will enable students to give you feedback on what they have learned.

The important rule to follow is: **Link your questions to your objectives; use your chunks.**

We assume you have had practice in writing these kinds of test questions. We cannot address question construction in this book. If you need help, refer to texts on the subject because objectives and feedback exercises are important parts of an A/I module. It is essential that you be able to write feedback questions.

### ***Referencing instruction***

Now let's look at another issue involved in autotutorial methodology and evaluation: referencing instruction.

There is a philosophical controversy in education - one concerning **norm-referenced vs. criterion/mastery** or **referenced instruction**. This controversy surrounds A/I, so perhaps you should be familiar with it should you adopt this type of methodology. However, if you're not interested, you can opt out of this discussion by turning to page 199.

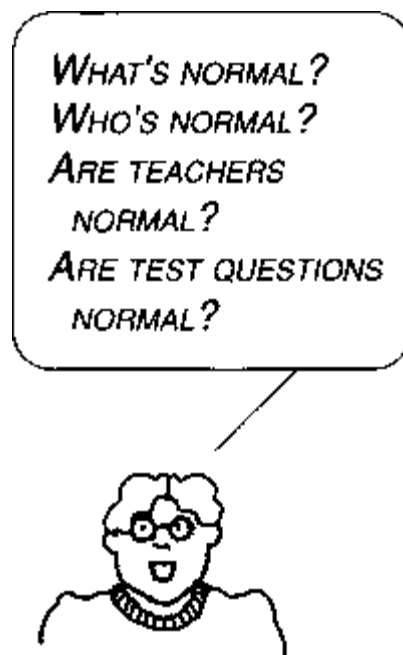

*Norm-referenced instruction*

Norm-referenced instruction involves the statistical aspects of the central limit theorem and the problem of grade distribution. In simple terms, the **central limit theorem** says that if you measure the frequency of an item of any natural or biological population (including students' learning abilities), the composite values will fall within a bell-shaped distribution curve.

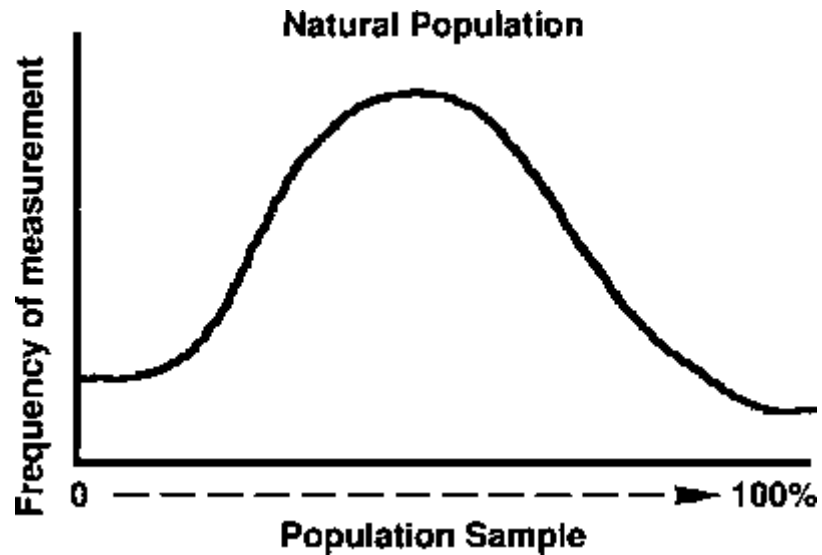

For example, if we randomly sample animal horn length, plant height, or seed weight of a natural population, the measurements would fall within a bell-shaped distribution.

When we apply this principle to the learning process, students' grades should also fall in a bell-shaped distribution.

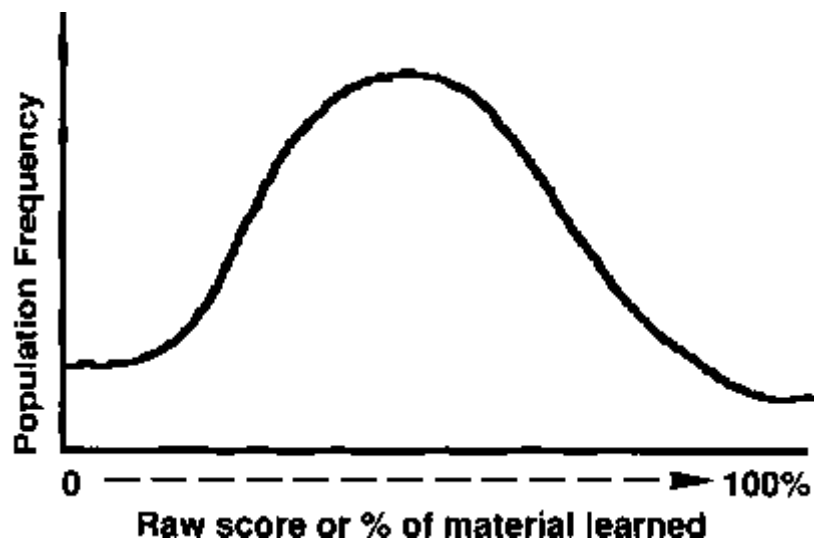

Then grades in the upper tail of the curve are As and those in the other end are Fs and in between grades are ranked accordingly.

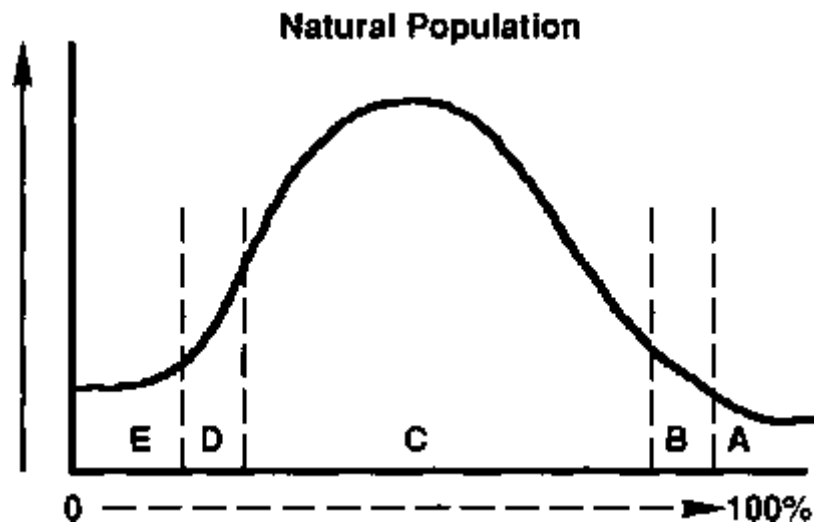

Because of competition, reward systems, honors, and transcripts, teachers have a difficult responsibility in determining and documenting students' learning success. The statistical procedures used in norm-referenced instruction are a tool to measure success. It is still by far the major methodology used in most instructional situations today.



**Scenario 1: The adversary.** To obtain a bell-shaped grade distribution, the instructor becomes an adversary to the learners. A few tactics employed in the adversary game are as follows:

- The lecturer lectures rapidly, covering many topics.
- The material is unorganized and without emphasis so students have difficulty taking notes.
- The instructor does not use visuals, handouts, overhead projections, or even write on the chalkboard.
- Outside readings are excessive and impossible to finish in the allotted time.
- The instructor does not ask questions, encourage discussion, or give practice exercises.

DOES THIS POWER PLAY  
REMINDE YOU OF ANY  
CLASSES YOU'VE  
ATTENDED?



Then comes the final exam. Questions are ultra specific, tricky and ambiguous. Result! A nice bell-shaped distribution of the exam scores.

We've purposely overstated these tactics. Yet unfortunately, many of them are in use, and they are contrary to all recommendations of learning research.

#### *Mastery-referenced instruction*

The ultimate goal of a master teacher is that 100% of the students learn 100% of the material. This is a human impossibility, but nevertheless, a goal. There are many elements that contribute to this goal, but the 8 components of A/I are some beneficial methods that have been researched.

**Scenario 2: The facilitator.** The facilitator has goals other than the bell-shaped distribution of grades. His/her primary function is to facilitate the learning process.

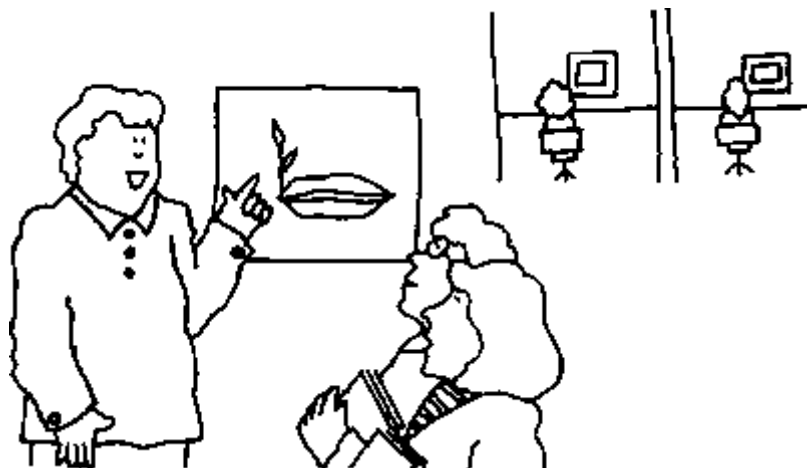

In mastery learning, the instructor facilitates by designing goals that both the student and the teacher clearly understand. Students must successfully learn the subject material before they are able to move on to the next topic.

The subject mastery level is set wherever you desire. Many researchers recommend that 97% of the material should be learned before the student moves to the next block of material.



This is a good idea for airplane pilots and brain surgeons! Perhaps if you're not involved in life and death situations, you could set a lower standard.

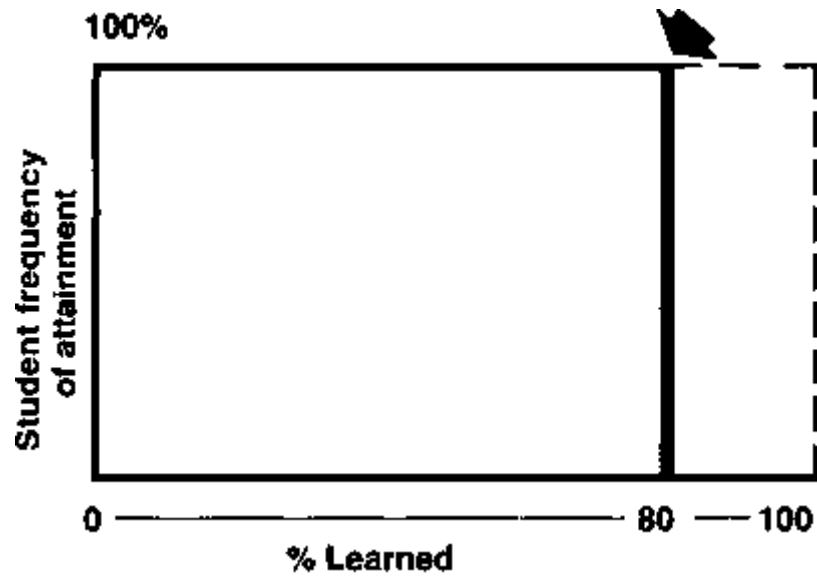

Many educators argue for 100% mastery level of content. They contend that if 80% is passing, then identify the 20% that's not so important and throw it out. Prioritize material!

<p><b>Yes</b></p> <p>1. need to know</p> <p><b>No</b></p> <p>2. nice to know          3. less nice to know          4. barely relevant          5. might be used someday</p>
--

Criterion or mastery learning means that with time, potentially all of the students pass. Some faster or easier than others, but they all pass. If everyone passes, how can you reward excellence? Simple!

Because students vary in the amount of time they need, motivation, interest, and maturity, some will always excel beyond the essential information. Then you establish a system that allows those fast learners a new exploratory track of independent exercises, reports, readings, and projects.

But all of the students must master your core goals or they fail! It is basically a pass/fail system with an added track of incentives for the learners.

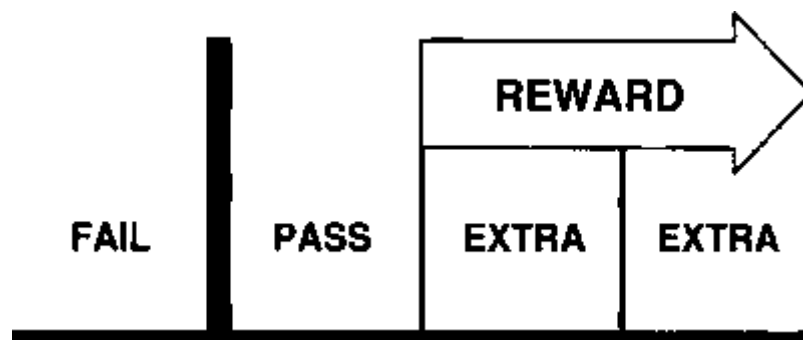

But if you use criterion referencing, be prepared to defend your philosophy and system to your norm-referenced colleagues. Norm referencing has been around a long time, and it's the system with which they were evaluated.

**Feedback exercise**

Speaking of evaluation, it's time to give you the opportunity to evaluate your learning.

- Four methods of including repetition in a module are

---

---

---

---

- When writing feedback exercises, they should be linked with the contracts or objectives.

\_\_\_\_\_ Yes \_\_\_\_\_ No

- Check the terms that best define the focus of mastery instruction.

- \_\_\_\_\_ bell curve
- \_\_\_\_\_ specific focus
- \_\_\_\_\_ group
- \_\_\_\_\_ pass/fail
- \_\_\_\_\_ reward system

- List 4 of the 7 reasons for using objectives.

---

---

---

---

**Answers to feedback exercise**

- Objectives
- Advanced organizers
- Examples
- Visuals
- Chunking
- Feedback exercises
  
- Yes
  
- Specific focus
- Pass/fail
- Reward system
  
- Defines behavior
- Learner/instructor contract
- Organizes information
- Autoevaluation for learner
- Maximizes concept agreement
- Minimizes learning time
- Correlates output and feedback channels



**Now that you have acquired this information on feedback exercises, practice designing a feedback exercise for the next chapter.**

#### ***References and information of interest***

Braskamp L A, Branderburg D C, Kohen E, Ory JC, Mayberry P W (1983-84) Guidebook for evaluating teaching. 3-part series. NACTA J. 27(4):29-34; 28(1): 19-25; 28(2):27-32.

DeLandsheere G (1982) Empirical research in education. United Nations, Paris.

Dwyer F (1972) A guide for improving visualized instruction. Learning Service, Pennsylvania State University, State College, Pennsylvania.

Friesen P A (1973) Designing instruction. Miller Publication, Sta. Monica, California.

Kirkpatrick D L (1975) Evaluating training programs. American Society Training and Development, Madison, Wisconsin.

Renwick G W (1979) Evaluation handbook for cross cultural training and multicultural education. Intercultural Network, Inc., Illinois.

Siri C M (1984) CIP course evaluation manual. International Potato Center (CIP), Lima, Peru.

Storey A G (1970) The measurement of classroom learning. Science Research Associates, White, Chicago.

## **CHAPTER 11. Creating A/I Programs: Problems and Shortcuts**

### **Prospectus**

In this chapter we will discuss some problems you might have in creating a slide-tape program and show you some short cuts.

### **Rationale**

Problems are not obstacles if you can anticipate them and devise ways to solve them.

## Objectives

There are none. Just some practical hints to help you. We want to encourage anyone **who lacks abundant resources** and show you that you can still use autotutorial programs. Be sure to read **Problem 1!**

### Problem 1: Hardware

The major drawback in using A/I is to get the hardware - adequate slide-tape machines to develop and carry out instruction for a large number of students.

**Read this again and note that autotutorial instruction doesn't need machines.**

### Solution

Abandon the slide-tape format but retain the **objectives, frame format, program, and the feedback exercises**. Using only picture/print materials and the principles of modular instruction, you can eliminate the hardware.

By doing this, you enable the students to use the information outside the learning center.

Here's how you can do it. The sequential pictures still contain titles, labels, and other cues, but they are compiled into a book. The script still coordinates the verbal information with the visual so that on the page, the picture is on the left and the narration is on the right. Be sure to underline or use capital letters for vocabulary words in the script.

#### FRAME X



Narration X  
The flower consists of a *pistil* (female organ) and

#### FRAME Y

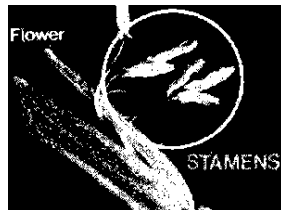

Narration Y  
six *stamens* (male organ)

#### FRAME Z

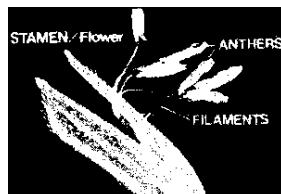

Narration Z  
The stamens have two-celled *anthers* borne on slender *filaments*.

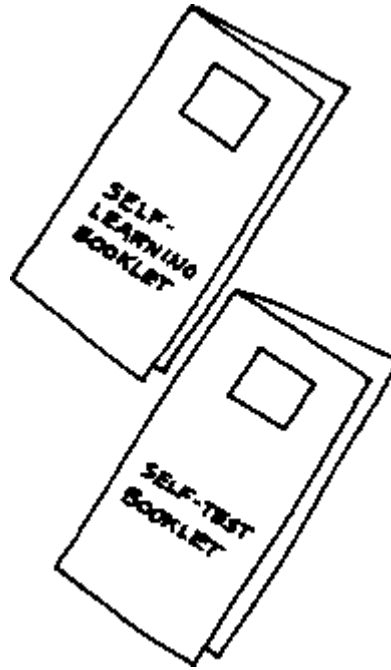

Disadvantages are that you do not have the voice and music that go with listening. Also, it is expensive to print pictures. You might compromise by using black and white instead of color.

If you can afford it, use this method of instruction in **addition** to the slide-tape format. It assists learning because learners can read the script and hear it at the same time.

### ***Problem 2: Graphics***

When trying to create A/I programs, it is sometimes difficult to find the right kinds of graphics for visuals.

#### **Solution**

Solve this problem by creating your own graphics. Usually, word slides are just a matter of sticking letters to colored paper. Here are some examples of short-cut graphic methods.

- Make a visual using colored chalk on a board, then photograph.
- Trace line drawings from a book; color them with pencils or crayons. Then paste them on colored paper backgrounds.
- Cut pictures out of popular magazines. Paste titles on them and photograph.
- Use your best artistic ability and create your own. Often simple drawings can adequately convey concepts, even the use of stick people.
- Use your imagination. Use friends who have artistic ability.

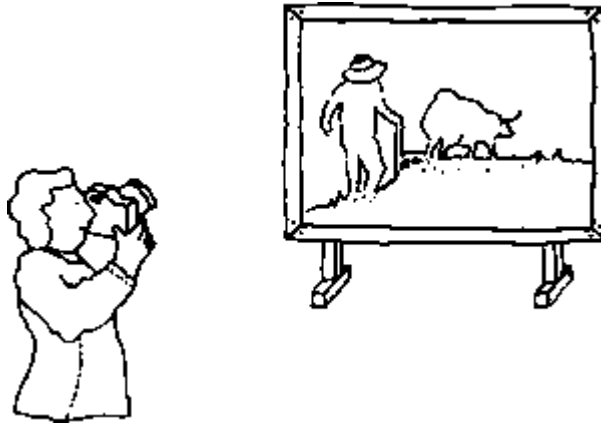

### ***Problem 3: Time***

Creating self-learning programs take time. You'll need about one hour of production (writing, storyboarding, graphics, taping, etc.) for each minute of instruction.

#### **Solution**

Two ways to speed up program creation are

- Graphics - use the graphics short cut.
- Narration - many people know their content information so well that they can lecture from memory or an outline. Try this short cut.
  1. Create slides to go with the lecture.
  2. Record the lecture while using the slides.
  3. Have a typist transcribe the lecture.
  4. Edit the transcription into a narrative.
  5. Record the narrative with cues.

**Remember, use only 15 seconds per slide.**

### ***Problem 4: Tape duplication***

Often, high speed and multitape duplicating facilities are not available.

#### **Solution**

Send tapes out to a duplicating service or duplicate them yourself one at a time from one recorder to another. Just find a soundproof area. You can even record in an insulated ice chest in a quiet room.

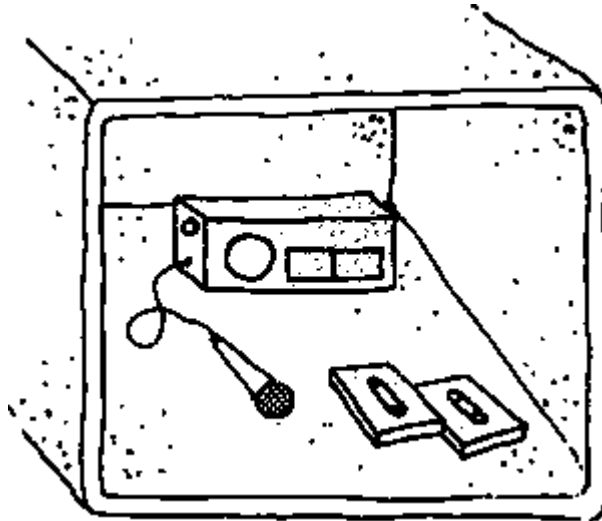

### ***Problem 5: Photography***

Good photography is difficult to master.

#### **Solution**

There are only 5 solutions to this problem:

- Stay with graphics.
- Ship it out to a professional.
- Hire your own professional.
- Have friends or colleagues help out by sharing their photographs.
- Take the time to master the skill yourself. Get a friend to teach you. With time you can learn about lighting, colors, camera stops, and techniques. It's not really that hard!

### ***Problem 6: Updating programs***

It is estimated that technical information doubles every 7 years. As a result, you will eventually need to revise some programs.

#### **Solution**

The frame format is ideal for revision. You can readily insert, delete, or reorganize chunks of information or concepts. Retaping and keeping visuals to the 80- or 120- frame limit are the primary obstacles.

However, if you are using the booklet format discussed in Problem 1 of this chapter, you have no problem. As information increases, increase the size of your book.

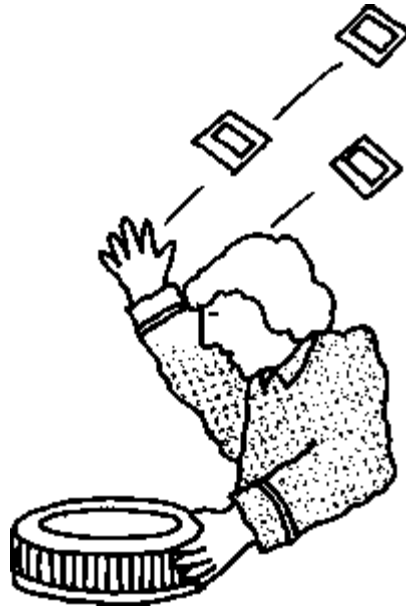

### ***Problem XYZ***

Any innovation has inherent problems that you must solve. You will undoubtedly encounter some not listed here. Be as creative in finding solutions to these obstacles as you are in creating your program. **It's part of the fun of being innovative!!!** In the next chapter, we'll talk about how to manage A/I instruction with the demands of students.

- ***NO OBJECTIVES...***
- ***NO FEEDBACK EXERCISES...***
- ***EXPERIENCE TEACHES!***



### ***References and information of interest***

Ostrander S, Ostrander N, Schroeder L (1979) Superlearning. Dell Publishing Co. Inc., New York, New York.

## **CHAPTER 12. Managing A/I Programs: Problems and Shortcuts**



## **Prospectus**

Now that you've got your A/I system developed and ready to run, what kind of problems can you expect to encounter in managing this teaching method? How can you solve them? We'll find out in this chapter, and learn more short cuts.

## **Rationale**

Now that you're going to use A/I instruction, you'll have new responsibilities as a teacher. You'll also need to rethink the student/teacher relationship.

### ***Problem 1: The new instructor/student responsibility***

A/I places more responsibility for the learning process on the student. Many learning situations have an adult/child or parent/child relationship. A/I reduces these roles. Instead, the teacher, an adult, assumes the student is an adult and responsible for learning. Often, both students and teachers have difficulty with this role change. This is especially true if the students are immature or other classes still adhere to the more conventional teaching methods.

## **Solution**

Before using A/I, talk to the students about the new method and explain how the responsibilities will change. Demonstrate a slide-tape program and discuss its advantages and disadvantages.

If you are an enthusiastic teacher and ask students to help you by giving feedback for an innovative instructional technique, they will feel a part of the process.

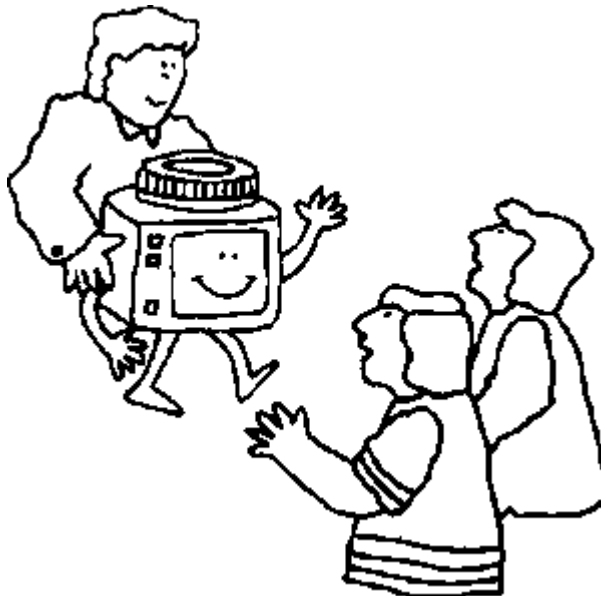

### ***Problem 2: Space***

Hardware and software are useless without space in which to store and use them.

## **Solution**

It is best if you can get a special room for this purpose. Divide the room into individual carrels such as those found in a library. Each carrel will usually seat one student, but sometimes up to three can use the carrel simultaneously.

Control the noise level by providing earphones for the students. Because the projector does make some noise, locate the room away from quiet areas. Experiment until you find the best place.

Often, the rear of a laboratory will work because the learning environment in a laboratory is compatible with machine noise accompanying the A/I hardware.

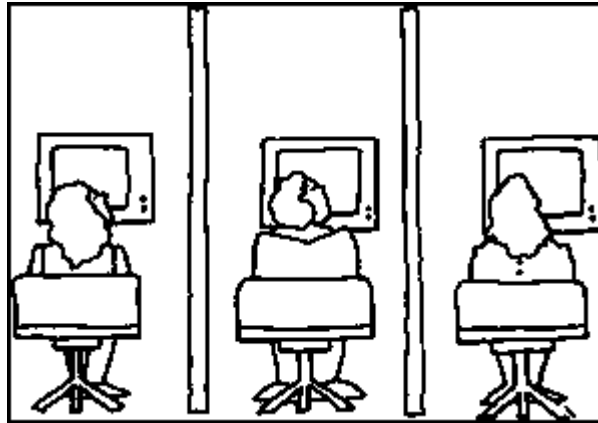

### ***Problem 3: Using hardware***

Slide-tape equipment, computer drives, and other teaching hardware are machines that need proper care to prevent damage.

#### **Solution**

Before beginning A/I instruction, teach students the correct way to use the equipment. Devise a step-by-step instruction sheet on how to run the video and audio hardware, rewind tapes, and check to see that all slides are present. Demonstrate these steps to students.

Give a hands-on skills test to each student. After accomplishing this, award each student a proficiency card.

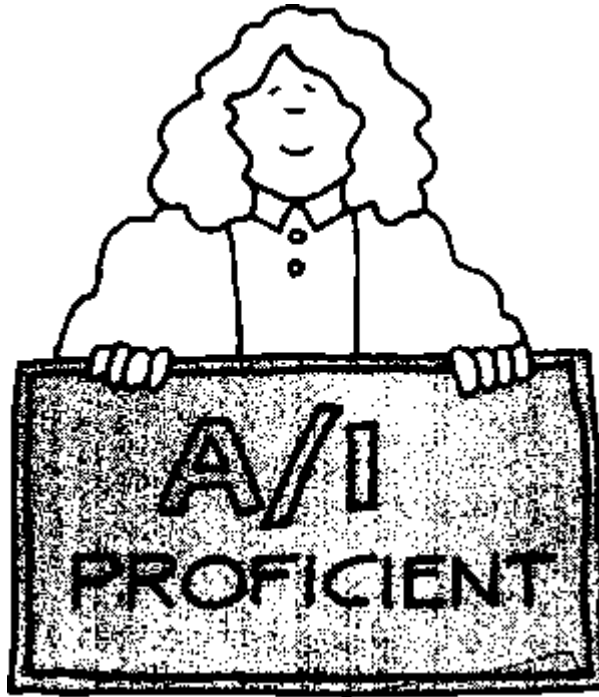

***Problem 4: A check-out system***

After you have taught students how to use hardware properly, devise a system of assigning software.

**Solution**

Some institutes have set up **learning resource centers** similar to a library. These units house the hardware for A/I instruction, and personnel check out the software when students show their proficiency certification card.

Often you can use an area of the library for software storage, and the librarian can check out the materials. Otherwise, the instructor can check out programs at specified times.

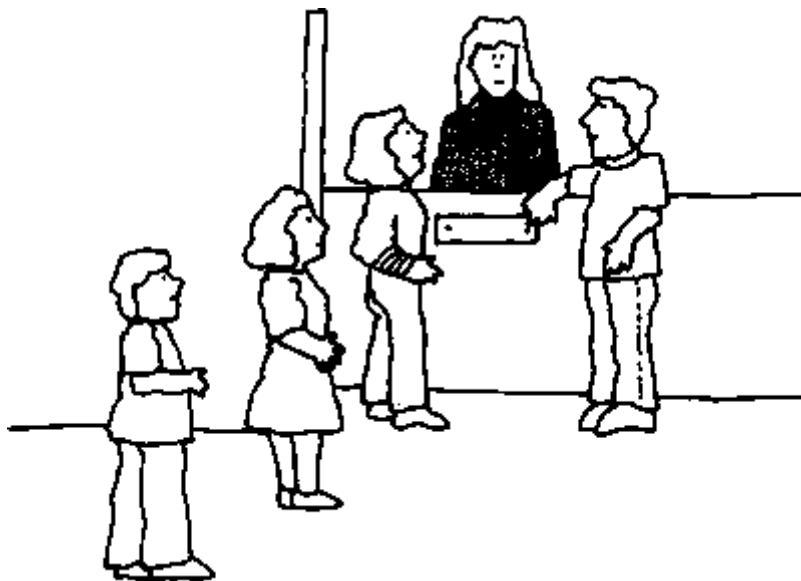

### **Problem 5: Demand for accessibility**

Self-pacing, easy access to programs, and the option to explore and repeat material are some of the advantages of A/I. However, you can have problems if you do not have enough programs or hardware to fit the number of students.

#### **Solutions**

**Spares.** When duplicating software, make two spare copies. You can use these programs as spares during emergencies. Also, when ordering hardware, order one extra component to use during repairs. Keep a supply of projector bulbs available.

**Extended borrowing time.** To make programs available to more students, you do not always have to have more equipment. Sometimes, you can simply extend the time that programs are available to students. Often libraries have extended hours. If you can house and coordinate A/I programs with library activities, you can serve more students.

**Sign-up sheets.** Sign-up sheets can also regulate the demand for programs during peak times. Of course, this compromises one of the advantages of allowing students to learn when they desire. You could also divide the class into groups and allow each group access at certain times.

**Pilot study.** You can manage program accessibility if you implement A/I instruction by degrees and adjust the system according to student feedback. Try a student-use study to see how long students need to use the machines.

**Time calculation.** Usually, students spend an average of 1 1/2 hours on a 30-minute module. They study at the machine and not at home. Students who are not studying in their native language will use the program as an aid to foreign language study. As a consequence, they may use the program **twice as long**.



**An example.** For example, if you conduct a course completely by the A/I system, 5 stations, if available for extended hours (70 rather than 40 hours/week), will accommodate 70 students. This allows a student about 5 hours/week to explore three 20- to 30-minute modules.

**SOME CALCULATIONS**

80	frames/program
<u>x 20</u>	seconds/frame
1600	seconds/program
<u>60</u>	seconds/minute
= 20-30	minutes/program

Students will use part of the time at the station to review, study objectives, and do evaluation exercises. Even so, 5 hours/week per student should be adequate.

**Problem 6: Hardware that doesn't work**

Hardware often won't work just when you need it most. Some developing countries experience frequent and extended power failures.

**Solution**

Find out ahead of time where you can find adequate repair facilities for the hardware and how long it takes to have it fixed. Plan your assignments and reserve equipment accordingly.

With some ingenuity, you can modify hardware to function on AC or DC batteries. Then when a power failure occurs, you can switch to battery power. Another option is to have your own generator.

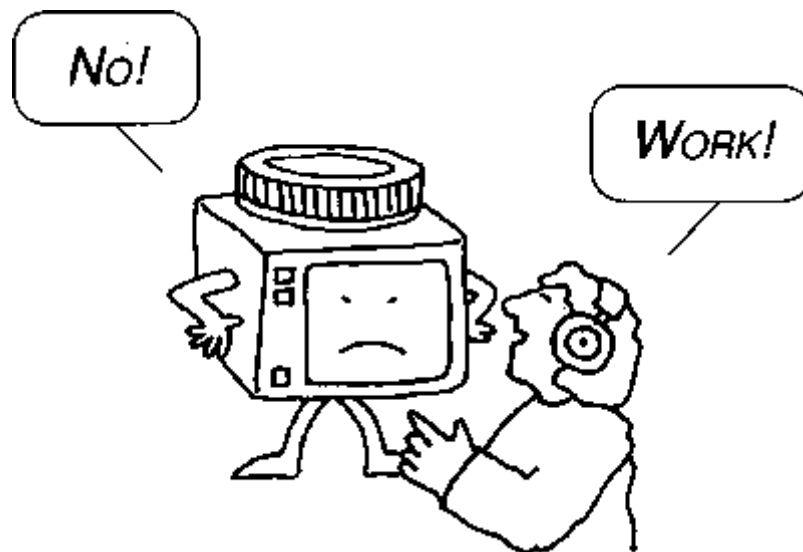

In this chapter, we have discussed 6 of the most common problems of using and maintaining A/I programs. You will encounter other problems depending on your institution, finances, and culture.

We also talked about the new role of the A/I teacher as a facilitator or a manager. Our potential problems and solutions may help you assume that role.

Perhaps you think these last two chapters on helpful hints are less important than information on software creation, objectives, and feedback exercises. However, once you begin using A/I, these hints will take on a new significance!

Another significant word is one in the title of this publication, guide.

There are whole books written about

- visuals
- educational theory
- programmed learning
- adult-to-adult teaching (andragogy)
- the information explosion
- writing objectives
- evaluation

This publication is a brief discussion of these concepts as they relate to technology transfer.



It is hoped that you learned from this publication. For additional assistance in your self-learning mode, please read the books and articles listed at the end of each chapter.



**Parting Note:** You will notice that most references in this guide are between 10-20 years in vintage. That means the technology has been around for a long time! Even then, we have to add a few more years because a piece of work takes some time for R and D before it gets cited.

**A suggestion:** Maybe it's time to get aboard - catch up and take the challenge to transfer this technology into your domain?

## APPENDIX

### How to make a copying stand

You can build this simple copying stand inexpensively (Fig. 1). You use it to hold a 35-mm camera when you photograph artwork or copywork. You'll need these materials:

- 1 piece plywood, 3/4 x 24 x 24 in
- 4 flathead bolts, 1/4-20 x 2 in
- 1 carriage bolt, 1/4-20 x 4 in
- 5 washers, 1/4 in
- 5 wing nuts, 1/4-20
- glue
- finishing nails, 4D
- lacquer or enamel, matte black

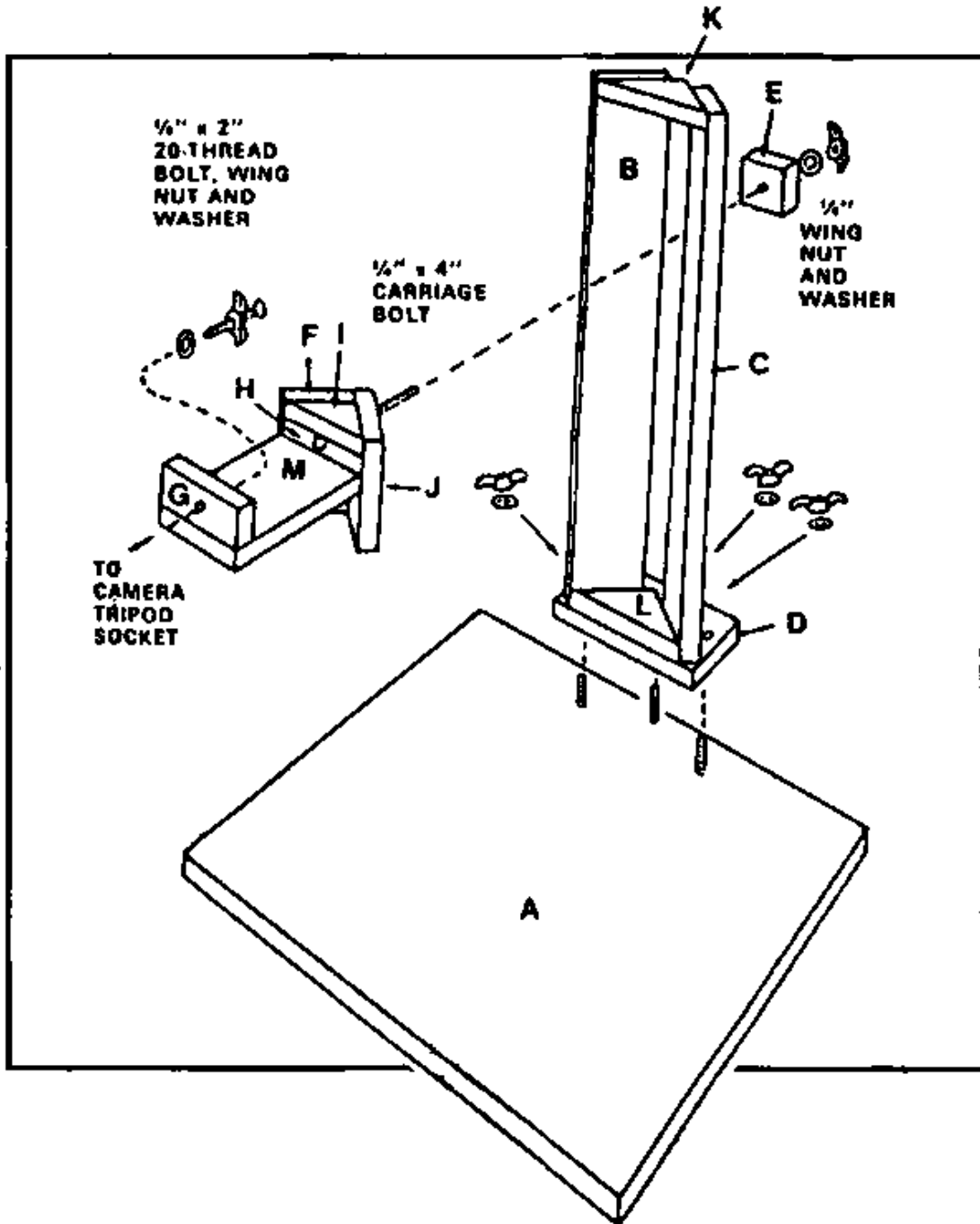

**Figure 1.** The assembled copying stand is shown partially unpainted so you can more easily identify the elements that can be disassembled for portability; the finished stand should be completely painted matte black.

### Constructing the stand

You can cut all of the wooden parts from your single piece of plywood (Fig. 2).

The dimensions in Figure 3 are not critical. You can reduce them by the width of the saw cut. Cut right angles accurately so that you can position the camera properly in relation to the reflection copy.

Glue and nail all permanent joints for rigidity. If you don't have to disassemble the copy stand to store or transport it, you can also glue the camera support column to the base.



Paint the entire stand matte black to minimize light reflection.

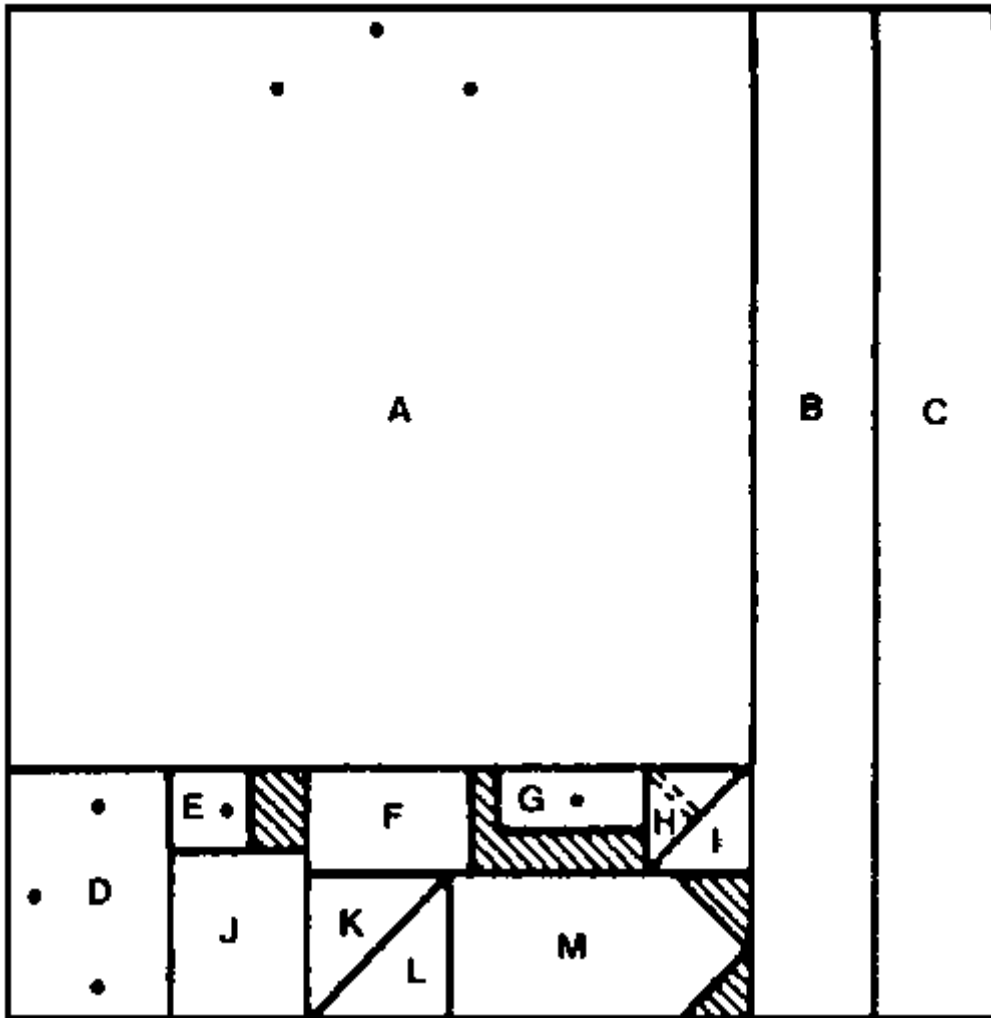

**Figure 2.** Cutting layout - 3/4" plywood, 24" x 24". Code letters are a guide to assembly.

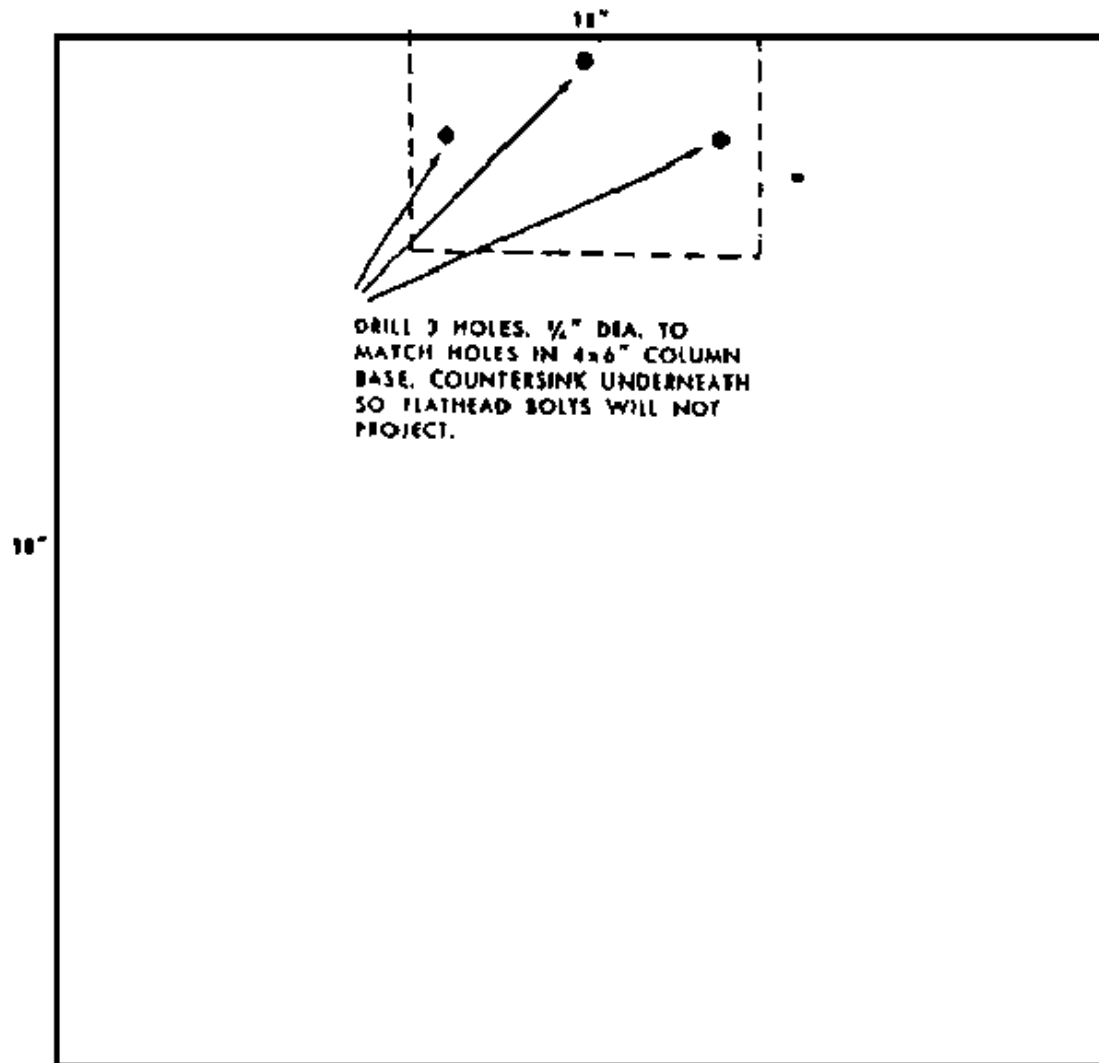

**Figure 3**

SOURCE: Kodak. 1968. Producing Slides and Filmstrips, Data Book S-18. Eastman Kodak Co., Rochester, N.Y. pp. 22-24.

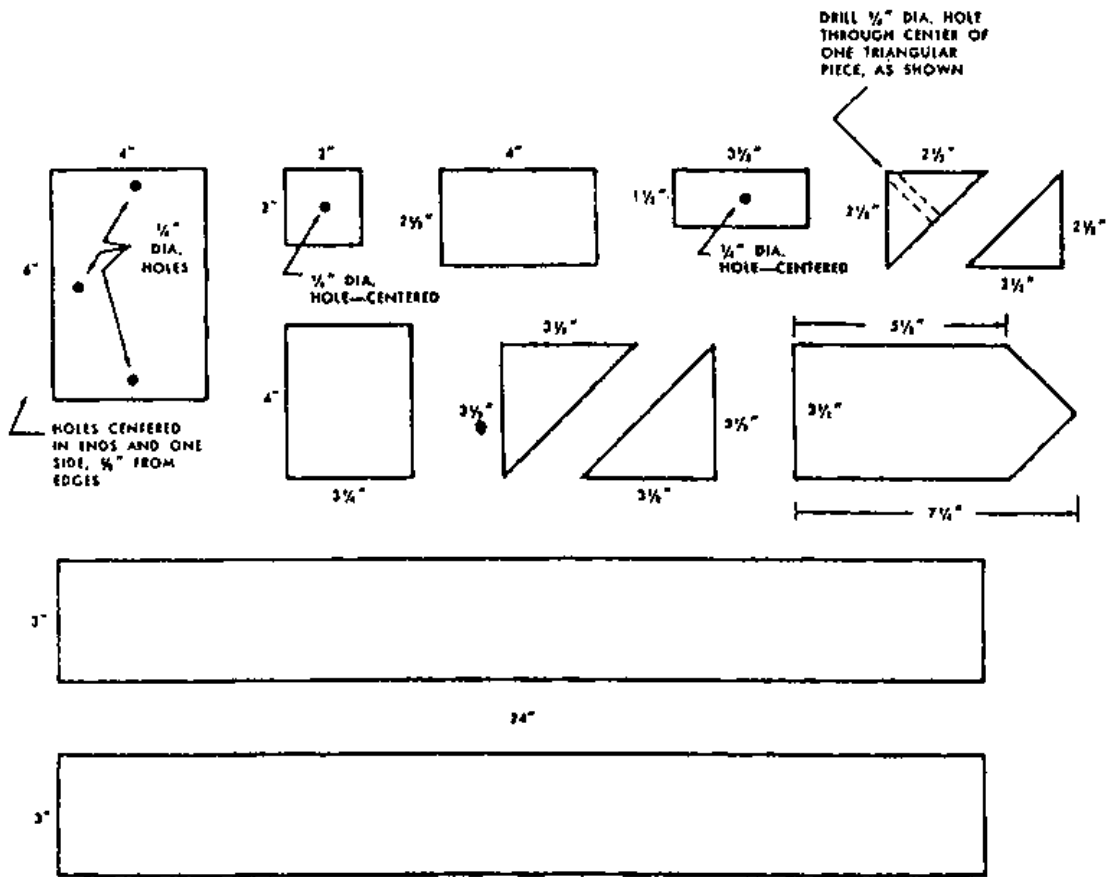

Figure 6