

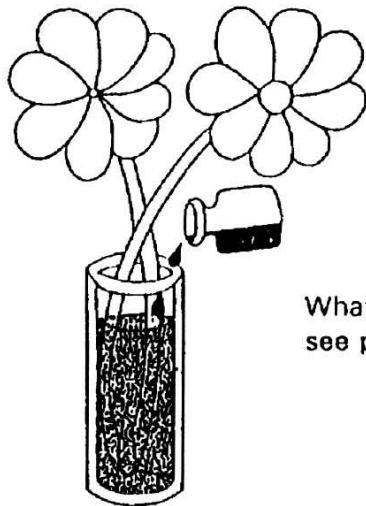

Deutsche Gesellschaft für
Technische Zusammenarbeit (GTZ) GmbH

SCIENCE EXPERIMENTS FOR PRIMARY SCHOOLS

- A Guide for Teachers -



What happens?
see page 12

What happens?
see page 62

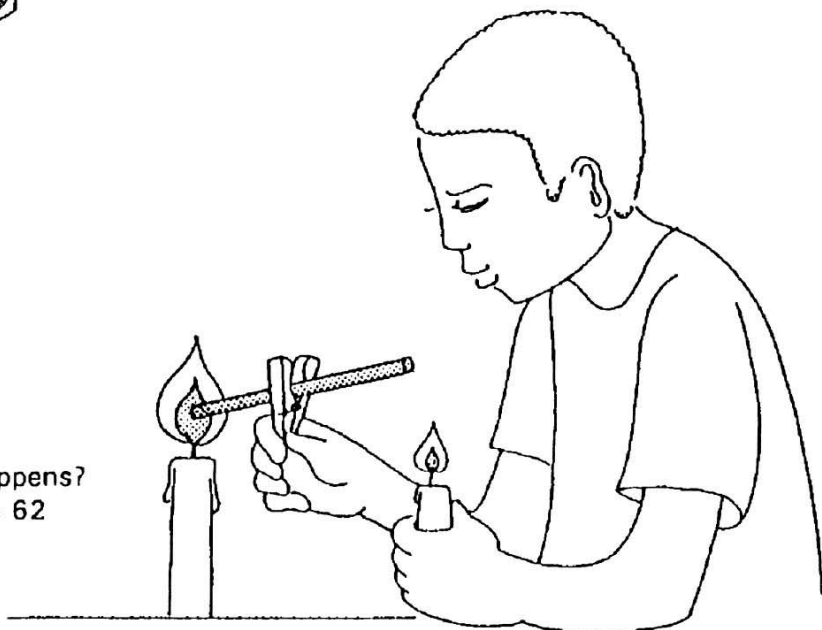

Published October 1992 by

Deutsche Gesellschaft für Technische Zusammenarbeit (GTZ) GmbH
Abteilung 411 - Education and Science Division
P.O. Box 51 80
D-6236 Eschborn
Federal Republic of Germany
Phone: (06196) 79-0 Telex: 41 523-0 gtz d Fax: (06196) 79-1115

Evaluation of curricula and project documents and compilation of the collection:

Renate Voßwinkel

Professional inputs:

Physics
Prof. Dr. Dieter Nachtigall, University of Dortmund

Biology
Dr. Gernot Strey, University of Göttingen

Illustrations
Dorsi Germann

Typeset & Layout
Fritzler & Fritzler Satz, Braunschweig

INTRODUCTION

In many countries, where natural science and technology are only now being called on to help solve the problems facing the land, educational planners and educationalists have to decide how to meet this challenge in science teaching at primary and secondary level. Conventional teaching media, which must generally be imported, are beyond the means of the already stretched education budgets and some teaching aids, that look to promising, do little more than confuse pupils, without helping to answer the questions.

Time, and a detailed knowledge of the regional problems will be needed in order to find a promising future solution for each country.

We would like to present one possible solution in the form of this collection of fundamental scientific experiments, requiring few, simple and readily available materials and inputs. Experience in many and varied projects, along with evaluations of the relevant curricula and of the schooling situation in various countries spurred us to take this step.

What has emerged is a collection, which we feel is in line with the level of previous methodical and didactic knowledge of the teaching staff, who are often inadequately trained for the tasks they are expected to perform. It provides the information needed for an interesting lesson and is meant to appeal the various intellectual faculties of children. To this end the experiments are described in simple, easy to understand language, and designed in the form of lesson blueprints.

Please let us know whether this collection lives up to its goal of providing practical assistance and as many ideas as possible in terms of materials, methods and experiments. We would be interested to hear from you which interests were awakened and what understanding pupils developed as a result of the individual experiments.

We would like to thank all those who contributed information, critical comments and ideas and, above all, the authors whose professional inputs have made this collection possible.

Hubert Hartmann
GTZ, Education and Science Division

TABLE OF CONTENTS

INTRODUCTION.....	3
1. BOTANY	7
1.1. THE EXPANSION IN VOLUME OF SWELLING SEEDS	7
1.2. THE TASK OF THE SEED LEAVES (COTYLEDONS) OF BEAN OR PEA SEEDLINGS	8
1.3. SEEDS DO NOT GERMINATE IN FRUITS	10
1.4. PLANTS DO NOT GROW WITHOUT LIGHT	11
1.5. PLANTS GROW TOWARDS THE LIGHT	13
1.6. PLANTS TRANSPORT WATER	14
1.7. THE WATER EVAPORATION OF PLANTS	16
1.8. THE IMPORTANCE OF MINERAL SALTS.....	18
1.9. PLANTS PRODUCE OXYGEN.....	19
1.10. STARCH FORMATION IN LEAVES	21
1.11. THE PRODUCTION OF GASES BY PLANTS UNDER DIFFERENT CONDITIONS	22
1.12. THE TRANSPIRATION OF PLANTS.....	23
1.13. GERMINATING PLANTS IN DIFFERENT CONDITIONS	24
2. HUMAN BIOLOGY.....	26
2.1. HEAT RADIATION OF THE HUMAN BODY	26
2.2. SENSATION OF WARMTH AND COLD.....	27
2.3. THE TASTE BUDS ON THE TONGUE	28
2.4. THE SENSATION OF TASTE AND SMELL.....	30
2.5. STARCH BREAKDOWN IN THE MOUTH.....	32
2.6. THE CINEMA EFFECT	33
2.7. THE BLIND SPOT.....	34
2.8. A MODEL DEMONSTRATING THE FLEXIBILITY OF THE SPINE	36
2.9. COSTAL RESPIRATION.....	37
2.10. IDENTIFICATION OF CARBON DIOXIDE IN EXHALED AIR.....	38
2.11. THE SKIN RELEASES SODIUM CHLORIDE.....	40
2.12. FINGERPRINTS.....	42
2.13. DISTINGUISHING SEVERAL MATERIALS BY TOUCHING THEM WITH THE FINGER TIPS	43
2.14. TESTING PULSE FREQUENCY UNDER DIFFERENT CONDITIONS	44
2.15. DETERMINING THE DIRECTION FROM WHICH A NOISE COMES	45
2.16. THE SENSITIVITY OF OUR HEARING.....	47
3. INORGANIC CHEMISTRY	48
3.1. COMBUSTION ZONES OF A CANDLE FLAME	48
3.2. THE CANDLE FLAME AND ITS DAUGHTER FLAME	49
3.3. COMBUSTION PRODUCTS OF A CANDLE.....	51
3.4. THE DETERMINATION OF OXYGEN CONCENTRATION IN THE AIR	52
3.5. NITROGEN EXTINGUISHES A CANDLE FLAME	54
3.6. ATMOSPHERIC OXYGEN SUPPORTS COMBUSTION	56
3.7. CARBON DIOXIDE AS A FIRE EXTINGUISHER.....	57
3.8. THE FORMATION OF CRYSTALS.....	59
3.9. SALT WATER IS HEAVIER THAN DRINKING WATER	60
3.10. SEPARATION OF SOLID MIXTURES.....	62
3.11. THE CORROSION OF IRON.....	63
3.12. THE IMPORTANCE OF AIR DURING THE PROCESS OF CORROSION.....	64
3.13. TINS ARE PROTECTED AGAINST RUST.....	66
3.14. INVESTIGATION OF RUST.....	67
3.15. THE ELECTROLYSIS OF SODIUM CHLORIDE.....	68
3.16. THE ELECTROLYSIS OF WATER.....	70
3.17. THE EXPLODING TIN	72
3.18. VEGETABLE INDICATOR - ANTHOCYAN	75
3.19. ACID AIR - ACID RAIN	76
4. ORGANIC CHEMISTRY	79
4.1. SUGAR CONTAINS CARBON.....	79
4.2. PROTEINS CONTAIN NITROGEN.....	80

4.3. PROTEIN CONTAINS SULPHUR	82
4.4. IDENTIFICATION OF STARCH IN FOOD.....	83
4.5. CARBON DIOXIDE IS PRODUCED DURING THE PROCESS OF FERMENTATION	84
5. PHASE TRANSITION	87
5.1. MELTING AND SOLIDIFICATION	87
5.2. EVAPORATION AND CONDENSATION.....	88
5.3. SUBLIMATION AND RESUBLIMATION.....	90
5.4. LAUNDRY DRIES WHEN THE WATER EVAPORATES	92
5.5. WATER EVAPORATION - DEPENDANT ON THE SURFACE SIZE.....	94
5.6. WATER EXPANDS WHEN IT SOLIDIFIES	95
5.7. ICE FLOATS ON TOP OF WATER	96
5.8. ICE MELTS WHEN THE PRESSURE INCREASES	98
6. WARMTH AND COLD	100
6.1. METALS EXPAND WHEN HEATED	100
6.2. THE THERMAL CONDUCTIVITY OF DIFFERENT KINDS OF MATERIALS.....	101
6.3. THE THERMAL CONDUCTIVITY OF WATER.....	103
6.4. THE HEAT "STREAMING".....	104
6.5. DENSITY DIFFERENCE BETWEEN WARM AND COLD WATER.....	106
6.6. HEAT RADIATION	108
6.7. DARK MATERIALS WARM UP FASTER THAN LIGHT ONES	109
6.8. DARK MATERIALS COOL DOWN FASTER THAN LIGHT ONES	111
6.9. HEATING WITHOUT A FLAME	112
7. AIR	115
7.1. THE AIR - A BODY	115
7.2. WE FIND OUT ABOUT AIR RESISTANCE	116
7.3. AIR RESISTANCE	118
7.4. THE DIFFUSION OF GASES	119
7.5. CARBON DIOXIDE IS HEAVIER THAN AIR	121
7.6. THE PHENOMENON OF AIR PRESSURE	122
7.7. HOW A DRINKING STRAW WORKS.....	124
7.8. THE DANCING COIN.....	125
7.9. THE BALLOON IN THE BOTTLE	127
7.10. THE FOUNTAIN EXPERIMENT	128
7.11. THE PHENOMENON OF AIR FLOW	130
7.12. THE AERODYNAMIC PARADOX.....	132
7.13. THE BOYLE-MARIOTTE LAW.....	133
7.14. MOVING FORWARD BY REPULSION	135
8. WATER	138
8.1. MODEL OF A WATER-PIPELINE.....	138
8.2. THE PRINCIPLE OF A WELL.....	139
8.3. THE SIDE-PRESSURE OF A WATER-COLUMN	141
8.4. VOLUME DETERMINATION OF A STONE	142
8.5. A RAZOR BLADE FLOATS ON TOP OF WATER.....	144
8.6. WATER HAS A SKIN	145
8.7. THE PHENOMENON OF SURFACE TENSION.....	147
8.8. WATER ASCENDS IN SOIL	149
8.9. DETERGENTS FACILITATE THE ABILITY OF PERFUSION	151
8.10. THE EFFECTS OF DETERGENTS ON DIRT	152
9. MECHANICS.....	155
9.1. GEAR MECHANISM - A TRANSMISSION	155
9.2. GEAR MECHANISM - A TRANSMISSION TO SLOW DOWN.....	156
9.3. A SEESAW - A TWO-ARMED LEVER	158
9.4. MODEL OF A SIMPLE CABLE WINCH.....	160
9.5. INERTIA	162
9.6. FRICTION.....	163
9.7. A HEAVER - A ONE-ARMED LEVER.....	165
10. ELECTRICITY.....	167
10.0. THE SCIENCE OF ELECTRICITY.....	167
10.1. A JET OF WATER IS DEFLECTED.....	170

10.2. A SIMPLE CIRCUIT	172
10.3. THE PRINCIPLE OF A FLASHLIGHT	173
10.4. CONDUCTOR AND NON-CONDUCTOR.....	175
10.5. SERIES CONNECTION	176
10.6. PARALLEL CONNECTION.....	178
10.7. ELECTRICAL CURRENT PRODUCES HEAT	179
10.8. THE PRINCIPLE OF AN ELECTROMAGNET.....	181
10.9. THE PRINCIPLE OF A BIMETALLIC STRIP	183
11. OPTICS.....	185
11.1. A CONVEX LENS	185
11.2. THE BURNING GLASS.....	186
11.3. MAGNIFYING GLASS - VIRTUAL IMAGE OF A CONVEX LENS	188
11.4. REAL IMAGES WITH CONVEX LENSES	189
11.5. THE CONCAVE LENS	191
11.6. VIRTUAL IMAGE OF A CONCAVE LENS.....	193
11.7. PINHOLE CAMERA	194
GLOSSARY	196

1. BOTANY

1.1. THE EXPANSION IN VOLUME OF SWELLING SEEDS

Main Goal:

This experiment illustrates in an impressive way how seeds expand in volume as they steep.

Information:

Seeds have a great osmotic pressure, which is responsible for water absorption during the steeping process. (Osmosis is the diffusion of fluids and gases through a membrane or porous partition.)

Materials and Apparatus:

bean or pea seeds

a. sand, water, a bottle, a pierced rubber or cork stopper, bucket;

b. gypsum, water, a small cardboard box, a vessel.

Procedure:

a. A bottle is completely filled with either bean or pea seeds and sand. The sand fills the spaces between the seeds. The bottle is tightly sealed with the pierced stopper. The stopper can be secured with wire gauze. The bottle is placed in a bucket filled to the rim with water. The bottle has to be totally submerged.

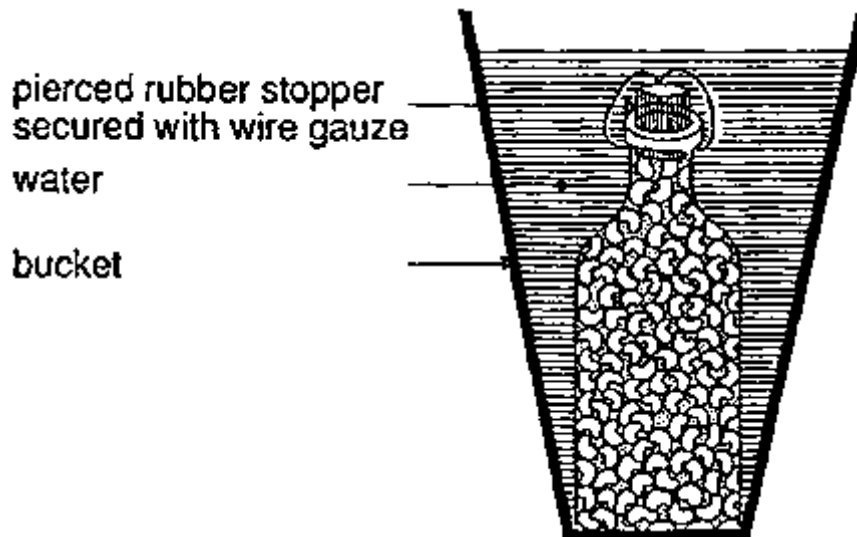

b. The small cardboard box is half filled with plaster of Paris. 15 seeds are placed in this and then the box is immediately completely filled with the plaster of Paris. The gypsum is left to firm completely and then the whole block is placed in water. Instead of a cardboard box you can use any other container, e.g. a plastic yoghurt tub.

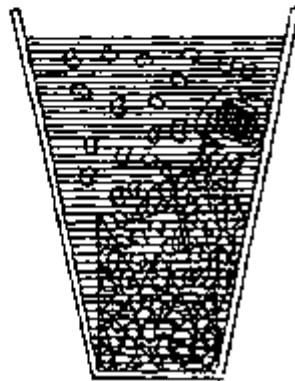
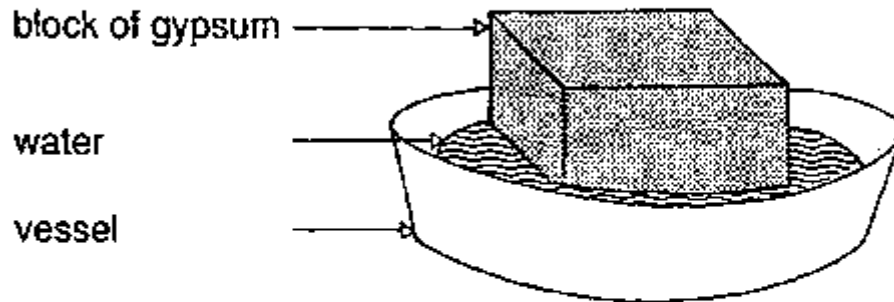
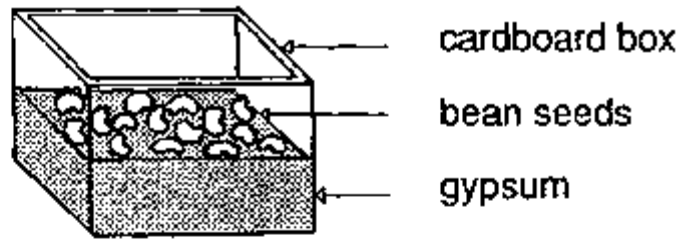

Observation:

After a few days the bottle and the plaster block shatter.

Analysis:

The seeds expand in volume to such a degree that the bottle and the block of gypsum shatter.

Importance in Nature:

Such power is necessary to push away the ground when the seeds swell in the soil. Otherwise they could not germinate, because they need the intake of water to make the stored nutrients in the seeds usable.

1.2. THE TASK OF THE SEED LEAVES (COTYLEDONS) OF BEAN OR PEA SEEDLINGS

Main Goal:

This experiment illustrates that seed leaves (cotyledons) play an important role in the early development of seedlings.

Information:

The two seed leaves of beans (or peas) contain a certain amount of reserve substances. These nourish the seedling until it is able to absorb mineral salts from the soil through its fully developed roots and carbon dioxide from the air through their leaves.

Materials and Apparatus:

a. 9 seeds capable of germinating (peas) 9 seedlings of the same size 2 pieces of wire gauze or 9 test tubes or flint-pebbles to hold the plants (the size should be such that the seedlings do not fall through the mesh) 1 dish (measuring about 13 cm by 5 cm, and about 7 - 10 cm in height) distilled water (Available in every garage. If distilled water cannot be bought or produced, rain water or tap water may be used).

Procedure:

a. Put the beans on the wire gauze. Make sure that they are moistened regularly. Let them germinate. Watch the water. If it becomes grey change it, because there are fungi in the water which may start to destroy the experiment.

b. When the seedlings are about 1 cm high, both seed leaves are taken from each of three seedlings and one seed leaf from three others. The roots must be kept below the surface of the water. The last three remain unchanged. The experiment is analysed after about a week.

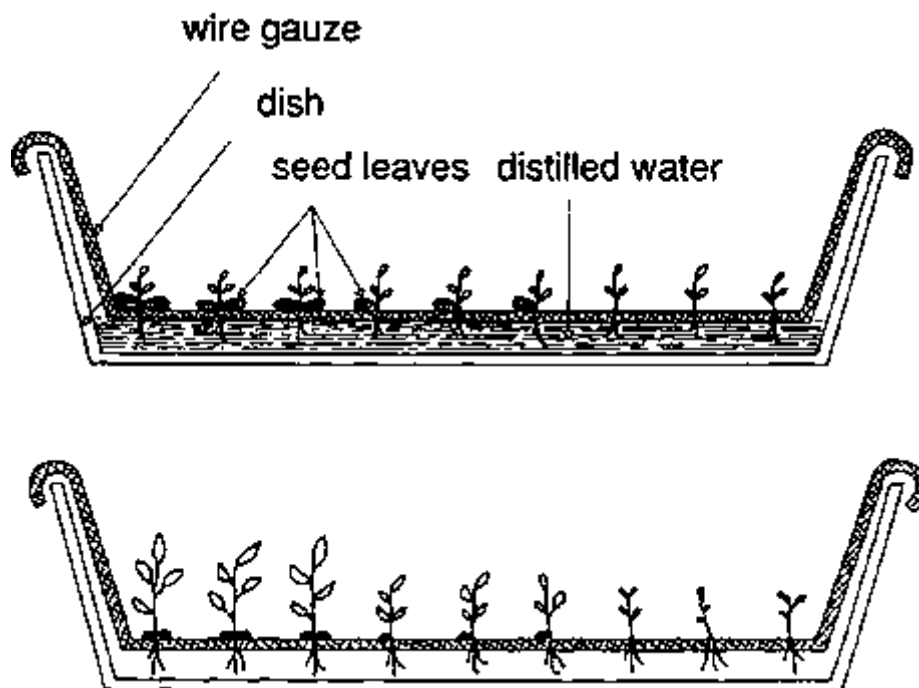

Observation:

The seedlings without any seed leaves have not grown.
Those with just one seed leaf have hardly grown.
The seedlings with two seed leaves have grown noticeably.
All of the seed leaves have withered.

Analysis:

The seed leaves nourish the seedlings until they are capable of absorbing mineral

salts through their roots.

Importance in Nature:

The nutrients the seed leaves use when germinating are the same as those we use when we eat beans, peas or other seeds. The reserve substances stored for the seeds themselves give us the feeling that we are full.

1.3. SEEDS DO NOT GERMINATE IN FRUITS

Main Goal:

This experiment illustrates the existence of materials which inhibit the germination of seeds in fruits.

Information:

In order to germinate, seeds need water as well as air. In most kinds of fruits, seeds do not germinate. One reason, besides the lack of air, is that there are substances in the fruits which prevent germination.

Materials and Apparatus:

*different kinds of fruit (e.g. oranges, apples, melons, tomatoes)
40 cress seedlings
4 round filters, or absorbent paper, or cotton wool
5 round dishes, about 10 cm in diameter (e.g. lids of jam jars)
1 knife water*

Procedure:

40 cress plants are soaked for about 10 minutes in one dish filled with water. (The swelling process takes longer if other fruit seeds are used, and some are not capable of germination.)

Meanwhile the moistened filters and the cut parts of the fruits are placed into the other dishes. Ensure that the equipment and your fingers are clean when you cut the fruits and place the parts into the dishes, otherwise you can get blue mould growing on your experiment. If blue mould should grow nevertheless repeat the experiment. The swelled cress seedlings are distributed among the four dishes as shown in the diagram below. They are observed for 4 - 5 days.

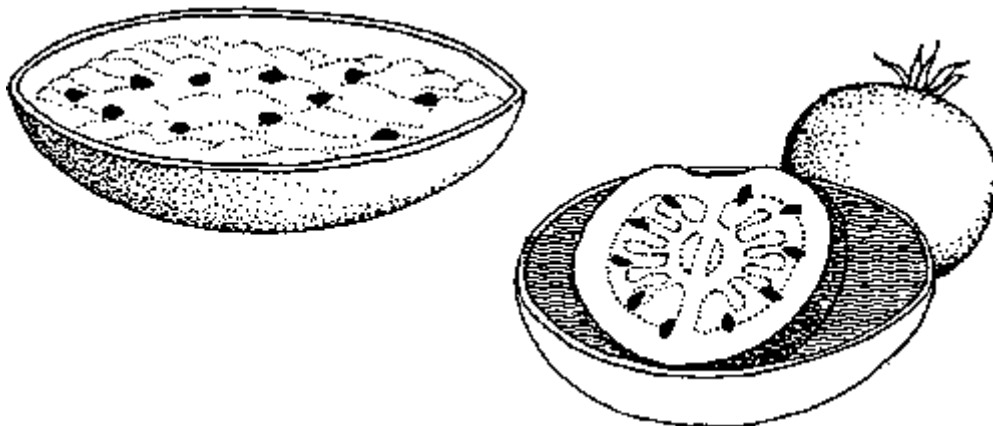

Observation:

Although the seeds in all the dishes receive air and water, germination takes place only in those dishes in which they were placed directly on moistened paper. (One or two germinated seeds on the fruit slices do not distort the result. Experiments in biology do not necessarily succeed completely.)

Analysis:

Fruits contain substances which inhibit the germination process. These prevent the germination of seeds. The seeds can only start germination and growing once the fruits are rotten.

Importance in Nature:

Fruit seeds are spread by birds, which are attracted by the coloured fruits. The birds eat them, and drop the seeds with their droppings. The seeds then germinate and grow where they land.

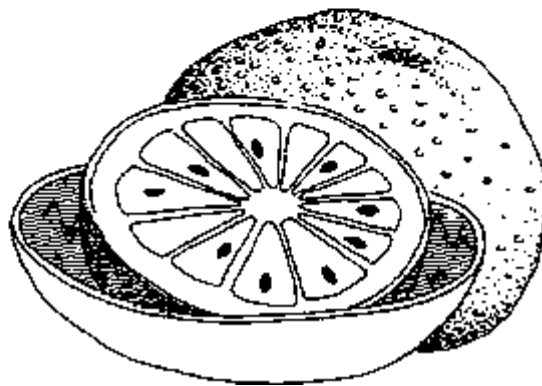
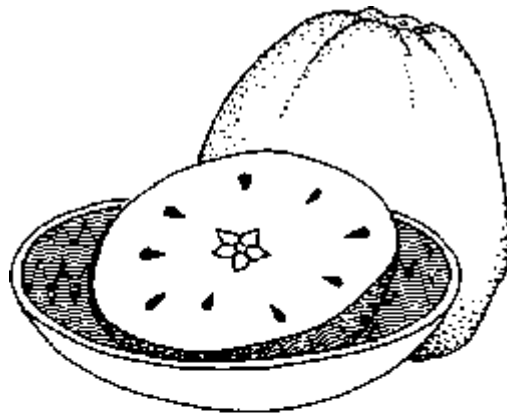

1.4. PLANTS DO NOT GROW WITHOUT LIGHT

Main Goal:

This experiment demonstrates that plants wither without light.

Information:

Plants require light to produce carbohydrates from carbon dioxide and water. (The carbohydrates are decomposed gradually by the metabolism of the plant. During this process, energy necessary for the vital functions of the plant is liberated.)

Materials and Apparatus:

- cress plants (about 30)*
- 2 flat receptacles filled with soil (e.g. cut-off tins or plastic mugs)*
- water*
- 1 cardboard box*

Procedure:

Cress plants are grown in the two receptacles in moist soil until they are approximately 1 cm high. A cardboard box is placed over one of the receptacles (see diagram). The soil is kept moist. (Other plant types may also be used.)

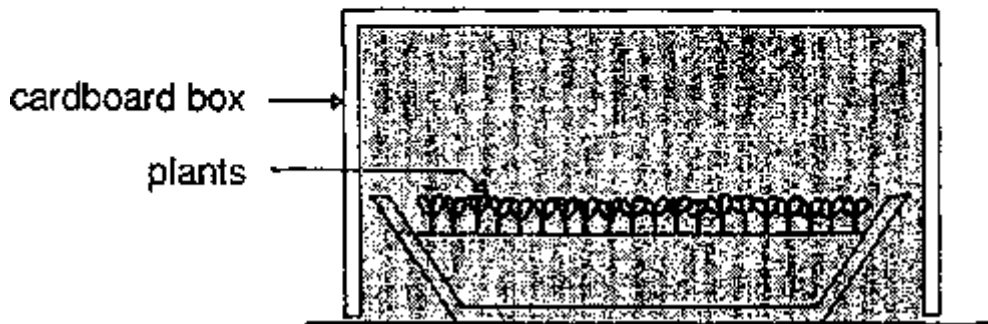

Observation:

After a few days it can be observed that the leaves of the plants under the cardboard box have turned yellow. The plants do not grow further.

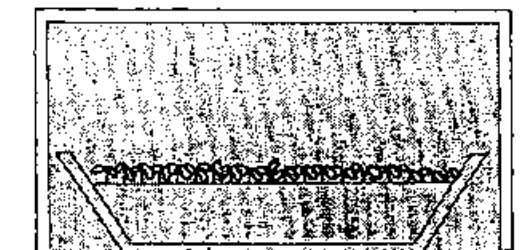
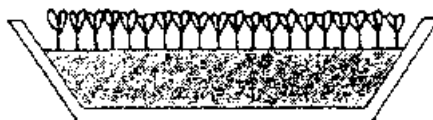

Analysis:

Besides water and the mineral salts which are found in the soil and carbon dioxide from the air, plants need light to grow.

1.5. PLANTS GROW TOWARDS THE LIGHT

Main Goal:

This experiment demonstrates that plant shoots usually grow towards the light.

Information:

As a rule, shoots grow towards the light. Light is indispensable for photosynthesis of plants.

Materials and Apparatus:

about 20 cress seedlings in soil (mustard seedlings or other kinds of plants can also be used)

cardboard box

a pair of scissors or a knife

Procedure:

A hole measuring some 2 cm² is cut in one side of the cardboard box. The hole should be cut at the height of the cress seedlings. This cardboard box is placed over the seedlings. The experiment should be placed beside a window with the hole facing the window.

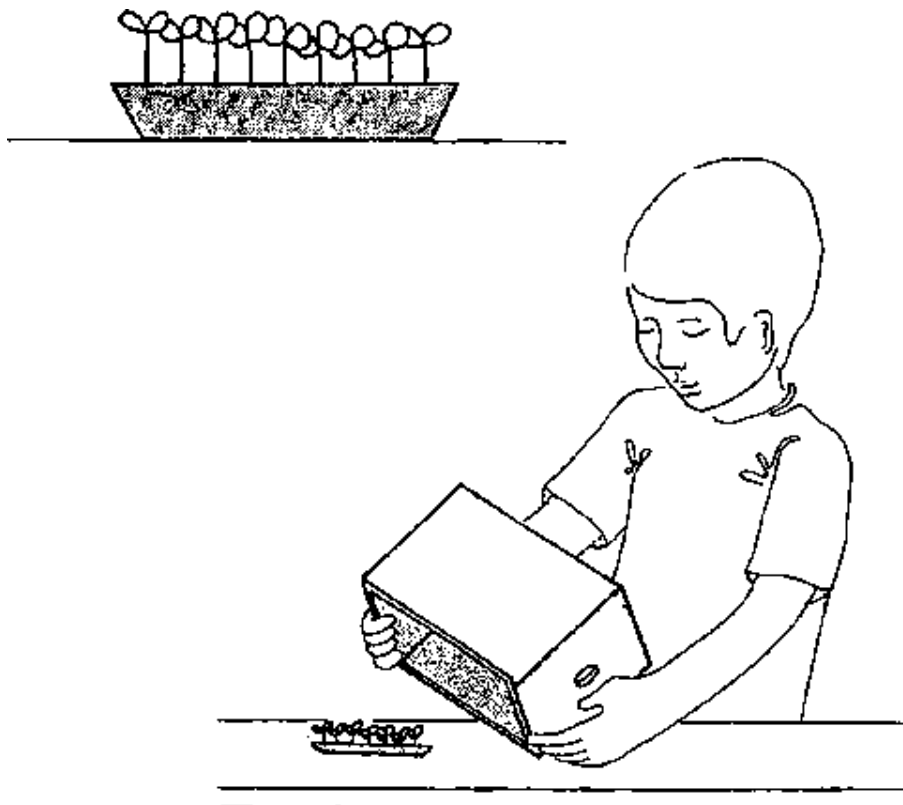

Observation:

After a few days it is observed that the axes of the seedlings bend towards the light source.

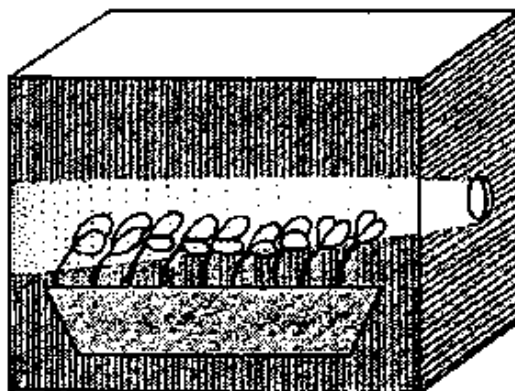

Analysis:

This bending towards the rays of light is known as “phototropism”.

Importance in Nature:

Phototropism helps the plant to get as much light as possible for a maximum photosynthesis. But in nature this involves certain problems: maximum photosynthesis means a maximum of transpiration. High rates of light diminish the growth in length, which can become a problem in competition with other plants. Everywhere in nature we thus see an optimal compromise.

1.6. PLANTS TRANSPORT WATER

Main Goal:

This experiment shows that plants transport water. There are only few flowers which are suitable for this experiment.

Information:

Plants contain vascular tissue. The xylem (woody tissue of a plant) conducts moisture and mineral salts. The phloem (sieve-tube tissue) serves as a path for the distribution of synthesized food.

Materials and: Apparatus:

white or yellow flowers like sowbread, snowdrop, white lilies, impatiens and other flowers with somewhat hyaline stalks and petals. You can also use small twigs of deciduous trees with very young leaves. It may be necessary to test some plants available in the country where the experiment will be carried out.

*water-soluble 1% red or blue colouring
(red or blue ink, acid solution)*

*1 glass or plastik beaker, approximately 15 cm in height
(depending on the length of the plant stalks)*

*water
knife*

Procedure:

Some flower stalks are cut obliquely under water and placed in the dish with the colouring solution. The stalks must be cut under water to prevent the appearance of an embolus of air in the lower part of the stalk. That would prevent the coloured water rising in the stalk.

This experiment takes between 30 and 60 minutes, sometimes half a day, depending on the kinds of plant used.

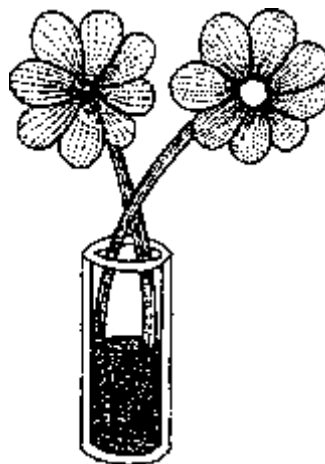
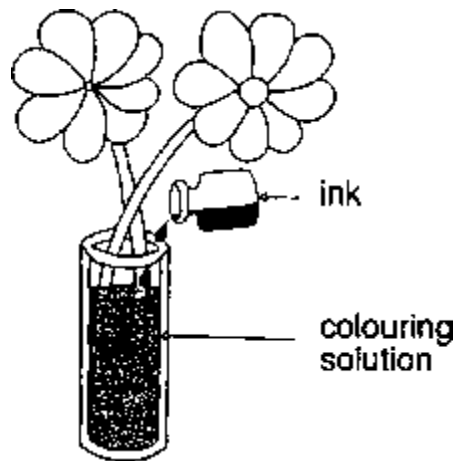
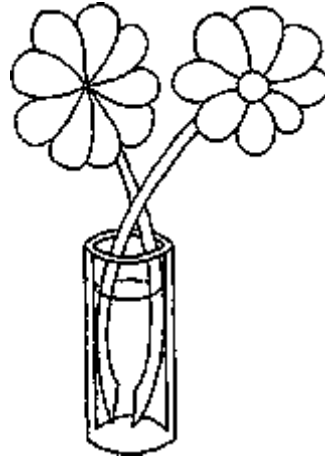

Observation:

The colouring solution can soon be seen in all parts of the plant. The way it moves up the stem can be clearly observed.

Analysis:

Water is conducted into each part of the plant by the plant's vascular tissue. Thus, a permanent water supply is guaranteed.

Importance in Nature:

The water has to get somewhere. Otherwise the plant would be fully saturated, no more water could rise and there would be no more intake of nutrients from the soil. Here once again we see optimal compromise.

The next experiment looks in more detail at water loss.

1.7. THE WATER EVAPORATION OF PLANTS

Main Goal:

This experiment illustrates that plants release water via their leaves.

Information:

Roots absorb water, which is conducted by the vascular tissue to all parts of the plant. The water evaporates via the leaves, so that a constant flow of water is guaranteed.

Materials and Apparatus:

1 thin (young) branch of a deciduous tree

water

oil (plant oil as used for cooking will be best. Do not use motoroil at all. It will damage the leaves by releasing poisonous gases).

1 glass or plastic beaker (about 10 cm in height)

1 glass only (about 20 - 25 cm in height)

Procedure:

The branch is cut obliquely under water and then placed in the smaller glass or beaker which is filled 2/3 full with water. The stalks must be cut under water to prevent the appearance of an embolus of air in the lower part of the stalk. That would prevent the water rising in the stalk. Then oil is carefully poured into the glass to form a 0.5 cm layer on top of the water.

The larger glass is placed upside down over the apparatus. Place the experiment in cool surroundings. This is the only way in which you can see the outcome because the evaporated water will only condense on the walls of the glass if the glass is cool.

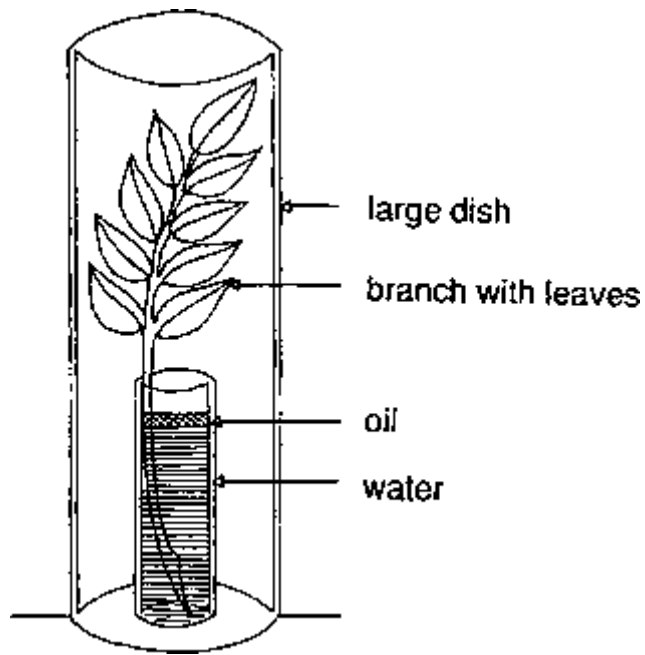

Observation:

Moisture condenses after some time on the inside of the larger glass. The condensed water will firstly form a layer on the wall of the glass and will later flow together to form drops of water.

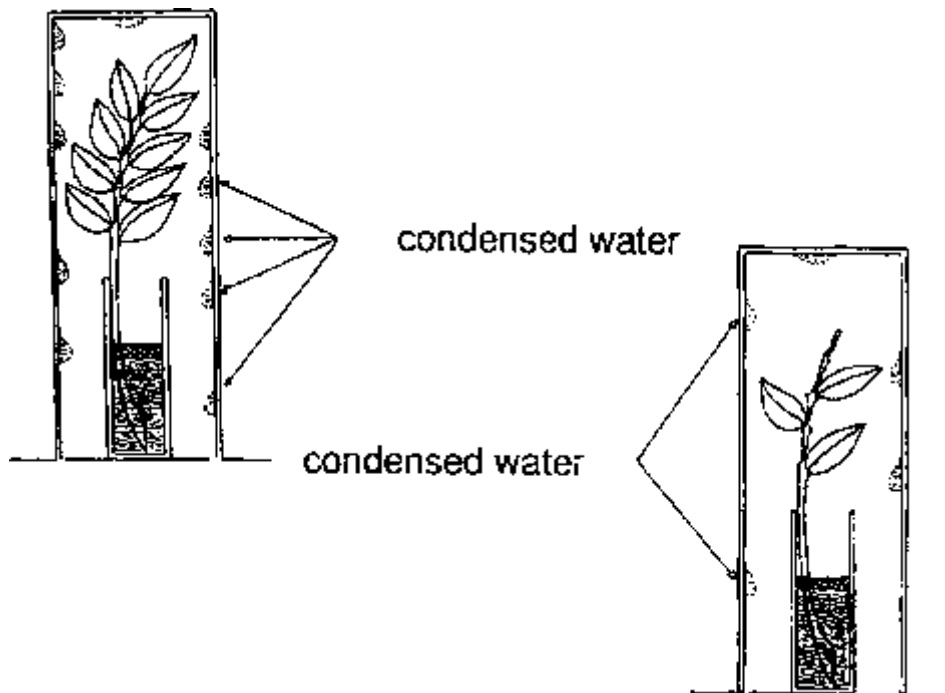

Analysis:

The condensation is water, which can only have evaporated via the leaves.

This process is known as transpiration.

The moisture evaporates through tiny holes on the underside of the leaves.

As the number of leaves increases, so too does the transpiration via the leaves.

Addition:

The water can be identified with dried white copper sulfate, which turns blue.
(see experiment: THE COMBUSTION PRODUCTS OF A FLAME.)

Practical Meaning:

There are different devices which prevent a plant drying out.

The plant protects itself by:

- thick leaves covered with a layer of wax;
- thick shoots with a tissue that can store water;
- bark formation;
- closing the stomata in the leaves in certain circumstances;
- growing dry hair on the lower surface of the leaves.

1.8. THE IMPORTANCE OF MINERAL SALTS

Main Goal:

This experiment shows that plants cannot live without mineral salts.

Information:

The seedlings obtain proteins, fats, carbohydrates, the nutrients necessary for their growth from the seed leaves.

To retain their vital functions, plants synthesize the nutrients in various metabolic processes. In order to do this, mineral salts and water are indispensable.

Terrestrial plants absorb the mineral salts, which are dissolved in the soil, through their roots.

Materials and Apparatus:

20 beans plants or other plants

2 glass or plastic vessels

2 pieces of wire gauze (or 8 test tubes with flint pebbles to hold the plants)

tap water

distilled water

1 bucket loamy soil

Procedure:

Put a small shovel of soil into the bucket and add a large amount of water, so that you can stir the soil. Then fill the two dishes with the water obtained from the soil. This water contains nutrients from the soil. Put the gauze onto the dishes and ten beans on each of

them. Make sure that the beans are regularly moistened. Watch the experiment to prevent fungi starting to grow. When the beans are about 5 cm high, replace the soily water from one of the dishes and replace it with distilled water. Rinse off the roots of those ten beans thoroughly but very carefully, **without removing them from the gauze**. Then put those beans into the vessel with distilled water.

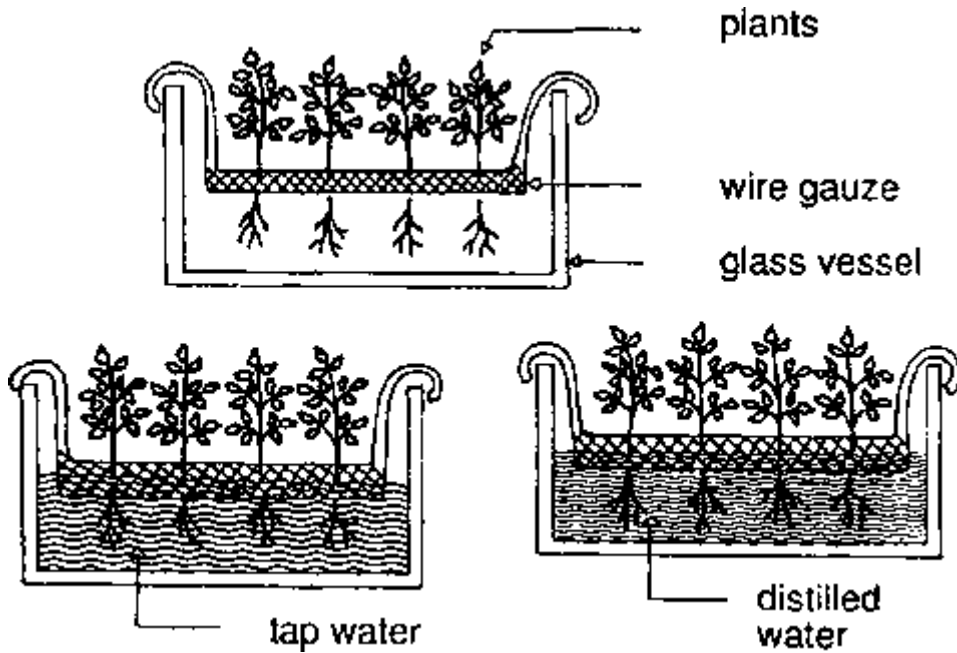

Observation:

After a few days it can be observed that the plants in the distilled water develop poorly.

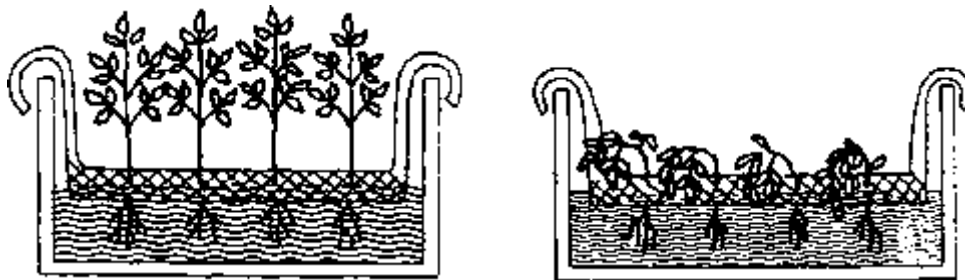

Analysis:

Distilled water does not contain mineral salts. Like soil, normal water contains mineral salts. These are necessary for the vital functions of the plants.

1.9. PLANTS PRODUCE OXYGEN

Main Goal:

This experiment demonstrates that a gas, oxygen, is produced during photosynthesis.

Information:

In their green leaves, with the help of sunlight, plants produce glucose and oxygen from carbon dioxide and water. This process is called "photosynthesis".

Materials and Apparatus:

In different countries there may be other plants which are suitable for this experiment, waterweed (elodea)

glass vessel

funnel with a short or shortened neck (see figures)

rubber stopper

a wood chip

matches

Procedure:

Bind about 15 stems of waterweed together with a piece of thin wire or a thread. Place them in a vessel which is filled with water almost up to the rim. The cut parts of the waterweed must point upwards. Put the funnel over the waterweed. Make sure that the top of the funnel neck is under water. (See figure) Then fill the test tube up to the rim with water. Seal it with your thumb. Turn it over and place it, still sealed with your thumb, into the water in the vessel. Place the tube over the funnel neck without pulling the tube out of the water. This is the only way, of placing the tube over the funnel neck, while retaining the water in the tube. - When the tube is nearly full of gas produced by the waterweed, take a glowing wood chip, remove the test tube from the funnel neck, turn it up and place the glowing wood chip into the tube.

Observe what happens.

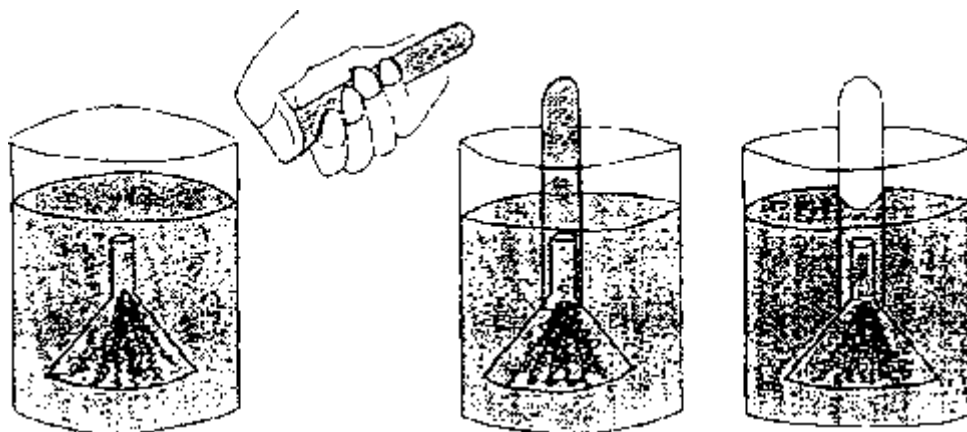

Observation:

Gradually the water in the tube is replaced by gas. The glowing chip lights up.

Analysis:

The gas produced by the waterweed could be oxygen or methane. You can exclude methane since, although it is a gas left by anaerobic bacteria in rotting organic

matter, it is poisonous to plants.

Importance in Nature:

Human beings and animals need oxygen to breathe. That is: We depend on plants producing oxygen, as do all animals. Therefore it is necessary to protect plants and the areas where they grow.

See experiments botany 1.12 und human biology 2.10.

1.10. STARCH FORMATION IN LEAVES

Main Goal:

This experiment serves to identify a product resulting from photosynthesis, namely starch.

Information:

Starch is one of the most important reserve substances of green plants. It is found as assimilation starch in the chloroplasts of green leaves.

Materials and Apparatus:

*a. plants with relatively large leaves
paper
pair of scissors
needles*

*b. 3 dishes
water
alcohol (96%)
iodine solution
(iodine-potassium iodide solution 1%)*

Procedure:

a. As shown in the diagram below, the leaves are covered with patterns. The plant stays like this for one day and one night. The experiment to detect starch can be carried out after the plant has been sunlit for at least three hours the next morning.

b. The leaves are cut off the plant and the patterns are removed. **Before heating the water put the alcohol aside so that it cannot be inflamed.** Boil the leaves for about five to ten minutes (depending on the hardness of the tissues of the leaves used).

After extinguishing the burner the leaves are dipped into the alcohol until the chlorophyll is almost extracted. This should take about five minutes. Then place the leaves upside down on a plate and drop up to five drops of the iodine solution onto each leaf. Rub the solution into the tissue of the leaves with the tip of a small stick. Leave the experiment for about one or two minutes. Then rinse the leaf.

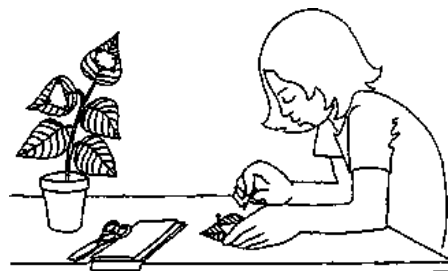

Observation:

Where starch is present the iodine will turn to a bluish brown or a deep dark brown. Parts without starch will become only a little bit yellow brown.

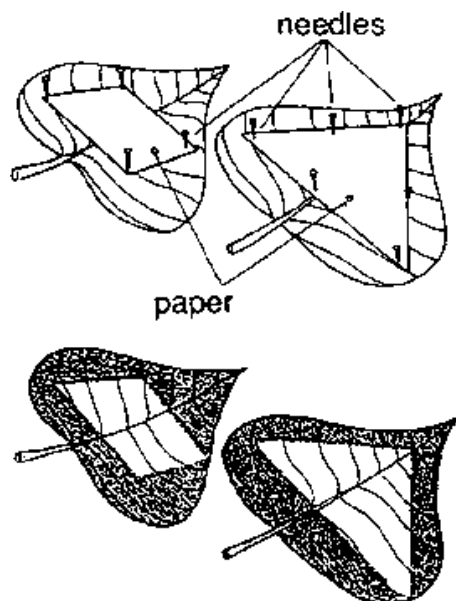

Analysis:

Iodine colours starch bluish brown or deep dark brown.

For the starch formation, chlorophyll and light are indispensable.

Addition:

Starch is the typical vegetable reserve carbohydrate, e.g. of grain.

Potatoes have a high starch content. When iodine-potassium iodide solution is dropped onto a cut potato, the surface turns a black-blue colour immediately.

(The blue-black colouring results from an inclusion of iodine molecules into the twisted arrangement of the starch molecules.)

1.11. THE PRODUCTION OF GASES BY PLANTS UNDER DIFFERENT CONDITIONS

Main Goal:

This experiment demonstrates that the amount of gas produced by plants depends on the amount of carbon dioxide available.

Information:

Plants transform the carbon dioxide from the air or water with water and energy from sunlight into sugar and starch. During this procedure so much oxygen is produced that the plant cannot use it all. This surplus of oxygen escapes from the plant.

Materials and Apparatus:

a glass vessel, e.g. a jam jar
boiled water which has been left to cool down
soda water
waterweed (other plants have to be tested)
one watch to count minutes

Procedure:

Fill the vessel up to one cm below the rim with tap water. Place a piece of waterweed into the water. Wait one minute. Watch and count the bubbles rising from the stem for exactly one minute. The bubbles are best if they large and discharged at a rate of not more than about ten a minute. Then change the water and place the waterweed into the boiled cooled water. Observe whether the plant continues to produce gas bubbles. After a few minutes pour some soda water into the vessel. Wait a minute and observe the plant. If it starts producing gas again, wait two minutes and then count the bubbles once more for exactly one minute. Compare the results obtained.

Observation:

In the first case you will note a few bubbles, in the second case there will be no bubbles, and in the third case you will see more bubbles of gas than in the first case.

Analysis:

Tap water contains a little carbon dioxide, enough for the waterweed to produce sugar and then a surplus of oxygen. In boiled water there is no carbon dioxide and the plant cannot act. The plant is not dead, however as we can see from the fact that it produces a lot of bubbles after adding soda water, which contains a large quantity of carbon dioxide.

Importance in Nature:

With this experiment, botany 1.10 and human biology 2.10 you can explain by yourself the circle of oxygen and carbon dioxide in nature and how animals and human beings depend on plants and vice versa.

1.12. THE TRANSPIRATION OF PLANTS

Main Goal:

This experiment shows that a large amount of water evaporates through plant leaves (more than evaporates from an open surface of water).

Information:

Plants transpire through their leaves.

On the lower side of the leaf there are many small pores, stomata, through which the steam escapes. Only one percent of the surface of the leaf is covered with those stomata, but more water escapes there than from a surface of water as large as the whole surface of a leaf.

Materials and Apparatus:

a big beaker (about a litre), e.g.
a preserving jar a dish measuring about 20 cm in diameter, e.g. a plate
a platform balance with several weights
a bunch of twigs with leaves

Procedure:

Put the bunch of twigs into the beaker and fill it up with water. Fill the dish with water too. Put them on the scales so that they balance.

Leave the experiment for about 30 minutes. Then compare the levels of the platforms.

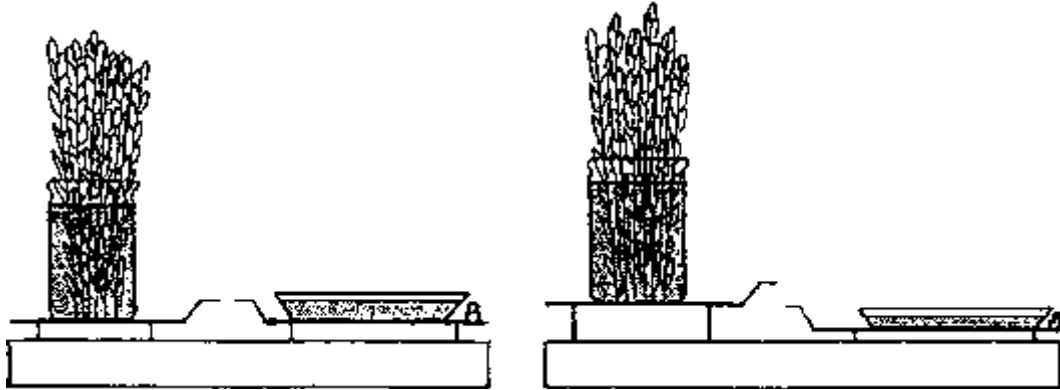

Observation:

The platform with the twigs in the beaker will go up, the other one naturally down.

Analysis:

More water has evaporated through the leaves of the bunch of twigs than via the surface of the water in the dish.

Importance in Nature:

Only a little area of the lower surface of the leaf is needed to release enough water to enable them to take as many minerals from the soil as necessary. The leaf remains stable in this way. There are only small parts where germs can get into the plant. There is another example of optimal compromises in nature.

1.13. GERMINATING PLANTS IN DIFFERENT CONDITIONS

Main Goal:

This experiment shows that seeds, in this case pea seeds, need air to germinate.

Information:

see analysis.

Materials and Apparatus:

*ten pea seeds (other seeds have to be tested)
two dishes with a rim high enough to cover the pea seeds with water
cotton wool or some other such substance to keep the pea seeds moistened*

Procedure:

Put the cotton wool in one of the dishes and place five pea seeds on it. The other five

seeds are placed in the other dish. Fill the first dish with water so that the seeds are just covered. Keep only the cotton wool wet after the seeds have soaked up the water.

Fill the second one up to the rim and keep the water at this level.

Watch the dishes and change water if it becomes grey.

Then there are fungus which will start to destroy the experiment.

Observation:

After 24 hours the seeds are swollen.

After another 24 hours the pea seeds on the cotton wool have germinated, while the seeds under water have not germinated or not to any great extent.

Analysis:

Though there is some oxygen soluted in tap water it is not enough to let seeds germinate. Plants can use their nutrients stored in the seed leaves only if there is enough oxygen available to decompose the starch into sugar.

Addition:

Now you know why the earth has to be loose and wet, when you sow seeds in the garden.

2. HUMAN BIOLOGY

2.1. HEAT RADIATION OF THE HUMAN BODY

Main Goal:

This experiment demonstrates that the human body, like all other substances, emits heat to a colder surrounding.

Information:

The average body temperature of a healthy human being is 37° C. This temperature is maintained by the various metabolic processes (see experiment "HEAT RADIATION").

Materials and Apparatus:

1 thermometer, if possible filled with alcohol rather than mercury

Procedure:

- With the thermometer, the body temperature is measured under the armpits.
- Fix the thermometer in a stand (e.g. a small branch in a pot with sand). Put one hand round the lower tip of the thermometer, close to it, but without touching the tip.

Wait about one or two minutes and note what happens.

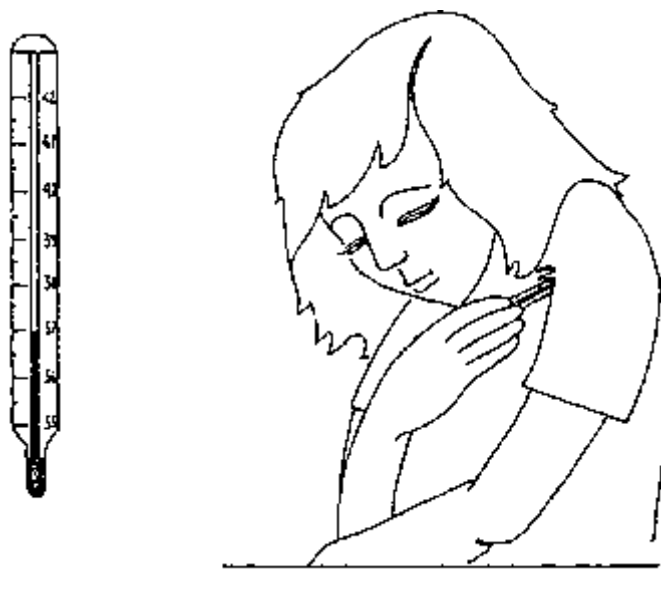

Observation:

- The thermometer indicates about 37° C.
- The thermometer ascends for two to five degrees, depending on the surrounding temperature.

Analysis:

The average body temperature of a human being is 37° C.
The body emits heat to a colder surrounding, e.g., the air.

Practical Use:

Human beings choose their clothing according to the outside temperature. To keep the heat radiation of the body at a low level, the Eskimos in Greenland wear thick furs. In southern warm countries, thin and often lightly coloured clothing is worn. It reflects the radiation of the sun better than dark clothing.

2.2. SENSATION OF WARMTH AND COLD

Main Goal:

This experiment illustrates that the sense of temperature cannot register temperature in an absolute way.

Information:

Covering the skin of a human being are about 250 000 receptors to perceive cold and 30 000 to perceive heat. Temperatures which are too high or too low cause a feeling of pain.

Materials and Apparatus:

1 thermometer
three litres of water one each at a temperature of 5° C,
20° C and 40° C 3 flat dishes

Procedure:

One litre of water is cooled down, in a refrigerator, with ice or by placing it outside at night.

Another litre is heated to about 40° C, and the last litre to about 20° C.

The experiment is set up as shown in the diagram below.

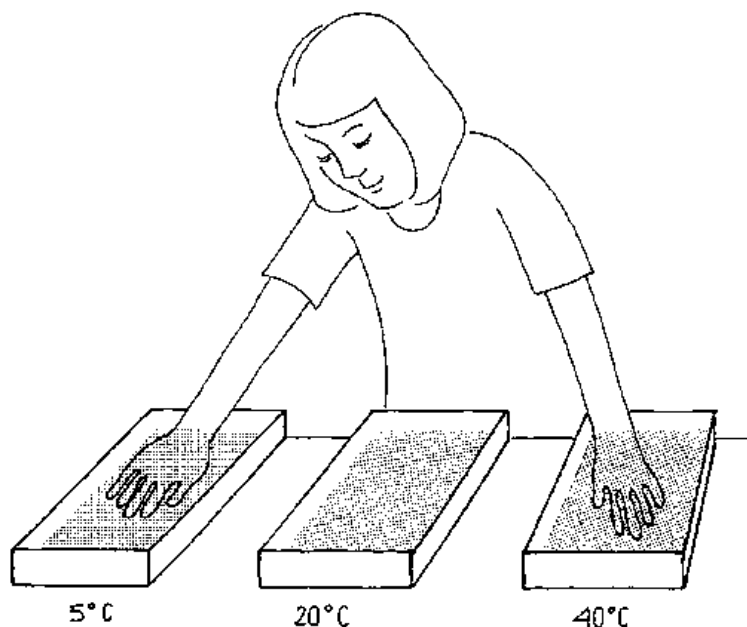

One test person places his left hand into the left-hand dish and the right hand into the right-hand dish. After 5 minutes, both hands are placed simultaneously into the middle dish.

Observation:

The left hand perceives the water in the middle dish to be relatively warm and the right hand perceives it to be relatively cold. After some time the water is perceived as being the same temperature by both hands

Analysis:

Temperatures are perceived with the sense of temperature.

The sense of temperature needs some time to adapt to sudden variations in temperature.

Thus it is only reliable up to a certain point.

Addition:

Non-heated rooms such as a cellar, are perceived to be cool in summer and warm in winter, although the temperature is higher in summer than in winter.

2.3. THE TASTE BUDS ON THE TONGUE

Main Goal:

This experiment shows that the tongue is divided into various areas which perceive different kinds of tastes.

Information:

On the surface of the tongue are taste bud areas which are capable of distinguishing between sweet, sour, salty and bitter. These areas can be easily located.

Materials and Apparatus:

sugar

sodium chloride - household salt

1 lemon

magnesium sulphate or one bitter grapefruit

4 cotton buds or wooden spatula

4 flat glass receptacles

1 cloth

Procedure:

Watery solutions of each of the above-mentioned substances and fruits should be prepared. A test person is blindfolded.

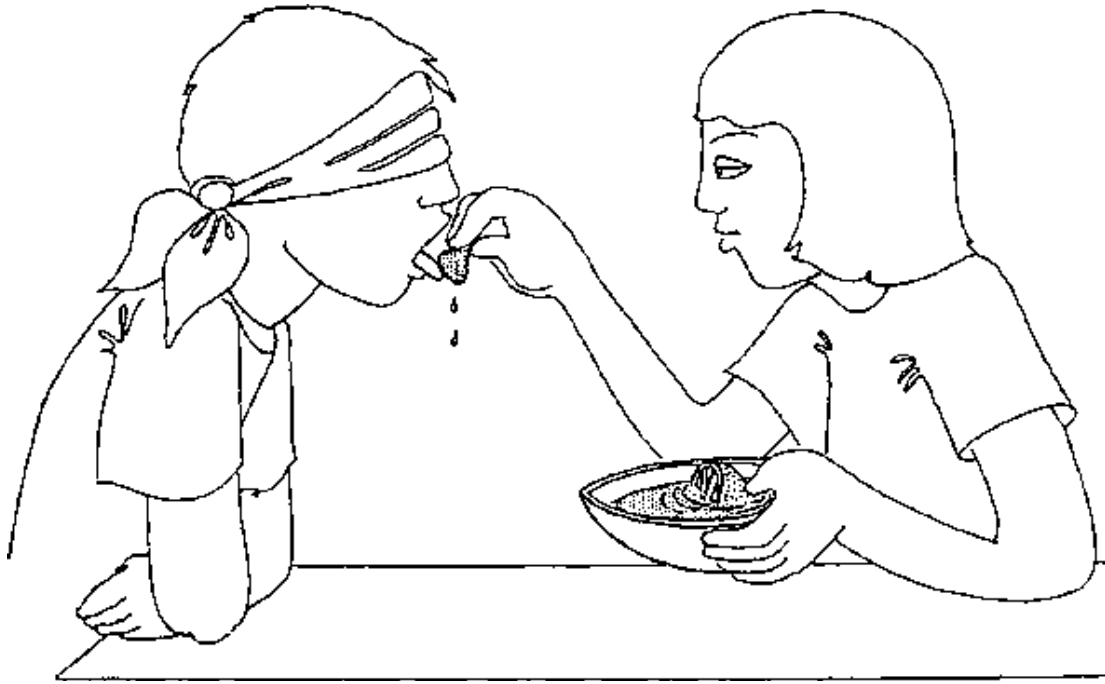

The solutions are placed on his/her tongue with the cotton buds. The test person states on which part of the tongue he tastes the solutions. The test person must rinse out his/her mouth with water between tests.

Observation:

Sweet tastes are perceived on the tip of the tongue.

The front edges of the tongue perceive salty substances.

The rear tongue edges perceive sour substances, and bitter ones are tasted in the retrolingual region.

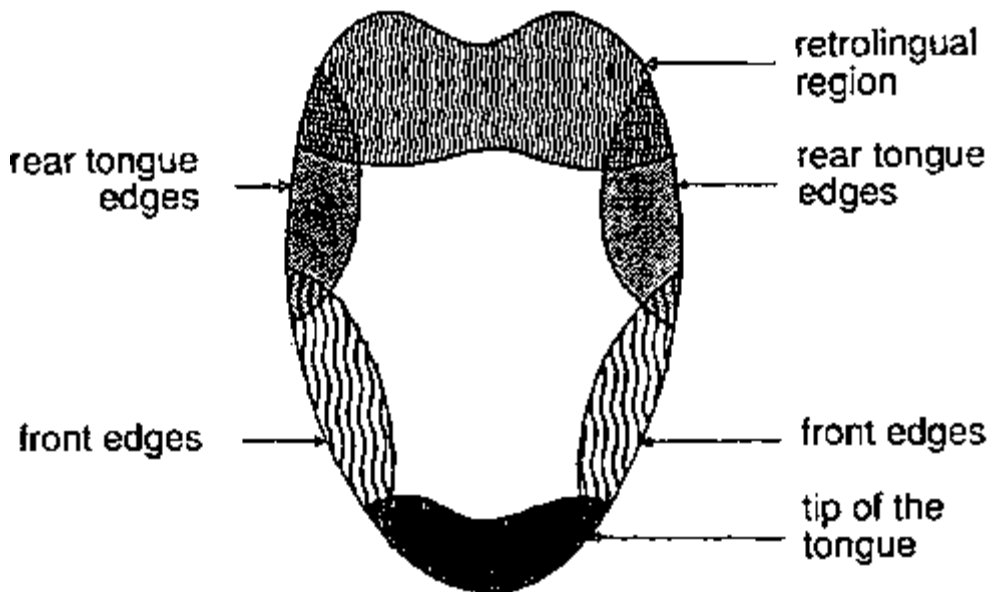

Analysis:

The taste bud areas are shown above in the form of a diagram.
The four different kinds of taste can be perceived best in the above areas.
The tastes overlap at the extremities of each zone.

Addition:

The knowledge of the places where you perceive the four different tastes is of no use at first, for you will seldom taste only one of the four tastes, when you eat anything. But if you think about your taste of a meal, you can imagine what happens in your mind with all the single tastes, composed in a very tasteful meal: Your tongue distinguish only four different tastes, in your mind find hundreds of different tastes, all composed by only the four, plus the taste "hot".

2.4. THE SENSATION OF TASTE AND SMELL

Main Goal:

This experiment demonstrates the interaction of the senses of smell and taste.

Information:

Four different areas of taste are located on the tongue:

sweet, salty, sour, bitter.

However, feelings of taste are created by an interaction of the sense of taste with the sense of smell. The latter is located on the mucous membrane of the nose. Besides this, the sensation of taste is affected by the sensations of warmth, cold, pain and touch.

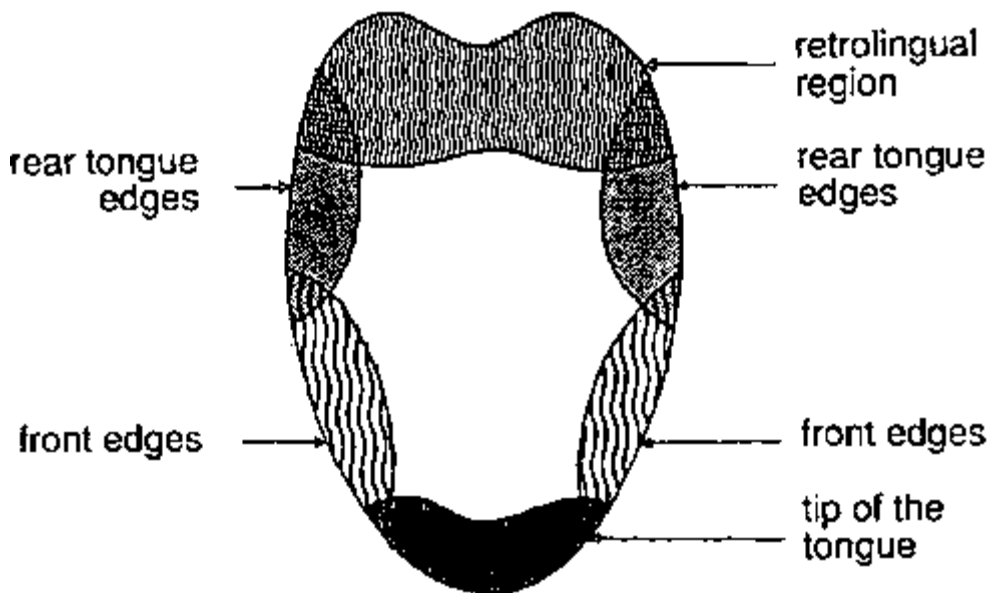

Materials and Apparatus:

- 1 apple
- 1 potato
- 1 onion

3 spoons
1 grater
3 dishes
1 cloth

Procedure:

The fruit and vegetables are grated and placed on the dishes.

One test person is blindfolded.

Using the spoons, the grated apple, potato and onion are put onto the tongue of the test person one after the other. After each test the test person rinses his/her mouth with water. The test person identifies the taste.

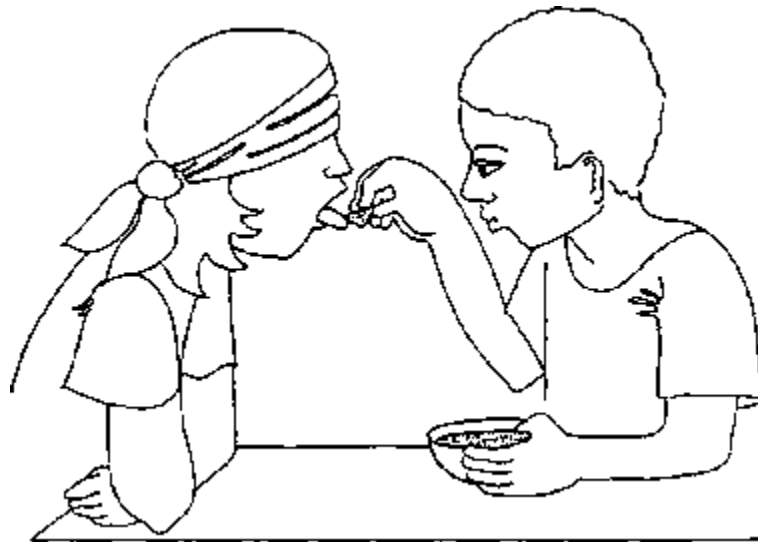

The second test is performed in the same way, but this time the test person holds his/her nose.

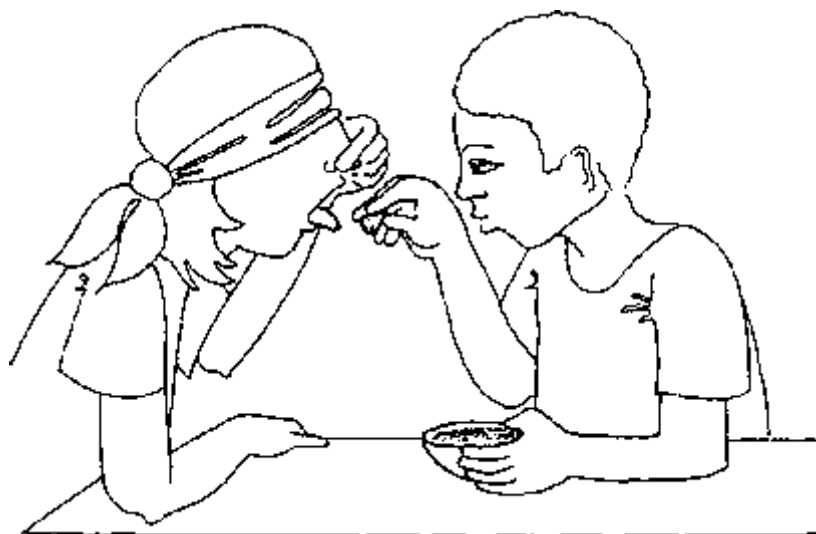

Observation:

When the test person holds his/her nose, the sensation of taste is significantly weaker.

Analysis:

There is an interaction between the sensations of taste and smell.

Addition:

It is well-known that to a person with a bad cold, food “has no taste”. Refer back to experiment 2.3 and complete your knowledge of tasting a meal.

2.5. STARCH BREAKDOWN IN THE MOUTH

Main Goal:

This experiment illustrates that starch breakdown starts in the mouth.

Information:

In the mouth, food is chewed into small pieces and moistened with saliva. The saliva is formed in the salivary glands, two sublingual, two lower jaw, and two parotid glands.

Saliva consists of mucus and the enzyme “ptyalin”. This enzyme causes the catabolism of starch into maltose. This catabolism continues in the stomach until the enzyme is made ineffective by hydrochloric acid, which is found in the stomach.

Materials:

- a few cubes of bread*
- a few tubes*
- iodine-potassium iodide solution 1%*

Procedure:

Put one cube of bread into a tube. Then drop so much of your saliva into the tube that the cube of bread becomes wet through. Drop about three drops of the iodine solution onto the cube. It turns dark blue. Keep the tube warm by closing your hand around the tube. Look periodically at the colour in the tube.



Observation:

After several minutes the colour changes from dark blue to light brown.

Analysis:

The enzyme ptyalin has catabolized the starch to sugar. Sugar cannot be tested with iodine solution. Therefore the blue colour disappears. This proves that the digestion of food starts in the mouth.

2.6. THE CINEMA EFFECT

Main Goal:

An expressive demonstration of the imperfections of the human eye.

Information:

The human eye does not register individual stimuli which hit the retina within less than an eighteenth of a second. One uniform impression is created.

Materials and Apparatus:

*one cardboard disk, about 5 cm in diameter
a piece of string
coloured pencils*

Procedure:

On one side of the cardboard disk a bird is painted and on the other side an upside-down cage.

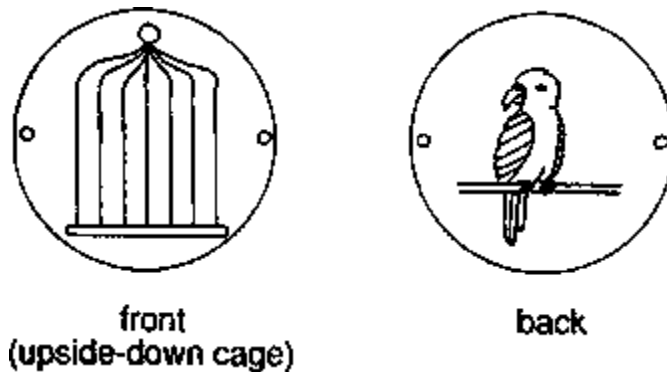

The string is cut into two pieces. Each of them is made into a noose. The nooses are attached to the opposite edges of the disk exactly in the middle of the drawing. (See diagram below.)

The free ends of the strings bands are firmly held, and then the disk is turned until the two strings are completely twisted. Then pull the ends of the strings in opposite directions. (If you pull too strongly you may tear the strings out of the holes in the cardboard.) The disk rotates rapidly and should be allowed to twist the strings in the other direction by loosing the pull on the strings. Then pull again and so on.

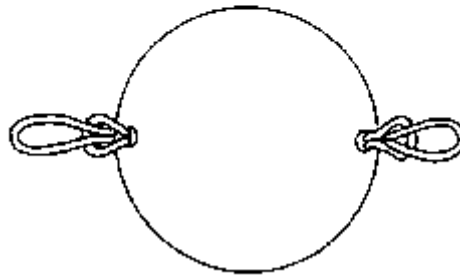
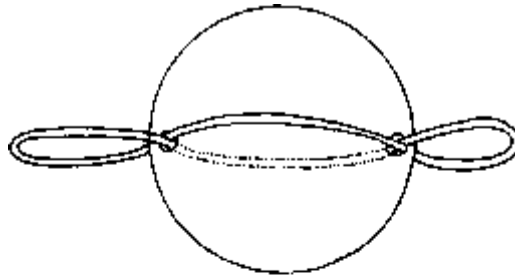

fastening of the strings

Observation:

Initially, the disk turns so quickly that the bird seems to be sitting in the cage.

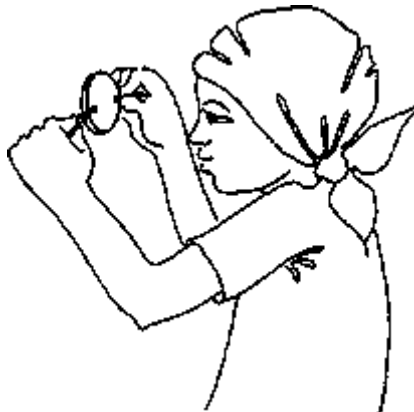

Analysis:

The rapid sequence of images cannot be separated by the eye into single images. The sluggishness of the eye is responsible for this “cinema effect”, which is the melting together of single images into one animated image. This effect can be produced at a speed of 18 pictures a second. Most films in the cinema and the television work with 24 or 25 pictures a second to avoid any flicker.

2.7. THE BLIND SPOT

Main Goal:

An experimental demonstration of the blind spot.

Information:

Rods and cones cells which are sensitive to light, are parts of the retina.

Nerve fibers conduct stimuli to the optic nerve and then to the visual centre of the cerebral cortex.

Where the optic nerve emerges, there are no rods and cones, so that an image cannot be created. This spot is called the "blind spot".

The brain completes the missing part of the image from its surrounding. Thus there is no "hole" in the field of vision.

Materials and Apparatus:

light cardboard, measuring about 10 cm x 3 cm
scissors
coloured pencil

Procedure:

The cardboard is prepared as shown in the following diagram. (Other symbols can also be used.)



The cardboard is held at arm's length in front of the right eye, and the left eye shut. The right eye focusses on the cross, and then the cardboard is slowly moved towards the eye.

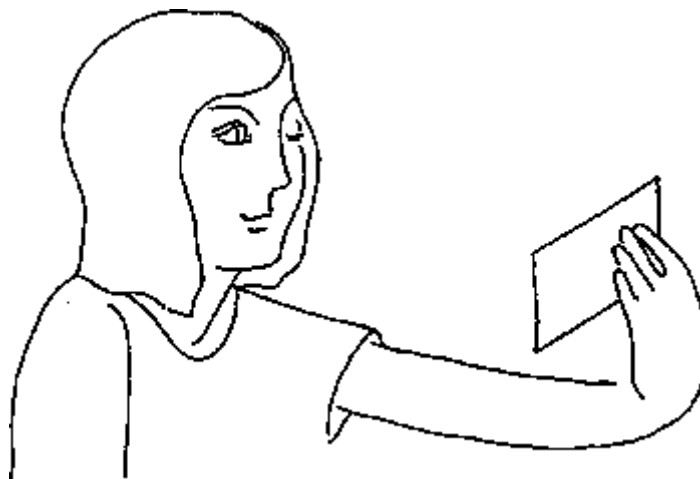

Observation:

The circle "disappears", when the cardboard is a certain distance from the eye.

Analysis:

Light stimuli, which hit the optic nerve, are not transformed into an image. The spot where the optic nerve emerges is called the “blind spot”.

2.8. A MODEL DEMONSTRATING THE FLEXIBILITY OF THE SPINE

Main Goal:

This experiment illustrates the flexibility and the stability of the spine.

Information:

The spine of a human being is shaped like a double “S”. The spine of a baby or an ape is shaped like a single “S”.

Materials and Apparatus:

2 solid pieces of wire about 50 cm long

a wooden board measuring about 10 cm x 20 cm different weights weighing about 50 - 200 g or other objects which can be hung at the top of the spine models.

Procedure:

As shown in the drawing below, the two wires are fastened onto the board and bent. Make sure that the curves are exactly at the same points as shown in the figure. Bend the two spine models so that the top is exactly above the fixing point of the lower part of the spine models. (This is indispensable for the success of the experiment.)

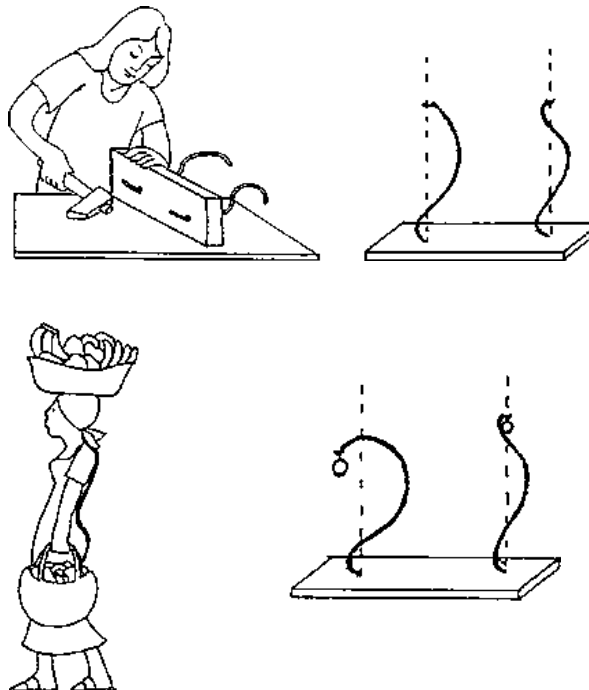

Identical weights are hung from each spine model.

Observation:

The single S-shaped spine sags to a greater extent than the double S-shaped spine.

Consequences

The double S-shaped spine of adolescents and adults is more stable than the single S-shaped spine of babies and apes.

Practical Meaning:

The spine of an adult can be subjected to great pressure.

Because it is more flexible, it absorbs vibrations resulting from walking upright. This protects the brain against the usually occurring vibrations.

In many countries, loads, e.g. water jugs, are carried on the head, because this makes the transport easier.

2.9. COSTAL RESPIRATION

Main Goal:

This experiment illustrates costal respiration.

Information:

When you breathe in, the volume of your chest increases. The muscles between the ribs contract, lifting the ribs, with them the breast bone (sternum) and therefore the complete chest (thorax).

Abdominal breathing usually takes place simultaneously with costal respiration.

The muscular diaphragm contracts, so that it flattens, presses onto the internal organs, and moves the abdominal wall forward. The lungs follow this expansion. Breathing out provokes the reverse sequence.

Materials and Apparatus:

*cardboard (or stiff paper)
scissors
cord, paper clips, rubber bands or blades of grass*

Procedure:

A model is made as shown in the following diagram.

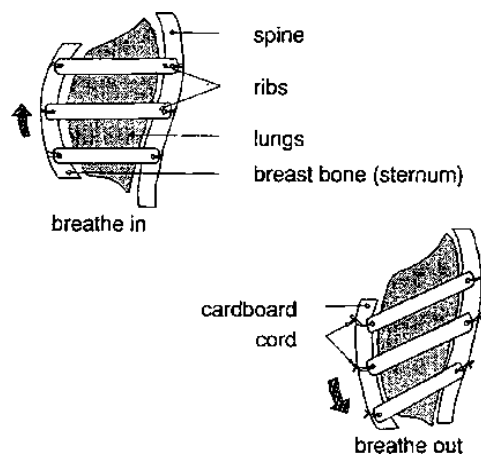

Observation:

If the breast bone is lifted, the chest widens. In reality the lungs expand.

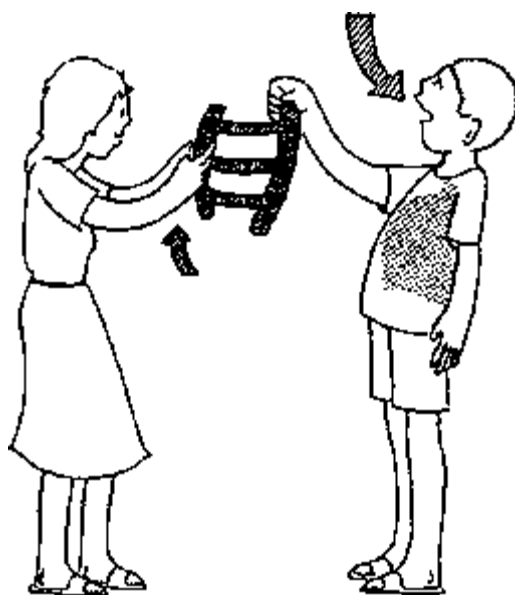

Analysis:

Because of the volume expansion, the air pressure in the lungs drops so that it is lower than the external air pressure. A lower pressure is thus formed and the pressure of the external air forces air into the lungs.

When you breathe out the air zone becomes smaller and the air is pressed out.

Addition:

If you pant you will see quite clearly that the abdominal wall arches forward when you inhale. The chest is hardly lifted. If you place one hand flat on the abdominal wall, you can feel the respiratory movement.

2.10. IDENTIFICATION OF CARBON DIOXIDE IN EXHALED AIR

Main Goal:

This experiment illustrates that exhaled air contains carbon dioxide.

Information:

The constituents of food are catabolized into carbon dioxide, water and urea. Carbon dioxide is exhaled. The carbon dioxide proportion of inhaled air is about 0.03% and the oxygen proportion about 20% volume. The carbon dioxide proportion of exhaled air is approximately 4.5% and the oxygen proportion 15.5% volume.

A solution of limewater ($\text{Ca}(\text{OH})_2$ in water) or a solution of ($\text{Ba}(\text{OH})_2$ in water), baryta water, is used as a carbon dioxide indicator.

Materials and Apparatus:

*calcium hydroxide or lime or calcium oxide (CaO)
barium hydroxide (made from barium oxide)
water
glass beaker
a glass pipe, a straw or a hollow bamboo cane
filters or clean paper from a cement sack*

Procedure:

If no calcium hydroxide (or barium hydroxide) is available, calcium oxide (or barium oxide) should be dissolved in water. These solutions are filtered until they are completely clear.

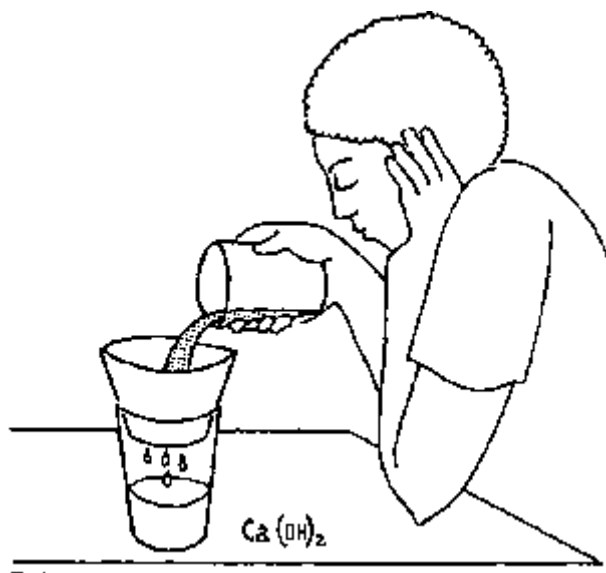
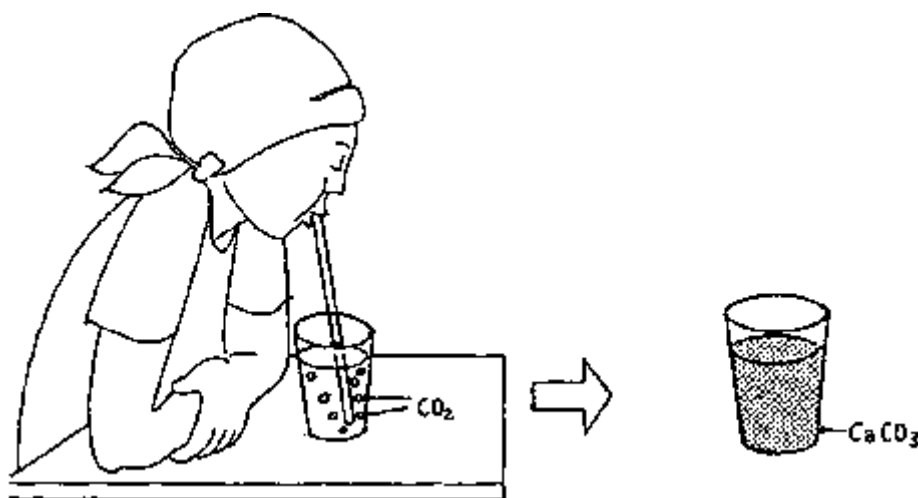

Exhaled air is blown into limewater through the glass pipe.

Observation:

The limewater (baryta water) becomes cloudy.
A white substance is precipitated.

Analysis:

Exhaled air contains so much carbon dioxide that it reacts with calcium hydroxide to form white, hardly soluble calcium carbonate. In the reaction with barium hydroxide, white, hardly soluble barium carbonate is precipitated.

Practical Importance:

With the help of sunlight, plants produce carbohydrates and oxygen from carbon dioxide and water.

Oxygen is essential for human beings and animals.

Addition:

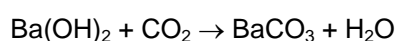
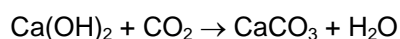

Leaving limewater or baryta water in direct contact with air does not cause clouding because the carbon dioxide concentration is too low.

Look up the experiments botany 1.10 and 1.12. Together with the experiment above you can now explain the circle of oxygen and carbon dioxide in nature.

2.11. THE SKIN RELEASES SODIUM CHLORIDE

Main Goal:

This experiment shows that sodium chloride is released by the skin.

Information:

The main task of the perspiratory glands in the skin is to regulate the body temperature. Besides water, sweat contains other products, predominantly sodium chloride - or household salt. This is why perspiration has a salty taste.

Materials and Apparatus:

a. *distilled water - available at any garage*

*2% silver nitrate solution (AgNO₃), which can be purchased from a chemist
large beaker holding 1 - 2 litres*

b. *magnesia sticks, which can be obtained from*

*a chemist
1 candle*

Procedure:

a. The glass dish is filled with distilled water.

A test person places one hand into the water and holds it there for about 10-20 minutes.

Then a few drops of silver nitrate solution are added to the distilled water.



b. Sodium ions can be identified using magnesia sticks and a candle flame. The top of the magnesia stick is moistened with sweat and then held in the candle flame.

Observation:

- A white precipitate is formed.
- It can be observed that the flame burns yellow.

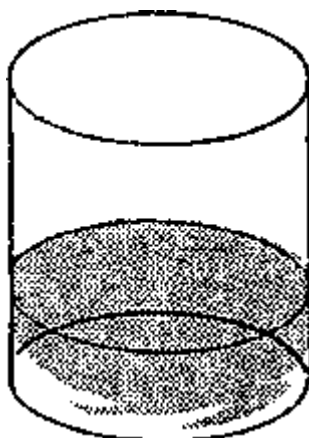

Analysis:

- The chloride ions together with silver nitrate form white silver chloride.**

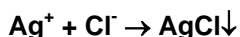

- The yellow colouring of the flame indicates the presence of sodium.**

Practical Meaning: The skin releases warmth by evaporating water on the skin and with that a remarkable amount of sodium chloride. The loss of water is as problematic as the loss of sodium chloride. Losing too much water can cause circulatory problems.

In countries where it is always hot, it is important that the body receive sufficient sodium chloride, otherwise the high loss of sodium chloride in perspiration can lead to circulatory disturbances as well.

In the last centurie British miners became ill, suffering from too little sodium chloride after sweating very strongly. After drinking weak saltwater they recovered. The products left by perspiration are not all waste products. Nature is not perfect. There are optimal compromises everywhere.

2.12. FINGERPRINTS

Main Goal:

This experiment shows that fingerprints are a typical characteristic of each individual.

Information:

Fingerprints are determined by the structure of the lines of the fingertips.

Materials and Apparatus:

ink or ink pad
white paper

Procedure:

One fingertip is coloured with ink and pressed onto the paper once.

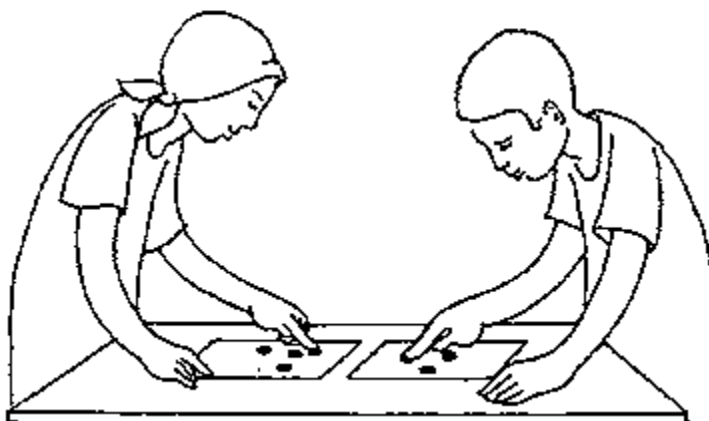
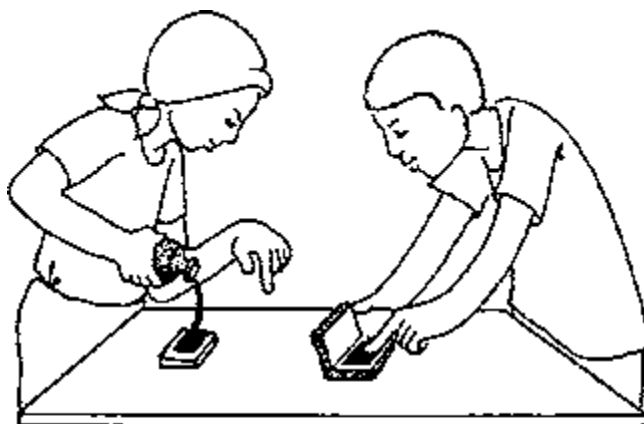

Observation:

A pattern of lines can be seen in black. This pattern is the fingerprint.

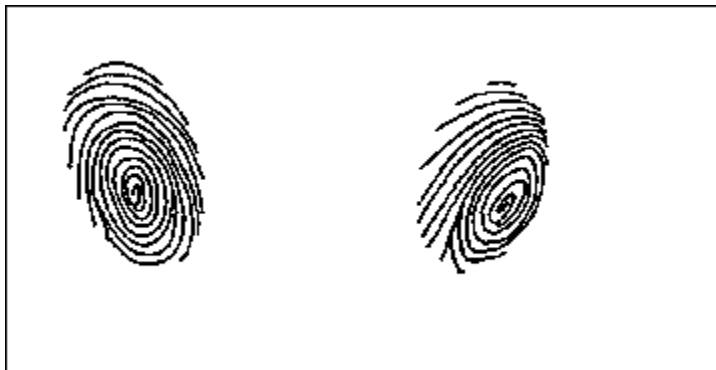

Analysis:

If the fingerprints of different individuals are compared, it can be seen that all of them are different.

Practical Use:

As the fingerprints of every human beings are unique, they are used as an important means of identification in criminology, when they can be used to identify a criminal.

2.13. DISTINGUISHING SEVERAL MATERIALS BY TOUCHING THEM WITH THE FINGER TIPS

Main Goal:

This experiment demonstrates that your finger tips can be used successfully to identify different surfaces.

Information:

see analysis

Materials and Apparatus:

You will require several objects with different surfaces such as a stone, a brick, pieces of bark from different trees, pieces of rough and smoothed wood, different textiles etc.

a scarf or shawl to blindfold a person.

Procedure:

One student is blindfolded and is given three objects to touch and retain the feeling. Then the scarf is removed. The student is allowed to test all objects and he/she must then determine which she/he touched while blindfolded.



Observation:

Different students will show different abilities to identify the objects they touched while blindfolded. But every one is able to distinguish very different things.

Analysis:

In our finger tips we have many sensory cells for touching far more than e.g. on our back.

The more of these cells there are in any area, the better we can identify different surfaces. The largest number of sensory cells for touching per square millimeter are in the tip of our tongue, but you should not test materials which may not be clean with your tongue.

The differences in the results stem from the different experience in identifying things by touching.

2.14. TESTING PULSE FREQUENCY UNDER DIFFERENT CONDITIONS

Main Goal:

This experiment demonstrates that the rate of the pulse depends on the work done immediately prior to measuring.

Information:

see analysis

Materials and Apparatus:

one watch to measure minutes

Procedure:

Look for your pulse on your wrist using the thumb of your other hand. You will find it one thumb length away from the back rim of the hand above the sinews of the inner side of

your arm.

You will probably need a little while to find it and feel it well.

One person, perhaps your teacher, says, observing the watch: "go" and you start counting the pulse beats. When he says: "stop" (after exactly one minute) you note the number of pulse beats you counted.

Then everybody does ten knee bends. After this someone gives a starting signal again and you count the pulse beats again for one minute.



Observation:

In the second case you will count a higher number of pulse beats than in the first. You may also be breathing faster especially if you are unaccustomed to sport and physical exercise.

Analysis:

Your body registers the work you do, in this case the knee bends.

It is able to regulate the pulse frequency in order to provide the muscles with enough blood for them to receive sufficient oxygen. That is also why you breath faster.

2.15. DETERMINING THE DIRECTION FROM WHICH A NOISE COMES

Main Goal:

This experiment demonstrates that with both ears you can better determine the direction from which a noise comes than with only one ear.

Information:

see analysis

Materials and Apparatus:

a scarf or shawl to blindfold a person

Procedure:

All students sit in a circle. One of them stands blindfolded in the center of the circle. One student in the circle knocks on something e.g. his chair to produce a noise. The blindfolded student has to point in the direction from which the noise came without turning round.

Another student knocks from a different direction, the blindfolded student points to the source of the second noise.

Repeat the experiment several times.

After ten trials the blindfolded student holds his/her hand over one ear and the experiment is repeated another ten times.



Observation:

With both ears the blindfolded student will probably achieve about 9 right answers out of ten.

When holding a hand over one ear though the student might achieve a score of only some five or six correct answers, or less.

Analysis:

Our ears are very sensitive. They can distinguish the time lapse which occurs if a noise does not come from immediately in front or behind us.

When one listens with only one ear this time lapse can no longer be heard and it becomes more difficult to determine the source of the noise.

2.16. THE SENSITIVITY OF OUR HEARING

Main Goal:

This experiment shows how sensitive our sense of hearing is.

Information:

see analysis

Materials and Apparatus:

nothing

Procedure:

One student stand in front of the classroom with his face to the wall. Another student whispers a number between thirteen and ninety-nine. The first student has to repeat the number.

Try this experiment ten times initially.

The 'listening' student should then cover one ear, and the experiment should be repeated another ten times.

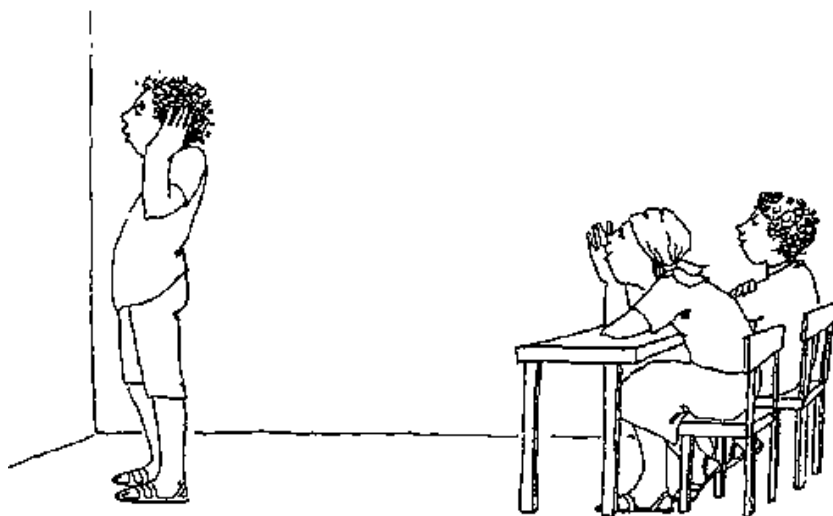

Observation:

In most cases it is not necessary to use both ears to understand whispered numbers.

Where a student does have difficulty he or she may have a hearing impediment.

Analysis:

Both ears are usually equal sensitive. Thus one ear is sufficient to identify whispered numbers.

This test will demonstrate immediately if a student is particularly hard of hearing in one ear.

Hearing difficulties can be caused by many different things and it is always better to consult a doctor immediately.

3. INORGANIC CHEMISTRY

3.1. COMBUSTION ZONES OF A CANDLE FLAME

Main Goal:

This experiment illustrates that the combustion of the gaseous particles of a candle takes place in the outer, the yellow zones of a flame.

In the following text these particles are called “candle gas”.

Information:

The yellow colour of the outer zone of the flame is produced when the soot particles (carbon) light up.

The blue zones of the flame contain candle gas, that is not burning.

The temperature of the yellow zone is higher than that of the blue zone.

Materials and Apparatus:

*matches, magnesia sticks
a candle*

Procedure:

- One match is passed through the flame of the candle (see diagram).
- The same experiment is carried out with a magnesia stick.



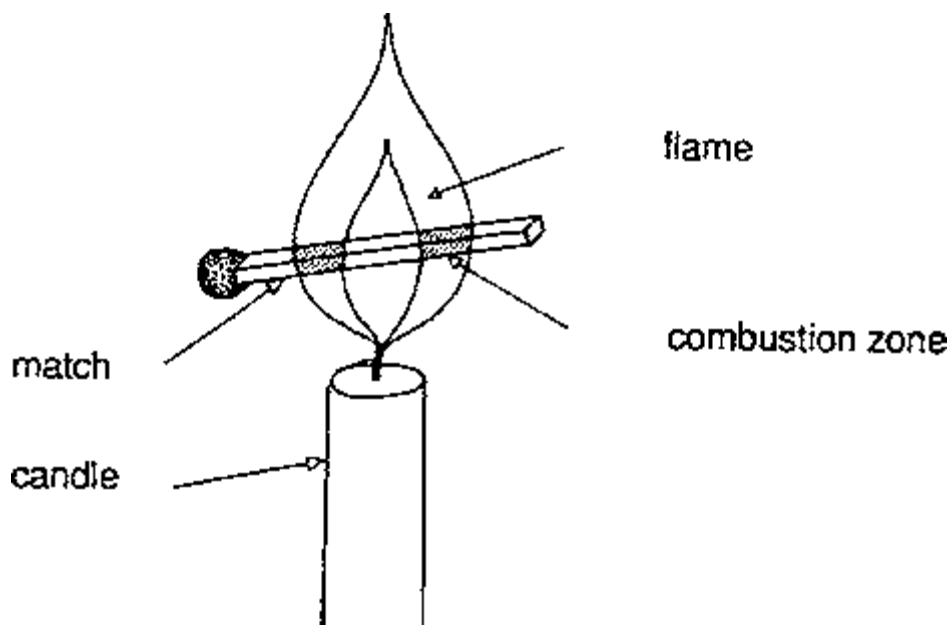

Observation:

- The part of the match in the yellow zone, is burning.
- The part of the magnesia stick in the yellow zone lights up in a yellow-orange colour.

Analysis:

The dark burnt parts of the match and the glowing parts of the magnesia stick demonstrate that the temperature in the yellow zone is higher than that in the blue zone. The combustion of the candle gas takes place in the yellow zone, as it is only here at the outer part of the flame, that enough oxygen is available and can mix with the candle gas.

Practical Meaning:

With this candle flame experiment the basic characteristics of a common laboratory burner or any other open fire can be demonstrated.

In open fires, a good oxygen supply is required to achieve complete combustion.

3.2. THE CANDLE FLAME AND ITS DAUGHTER FLAME

Main Goal:

This experiment demonstrates that the blue zone of the flame contains unburnt candle gas.

Information:

(see experiment: THE COMBUSTION ZONES OF THE CANDLE FLAME)

Materials and Apparatus:

- 2 candles*
- 2 tubes (of metal or glass, e.g. eye dropper)*
- 1 clothes peg*

Procedure:

The candle gas of the blue flame zone is passed through the tube (see diagram).

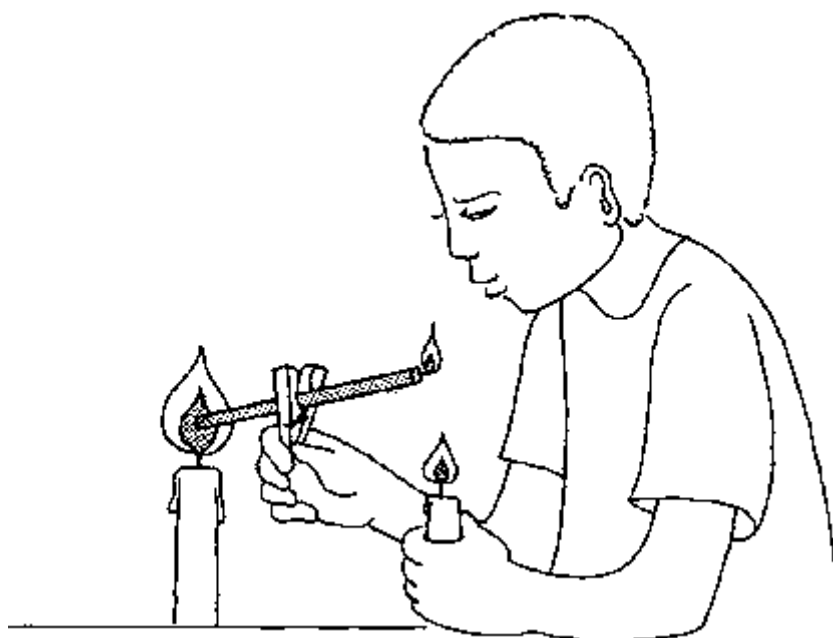
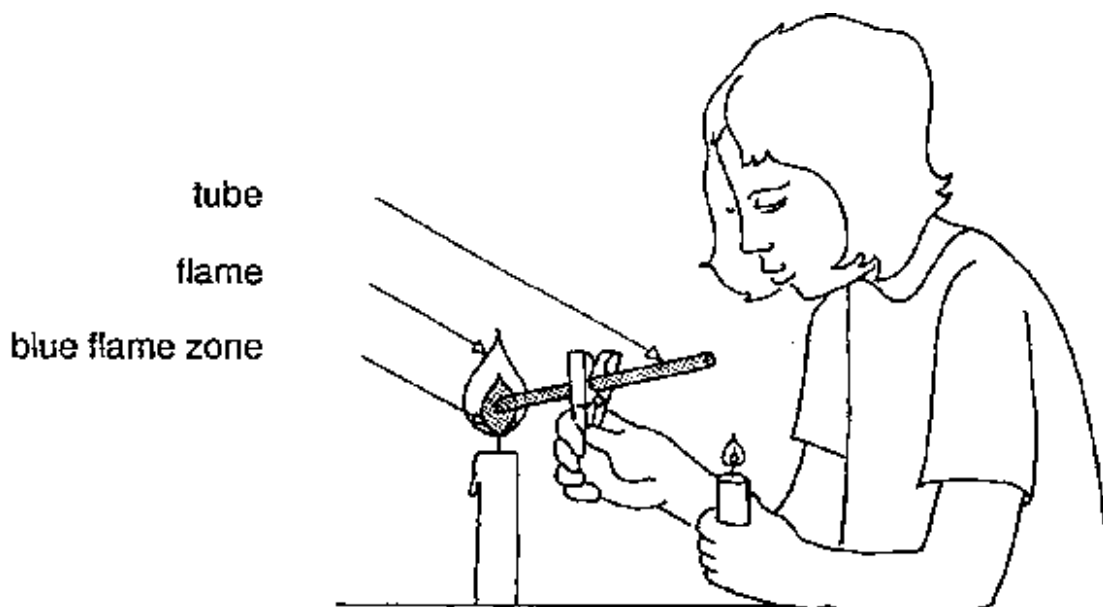

Observation:

This gas can be ignited with a lit candle.

Analysis:

Unburnt candle gas can be found in the blue zone of the flame.

When the candle gas from the blue zone reaches the outer zone, it burns, when atmospheric oxygen and candle gas mix in the right proportion.

Practical Use:

The candle flame has the same structure as the flame of bunsen or alcohol burners.

The most important properties of these burners can be demonstrated with a candle flame.

3.3. COMBUSTION PRODUCTS OF A CANDLE**Main Goal:**

This experiment demonstrates that a candle forms soot (carbon), carbon dioxide and water when it burns.

Information:

The candle substance, natural wax or stearin, consists of the elements carbon, hydrogen and oxygen. Carbon can be identified directly as soot, and indirectly as carbon dioxide.

During combustion water is formed. The presence of water provides indirect evidence of the presence of hydrogen.

Materials and Apparatus:

candle
glass vessel
limewater
white copper sulfate (dried blue copper sulfate)

Procedure:

- a. The bottom of a glass vessel is held over a burning candle.
- b. A cold glass vessel is held upside down over a burning candle.

The water which is produced can be identified with finely pulverized copper sulfate.

- c. A glass vessel is held over a burning candle.

It is then rinsed with limewater to identify the carbon dioxide produced.

(As carbon dioxide is heavier than air, a great amount of it escapes from the glass dish.)

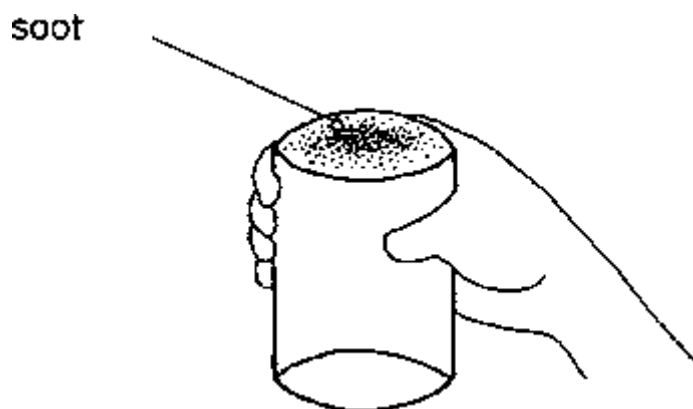
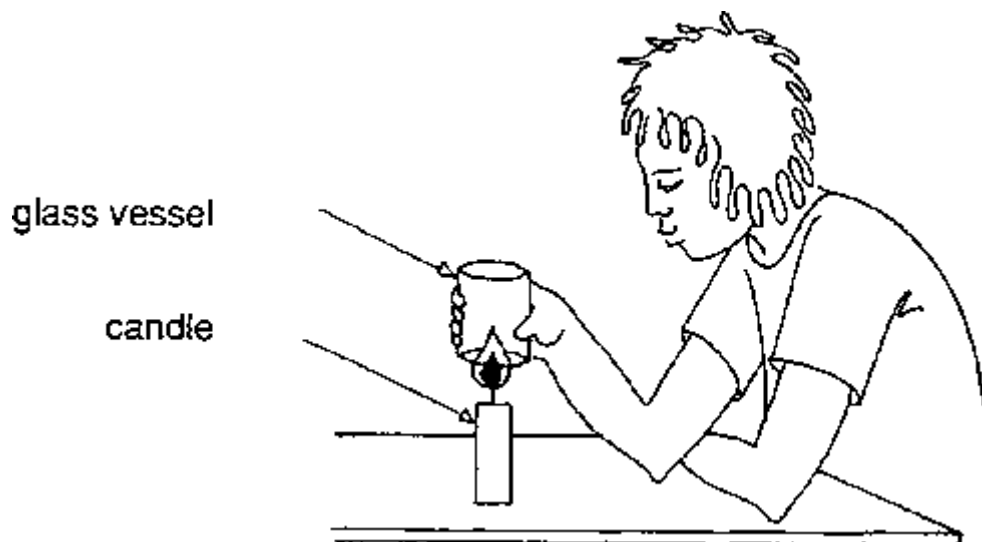

Observation:

- Soot settles on the glass vessel.
- A moist film develops. White copper sulfate turns blue.
- A white precipitate - calcium carbonate - is formed.

Analysis:

The candle substance burns to form soot (carbon), carbon dioxide, and water. Soot is the product of incomplete combustion of the candle substance.

Practical Use:

All organic substances contain carbon and hydrogen.
These elements can always be identified using the above methods.

3.4. THE DETERMINATION OF OXYGEN CONCENTRATION IN THE AIR

Main Goal:

This experiment demonstrates that part of the air is used during combustion.

Information:

The investigation of air compounds shows that air consists of about 20 parts by volume oxygen and about 78 parts by volume nitrogen. The amount of other gases can be ignored for the purposes of the two following experiments. (These other gases are carbon dioxide and inert gases.)

Materials and Apparatus:

- part of a neon lamp (about 30 cm) or a tall glass*
- small candle - should be light enough to float in water*
- rubber stopper*
- large glass dish*
- a clamp stand if available (if not, the glass can be held as shown below)*

Procedure:

As shown in the following diagram, apparatus is constructed, with which the oxygen content of air can be approximately determined.

During combustion of the candle, the rising water fills the space left vacant by the air used to form carbon dioxide and water.

(The candle is extinguished before all the oxygen is used. The carbon dioxide formed dissolves in the water.)

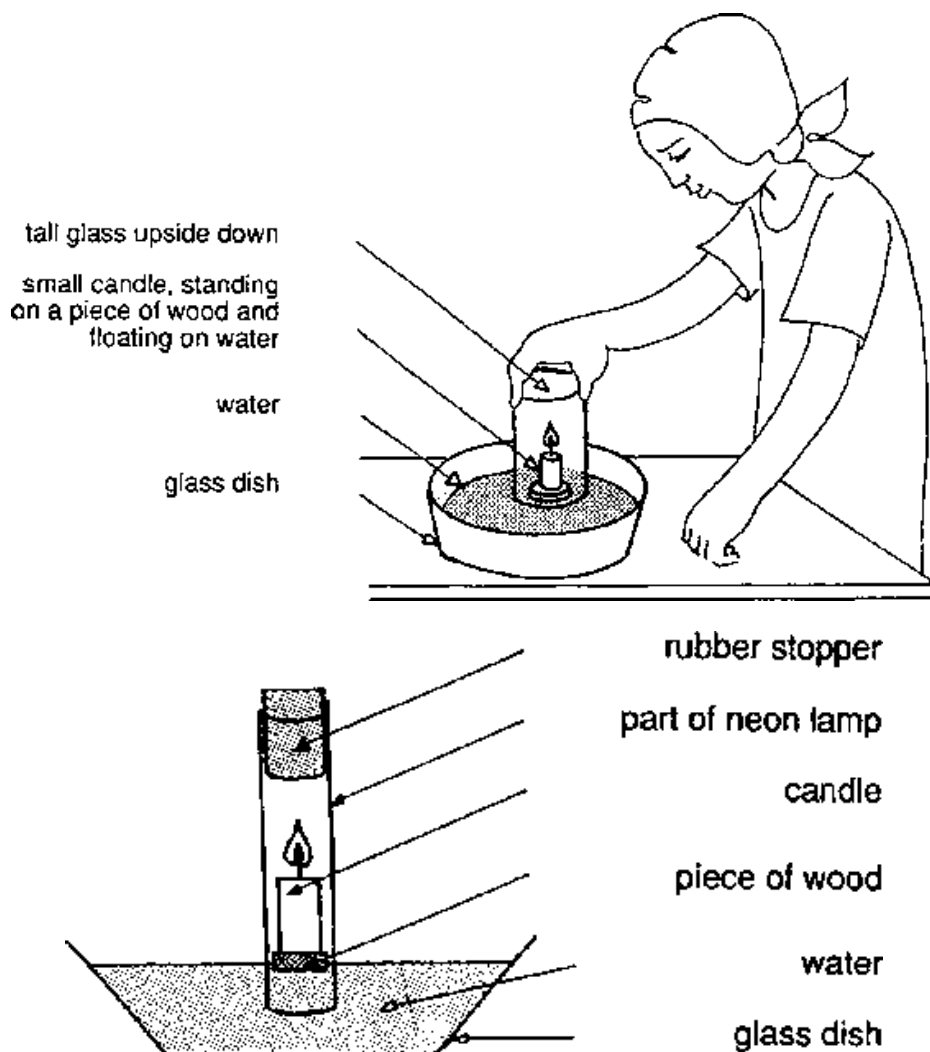

Observation:

While the candle light gradually becomes dimmer, the water level in the neon lamp rises. The rising water occupies about one fifth of the air volume which was present at the beginning of the experiment.

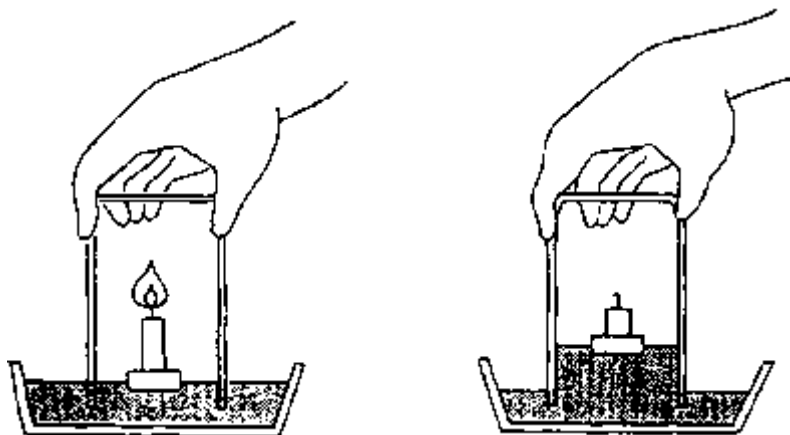

Analysis:

During combustion, the candle uses about one fifth of the air volume. This part of the air is called oxygen.

Practical Meaning:

Plants are the sole producers of oxygen on Earth.

They guarantee the constant oxygen content of the air. Any massive disturbance to the plant world would automatically seriously perturb the lives of man and animals. Human beings and animals need atmospheric oxygen to breathe. During the process of metabolism, carbon dioxide is produced in their bodies. With the help of solar energy, plants produce oxygen and carbohydrates from carbon dioxide and water (CO_2 and H_2O).

3.5. NITROGEN EXTINGUISHES A CANDLE FLAME

Main Goal:

This experiment demonstrates that a candle, or any other kind of flame, does not burn in nitrogen.

Information:

(see experiment: DETERMINATION OF OXYGEN CONCENTRATION IN THE AIR)

Materials and Apparatus:

*part of a neon lamp (about 30 cm) or a tall glass
small candle - should be light enough to float in water
rubber stopper
glass dish
a covering plate made of wood, glass, or metal
a candle attached to a wire*

a stand if available

Procedure:

First the experiment "DETERMINATION OF OXYGEN CONCENTRATION IN THE AIR" is carried out. Then the dish is closed under water with the cover plate and turned upside down.

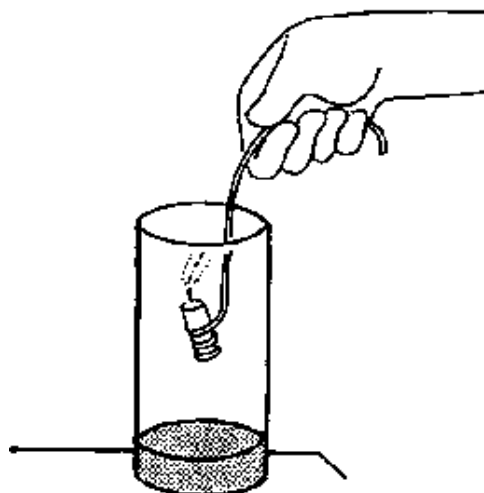
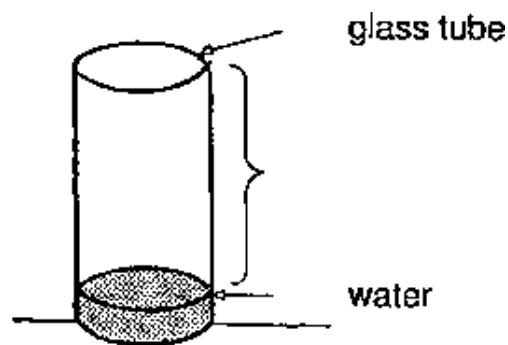
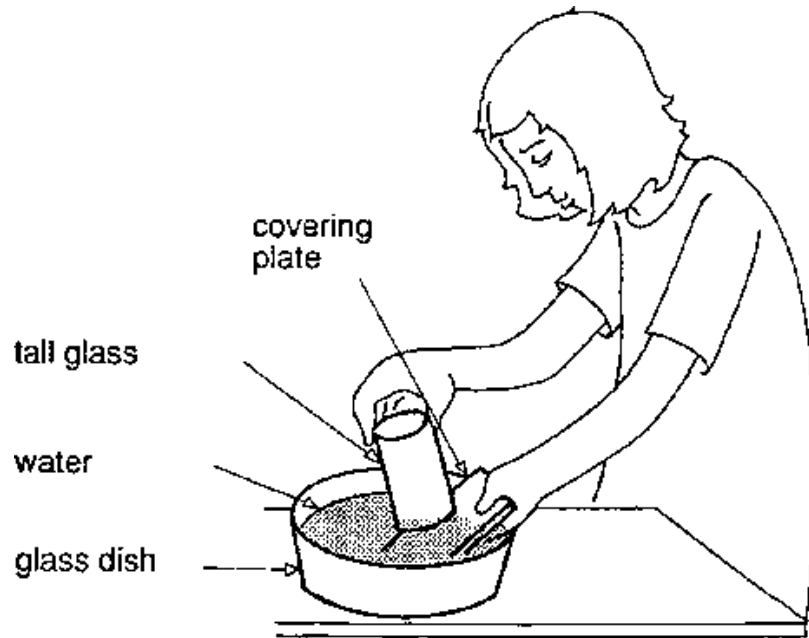

As shown in the diagram below, a burning candle is introduced into the remaining gas.

Observation:

The flame is extinguished.

Analysis:

The remaining gas extinguishes the flame. This gas is called “nitrogen”.

Air consists of about 78% parts by volume nitrogen. (Oxygen supports combustion. Other gases, e.g. nitrogen, carbon dioxide, inert gases do not support combustion.)

3.6. ATMOSPHERIC OXYGEN SUPPORTS COMBUSTION

Main Goal:

This experiment illustrates that combustion can only take place if there is a constant supply of oxygen.

Information:

Without oxygen, combustion cannot take place.

The oxygen necessary for combustion is present in the air. If a burning candle is placed in a small closed volume, it burns until the available oxygen is nearly used up.

Materials and Apparatus:

*candle
glass vessel
cover plate*

Procedure:

- a. A glass vessel is placed upside down over a burning candle (see diagram).



- b. A burning candle is placed in an open glass vessel. With the help of the cover plate, the vessel is first half and then completely covered, (see diagram).

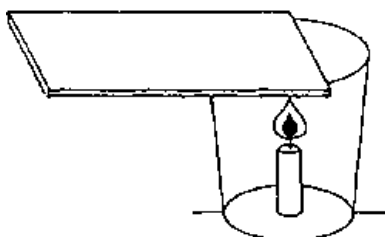

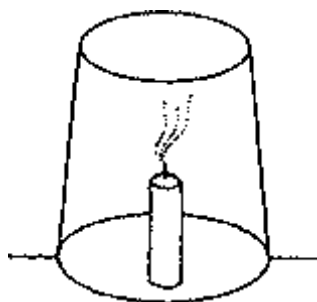

Observation:

- a. During the course of the experiment, the flame gradually becomes smaller until it is finally extinguished.

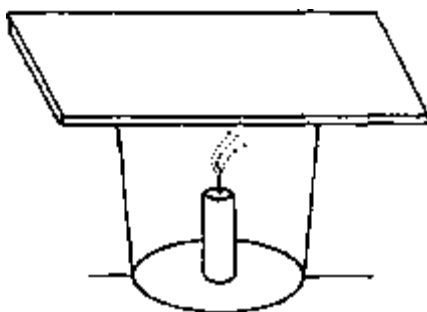

- b. The candle is not extinguished until the vessel is completely covered.

Analysis:

A candle can only burn if there is a constant supply of oxygen.

The component of air which the candle needs for combustion is called “oxygen”.

Practical Use:

The various ways of extinguishing fire all work by preventing the continued supply of oxygen.

Without oxygen combustion does not take place.

Some methods used to extinguish fire include spreading: water, sand, or carbon dioxide over the flames so that oxygen is kept away from them.

3.7. CARBON DIOXIDE AS A FIRE EXTINGUISHER

Main Goal:

This experiment demonstrates that a candle or other burning material is extinguished in carbon dioxide.

Information:

As carbon dioxide is heavier than air, it sinks when poured out of a dish.

Materials and Apparatus:

candle
glass dish or bottle
Alka Seltzer (1/2 or 1 tablet)

Procedure:

One Alka Seltzer tablet is mixed with a few drops of water in a glass dish.

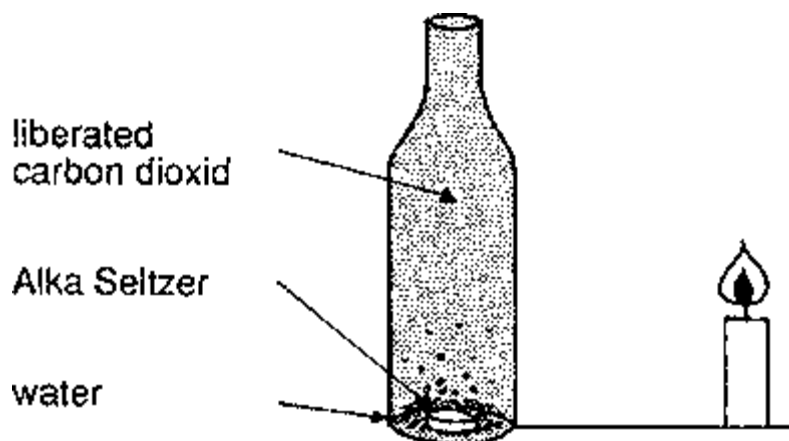

The carbon dioxide liberated is poured over a burning candle.
(A burning candle can also be dipped into the dish.)

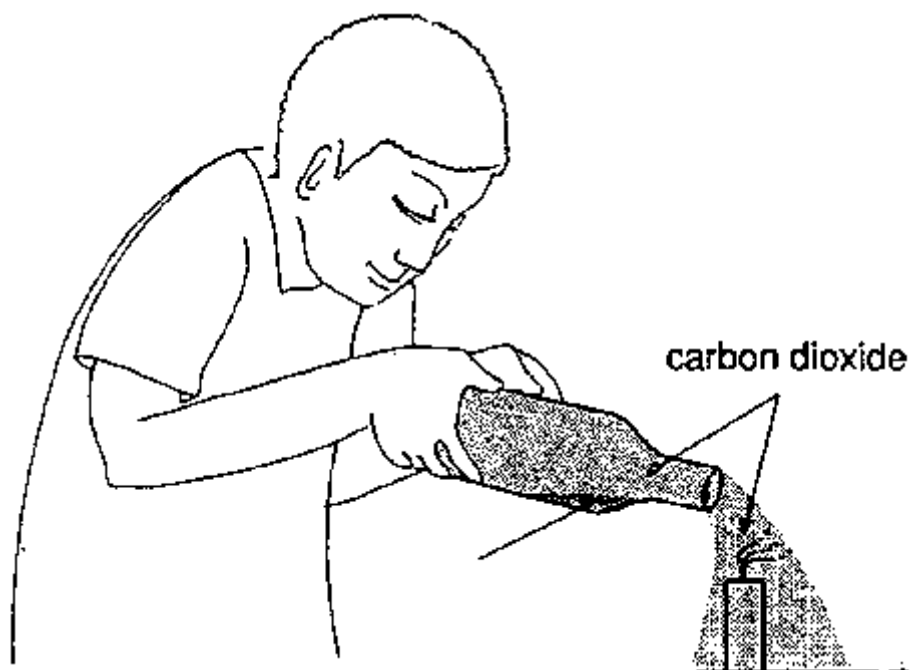

Observation:

The burning candle is extinguished.

Analysis:

A candle is extinguished in an atmosphere of carbon dioxide. Obviously the carbon dioxide is concentrated at the bottom when poured out of the glass dish.

Practical Use:

The air contains 0.03 per cent carbon dioxide by volume. If there is more than 5 per cent of this gas in the air, respiration is impeded. Exhaled air contains about 4 per cent carbon dioxide by volume.

Carbon dioxide does not conduct electricity and does not leave any kind of residue. For this reason it is used instead of water as a fire extinguisher in chemical and nuclear plants.

3.8. THE FORMATION OF CRYSTALS

Main Goal:

This experiment demonstrates the formation of crystals, and proves that dissolved substances are present in solutions, even if they cannot be seen.

Information:

Salts form crystals. The longer it takes for water to evaporate from a salt solution, the more even the crystals become.

Every salt has a typical crystalline form.

On the basis of this experiment, some further terms can be explained:

- solvent
- dissolved substance
- soluble/insoluble
- water-soluble
- precipitation

Materials and Apparatus:

- sodium chloride (household salt)*
- flat dishes*
- 1 glass vessel*
- water*

Procedure:

Household salt is added to 50 ml of water (the solvent), until no more salt will dissolve.

Be sure that no solid salt is present anymore in the saline solution.



About 5 ml of the saline solution is poured into each of the glass dishes.

The water takes several hours or even a day to evaporate.

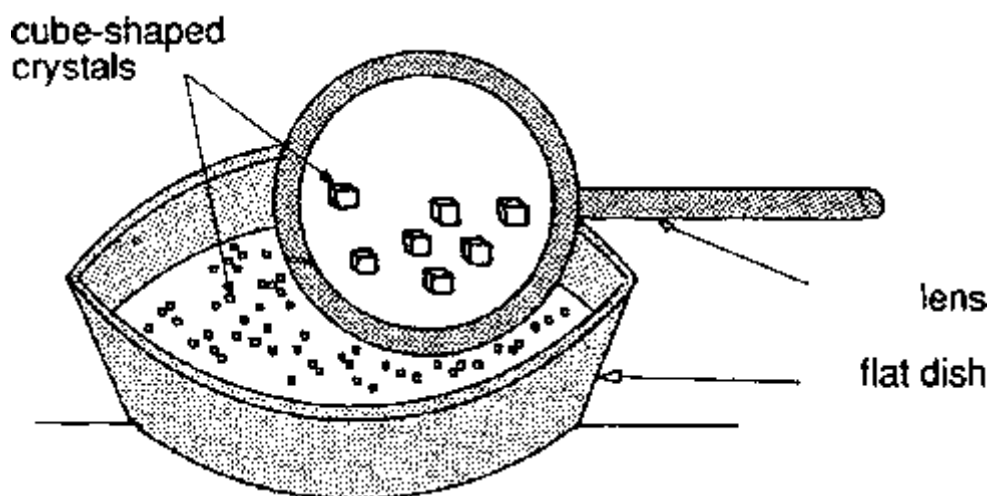

Observation:

The water evaporates.
Cube-shaped crystals form.

Analysis:

Sodium chloride forms cube-shaped crystals.

Addition:

Various substances can be identified from their crystalline form.

Practical Meaning:

Salt is obtained from sea water in some hot countries.

The sea water is channeled into flat basins (salterns).

The sun causes the water to evaporate. The salt, which was dissolved in the sea water, is left as residue. Sea water contains 3% sodium chloride (household salt).

3.9. SALT WATER IS HEAVIER THAN DRINKING WATER

Main Goal:

Solutions always have a density higher than that of the solvent. That is to say that 1 cm³ solutions has great mass and weights more than 1 cm³ of the solvent.

Information:

see "Main Goal"

Materials and Apparatus:

salt water - sodium chloride dissolved in water
drinking water
2 glass dishes, glass stick
ink or other colours

Procedure:

2 - 3 drops of ink are added to the salt water, which is then carefully added to the drinking water. This is best done by means of a glass stick along which the salt water runs down.

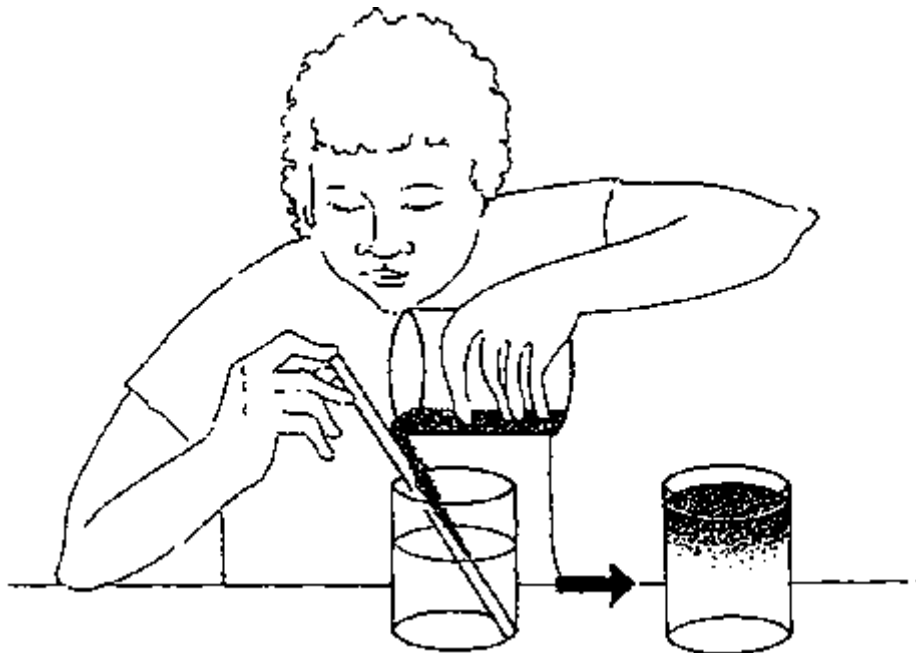

Observation:

The coloured salt water sinks to the bottom of the dish.

Analysis:

Salt water has a higher density than drinking water. However, drinking water also contains dissolved salts. Therefore, it is heavier than distilled water (completely pure water) without any dissolved salts. Solutions have always a higher density than solvents.

3.10. SEPARATION OF SOLID MIXTURES

Main Goal:

The experiment illustrates that solid mixtures can be separated using their physical properties.

Information:

In contrast to a compound, the single substances of a solid mixture exist independently in an unaltered form. Their individual physical properties are preserved. Using these known properties, the single substances can be separated from each other.



Materials and Apparatus:

salt (sodium chloride)
sand iron filings (cutted iron wool)
magnet
filter papers
filter
glass dish
burner, candle
tripod
paper
water
wooden stick, spoon

Procedure:

Salt, sand and iron cuttings are mixed up on a sheet of paper.

(1) The iron cuttings are removed from the mixture with the help of the magnet.

 iron filings
 sand
 salt

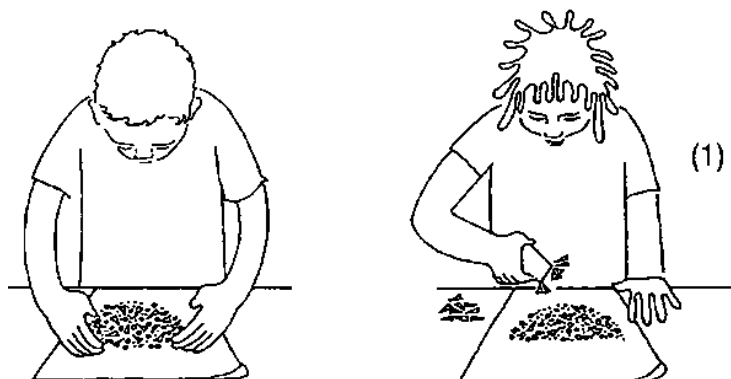

(2) The salt-sand mixture is added to 30 ml of water, stirred well, and filtered. The filtration residue is rinsed 2 - 3 times with water. Then it is dried in the air.

(3) Using the burner, the filtrate (salt solution) is slowly evaporated until it is dry.

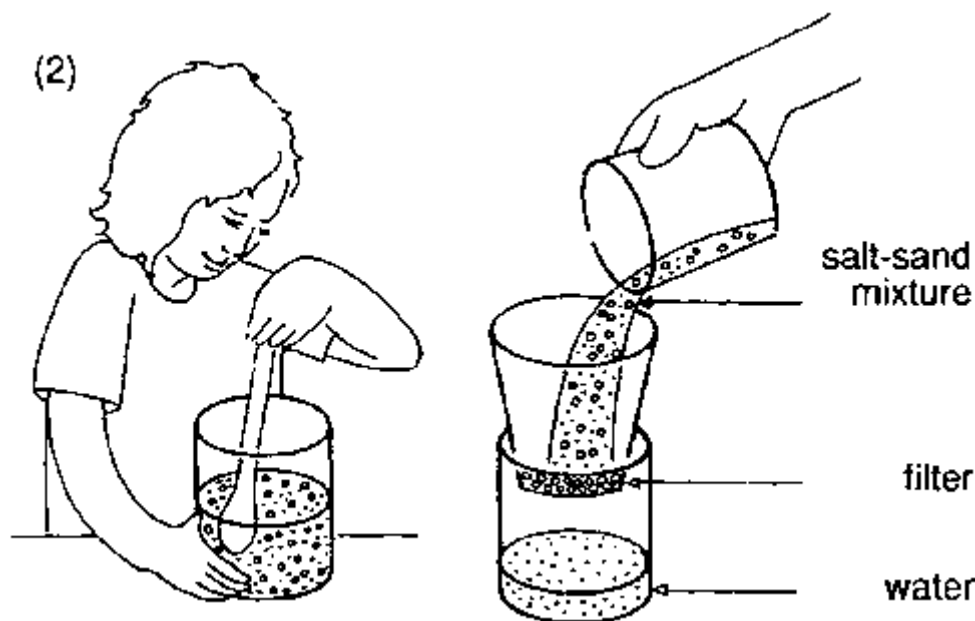

Observation:

The magnet attracts the iron cuttings.

The salt dissolves in water.

The sand does not dissolve but is collected on the filter paper.

After the water evaporates, the salt is left as residue. In a solid mixture, the properties of each substance are preserved.

Analysis:

By means of a magnet, iron is separated from other kind of metals and other substances, e.g. in junkyards.

There are several other methods for obtaining salt. One is by evaporation of sea water and another, the washing out of salty soil.

3.11. THE CORROSION OF IRON

Main Goal:

This experiment demonstrates that moistened iron corrodes faster (corrodere - Latin: to gnaw away), than dry iron.

Information:

When the air is humid, iron reacts with oxygen to form rust.

Materials and Apparatus:

*iron wool, iron filings
2 glass vessels
water*

Procedure:

- a. Some dry iron wool is put into the first glass vessel,
- b. Some wet iron wool is put into the second glass vessel.

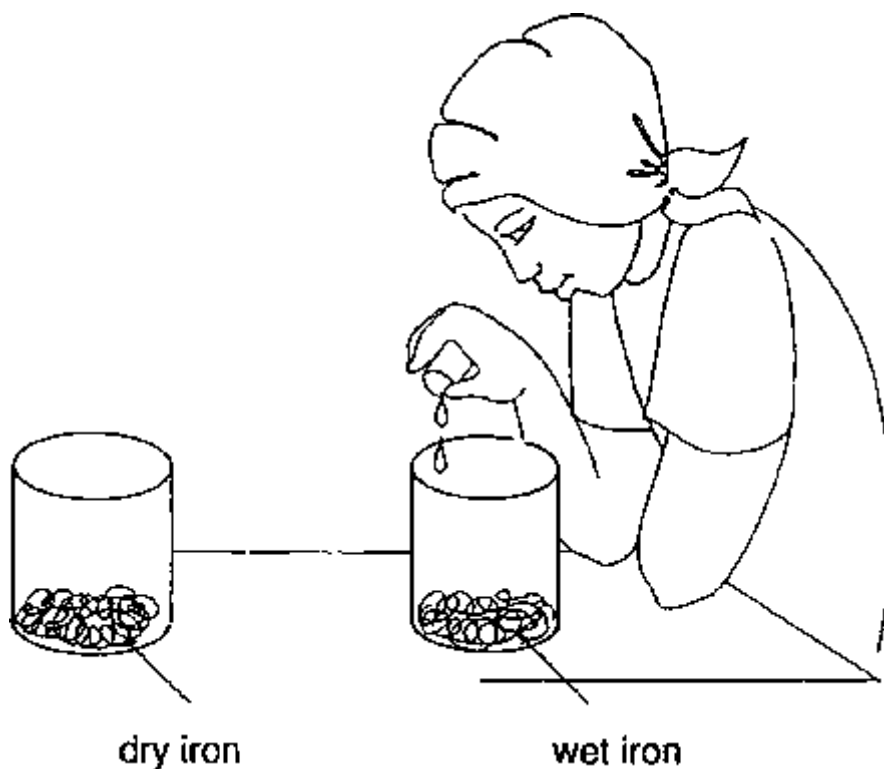

The experiment takes some days.

Observation:

The moistened iron wool has turned a brown colour. It has become brittle.

Analysis:

**It can be concluded that rust has been formed.
Moist iron rusts faster than dry iron.**

3.12. THE IMPORTANCE OF AIR DURING THE PROCESS OF CORROSION

Main Goal:

The experiment demonstrates that air plays a role in the process of corrosion.

Information:

In humid air, iron reacts with oxygen to form rust.

Materials and Apparatus:

*iron wool
1 test tube
1 large glass dish
water
sodium chloride*

Procedure:

a) The experimental apparatus is constructed as shown in the following diagram and observed for several days.

Leave some space between the open end of the test tube and the bottom of the glass dish.

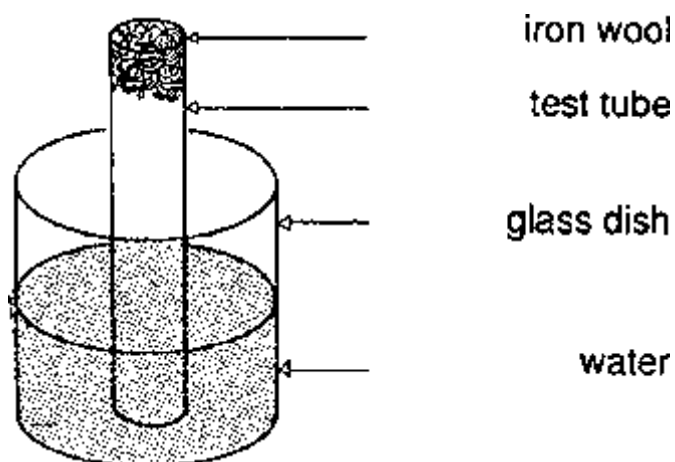

b) Do the same experiment in parallel with salt water in place of water.

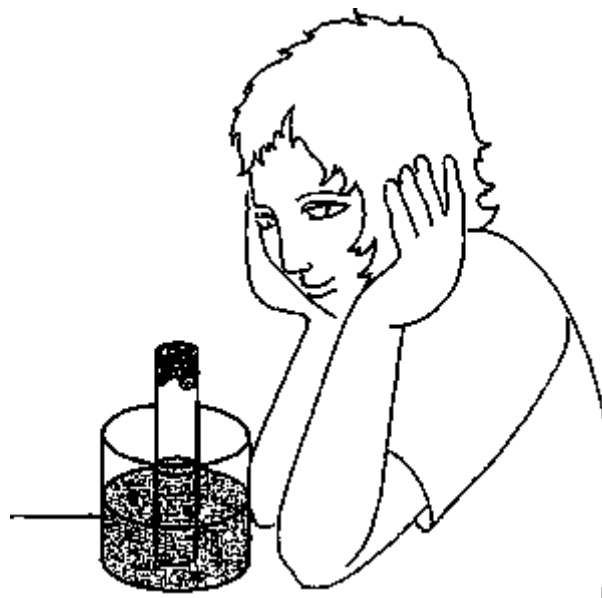

Observation:

The iron wool has corroded.
Some water has entered the test tube.
The corrosion is faster in the presence of a dissolved salt.

Analysis:

When iron corrodes, a part of the air is used to form rust together with the iron and the water. This proportion of the air is called “oxygen”.

Iron corrodes when water and oxygen are present. Its formation is increased by the presence of a dissolved salt.

Practical Use:

Iron is protected against corrosion by a rust inhibitor (special paint).

3.13. TINS ARE PROTECTED AGAINST RUST

Main Goal:

The experiment shows that tins are protected against corrosion.

Information:

Tins consist of tinned sheet iron.
This is iron which is plated with tin.

Materials and Apparatus:

*2 tins
1 nail
2 rags
water*

Procedure:

A pattern is scratched with the nail into one of the tins.



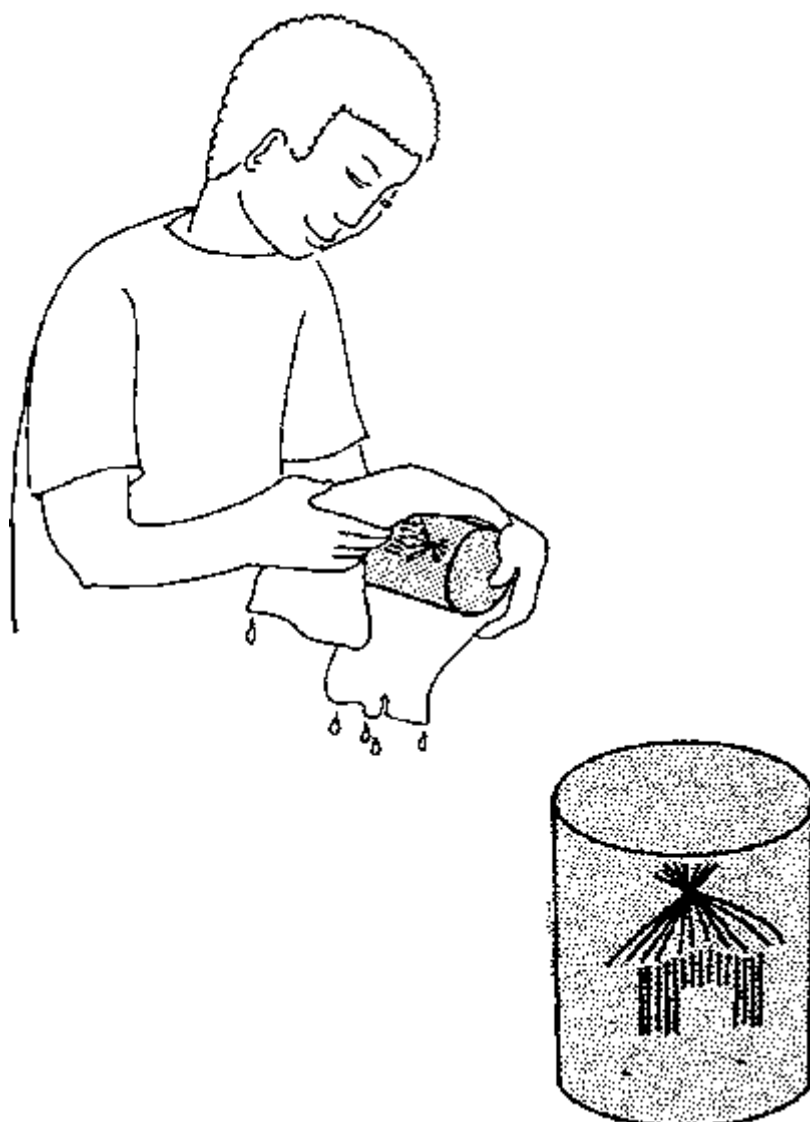

The two tins are wrapped in moistened rags and kept wet for some days.

Observation:

Clearly visible rust traces can be seen along the lines of the pattern, whereas the other tin does not show any signs of rust.

Analysis:

Tins are plated with a protective layer, which prevents corrosion.

3.14. INVESTIGATION OF RUST

Main Goal:

The experiment demonstrates that rust is a different material from iron.

Information:

Rust consists of iron oxide (trivalent iron) and iron hydroxides (trivalent iron).

Materials and Apparatus:

*rust
iron wool
magnet*

Procedure:

- a. The physical properties of iron are examined, such as flexibility, magnetism and colour.
- b. Rust is examined for the same physical properties.

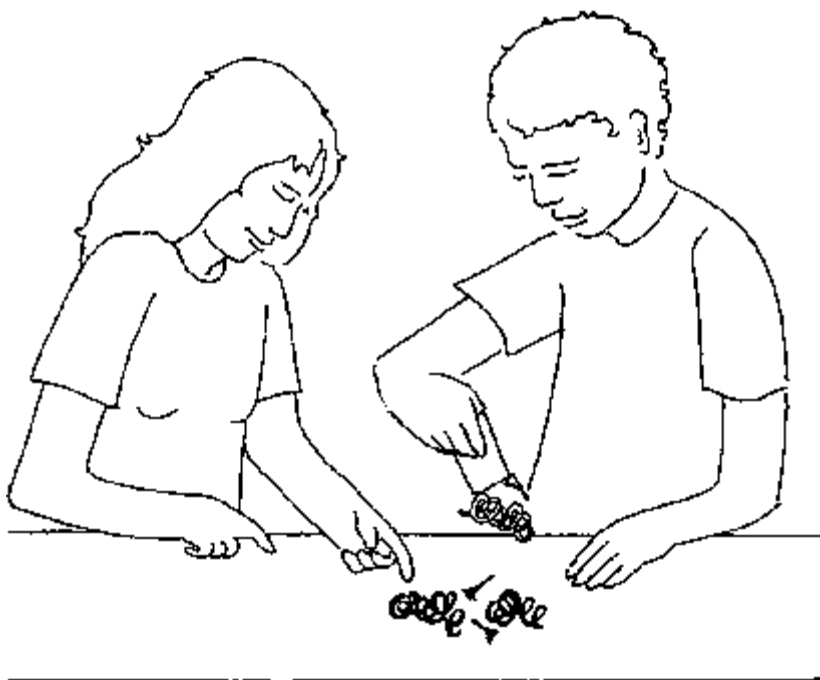

Analysis:

Iron is attracted by a magnet; we say it is ferromagnetic.

As rust and iron display completely different properties, they must be two different materials.

Practical Use:

The porosity of rust encourages the continuing reaction with air and humidity until finally the iron parts rust through.

This can be observed in cars. In technology, different methods are used to prevent corrosion, such as plastic covers, metal covers, and rust inhibiting paint.

3.15. THE ELECTROLYSIS OF SODIUM CHLORIDE

Main Goal:

This experiment illustrates the principle of electrolysis.

Information:

With the help of direct current, chlorine and hydrogen can be separated from a sodium chloride solution. Chlorine develops as gas at the positive pole (anode) and hydrogen gas at the negative pole (cathode).

Sodium ions are collected also at the cathode where sodium appears as metal.

An additional product is sodium hydroxide solution.

(Warning: A detonating mixture of chlorine and hydrogen may be formed. **Chlorine is toxic!)**

Materials and Apparatus:

household salt (sodium chloride) (5-10 g)

2 copper wires about 15 cm long, insulated apart from the last 3 cm at each end of the wires, which shall be knocked flat.

glass vessel

battery, about 4.5 V

(indicator, e.g. litmus, see experiment: VEGETABLE INDICATOR - ANTHOCYANE)

Procedure:

The household salt is dissolved in water.

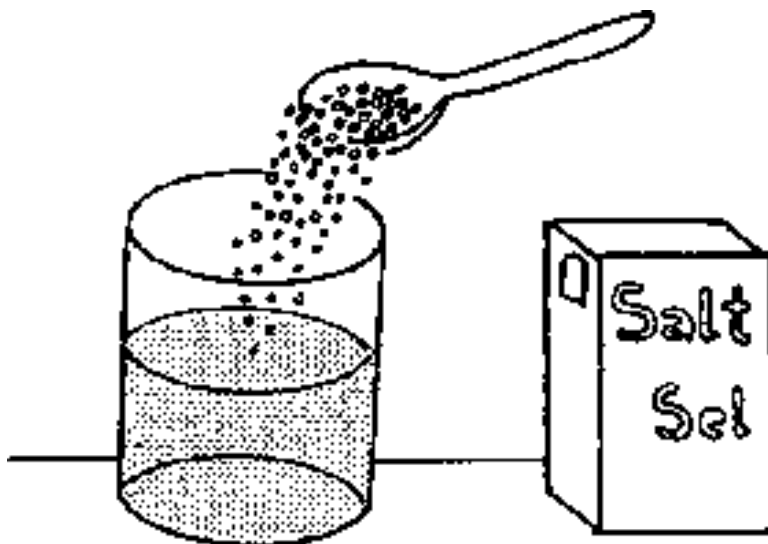

The two electrodes are attached to the battery and then dipped into the solution.

(An indicator can be added to the solution. In addition, the gases which escape can be collected - see experiment: ELECTROLYSIS OF WATER - and then the detonating gas test can be performed.)

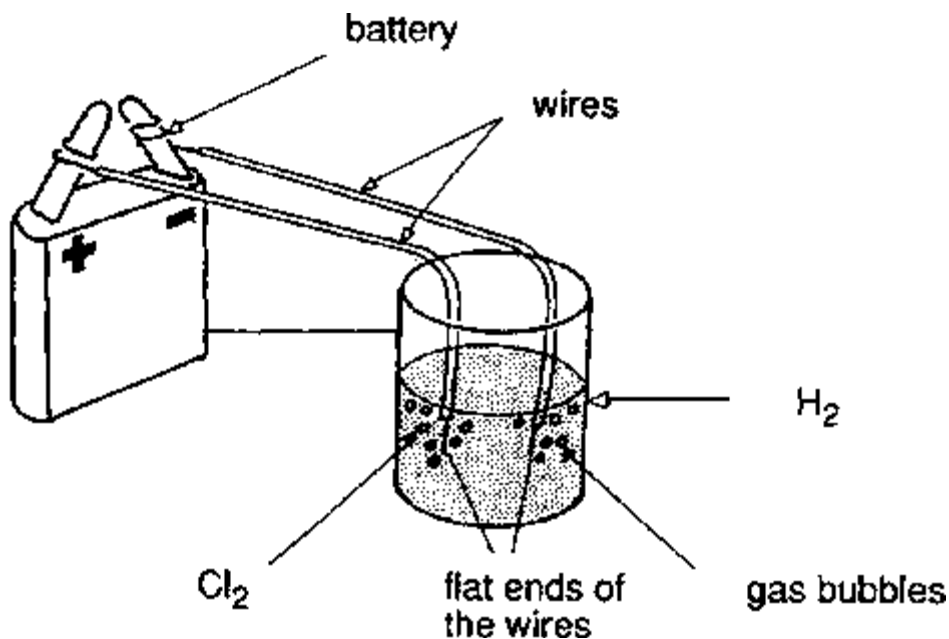

Observation:

Gas bubbles rise at the two poles.

There is a smell of chlorine.

(Near the cathode, the litmus turns blue after a while. Near the anode it is bleached.)

Analysis:

Chlorine gas is released at the positive pole (anode).

At the negative pole (cathode) hydrogen gas is generated and metallic sodium is collected.

(The change of colour indicates an alkali, which is caustic soda solution. Chlorine dissolves well in water and bleaches colours.)

Practical Use:

The electrolysis of sodium chloride is a technique used to produce chlorine.

Chlorine is used as a disinfectant in swimming pools.

In addition, large quantities of chlorine are used to produce chlorine compounds (e.g., hydrogen chloride (HCl), phosgene (COCl_2), chlorinated hydrocarbons (poly vinyl chloride)). Because metal is deposited at the cathode, electrolysis has important industrial applications for manufacturing metal. Aluminium, magnesium, sodium and zinc are often produced in this way.

3.16. THE ELECTROLYSIS OF WATER

Main Goal:

To demonstrate that water is a compound of hydrogen and oxygen.

Information:

With a constant voltage of 4,5 V, delivered by a battery, water can be decomposed into hydrogen and oxygen. The effect is more impressive when two batteries in series are used.

Materials and Apparatus

1 glass vessel (beaker), filled with water,

copper or iron electrodes

insulated wire

2 batteries, serially connected, the two electrodes, covered by test tubes, about 1.5 cm separated

sulphuric acid

wood chip

candle, matches

wooden board (ca. 10 x 20 cm)

Procedure:

The following apparatus is set up.

A few drops of sulphuric acid are added to the water. (This increases conductivity.)

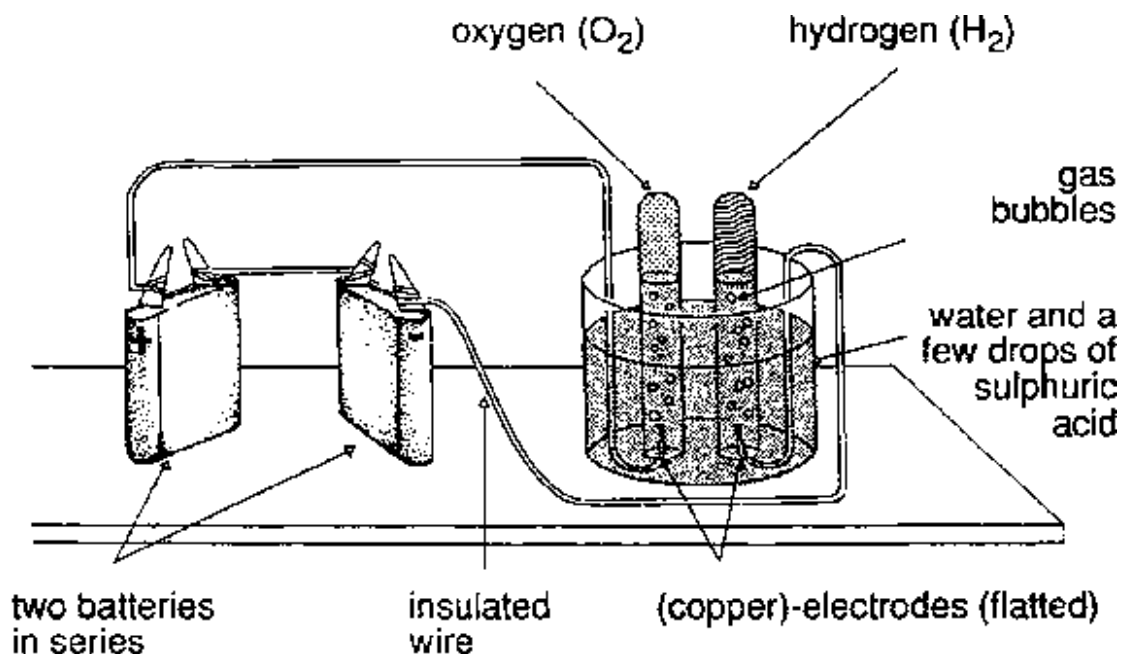

The test tubes are completely filled with the sulphate water, covered with the thumbs and turned upside down over the electrodes.

a. When the apparatus is complete, the electrodes are connected.

b. Shortly before the right test tube (negative pole) is completely filled with gas, a candle is lit. The test tube is covered with the thumb after the complete displacement of the water. It is taken out of the water and kept upside down.

c. Before the left test tube is taken out of the water in the same manner as the right one, a wood chip is lighted. The glowing wood chip is dipped into the test tube.

Observation:

a. Gas bubbles are formed at both poles.

They displace the water from the test tubes.

b. An explosion is heard and perhaps of blue flame may be seen.

c. The glowing wood chip lights up in the test tube.

Analysis:

The two test tubes fill with gas.

**The gas in test tube (A) is called "hydrogen".
Hydrogen burns with a blue flame.**

**The gas in test tube (B) is called "oxygen".
Oxygen supports combustion.**

Water consists of the element hydrogen and oxygen.

to b.) The explosion, which is not dangerous on such a small scale, is the so-called "oxyhydrogen gas reaction".

Hydrogen and oxygen react to form water.

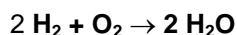

Practical Use:

Pure hydrogen is used for autogenous welding or cutting. In cutting or welding torches, oxygen is directed into a hydrogen stream shortly before its combustion.

With a surplus of oxygen, metals can be cut.

With a surplus of hydrogen, metals can be welded.

3.17. THE EXPLODING TIN

Main Goal:

This experiment demonstrates impressively the danger of a hydrogen-oxygen mixture.

Information:

If a hydrogen-air mixture is ignited, it reacts with a loud explosion, and water is formed. A hydrogen-oxygen mixture with the proportions 2: 1 is dangerous.

Materials and Apparatus:

- 1 coke can, or metal tea caddy*
- 1 nail*
- 1 hammer*
- 1 pair of sheet-iron shears*
- 1 piece of adhesive tape*
- 1 flask of compressed hydrogen matches*

Procedure:

The top of the coke can is cut off, using the sheet-iron shears.

As shown in the following diagram, 2 small holes are cut in the can.

These two holes are covered with adhesive tape or adhesive plaster.

As shown in the diagram, the can is filled with hydrogen, taken from the flask, for one minute. It is placed on the table.

The flask with compressed hydrogen is sealed and placed several metres away from the can.

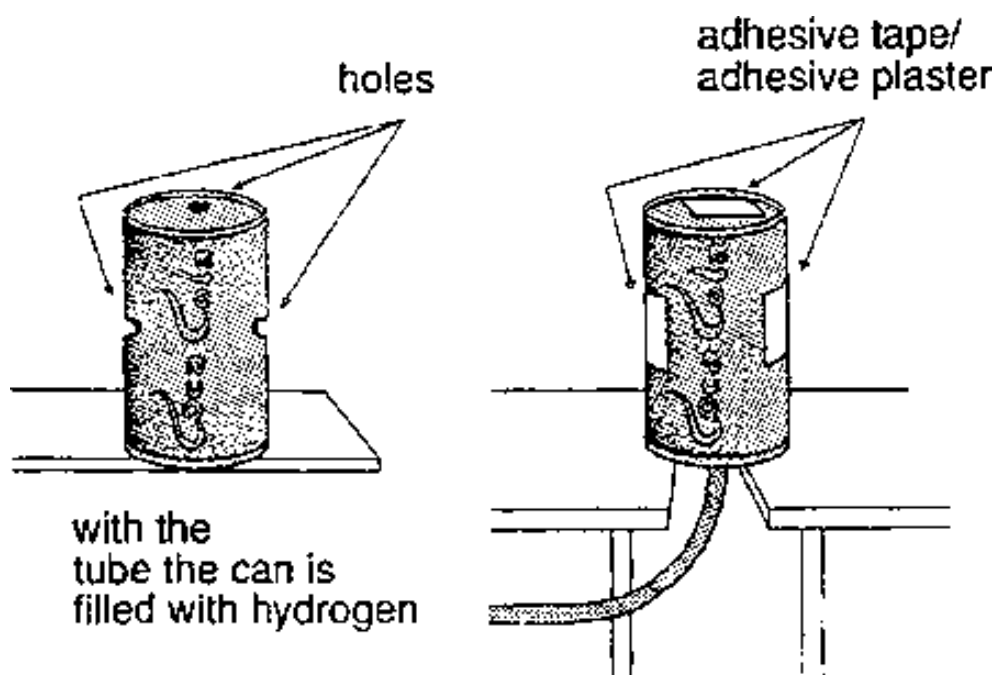

The adhesive tape is removed, a match is lit, and the flame is held close to the upper hole.

Then move back several steps.

(The experiment is very impressive in a darkened room.)

However, one window or door should be left open.)

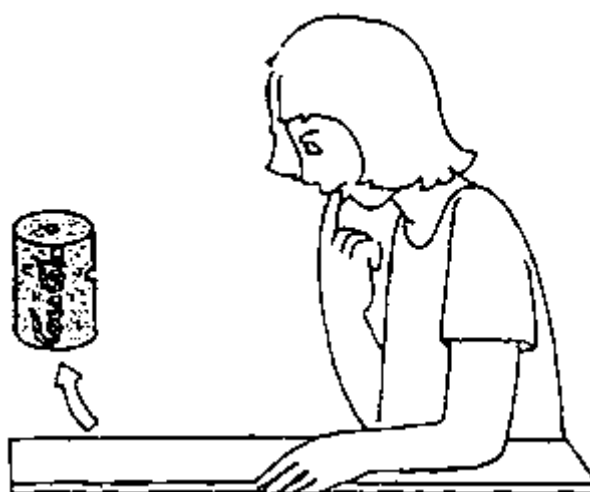

Observation:

When the gas is ignited, a light explosion can be heard. The hydrogen burns with a blue flame.

A faint whistling sound, can be heard. It becomes louder, and is followed by a loud bang.

The tin is lifted from the table. A faint flame can be seen.

Analysis:

Air seaks into the tin, through the holes in the sides. The air-hydrogen mixture explodes.

Only oxygen and hydrogen produce this reaction, which is known as the “oxyhydrogen gas reaction”.

A 2: 1 hydrogen-oxygen mixture is especially dangerous.

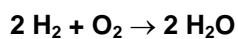

Practical Use:

A high temperature of up to 2000° C is needed to weld iron parts together. This temperature is reached when hydrogen and oxygen reacts.

With a welding torch, this combustion is not dangerous.

3.18. VEGETABLE INDICATOR - ANTHOCYAN

Main Goal:

The pupils learn to distinguish between an acid and an alkali with the help of an indicator.

Information:

The word “indicator” is derived from the Latin “indicare”: meaning to show. Indicators change colour according to the medium with which they are in contact.

Anthocyanins are vegetable colourings, which form salts with acids and alkalis. The salt formation with an acid gives a red colour and the salt formation with an alkali a blue colour.

Anthocyanins can be produced from red cabbage or red corn.

Materials and Apparatus:

red cabbage juice (litmus)

a. lemon juice

acetic acid

a selection of other acids (HCl, H₂SO₄, etc.)

b. a selection of alkalis (NaOH, KOH, etc.)

a few small dishes

Procedure:

The leaves of the red cabbage are cut into small pieces, placed in boiling water. The corn is also pressed and placed in boiling water.



a. 1 ml of each of the various acids and alkalis are poured into separate dishes, one substance per dish.

b. 2-3 drops of indicator are added to each solution.

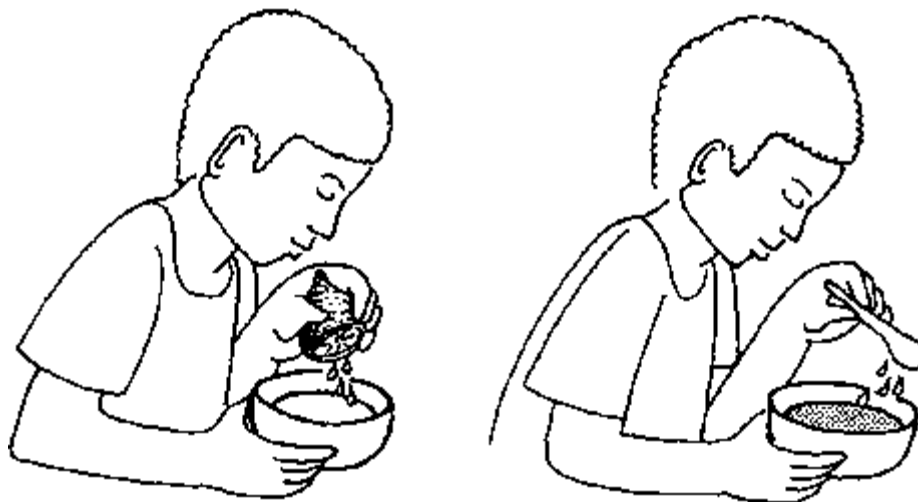

Observation:

The colour of the indicator is red-violet in the acidic range (a.), whereas it is green-yellow in the alkaline range (b.).

Analysis:

With the help of indicators, acids and alkalis can be identified.

3.19. ACID AIR - ACID RAIN

Main Goal:

This experiment introduces sulphurous acid and the problem of “acid rain”.

Information:

If sulphur is burned, sulphur dioxide is produced. This gas forms “sulphurous acid” if it is added to water.

Diesel oil and fuel oil both contain sulphur.

This experiment demonstrates that non-metal oxides and water form acids. (Carbon dioxide is also formed.)

Materials and Apparatus:

Diesel oil or fuel oil

1 wick or cotton thread or rag

1 dish

1 covering plate (metal) with a hole for the wick

1 funnel

1 piece of tubing, with a glass-pipe

1 tall glass vessel (test tube)

water with indicator (fuchsine or litmus solution)

Procedure:

The apparatus is set up as shown in the following diagram.

The water contains 2 - 3 drops of the indicator. The glass and the funnel can be supported with one hand.

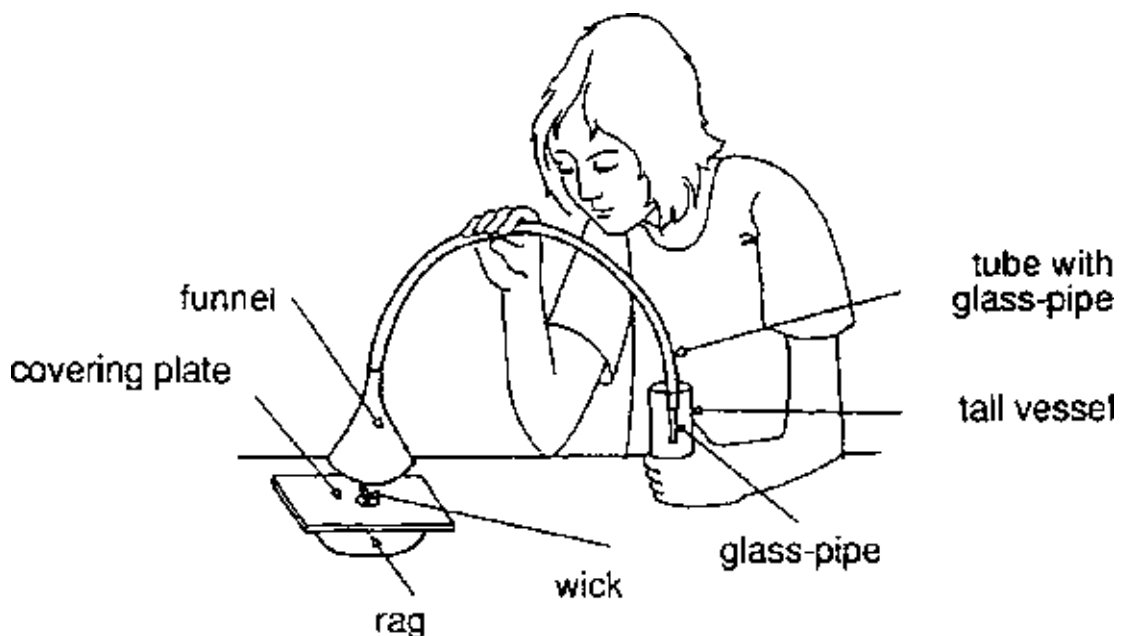

Observation:

Gas bubbles can be observed in the water. The indicator changes colour. The colour change indicates the presence of an acid.

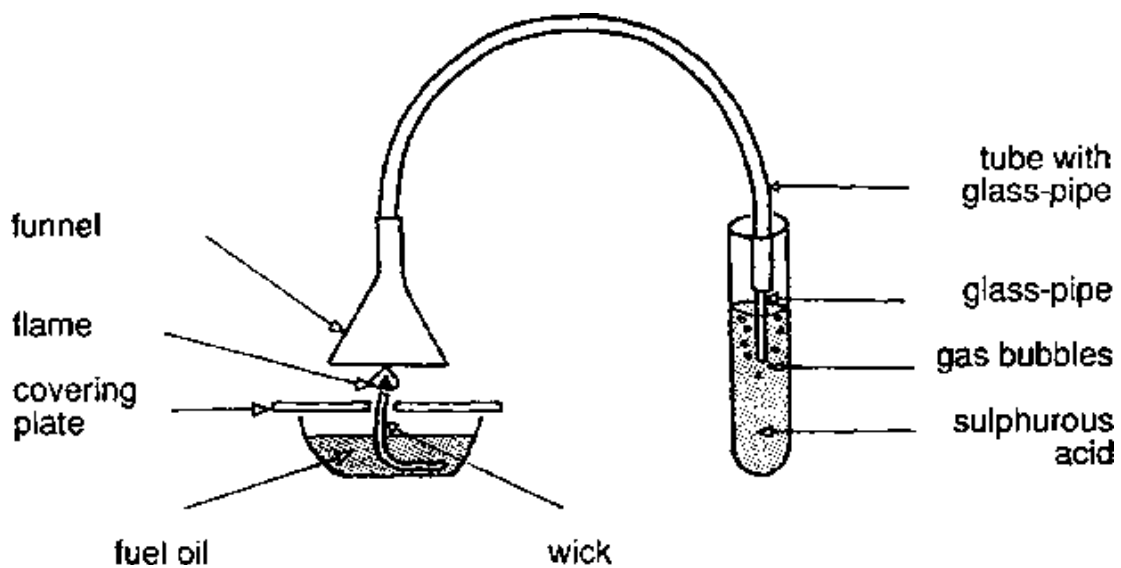

Analysis:

When fuel oil is burnt, the sulphur is oxidized to form sulphur dioxide.

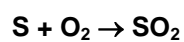

Sulphur dioxide can be easily dissolved in water. Sulphurous acid is formed

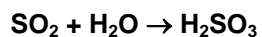

Note: A non-metal oxide and water form an acid.

Practical Meaning:

Sulphur dioxide is one of the components of "acid air".

When combined with water, it forms one essential part of "acid rain".

Sulphur dioxide as well as sulphurous acid damage animate and the inanimate nature. Trees become sick.

It is assumed that what is called "forest die-back" in some industrialized countries might have its origin in acid rain.

(see botany: THE DESTRUCTIVE INFLUENCE OF ACID AIR AND ACID RAIN)

4. ORGANIC CHEMISTRY

4.1. SUGAR CONTAINS CARBON

Main Goal:

Qualitative ultimate analysis.

All matter is made out of atoms, tiny particles that cannot be decomposed anymore by chemical methods. Most matter of our environment, and also our body, is made of compounds the building blocks of which are atoms. There are many different sorts of atoms. Each sort has its typical chemical properties. Matter containing one sort of atoms only is called 'element'. Carbon, hydrogen and oxygen are chemical elements. There are just over 100 known elements.

Information:

Carbohydrates contain the elements carbon, hydrogen, and oxygen. Therefore, its a compound.

Some examples of saccharides are grape sugar (glucose), cane sugar, starch, and cellulose.

Within the scope of ultimate analysis, carbon is identified as one of the elements of sugar.

Materials and Apparatus:

glucose or cane sugar

water

about 10 ml of concentrated sulphuric acid

a glass dish which holds about 50 ml or a small beaker

Procedure:

The beaker is filled to a depth of approximately 1 cm with glucose, which is moistened with a few drops of water.

Sulphuric acid is added carefully until the glucose is just covered. (Wear protective goggles.)

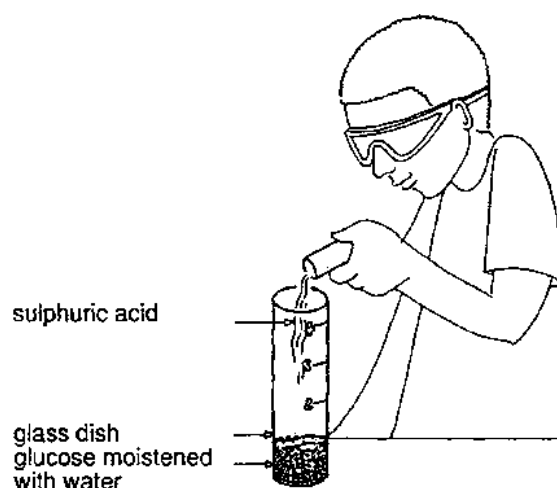

Observation:

A very voluminous black substance is formed.

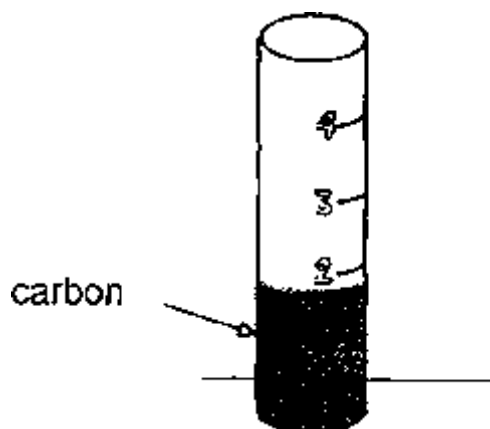

Analysis:

The black substance is carbon.

Concentrated sulphuric acid extracts water from glucose.

Carbon is left as residue.

Practical Meaning:

When you burn wood you can observe that it passes a state where it appears black (charcoal). Again, the black substance is carbon.

4.2. PROTEINS CONTAIN NITROGEN

Main Goal:

Qualitative ultimate analysis.

Information:

Proteins are organic compounds containing, among other elements, nitrogen, in particular the so called amino group - NH_2 . Proteins are essential parts of animals' food, and also indispensable for mens' nutrition. Within the scope of ultimate analysis, nitrogen can be indirectly identified. When proteins are heated, ammonium gas is formed.

Materials and Apparatus:

*hard-boiled egg, chicken protein
moistened litmus paper
test tube or fire-resistant glass dish
test tube holder
burner or candle*

Procedure:

About 1 - 2 cm^3 of hard boiled egg white is placed into a test tube.

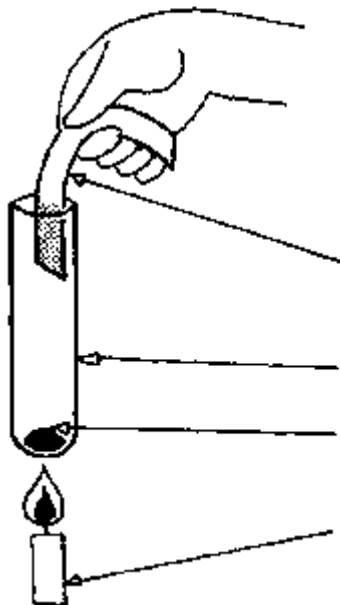
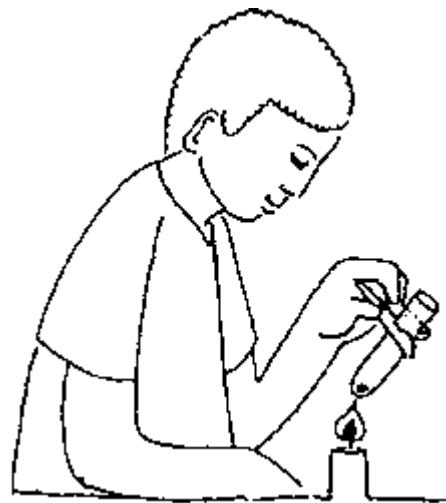
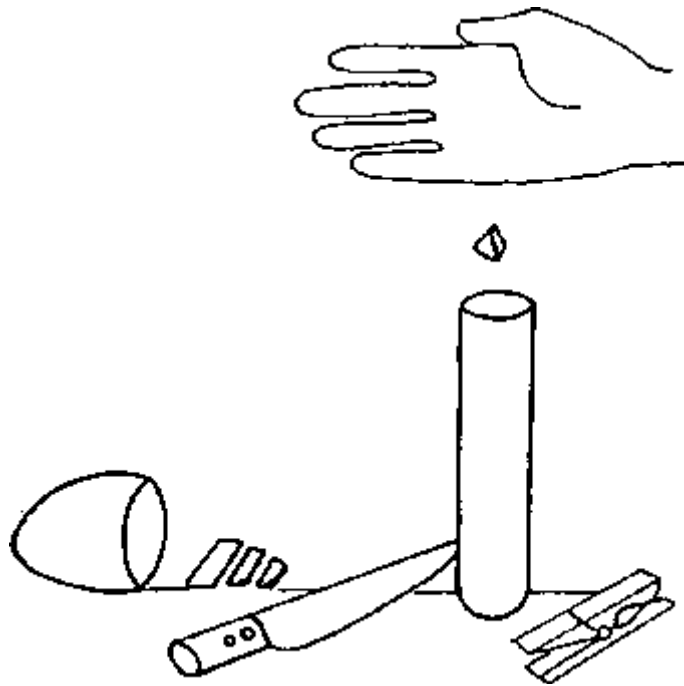

litmus paper

test tube

egg white

candle

The egg white is heated, and after a few minutes the moistened litmus paper is held in the vapour released.

Observation:

The protein turns black when heated.

The litmus paper changes colour indicating an alkali.

Analysis:

When protein is heated, carbon is left as a black residue.

Protein contains nitrogen. When chicken protein is heated, ammonium gas is set free. It forms ammonium hydroxide if water is added.

Ammonium hydroxide changes the colour of indicators.

Addition:

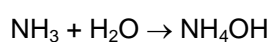

4.3. PROTEIN CONTAINS SULPHUR

Main Goal:

Qualitative ultimate analysis.

Information:

Proteins are made up of amino acids. There are two kinds of amino acids which have sulphur in their functional group - cysteine and methionine.

When protein, e.g. chicken protein, is heated, hydrogen sulphide is formed. Sulphur can then be indirectly identified within the scope of ultimate analysis.

Materials and Apparatus:

*hard-boiled egg, chicken protein
moistened lead acetate film
test tube or glass dish
test tube holder
burner*

Procedure:

About 1 - 2 cm³ of hard-boiled egg white is placed into a test tube. The egg white is heated, and after a few minutes the moistened lead acetate paper is held in the vapour released

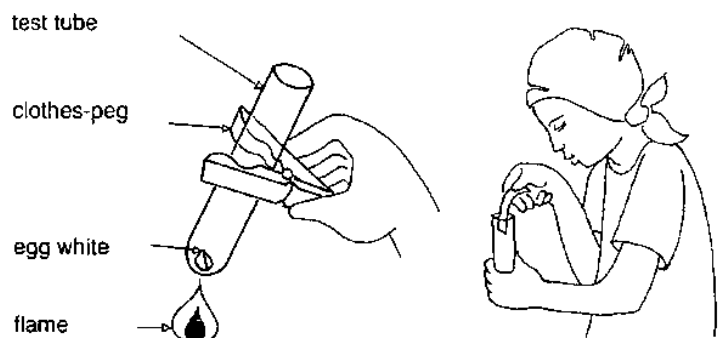

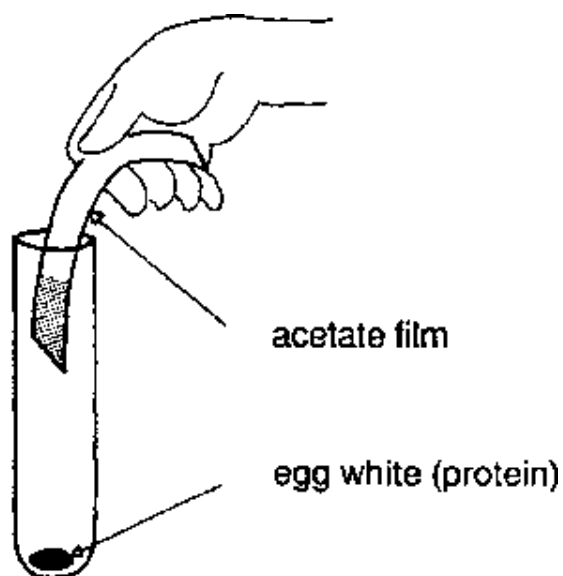

Observation:

The protein turns black when heated.
The white lead acetate turns black.

Analysis:

When protein is heated, carbon is left as black residue.

Chicken protein contains sulphur. When heated, hydrogen sulfide gas is set free. Hydrogen sulfide in combination with lead acetate forms black lead sulfide.

4.4. IDENTIFICATION OF STARCH IN FOOD

Main Goal:

Starch is identified with iodine potassium iodide solution.

Information:

Starch is a polysaccharide and belongs to the class of carbohydrates.

Starch is a vegetable reserve substance, found in grain, potatoes, etc.

Materials and Apparatus:

a. about 0.5 g iodine

1 g of potassium iodide

100 ml distilled water

200 ml brown glass dish which can be tightly closed

b. 1 slice of potato

1 cube of bread

Procedure:

- a. The potassium iodide is dissolved in distilled water, and then the iodine is added.
- b. Some drops of the iodine potassium iodide solution are dropped on a cube of bread and a slice of potato.

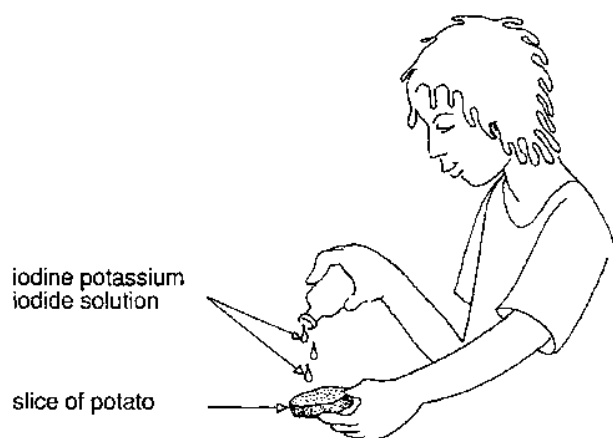

Observation:

The bread and the slice of potato turn a dark blue colour.

Analysis:

The blue colour indicates starch.

Addition:

Starch molecules are coiled in the form of a helix (like a spiral staircase). Iodine molecules accommodate themselves in this starch spiral.

The blue colour is caused by the trapped iodine molecules.

4.5. CARBON DIOXIDE IS PRODUCED DURING THE PROCESS OF FERMENTATION

Main Goal:

The experiment demonstrates alcoholic fermentation.

Information:

The oldest chemical synthesis technique of mankind is fermentation. It is the change which takes place when a saccharine solution is exposed to yeast. The products are alcohol (ethanol), carbon dioxide and heat.

Materials and Apparatus:

freshly pressed apple juice or other fresh fruit juice

yeast (from a bakery)

250 ml glass vessel which can be closed with a rubber stopper

a pierced rubber stopper with a fermentation tube

limewater (CaO is dissolved in water and filtered)

Procedure:

About 100 ml freshly pressed apple juice is poured into a glass vessel. Then 10 - 20 g yeast is added and the vessel is closed with a rubber stopper. The fermentation tube is filled with limewater (see diagram).

If the fermentation does not start immediately the glass vessel should be warmed in a water bath.

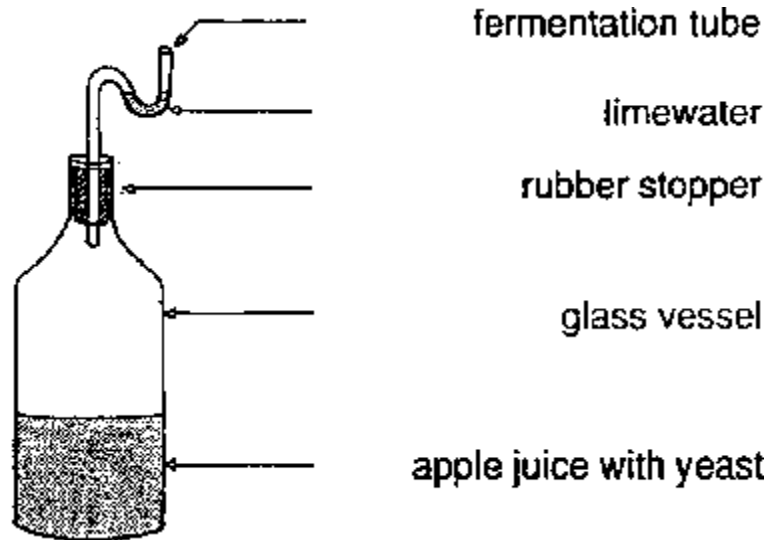

Observation:

After some time gas bubbles form.
The limewater becomes cloudy.
A white precipitate settles.
The glass vessel becomes warmer.



Analysis:

The gas formed is carbon dioxide.

Carbon dioxide and calcium hydroxide form white calcium carbonate.

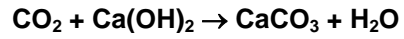

Addition:

Fermentation vessels are closed with fermentation tubes which usually contain water. One reason for this is to create an anaerobic medium.

In an anaerobic medium more alcohol is produced than in an aerobic one.

Practical Use:

In industry, ethanol is produced in large quantities by alcoholic fermentation.

5. PHASE TRANSITION

5.1. MELTING AND SOLIDIFICATION

Main Goal:

This experiment demonstrates the processes of melting and solidification taking water as an example. Water appears as liquid, vapor and solid (ice). These three modes of appearance are called phases. The transition from one phase to another one is called 'phase transition'. At the melting point solid water changes phase to liquid water. At the freezing point liquid water becomes solid water.

Information:

The melting point and the freezing point, i.e. temperature at which these changes take place, are identical.

These two phase transitions are hardly dependant on air pressure.

Materials and Apparatus:

a. water

dish
refrigerator

b. ice

glass dish
thermometer

Procedure:

a. A little water is poured into a dish and this is then placed in the refrigerator.

b. Some ice is placed in a glass dish, and the temperature is measured as the ice melts (see drawing).

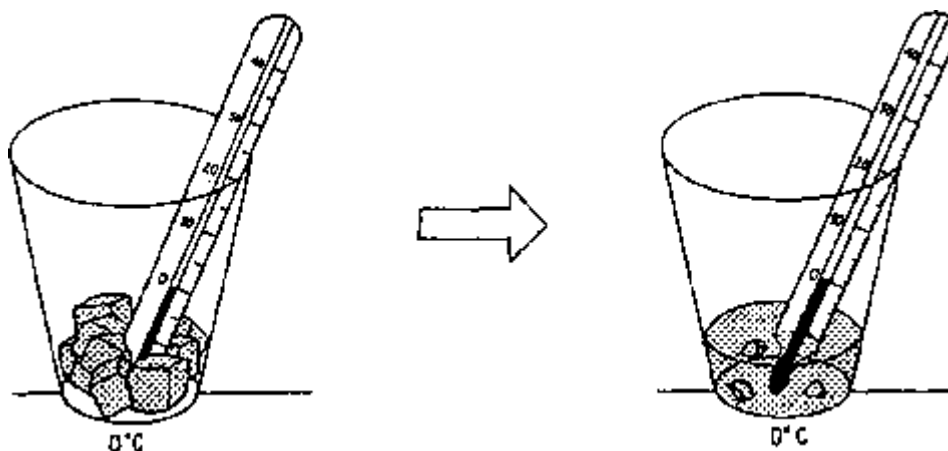

Observation:

- a. After some time the water freezes.
- b. As long as the ice melts, the temperature remains at 0°C.

Analysis:

The transition from the liquid phase into the solid phase at a particular temperature (point of solidification) is called “solidification”.

The transition from a solid phase into a liquid phase at a given temperature (melting point) is called “melting”.

Thus it is possible to liquefy a solid substance and solidify a liquid.

The melting point (and the freezing point) for water is 0°C.

Practical Use:

The melting point is one means of identifying a material.

Addition:

The melting point of alcohol is - 114° C, its boiling point is 78° C.

For mercury the corresponding data are - 39° C and 357° C.

Further thought:

As long as the ice melts, the temperature remains constant (0° C) in spite of the fact that heat is continually being supplied.

Why does the temperature not rise?

5.2. EVAPORATION AND CONDENSATION

Main Goal:

This experiment illustrates evaporation (boiling) and condensation taking water as an example.

Information:

The boiling point and the condensation point of a pure substance are identical.

These two phase transitions are highly dependent on air pressure.

Condensation comes from the Latin “condensare” meaning to thicken.

Materials and Apparatus:

*water
glass or a pot
glass vessel
tripod
burner
thermometer*

Procedure:

a. The apparatus is set up as shown in the diagram below.

The water is heated.

The temperature at the boiling point is measured using the thermometer. (The temperature should not be taken at the bottom of the dish).

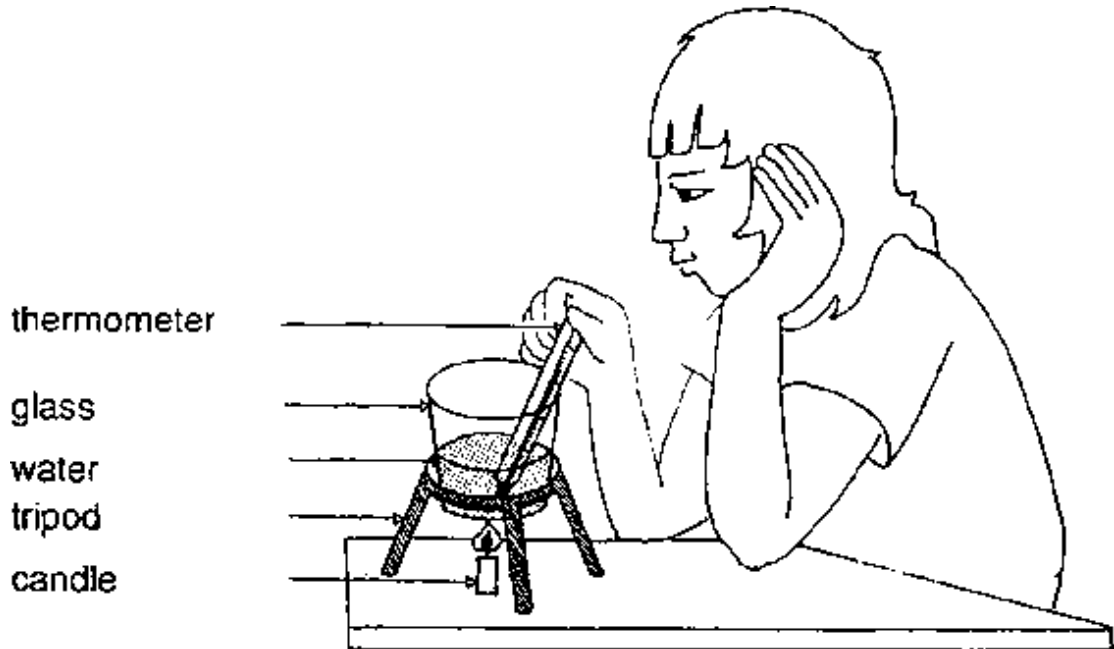

b. Then the second glass vessel is then held in the gaseous water (steam).

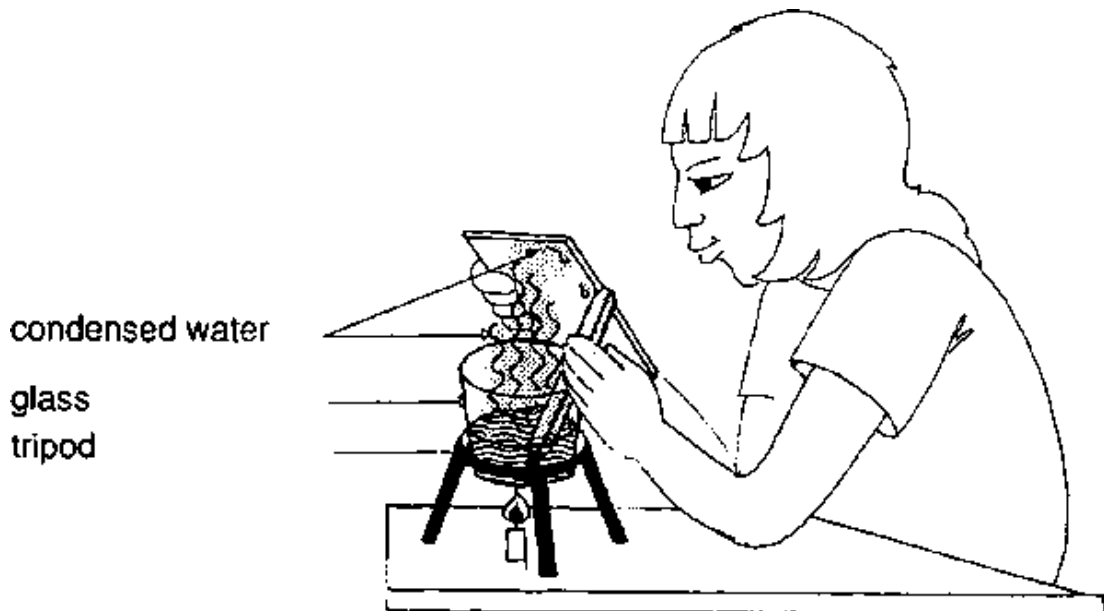

Observation:

- a. The water boils at about 100° C (at normal air pressure).
- b. Moisture condenses on the second glass vessel.

Analysis:

a. The transition of a liquid to a gas at a certain temperature (the boiling point) is called “evaporation” or “volatilization”.

b. The transition of a gas to a liquid at a certain temperature (condensation point) is called “condensation”.

Practical Use:

Boiling points are a means of identifying substances.

Air is generally loaded with water vapor. If air rises and reaches colder regions, the vapor condenses. Tiny liquid water drops are formed, clouds develop.

Further thought:

A solid must be heated to melt. A liquid must absorb heat to vaporize. Conversely, what must a gas release to liquefy and a liquid to solidify?

5.3. SUBLIMATION AND RESUBLIMATION

Main Goal:

This experiment demonstrates the processes of sublimation and resublimation taking iodine as an example.

Information:

Sublimation is the direct transition of a solid body into a gaseous substance. The reverse process is called resublimation.

Materials and Apparatus:

iodine - some crystals

sand - 2 or 3 teaspoons

porcelain or clay dish

funnel or a cut-off bottle neck

glass vessel - must be cooled in a freezer prior to the experiment

burner or candle

tripod

Procedure:

The iodine crystals are mixed with the sand in the porcelain dish.

The apparatus is set up as shown in the diagram below and heated slowly.

glass vessel

funnel

porcelain dish

iodine crystals
mixed with sand

tripod

flame

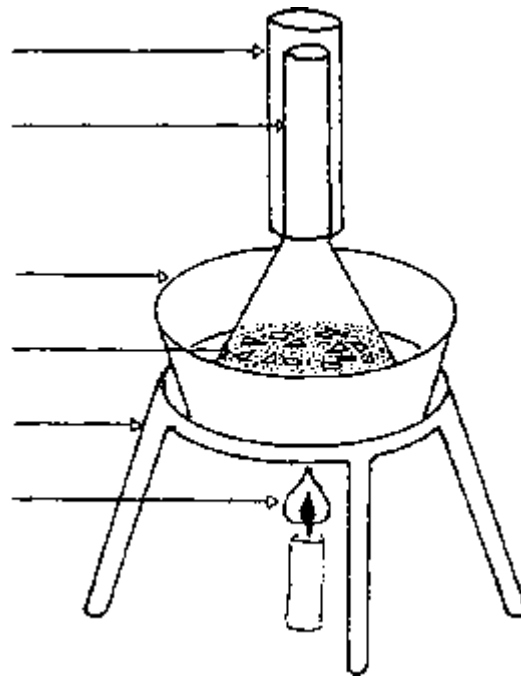

Observation:

Violet vapour appears. The solid iodine becomes a gas without melting. Crystals settle in the glass dish.

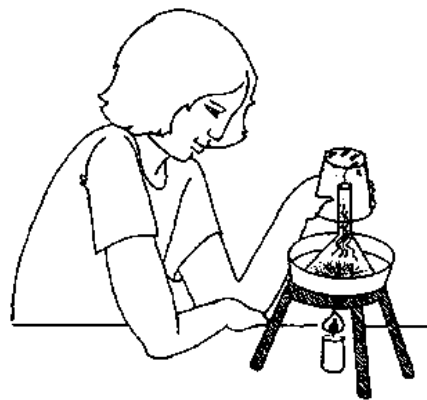

crystals

violet vapour

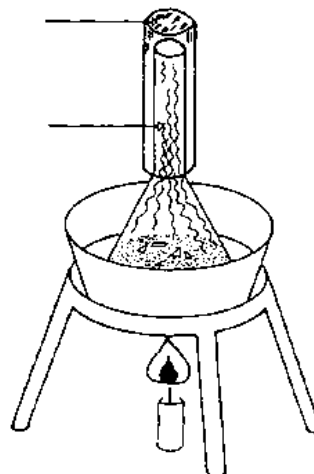

Analysis:

This direct transition of a solid substance to a gas is called “sublimation”.

The direct transition of a gas to a solid condition is called “resublimation”.

Further thought:

So-called “dry ice” (a solid) consists of carbon dioxide. At the open air it undergoes sublimation, and i.e. it changes phase directly from solid to gas. Why then is dry ice used in picnic cooler?

5.4. LAUNDRY DRIES WHEN THE WATER EVAPORATES**Main Goal:**

Through the experiment pupils learn why and how liquids evaporate, taking water as an example.

Information:

Even below the boiling point water can become a gas. This process is called evaporation. The pace of water evaporation is dependent on the factors temperature and vapor saturation of the air (among others). Generally air contains water vapor. The concentration of water vapor i.e. the number of grams of water per cubic meter of air, depends on the temperature of the air. If air of a certain temperature contains the maximum possible amount of water vapor we call this air ‘saturated’. The higher the temperature of the air the more water vapor can it contain.

The following experiments illustrate these two interdependent factors.

Materials and Apparatus:

a. 2 dishes of about the same size

1 glass vessel

b. 2 rags of about the same size

(about 15 cm x 15 cm)

water

Procedure:

a. The two dishes are half filled with water. A glass vessel is placed over one of the dishes. The experiment is observed for several days.

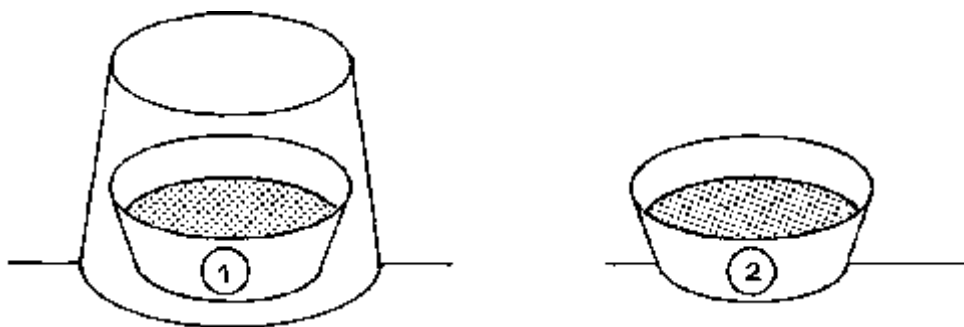

b. The rags are soaked in water. One is dried in the sun and the other one in the shade. The times taken by the rags to dry are compared.

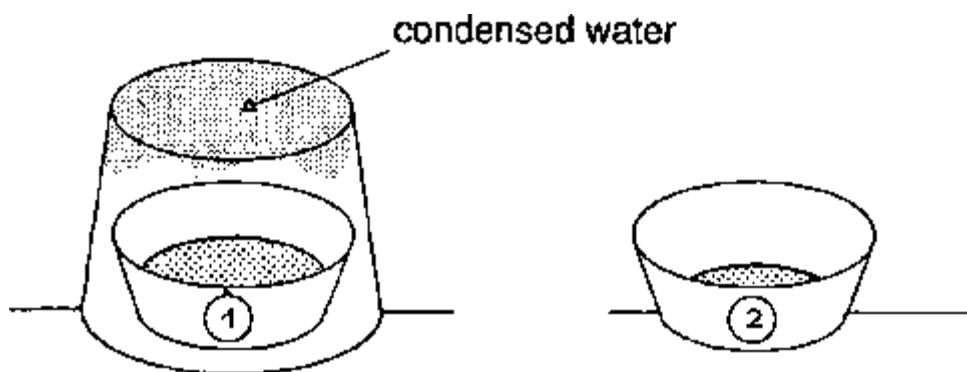

Observation:

a. After a few days (the time depends on the amount of water and the size of the surface) the water in the open dish has completely evaporated. The water in the other dish has only partly evaporated.

b. The rag in the sun dries more quickly than that in the shade.

Analysis:

The ambient air takes in the gaseous water particles to a certain degree until the air becomes 'saturated'. This is why the water from the dish with the cover (experiment a.) evaporates only partially. Water evaporates more rapidly in warm air than in cold air.

An additional air movement, e.g. caused by wind, moves away the air surrounding the wet rags which is saturated with water vapour.

The "dry" air is moved along and the whole process starts again. Thus, the pace of evaporation is increased.

Practical Use:

A technical way of using water evaporation is the process of refining salt (basically sodium chloride) from sea water in warm countries. The sea water is lead into huge basins. The water evaporates, according to the water circulation, with the help of the sun and the wind.

The salts crystallize out and can then be refined (see experiment: CRYSTAL FORMATION).

Further thought:

The cloth covering canteens are moistened when we want to keep the liquid inside cool. Why?

5.5. WATER EVAPORATION - DEPENDANT ON THE SURFACE SIZE

Main Goal:

The experiment demonstrates to what extent the evaporation of water is dependant on the surface size.

Information:

Water also becomes a gas below the boiling point. This process is called evaporation.

(see experiment: LAUDRY DRIES WHEN THE WATER EVAPORATES.)

Materials and Apparatus:

1 glass vessel with a smaller diameter
a tin pan
1 measuring cylinder (scales, measuring vessel)

Procedure:

The same amount of water is placed in each of the three vessels. They are then placed in a sunny spot and observed for several days.

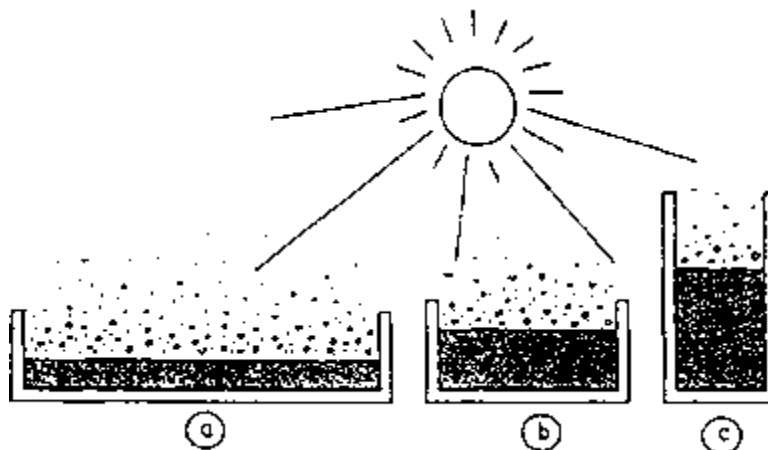

Observation:

The water in the tin pan (a) evaporates faster than that in glass vessel (b). Slowest evaporation takes place in glass vessel (c).



Analysis:

The speed of water evaporation is dependant on the size of the surface. The bigger it is, the more rapid the evaporation.

Practical Use:

see experiment: LAUNDRY DRIES.

Laundry dries faster when the surface of the washing is made as big as possible.

Further thought:

What is the effect when rubbing alcohol is poured on your back?

5.6. WATER EXPANDS WHEN IT SOLIDIFIES

Main Goal:

This experiment illustrates the volume expansion of water when it solidifies.

Information:

Water has its greatest density at 4° C. Above and below this temperature, the density decreases.

The volume expansion of solidified water can be demonstrated impressively by the volume increase undergone by water when it freezes.

This phenomenon, which is a contradiction of accepted, normal laws is called the “density anomaly”. The word anomaly comes from the Greek and Latin word “anomalus” meaning: against the law.

Materials and Apparatus:

- a bottle or jar with a screw cap*
- water which has been boiled and then cooled*
- freezer*
- plastic bag, paper*
- an empty tin*

Procedure:

The jar is filled up to the rim with boiled water and the screw cap is tightly closed. Then it is placed in a plastic bag.

The tin is also filled up to 3/4 of its height. The water level is marked.

Both, the bag with the jar and the tin are placed in the freezer for one or two days.

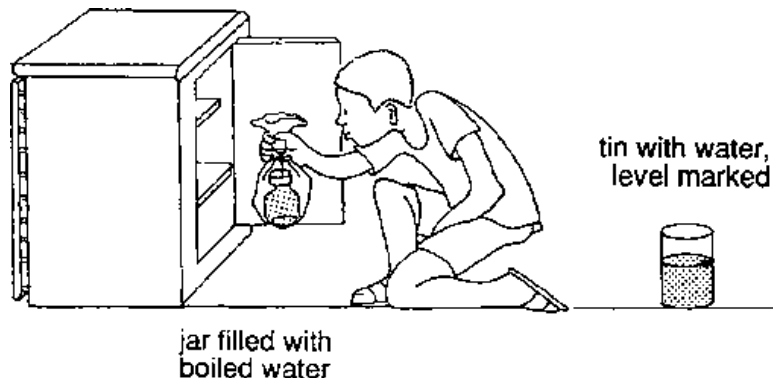

Observation:

The water is frozen, the jar has shattered, the ice in the tin has reached a higher level than the liquid water before.

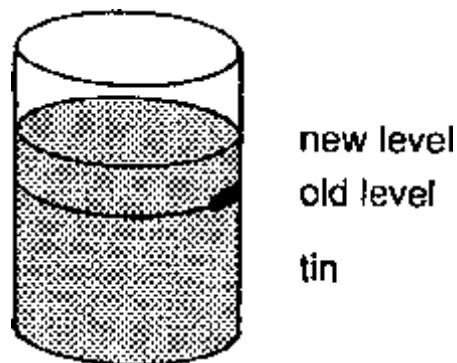

Analysis:

Water expands when it solidifies.

Practical Meaning:

Underground water which freezes causes erosion (from the Latin word “erodere”, meaning to gnaw off) in the mountains and streets.

Further thought:

When water solidifies, it not only enlarges its volume but also releases heat into the freezer.

What does the freezer do with this heat?

5.7. ICE FLOATS ON TOP OF WATER

Main Goal:

This experiment demonstrates that ice is less dense than water.

Information:

At room temperature, the density of water is approximately 1 g/cm^3 and that of ice about 0.9 g/cm^3 .

Materials and Apparatus:

ice cubes (if a refrigerator is not available in your school, go to the next bar and ask for some ice cubes)

water

drinking glass

Procedure:

Some ice cubes are placed in a pan with water.



Observation:

The ice floats on the water.

Analysis:

We observe that water expands when it solidifies. This means that 1 cm^3 ice weighs less than 1 cm^3 liquid water. The bigger volume of ice has the same mass as the water that becomes ice. Therefore, the density, i.e. the mass (in g) per volume (in cm^3) of ice is smaller than that one of liquid water.

Further thought:

What happens to the water level in the pan (see drawing) when the ice melts?

5.8. ICE MELTS WHEN THE PRESSURE INCREASES

Main Goal:

This experiment demonstrates that ice melts where locally the pressure is increased.

Information:

The freezing point, or rather melting point, slides toward lower temperatures as pressure is increased. This is true of water and of the elements mercury and bismuth. Thus, under high pressure ice melts already at -5°C or even lower temperatures.

With all other substances the melting or the freezing point is increased by an increase in pressure.

Materials and Apparatus

1 ice block

1 boulder or big brick (about 5 kg)

wire about 30 cm long

10 normal bricks

Procedure:

The experiment is set up as shown in the diagram below.

The experiment takes about half an hour or longer, depending on the thickness of the ice block, and the weight of the weight.

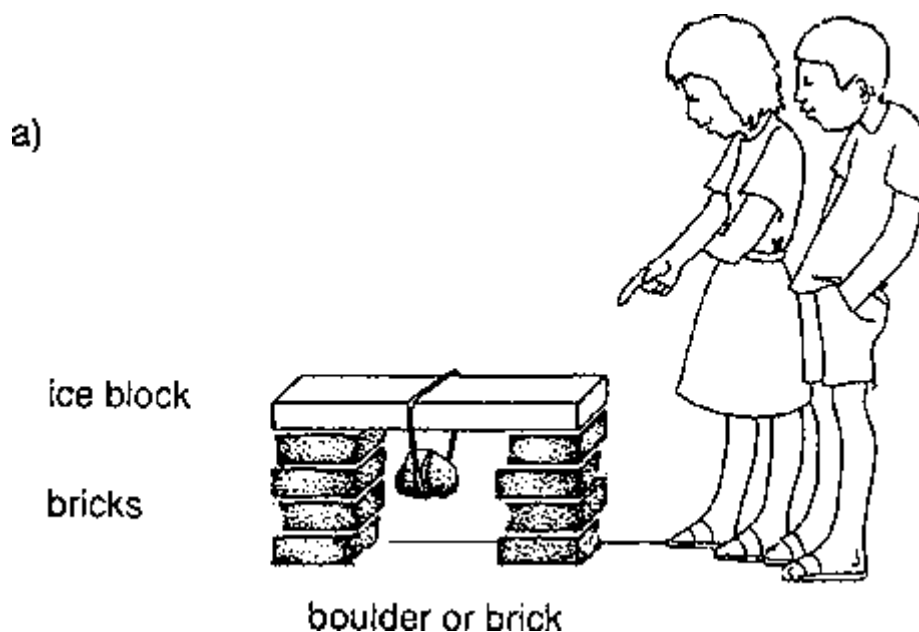

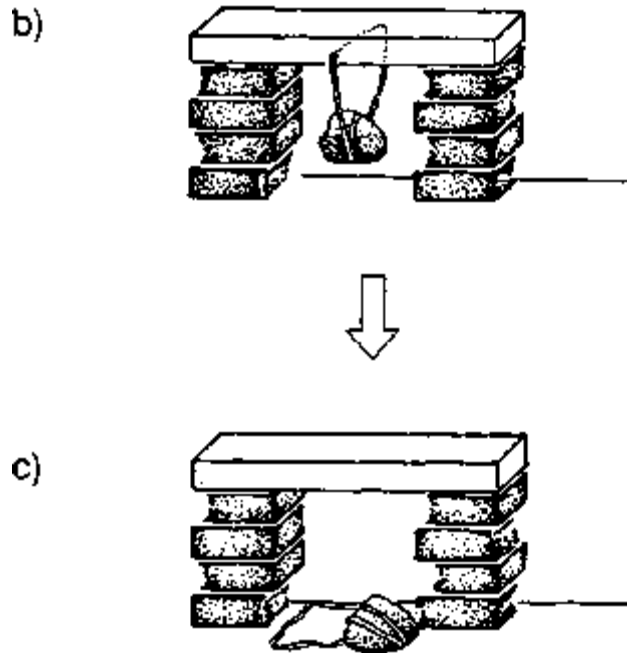

Observation:

The wire moves through the ice block without cutting it into pieces.

Analysis:

The boulder produces pressure along the line of the wire at the upper surface and at the sides of the ice block. The ice melts because of the pressure transmitted to the ice by the wire. Above the wire the ice freezes again. Under increased pressure, water has a lower freezing or melting point.

Practical Meaning:

Ice skating is possible due to the increased pressure which is exerted on the ice through the blade of the ice skate. A water film is created which allows skater to glide.

The movement of glaciers can also be explained by the high pressure which the upper layers of snow or ice exert on the lower ones.

Further thought:

Look at the ice block in drawing c).

It is not quite correct. The wire when pulled through the ice will leave a trace! Why?

6. WARMTH AND COLD

6.1. METALS EXPAND WHEN HEATED

Main Goal:

This experiment demonstrates the expansion of metals when heated.

Information:

Some important properties of metals are malleability, thermal conductivity, expansion when heated and electrical conductivity.

The expansion of metal under the influence of heat is very important. The effect is in particular conspicuous for long, thin rods and pipes, which are at high temperatures significantly longer than at low temperatures.

Solid materials do not expand as much as liquids or gases.

Materials and Apparatus:

1 metal sheet (aluminium or copper)

1 coin

*alcohol or gas burner,
a candle a pair of tongs
a pair of pliers*

Procedure:

An opening is cut into the metal sheet to allow the coin just to pass when cold. The coin is heated as shown in the diagram below. (The time required depends on the material of which the coin is made.) After heating, attempt to put the heated coin through the opening in the metal sheet.

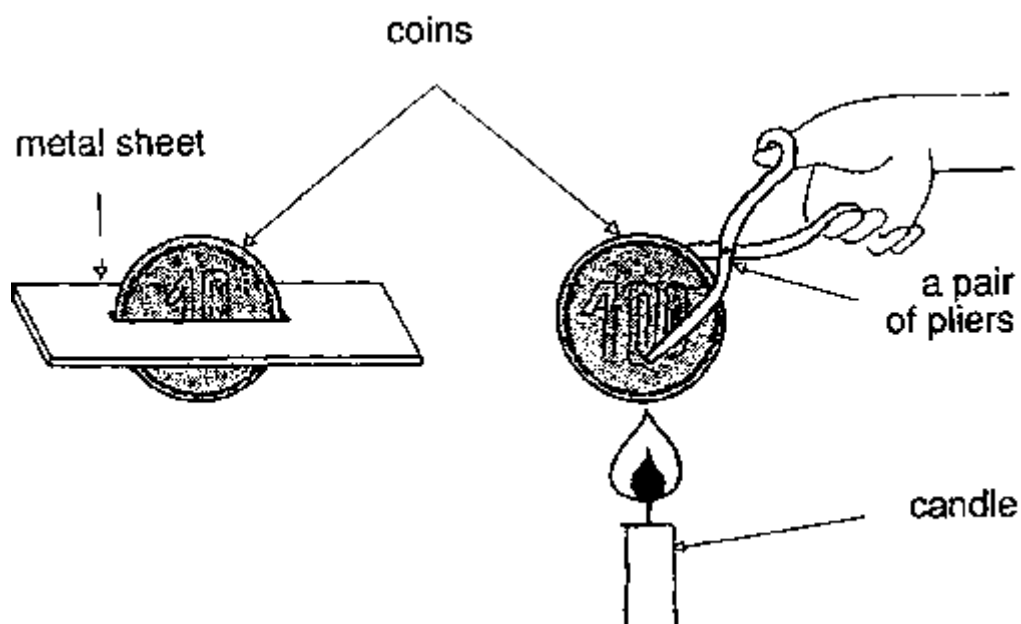

Observation:

The heated coin no longer fits through the opening as before. It jams.

After the coin has cooled down, it fits through the opening again.



Analysis:

The coin expanded when heated.

Metals expand when heated and contract when cooled down.

Practical Use:

The expansion of metals on heating can be observed in the wires of telegraph lines and transmission lines.

During the summer metal wires sag, whereas in winter they tauten again. When metal wires are laid in summer, they should never be tautened.

In winter small gaps between railway tracks can be observed. These close in summer. The length expansion must be taken into consideration to avoid a deformation of the whole track system. Track sections are often welded together today without leaving seams. Iron tyres are fitted on a wooden wheel after having been heated. When they cool down they contract and tighten on the wood.

Metal bridges are set into concrete only at one side of the bridge, so that they do not bend when they expand. Bimetals take advantage of various kinds of length expansions of different sorts of metals.

(see experiment: THE PRINCIPLE OF A BIMETAL)

Futher thought:

Mercury, under normal conditions, is a liquid. It expands also when heated. The same happens to glass, even if it is not a metal. Many thermometres are made of glass and mercury. Which material expands more with increasing temperature?

6.2. THE THERMAL CONDUCTIVITY OF DIFFERENT KINDS OF MATERIALS

Main Goal:

This experiment shows the good and poor conductivity of various kinds of materials.

Information:

All kinds of substances conduct heat. The degree of heat conductivity is dependent on the

material. If the transport of heat takes place in testing substances, it is said to be heat conduction (in contrast to heat streaming due to differences in density).

Materials and Apparatus:

about 20 cm of copper wire, iron wire and glass rod, each one of the same length and with the same diameter

a wooden rack

wood auger

wax

3 candles

Procedure:

The experiment is set up as shown in the following diagram.

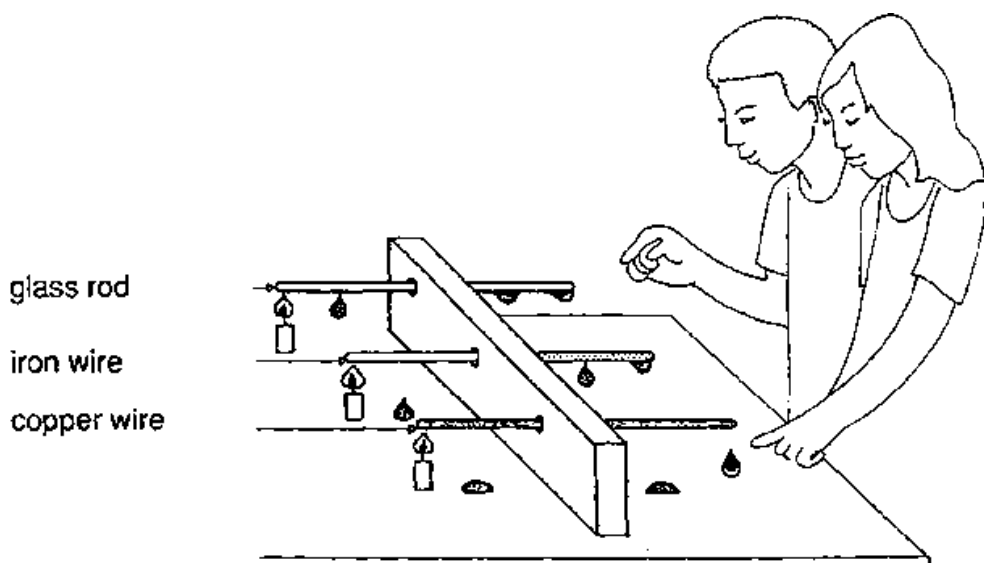
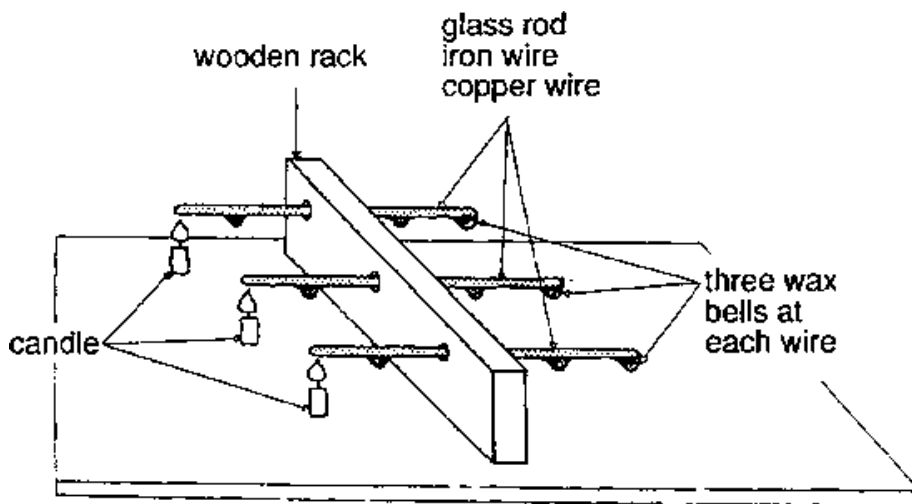

Observation:

First the little wax ball at the end of the copper wire melts and then the one on the iron wire. The one at the end of the glass rod does not drop off.

Analysis:

Heat needs time to go through. The faster the better the conductivity. Glass is a poor heat conductor. Copper is a better one than iron. The heat conductivity is dependant on the material. There are good, mediocre and bad heat conductors.

Practical Use:

Good heat conductivity is taken advantage of in the household, e.g. with pots.

Wood conducts heat much worse than brick.

A house made of wood only warms up slowly, which means, it stays cool in summer. In winter it cools down more slowly than houses made of brick.

(The thickness of the wall and its construction also have to be taken into consideration.)

It is recognized that houses made of brick are built in such a way that the bricks include a lot of air, since air is a poor thermal conductor.

On Cabor Verde, holes are punched into mud blocks and gypsum blocks with the help of bottles and tins. This procedure saves material and is insulating.

Futher thought:

Why is it difficult to estimate the temperature of things by touching them?

6.3. THE THERMAL CONDUCTIVITY OF WATER

Main Goal:

This experiment demonstrates the thermal conductivity of water.

Information:

see experiment: THE THERMAL CONDUCTIVITY OF DIFFERENT KINDS OF MATERIALS.

Materials and Apparatus:

glass tube

cold water

burner or candle

Procedure:

The water is heated in the upper part of the glass tube.



Observation:

The water boils in the upper part of the glass tube.
The bottom of it hardly warms up.

Analysis:

Heated water expands, the density decreases and it becomes lighter (see experiment 6.4). Therefore, it does not sink down.

The water at the bottom of the test tube remains rather cold.

Therefore: Water must be a bad heat conductor.

Further thought:

How can you make this experiment even more dramatic? Think about the usage of ice!

6.4. THE HEAT “STREAMING”

Main Goal:

The experiment demonstrates that the density of water decreases when it is heated.

(The density anomaly of water - highest density at 4° C - is not taken into account.)

Information:

When water is heated, it expands and its density decreases. It becomes lighter (i.e. 1 cm³ of hot water is lighter than 1 cm³ of cold water). If heated at the bottom of a beaker the hot water moves upwards. At the surface it cools down. Its density increases and the water sinks. These processes cause a “heat streaming” in water.

“Heat streaming”, (unaided convection, Latin: *convehere* to bring along), occurs when the density differences are caused by different temperatures.

Materials and Apparatus:

*water, ink
sawdust, straw, glass pipe, bamboo pipe
tripod or a similar frame
candle
glass beaker*

Procedure:

Ink or another colour is placed at the bottom of the beaker by means of a straw or a glass pipe.

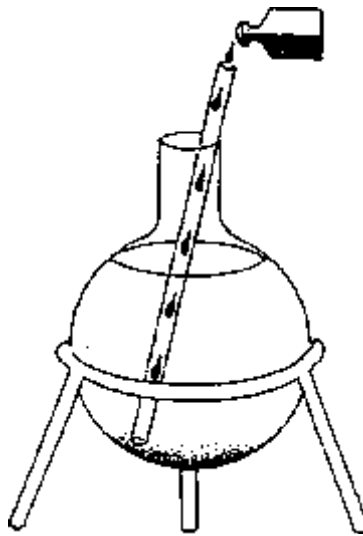

The water is warmed up with the candle at one side of the bottom of the beaker.

**glass beaker
water
tripod
colour**

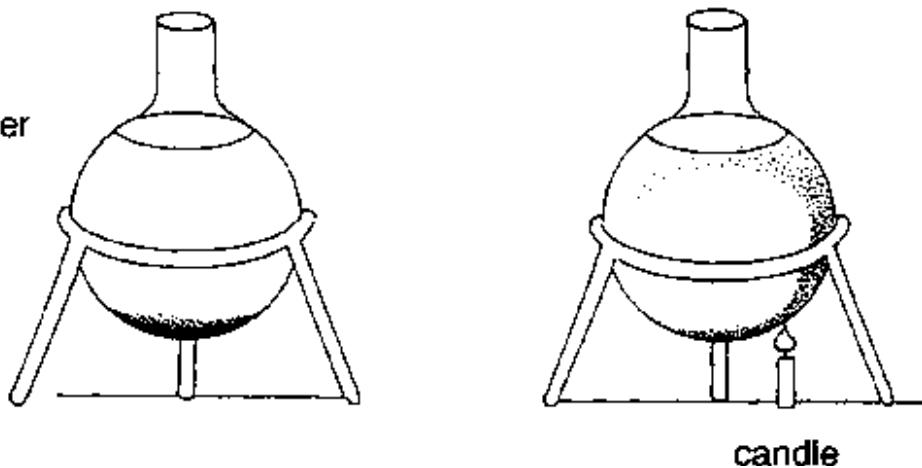

Observation:

The coloured water ascend at the side of the beaker which is heated. At the opposite side

the water sinks back to the bottom. After a while it circulates.

Analysis:

The warmed up water ascends and carries the colour with it. The density of heated water is less than that of cold water, which sinks back to the bottom. This “heat streaming” can be observed as long as the water is heated in the way shown.

Practical Use:

This phenomenon is used in warm water heating. In the basement, cold water is warmed up. Warm water ascends into the heating system, cools down and arrives at the boiler over a down-pipe. Today pumps are used to support this cycle.

Furhter thought:

In this experiment not only water is moving! It carries colour and something else. What?

6.5. DENSITY DIFFERENCE BETWEEN WARM AND COLD WATER

Main Goal:

These experiments show that warm water has a lower density than cold water.

Information:

The greatest density of water is at 4° C. Above and below this temperature, the density of water decreases (see experiment: WATER EXPANDS WHEN IT SOLIDIFIES)

Materials and Apparatus:

a. water heated to about 50° C

*ink
cold water of about 10° C
2 glass dishes
thermometer*

b. water heated to about 50° C

*ink
cold water of about 10° C
2 glass dishes
thermometer*

Procedure:

- a. The warm water is coloured with 1 - 2 drops of ink and then carefully added to the cold water.
- b. The cold water is coloured with 1 - 2 drops of ink and then carefully added to the warm water.

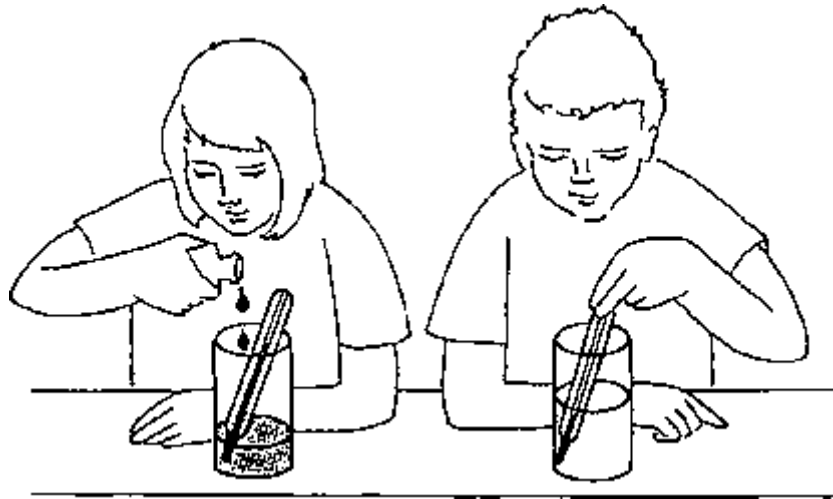

Observation:

- a. If added carefully and slowly by means of a glass rod where it 'slides down' to the surface of the cold water, the warm water floats on top of the cold water.

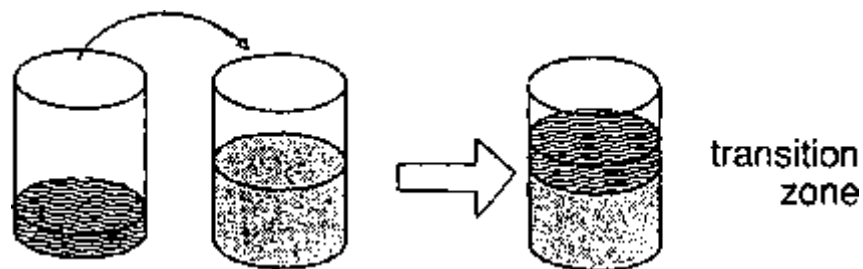

- b. Added in the same way to warm water, the cold water sinks more down to the bottom and mixes with the hot water.

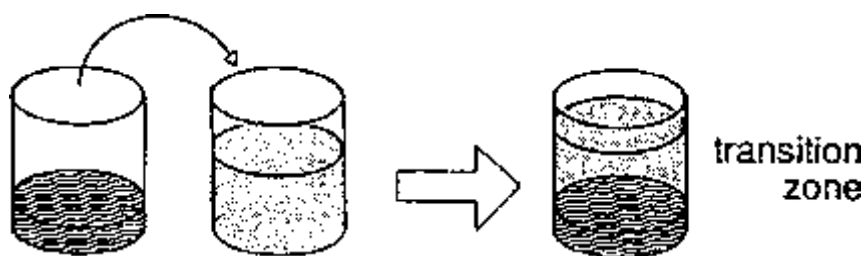

Analysis:

Warm water has a density lower than that of cold water. However this is only true for water above 4° C. Below this temperature, the density of water decreases again. Thus, water of 4° C is 'heaviest'. It has the highest density.

Practical Meaning:

This characteristic of water is important in countries in which the water freezes in winter. On the floors of frozen lakes, the water temperature is 4° C. Therefore, fish and other aquatic animals can survive in the deeper layers of these waters.

Further thought:

Suppose that water is used in a thermometer instead of mercury. Suppose further that it is 4°C . Then temperature changes. The thermometer indicates this change. Is this indication unequivocal?

6.6. HEAT RADIATION

Main Goal:

This experiment illustrates heat transmission by means of heat radiation.

Information:

“Heat radiation” is the name given to a process of transmission of energy, which is not linked with any specific Kind of substance. Sun rays reach earth through space which is void of air. The thermal energy of the sun is transformed into radiant energy and travels in that form through space. When it strikes an object on earth it is retransformed into thermal energy. This is the energy in the object due to the random motion of its molecules. The object, when it has higher temperature than another body or substance in its environment, can loose part of its thermal energy due to flow of heat to the colder body. Therefore, not heat is transmitted in the radiation process but radiant energy.

(see experiment: DARK MATERIALS COOL DOWN FASTER THAN LIGHT ONES)

Materials and Apparatus:

*any kind of heating element
(candle, heater, bunsen burner or burning glass and sunlight)*

Procedure:

Hands are held at a distance of about 10 - 20 cm from the heating element.

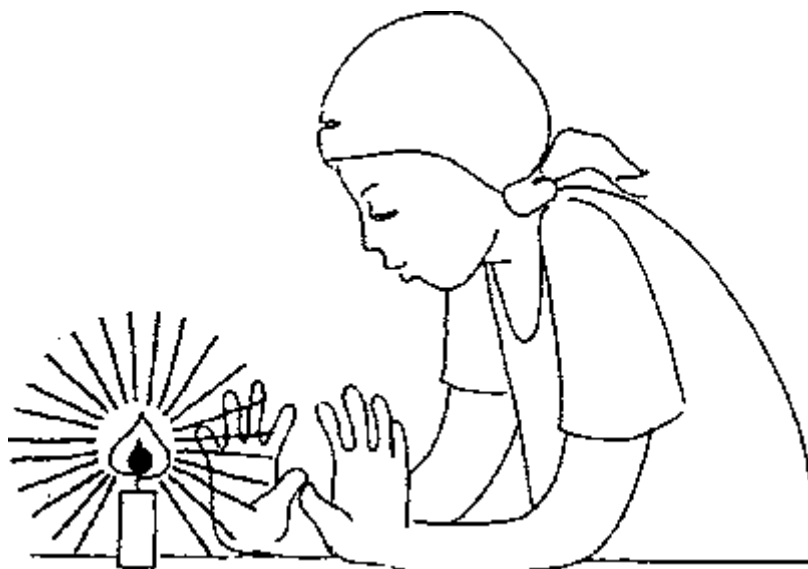

Observation:

A warming sensation is felt on the palms of the hand.

Analysis:

The energy transport hardly takes via heat conduction as air is a poor thermal conductor.

It cannot take place on the basis of heat streaming because warm air rises. The heat transmission in this case is called “heat radiation”. Heat radiation is not linked with any specific kind of substance. It needs no medium.

Practical Use:

Every kind of heating element exploits heat radiation (e.g. open fires, ovens, central heating).

With the help of sun collectors, the heat radiation of the sun is harnessed. Sun collectors include, for example black tubes through which water flows.

Further thought:

The composition of the upper atmosphere is changed. It prevents a greater amount of the earth’s “heat radiation” from escaping into the space. What are the consequences?

6.7. DARK MATERIALS WARM UP FASTER THAN LIGHT ONES

Main Goal:

Investigation of how different kinds of materials react to heat radiation.

Information:

Light materials reflect (from the Latin “reflectare”: to throw back) a greater proportion of heat radiation than dark materials.

Dark ones absorb (from Latin “absorbere”: to suck up) a greater amount of this radiation.

Some investigations have shown that rough surfaces absorb more heat radiation than smooth ones.

Materials and Apparatus:

*2 thermometers
soot or black paint
white paint candle, a gas burner or similar source of heat*

Procedure:

The mercury or coloured alcohol-filled bulb at the bottom of one thermometer is painted black with soot or paint. That of the other thermometer is painted white.

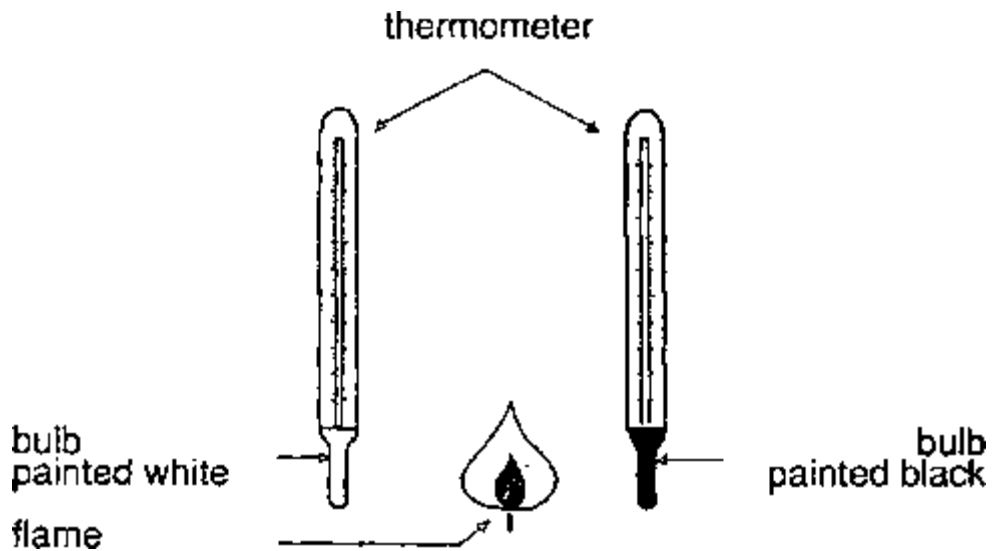

They are held close to some kind of heating unit.

Observation:

After a short time the blackened thermometer indicates a higher temperature than the white one.

Analysis:

Dark materials absorb in the same time and at the same distance from the heat source more heat radiation than light ones. The absorbed heat causes the temperature of the absorbing material to rise.

Light materials reflect the heat radiation better than dark materials.

Practical Use:

Refrigerators, freezers and refrigerator vans almost all have white, smooth surfaces so that heat radiation which hits them is well reflected.

In southern countries houses are painted white.

The people in these countries often wear light coloured clothes.

Sun collectors, for instance black tubes through which water flows, are black.

Further thought:

In countries where there is snow you can lay samples of light and dark cloth on the snow.

What can be observed?

6.8. DARK MATERIALS COOL DOWN FASTER THAN LIGHT ONES

Main Goal:

This experiment demonstrates that dark materials cool down faster than light ones.

Information:

Dark materials emit (from the Latin "emittere": to send out) heat faster than light ones.

Materials and Apparatus:

2 tins or glasses

2 thermometers

boiling water

a candle

soot or black paint

white paint

Procedure:

The outside of the tin is blackened with soot (or with black paint).

The second tin can be painted white although this is not absolutely necessary.

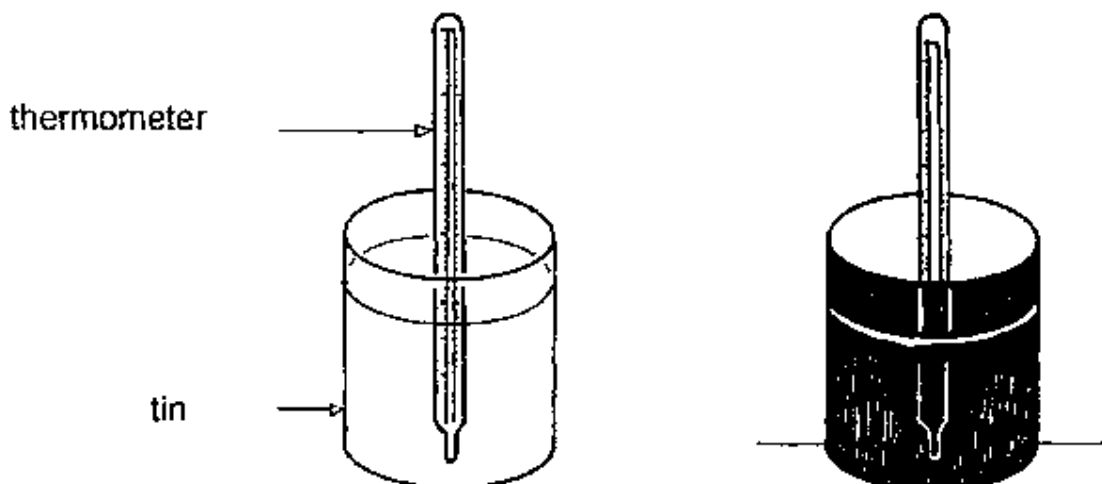

The two tins are filled with boiling water. The temperatures are taken regularly at intervals of 30 seconds or 1 minute. It might be useful to note the temperatures recorded.

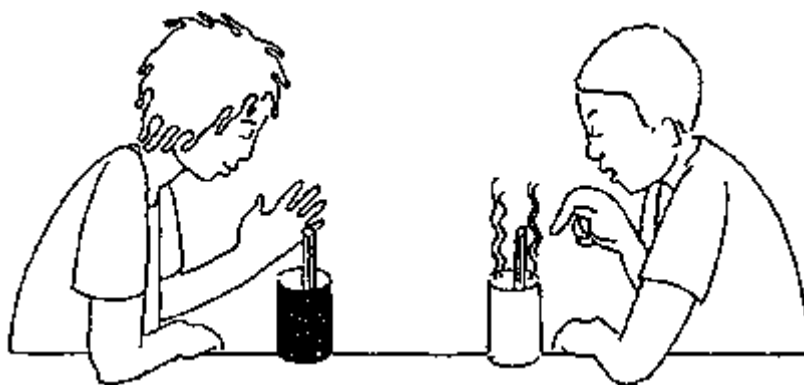

Observation:

The temperature of the black tin drops faster than that of the white one.

Analysis:

Black materials do not retain heat as long as light materials. Black materials emit heat faster than light ones. Thus black materials not only absorb heat better than light ones (see 6.7), but also are better emitters.

Practical Use:

The rays of the sun warm up the dark soil and water in daytime. The dark ground and the water emit heat so that the air warms up. The same amount of heat warms the water less than the ground, because it needs more heat to increase the temperature of 1 kg water than for 1 kg stone or soil.

At the coast it can be observed that the land warms up faster than the sea under the influence of sun radiations. As the air above the land is warmed up more, it ascends and the cooler air above the water streams onto the land. It is the other way round during the night. We perceive this heat streaming in the air as wind. In the daytime the wind blows from the sea onto the land, and during the night from the land to the sea. The degree of heating depends on the angle at which the sun's rays hit the earth and the water. The steeper the angle at which the sun's rays hit the earth, the stronger is the heating effect. This can be explained by the fact that in this case, more rays hit the ground per square metre.

Further thought:

Suppose at a restaurant you get coffee before you are ready to drink it. But you want it hottest when you are ready. When do you add the cream? Right away or when you are ready?

6.9. HEATING WITHOUT A FLAME

Main Goal:

The experiment illustrates the warming up of substances by mechanical work.

Information:

In contrast to heating bodies by heat radiation, conduction or streaming solids, liquids and gases can also be heated if they are mechanically worked on.

Work done in that way that friction force is applied on a body, increases the movement of the atoms the body is made of. This increase of (invisible) microscopic motion appears microscopically as an increase of temperature.

Materials and Apparatus:

- a. *blackboard or a table*
- b. *air pump*

Procedure:

- a. Vigorously rub a small spot on the blackboard with one finger. Immediately afterwards, feel this spot and its surroundings with the ball of the other hand.

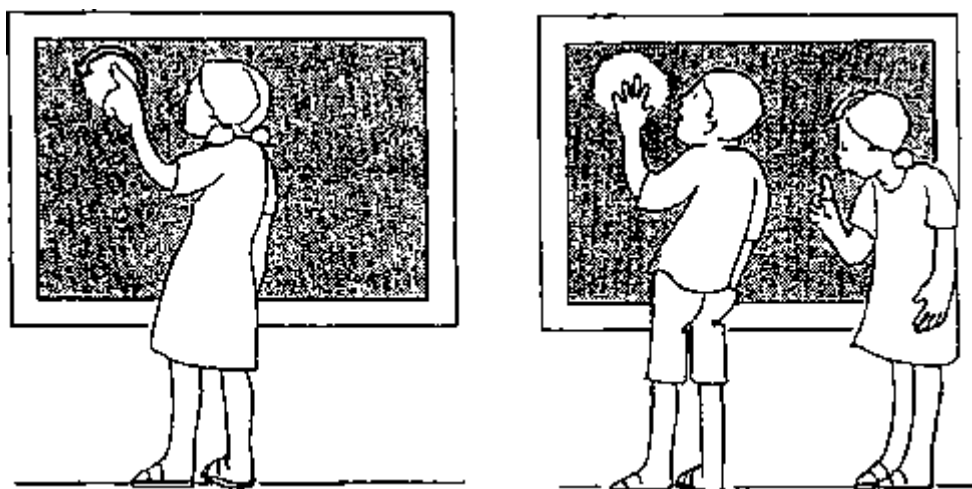

- b. The piston of an air pump is pulled out about 15 cm. The valve is closed with one finger. Then the piston is vigorously pushed into the cylinder.

This process should be repeated several times.

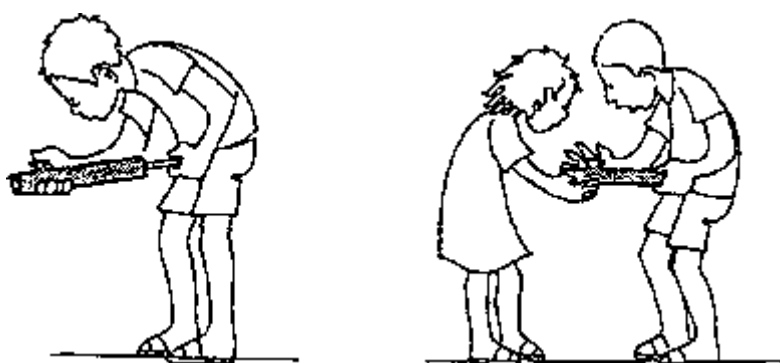

Observation:

- a. The blackboard and the fingers become warm.
- b. The cylinder is warm - this is also true of the air in the cylinder.

Analysis:

In both cases, mechanical work is done, which increases the movement of the atoms. In the first case this increase is transmitted by friction and in the second case by a pressure increase as well as by friction.

Practical Meaning:

When a spaceship enters the earth's atmosphere, its cover becomes very hot. The spaceship dives into the air, which presses it together. The strong increase of temperature results from the friction of the air with the spaceship. Friction increases the thermal energy.

If a bucket on a rope is let down into a well quickly, the warming up of the hands can be perceived.

The higher temperature results from the friction of rope and the palms of the hands.

Further thought:

When heat is flowing energy (from hot to cold) and thermal energy is due to random motion of molecules, what then is temperature?

7. AIR

7.1. THE AIR - A BODY

Main Goal:

The experiment demonstrates that air occupies space.

Information:

Air is a mixture of gases whose main components are 78.09% by volume nitrogen, 20.95% by volume oxygen, 0.93% by volume inert gases and 0.03% by volume carbon dioxide.

Materials and Apparatus:

a. *dry glass*

basin filled with water

b. funnel

pierced cork or rubber stopper
bottle
water

Procedure:

a. As shown in the diagram below, an empty glass is dipped into water, upside down.

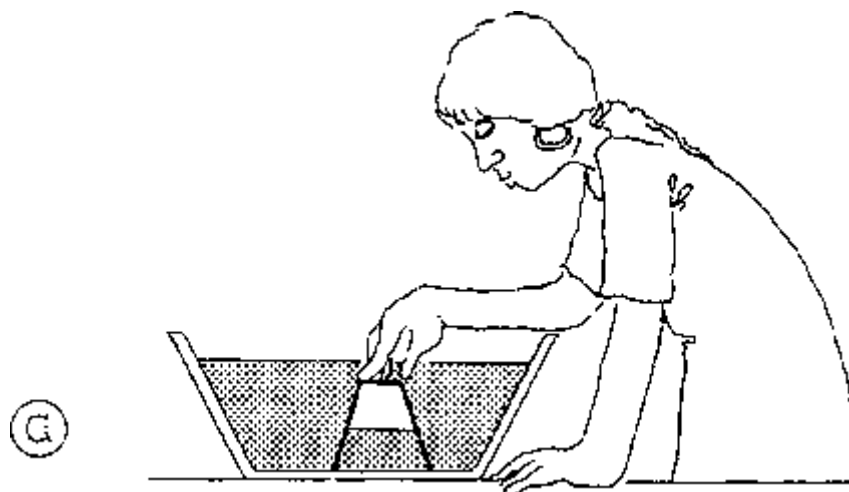

b. The apparatus is set up as shown in the diagram below. The funnel is filled with water, and then the stopper is eased out a little.

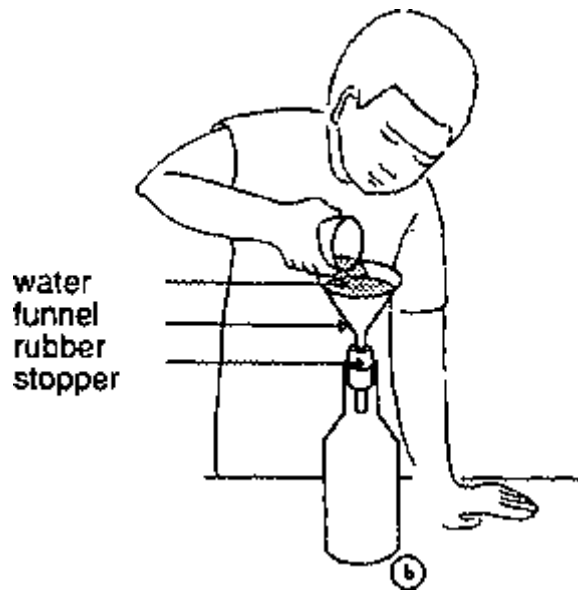

Observation:

- a. The water does not completely fill the glass. Part of the glass remains dry (see a).
- b. The water flows into the bottle only after the stopper is loosened.

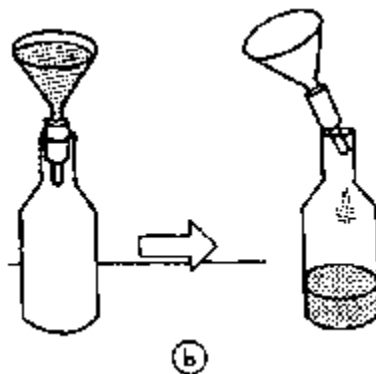

Analysis:

The glass and the bottle both contain air. This space can only be filled with water if the air is compressed or when it can escape. Air occupies space. Thus it is a body.

Futher thought:

Why does a balloon, filled with air, not rise?

7.2. WE FIND OUT ABOUT AIR RESISTANCE

Main Goal:

During this experiment the pupils feel air resistance.

Information:

Air is a mixture of gases. As gases too are bodies, where one body is, no other body can be. If one body wants to occupy the space where another body is situated, this other body must be displaced. Thus, when you occupy a certain space, you dislodge the air from this space. But air as a body, like all other bodies, offer some resistance against your efforts. Sometimes you can feel this drastically.

Materials:

newspapers or large sheets of cardboard

Procedure:

The pupils hold very large newspapers in front of their bodies and run quickly across the school yard or through the classroom. While running, they push the newspaper away from their bodies a few times.



Observation:

The newspaper is pushed against the body. When it is pushed away from the body, the resistance can be felt.

Analysis:

The resistance is caused by your moving against the air. Air consists of gases, which can be visualized as invisible bodies. All bodies offer resistance against their displacement.

Further thought:

It is difficult to breathe when snorkeling at a depth of 1 meter. It is practically impossible at a 2-meter depth. Why?

7.3. AIR RESISTANCE

Main Goal:

This experiment demonstrates air resistance.

Information:

Air consists of a mixture of gases. As gases too are bodies they offer resistance against change of their place.

Materials and Apparatus

- 1 sheet of paper
- 1 stopwatch, (or someone must count regularly)
- 2 cardboards of same size and same thickness

Procedure:

a) From a height of about 1.5 m, a student lets a sheet of paper fall as demonstrated in the following diagram. The time it needs to reach the floor is measured with the stopwatch.

In further experiments, the sheet of paper is gradually folded up until in the final experiment a ball is formed.

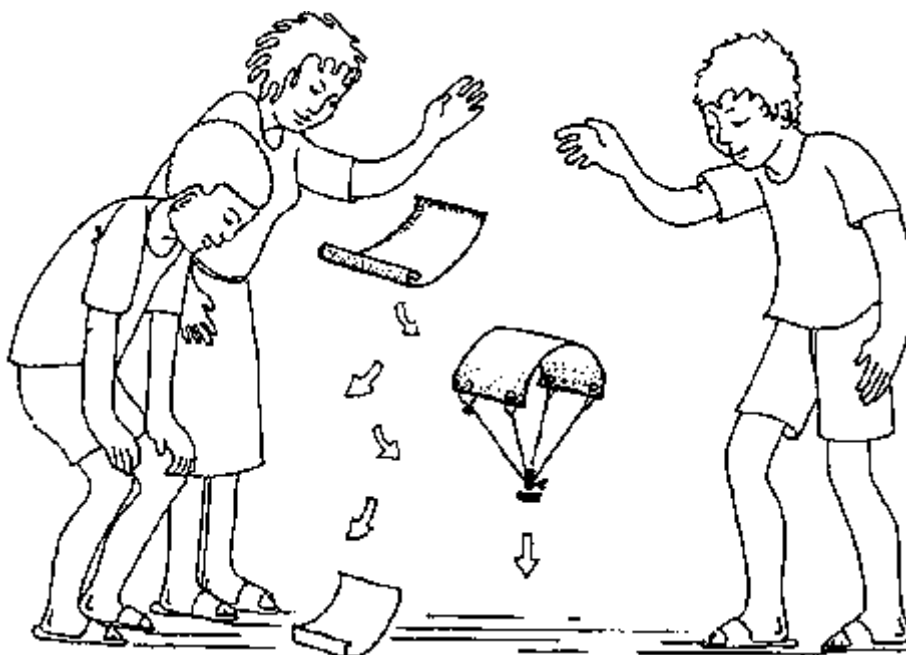

b) Drop the cardboards simultaneously from the same height so that one falls with one edge in front, the other one with a flat side in front.

Which one hits the ground first?

Observation:

a) The smaller the paper is, the faster it falls to the floor.

b) That one with the edge in front hits first.

Analysis:

The smaller the surface that points in the direction of motion, the less air resistance met. From further experiments it is known that the shape of the falling object also plays a role.

Practical Use:

Parachutists take advantage of air resistance. The round shape of a parachute significantly increases the time of falling compared to a flatter shape.

The seeds of plants, which are spread by the wind, are also shaped in such a way that they harness the air resistance.

Addition:

In order to make a parachute, four cords of equal length are fastened to the edges of a square cloth. The ends of the cords are tied together and attached to a moderately heavy screw.

Further thought:

A stone dropped from the top of a tower becomes faster when it falls. A parachutist falls toward the earth with constant speed.

Why this difference?

7.4. THE DIFFUSION OF GASES

Main Goal:

This experiment illustrates the diffusion of gases.

Information:

Gas particles diffuse into even space, no matter how large it is.

Materials and Apparatus:

perfumed substance perhaps a spraycan or an atomizer with mosquito spray, perfume, or a strongly smelling flower or fruit)

vessel

Procedure:

1 - 2 ml of the perfume are placed into the vessel.

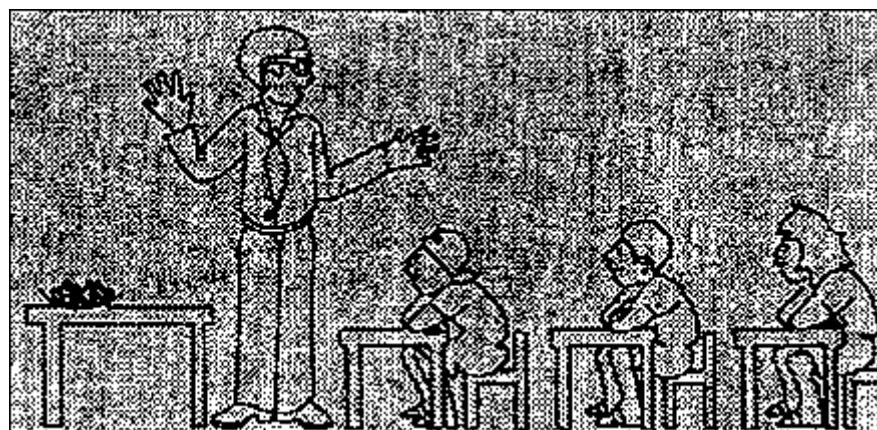
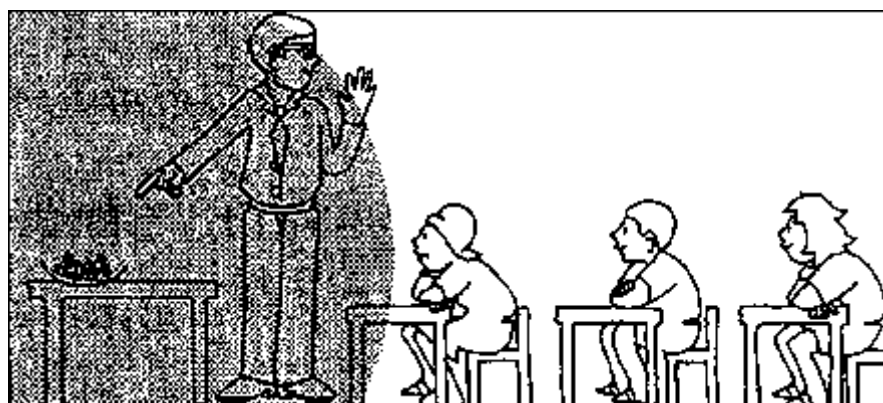
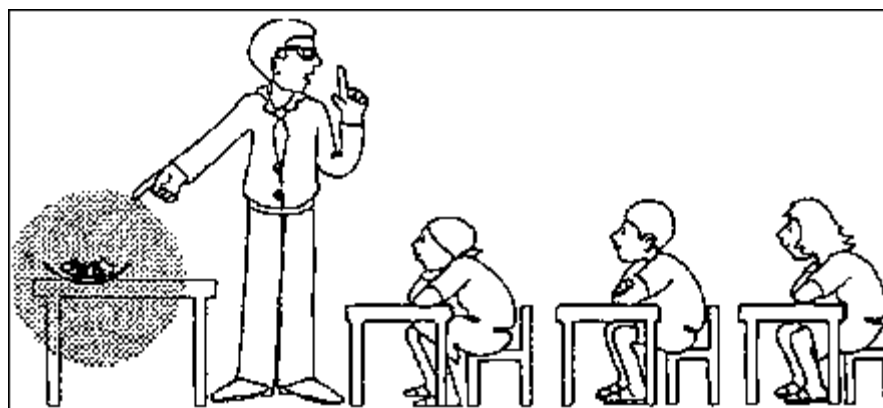

Observation:

After a short time the smell can be detected by pupils sitting near the teacher's desk. A little later also pupils in the following rows of seats smell successively the perfume.

Analysis:

Gases diffuse into each space. This unaided distribution of particles is called diffusion. We cannot see the perfume moving through the classroom. It is said that all bodies, also perfume, is made out of atoms. Therefore, atoms must be very very small.

Further thought:

What changes when you heat the perfume?

7.5. CARBON DIOXIDE IS HEAVIER THAN AIR

Main Goal:

Gases, like solid matter, have different densities.

Information:

When carbon dioxide is produced in a vessel, it concentrates first at the bottom of the vessel, as it is heavier than air. Later it completely displaces the air. The carbon dioxide then gradually diffuses evenly. (See experiment: DIFFUSION OF GASES)

Materials and Apparatus:

3 candles
empty bottle, tubing, rubber stopper
Alka Seltzer (or sparkling lemonade)

Procedure:

A glass dish is prepared as shown in the diagram below. Using Alka Seltzer and water, both put into the bottle, carbon dioxide is produced and led into the glass dish. (Or, carbon dioxide from lemonade is conducted through the tubing into the dish. It is also possible to exhale air into the dish through the tube.)

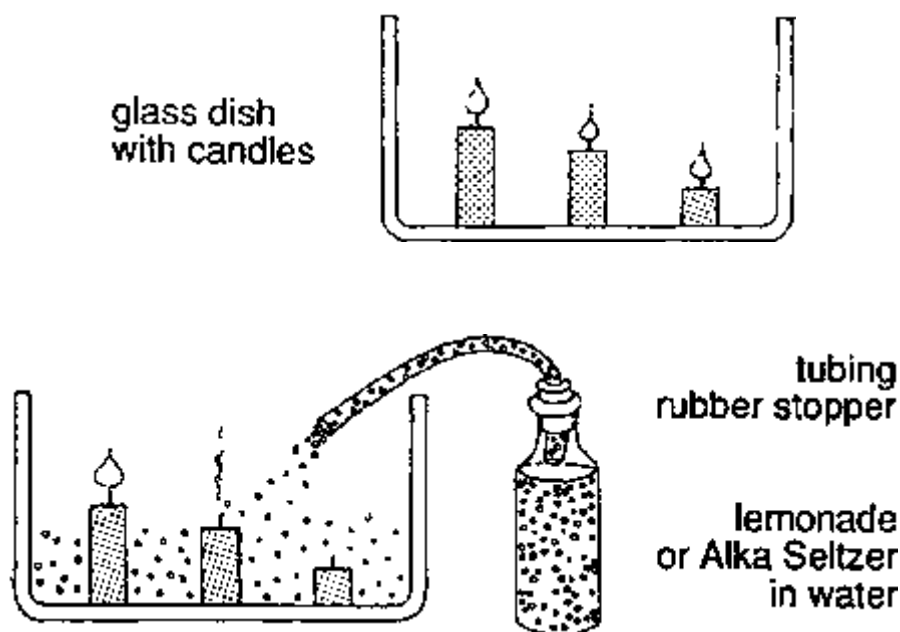

Carbon dioxide from lemonade or Alka Seltzer is conducted through the tubing just to the top of the glass dish.

Observation:

The candles are extinguished one by one because the carbon dioxide sinks down. It is heavier than air. (A burning match is extinguished when dipped into the carbon dioxide atmosphere.)

Analysis:

The carbon dioxide is heavier than air and sinks down and concentrates at the bottom of the dish. The more carbon dioxide is produced, the more air is displaced.

Practical Use:

Where it is impossible to use water to extinguish a fire, carbon dioxide is used, e.g. in power stations or in chemical firms. Carbon dioxide leaves no residues and does not conduct electricity.

Human beings and animals breathe in oxygen and exhale carbon dioxide. Plants produce glucose and oxygen from carbon dioxide and light.

Further thought:

The increase of carbon dioxide concentration in air atmosphere has serious consequences (greenhouse effect).

What would be the best 'biological' mean against this effect?

7.6. THE PHENOMENON OF AIR PRESSURE

Main Goal:

This experiment demonstrates the consequences of air pressure.

Information:

Air is a body and exerts pressure. The average air pressure is 1 bar. This pressure equals water pressure at a depth of 10 m under the water's surface.

With increasing height, e.g. in the mountains, the air pressure decreases.

Materials and Apparatus:

*glass, paper, water
empty cola can
heater
bowl with cold water*

Procedure:

a) Fill a little water into the empty cola can (four tea spoons are enough). Heat that water so that it boils. Let it boil for a minute. Then dip it -upside down - into the cold water in the bowl. Observe the dramatic effect.

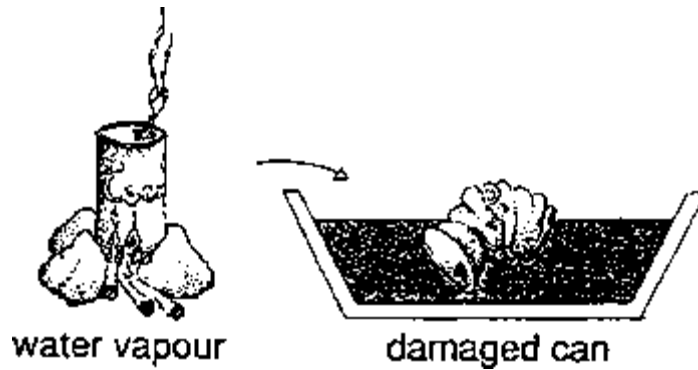

b) The glass is filled up to the rim with water. Then it is covered with the paper, which is pressed down with the palm of the hand. The paper is held tight until the glass has been turned upside down.

Observation:

- a) The can is compressed and damaged.
- b) From the glass the water does not run out.
(Warning! After a certain time the paper will be soaked through.)

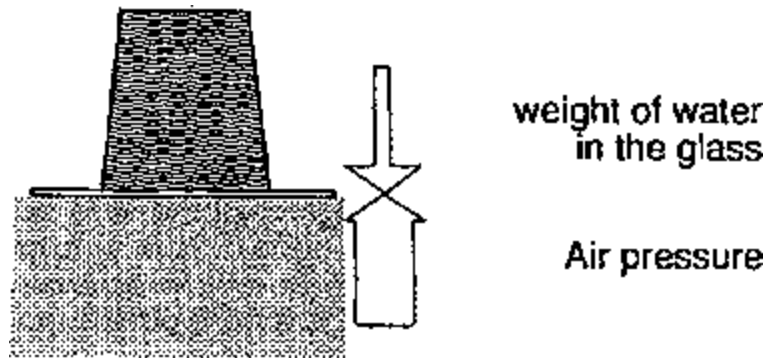

Analysis:

The air in the can is replaced by water vapour. In contact with cold water vapour condenses. Inside the can is suddenly very low pressure, so that the outer air pressure presses the can.

The external air pressure is greater than the pressure exerted by the water in the glass.

Practical Use:

To secure the water supply, pressure and suction pumps can be used.

By means of suction pumps, water can theoretically be sucked up to a height of 10 m. However, in practice it can only be sucked up to a height of 8 m, due to the fact that valves are not entirely leaktight.

As there are pipes linked to the pressure pumps, the water is conveyed 10 m high.

Both pumps operate on the principle that, on raising the piston, low pressure is generated.

The air pressure then forces the groundwater into the pump. Repeated pumping movements result in the filling of the pump with water, which flows out through a discharge pipe in the case of a suction pump. In a pressure pump the water is forced into a carrying pipe. Valves, which only open under the pressure of the water in the pump, prevent the water flowing back down the vertical pipe.

Further thought:

Make a small hole near the bottom of an open tin can. Fill it with water. It will spurt from the hole. Cover the top of the can firmly with the palm of your hand. What happens? Why?

7.7. HOW A DRINKING STRAW WORKS

Main Goal:

This experiment demonstrates the practical use of air pressure.

Information:

Air pressure is caused by randomly moving atoms or clusters of atoms (molecules) bouncing randomly against other matter.

Materials and Apparatus:

*water or a beverage
a drinking straw
glass*

Procedure:

Some water is sipped through the straw.

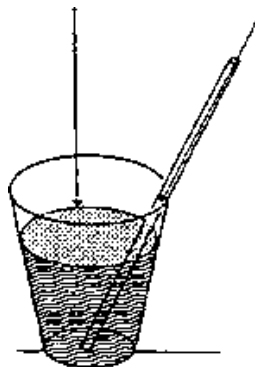

Observation:

see diagram

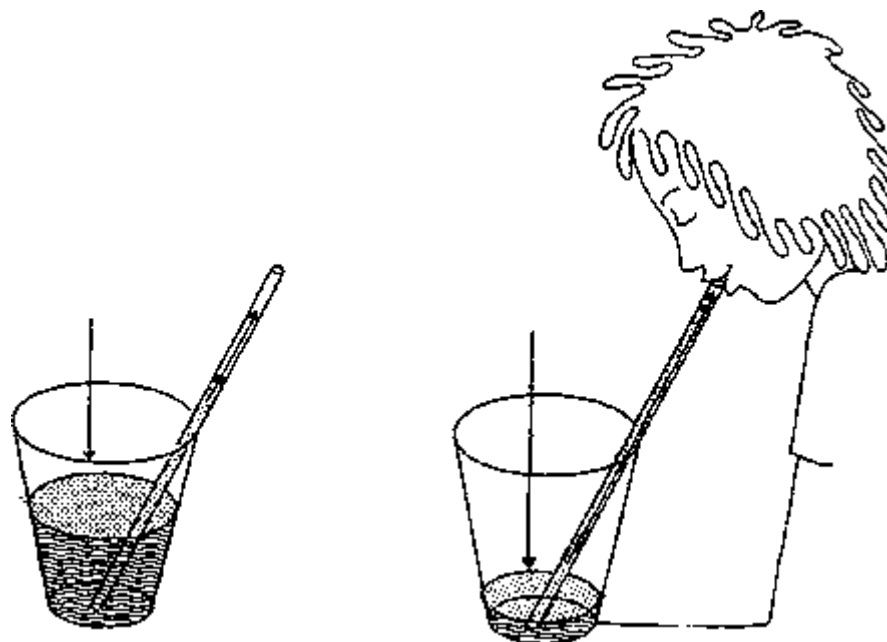

Analysis:

First the air is sucked out of the straw. This creates a space in which the air is rarefied and a space with low pressure is formed.

The ambient air pressure, which is higher, presses on the water surface, forcing the water to rise up the straw. A low pressure region is also formed in the mouth, due to the continual sucking. Therefore the water is always pressed into a space in which the air is rarefied.

(see also experiment: THE PHENOMENON OF AIR PRESSURE)

Strictly speaking, one does not suck the water up the straw. One instead reduce pressure in the straw and allow the pressure of the atmosphere to press the water up into the straw.

Further thought:

On the moon there is no air atmosphere.
Could one drink water this way on the moon?

7.8. THE DANCING COIN

Main Goal:

To demonstrate that gases are bodies which expand when heated.

Information:

Air expands when heated.

Materials and Apparatus:

*a bottle - the glass should be very thin
a coin which covers the opening of the bottle.*

Procedure:

The rim of the bottle neck is wetted with some water, and the opening covered with a coin. When the bottle neck is grasped with both hands, the air in the bottle expands due to the transmission of heat from the hands to the bottle and from the bottle to the air in the bottle.

The pressure in the bottle becomes higher than the ambient air pressure, so that the coin is lifted up briefly again and again.

(The glass also expands a little.)

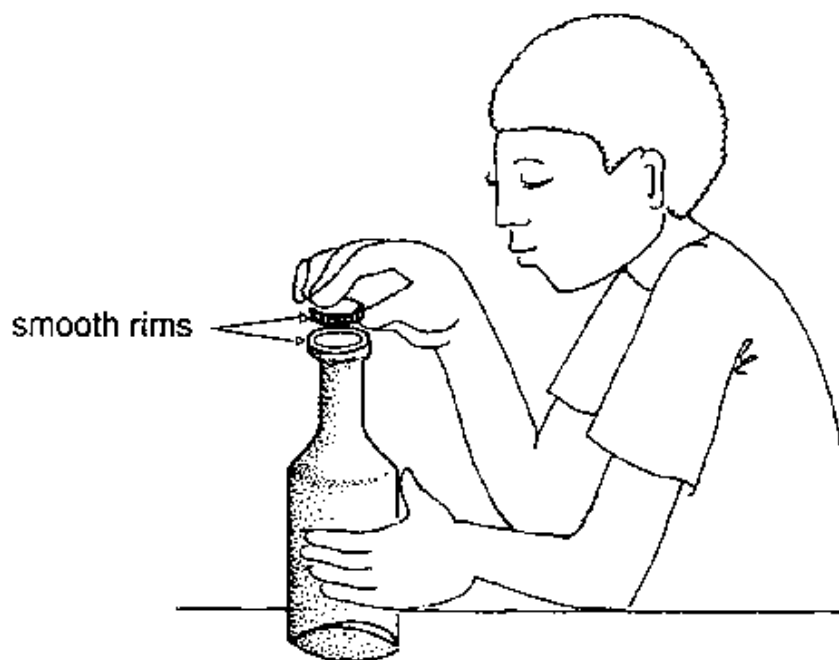

Observation:

The coin “dances” on the bottle neck.

Analysis:

A transfer of heat causes the air in the bottle expand. The pressure increases, lifts the coin, some air escapes and the pressure is reduced for a moment. Then the heat transmission again expands the air, pressure increases and the coin lifts up again, and so on.

Practical Use:

All gases expand when heated. Gas tanks have to be protected against the sun, otherwise they eventually would not be able to withstand the excessive pressure of the expanding gas. Fizzy beverages must be chilled to prevent the escape of the carbon dioxide.

Further thought:

When heat is transferred to the air, also glass expands. Then the volume of the bottle must increase. Doesn't this just compensate the air expansion? Obviously not. What kind of conclusion can you draw?

7.9. THE BALLOON IN THE BOTTLE

Main Goal:

To demonstrate air pressure, excessive pressure, and vacuum.

Information:

Warmed air enclosed in a certain volume, expands. The pressure increases and some air escapes.

When cooled down and no air from outside is allowed to enter the volume, low pressure is generated inside that volume.

Materials and Apparatus:

1 bottle

1 balloon

paper

Procedure:

A piece of paper is set on fire in a bottle. A balloon is then placed onto the neck of the bottle, immediately the paper is burnt.

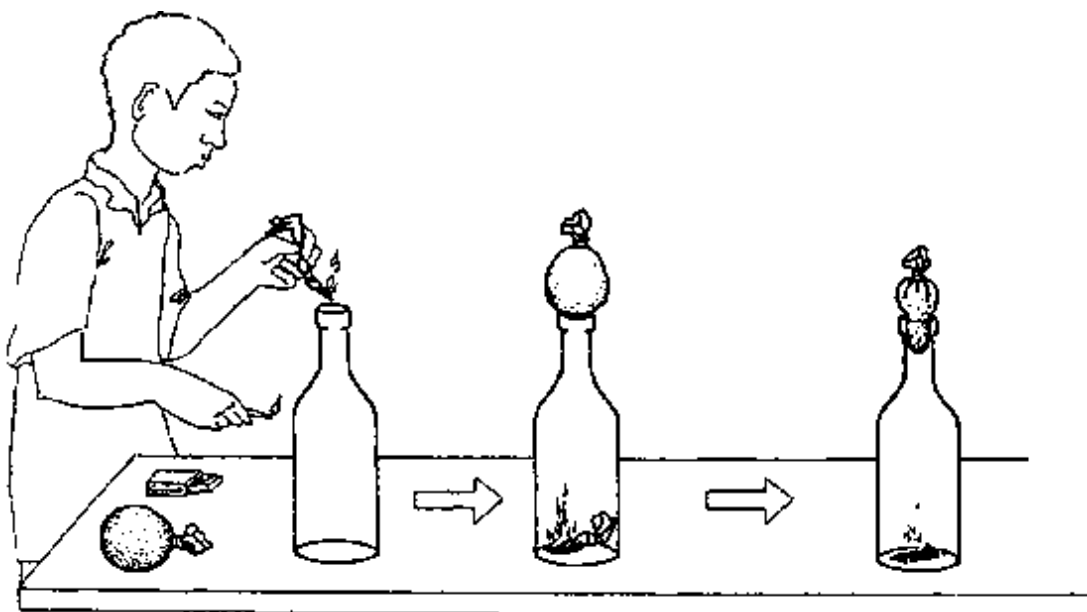

Observation:

see diagram

Analysis:

Due to the burning of the paper, the air in the bottle is warmed and some of it escapes. The balloon closes the bottle opening. As the air inside the bottle cools down, less air is now present in the bottle and lower pressure than outside is created. The air pressure outside of the bottle presses the balloon into the bottle neck.

Further thought:

gas-meter measure the volume of gas you are using.

Who would gain by having gas warmed up before it passes the meter, you or the gas company?

7.10. THE FOUNTAIN EXPERIMENT

Main Goal:

The experiment essentially demonstrates:

- **gases are bodies**
- **gases expand and contract**
- **the existence of air pressure**

Information:

When heated, gases expand much more than solids and liquids. If the pressure remains constant, ideal gases expand when heated by $1/273$ of their volume 0°C for every 1 degree they are heated.

When cooled down, they contract to the same extent. In the following experiment, most of

the air is expelled from a glass vessel by heating. When it cools down, the remaining gas is under lower pressure. The external, higher air pressure presses the water into the glass vessel, until a pressure balance is created.

Materials and Apparatus:

- glass pipe, 20 cm long, which is pointed at one end*
- pierced stopper (rubber or cork)*
- glass flask or bottle made of clear glass*
- glass dish*
- burner (alcohol or gas burner or a candle)*
- water (may be coloured with water soluble eosin or ink)*

Procedure:

The apparatus is set up as shown in the diagram below. The flask is held at the neck and carefully heated from the side. When there are only a few gas bubbles escaping from the flask, the burner is set aside. The dish is held vertically in such a way that the end of the glass pipe is always submerged.

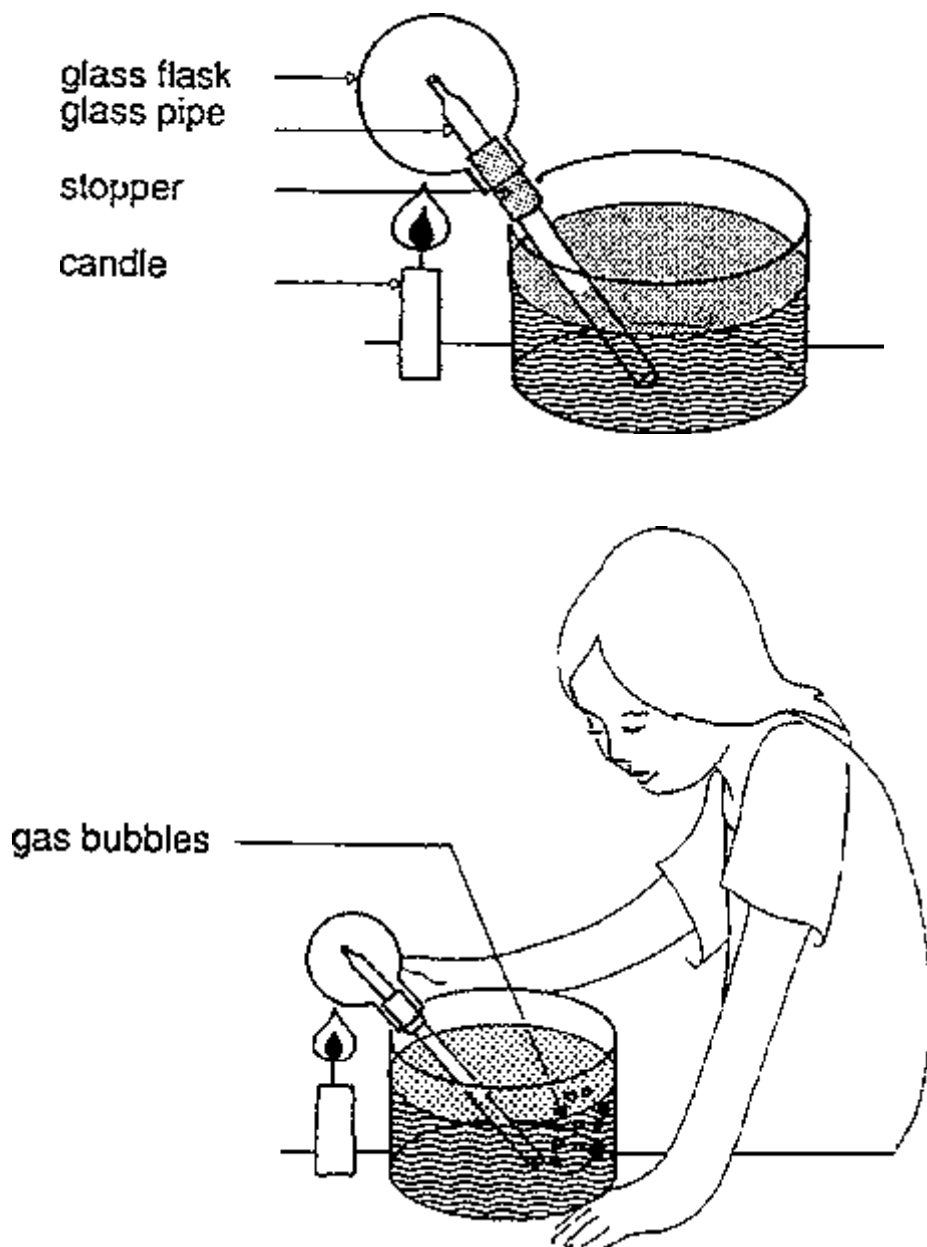

Observation:

When the glass pipe is first heated a large number of gas bubbles escape. The number of gas bubbles decreases gradually. Some time after the burner is removed, water shoots into the flask.

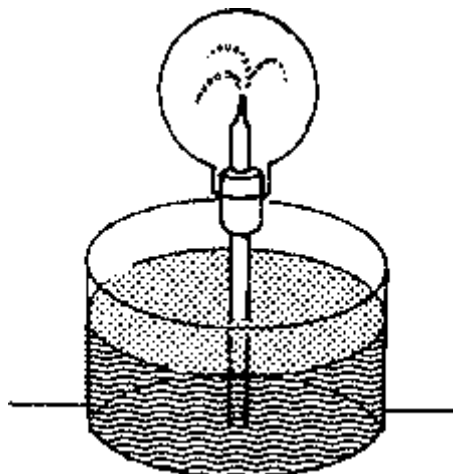

Analysis:

When the glass flask is heated, the air expands greatly and part of it escapes. When the burner is removed, the remaining air in the flask cools down. It's now less air inside which needs under normal temperature less space. The gas contracts, and the outer air pressure presses water into the flask until the pressure inside is equal to the pressure outside.

Practical Use:

Bicycle and car tyres can burst if they are over inflated and then exposed to the sun.

Further thought:

Why do the gas bubbles rise?

7.11. THE PHENOMENON OF AIR FLOW

Main Goal:

This experiment illustrates air flow.

Information:

Warm air ascends in a room, so that the lowest temperature is always found at floor level. Heated air expands. Its density is less than that of cold air, and it therefore ascends into the upper layers. Cold air flows in from the surrounding, is also heated, expands and ascends.

Materials and Apparatus:

thick wire about 20 - 30 cm long
wooden board
a streamer made of thin cardboard
a candle

Procedure:

A spiral shaped streamer is cut out of cardboard.

The experiment is set up as shown in the following diagram.

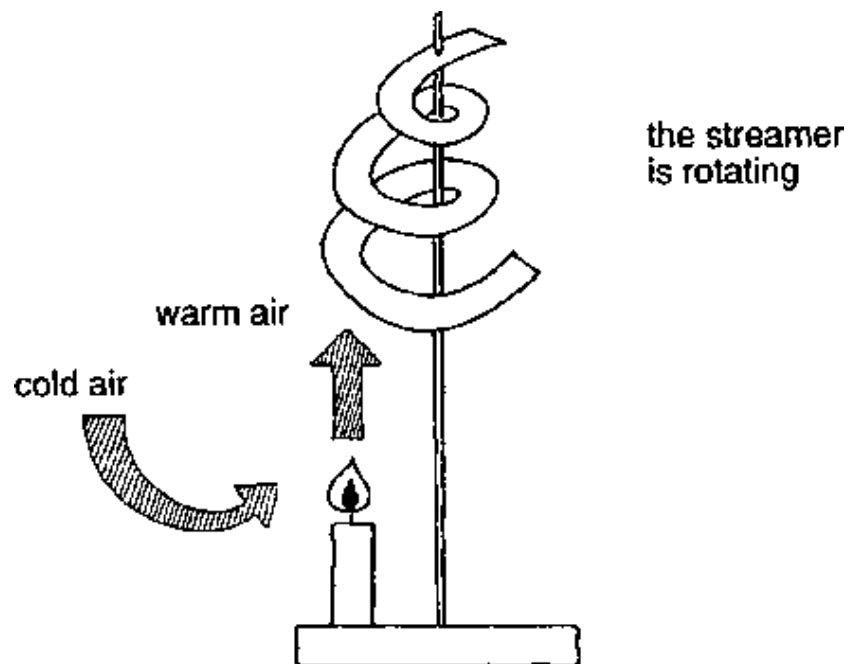
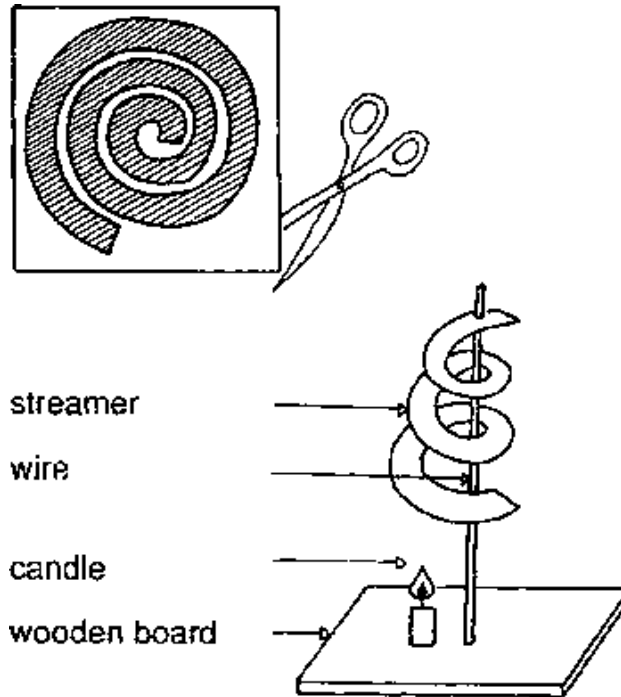

Observation:

The streamer starts rotating.

Analysis:

The candle warms the surrounding air. The warm air ascends and causes the streamer to rotate. Cold air flows in to replace the ascending warm air, is also heated, and the process continues.

Practical Meaning:

When a house burns, the air is heated strongly, and ascends. Cold air containing oxygen flows in very quickly. This effect causes a strong wind. Open doors and windows support this process, which supports the fire.

Further thought:

How can it happen that birds in the air gain height without moving their wings?

7.12. THE AERODYNAMIC PARADOX

Main Goal:

This experiment demonstrates that low pressure is generated by streaming air.

Information:

The aerodynamic paradox it applies also to liquids, where it is called hydrodynamic paradox. It states that, the higher the pace of streaming, the lower the pressure. Consequently, if the pace of streaming increases due to a decrease of the sectional area of a pipe, the pressure within this area decreases.

Materials and Apparatus

2 sheets of paper
2 wooden rods

Procedure:

The paper is placed round the wooden rods as shown in the diagram.

Air is blown, alternately lightly and strongly, between the two sheets.



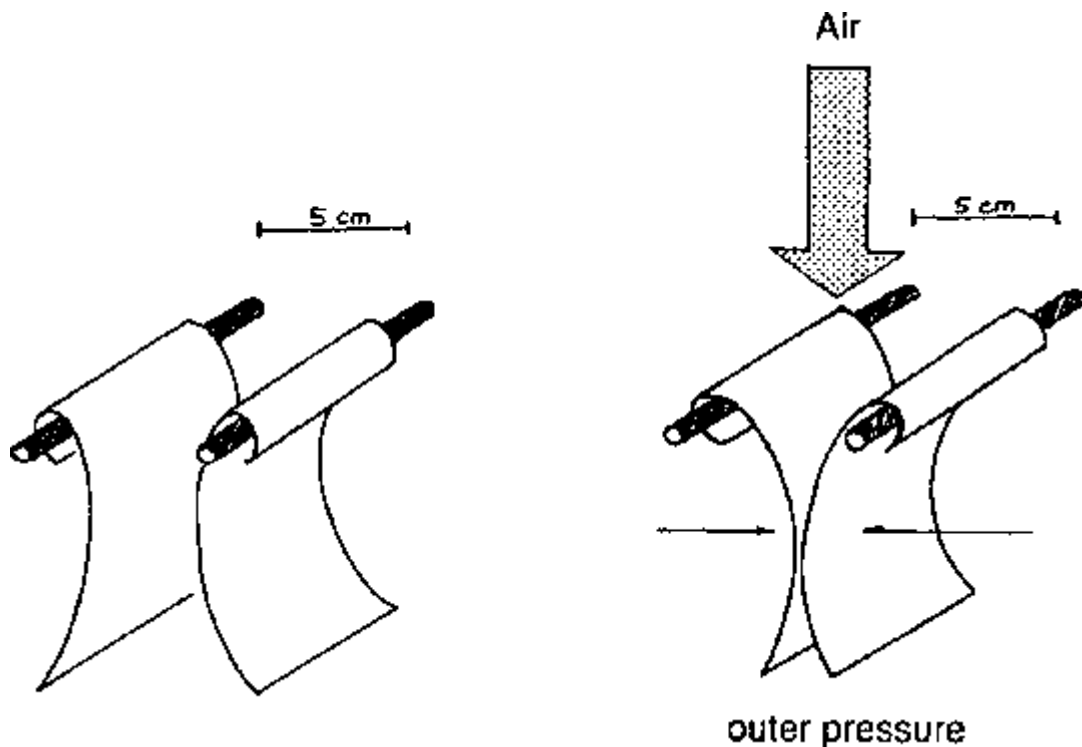

Observation:

Against our intuition the two sheets are drawn towards each other and not apart!

Analysis:

The blown air streams between the two sheets with high pace. An area of low pressure is generated.

The faster the pace of the streaming (the more strongly the air is blown), the lower the pressure in the flow. The normal outer air pressure pushes the sheets together.

Practical Use:

This paradox (it is called paradox because its against our intuition) is harnessed in water jet pumps and in the construction of aeroplane wings.

Further thought:

What is the consequence of this effect with respect to the roofs of houses in case of a strong storm?

7.13. THE BOYLE-MARIOTTE LAW

Main Goal:

This experiment demonstrates the relationship between the volume and pressure of gases.

Information:

If the pressure exerted on a closed gas volume is increased, the volume decreases.

If the pressure exerted on a closed gas volume is decreased, the volume increases. This means that gas always occupies the whole volume available. Moreover, it tends to expand and to enlarge its volume permanently.

The English physicist Boyle (1627 - 1691) and the French physicist Mariotte (1620 - 1684) discovered this association, which is the basis of a law linking the pressure and volume of gases.

The law states that the product of pressure and volume is constant. It is valid only at constant temperatures.

The pressure of gases can be demonstrated with the help of the model of particles: gas particles are in constant motion, and when they collide with an obstacle, they exert pressure.

Materials:

air pump

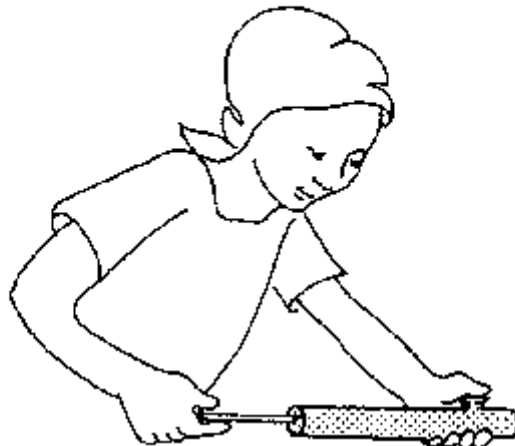

Procedure:

The piston of the air pump is pulled out of the cylinder, and then the valve opening is sealed with one finger. The piston is then pressed as far as possible into the cylinder.

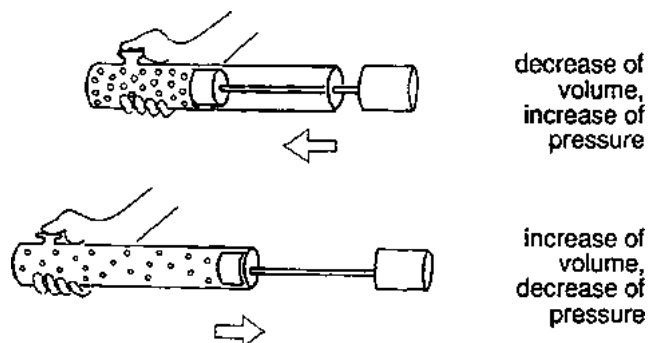

Observation:

Air can be pressed together. The further the piston is pressed into the cylinder, the greater the force required, the greater the pressure of the enclosed air.

The further the piston is pressed into the cylinder, the more quickly it jumps back out when released.

(The air pump and the enclosed air warm up. See experiment: WARMING UP WITHOUT A FLAME)

Therefore, Boyle's Law is not an accurate description of this effect.

Analysis:

If a given gas volume is decreased, its pressure is increased.

If a given gas volume is increased, its pressure is decreased.

Further thought:

Boyle's Law can be written in shorthand notation as a formula

$$p_1 \times V_1 = p_2 \times V_2 = \text{const.}$$

(p = pressure, V = volume)

There are other laws in physics that have the same structure, e.g. the Law of Lever.
Compare!

7.14. MOVING FORWARD BY REPULSION

Main Goal:

This experiment demonstrates the phenomenon of repulsion.

Information:

Air which escapes from an narrow orifice produces a repulsion.

Two forces always come into play: one in the direction of the streaming, the other in the opposite direction.

Materials:

1 balloon

Procedure:

The balloon is completely blown up.

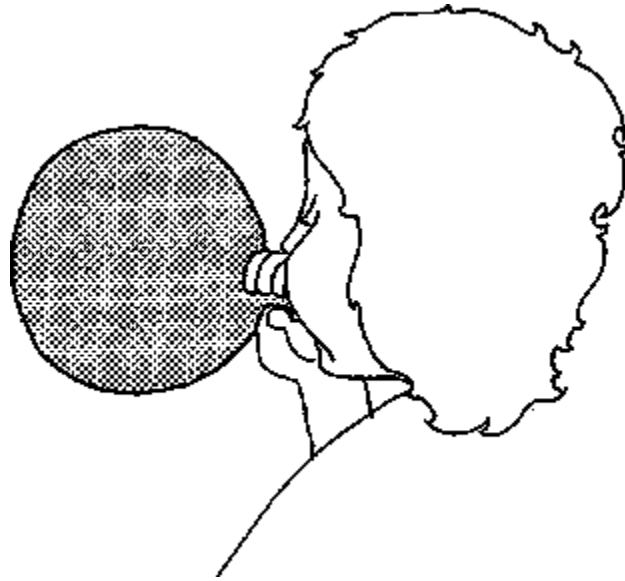

Its opening is first held closed, and then the balloon is released.

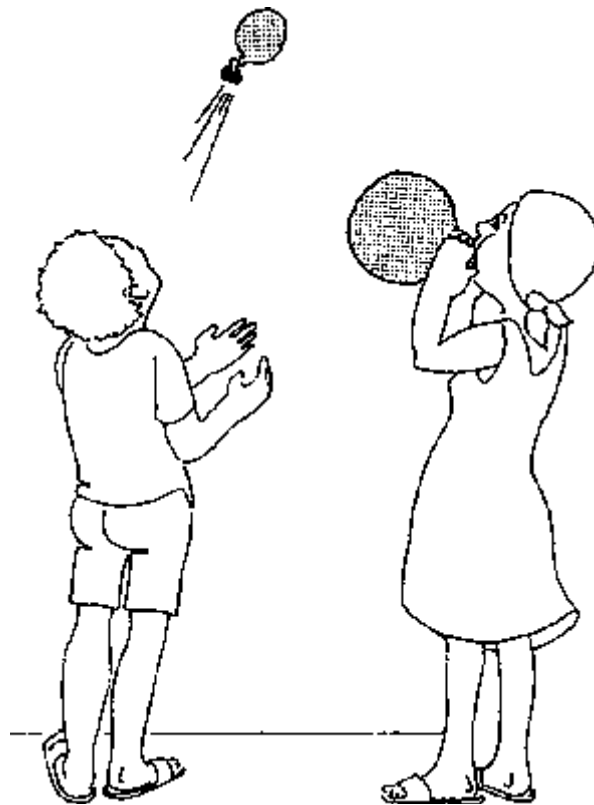

Observation:

The balloon moves around jerkily. First it flies upwards, and then it moves uncontrolled through the room. The escaping air hisses.

Analysis:

The balloon moves because of the repulsion, in the opposite direction to the

escaping air. One force in the direction of streaming. This force stems from the tension of the rubber of the balloon. It pushes the air through the orifice. On the other hand: the air pushes back and causes the balloon to move in the opposite direction. The two forces are equally strong.

Practical Use:

Jets and rockets move forward due to this principle of repulsion. They are driven forward by combustion gases escaping rapidly.

Further thought:

What happens to a boat when you jump out of it?

8. WATER

8.1. MODEL OF A WATER-PIPELINE

Main Goal:

The same air pressure acting on the surfaces of a liquid in joint vessels which are opened at the tops causes them to lie at the same level, (exceptions are very narrow vessels because of capillarity.) This principle is applied in water-pipes in technology. (Ground water is pumped into a water-storage tank such as a water-tower. The storage tank must be higher than the taps.)

Materials and Apparatus:

*funnels or bottles from which the bottoms are cut off
(use caution!) or glass-pipes tubing
2 nails
hammer
rope
water*

Procedure:

As demonstrated in the following diagram, the principle of a water-pipeline is illustrated.

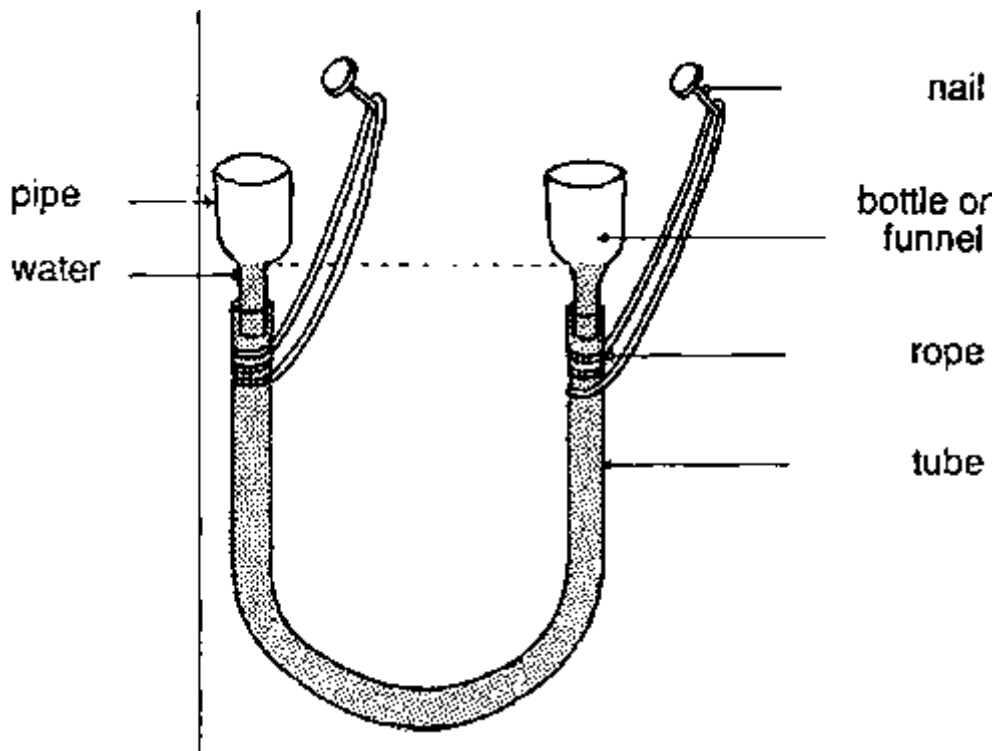

The bottles (or the funnels) are alternately lifted and lowered. In the beginning, the two water surfaces lie at the same level.

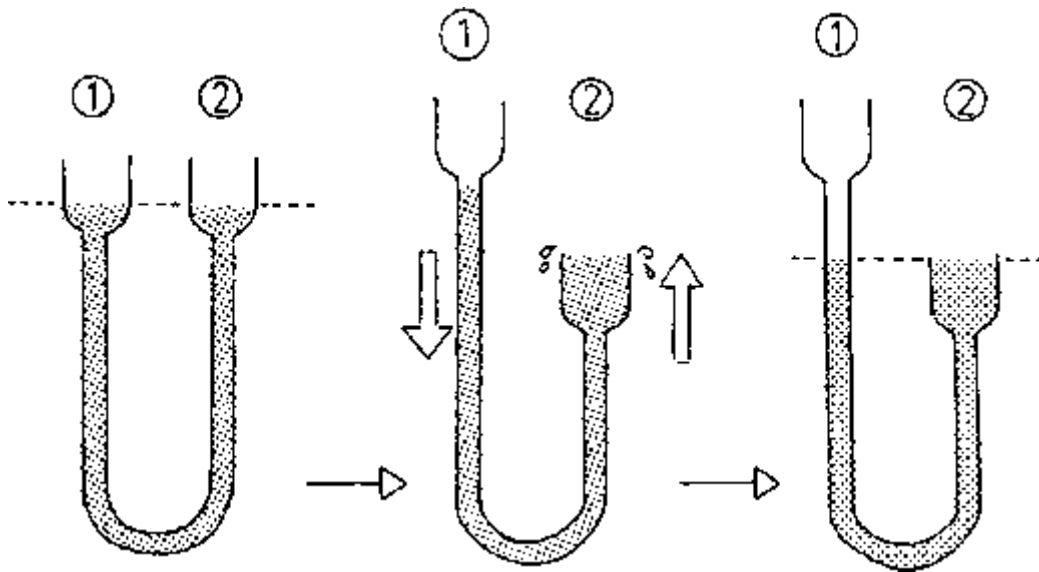

Observation:

If bottle 1 is lifted, the water level in bottle 2 is suddenly lower than that one in bottle 1 and then the water rises into the bottle 2 until the two water columns are equally high.

Analysis:

In joint vessels, water tends to stand at the same level. Thus water can be taken from taps which are placed lower than the water-storage tank. If the bottle 1 is lifted up high enough, water will spout out of the top of bottle 2.

Practical Use:

The principle of joint vessels is used in floodgates. Ships are lifted or lowered onto an adequate water level with the help of water which flows in and out.

Further practical applications: Roman water pipes, wells, irrigation plants.

Further thought:

This experiment contains implicitly a method to keep a gas volume constant when the temperature rises.

How does it work?

8.2. THE PRINCIPLE OF A WELL

Main Goal:

This experiment demonstrates the working mechanism of joint vessels

(see experiment: MODEL OF A WATER-PIPE)

Information:

In order to obtain drinking-water, a well can be dug into the aqueous layers of the soil. The ground water soaks into the well up to the level of the ground water surface and can be

taken from the well with a bucket.

Materials and Apparatus:

tin (cola tin) with the top removed
nail
hammer
glass vessel or a bucket with water
tin-opener or pair of plate-shears

Procedure:

Two to three holes are made with the nail and the hammer in the tin walls.



As demonstrated in the diagram below, the tin is dipped into the water.

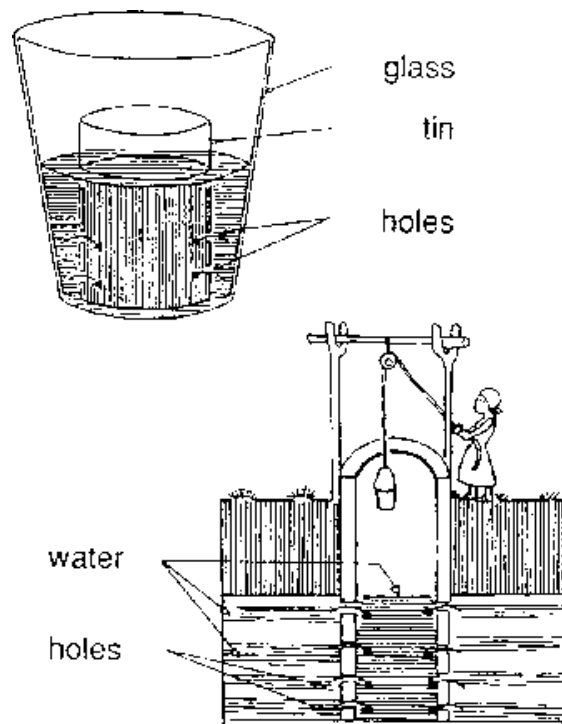

Observation:

The water soaks into the tin through the holes. The water level inside and outside of the tin adjusts itself after a short time.

Analysis:

The well which is represented by the tin, and the ground water surface represented by the water surface in the vessel are joint vessels. In joint vessels the water surfaces always adjust to each other.

Further thought:

What is the maximum height to which water could be drink through a straw?

8.3. THE SIDE-PRESSURE OF A WATER-COLUMN

Main Goal:

This experiment demonstrates the pressure increase from the top to the bottom of a water column.

Information:

The pressure of a liquid onto the bottom and sides of a liquid column depends exclusively on its height. The pressure increases towards the bottom. A water-column of 10 m exercises a pressure of 1 atmosphere (about 1.013 bar) onto the bottom.

Materials and Apparatus

*container made of sheet metal (tin or cola tin)
- should be very high and open at the top -
nail
hammer
water
plate-shears or tin-opener*

Procedure:

3 holes are made at different heights in the metal container. Afterwards it is filled with water.

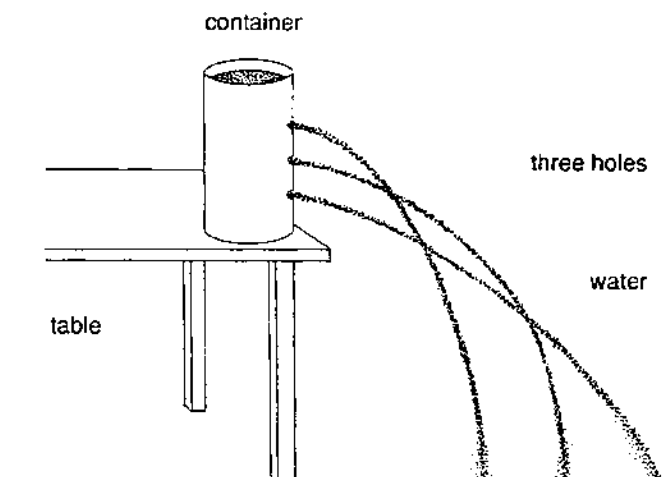

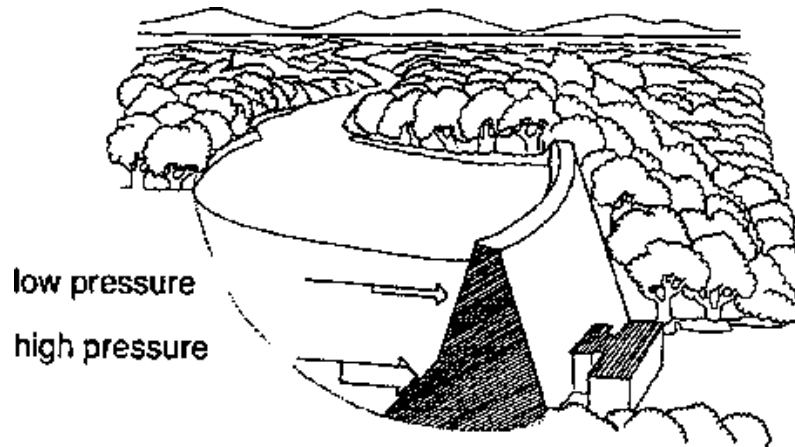

Observation:

see diagram

Analysis:

The pressure is exercised onto the sides as well as onto the bottom of the tin. It increases with the height of the water-column, because it's the weight of the water column above the level of the hole that determines the pressure. The more weight, the more pressure.

Practical Use:

When roller dams are built, the walls are reinforced towards the ground, in order to make them withstand the water pressure which increases with the height of the water-column.

Further thought:

Is there any difference concerning the water pressure acting against the bottom of the dam in the drawing, when you have a small volume of water held back or a very big one? The depth shall be the same in both cases.

8.4. VOLUME DETERMINATION OF A STONE

Main Goal:

This experiment demonstrates how to determine the volume of an uneven solid body on the basis of its liquid displacement. (it is necessary that the body is dipped completely into water.)

Information:

If a stone is placed into water, it displaces as much liquid as corresponds to its volume. (This is also true for other kinds of liquids, such as alcohol, oil and also for all gases.)

Materials and Apparatus:

stone
measuring cylinder (measuring flask)
water

Procedure:

The measuring cylinder is half filled with water. The water level is exactly read before and after inserting the stone.

Take care that no water splashes out of the cylinder when the stone is inserted.

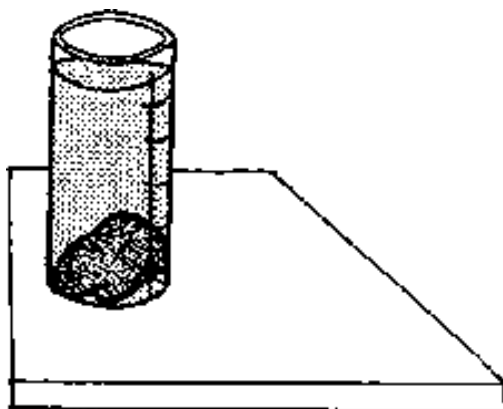
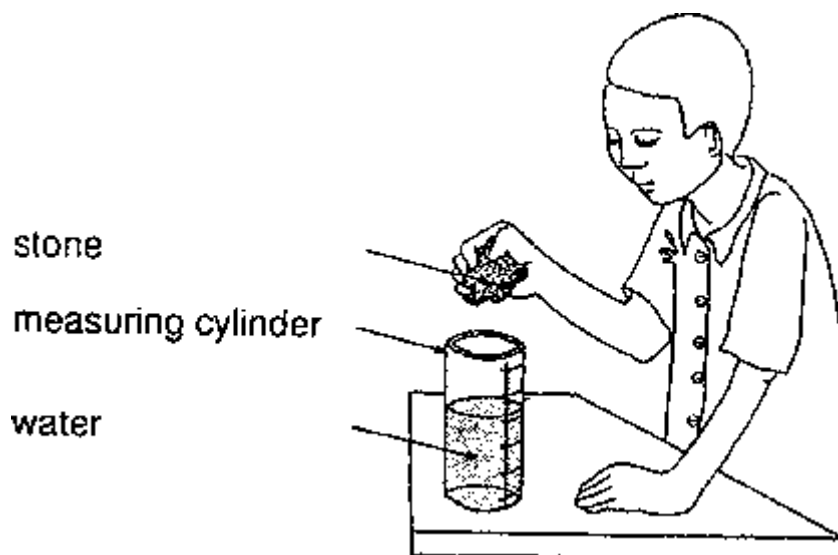

Then the stone is placed into the measuring cylinder.

Observation:

The stone sinks to the bottom, and the water level rises.

Analysis:

The stone displaces just as much water as it needs to settle in the cylinder.

The water that has been at the place where the stone is now situated had no other choice than to rise and to settle above the stone. Thus, the water level rises.

The amount of water (the volume) has not changed.

The difference between the two readings is a measure of the volume of the stone.

Further thought:

This method functions because the rock (or other solid bodies) doesn't change its volume when submerged in water.

What's about your body when you are submerged? Does the method work too?

8.5. A RAZOR BLADE FLOATS ON TOP OF WATER

Main Goal:

This experiment illustrates the phenomenon of surface tension.

Information:

At the surfaces of liquids are cohesive forces (Latin: attractive), whose forces are directed inward.

These forces tend to pull the surface molecules inward, which means, to reduce the size of the surface.

This special cohesion between like molecules is called "surface tension".

Materials and Apparatus:

vessel
razor blade (greased needle, paper clip)
water

Procedure:

a. One vessel is filled half way with water.

The razor blade is placed flat onto the water surface.

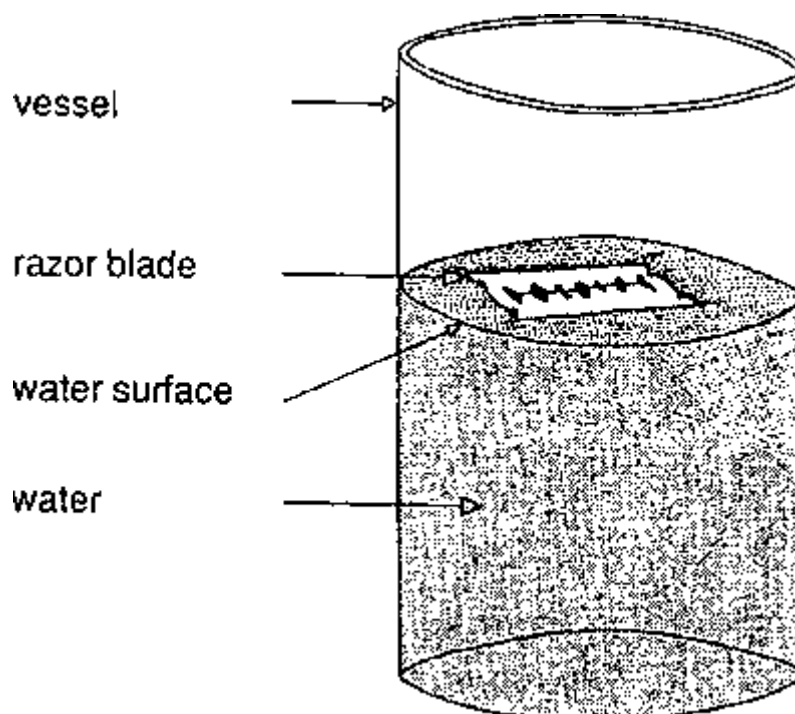

b. An attempt is made to place the razor blade on the water surface on one of the cutting edges.

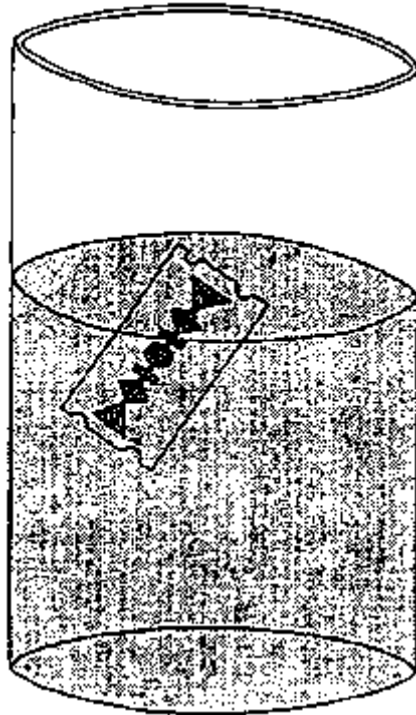

Observation:

- a. The razor blade floats on top of the water.
- b. The razor blade sinks.

Analysis:

The water surface can be imagined as one connected water skin. It is temporarily destroyed when the razor blade sinks in.

This characteristic of liquids is called “surface tension”.

Examples:

Insects which run over the water surface can be observed, e.g. the water-runner. Further examples of surface tension are rain drops or dew drops.

Further thought:

Why do rain drops have a spherical shape?

8.6. WATER HAS A SKIN

Main Goal:

This experiment demonstrates the phenomenon of surface tension.

(see experiment: A RAZOR BLADE FLOATS ON TOP OF WATER)

Materials and Apparatus:

waxed paper
pipette (drinking-straw)
water

Procedure:

With the help of a pipette, several small portions of water are dropped onto waxed paper.



waxed paper

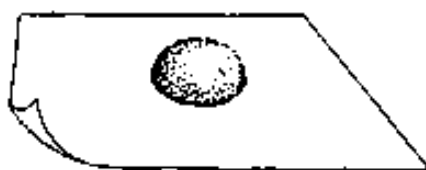

Observation:

Small drops are really spherical. If pushed together, bigger drops are formed that are more tear-shaped.

Analysis:

The high surface tension of water is responsible for the holding together of this “surface skin”.

The surface tension tends to form the smallest possible surface surrounding the volume of water. 1 sphere has the smallest possible surface.

Addition:

If some drops of soap solution or some small grains of a detergent are added to the “heap of water”, it dissolves at once. The surface tension of water is reduced.

Practical Meaning

The reduction of the surface tension of water is achieved with detergents to increase the wetting ability of dishes or clothing.

(see further experiments with detergents)

Further thought:

What additional effect makes bigger drops more tear-shaped?

8.7. THE PHENOMENON OF SURFACE TENSION

Main Goal:

These experiments use a soap solution to illustrate the surface tension.

Information:

(see experiment: A RAZOR BLADE FLOATS **ON** TOP OF WATER)

Materials and Apparatus:

concentrated soap-solution

a. clay pipe or a peashooter

b. a ring of wire

*a loop of thin yarn
needle*

Procedure:

a. Soap-bubbles are blown with a clay pipe.

The mouthpiece is then released and observed.

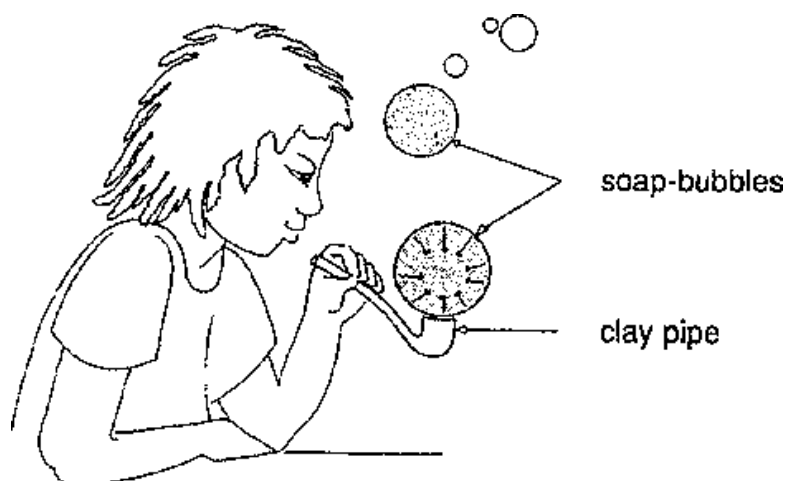

b. As demonstrated in the diagram below, a wetted loop of yarn is placed onto the soap skin. This skin is pricked in the centre of the yarn loop.

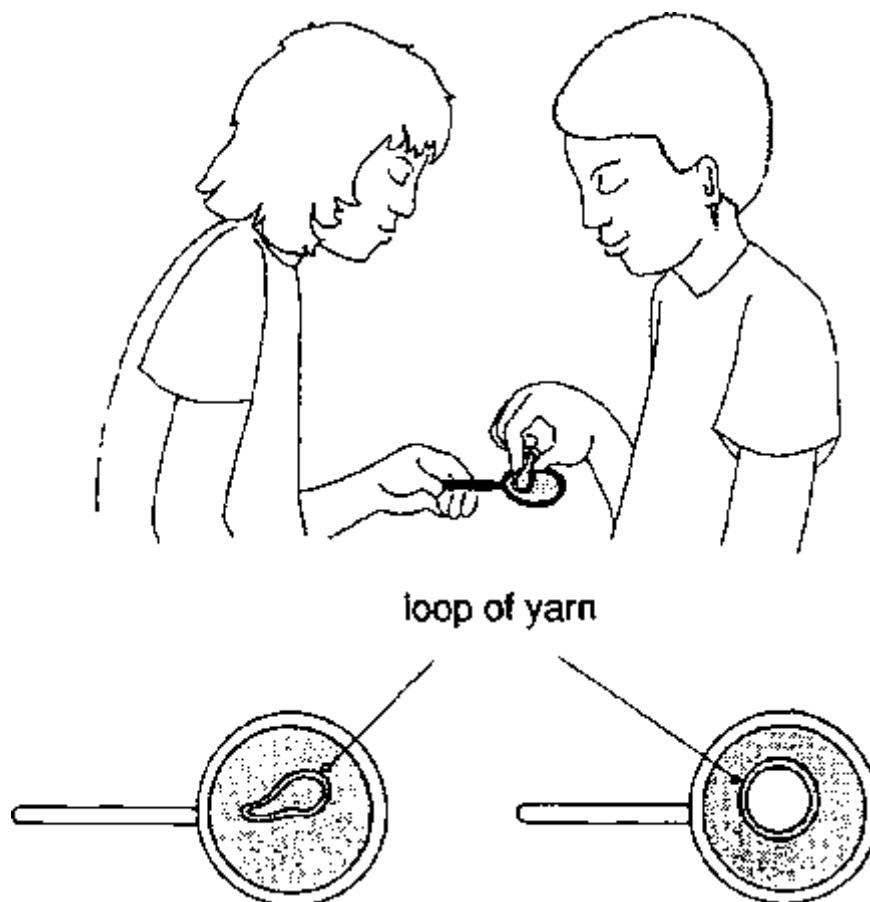

Observation:

- The soap-bubbles slowly become smaller.
- The loop of yarn is drawn apart.

Analysis:

a. Round soap-bubbles develop due to surface tension, which presses the air out of the soap-bubble, so that its surface size decreases. The surface tension tends to minimize the surface area.

b. The surface tension is responsible for the yarn loop being torn apart. The remaining soap skin has minimum size when the yarn has a circular shape.

The surface tension of different liquids varies.

Water has a very high surface tension, so that it is not possible to form a “water bubble” in analog to the “soap-bubble”.

Further thought:

The surface tension of hot water is smaller than that one of cold water. Why?

8.8. WATER ASCENDS IN SOIL

Main Goal:

This experiment illustrates the phenomenon of capillary action. (Latin: suction effect of very thin tubes)

Information:

Very thin tubes are called capillary tubes (capillary -Latin: hair-like). In these, water climbs up. The thinner the tube, the higher the water climbs. The cause is the surface tension (see further experiments on surface tension).

Water molecules are attracted to glass or other substances more than to each other. This effect is called adhesion. When a glass tube is dipped into water, the adhesion between glass and water causes a thin film of water to be drawn up over the surface of the tube. Surface tension causes this film to contract. The film on the inner surface continues to contract, raising water with it until the adhesive force is balanced by the weight of the water lifted (see drawings).

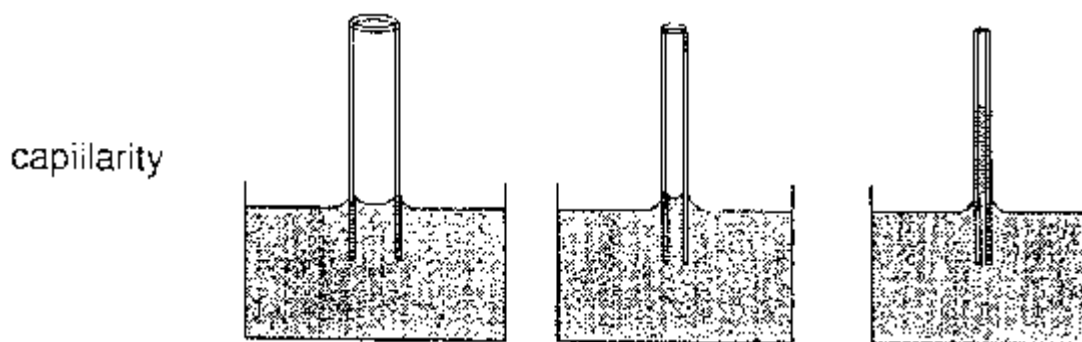

Materials:

*piece of white chalk
ink or coloured water
(transparent tubes of different diameter)*

Procedure:

The chalk is dipped 10 cm into the ink-solution.

After 10 minutes, the piece of chalk is broken into two, at the point to which the coloured solution has climbed.

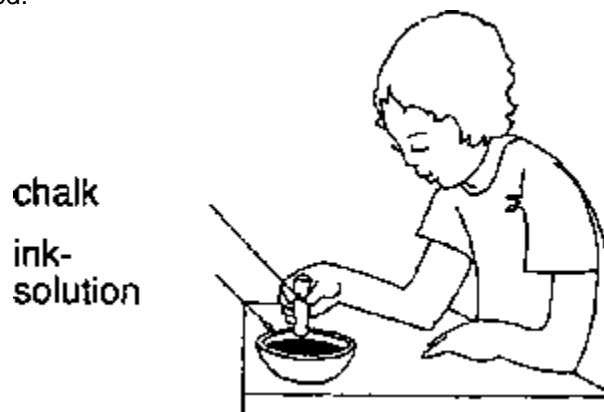

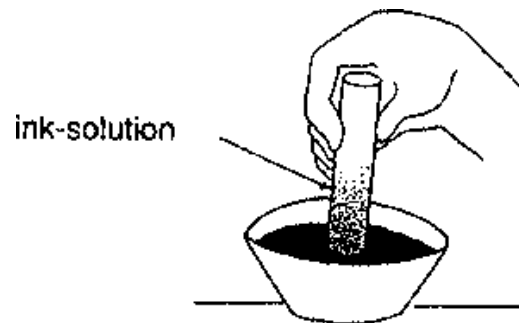

Observation:

The ink climbs up the piece of chalk.

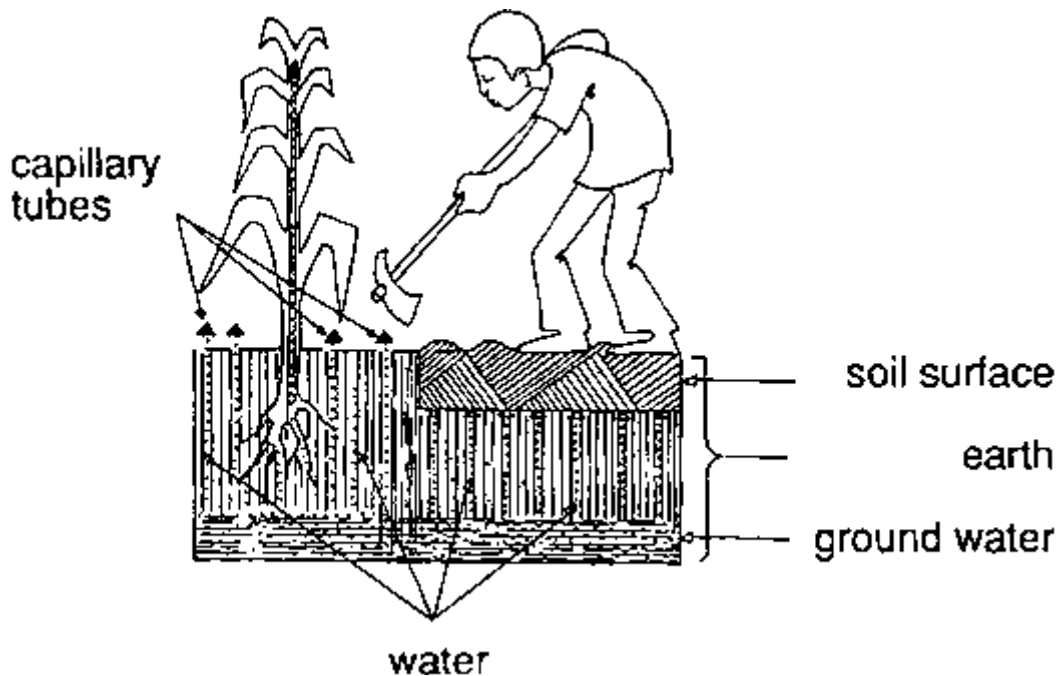

Analysis:

This observation is called “capillary action” or the suction effect of hair-like tubes.

Practical Meaning:

Ground water climbs up in soil because of capillary action. So the roots of plants are continually supported with water even in dry seasons. (Capillary tubes are formed when the soil sags and rainwater flows slowly in thin streams through the soil.)

Usually the water climbs up to the earth’s surface, where it evaporates. When farmers hoe the ground, they make the capillaries wider and the water does not go up. Thus, they hinder this process, as the capillary effect is reduced. Therefore, the water loss of the soil is reduced for some time. Furthermore, the soil surface is loosened and the area of surface is increased.

Further thought:

Why is oil soaked upward in a lamp wick when one end hang in oil?

8.9. DETERGENTS FACILITATE THE ABILITY OF PERFUSION

Main Goal:

These experiments illustrate the effects of water and a detergent solution on fabric cloth.

Information:

Soaps and detergents reduce the surface tension of water.

The process of perfusion, which is the absorption of a detergent solution (soap solution) by the fabric cloth, is facilitated.

Materials and Apparatus:

detergent solution (soap solution)
(1 g detergent in 100 ml of water)
water
2 wool threads
2 small rags
2 vessels

Procedure:

One vessel is half filled with water; the second is half filled with a detergent-solution.

A wool thread and a small rag are placed into each vessel.

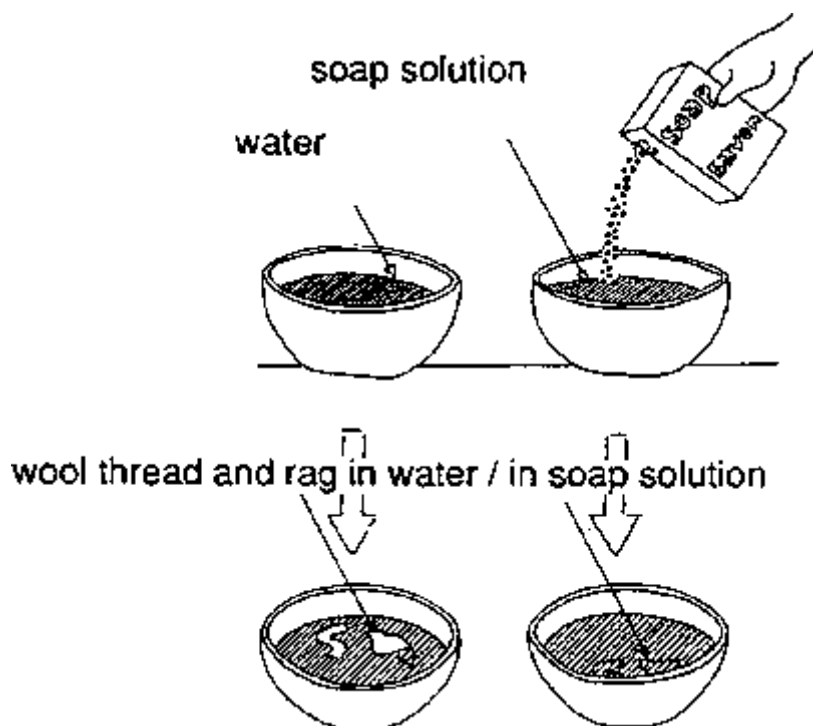

Observation:

The wool thread and rag sink relatively quickly into the detergent solution. The rag sinks much more slowly into pure water, whereas the wool thread hardly sinks or does not sink at all.

Analysis:

Compared to a detergent-solution, pure water soaks more slowly into similar fabric cloths.

Practical Use:

Soaps and modern detergents are used for the cleansing of laundry.

(see experiment: THE EFFECT OF DETERGENTS ON DIRT)

Further thought:

If soap reduces surface tension of water, why do we blow soap bubbles instead of water bubbles?

8.10. THE EFFECTS OF DETERGENTS ON DIRT

Main Goal:

This experiment illustrates that dirt is distributed in very small particles in a detergent solution.

Information:

The basic components of dirt are grease, soot, and proteins. Detergent molecules distribute soot and grease particles, in the washing solution so that they can be washed away.

Fruit and vegetable stains are destroyed by bleach. The experiments demonstrate the perfusion of soot and grease by detergents.

Materials and Apparatus:

a. 2 glass dishes (test tubes)

soot (activated carbon or wood charcoal)

b. 2 glass dishes (test tubes)

oil (salad oil, engine oil)

detergent solution

(about 1 teaspoon of detergent in a big vessel of water)

c. 2 funnels

2 paper filters

2 glass dishes

Procedure:

a. One glass dish is half filled with water; a second is half filled with detergent solution. Some soot (about one spatula tip) is added to each dish, vigorously shaken and then filtered.



b. One glass dish is half filled with water, a second is half filled with detergent solution. About 0.5 ml oil is added to each dish, and then the dishes are vigorously shaken.

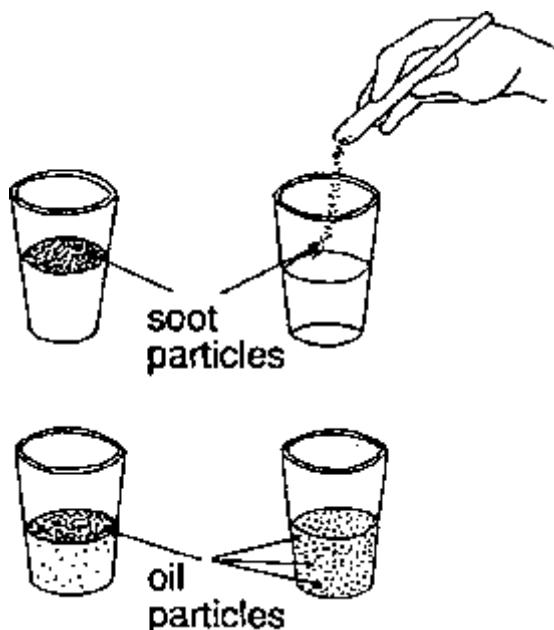

Observation:

a. The soot particles in the detergent solution are distributed, whereas those in water recollect on its surface. The soot particles in the detergent solution are hardly retained by the paper filters.

b. The oil in the detergent solution is distributed in very small particles, whereas it forms a layer on top of the water.

Analysis:

Detergents cause oil and soot to be well distributed in water. Oil drops and soot particles are distributed and thus kept floating.

Thus, the dirt particles are prevented from being deposited on the fabric cloth again. In the first case of the soot particles in a detergent solution, a suspension is formed. In the case of detergent solution and oil, a suspension is formed.

(emulsion: a mixture of two liquids; suspension: a mixture of a liquid and one solid, which can not solve in the liquid)

Practical Use:

Soaps and detergents are used to remove dirt from clothes, dishes, and the human body.

Further thought:

We say that some liquids "wet" a surface, whereas other don't do this. What's the difference? Where is it coming from?

9. MECHANICS

9.1. GEAR MECHANISM - A TRANSMISSION

TO SPEED UP

Main Goal:

The pupils become familiar with an important element of machines - the gear transmission.

Information:

In technology, cogwheels serve to transmit rotary motions.

The simplest kind of gear transmissions consists of a driving gear, an output gear, one crank, two spindles, and two bearings. A gear transmission transmits two unchanging rotary motions, motions into slowness, into speed, in opposed motions and motions into other revolving planes.

If there is a transmission to speed up, the bigger of the two cogwheels is the driving gear and the smaller one is the output gear.

Materials and Apparatus:

firm corrugated board
screws
wire
knife or pair of scissors
coloured pencil

Procedure:

Two cogwheels - one with 20 and the other with 40 cogs are made of the corrugated board. The screws serve as spindles and simultaneously as fastening devices on a sheet of corrugated board. A crank - made of wire - is fastened to the bigger cogwheel.

One cog of each gear is coloured, to determine the number of rotations.

The bigger cogwheel is driven by the smaller one.

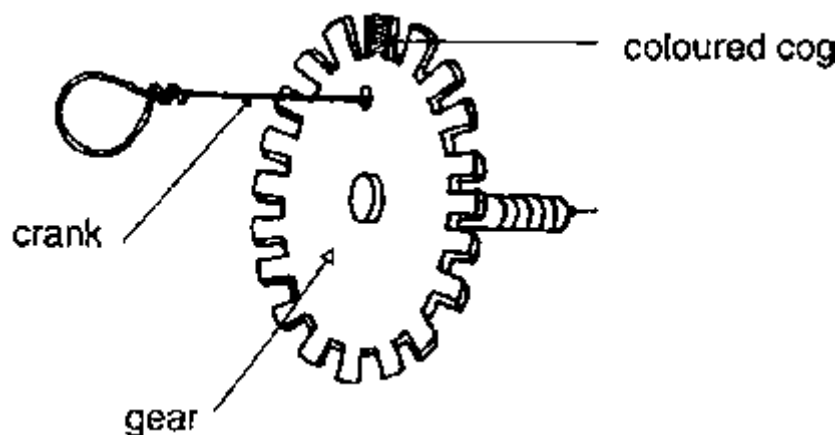

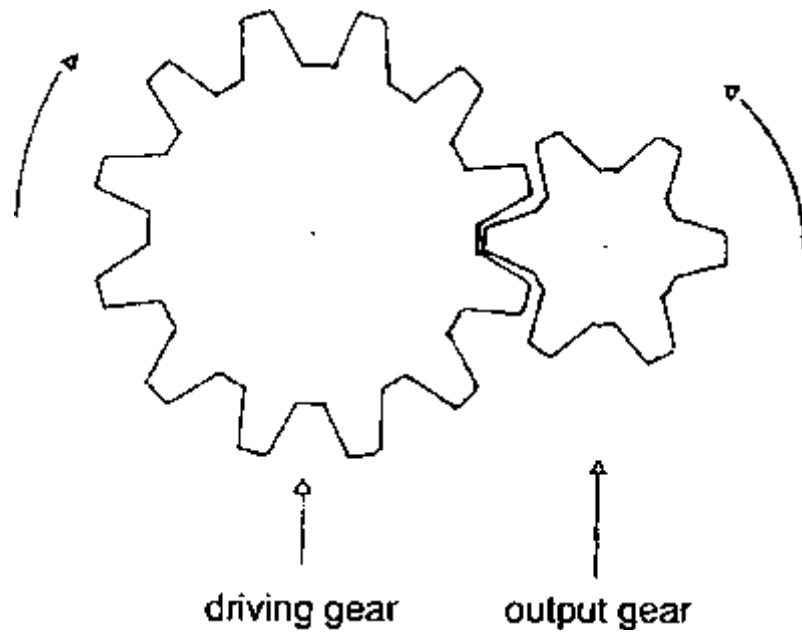

Observation:

Driving gear and output gear rotate in opposite directions. The output gear turns twice as fast as the driving gear.

Analysis:

If a rotary motion is transmitted from a bigger driving gear onto a smaller output gear, the number of rotations of the smaller cogwheel is greater.

The quotient of the number of rotations is called transmission. It is computed by the proportion between the two cogwheel radii or between the proportion of the cogs of the single gears.

$$u = r_1/r_2 = z_1/z_2$$

u: transmission
r: radius of a gear
z: number of cogs

Practical Use:

One of the numerous examples of such a transmission is the gear mechanism of a grinding machine. The grindstone (as working element) is connected over a spindle to a smaller output gear, which speeds up. With bicycles, the motion is transmitted over the chain.

9.2. GEAR MECHANISM - A TRANSMISSION TO SLOW DOWN

Main Goal:

By means of this experiment the pupils experience an important element of machines - the gear transmission.

This experiment demonstrates a transmission in order to slow down.

Materials and Apparatus:

corrugated board
screws
knife or pair of scissors
wire
coloured pencil

Procedure:

see "GEAR MECHANISM - TRANSMISSION TO SPEED UP"

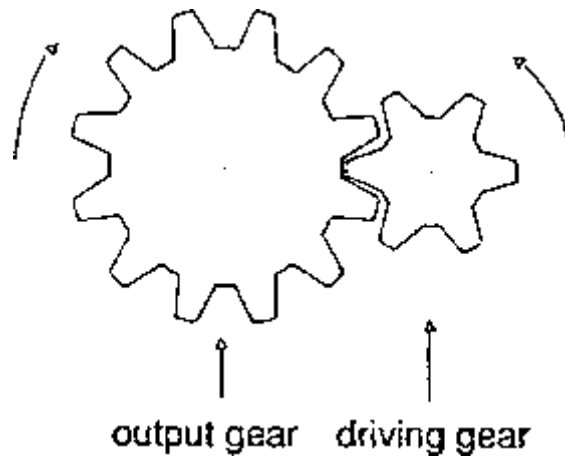

Observation:

Driving gear and output gear turn into the opposite directions. The driving gear turns double as fast as the output gear.

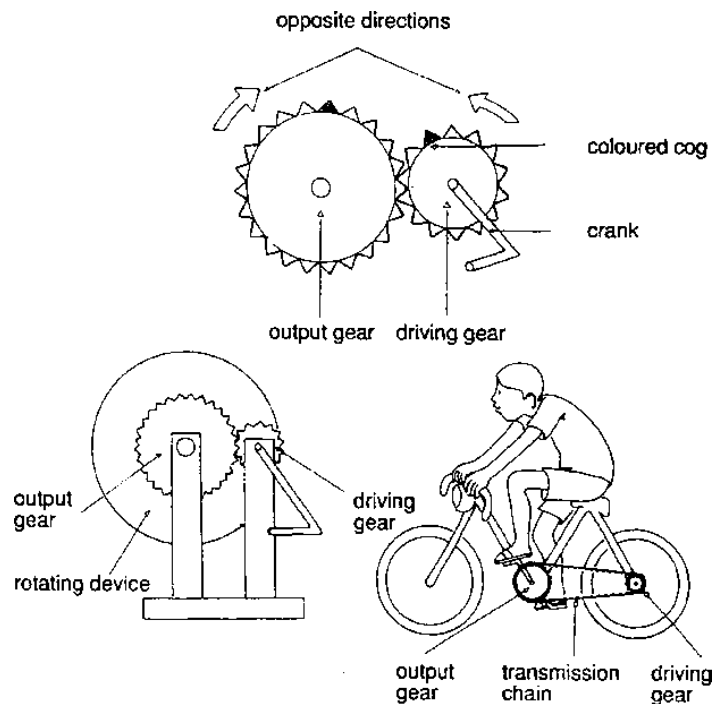

Analysis:

If a rotary motion is transmitted from a smaller driving gear onto a bigger output gear, the number of rotations of the bigger cogwheel is smaller. The quotient of the number of rotations is called transmission. It is computed by the proportion between the two cogwheel radii or by the proportion between the cogs of each gear.

$$u = r_1/r_2 = z_1/z_2$$

u: transmission
r: radius of a gear
z: number of cogs

Practical Use:

A vivid example of a transmission to slow down is the gear mechanism of a bread-slicing machine. The knife as working element is connected to a big output gear which undergoes a transmission into slowness by a smaller driving gear.

9.3. A SEESAW - A TWO-ARMED LEVER

Main Goal:

Pupils learn that a seesaw is a two-armed lever and flat in case of equilibrium. There is a special relationship between the length of a levers and the weights resting on them. For older pupils this experiment provides a mathematical basis to approach the law of the lever.

Information:

In physics, a lever is a bar, which can turn about one point (axis). This point is called the fulcrum. The fulcrum of a two-armed lever lies between the two attacking forces (see drawing 1). If a lever is in balance, the effects on left and right are equal. These effects are the product of the attacking force and the lever bar (distance between attacking force and the fulcrum). In drawing 1 the attacking forces F_1 and F_2 are the weights of the paper clips.

The law of lever says:

$$F_1 \times L_1 = F_2 \times L_2$$

If F_1 is considered the force that is to balance the load at the right hand side (F_2), then we have

$$\text{force} \times \text{force arm (left hand side)} = \text{load} \times \text{load arm (right hand side)}$$

Materials and Apparatus:

styrofoam (or soft wood)
thin iron nails
paper clips metal rings which are similarly heavy
(if existing: weights)
pencil, ruler
firm, thin wire
knife

distance between
attacking force
and the fulcrum

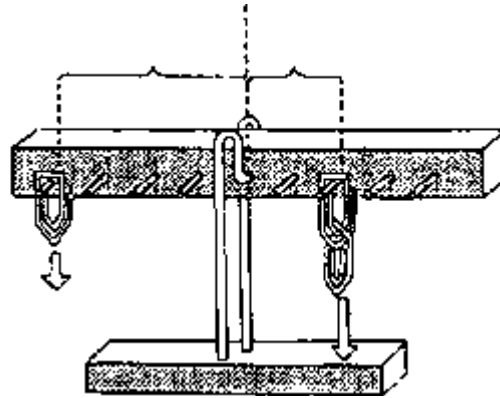

Procedure:

As shown in the drawing 1, a two-armed lever is constructed.

The axle bearing has to enclose the axis in such a way that the lever can freely rotate. However, it should not be too loose. It is favourable to pierce the styrofoam with the wire, which serves as axis and rack. Perhaps the wire should be heated before hand. The weights, e.g. paper clips or metal rings are fastened in different amounts at different distances from the fulcrum.

(This corresponds to the children on a seesaw.)

It is the pupils' task to balance the lever.

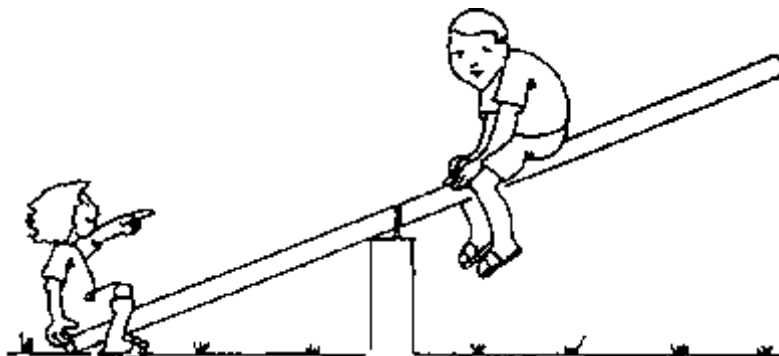

Observation:

The lever is balanced if the same number of paper clips is placed on each arm of the lever at the same distance from the fulcrum or, if different weights are fixed, the heavier weight must be closer to the fulcrum in order to balance the lever.

Analysis:

When the lever is balanced, the product of force and force arm equals the product of weight and weight arm.

That's to say: the product $F \times L$ of the left hand side must be equal to the product $F \times L$ of the right hand side.

Practical Use:

Examples of two-armed levers include: beam scales, scissors, pliers, and railway-signals.

Further thought:

What must be done in the situation of drawing 2 when the seesaw is to be balanced?
There are two possibilities.

9.4. MODEL OF A SIMPLE CABLE WINCH

Main Goal:

Younger pupils learn that loads can be moved more easily with the help of a cable winch. Older pupils trace the cable winch back to a two-armed lever.

Information:

With the help of a cable winch, loads can be lifted vertically, or pulled closer horizontally more efficiently, i.e. with less effort.

Simple cable winches consist of a cable drum, the cable, and the friction drive. The friction drive can be moved by hand as well as by a motor.

(see experiment: A SEESAW - A TWO-ARMED LEVER)

Materials and Apparatus:

stone as the load
rope
tin (with 2 holes) filled with sand, (see diagram)
pierced cork-stopper
stable wire

Procedure:

The experiment is set up as shown in the diagram below. The stone is lifted once with the help of the cable winch, and another time without it.

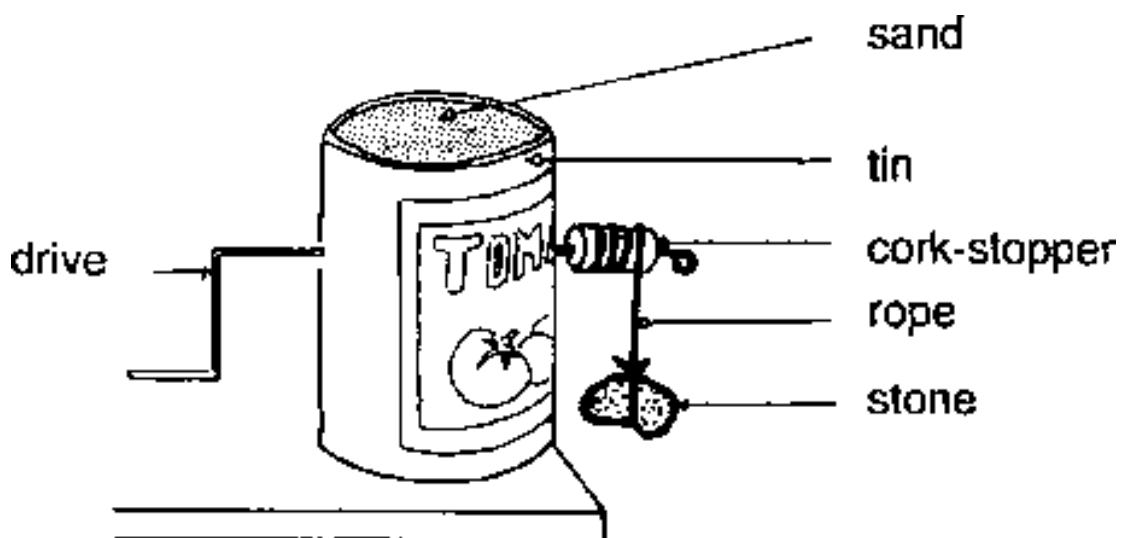

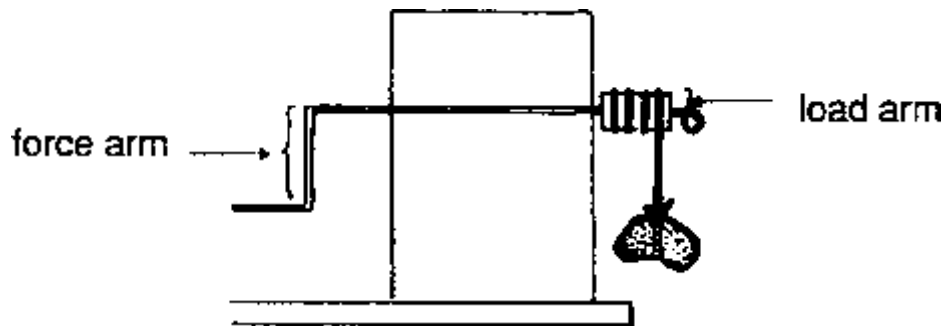

Observation:

The stone can be lifted more easily with the cable winch.

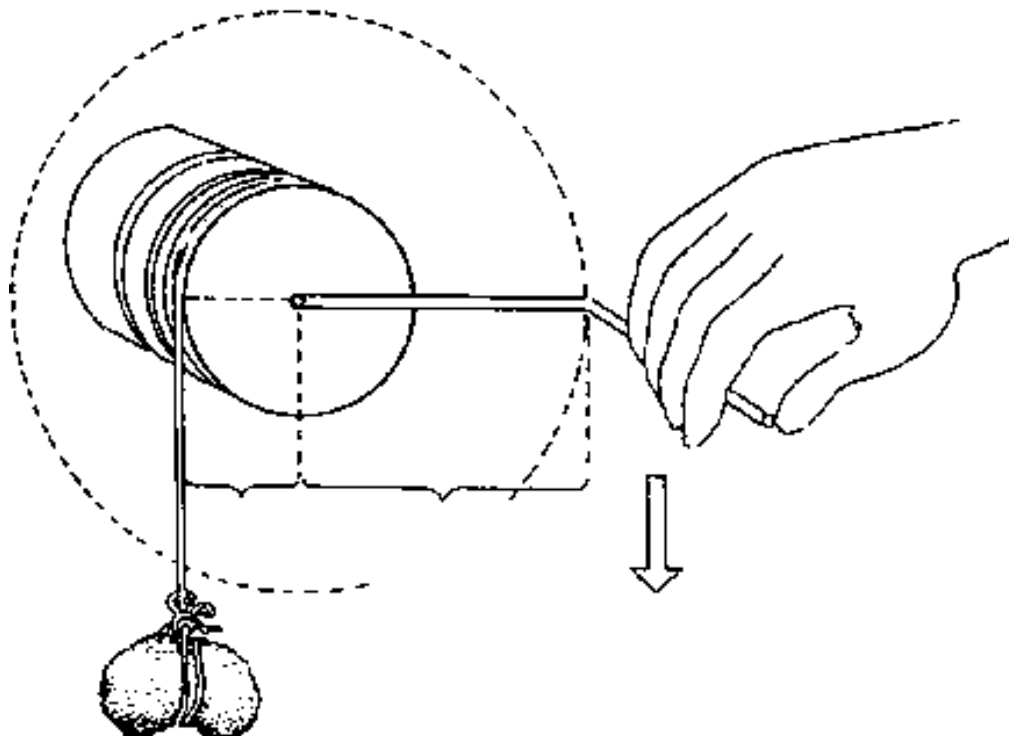

Analysis:

The winch presents a two-armed lever. When a load is lifted, force is saved, because the force arm is longer than the load arm. Thus the required force is smaller than the load (weight of the stone).

Practical Use:

Uses for winches: water cranes, pit-head frames, lifting device at wheels, etc.

Further thought:

We save force with cable winches or levers.
Do we get this for granted or do we have somehow to pay for?

9.5. INERTIA

Main Goal:

The experiment illustrates well-known observations, from which the law of inertia can be derived.

Information:

Inertia describes the property of all bodies to counteract a change in motion. That's what experience teaches us.

The heavier a body is, the more inertia it exerts.

It is more difficult to put a heavy body from a position of rest into motion than a light one.

More force is needed to stop a heavy body than to stop a lighter body.

Materials and Apparatus:

glass, tin etc. with smooth rims

coin

firm paper (cardboard)

Procedure:

The experiment is prepared as shown in the diagram below.

The paper is pulled away horizontally as quickly as possible.

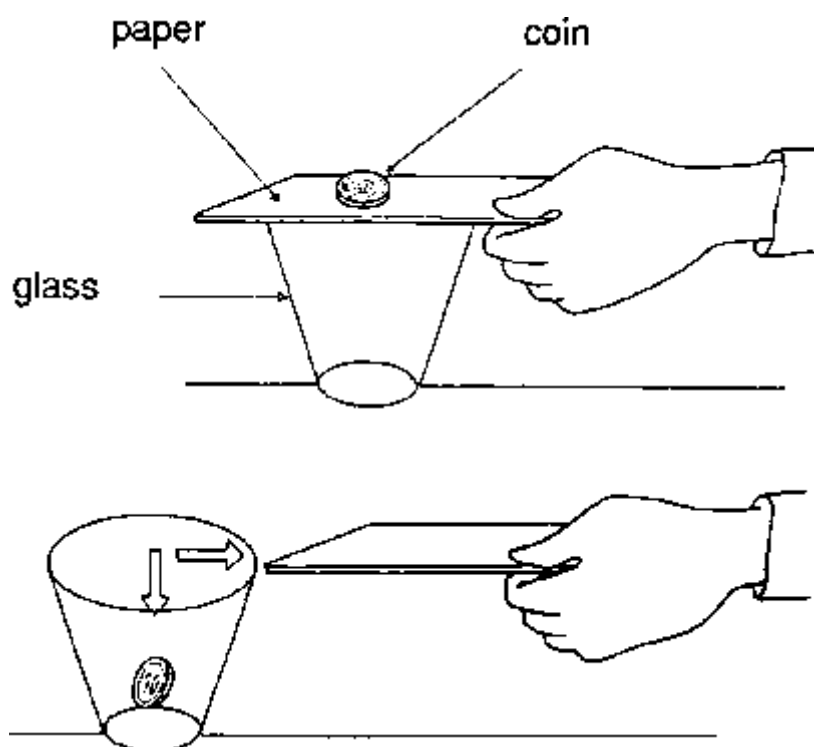

Observation:

The coin falls into the glass. It does not join the movement of the paper.

Analysis:

If stationary bodies try to remain in a position of rest, then, once in motion, they should also try to remain in motion. They should resist to change their state of actual motion. This is, in fact, the case.

Practical Use:

these principles can be observed with vehicles - cars, buses, trains, aeroplanes. If they suddenly stop, the passengers fall forward. If these vehicles start quickly, the passengers are pressed into their seats.

It is very dangerous to jump on or off a moving train, as our body hardly can balance the sudden change in motion.

Illusionists take advantage of the law of inertia, when they pull a table cloth off a set table as quickly as a flash of lightning. With a little everybody can do this too.

Further thought:

When one pulls slowly, the coin joins the movement of the paper. Why?

9.6. FRICTION

Main Goal:

These experiments demonstrate the principles of adhesive friction, sliding friction and rolling friction.

Information:

1. Friction is the result of mutual contact of irregularities in the surface of sliding objects. Three types of friction are distinguishable:

With **adhesive friction**, the force of friction is strongest. It decreases from **sliding friction** to **rolling friction**.

The strength of the frictional force depends on the surfaces of the bodies which rub against each other and on the weight of the upper body.

2. Adhesive friction causes two bodies to stick together.

Sliding friction counteracts the act of gliding.

Rolling friction is created when one body unrolls over another one.

The force of friction can be measured with a dynamometer.

Materials and Apparatus:

*2 brushes or brooms
marbles or peas
sand*

Procedure:

a. As shown in the diagram, the two brushes are placed on top of each other.

- b. The upper brush is moved to the right side.
- c. The marbles are rolled over a smooth and a sandy (rough) ground. Their initial speed should be nearly the same.



Observation:

- a. The bristles grip one another.
- b. The bristles of the upper brush are twisted to the left and those of the lower brush are twisted to the right side.
- c. The marbles roll further on the smooth ground than on the rough ground.

Analysis:

Observation (a) is called adhesive friction.

The irregularities or unevennesses of the two surfaces grip one another.

Observation (b) is called 'gliding friction'.

The unevennesses of the two bodies grip each other less strongly than with the adhesive friction.

Observation (c) is called 'rolling friction'.

Here, the unevennesses can grip each other to an even lesser extent than in sliding friction.

The strength of the respective frictional force basically depends on the surfaces of the two bodies, which is made clear in experiment c.

Practical Use:

For reduction of frictional forces, very smooth surfaces are used in technology. In addition, lubricants, e.g. oil and graphite, are used. Frictional forces should be minimized at those machine parts which move. However, often frictional forces are necessary. Tires need a certain depth of tread patterns, so that the car does not skid on a wet road.

The brakes should not be wet or oily, because this would greatly reduce the braking action (friction).

A nail or a screw stays in a wall or in wood because of frictional forces.

Further thought:

When we walk, has this also to do with friction?

9.7. A HEAVER - A ONE-ARMED LEVER

Main Goal:

With a one-armed lever, it can be demonstrated that a weight can be lifted more easily, the longer the force arm of the lever.

Information:

In physics, a lever is a bar, which can turn about one point (axis). This point is called the fulcrum.

The fulcrum of a one-armed lever lies at its end.

Load arm and force arm of a one-armed lever are resting on the top of one another. Thus, the two forces attack the same side of the lever.

The lever principle is:

$$\text{force} \times \text{force arm} = \text{load} \times \text{load arm}$$

Materials and Apparatus:

one heavy stone or a heavy object as load
one stable wood lath or iron rod

Procedure:

The stone is lifted with the wooden lath as shown in fig. a).

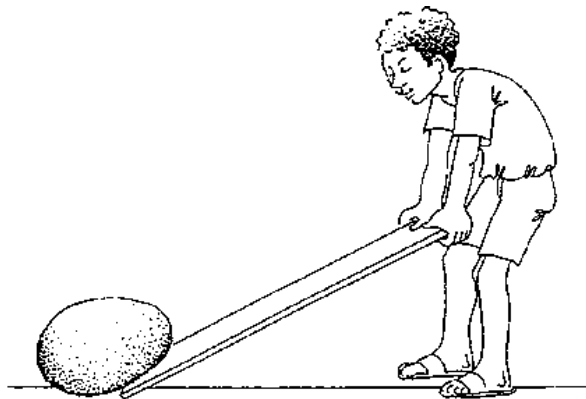

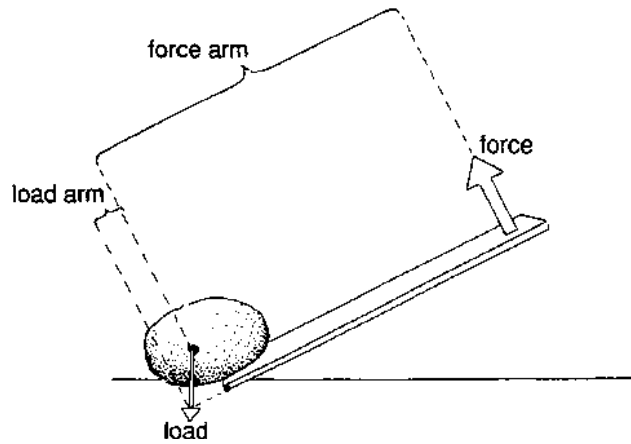

Observation:

The longer the lever, the greater the distance between the fulcrum and the end of the heaver, and the less force is needed to lift the stone.

Analysis:

If the lever is in a state of balance, the product of load (weight of the stone) and load arm equals the product of force and force arm.

(A dynanometer is needed to check this principle. It measures the force held against the load.)

Practical Use:

Examples for one-armed levers include:
a wheel-barrow and a nutcracker.

Further thought:

If we are rowing a boat, do we apply the law of levers?

10. ELECTRICITY

10.0. THE SCIENCE OF ELECTRICITY

Before we look in detail at the following experiments, here are some suggestions relating to the necessary materials and apparatus.

As the equipment used is always very similar, it is practical to build up one basic board and to put together basic equipment.

N. B.

The experiments performed with batteries, can also be performed with a transformer.

(Batteries pollute the environment and are expensive)

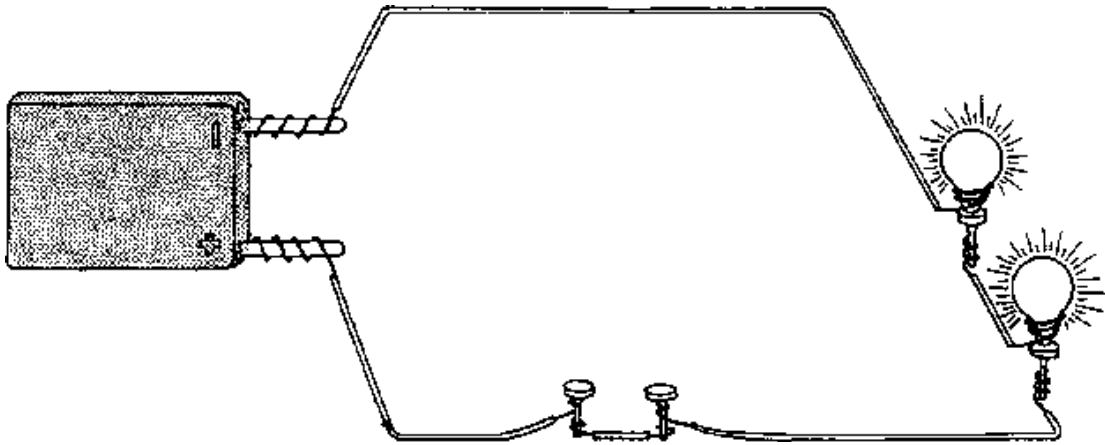

SUGGESTIONS FOR “SCIENCE OF ELECTRICITY”

a. MATERIALS

- | | | |
|-------------------|---|--|
| batteries | : | flat and round batteries |
| small light bulbs | : | e.g. from flashlights |
| metal sheet | : | thin, made of copper, aluminium, or iron |
| wire | : | single core, length as required |
| clothes peg | : | made of wood or plastic |

drawing-pin, paper clips, different kinds of iron nail,

screws rubber bands (broad)

knife, pair of scissors, hammer, screw-driver, pair of pliers.

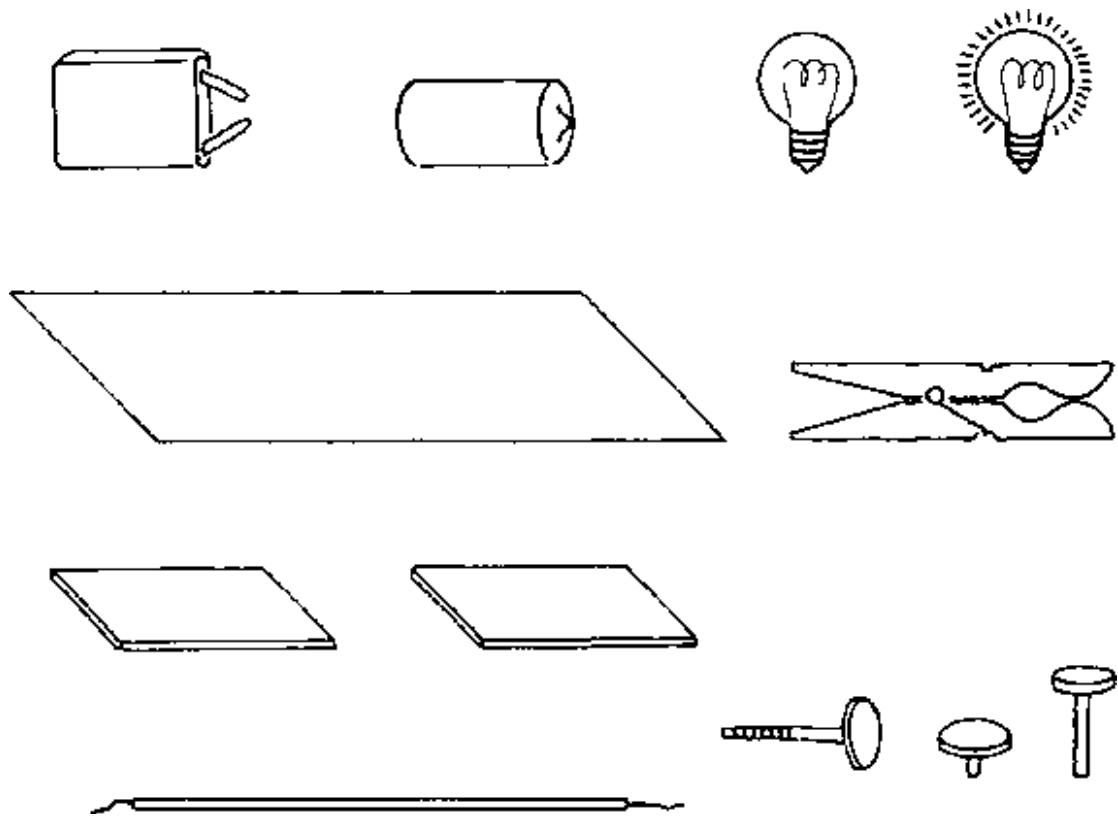

b) Suggestions for the base-plate

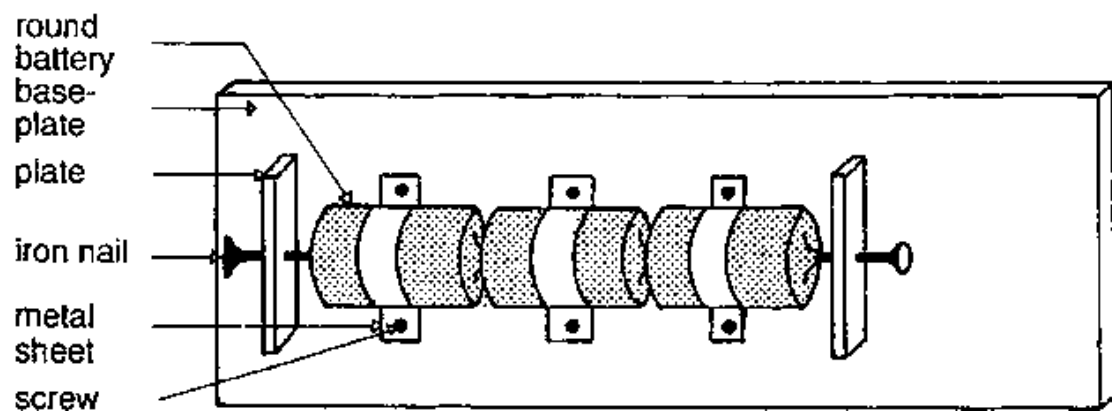
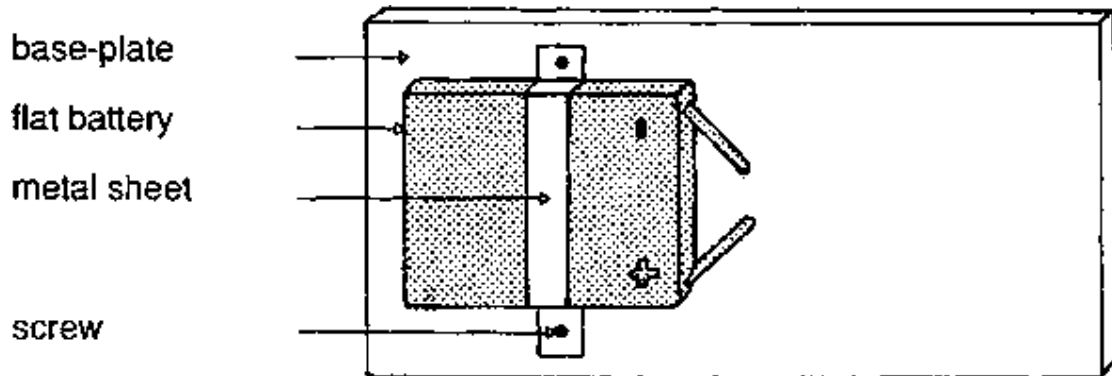

c) Suggestions for the sockets

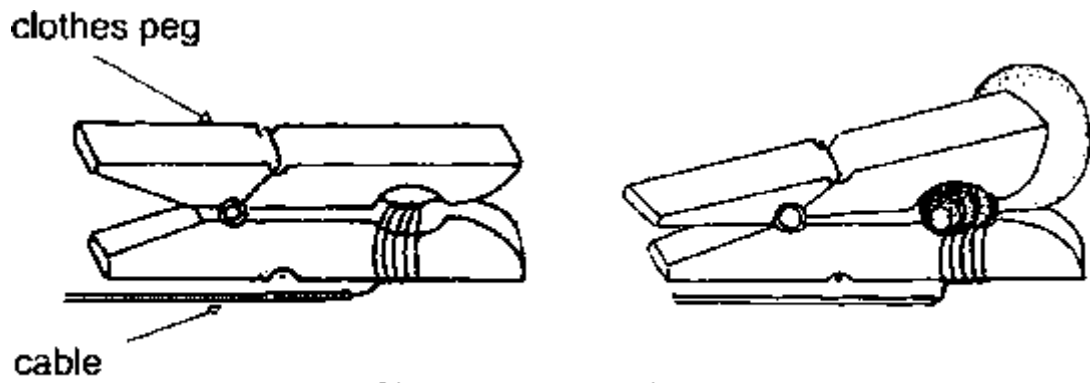
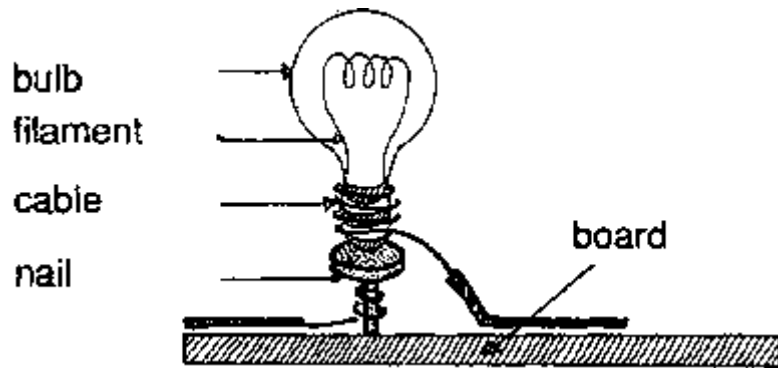

Clothes peg used as clamp

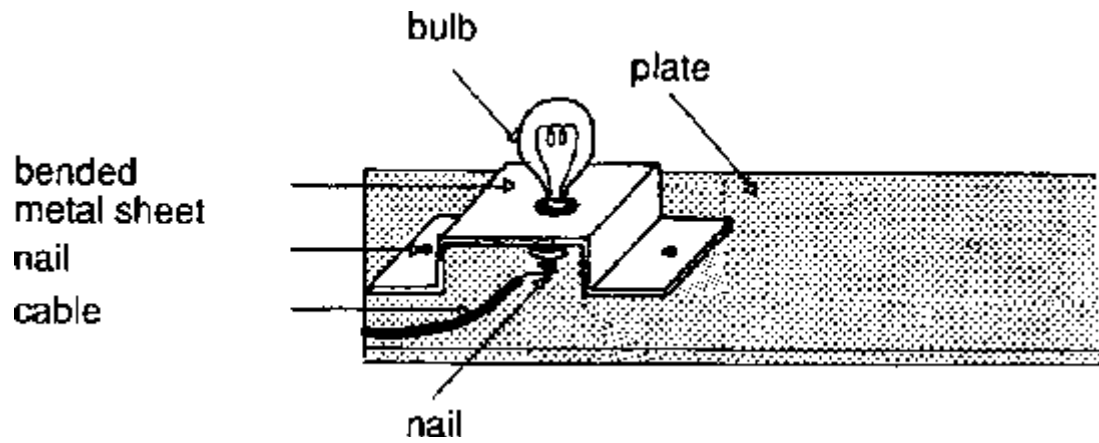

d) Suggestions for the switches

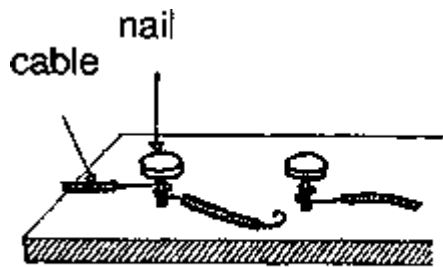

simple switch: off



simple switch: on

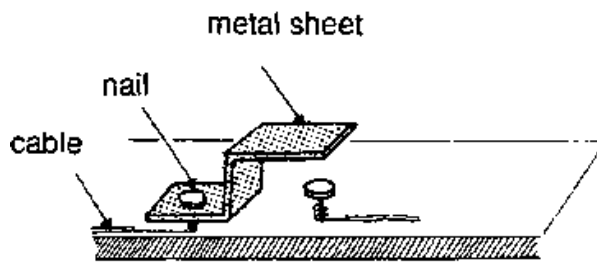

press-switch: off

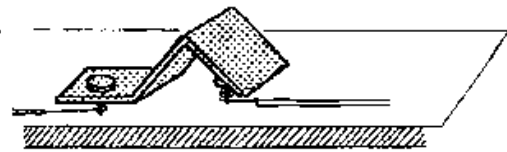

on

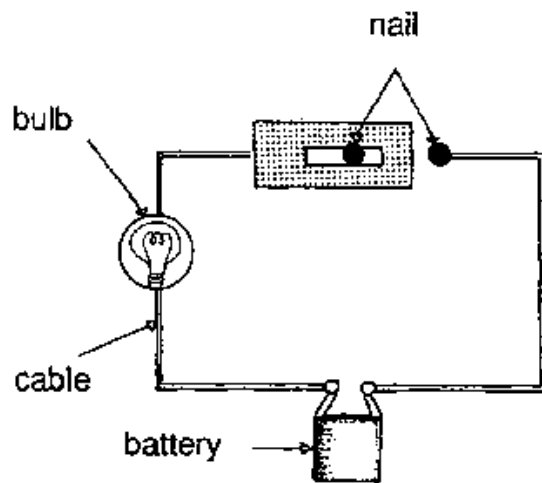

slide-switch: off

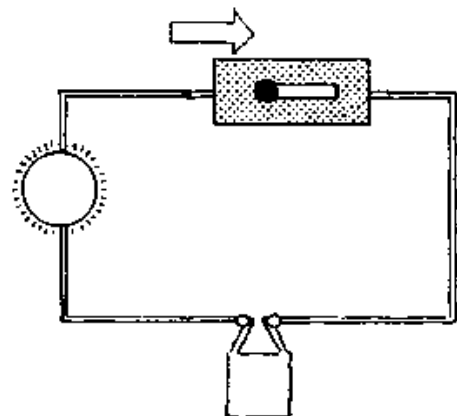

on

10.1. A JET OF WATER IS DEFLECTED

Main Goal:

The following experiment demonstrates static electricity, which can be found when a non-conductor is charged due to friction.

Information:

Various non-conductors, e.g. rubber, glass, plastic, can be charged electrically by rubbing them with a woollen leather or nylon cloths.

Friction causes an electron surplus or deficiency, depending on the material, (The material, used to rub the non-conductor takes on the opposite electric charge.)

This specific charge is retained for a short period, so that the influence - electrical attraction or repulsion - may be illustrated.

The experiments can be performed best in very dry air.

Materials and Apparatus:

*2 pieces of plastic sheeting, plastic bags, wool cloth
plastic comb, ball-point pen...
woollen cloth
jet or water from a water-pipe or a tin
2 balloons*

Procedure:

a. The sheeting or bags are rubbed vigorously with a woollen cloth and then brought close together.

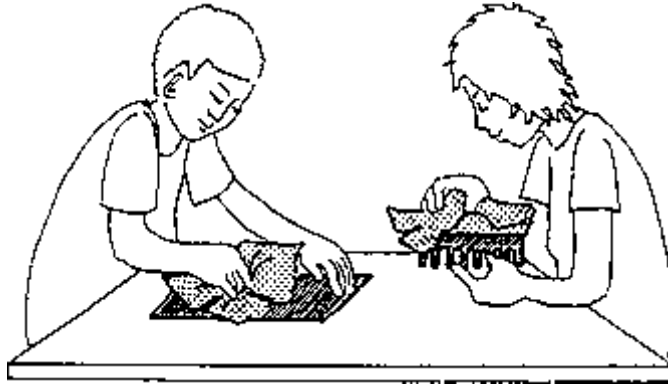

b. One piece of sheeting or bag is charged by rubbing vigorously. A finger is then held very close to it.

c. The comb is rubbed vigorously with a woollen cloth and then brought close to a thin jet of water.

d. Inflate two balloons, rub them at your woolen pullover and try to get hot balloons close together.

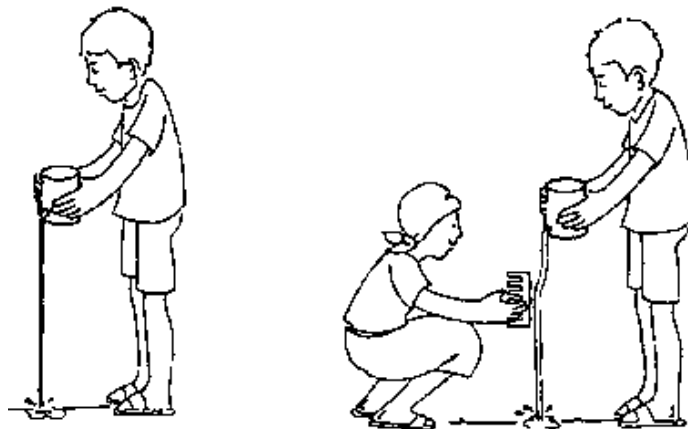

Observation:

- a. The sheeting or bags repel each other. They do not touch.
- b. A crackle can be heard. In a darkened room sparks can be seen.
- c. The jet of water is attracted by the comb.
- d. You feel a repelling force.

Analysis:

- a. The sheeting/bags carry the same type of charge and repel each other.**
- b. Friction of non-conductors produce high voltage electricity. It breaks down immediately when a spark leaps and is not dangerous.**
- c. The plastic comb and the jet of water have the opposite electric charges and attract each other.**
- d. The same type of charge on the balloons cause them to repel each other.**

Further thought:

You can put a charged balloon on a wall. It sticks to it. What is the reason?

10.2. A SIMPLE CIRCUIT

Main Goal:

This experiment teaches pupils how a simple circuit is built and how it works.

Information:

When electric charge moves in a circuit, it does work. The rate at which this work is done is called power. Electric power (in watts W) is equal to the product of current (in amperes A) and voltage (in volts V) across the circuit.

Thus power = current × voltage,
in units watts = amperes × volts.

A simple circuit can be demonstrated with the help of a battery and a small light bulb.

Materials and Apparatus:

battery (about 4.5 V)
small light bulb (about 2.2 V)

Procedure:

The circuit is closed as illustrated in the diagram below.

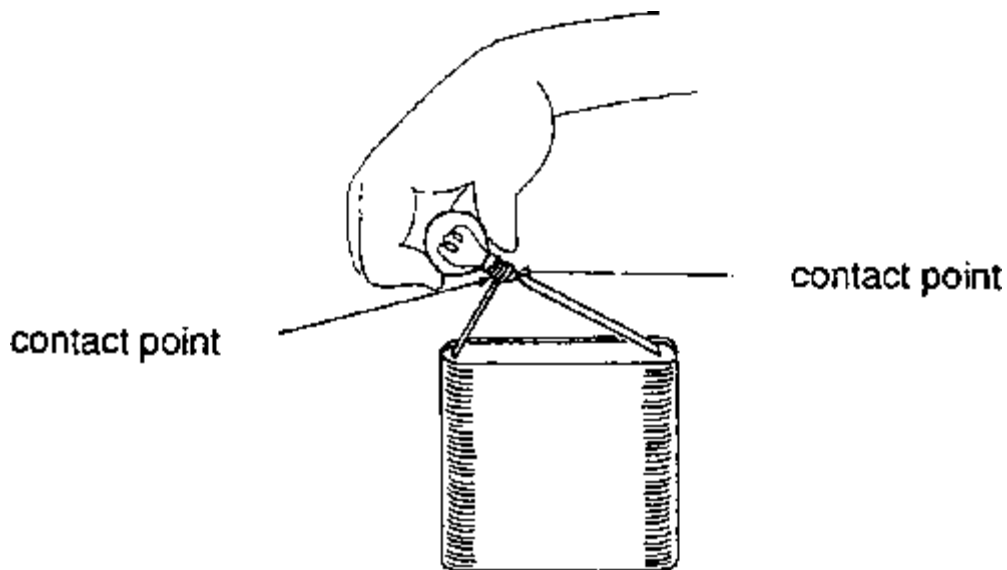

Observation:

The lamp lights up if each of the two contact points are connected with one of the poles.

Analysis:

A simple circuit consists of a battery, that provides the voltage, and of a power consumer, in this case a small light bulb. Electric current only flows if the circuit is closed. When the small bulb lights up, the circuit is closed.

Practical Use:

see "Main Goal".

Further thought:

The electric current that flows in the circuit consists of electrons. Where do they originate?

10.3. THE PRINCIPLE OF A FLASHLIGHT

Main Goal:

This experiment demonstrates that switches can close and interrupt circuits.

Information:

Switches connect contacts. Those which are known from the household and engineering include slide switches, rotary switches and button switches.

Materials and Apparatus:

see suggestions "SCIENCE OF ELECTRICITY"

Procedure:

A circuit is set up as shown in the following diagram. The circuit is closed or interrupted with the switch.

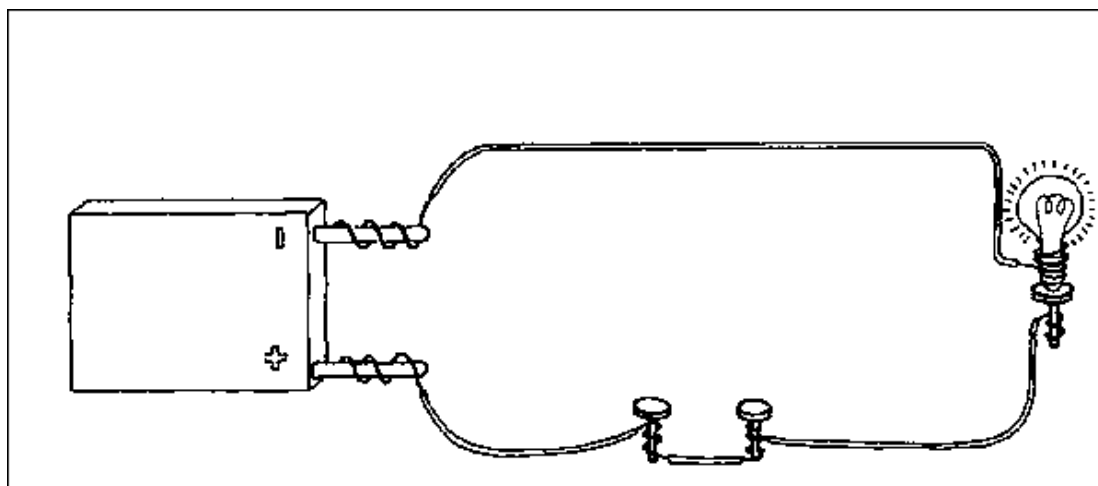
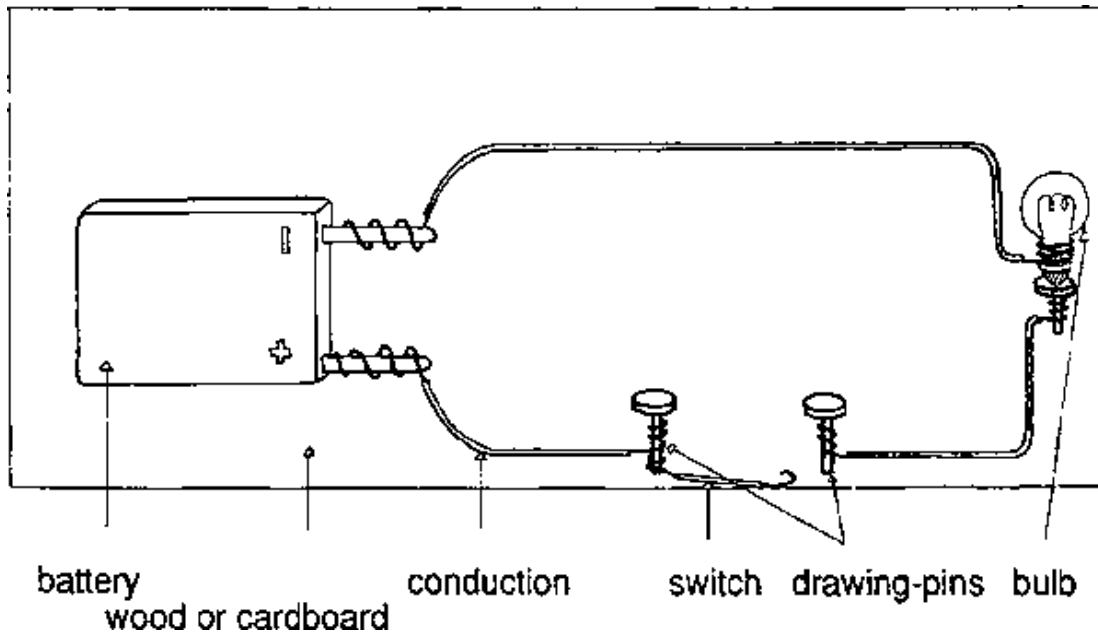

Observation:

The bulb lights up if the switch is connected with the two drawing-pins. The bulb lights off when the switch is 'opened'.

Analysis:

Switches can close or interrupt circuits.

They connect or interrupt two conducting parts of a circuit.

There is no current when the switch is off.

Wood or cardboard seem not to be able to conduct electric current.

Practical Use:

see "Main Goal".

Further thought:

Is there any voltage in the circuit even when the switch is off?

Is any current possible without voltage?

10.4. CONDUCTOR AND NON-CONDUCTOR

Main Goal:

The pupils learn about the classification of materials as good conductors, not so good conductors, and non-conductors.

Information:

Metals conduct an electric current very good. Non-metals may be moderate conductors (like ordinary water or wet wood) or bad or very bad conductors (like glass, hard rubber or quartz).

The conductivity is dependant on free electrons.

The flow of current can be equated with the flow of electrons.

(The word "electricity" comes from the Greek word "elektrum" meaning amber. Static electricity was first discovered with amber.)

Materials and Apparatus:

see suggestions - "SCIENCE OF ELECTRICITY".

See the following chart and select a few materials to test.

Procedure:

A circuit is set up as shown in the following diagram.

The materials to be tested are connected up between the two iron nails.

A material conducts electricity when the bulb lights up.

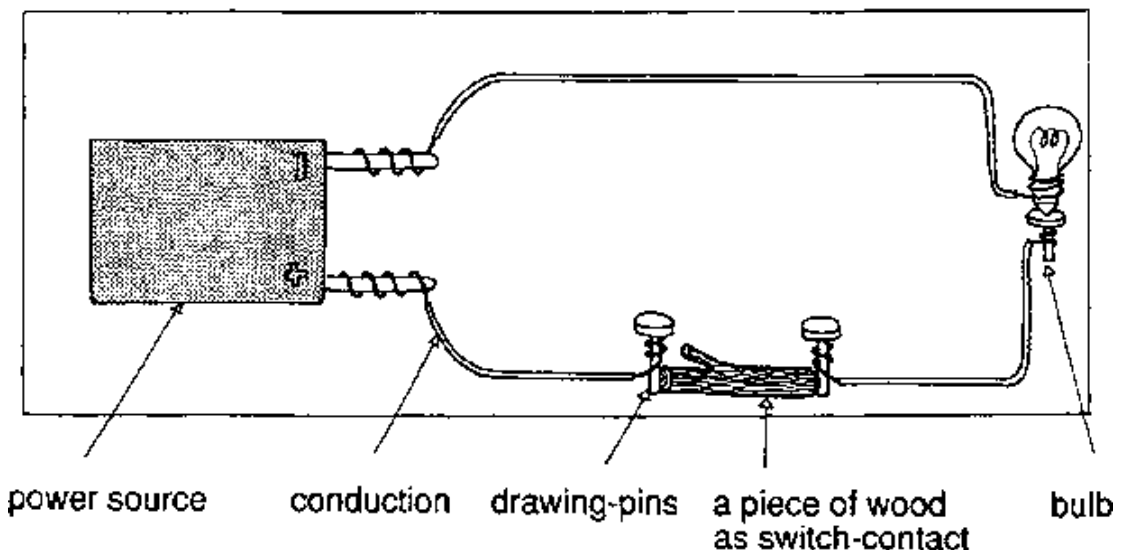

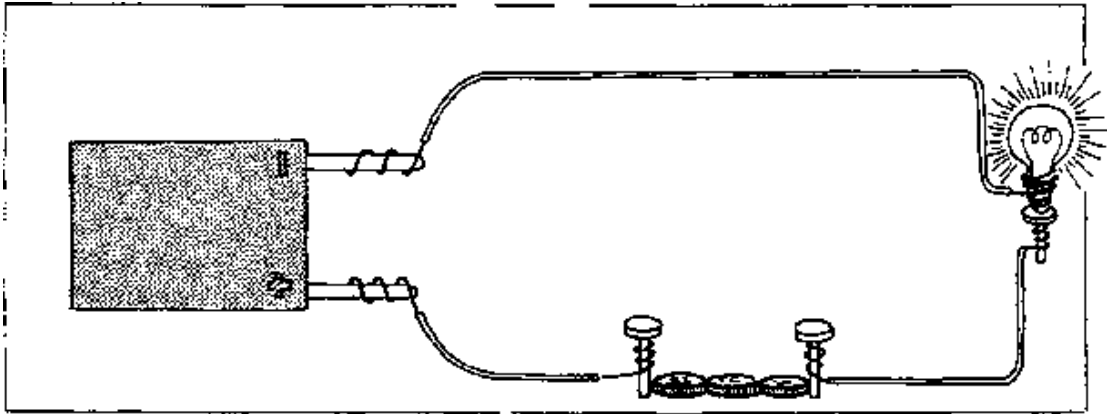

Observation:	material	conducts current	does not conduct current	conducts a little
	wood		-	
	glass		-	
	yarn		-	
	rubber		-	
	paper		-	
	plastic		-	
	coal	+		
	paper clip	+		
	coin	+		
	nail	+		
	cigarette paper (metal foil)	+		
	water			0
	wet wood			0

Analysis:

It depends on the material, how good or bad current is conducted.

Practical Use:

Materials which conduct current are insulated with materials which are very bad conductors. Thus, a voltage drop, short circuit, and electro-cution are prevented.

Further thought:

Sometimes not good conduction is required, but good non-conduction. So, what kind of material is used as isolators?

10.5. SERIES CONNECTION

Main Goal:

This example teaches younger pupils the principles of a series connection, in which several consumers are connected up one after the other. The observations are not analysed in detail. Older pupils learn Ohm's law and the meaning of partial resistors.

Information:

Electric power consumers are 'consumers' because they convert electric power into heat power or light power. The property that enables 'consumers' to such conversion is called electric resistance. Circuit elements with appreciable resistance are called resistors. Bulbs are such resistors.

If several bulbs - resistors - are connected in series, they scarcely shine if at all.

This is due to the fact that the strength of the current, which is equally large at each partial resistor, drops. To calculate the current, Ohm's law is used.

Materials and Apparatus:

see suggestion "SCIENCE OF ELECTRICITY"

Procedure:

The circuit is set up as shown in the following diagram.

- a. One, then two, then three small bulbs, etc., are connected in series.

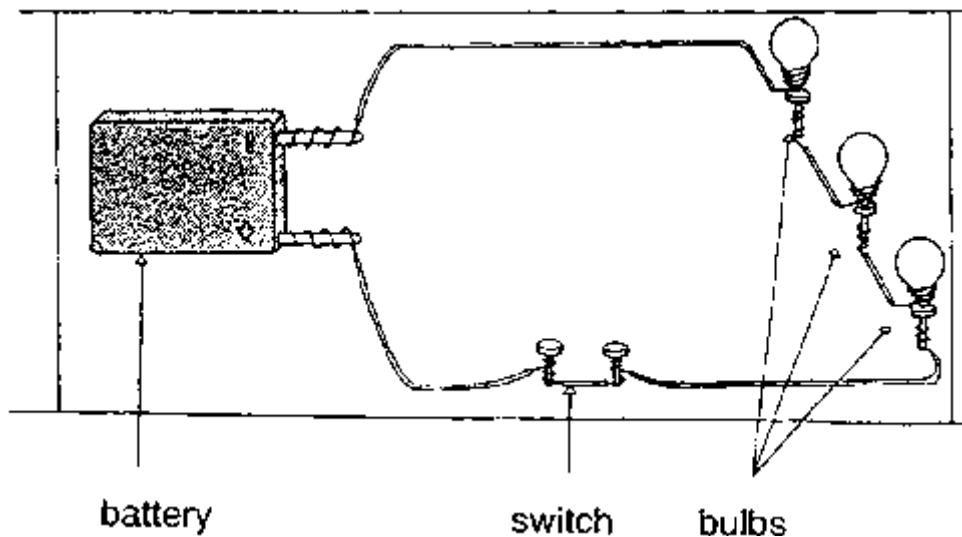

- b. When the switch is closed one of the small bulbs are unscrewed then another and so on.

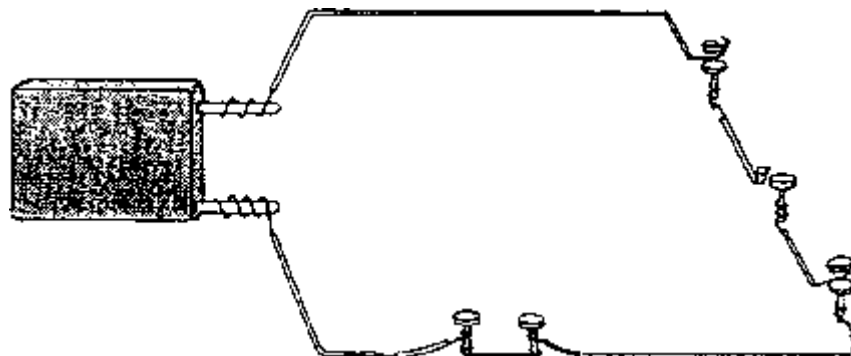

Observation:

- a. The bulbs shine less brightly after every additional connection, until they finally do not shine at all.
- b. If one bulb is unscrewed, all bulbs go out.

Analysis:

- a. The strength of the current sinks gradually, so that it is finally not strong enough to make the bulbs light up.**
- b. The circuit is interrupted if one bulb is unscrewed.**

This means: the bigger the resistance, the smaller the current.

Practical Use:

see "Main Goal"

Further thought:

But what will happen in case the current is not strong enough anymore to make the bulbs light up, when we take a battery that delivers higher voltage?

10.6. PARALLEL CONNECTION

Main Goal:

This example teaches younger pupils the principle of parallel connection. The observations made are not analysed in detail.

Older pupils learn Ohm's law in combination with Kirchhoff's law.

Information:

If two bulbs - resistors - are connected in parallel circuits, they shine with equal intensity. This is due to the fact that two or more separate circuits exist.

To calculate the current at each resistor, Ohm's law is used.

Materials and Apparatus:

See suggestions - "SCIENCE OF ELECTRICITY"

Procedure:

A circuit is set up as shown in the following diagram.

- a. The small bulbs are connected in parallel circuits.
- b. When the switch is closed, the small bulbs are alternatingly unscrewed.

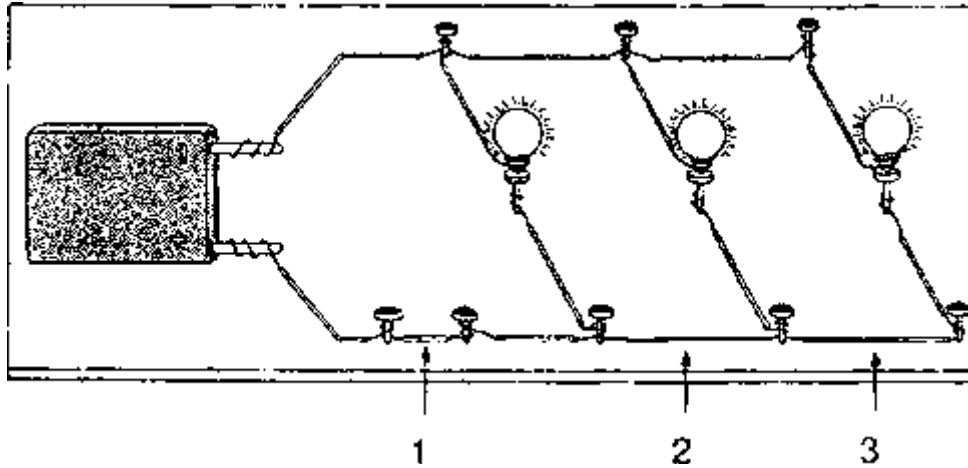

Observation:

- a. The small bulbs light up with equal intensity.
- b. If one bulb is unscrewed, the others still burn.

Analysis:

Every parallel connection forms an independent circuit. The current through each bulb is only dependant on the output of the battery (i.e. the voltage) and the resistance of the bulb.

Practical Use:

In all households, outlets and switches are connected in parallel circuits. The electricity meter is placed in the non-branching part of the electric power supply system. The complete amount of electric current used, runs through the meter (1st law of Kirchhoff).

Because the voltage is standard (220 V or 110 V), power (= voltage × current) times the time for which the power is used in the household is what we have to pay for:

$$\text{power} \times \text{time} = \text{electrical energy}$$

The electrical energy is measured in wattseconds (ws) or kilowatthours (kwh).

Further thought:

What happens when the circuit is interrupted, e.g. at the point 1, or 2, or 3 in the drawing?

10.7. ELECTRICAL CURRENT PRODUCES HEAT

Main Goal:

This experiment demonstrates that electrical energy can be transformed into heat.

Information:

If electricity flows through a conductor, the conductor is heated. Depending on the material of which the conductor is made on the voltage, and on the current, the conductor is heated more or less. In heating instruments a special resistance wire - "constantan wire" - is used.

It does not fuse at high temperatures and has a high resistance, which is hardly dependant on temperature.

Materials and Apparatus:

*See suggestions - "SCIENCE OF ELECTRICITY"
resistance wire (constantan wire)
2 iron nails
15 V battery (or several batteries connected in series)
styrofoam (wood)*

Procedure:

A circuit is set up as shown in the following diagram.

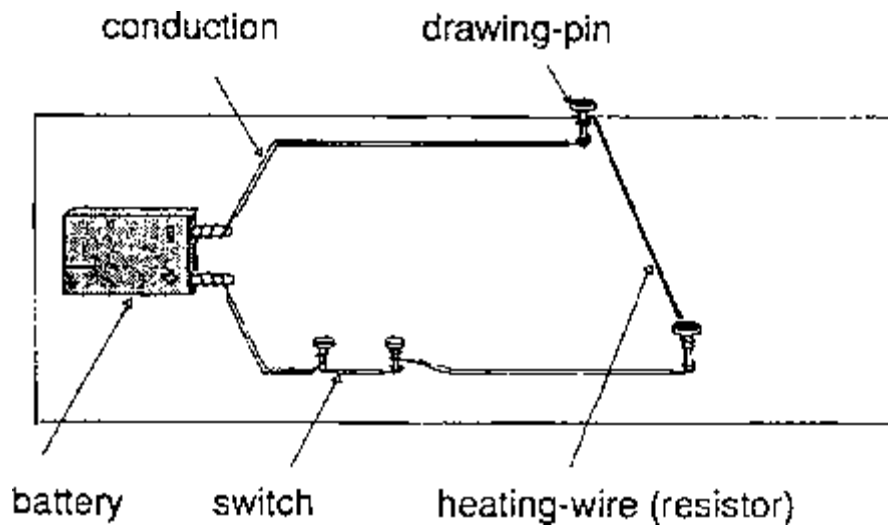

When the heating wire is red glowing, it can cut the styrofoam or singe the wood.

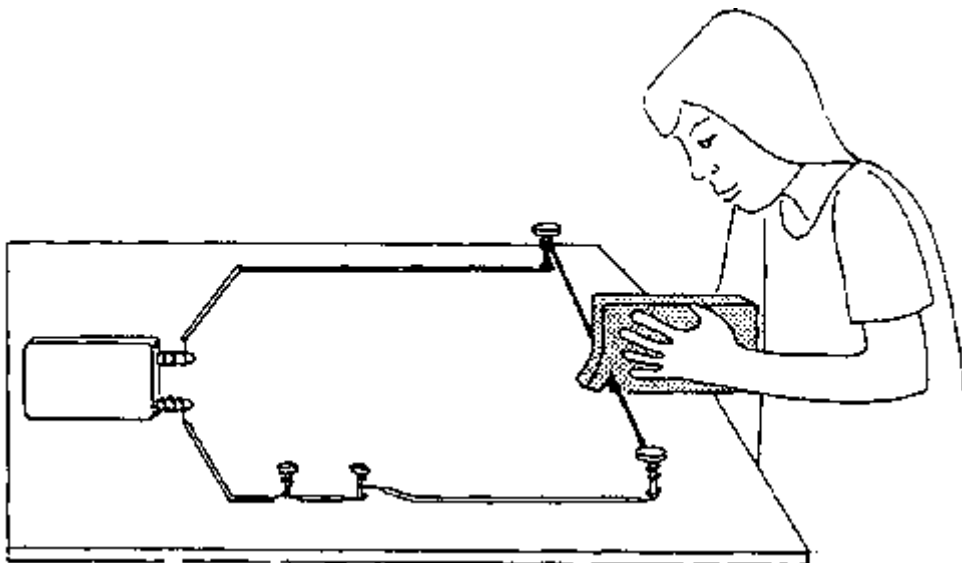

Observation:

The heating wire becomes hot, so that it cuts the styrofoam or singes the wood.

Analysis:

Electrical current produces heat in resistors or power consumers.

Practical Use:

In the household, a lot of electrical appliances are used which produce heat, e.g.:

electric heater
hot-plate
immersion heater

Further thought:

Sometimes you hear someone say that the electric current in a circuit is used up. Is it really the current, i.e. the flow of electrons, that's 'used up', or what?

10.8. THE PRINCIPLE OF AN ELECTROMAGNET

Main Goal:

The experiment demonstrates the magnetic effect of an electrical current.

Information:

A current-carrying coil has the same effect as a permanent magnet. If a non-magnetic iron core is placed in the centre of the coil, it too becomes a magnet. The magnetism is intensified by increasing the number of times the coil is wound round the core.

Materials and Apparatus:

see suggestions - "SCIENCE OF ELECTRICITY"

iron nail

light pieces of iron

Procedure:

A switch circuit is set up as shown in the following diagram.

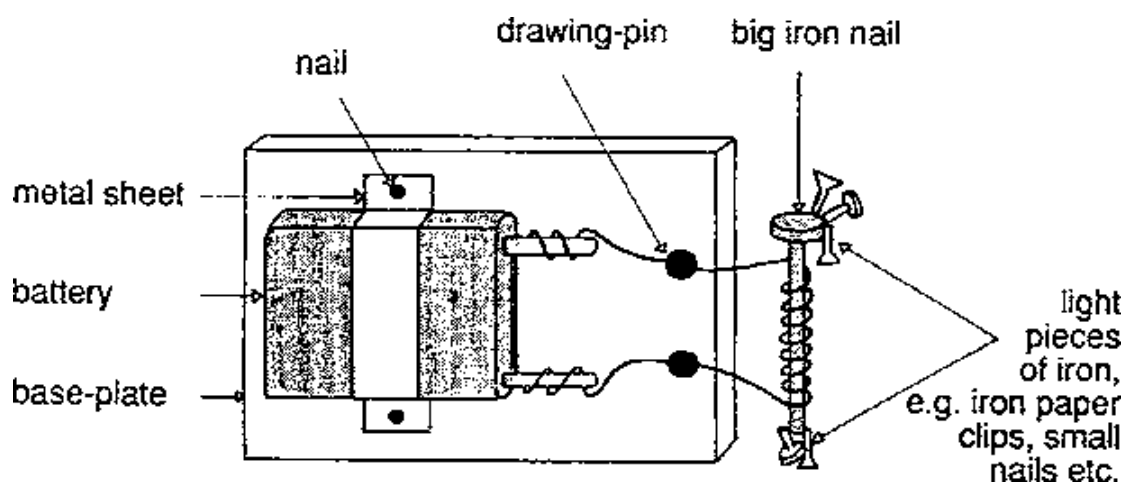

Some experiments which can be performed:

- Try to attract the lighter pieces of iron with the iron nail.
- The pieces of iron can be attracted with the current-carrying coil.
- The big iron core (nail) is placed in the coil.
- The number of times the coil is wound round the nail is increased or decreased.

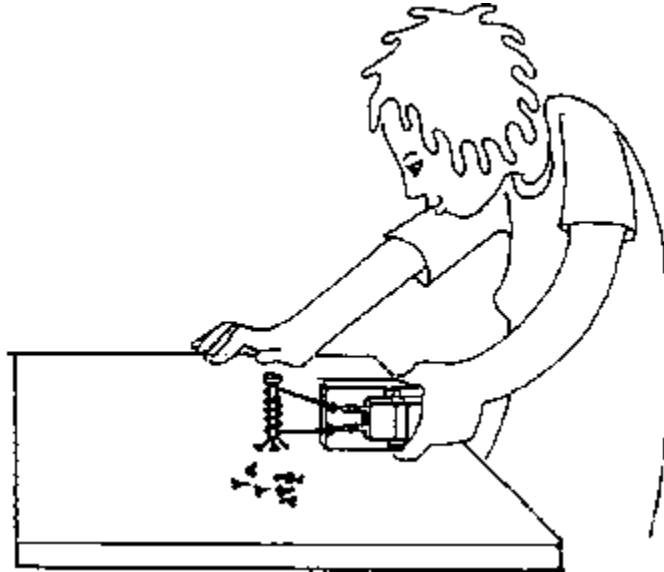

Observation:

- The non-magnetic iron nail does not attract the iron pieces.
- The current-carrying coil attracts the lighter pieces.
- The attraction is increased with the addition of the iron core.
- The attraction is increased or decreased.
- Small current means little attraction, large current strong attraction.

Analysis:

A coil with an iron core is called an electromagnet. Its attractive power is greater, the higher the number of coil windings and the larger the current. An electromagnet loses almost all its effect when switched off. No current, no magnetic effect.

Practical Use:

With the help of an electromagnet, iron pieces are transported and sifted out from other metals.

Electromagnets are also used in many electrical appliances. They either close a circuit, as a bell, or interrupt the circuit, as in an electric fuse.

Further thought:

A permanent magnet (e.g. a horse shoe magnet) has a magnetic North-Pole and a magnetic South-Pole. What's about poles of an electro magnet?

10.9. THE PRINCIPLE OF A BIMETALLIC STRIP

Main Goal:

The experiment demonstrates the behaviour of a bimetallic strip when heated.

Information:

Bimetals consist - as the name suggests - of two strips of different metals, which are either rivetted or soldered together. When heated, a bimetallic strip bends due to the different expansion properties of the different metals.

Materials and Apparatus:

*1 copper and 1 iron strip and 1 aluminium strip and
1 iron strip (of the same strength)
hammer
pair of pliers
alcohol burner, gas burner or a candle*

Procedure:

Two metallic strips are joined by twisting their ends as shown below.

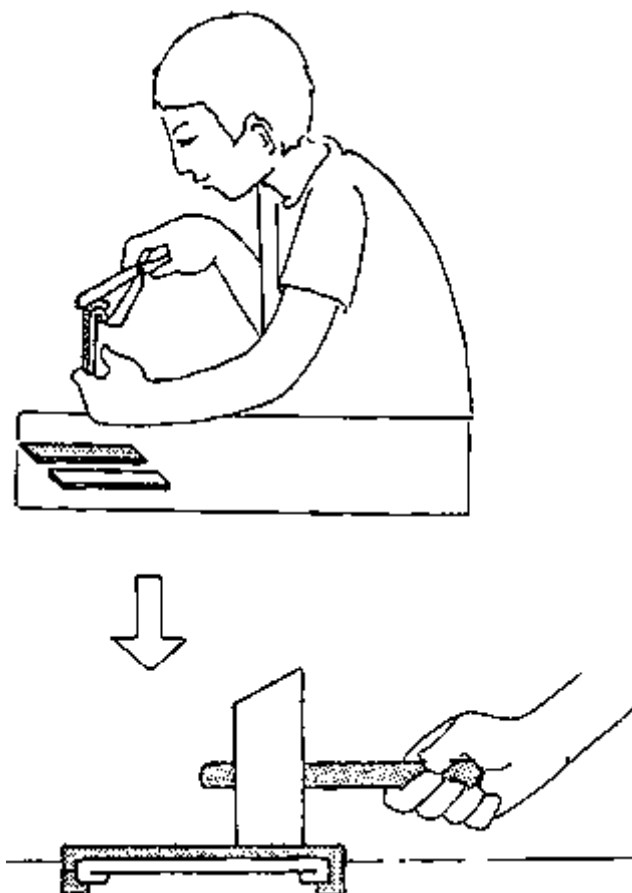

The strips are then hammered flat.

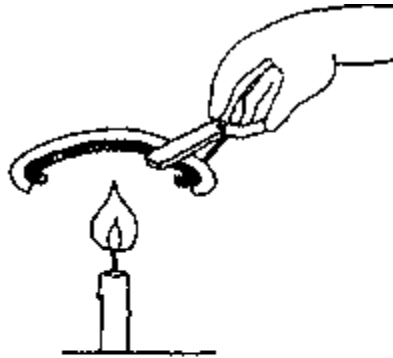

copper strip

aluminium strip



iron strip

iron strip

The bimetallc strip is held in a flame.

Observation:

The bimetallc strip bends when heated.

Analysis:

The copper and the aluminium strip expand more than the iron strip.

Practical Use:

Bimetallc strips are used wherever it is necessary to interrupt an electrical contact at a specific temperature.

The circuit is interrupted, when the bimetallc strip is twisted.

Thus, bimetallc strips serve in thermostats. They are used in irons, ovens, electrical fuses, refrigerators, etc.

Further thought:

How would you construct a switch (e.g. a thermostat) by the help of a bimetallc strip?

11. OPTICS

11.1. A CONVEX LENS

Main Goal:

This experiment shows the course of the rays of a convex lens or condensing lens.

Information:

Convex lenses are thicker in the middle than at the edges. Rays which are parallel to the optical axis, are refracted by a convex lens in such a way that they focus again behind the lens at the focal point. However, the marginal rays are refracted more than those rays which are closer to the optical axis.

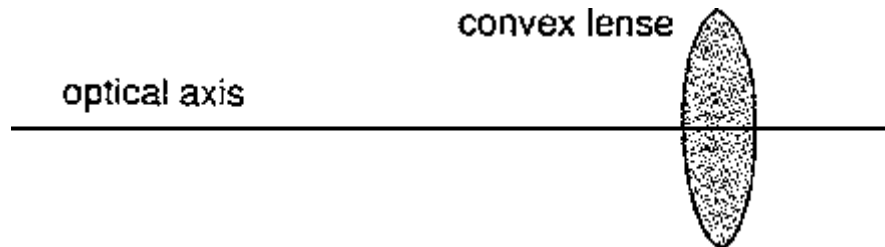

Materials and Apparatus:

*magnifying glass -
(one spectacle-lens for long-sighted people)
flashlight (maybe a candle)
rack made of wire for the flashlight*

Procedure:

The apparatus is set up as shown in the diagram below.
The room is darkened and the path of the rays observed.
This is possible when cigarette smoke is blown into the beam.

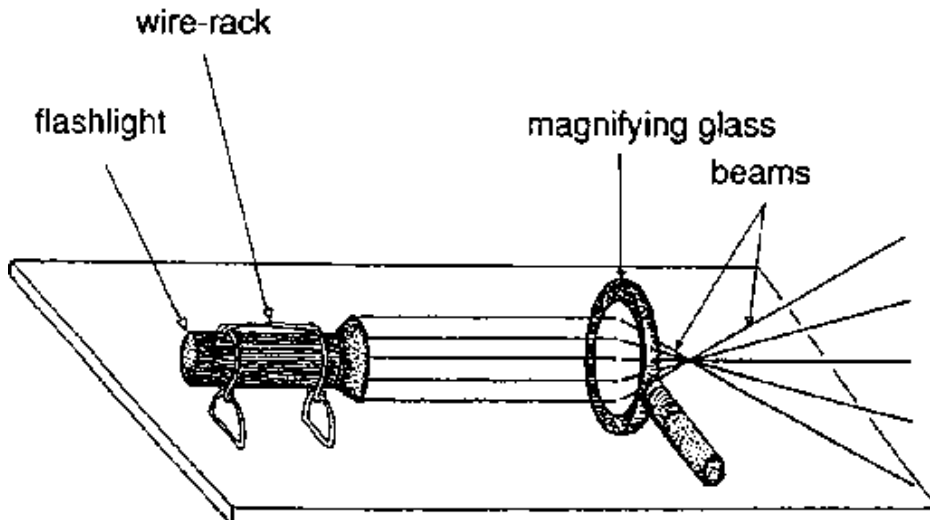

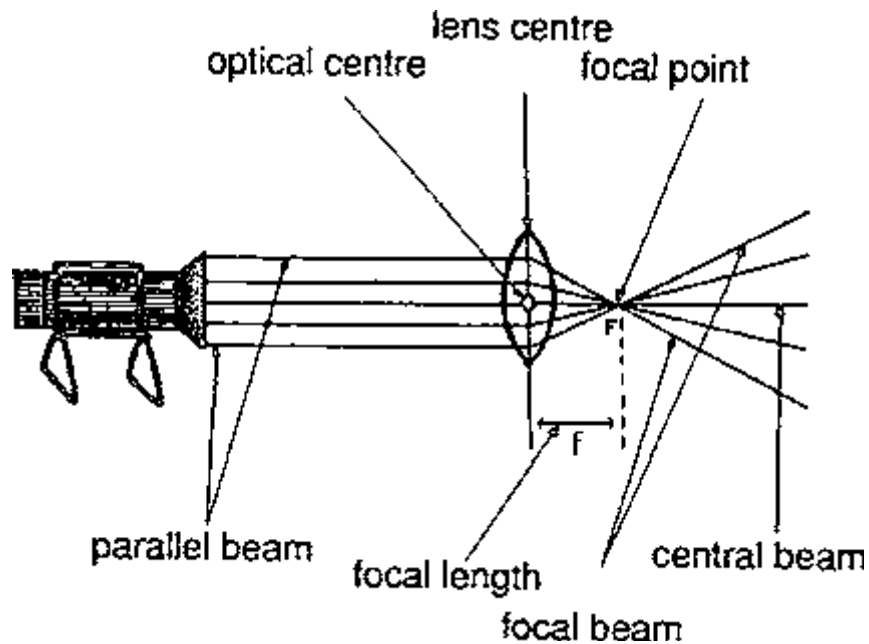

Observation:

The light of the flashlight is focused on one point behind the lens. When parallel light comes in from the right side, there can also a focal point be observed at the left side of the lense.

Analysis:

Lenses, which focus parallel light on one point are called condensing lenses or convex lenses.

The point is called the focal point.

It is situated on the optical axis.

The distance from the lens centre to the focal point is called the focal length (f).

Practical Use:

Convex lenses are used to correct long-sightedness and in microscopes, cameras, binoculars, etc.

The lens of the human eye is a convex lens.

Further thought:

Optical lenses normally are made of glass. Can one obtain the same effect (focusing of parallel light in one point) with lenses of other material?

11.2. THE BURNING GLASS

Main Goal:

The experiment demonstrates that a convex lens works as burning glass.

Information:

With a convex lens the sun's rays can be collected at the focal point (see experiment: A CONVEX LENS).

If a sheet of paper or the head of a match is held at the focal point, these materials ignite after a short while when the lens is placed perpendicular to the incoming sunlight. This is due to the fact that the energy carried by the sunlight is concentrated at the focal point.

Materials and Apparatus:

magnifying glass (one strong convex lens)
paper (match)

Procedure:

Sunlight is collected with a convex lens.
A sheet of paper or a match is placed at the focal point.
The spot of light should be as small as possible.



Observation:

The light can be seen as one small spot on the sheet of paper.

Here the paper starts to burn.

Analysis:

A convex lens can be used as a “burning glass”.

At the focal point, the sun's rays and the energy carried by these rays are collected. Here, the energy concentration or energy density is so high that paper can be set on fire.

Further thought:

Why can you not get the same effect with a flash light as light source?

11.3. MAGNIFYING GLASS - VIRTUAL IMAGE OF A CONVEX LENS

Main Goal:

This experiment demonstrates a virtual image of a convex lens.

Information:

If an object is placed at the focal point or between the lens and the focal point, a real image cannot be perceived. If one looks through the lens at the candle however one can perceive a larger non-inverted image. (The eye must be at a greater distance from the lens than of its focal length.)

The image is called a virtual image and is only perceived with the eyes. It cannot be projected on the screen. The virtual image is formed when the eye follows the incoming rays backwards to the seeming point of intersection.

Materials and Apparatus:

*magnifying glass -
(one spectacle-lens for long-sighted people)
candle or other objects such as flowers*

Procedure:

The burning candle is placed close to the lens. The candle is observed through the lens.

**image: candle object: candle
magnifying glass/spectacle-lens**

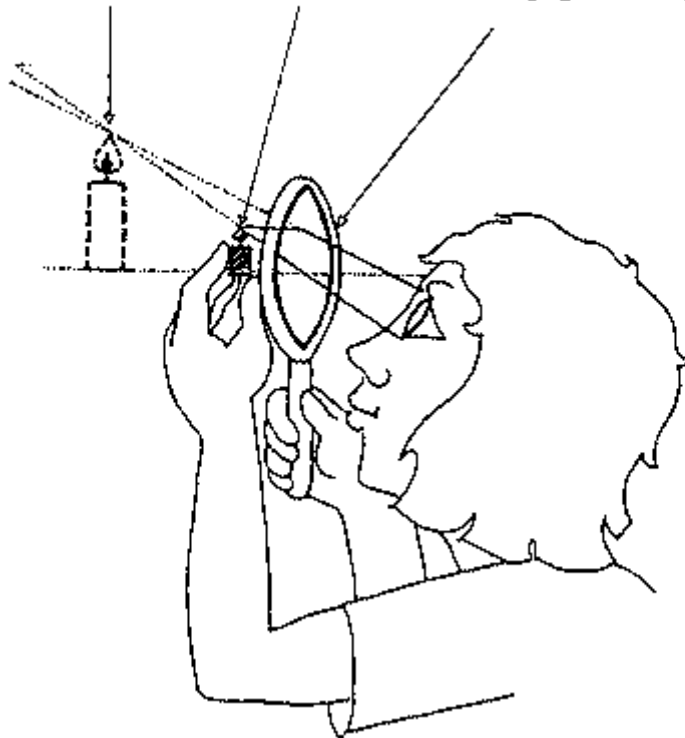

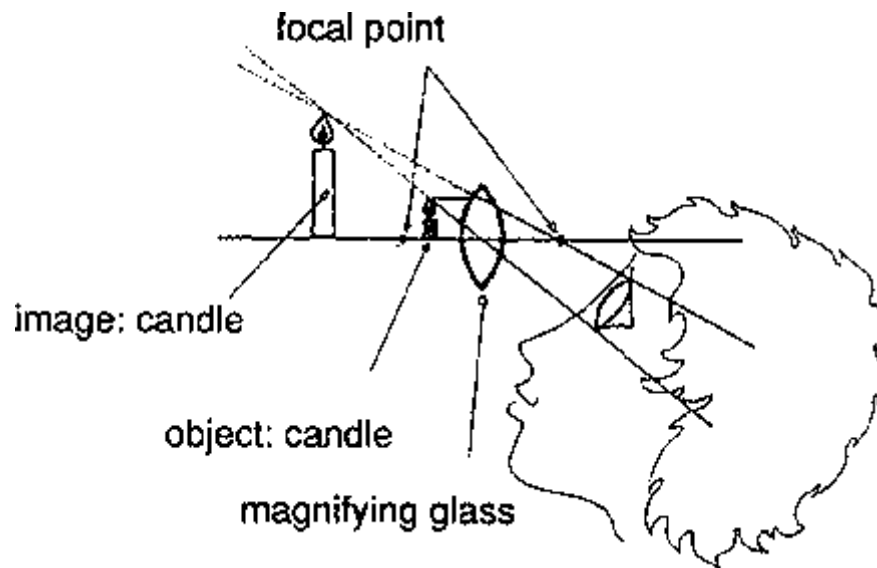

Observation:

Looking through the lens at the candle, non-inverted magnified image can be seen.

Analysis:

This image cannot be projected onto a screen. It is just the eye which perceives this imaginary or “virtual” image.

Practical Use:

A convex lens is needed by people who are longsighted.

The eyeball of a long-sighted eye is flattened. Thus, without a convex lens, the incoming rays meet “behind” the retina. The lens corrects this defect.

Further thought:

Within glass light has a lower velocity than in air. Therefore, light going through the middle of the lens, where the glass is thicker, loses more time than light going through the glass at the edge. Is this fact of importance for the image forming?

11.4. REAL IMAGES WITH CONVEX LENSES

Main Goal:

Through this experiment, images created by a convex lens are observed.

Information:

Convex lenses create images, which can be projected on a screen. They are called real images and appear upside down on the screen.

If an object is moved towards a convex lens, its real image moves further away from the lens and becomes larger.

If the object is located at the focal point, no real image is formed.

If the distance between the object and the lens is equal to twice the focal length, the image is the same size as the object. The distance from the image to the lens also equals twice the focal length.

Materials and Apparatus:

*magnifying glass -
(one spectacle-lens for long-sighted people)
screen made of cardboard, candle,
rack made of wire or wooden rack for the magnifying glass, measuring rod.*

Procedure:

The apparatus is set up as demonstrated in the diagram below. The candle is placed at one side of the lens. The screen is placed in such a way at the other side that a sharp image is obtained. When the candle is moved gradually towards the lens, the screen is moved correspondingly away from the lens.

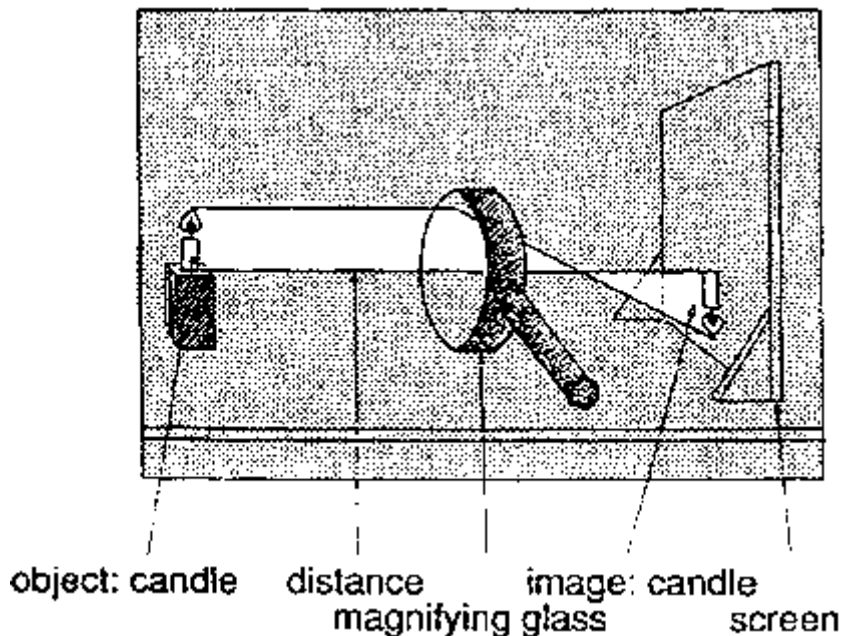

Using the measuring rod, the distance from the candle to the lens, the distance from the image to the lens, the object size and the image size are measured.

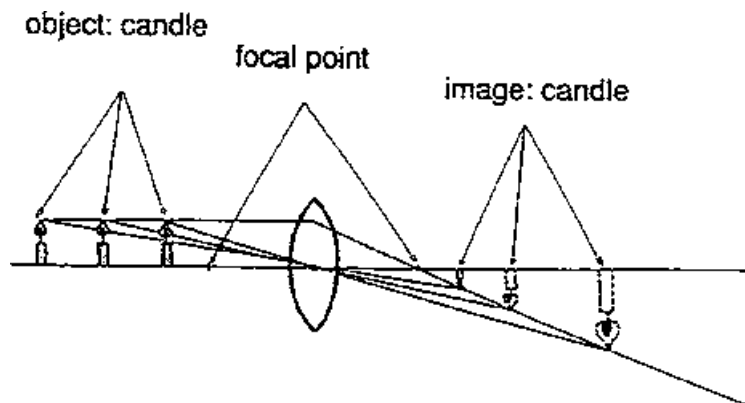

Observation:

Upside-down images are created.

The closer the candle is to the convex lens, the further away the image. At a certain distance (twice the focal length) from the lens, the object is the same size as the real image.

If the candle is placed close to the lens, no image is formed at all.

Analysis:

When the height of the object is equal to the height of the image, the distance from the candle to the lens is equal to the distance from the image to the lens and both are exactly double the focal length.

If the candle is placed at the focal point or between focal point and lens, no image can be projected.

Further thought:

When we want to get a magnified image of the object on the screen in which distance from the lens must the object be placed?

11.5. THE CONCAVE LENS

Main Goal:

Through this experiment, the course of the rays of a concave lens - diverging lens - can be observed.

Information:

Diverging lenses are thinner in the middle than at the rim.

Rays parallel to an axis are refracted by a concave lens in such a way that they are refracted off the optical axis.

If the rays are followed backwards, it seems as if they all come from one point. This point is called the "virtual focus" or "point of divergence".

The centre ray remains at the centre. No real image is created.

Materials and Apparatus:

*concave lens -
(one spectacle-lens for short-sighted people)
flashlight (or maybe a candle)
rack made of wire for the flashlight*

Procedure:

The apparatus is set up as shown in the following diagram. The room is darkened and the ray path is made visible by means of cigarette smoke or chalk dust.

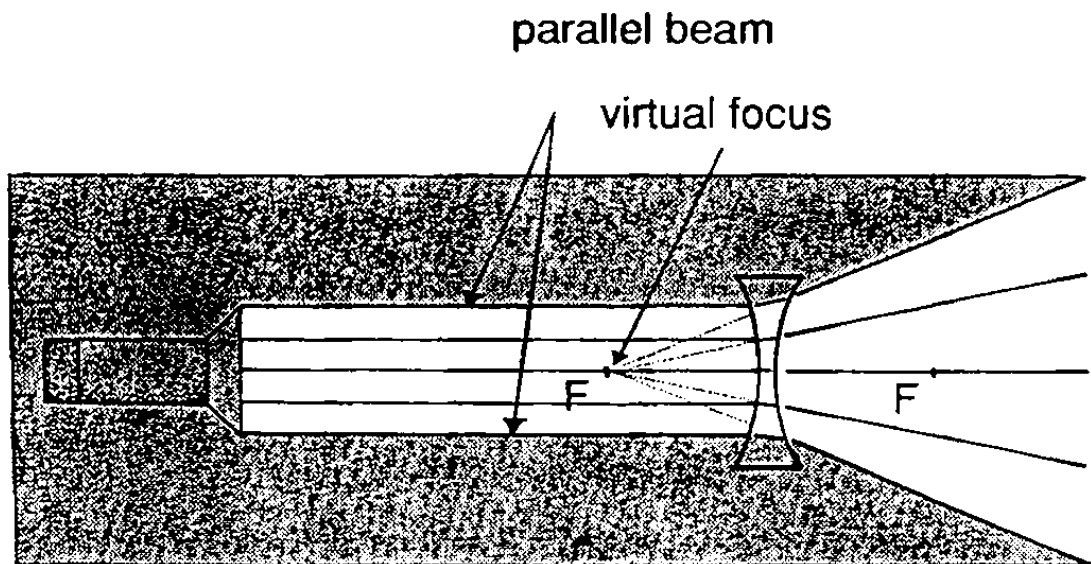
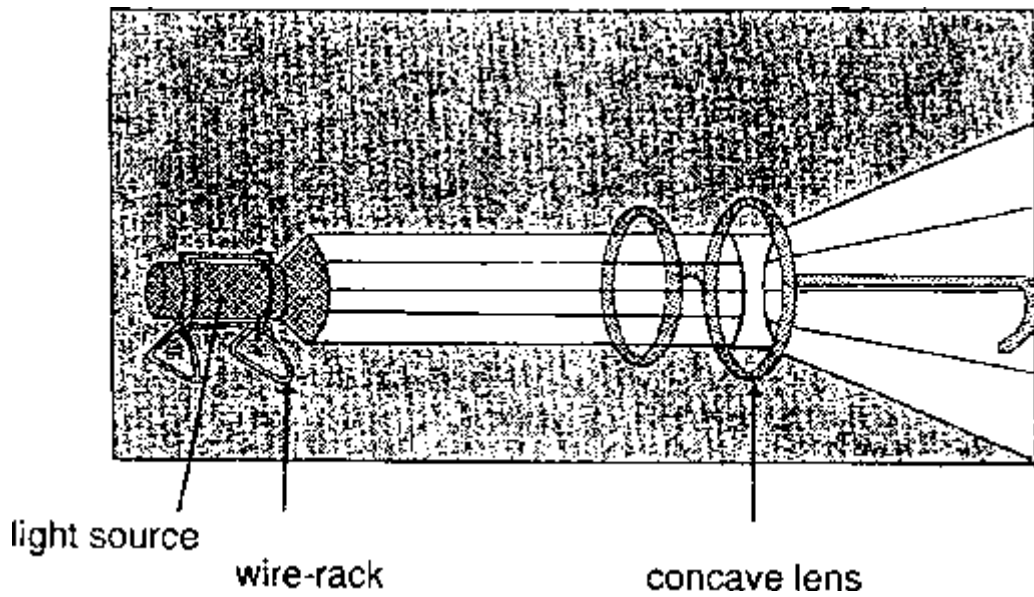

Observation:

Behind the lens, the light of the lamp is diverging in a way that makes them appear to come from a single point in front of the lens.

Analysis:

Lenses which deviate light in such a way that it is spread out or diverges are called concave (or negative) lenses.

If the refracted rays are followed backwards, it seems as if they all come from one point.

This point is called the virtual focus or point of divergence.

Practical Use:

A concave lens is used in glasses for short-sighted people, in cameras, telescopes, etc.

Further thought:

If light traveled at the same speed in different media, would glass lenses still alter the direction of rays?

11.6. VIRTUAL IMAGE OF A CONCAVE LENS

Main Goal:

This experiment demonstrates the virtual image of a concave lens.

Information:

Looking through a diverging lens towards an object, one can see a virtual, upright image. The image is always smaller than the object.

The course of rays followed by the eye is shown in a diagram.

Materials and Apparatus:

candle
concave lens -
(one spectacle-glass for short-sighted people)

Procedure:

The burning candle is placed at some distance from the lens. The candle is observed through the lens.

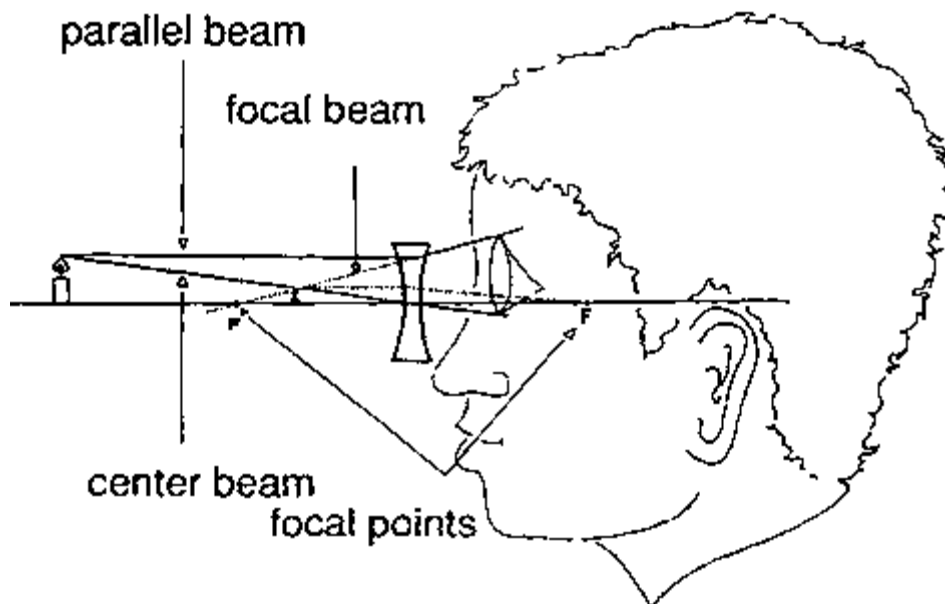

Observation:

An upright image is observed, smaller than the actual candle.

Analysis:

The image can only be observed with the eye or with a camera. It cannot be projected on a screen. For this reason it is called a “virtual image”.

Practical Use:

The concave lens is needed by people who are shortsighted.
The eyeball of the short-sighted eye is lengthened.
The incoming rays focus in front of the retina.
The lens corrects the defect.

Further thought:

There are lenses that are at one side convex and at the other side concave. How do they refract the light?

11.7. PINHOLE CAMERA

Main Goal:

Using a pinhole camera, the origin of optical images is demonstrated.

Information:

A pinhole camera creates upside-down, back-to-front images.

If the object is moved away from the pinhole diaphragm, the size of the image is reduced.

If the object is moved towards the pinhole diaphragm, the image is enlarged.

A small pinhole creates a clearer image but is weaker in light intensity than a bigger pinhole.

The image is created by rays coming from every point of the object. A small number of those rays arrive at the diaphragm opening. These finally focus onto the screen as several light spots. All of these spots together form the image.

Materials and Apparatus:

*candle
cardboard box (shoe or cigar box)
translucent paper, waxed paper
pieces of cardboard
pair of scissors
glue*

Procedure:

One of the two small side-walls of the cardboard box is replaced by translucent paper. That's the screen where the image appears.

A hole of 4 mm diameter is cut into the other small side-wall.

Two more holes with smaller diameter (2 or 1 mm) are cut into two other pieces of cardboard. The three cardboard pieces with holes are called pinhole apertures.

a. A burning candle is placed before the 4 mm aperture side at a distance of about 20 cm.

The room is darkened.

b. The image is observed. Then the 2 mm aperture is put over the 4 mm aperture. Again the image is observed. Finally the 1 mm aperture is used. The candle is moved away from and toward the apertures.

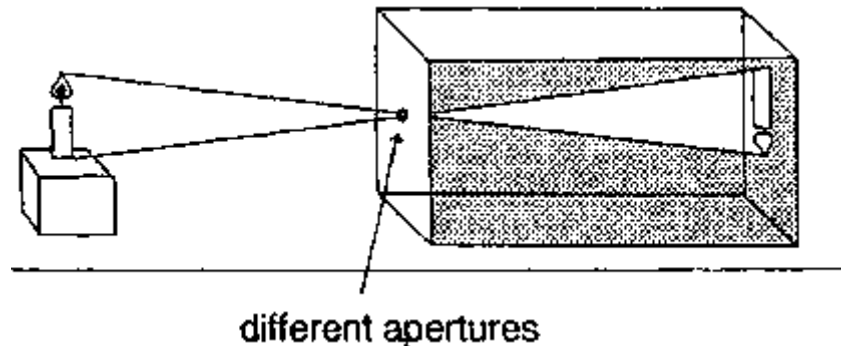

Observation:

- a. The image is always turned upside-down.
- b. The image becomes smaller as the candle is moved away from the diaphragm opening and bigger as it is moved in the other direction.
- c. The image created by a larger aperture is of higher light intensity but more blurred than that created by a smaller opening.

Analysis:

If good optical images are desired, the aperture, light intensity, and distance of the object from the aperture have to be coordinated.

Practical Use:

In a camera a condensing lens is placed in front of the diaphragm (see experiments on condensing lenses). This provides better light exposure. The size of an opening can be changed using a mechanism called iris diaphragm.

The human eye lets light penetrate through the pupil. The pupil becomes smaller or larger depending on the intensity of the light. Upside-down, scaled-down images are produced on the retina.

Further thought:

Our optical perception system delivers upside-down-images, but we 'see' things upright. Isn't that a contradiction?

GLOSSARY

ACCELERATION	:	Rate at which velocity changes with time. The change in velocity may be in magnitude (speeding up or slowing down) or in direction or both.
AMINO ACID	:	Chemical compounds in which a hydrogen atom in the alkyl group attached to the COOH (carbonyl) group of an organic acid is replaced by an NH ₂ group. Their common chemical formula is: R-CH(NH ₂)-COOH.
ANODE	:	anodos - Greek: the way upwards It is the electrode which is connected to the positive pole of a voltage source. (Gives off positive ions and towards which negative ions move)
ASSIMILATION	:	ad - Latin: to similis - Latin: similar Synthesis of organic compounds of indigested and digested nutrient materials, e.g. at the photosynthesis.
ATOM	:	atomos - Greek: an atom, invisible The smallest particle of an element, which does not admit a further division on the basis of chemical processes.
BIMETAL	:	Two different metals which are closely connected to each other
BOILING	:	A rapid state of evaporation which takes place within the liquid well as at the surface.
CAPILLARITY	:	The rise of a liquid in a fine hollow tube or in narrow space due to surface tension.
CARBOHYDRATE	:	Organic compounds of carbon, hydrogen, and oxygen with the general formula C _n (H ₂ O) _m , e.g. all kinds of sugar, starch, and cellulose.
CATALYZER	:	A substance which induces or accelerates a chemical process, however, is not affected by the reaction.
CATHODE	:	katodos - Greek: the way downwards It is the electrode which is connected to the negative pole of a voltage source. (Emits electrons and gives off negative ions.)
CELLULOSE	:	The chief substance composing the cell walls or woody part of plants, a carbohydrate of unknown molecular structure but having the composition represented by the empirical formula (C ₆ H ₁₀ O ₆) _x . (polysaccharides).
CINETIC ENERGY	:	Energy of motion of a body. Is proportional to the mass of the body and to the square of its speed.
CONDENSATION	:	Change of state from vapor to liquid.

CONDUCTOR	:	Any material through which electric charges easily flow when subject to an applied voltage.
CONES	:	Cells which perceive light. About 120 millions are found in the retina. They are responsible for the ability to see in the night, as they work at very low light intensities.
CONSERVATION OF ENERGY	:	Experience shows that energy cannot be destroyed. The total amount of energy never changes. But it may be transformed from one form into another one.
CONSTANTAN WIRE	:	A special kind of wire which has the same resistance does not expand when heated. It is an alloy made of 60% copper and 40% nickel.
CONVECTION	:	convehere - Latin: to bring together The transmission of heat or electricity by the mass movement of the heated or electrified particles as in air, gas, or liquid currents.
CONVERGING LENSE	:	A lens that is thicker in the middle than at the edges and refracts parallel rays of light passing through it to a focus.
COTELYDON	:	kotyle - Greek: cup The seed-leaf, primary or first leaf of an embryonic sporophyte. They are part of the plant embryo in the seed. Those of peas and beans serve as food storage organs for the seedling.
CRYSTAL	:	Regular arrangements of atoms, ions or molecules in a pattern as in solid grains, sugar, salt, etc.. The regular arrangements determine the shape of the matter.
DENSITY	:	The mass (amount of matter) per unit of volume (space into which the matter is packed) density = m/v = m/v (g/cm^3 or kg/m^3) The density of solid and liquid matters is dependant on temperature and that of gaseous matters is dependant on temperature and pressure.
DIFFUSION	:	diffundere - Latin: to diffuse The gradual permeation or spreading out, e.g. of a substance through a liquid (ink through water) or of a gas or of ions.
DIVERGING LENSE	:	A lens that is thinner in the middle than at the edges, causing light rays passing through it to diverge.
ELECTROLYSIS	:	lysis - Greek: a loosening, decomposition The decomposition into ions of a chemical compound by the action of an electric current passing through the solution.
EMBRYO	:	embryon - Greek: seedling The rudimentary plant which is usually contained in seeds.

EMIT	:	emittere - Latin: to send out
ENERGY	:	A state of a body or a system of bodies that - among other characteristics - enables the body or the system to do work.
ENZYME	:	zymes - Greek: leaven en - Greek: in Any of various complex organic substances, originating from living cells, and capable of producing by catalytic action certain chemical changes.
EROSION	:	erodere - Latin: to gnaw off The process by which the surface of the earth is worn away by the action of water, glaciers, wind, waves etc..
EVAPORATION	:	Change of state at a surface of a liquid as it passes to vapor.
FERMENTATION	:	fermentare - Latin: to cause to rise The breakdown of complex molecules in organic compounds, caused by the influence of organisms; such as yeast or bacteria or enzymes.
FORCE	:	Any influence that can cause a body to be accelerated.
FREEZING	:	Change of state from the liquid to the solid form.
FRICTION	:	A force that arises to oppose the motion or attempted motion of a body pass another with which it is in contact.
INDICATOR	:	indicare - Latin: to show A substance used to indicate by change in colour the acidity or alkalinity of a solution.
INERTIA	:	The sluggishness or apparent resistance a body offers to changes in its state of motion.
INSULATOR	:	Any material through which charge resist flow when subject to an applied voltage.
ION	:	ionos - Greek: to move Electrically charged atoms or molecules, formed by the loss or gain of one or more electrons.
MAGNET	:	An iron-bearing matter which possesses the property of attracting iron.
MAGNETISM	:	The property or quality or condition of a magnetic field.
MASS	:	Quantity of matter in a body. Becomes manifest due to a body's inertia and/or due to the property of being attracted by another mass in its environment (heaviness).
MELTING	:	Change of state from the solid to the liquid form.
MIXTURE	:	An aggregate of two or more substances which are not chemically united and exist in no fixed proportion and do not lose their individual characteristics.

MOLECULE	:	The smallest particle of any substance that has all its chemical properties. Atoms combine to form molecules.
MONOSACCHARIDE	:	A carbohydrate not decomposable by hydrolysis; simple sugar such as glucose, fructose, etc..
OSMOSIS	:	osmos - Greek: an impulse, a pushing The tendency of a fluid to pass through a semipermeable membrane into a solution of lower concentration, so as to equalize concentration on both sides of the membrane.
OSMOTIC PRESSURE	:	The pressure caused by osmosis.
PARTICLE	:	Any body that is projected by some force and continues in motion by virtue of its own inertia.
PHLOEM	:	phloios - Greek: inner bark Bast-tissue; the soft bast of vascular bundles, consisting of sieve-tube tissue. Its purpose is to transport proteins and minerals.
PHOTOSYNTHESIS	:	phos - Greek/Latin: light synthesis - Greek: putting together Carbon assimilation, requiring the presence of chloroplasts and light, and consisting in synthesis of carbohydrates from carbon dioxide and water.
PHOTOTROPISM	:	phos - Greek/Latin: light tropein - Greek: to change A bending towards light.
POLYSACCHARIDE	:	polys - Greek: many saccharum - Latin: sugar Any of a group of carbohydrates that decomposes by hydrolysis into more than three molecules of monosaccharides. For instance cellulose, starch, etc..
POWER	:	Time rate of work: $\text{power} = \frac{\text{work}}{\text{time}}$
PRESSURE	:	Ratio of the amount of force per area over which that force is distributed. $\text{pressure} = \frac{\text{force}}{\text{area}}$
PURE SUBSTANCE	:	It is a substance which cannot be further separated on the basis of physical processes.
RADIANT ENERGY	:	Energy that travels in the form of electromagnetic waves through space without needing a medium. When it meets an absorber it is transformed into thermal energy. On the other hand, the thermal energy of a radiating body is transformed, at the instant of radiation, into radiant energy.

REFLECT	:	reflectare - Latin: to mirror
RODS	:	Cells which perceive light. About 6 millions are found in the retina of vertebrate animals. They serve to perceive light and the exact recognition of details.
SPEED	:	Distance traveled per time.
SPROUT	:	Usually the above ground part of a plant with the leaves, the buds, genital organs (e.g. blossoms).
STARCH	:	A polysaccharide which is insoluble in water. It consists of the two components amylose and amylopectin.
SURFACE TENSION	:	Tendency of the surface of a liquid to contract in area and thus behave similar a stretched rubber membrane.
SURFACE TENSION	:	Tendency of the surface of a liquid to contract in area and thus behave similar a stretched rubber membrane.
THERMAL ENERGY	:	Internal energy a body possesses due to the random motion of its molecules. The faster the motion, the higher the thermal energy of the body.
VASCULAR TISSUE	:	Specially modified plant-cells, usually consisting of either tracheid or sieve cells, for circulation of sap.
VELOCITY	:	Speed of a body but with specification of its direction of motion.
WORK	:	Product of the force extended and the distance through which the force acts.
XYLEM	:	xylon - Greek: wood Lignified portion of vascular bundle, which is found all over the plant. Its purpose is to transport mineral salts and water sucked up over the roots.

GTZ

*Deutsche Gesellschaft für Technische Zusammenarbeit (GTZ) GmbH
Dag-Hammarskjöld-Weg 1+2 · D6236 Eschborn 1 · Telefon (0 6196) 79-0 · Telex 407 501-0
gtz d*

The government-owned GTZ operates in the field of Technical Cooperation. Some 4,500 German experts are working together with partners from some 100 countries in Africa, Asia and Latin America in projects covering practically every sector of agriculture, forestry, economic development, social services and institutional and physical infrastructure. - The GTZ is commissioned to do this work by the Government of the Federal Republic of Germany and by other national and international organizations.

GTZ activities encompass:

- appraisal, technical planning, control and supervision of technical cooperation projects commissioned by the Government of the Federal Republic of Germany or by other authorities
- advisory services to other agencies implementing development projects

- the recruitment, selection, briefing and assignment of expert personnel and assuring their welfare and technical backstopping during their period of assignment
- provision of materials and equipment for projects, planning work, selection, purchasing and shipment to the developing countries
- management of all financial obligations to the partner country.