



UNIVERSITY OF CAMBRIDGE INTERNATIONAL EXAMINATIONS
International General Certificate of Secondary Education

CANDIDATE
NAME

CENTRE
NUMBER

--	--	--	--	--

CANDIDATE
NUMBER

--	--	--	--

* 0 2 2 6 1 5 2 0 3 5 *

BIOLOGY

0610/02

Paper 2 Core

May/June 2008

1 hour 15 minutes

Candidates answer on the Question Paper.

No Additional Materials are required.

READ THESE INSTRUCTIONS FIRST

Write your Centre number, candidate number and name on all the work you hand in.

Write in dark blue or black pen.

You may use a pencil for any diagrams or graphs.

Do not use staples, paper clips, highlighters, glue or correction fluid.

Answer **all** questions.

At the end of the examination, fasten all your work securely together.

The number of marks is given in brackets [] at the end of each question or part question.

For Examiner's Use	
1	
2	
3	
4	
5	
6	
7	
8	
9	
10	
11	
Total	

This document consists of **15** printed pages and **1** blank page.



1 Respiration is one of the characteristics of living things.

(a) List four other characteristics of living things **not** including respiration.

- 1
- 2
- 3
- 4 [4]

(b) Describe the difference between *respiration* and *breathing*.

.....

.....

..... [2]

[Total: 6]

2 Choose words from the list to complete each of the spaces in the paragraph.

Each word may be used once only and some words are not used at all.

- | | | | | | |
|---------------|--------------|----------------|---------------|--------------|--------------|
| bright | dry | dull | heavy | large | light |
| sepals | small | stamens | sticky | style | |

Flowers of plants that rely on the wind to bring about pollination tend to

have petals that have a colour.

Their pollen is normally and

In these flowers, the and the both tend to be long. [6]

[Total: 6]

- 3 (a) Table 3.1 lists some of the food materials that need to be digested, the enzymes that carry out the digestion and the end products.

Complete Table 3.1.

[5]

Table 3.1

food material	digestive enzyme	end products of digestion
starch	simple sugars
.....	amino acids
fat	lipase

- (b) Amino acids and glucose are carried in the blood from the intestine to the liver.

Describe the processes that occur in the liver when there is an excess of these materials arriving in the blood.

amino acids

.....

.....

glucose

.....

..... [4]

[Total: 9]

4 (a) (i) Name the two raw materials needed by plants for photosynthesis.

1

2 [2]

(ii) Name the gas produced by photosynthesis.

..... [1]

(b) Fig. 4.1 shows a leaf, with white and green regions, that is attached to a plant. The plant had been kept in the dark for 48 hours and then a lightproof, black paper cover was placed over part of the leaf.

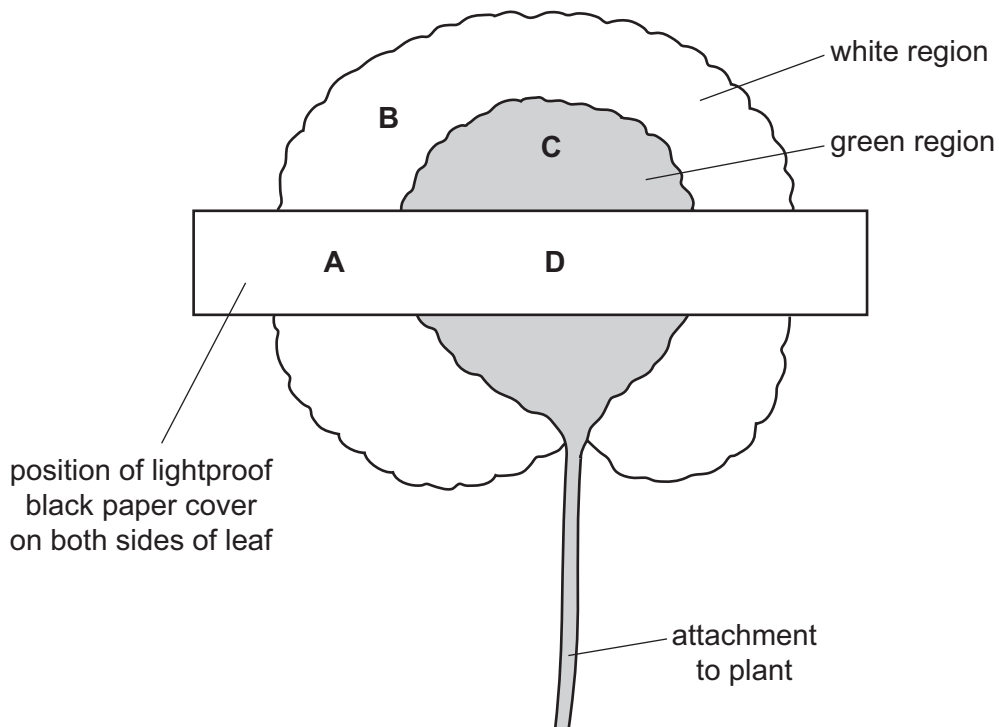

Fig. 4.1

The plant is left under a light for 24 hours. After this time the leaf is removed from the plant and is tested for the presence of starch.

*For
Examiner's
Use*

(i) Which chemical reagent is used to show the presence of starch?

..... [1]

(ii) Record the colour you would see, if you had carried out this test, in each of the areas **A**, **B**, **C**, and **D**.

area	colour
A	
B	
C	
D	

[4]

(iii) Explain the results for each of the following areas.

area **B**

.....

area **D**

..... [2]

[Total: 10]

5 Fig. 5.1 shows a section through the heart.

For
Examiner's
Use

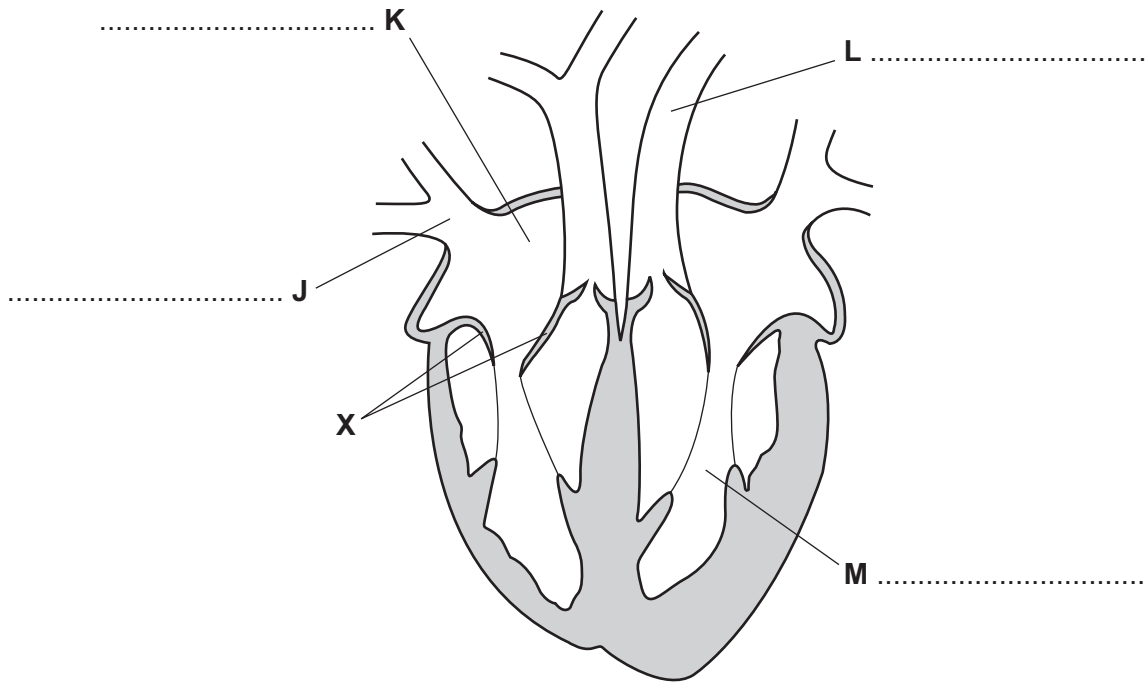

Fig. 5.1

(a) On Fig. 5.1,

- (i) label parts **J**, **K**, **L** and **M**, [4]
- (ii) shade in the blood vessels that carry deoxygenated blood, [1]
- (iii) draw a series of arrows to show the direction of blood flow through the heart from the lungs to the rest of the body. [1]

(b) Describe the role of valve **X**.

.....

.....

..... [2]

[Total: 8]

6 Fig. 6.1 shows the female reproductive system.

For
Examiner's
Use

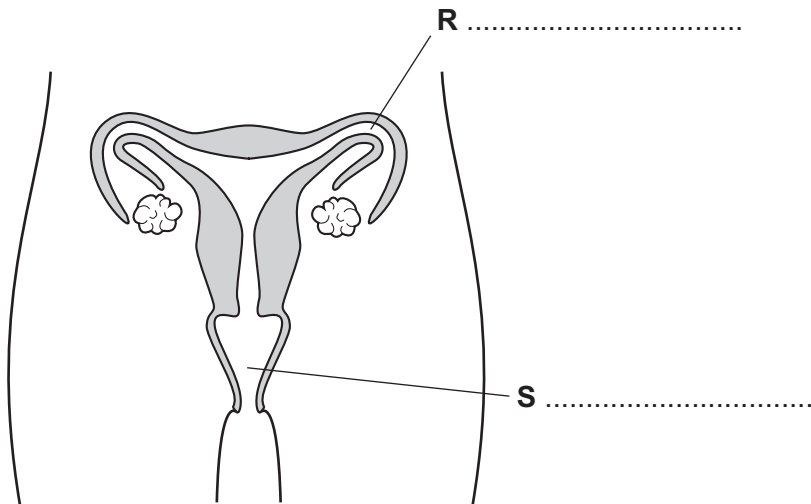

Fig. 6.1

(a) On Fig. 6.1, label structures **R** and **S**. [2]

(b) On Fig. 6.1,

(i) label, with a line and a letter **F**, where fertilisation occurs, [1]

(ii) label, with a line and a letter **I**, where implantation occurs. [1]

(c) During puberty, the secondary sexual characteristics develop.

(i) Name the hormone that controls these developments in a female and state which organ produces it.

hormone

organ producing it [2]

(ii) State two secondary sexual characteristics that develop in females, in parts of the body other than in the reproductive organs shown in Fig. 6.1.

1

.....

2

..... [2]

[Total: 8]

7 Fig. 7.1 shows a family tree for a condition known as nail-patella syndrome (NPS).

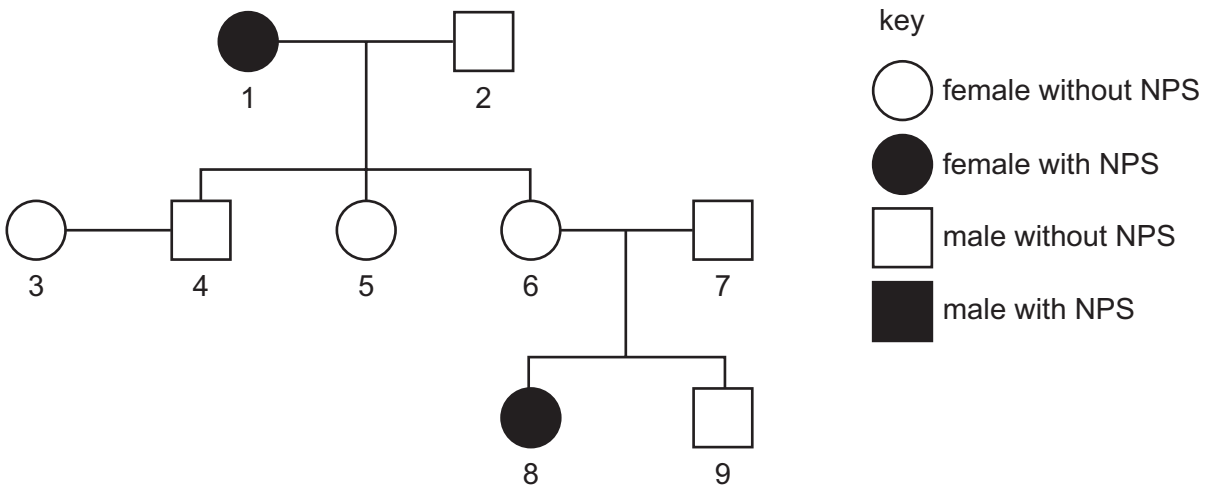

Fig. 7.1

(a) (i) State whether NPS is controlled by a dominant or a recessive allele.

.....

(ii) Explain which evidence from the family tree confirms your answer to (i).

.....

.....

.....

..... [3]

For
Examiner's
Use

(b) Explain what the chances are for a third child of parents 6 and 7 having NPS.

You may use a genetic diagram to help your explanation.

*For
Examiner's
Use*

.....

.....

.....

..... [3]

[Total: 6]

- 8 Fig. 8.1 shows changes in the population of bacteria that take place in a river when untreated sewage is added to it.

For
Examiner's
Use

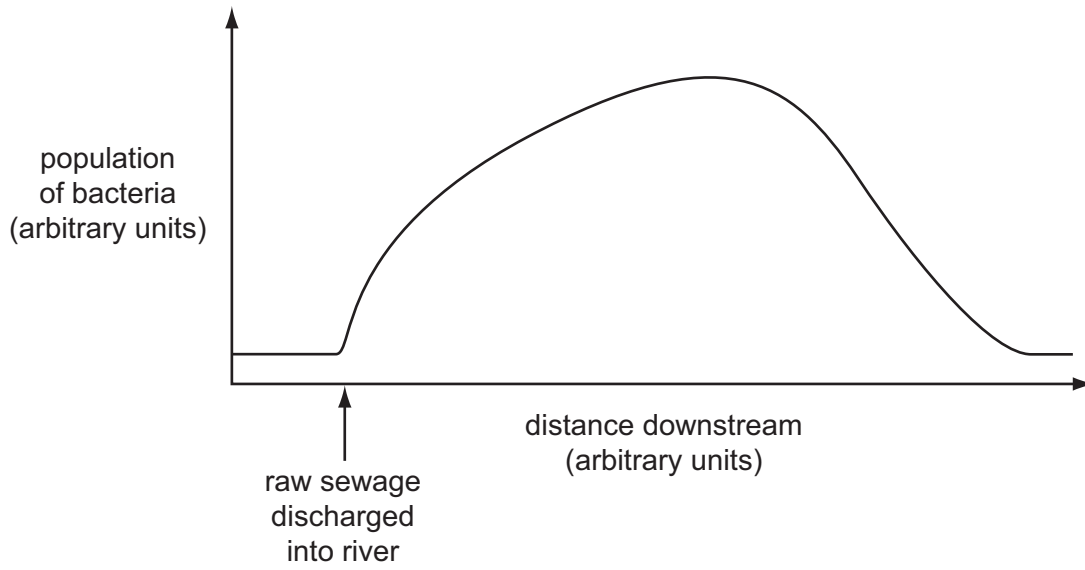

Fig. 8.1

- (a) Describe the changes in the population of bacteria that take place in this river.

.....
.....
..... [2]

- (b) Suggest an explanation for these changes in the population of bacteria.

.....
.....
.....
.....
.....
..... [4]

[Total: 6]

9 Fig. 9.1 shows part of a food web for the South Atlantic Ocean.

For
Examiner's
Use

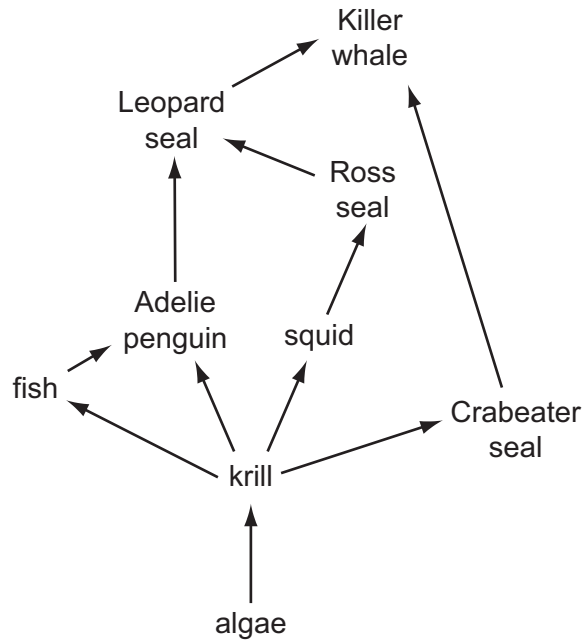

Fig. 9.1

(a) (i) Name the top carnivore in this food web.

..... [1]

(ii) Name a member of this food web that is both a secondary and a tertiary consumer.

..... [1]

(b) Use the information from the food web to complete the food chain of five organisms.

algae → → → → [2]

(c) In the future the extraction of mineral resources in the Antarctic might occur on a large scale. This could destroy the breeding grounds of the Ross seal.

(i) State and explain what effects this might have on the population of Leopard seal.

.....

 [2]

(ii) State and explain what effects this might have on the population of fish.

.....
.....
.....
.....
..... [4]

[Total: 10]

*For
Examiner's
Use*

10 (a) Define the term *homeostasis*.

.....
.....
..... [2]

(b) It has been suggested by some scientists that the iris reflex is an example of homeostasis.

Describe this reflex and explain why it might be considered to be a homeostatic mechanism.

.....
.....
.....
.....
..... [3]

[Total: 5]

For
Examiner's
Use

11 (a) Fig. 11.1 shows the urinary system and its blood supply.

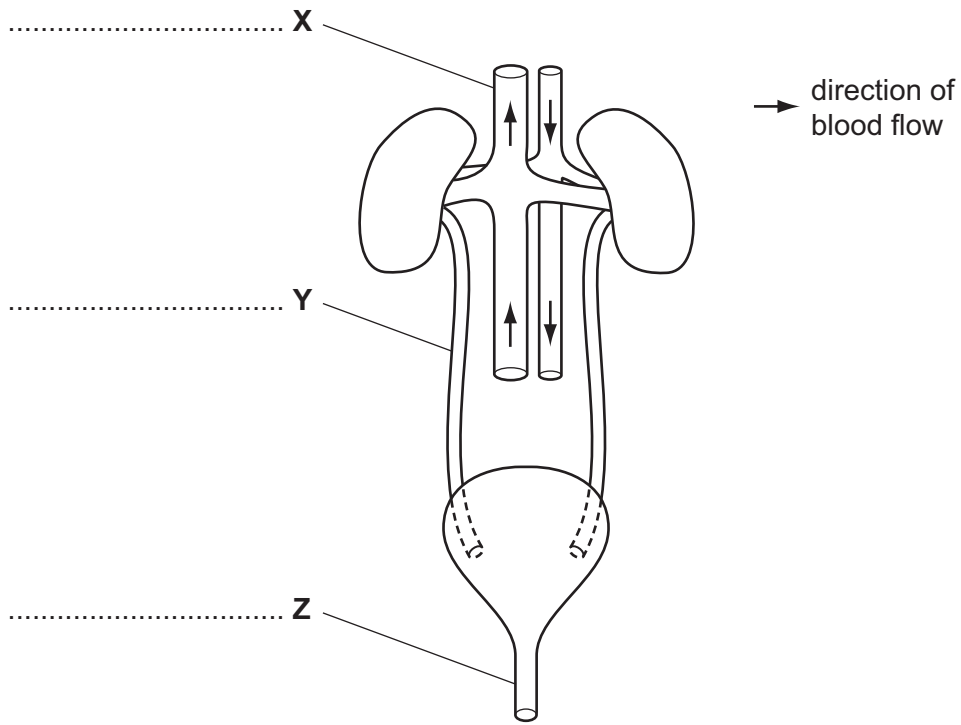

Fig. 11.1

On Fig. 11.1 label structures **X**, **Y** and **Z**. [3]

(b) Table 11.1 shows the relative quantities of several substances in the blood in the renal artery and renal vein.

Table 11.1

substance	relative quantities in blood in renal artery (arbitrary units)	relative quantities in blood in renal vein (arbitrary units)
glucose	10.0	9.7
oxygen	100.0	35.0
sodium salts	32.0	29.0
urea	3.0	1.5
water	180.0	178.0

Explain what is happening in the kidney to bring about **three** of the differences between the blood in the renal artery and renal vein, shown in the table.

*For
Examiner's
Use*

.....

.....

.....

.....

..... [3]

[Total: 6]

BLANK PAGE

Permission to reproduce items where third-party owned material protected by copyright is included has been sought and cleared where possible. Every reasonable effort has been made by the publisher (UCLES) to trace copyright holders, but if any items requiring clearance have unwittingly been included, the publisher will be pleased to make amends at the earliest possible opportunity.

University of Cambridge International Examinations is part of the Cambridge Assessment Group. Cambridge Assessment is the brand name of University of Cambridge Local Examinations Syndicate (UCLES), which is itself a department of the University of Cambridge.