

IBM 3746 Nways Multiprotocol Controllers Models 900 and 950

December 2, 1997
(Revision 4)

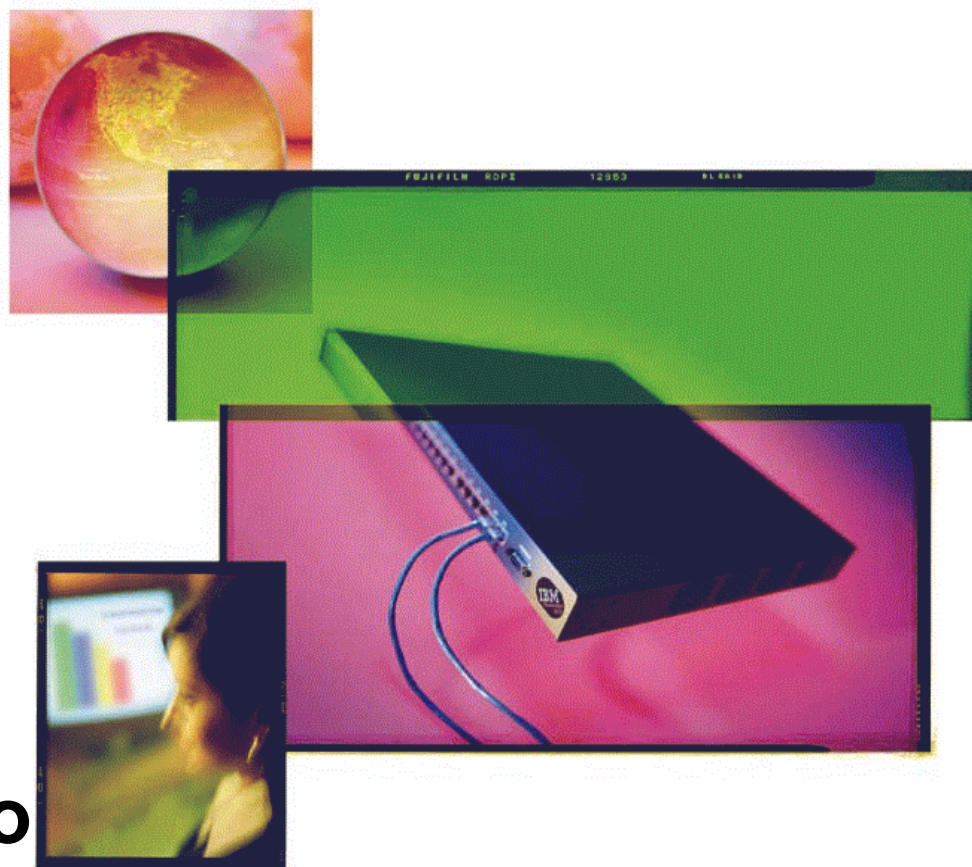

Evolution from 3745 to 3746-950 "Step by Step"

Evolution from 3745 to 3746-950 (1)

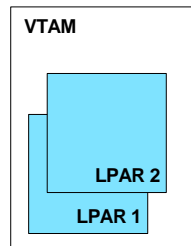

3745

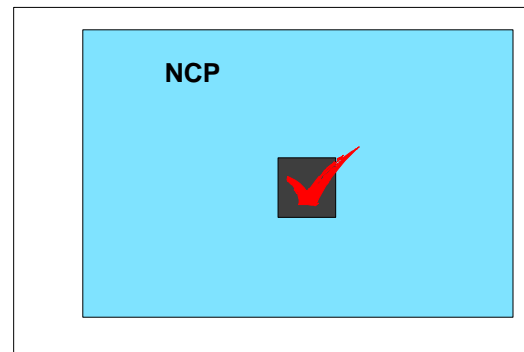

The Sky is BLUE....

The network is SNA ...

Let's jump to the future
Dynamic Networking
World in GREEN...

with APPN / HPR



Evolution from 3745 to 3746-950 (1)

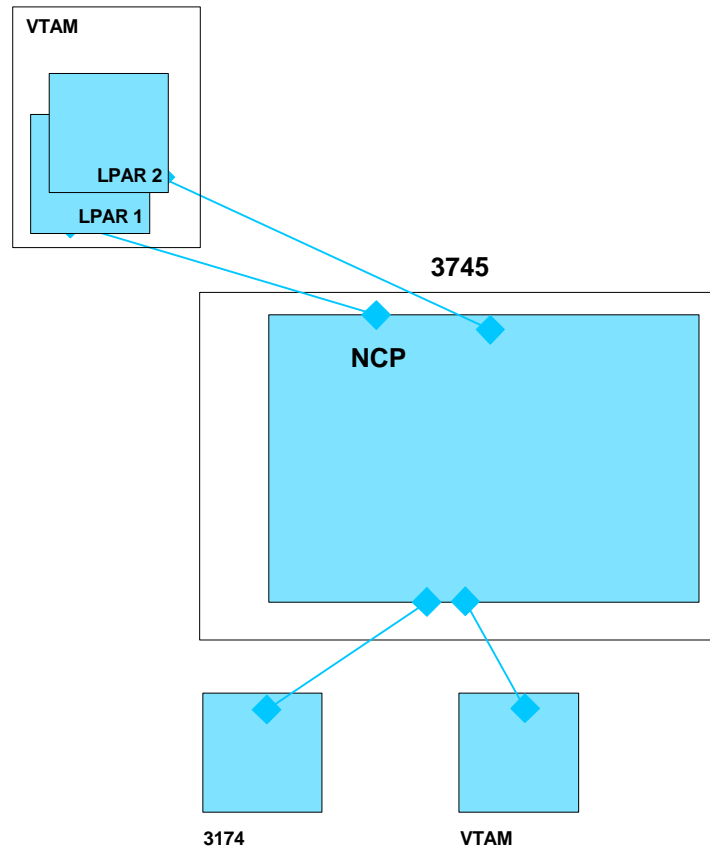

Evolution from 3745 to 3746-950 (1)

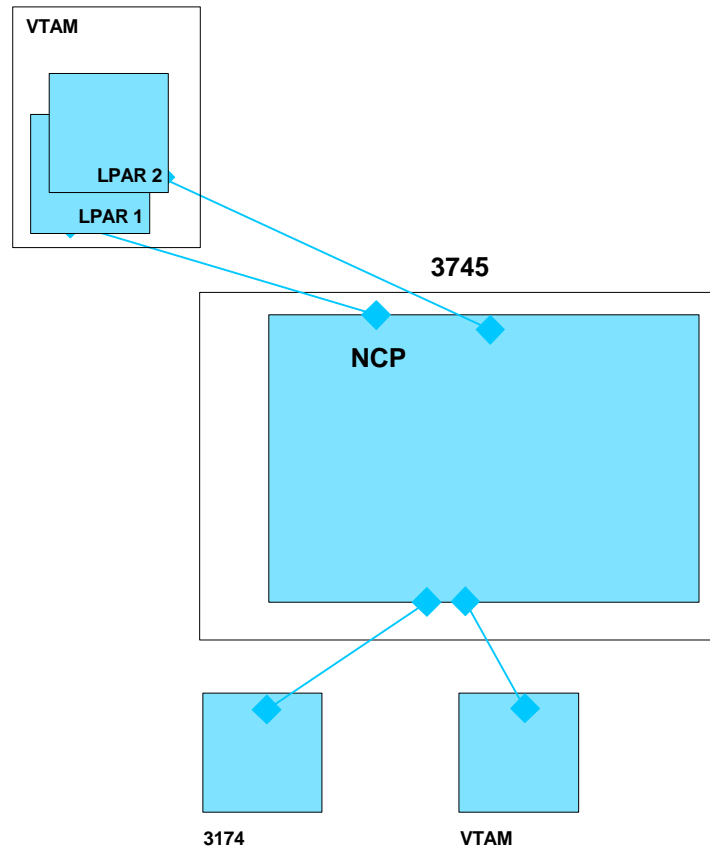

Add a 3746-900
for Performance
Connectivity
Cost savings

Evolution from 3745 to 3746-950 (2)

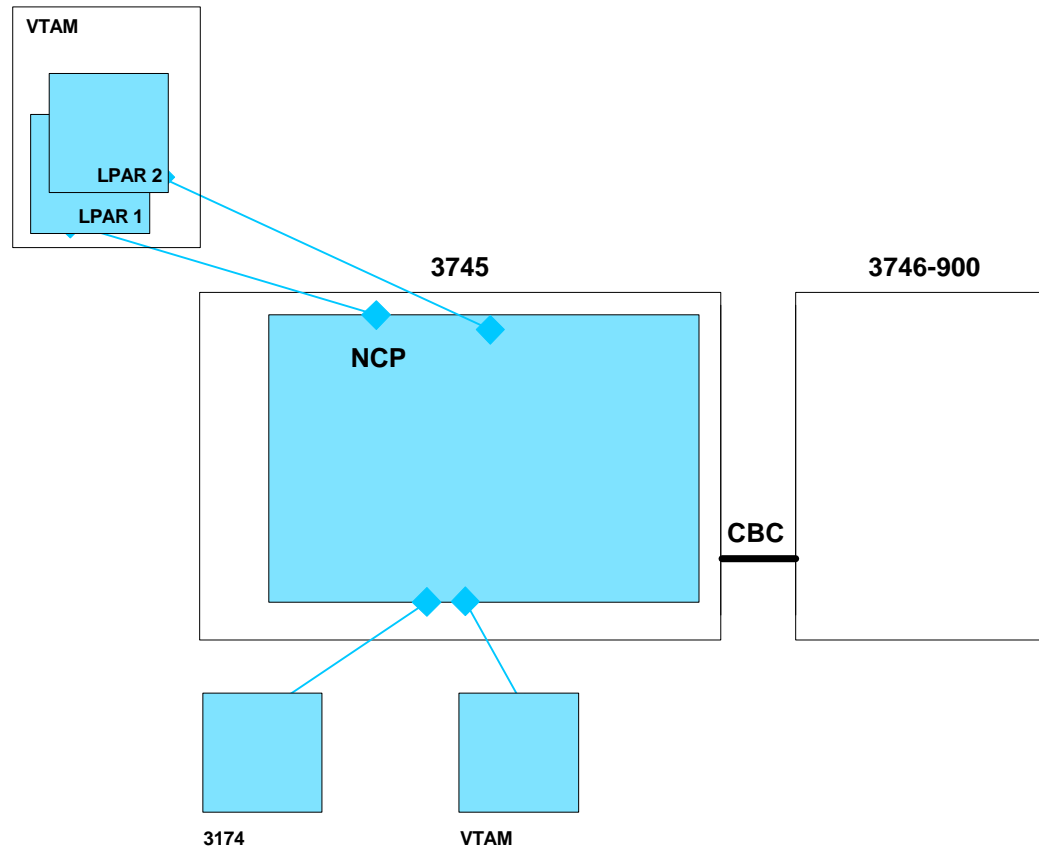

Evolution from 3745 to 3746-950 (2)

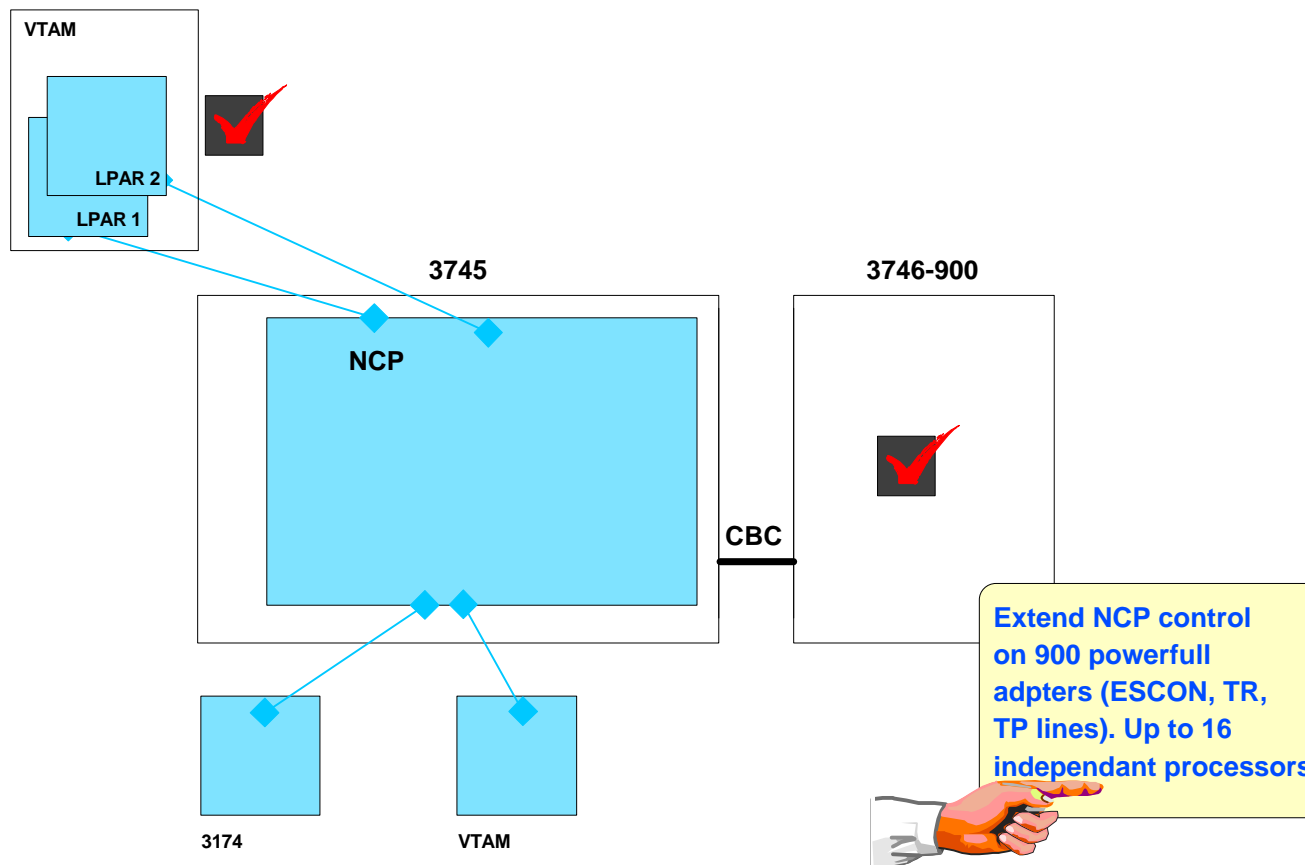

Evolution from 3745 to 3746-950 (3)

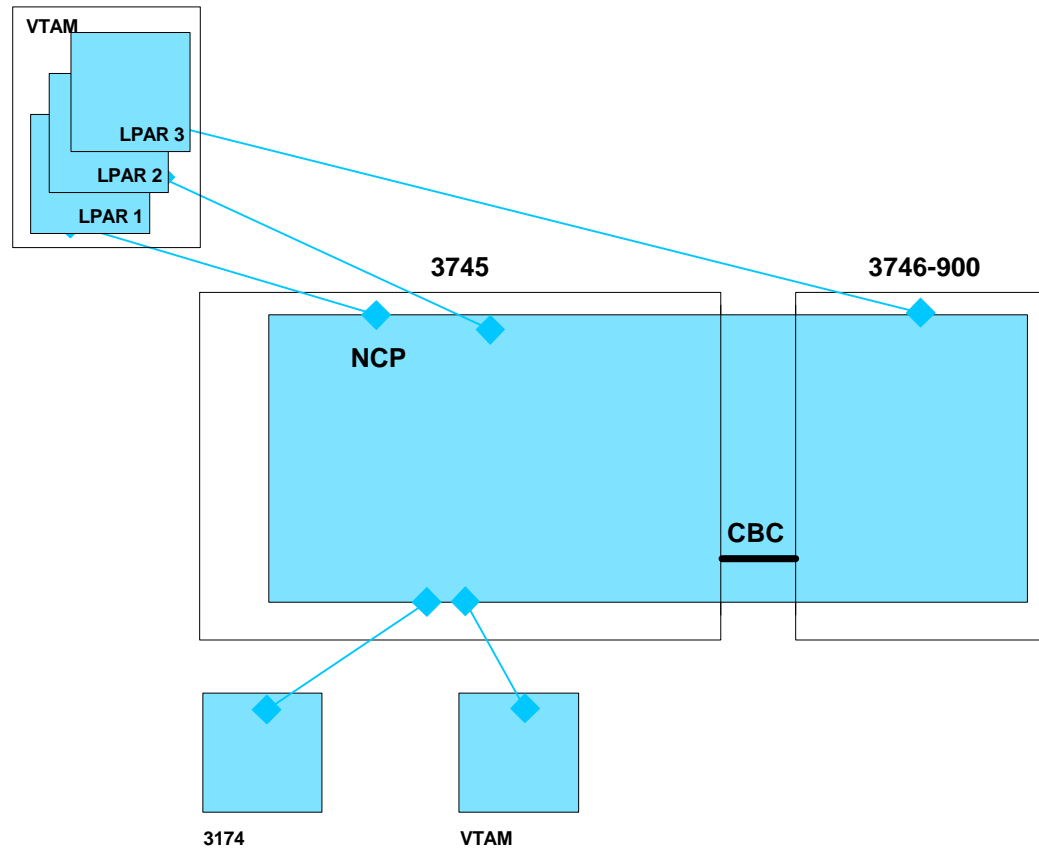

Evolution from 3745 to 3746-950 (3)

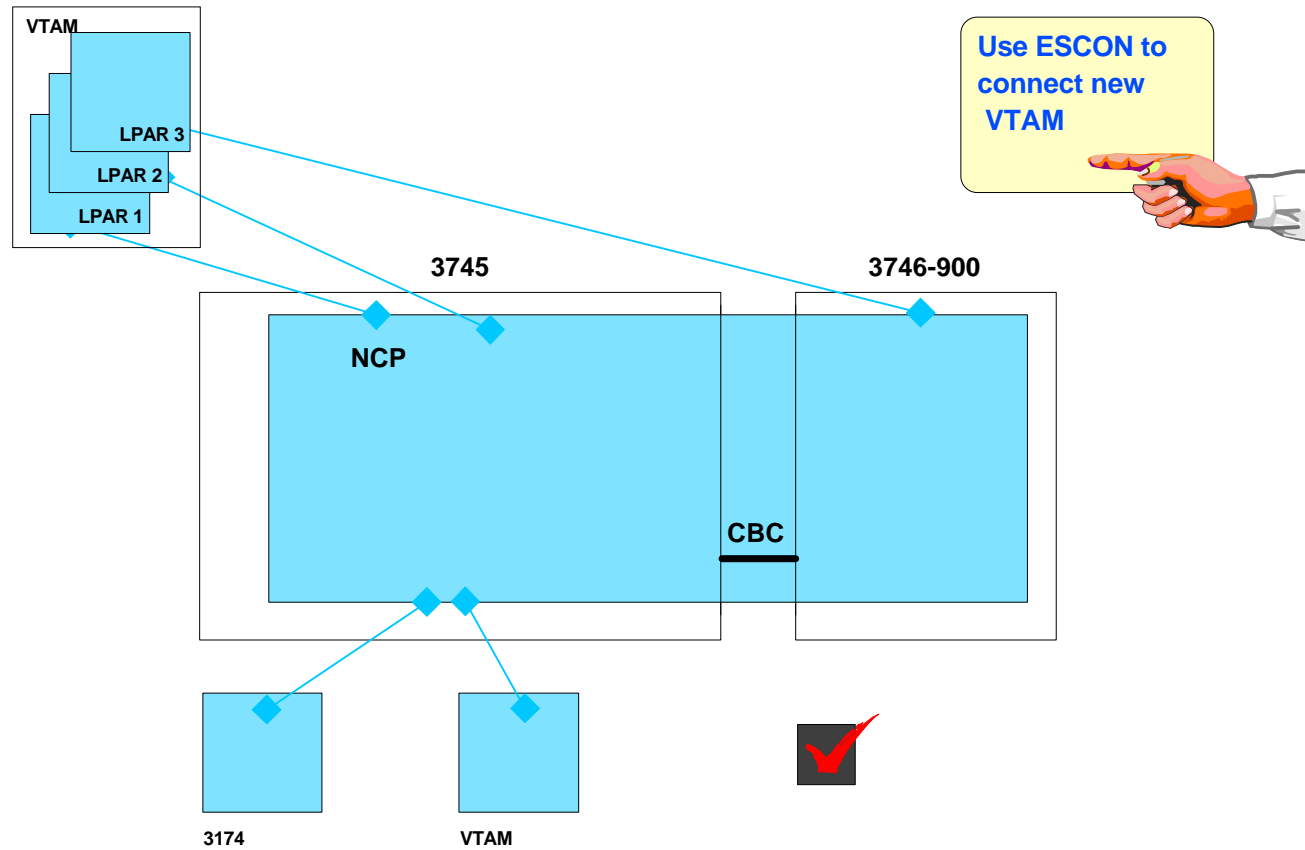
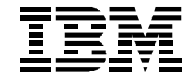

Evolution from 3745 to 3746-950 (4)

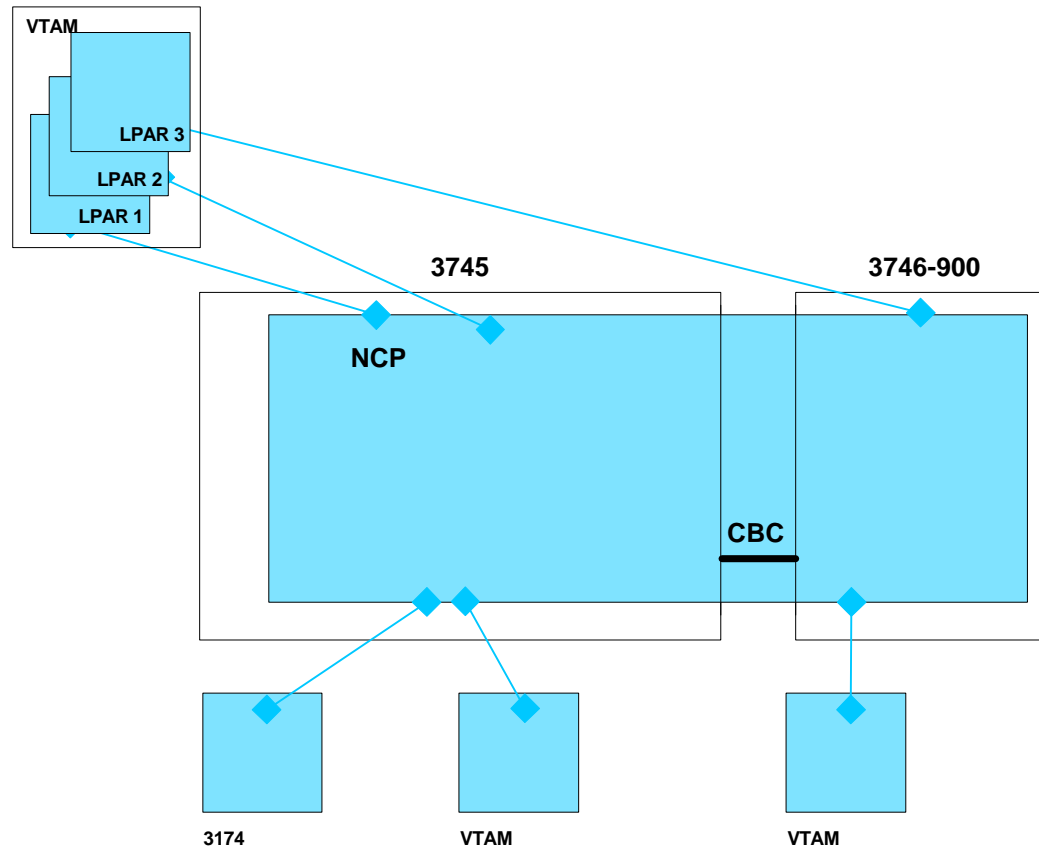

Evolution from 3745 to 3746-950 (4)

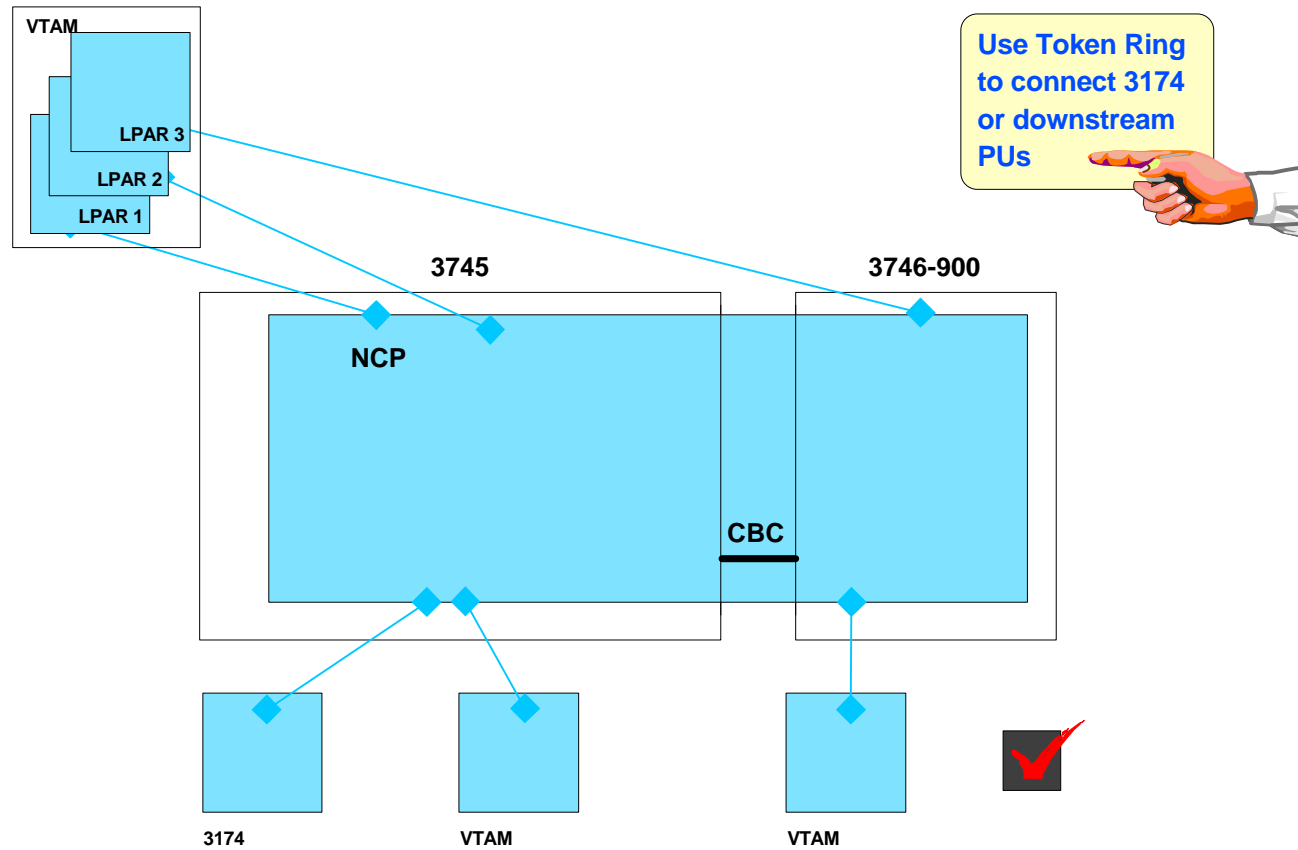

Evolution from 3745 to 3746-950 (5)

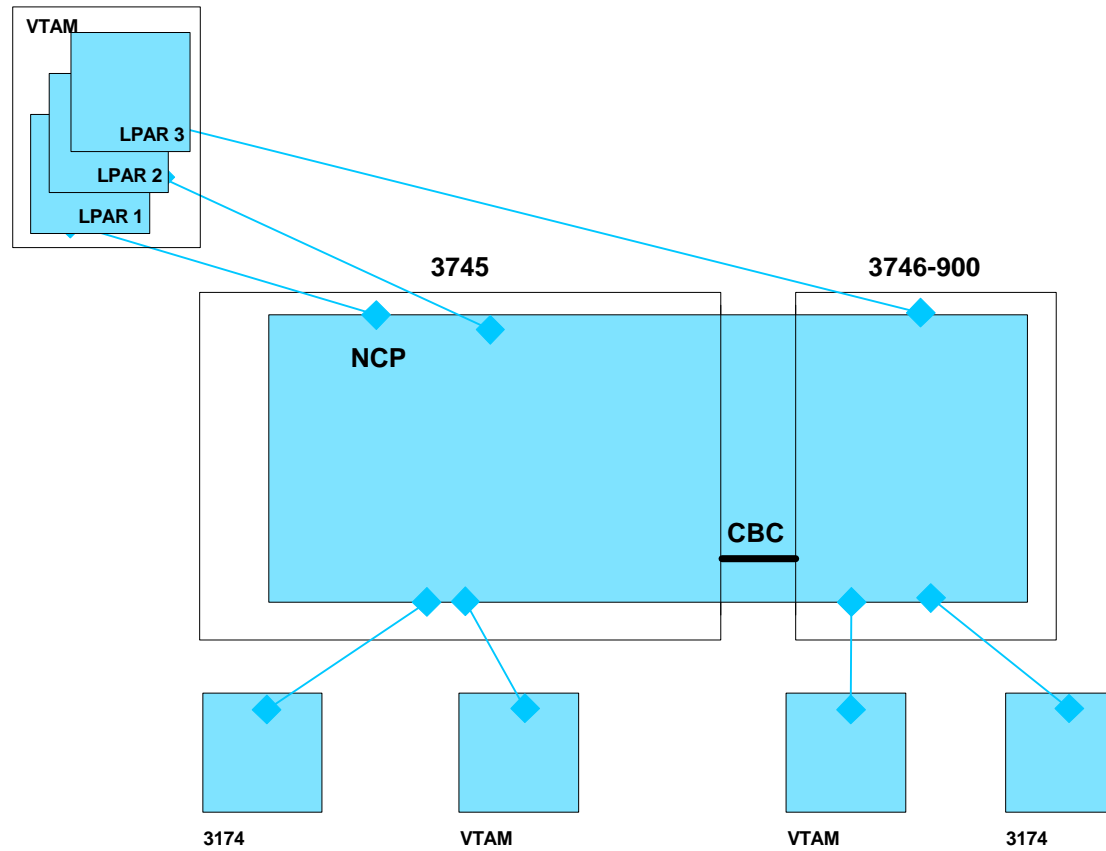

Evolution from 3745 to 3746-950 (5)

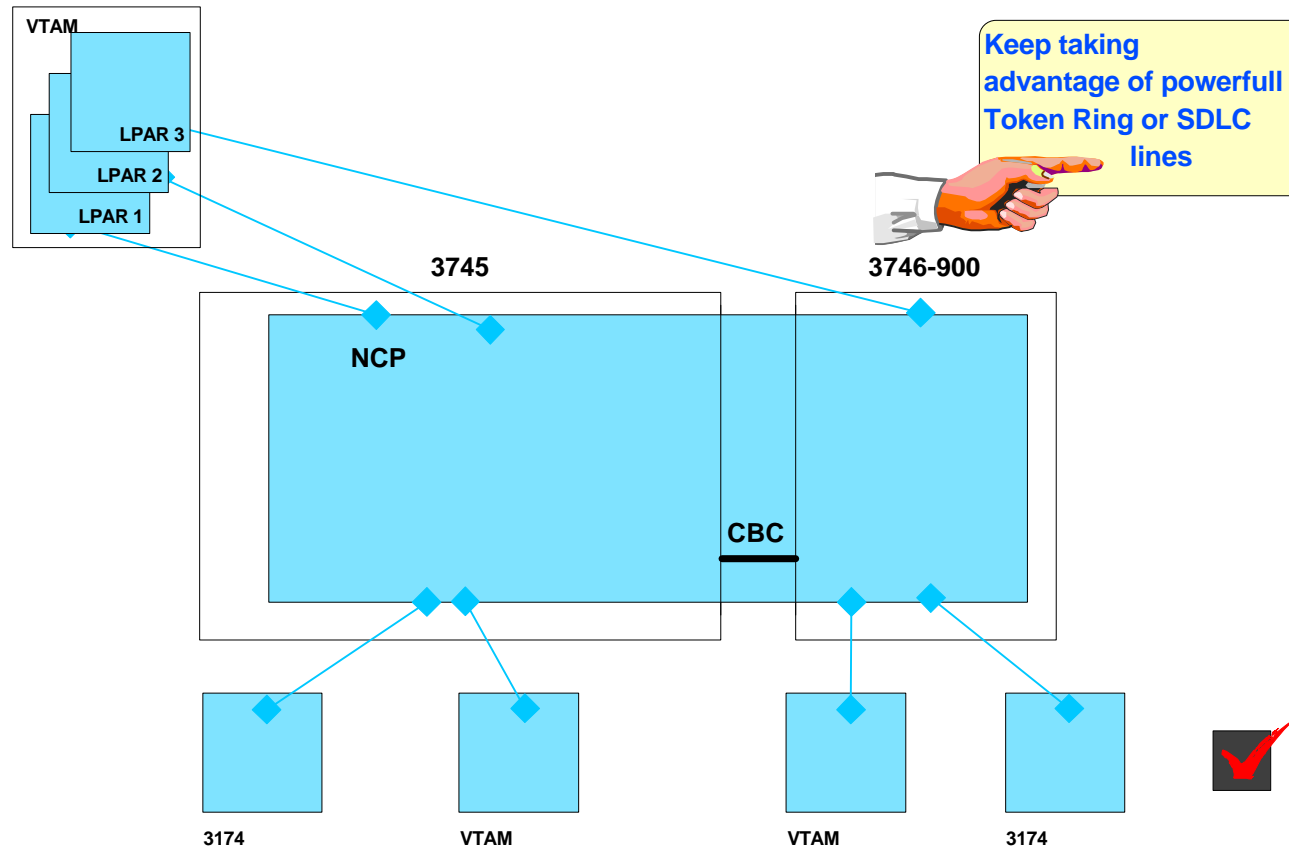

Evolution from 3745 to 3746-950 (6)

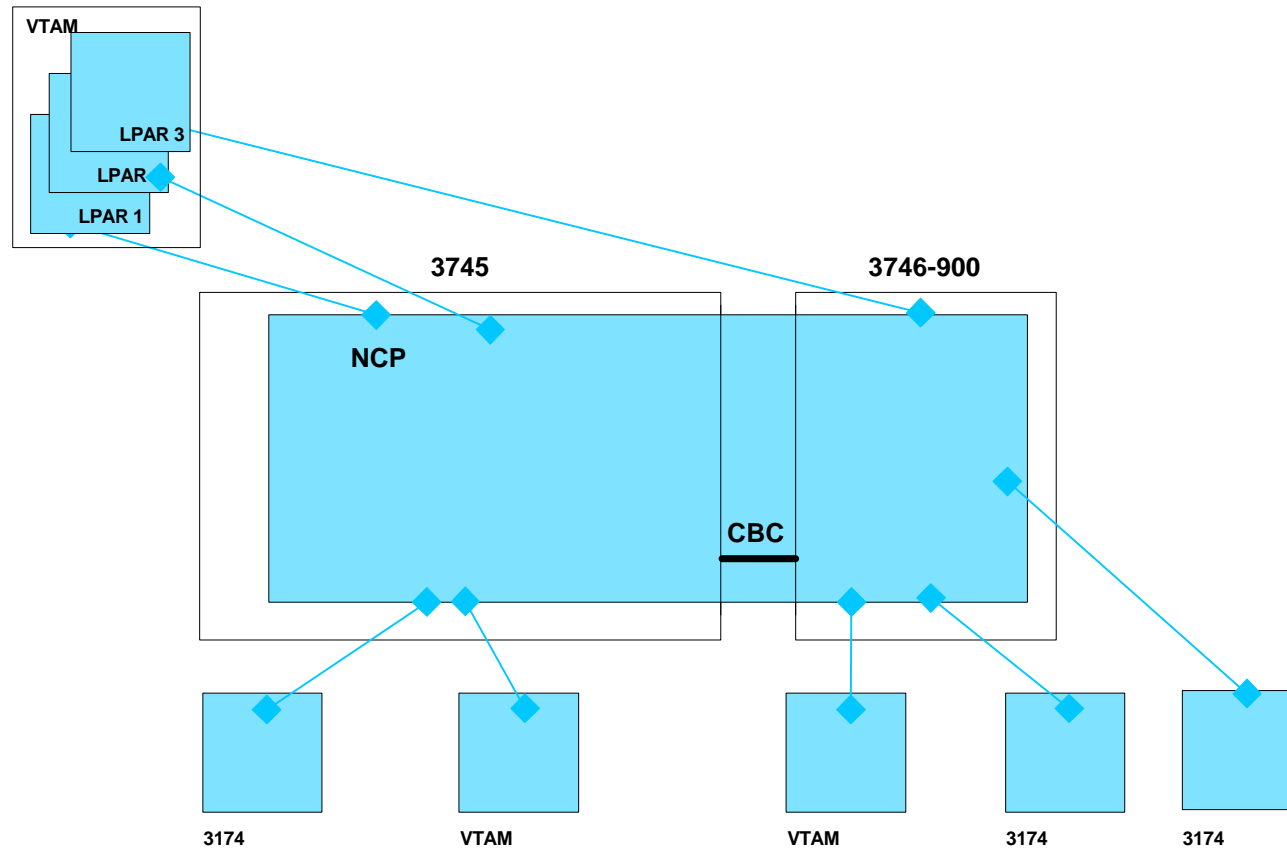

Evolution from 3745 to 3746-950 (6)

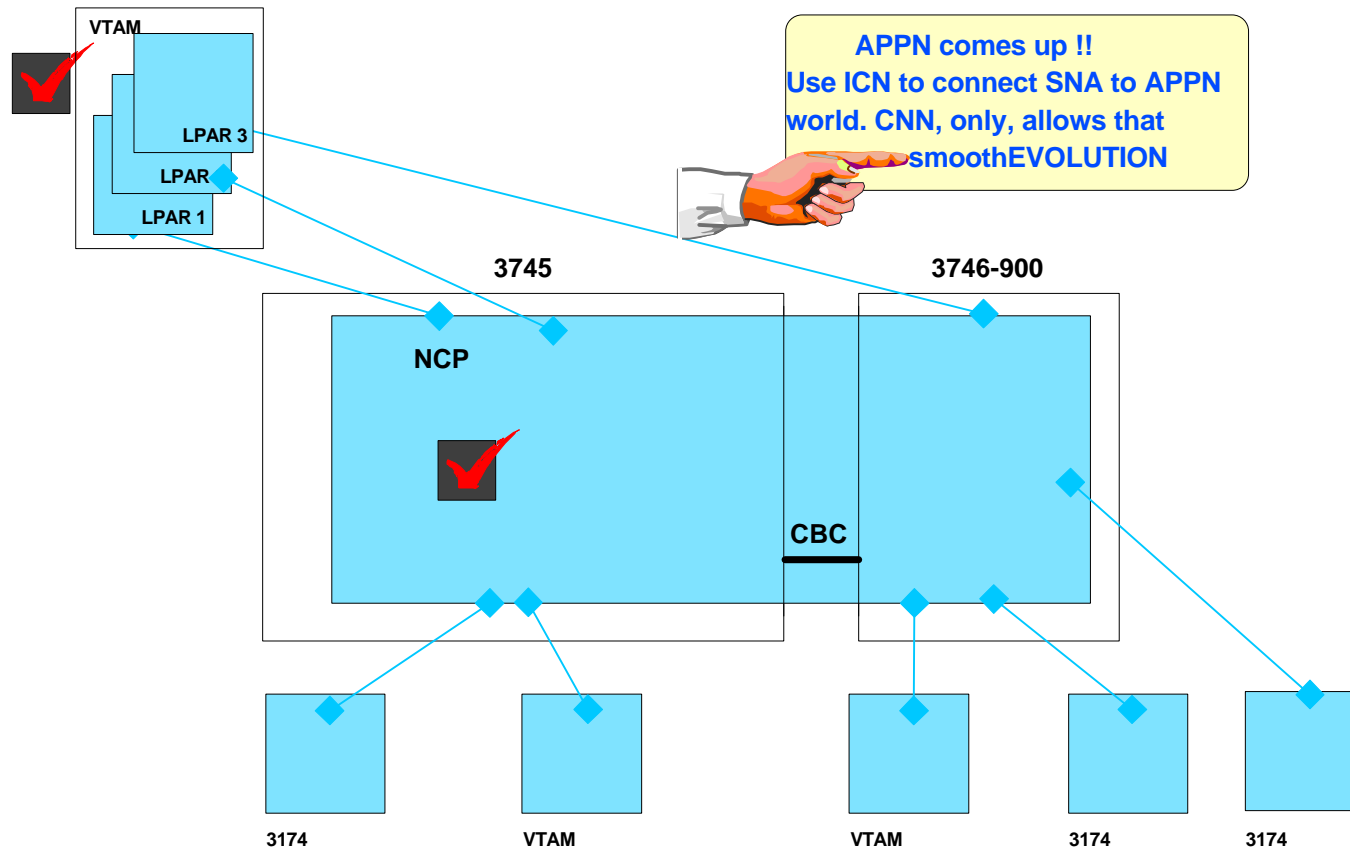

Evolution from 3745 to 3746-950 (7)

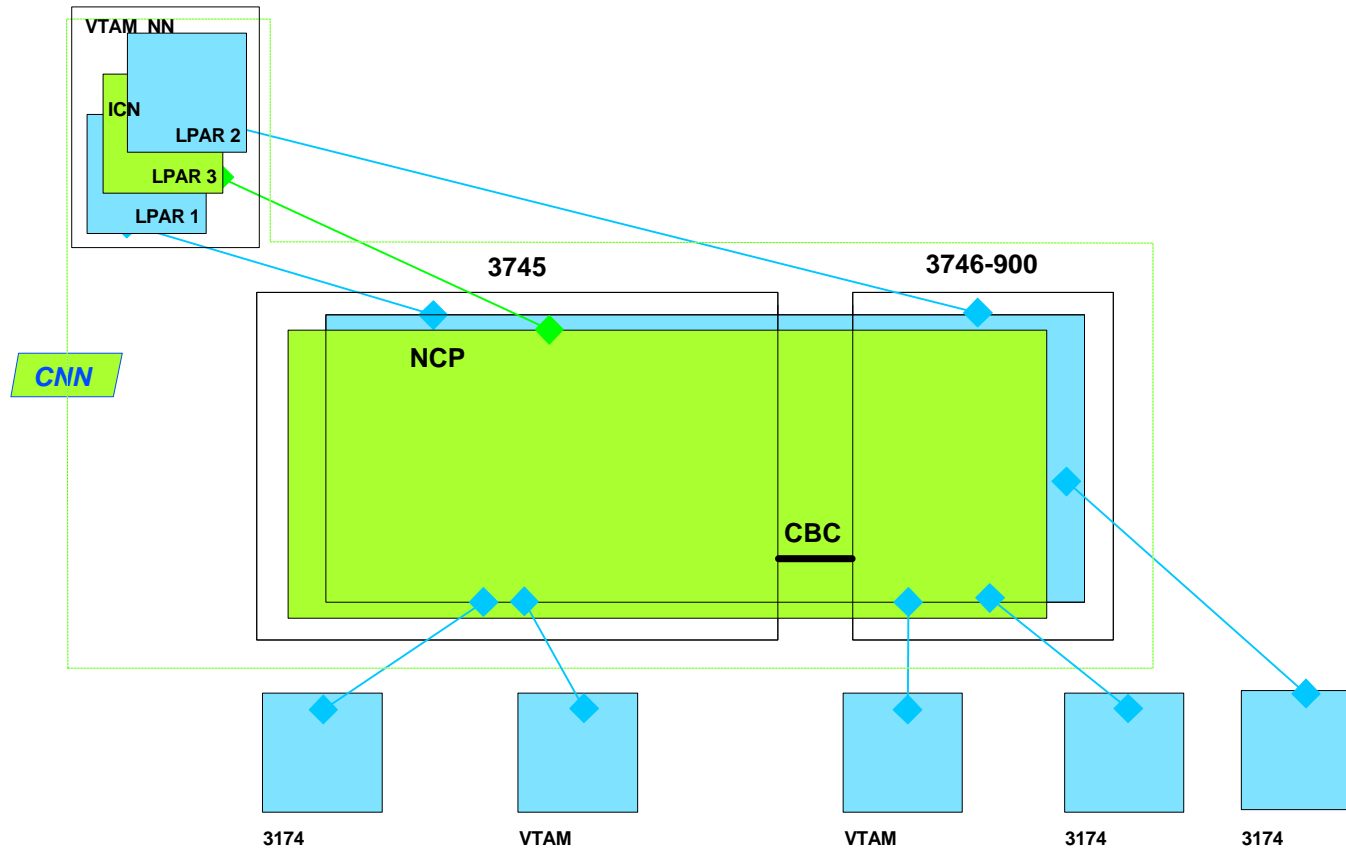

Evolution from 3745 to 3746-950 (7)

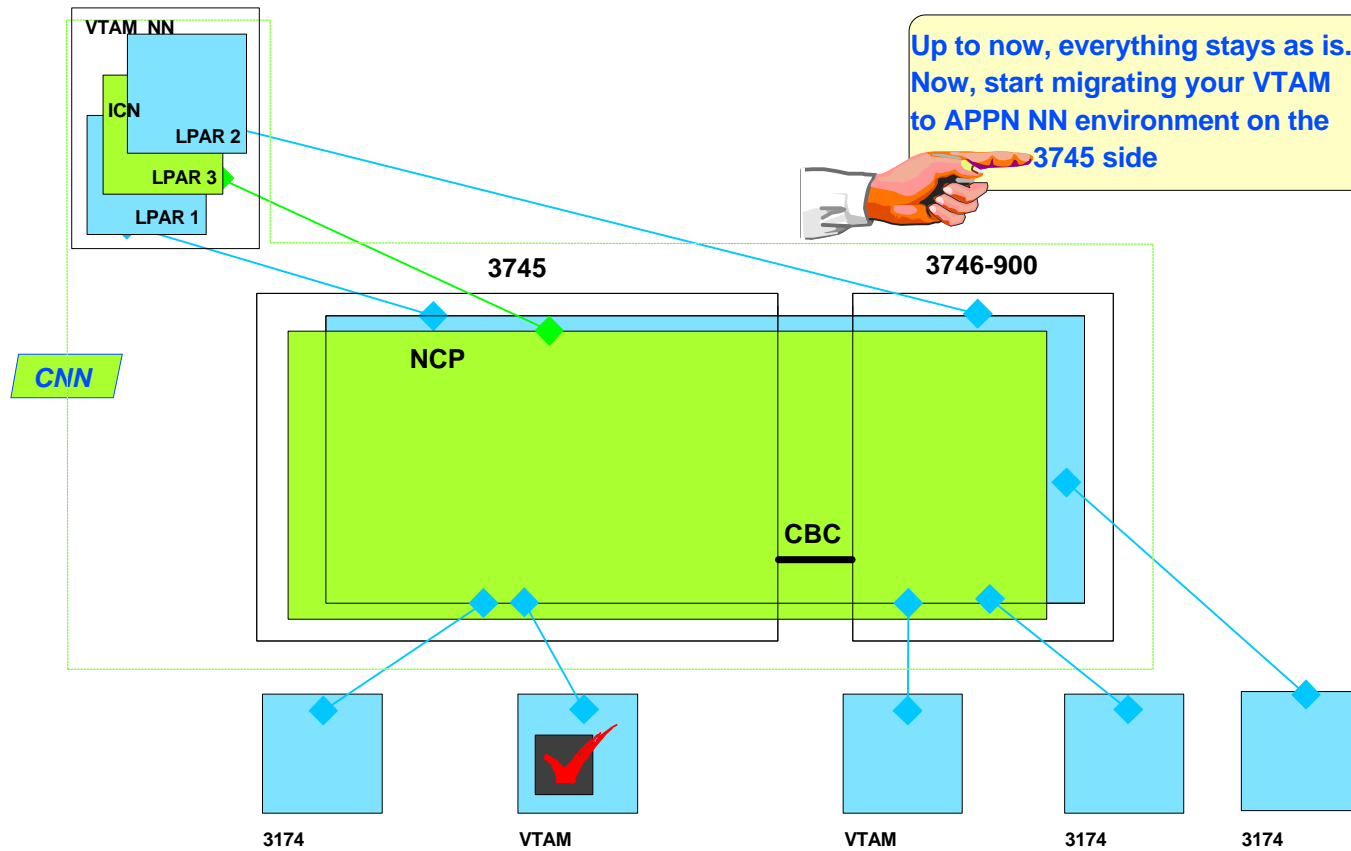

Evolution from 3745 to 3746-950 (8)

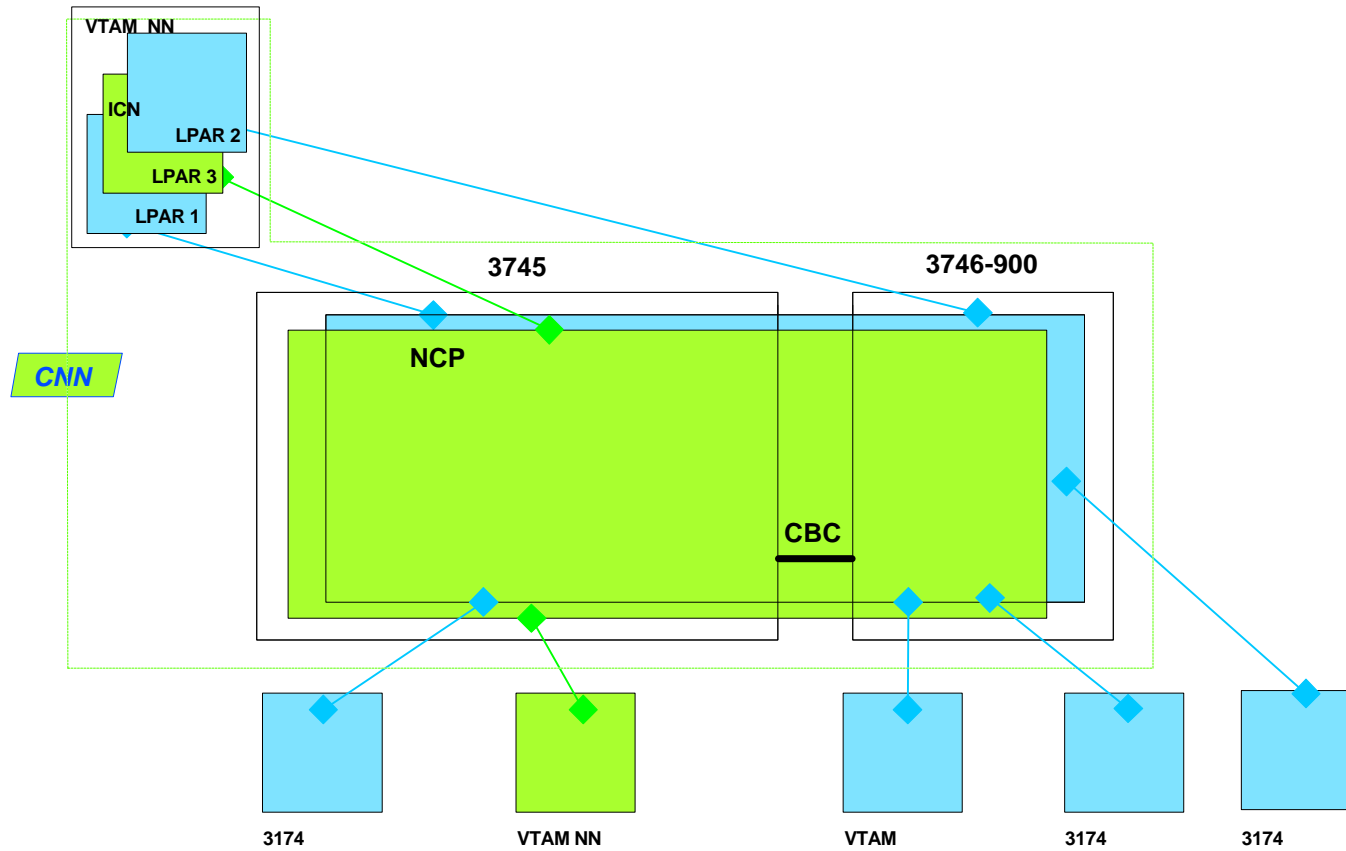

Evolution from 3745 to 3746-950 (8)

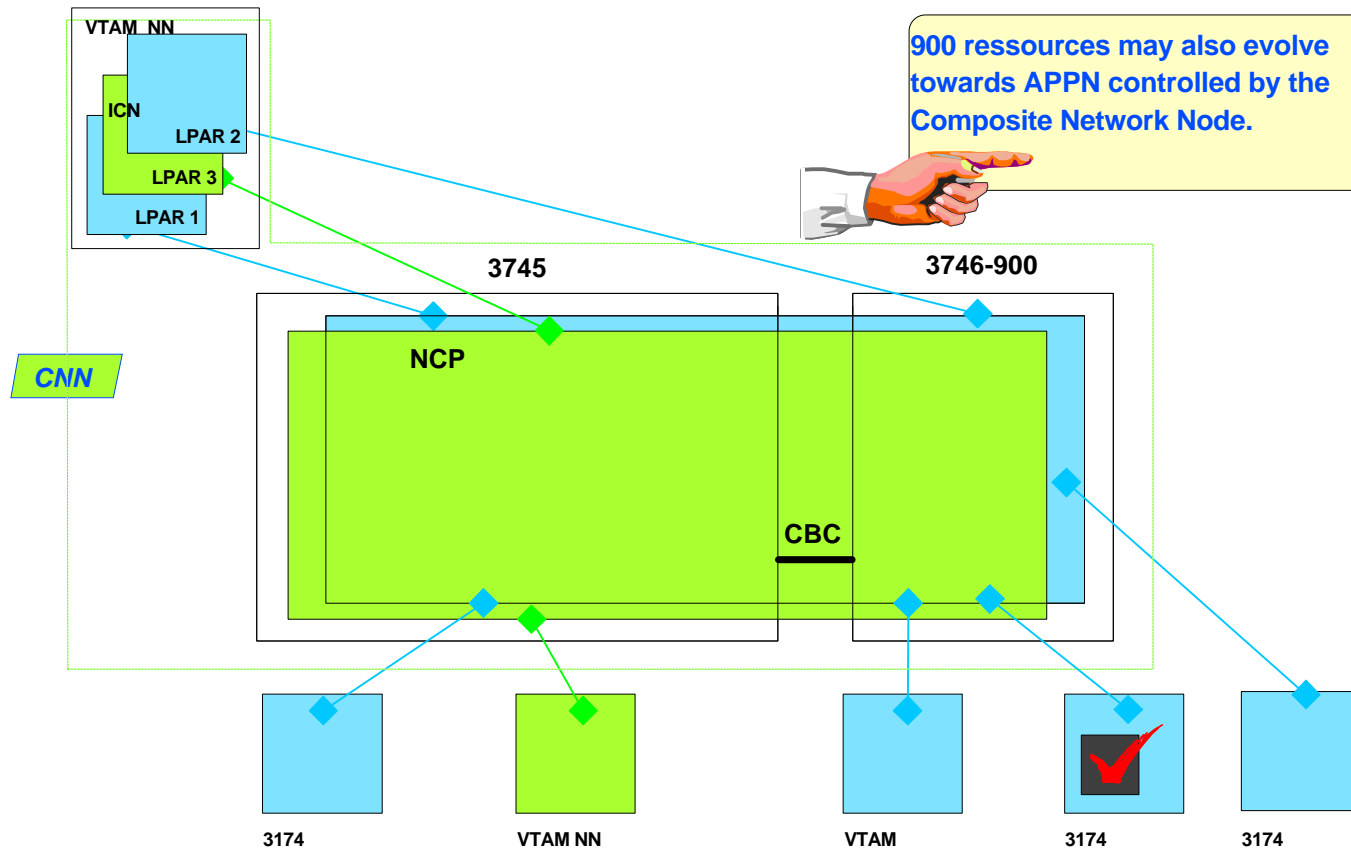

Evolution from 3745 to 3746-950 (9)

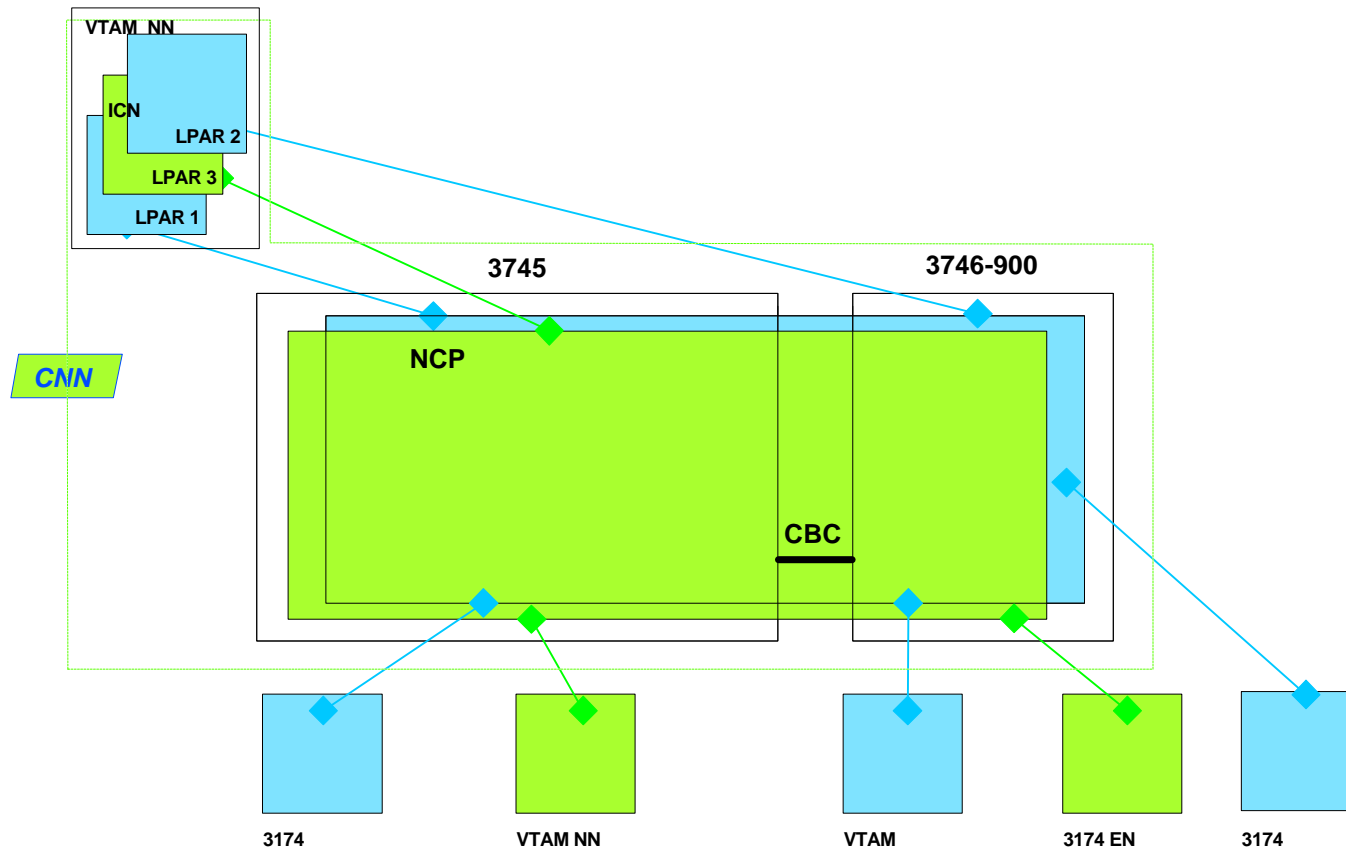

Evolution from 3745 to 3746-950 (9)

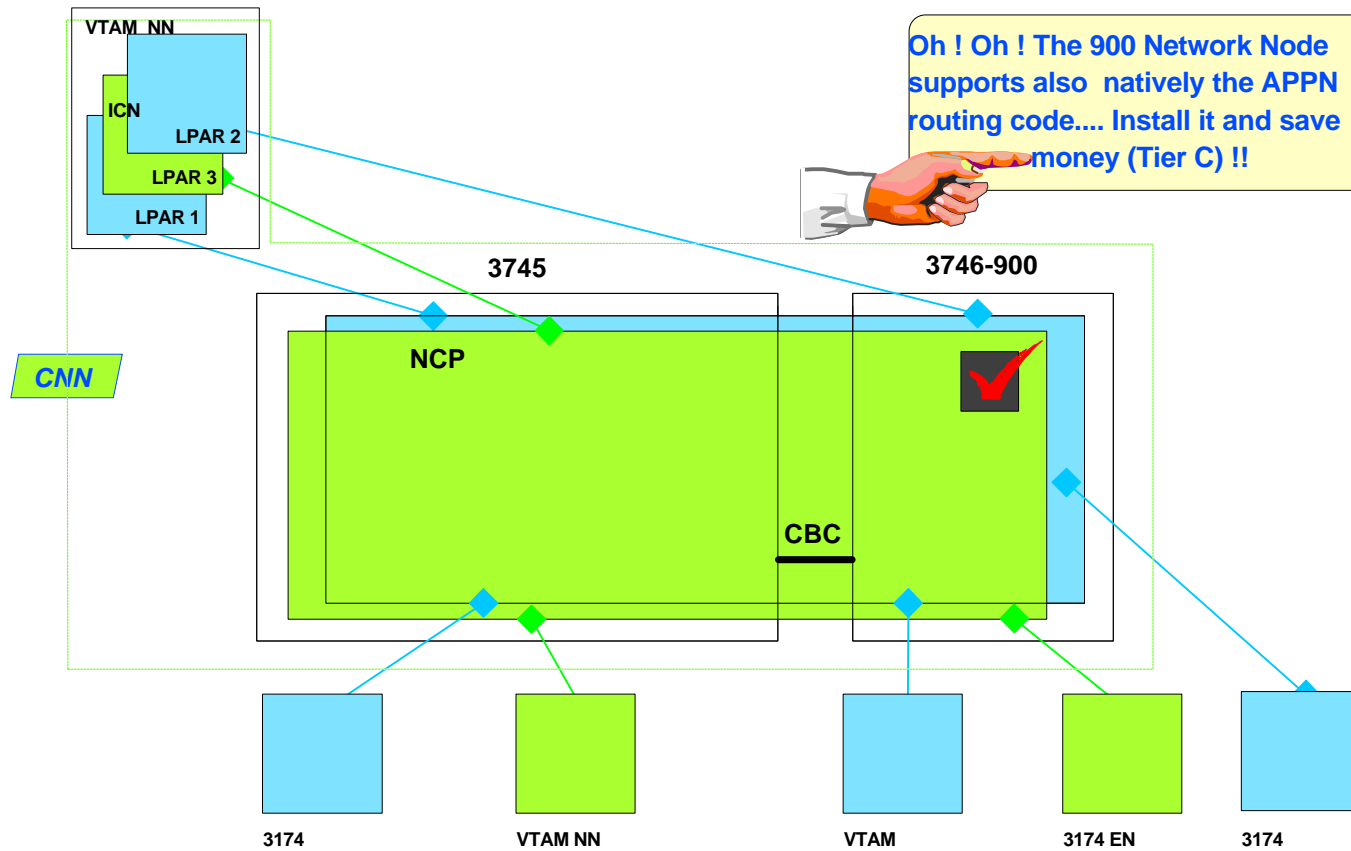

Evolution from 3745 to 3746-950 (10)

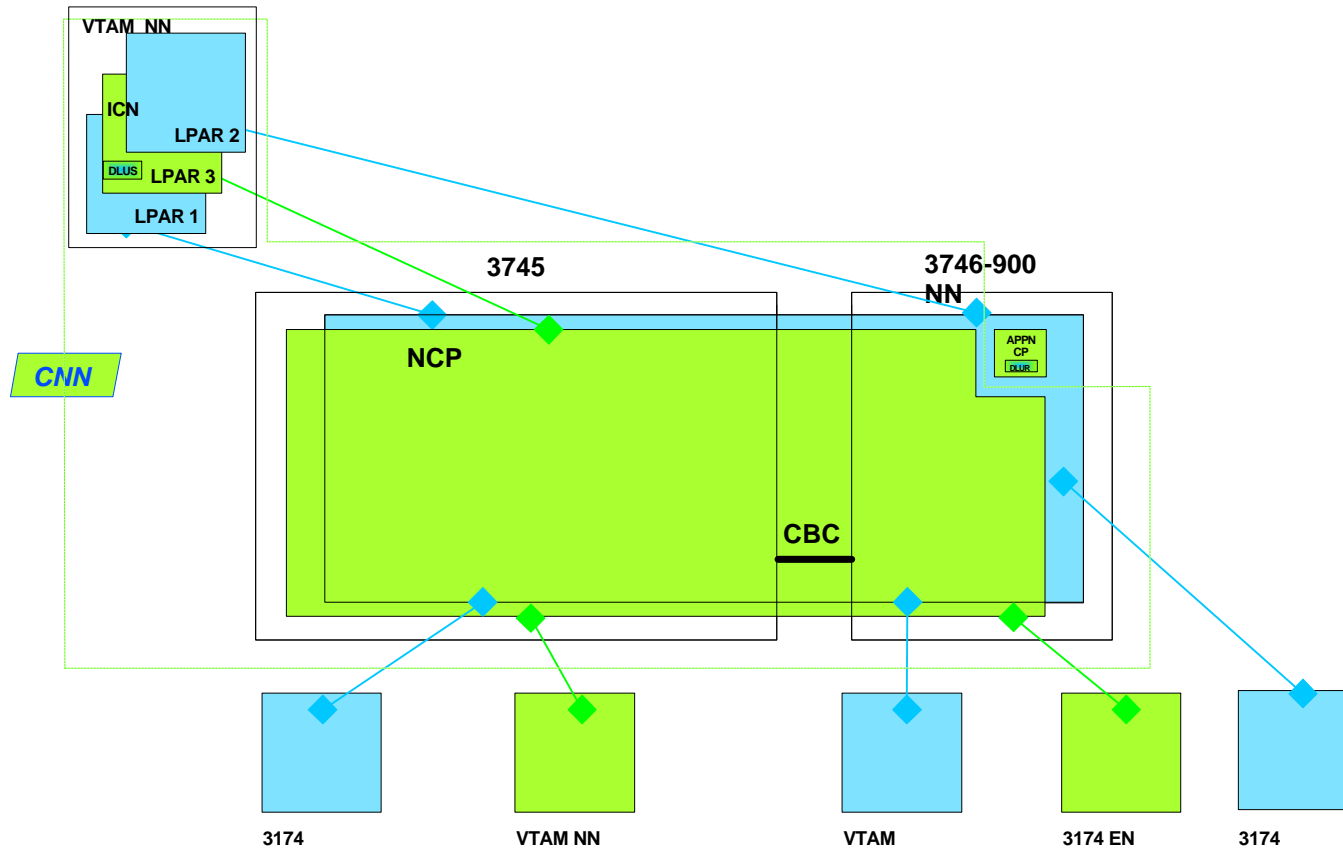

Evolution from 3745 to 3746-950 (10)

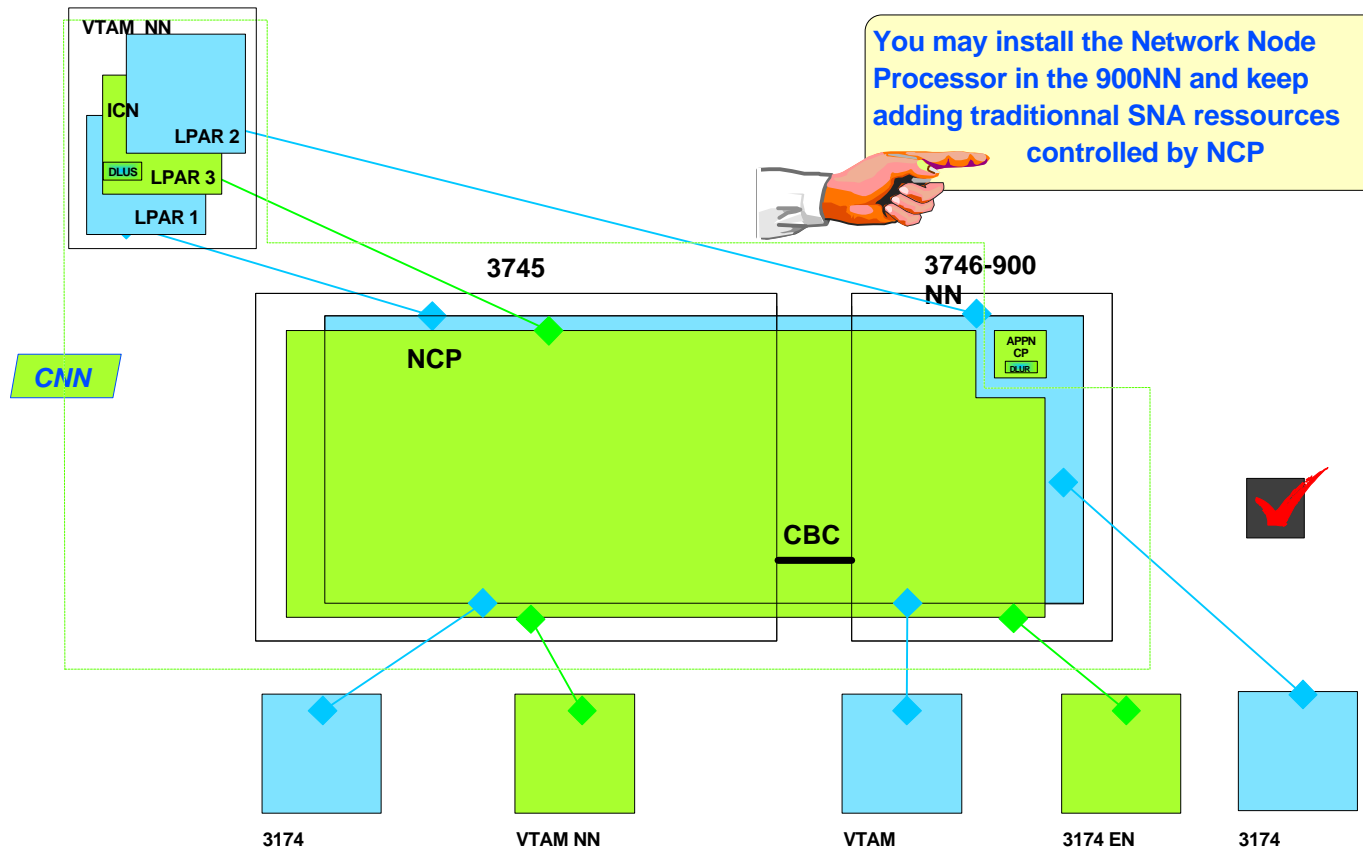

Evolution from 3745 to 3746-950 (11)

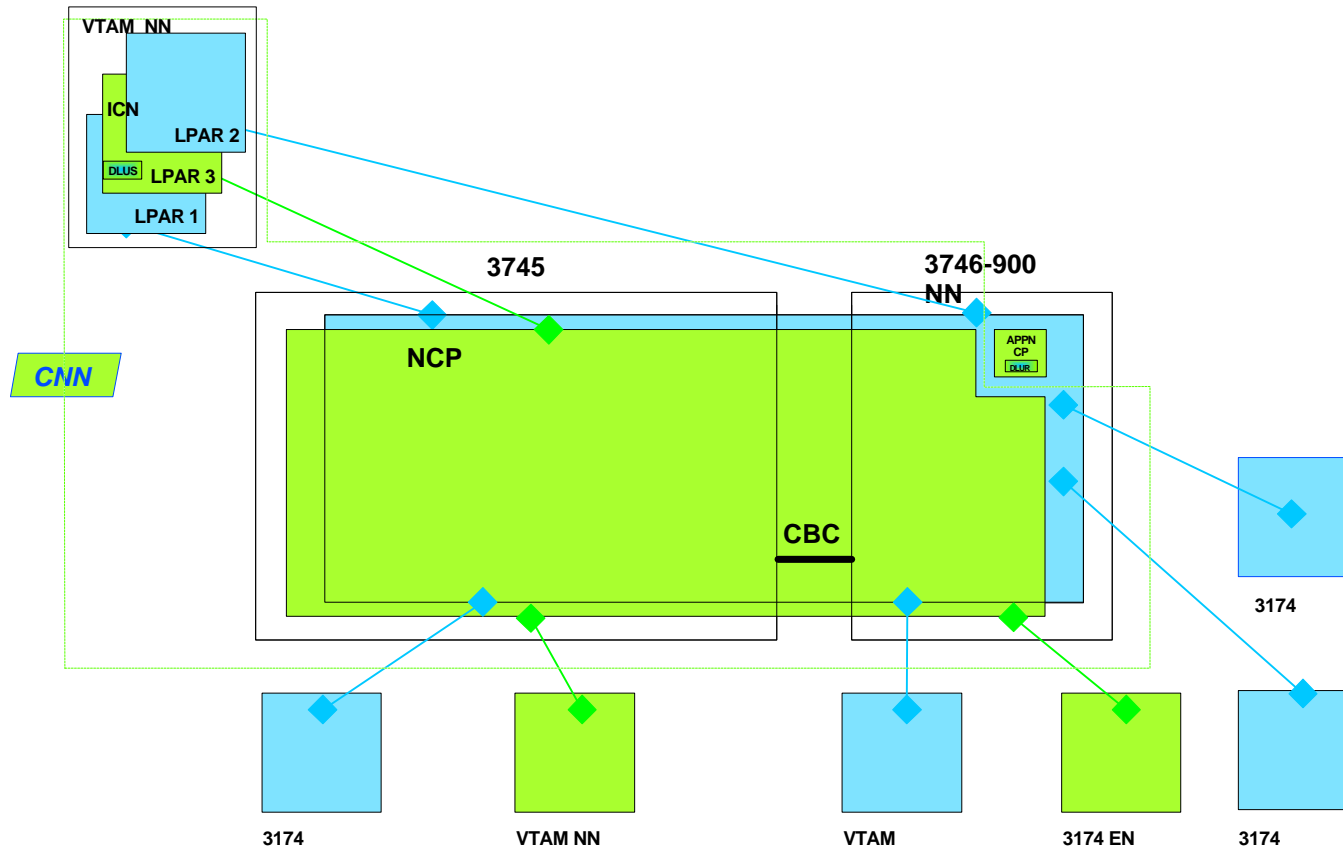

Evolution from 3745 to 3746-950 (11)

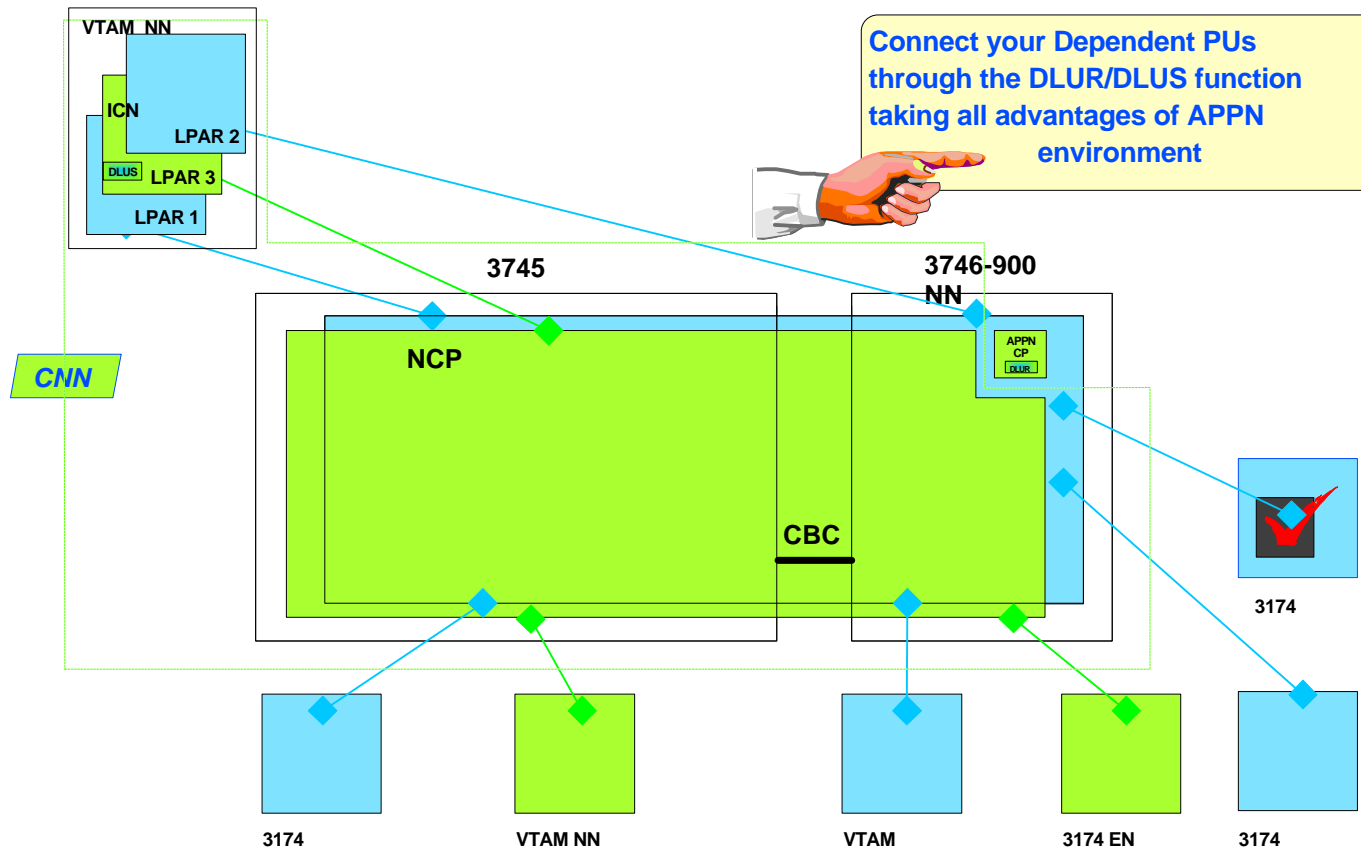

Evolution from 3745 to 3746-950 (12)

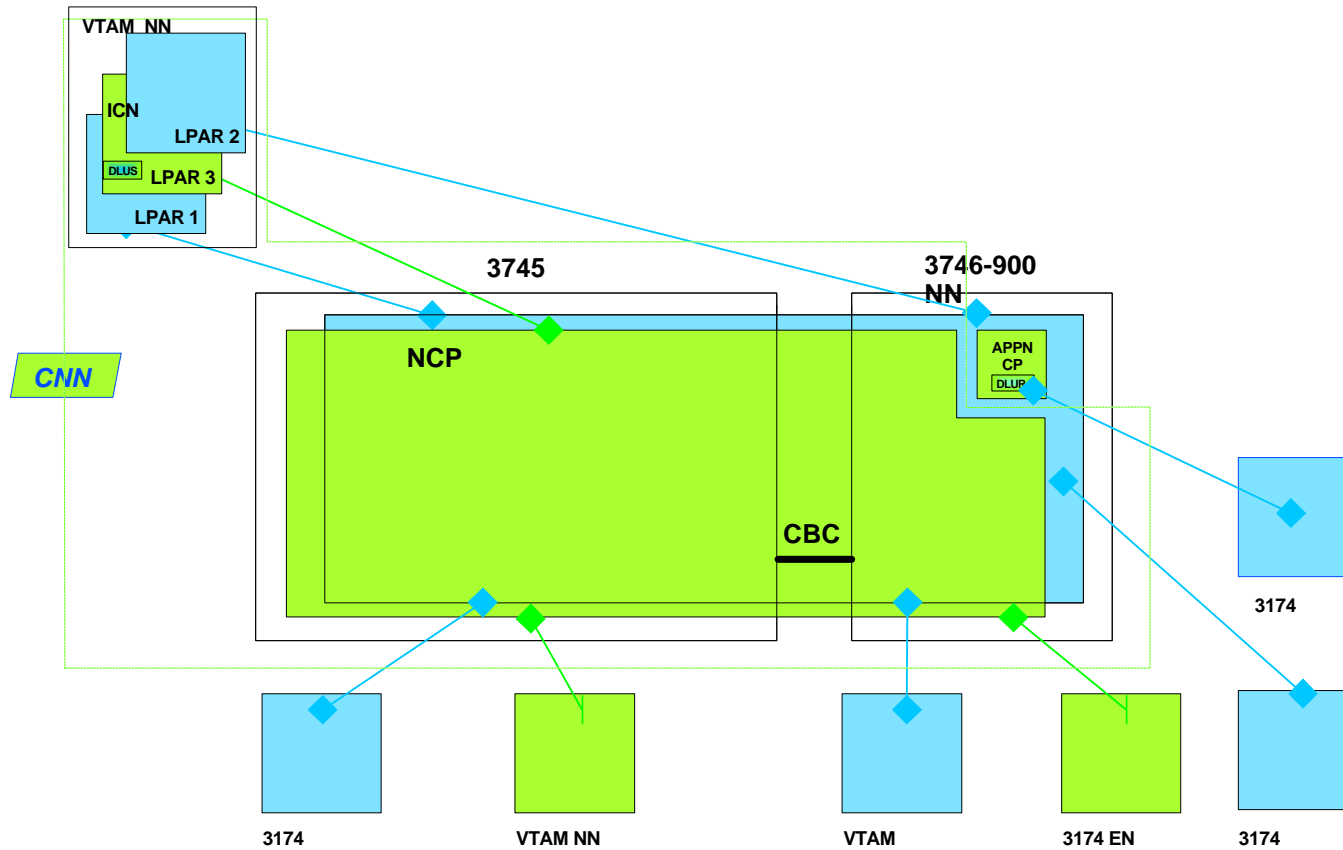

Evolution from 3745 to 3746-950 (12)

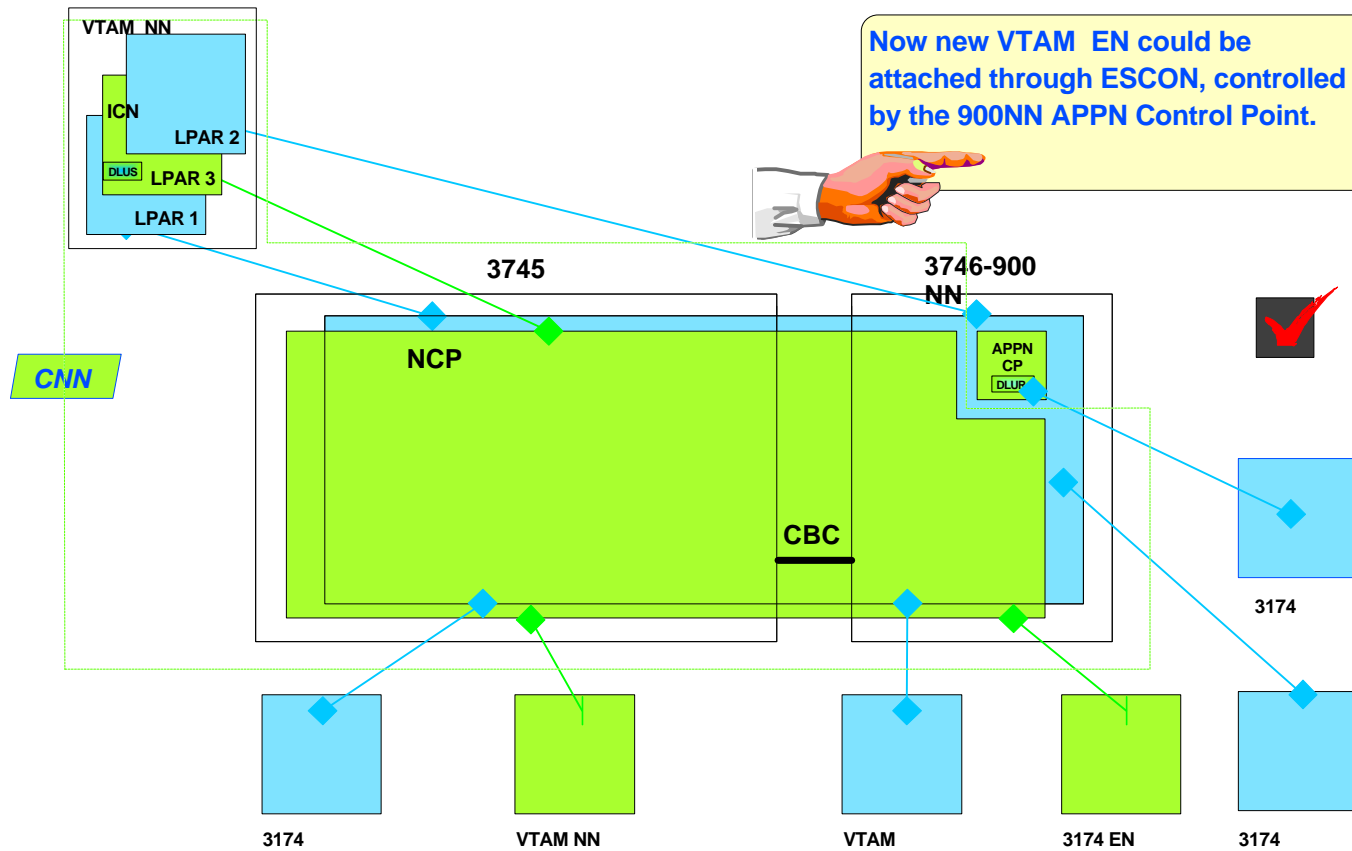

Evolution from 3745 to 3746-950 (13)

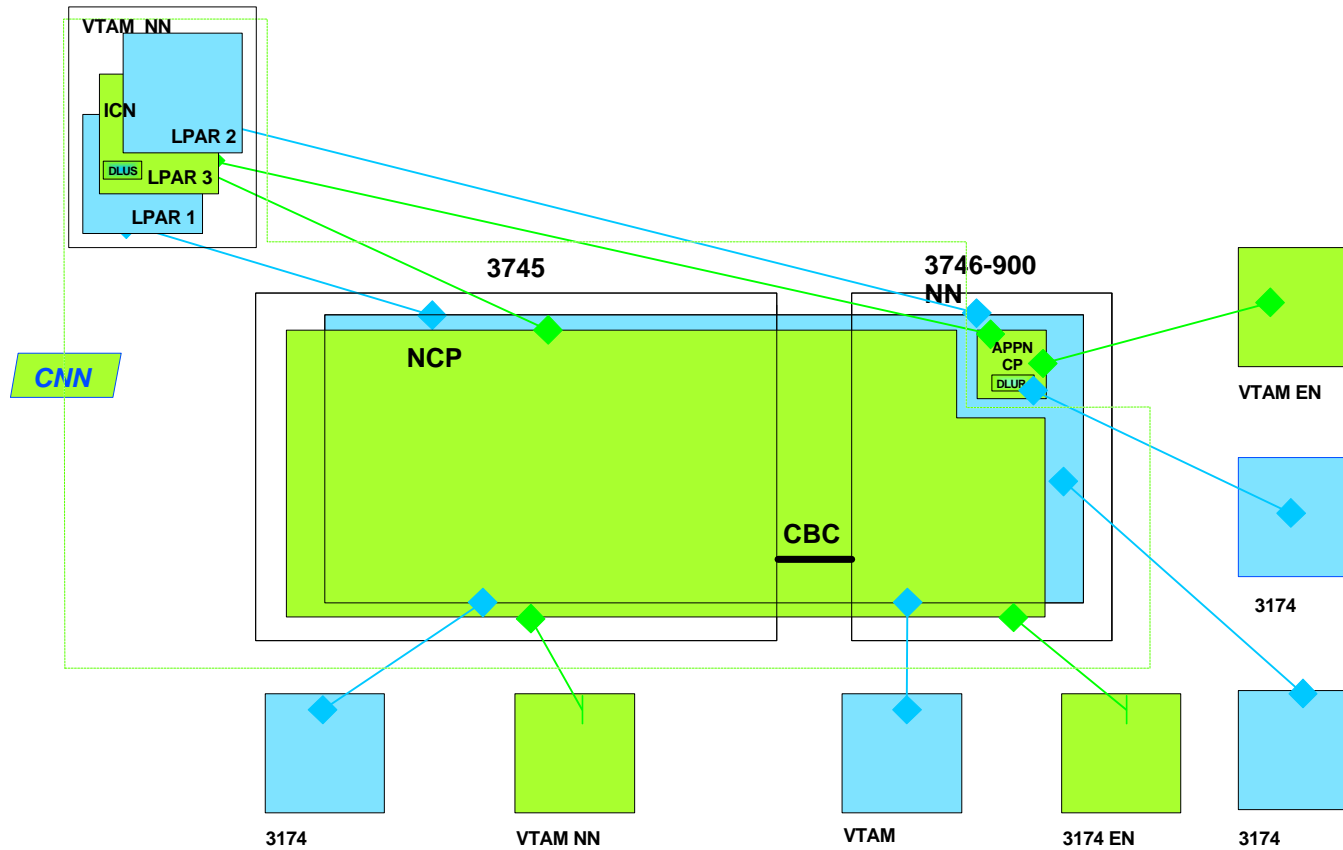

Evolution from 3745 to 3746-950 (13)

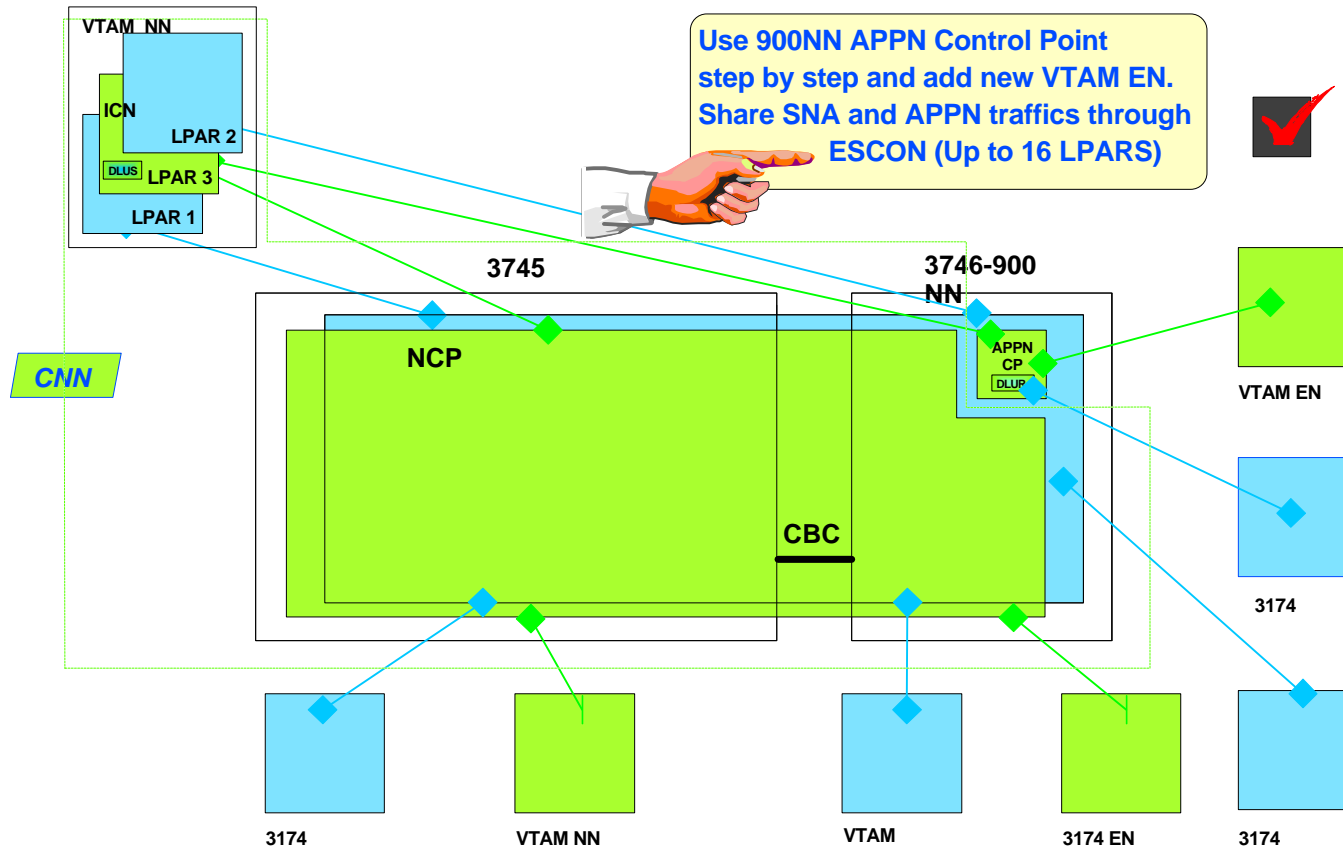

Evolution from 3745 to 3746-950 (14)

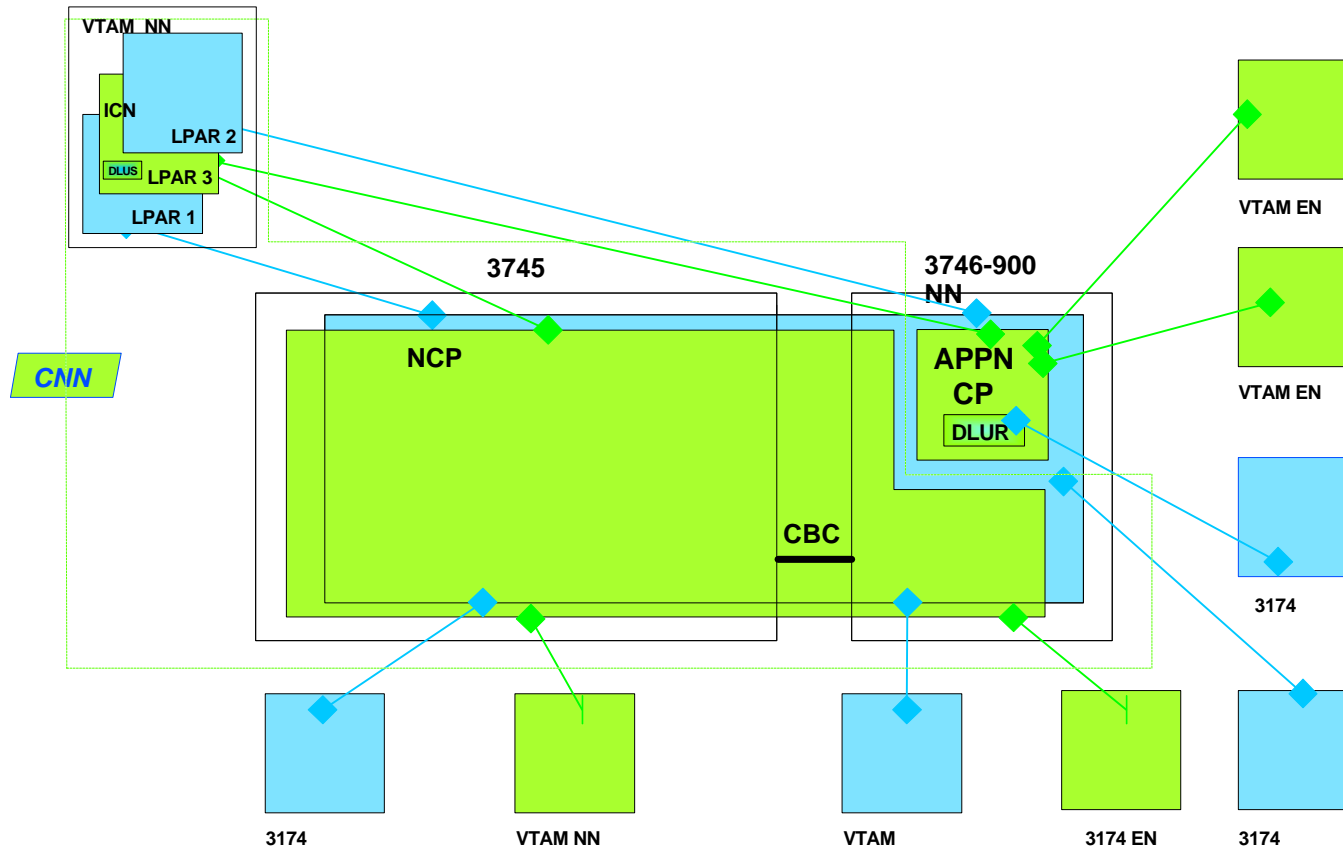

Evolution from 3745 to 3746-950 (14)

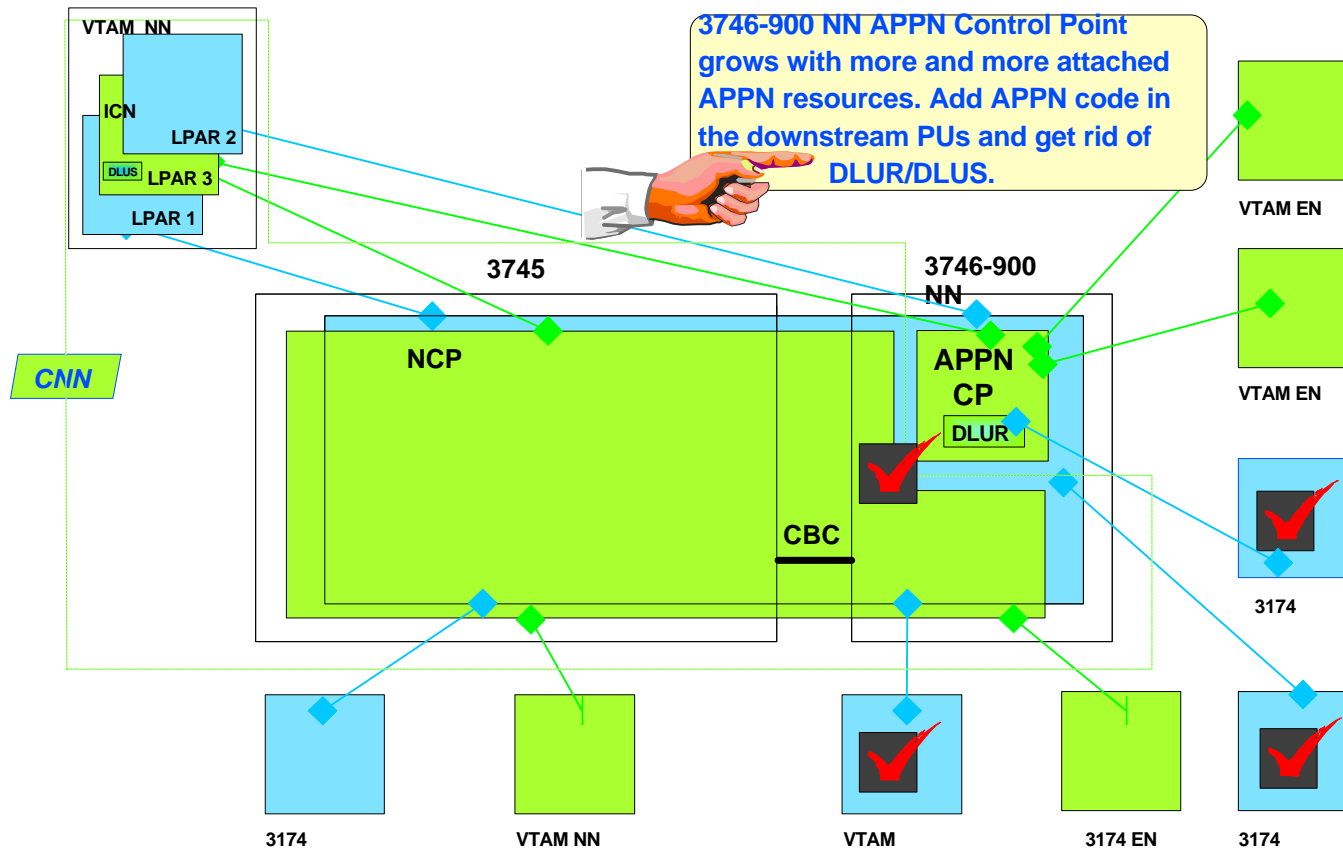

Evolution from 3745 to 3746-950 (15)

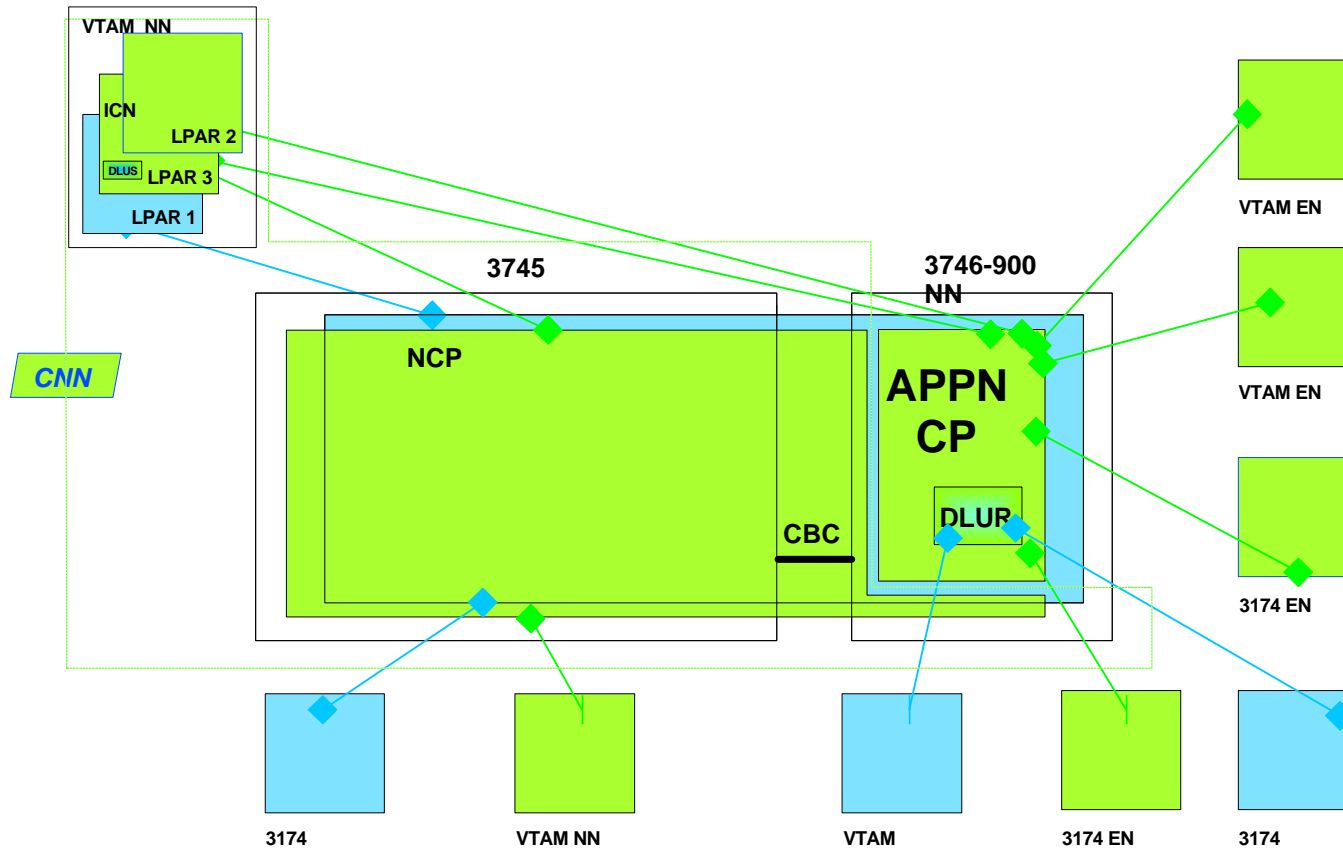

Evolution from 3745 to 3746-950 (15)

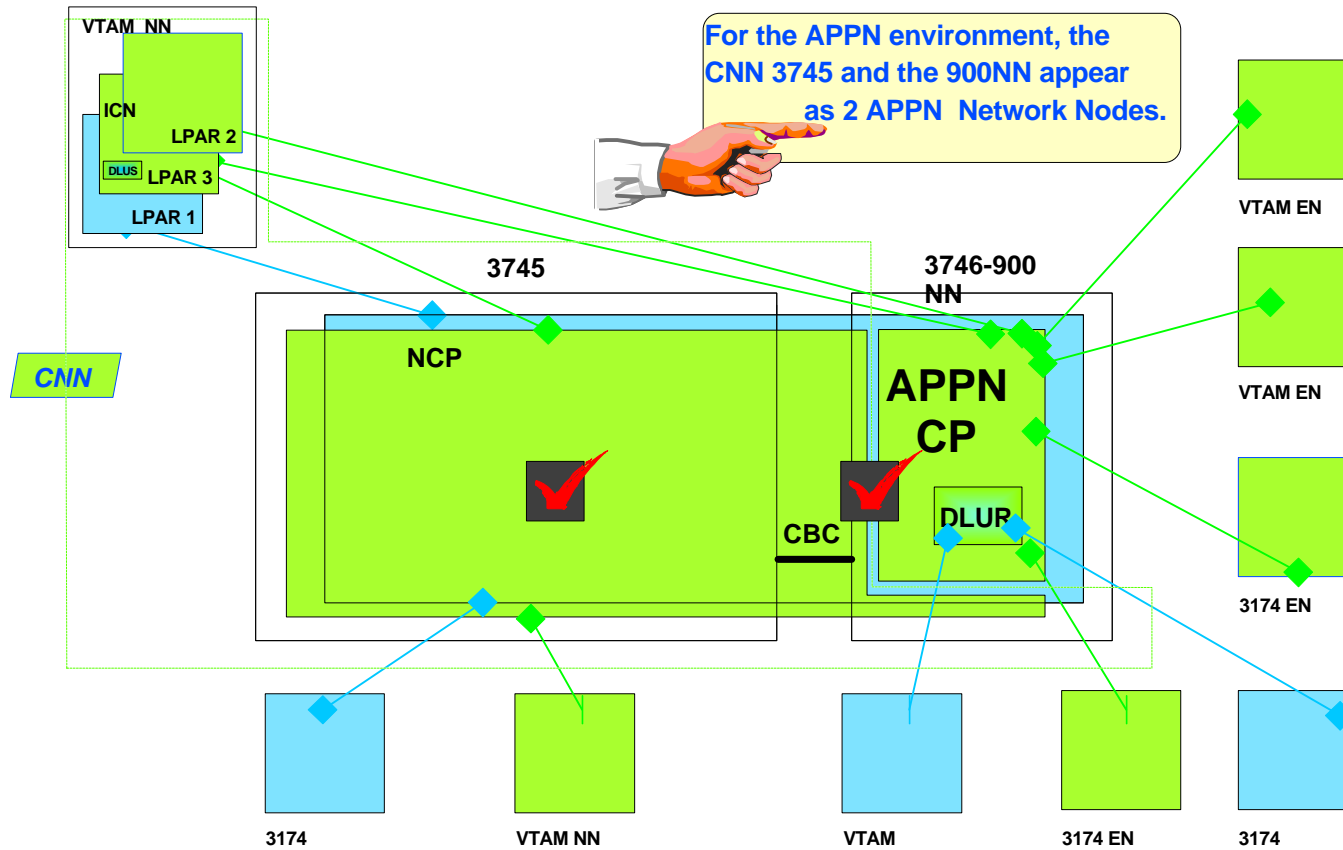
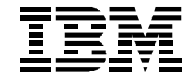

Evolution from 3745 to 3746-950 (16)

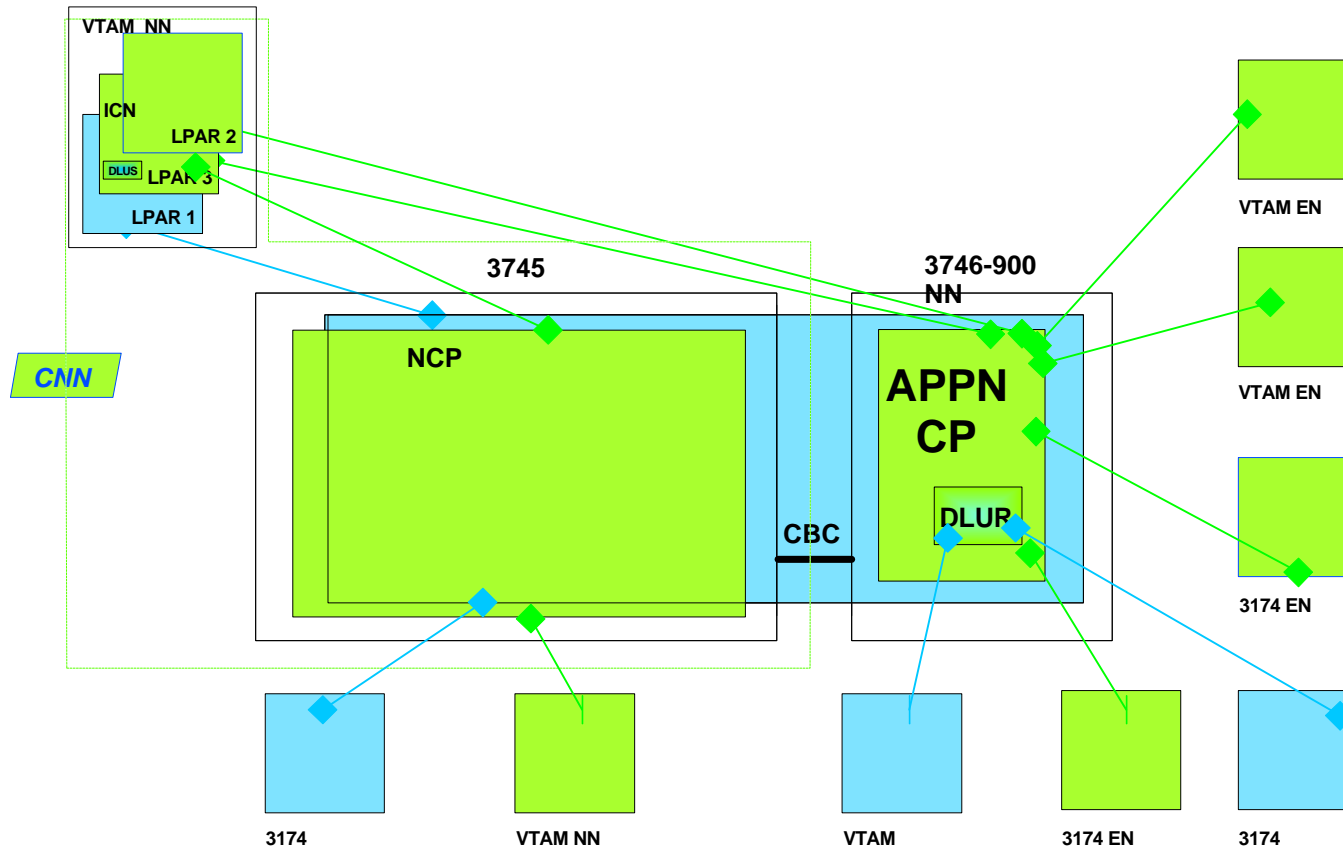

Evolution from 3745 to 3746-950 (16)

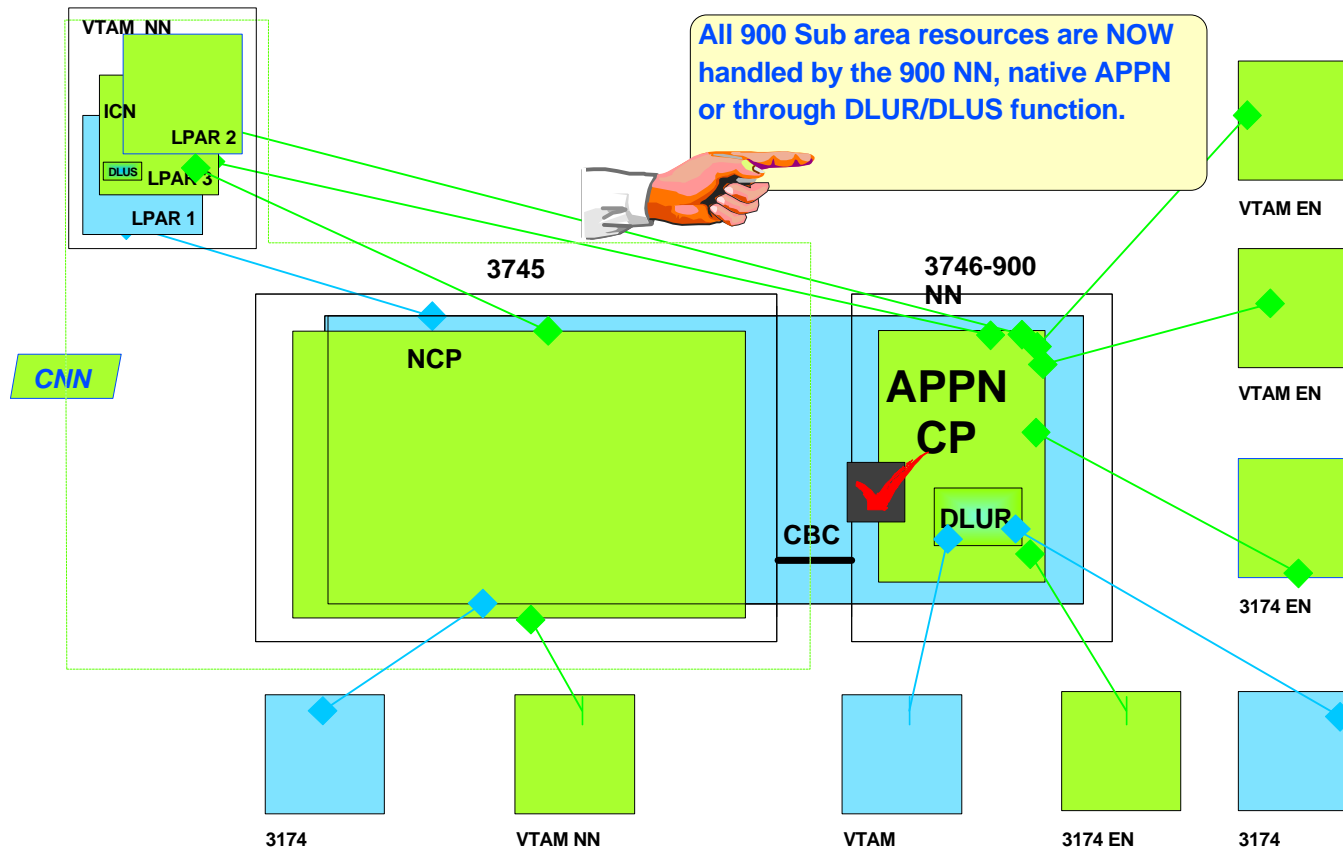

Evolution from 3745 to 3746-950 (17)

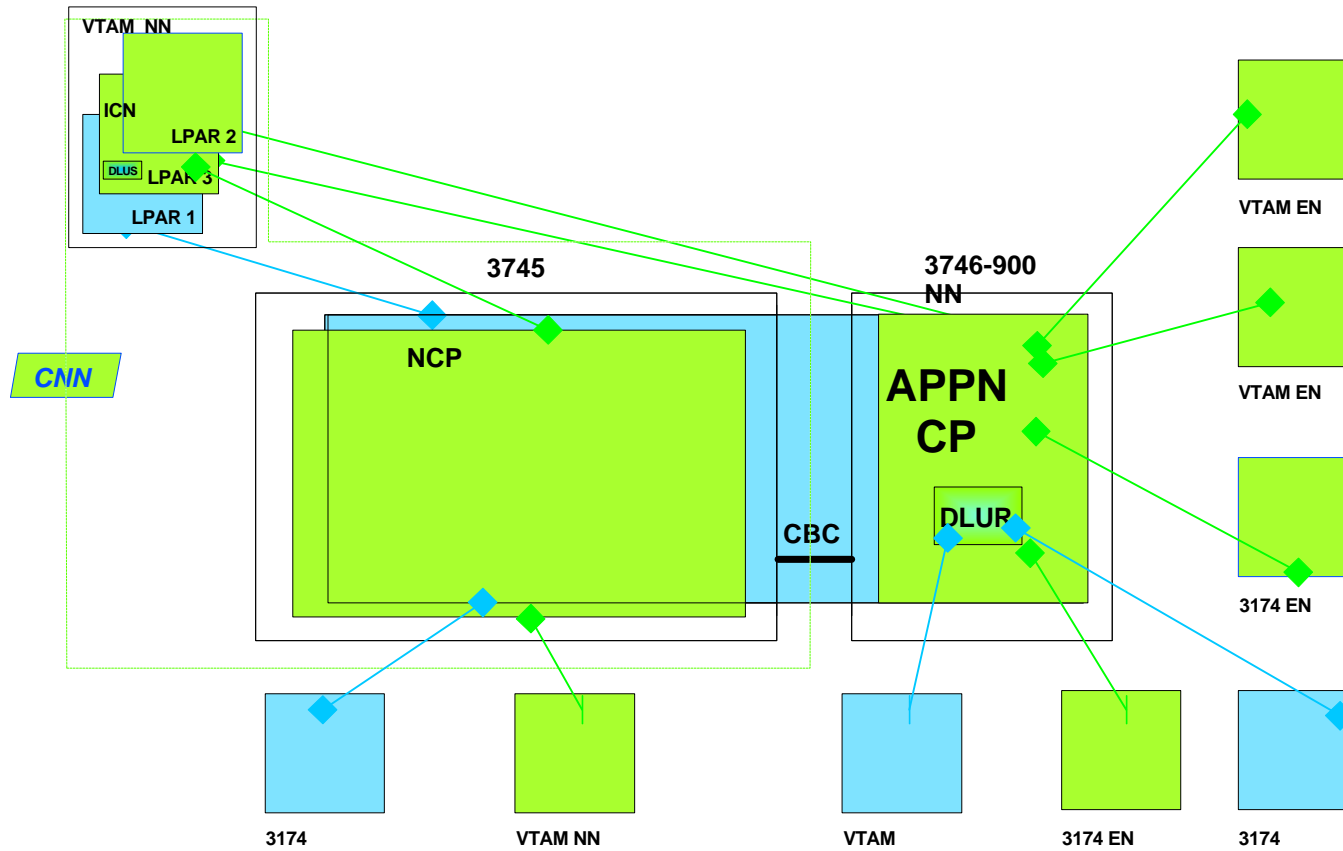

Evolution from 3745 to 3746-950 (17)

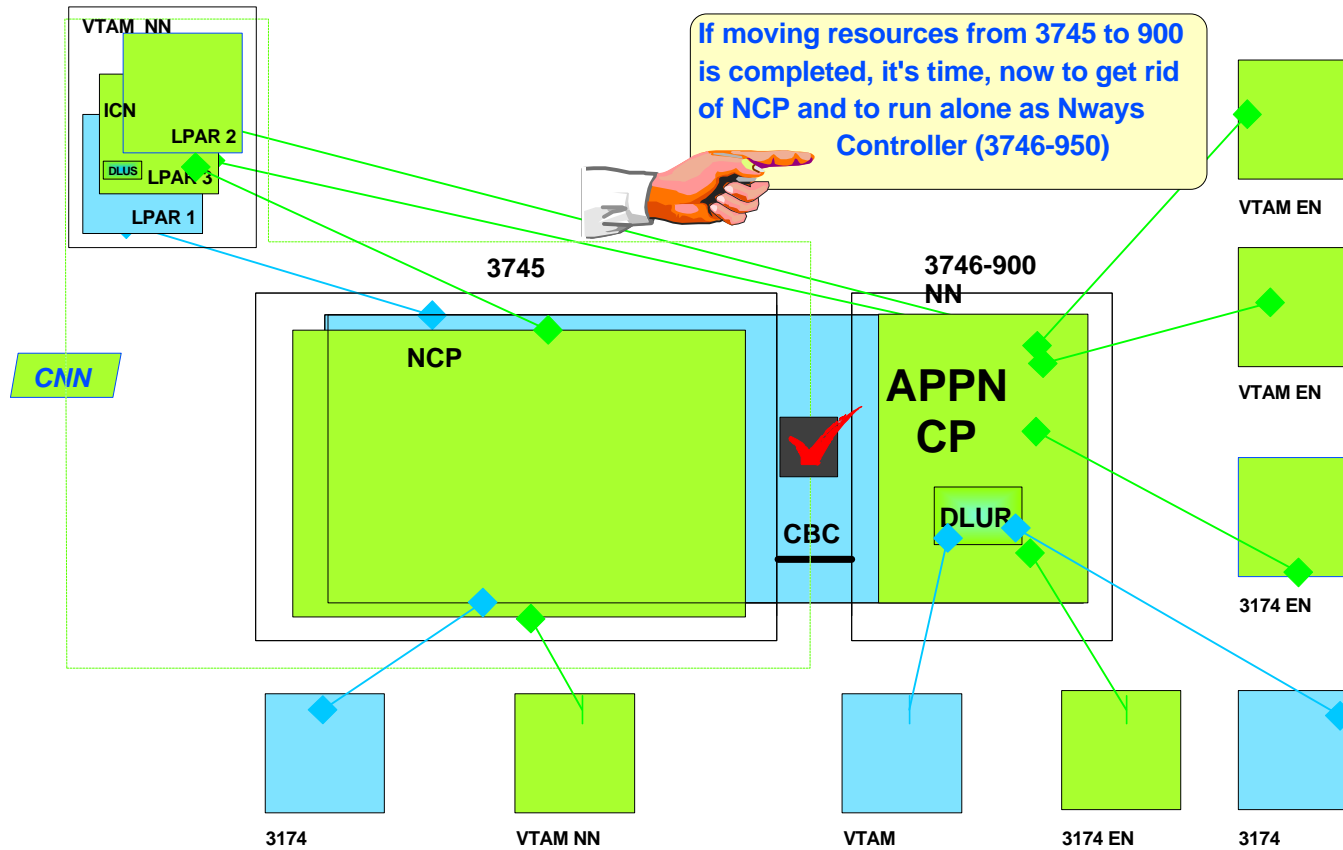

Evolution from 3745 to 3746-950 (18)

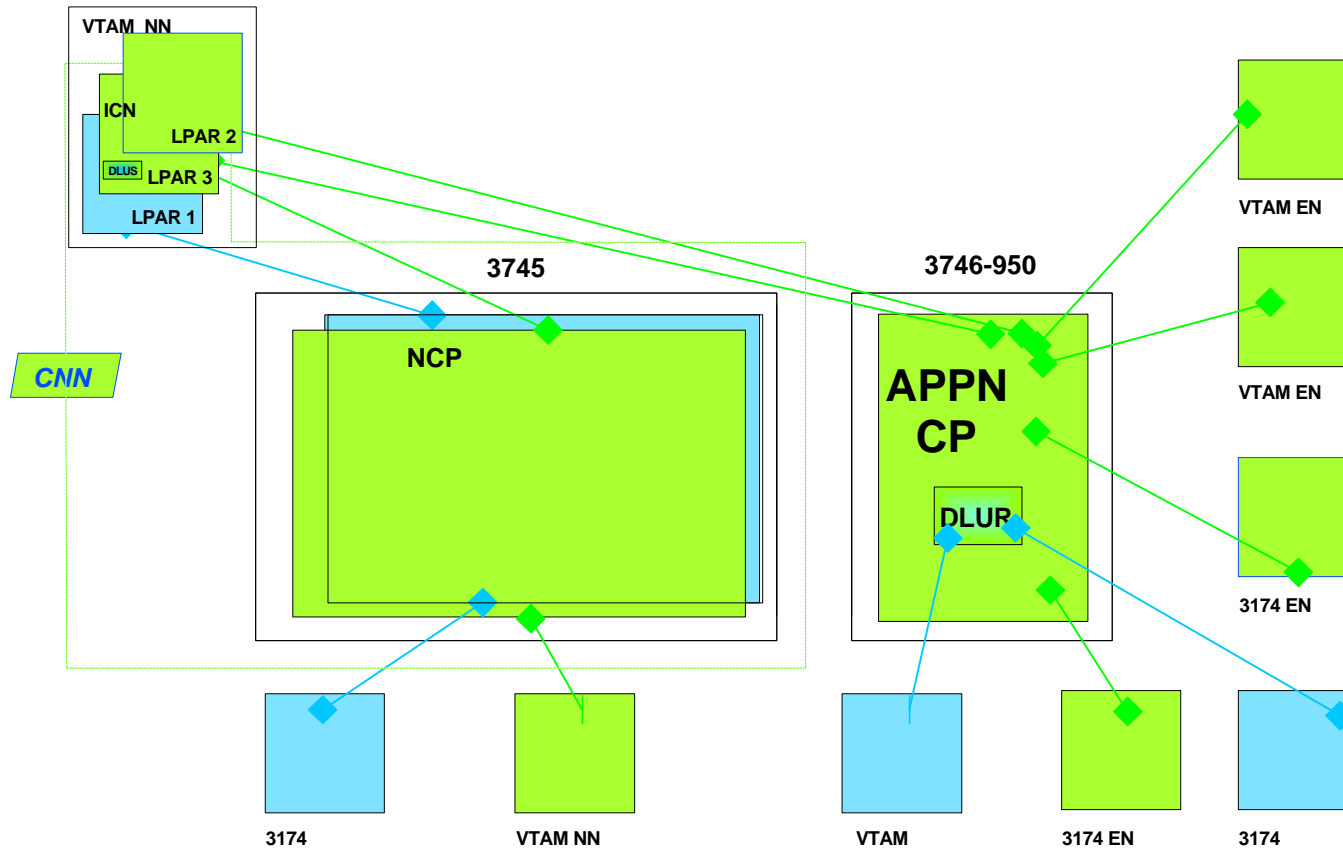

Evolution from 3745 to 3746-950 (18)

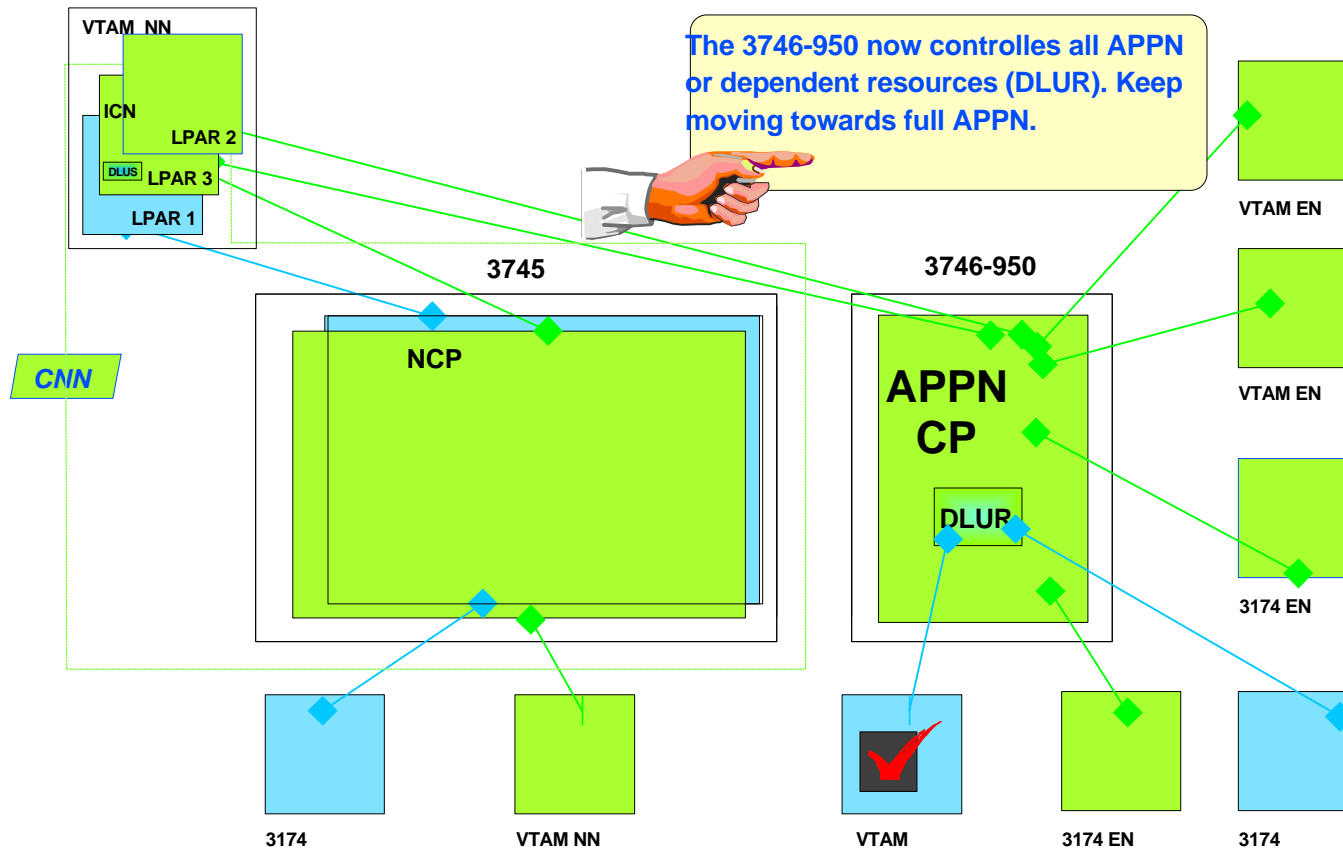

Evolution from 3745 to 3746-950 (19)

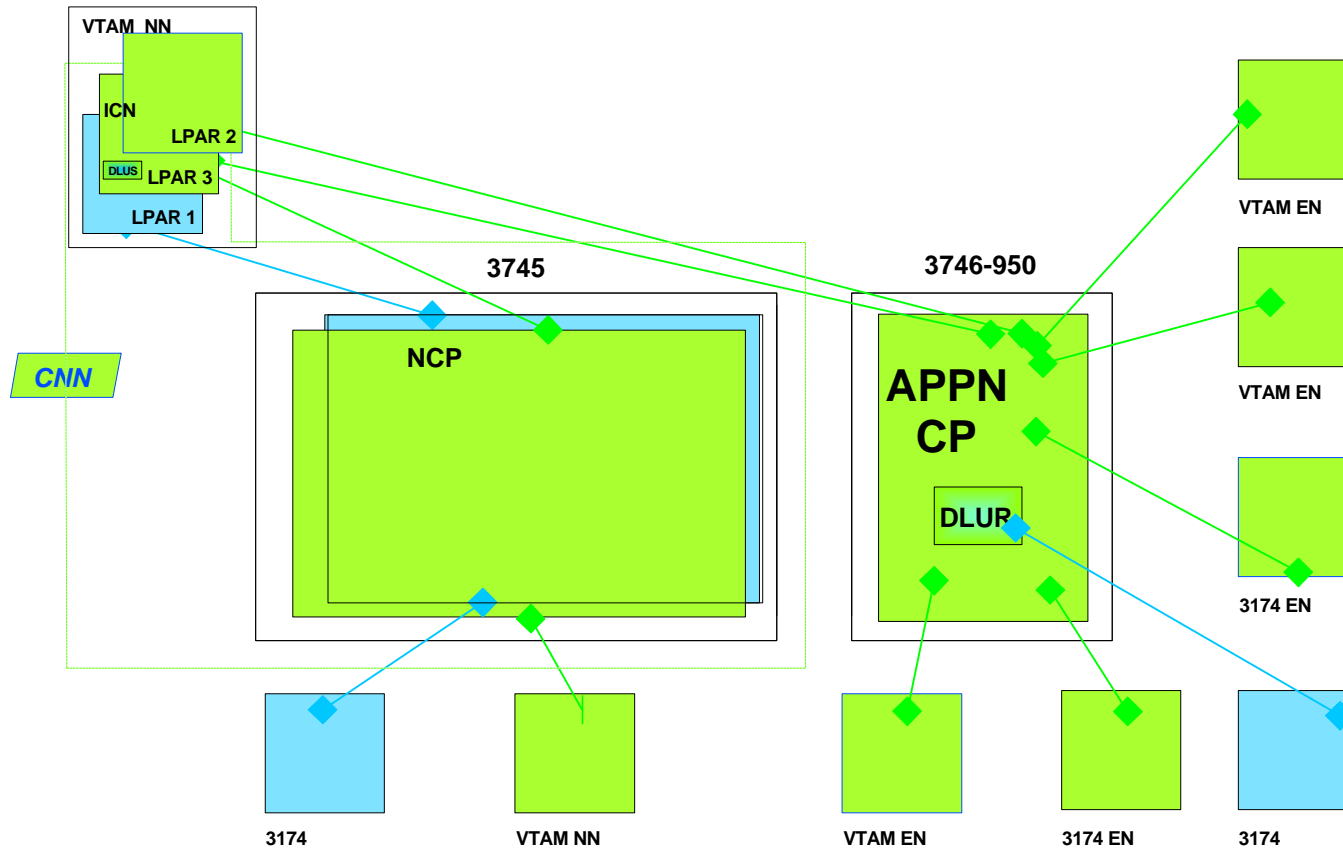

Evolution from 3745 to 3746-950 (19)

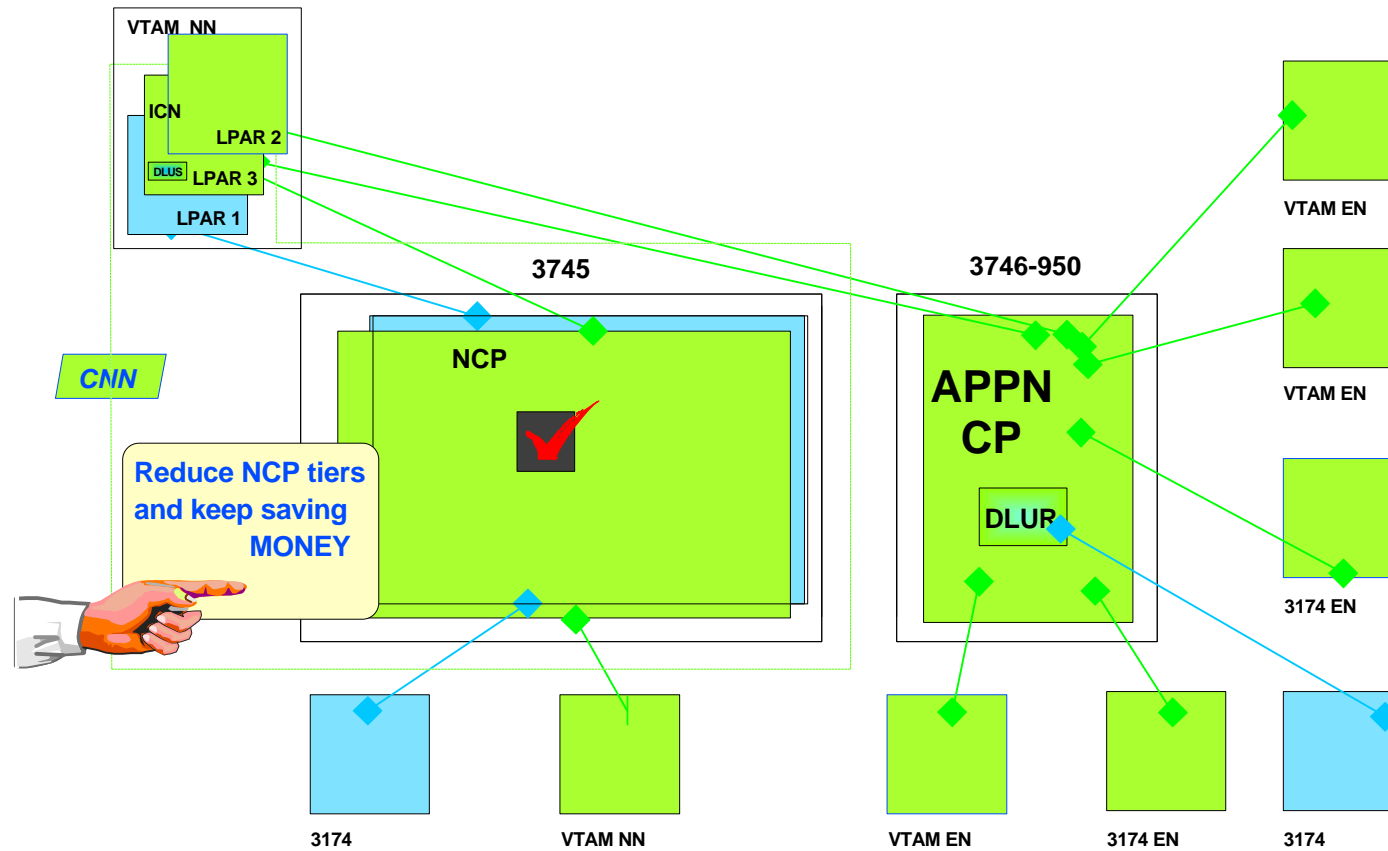
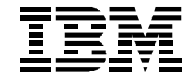

Evolution from 3745 to 3746-950 (20)

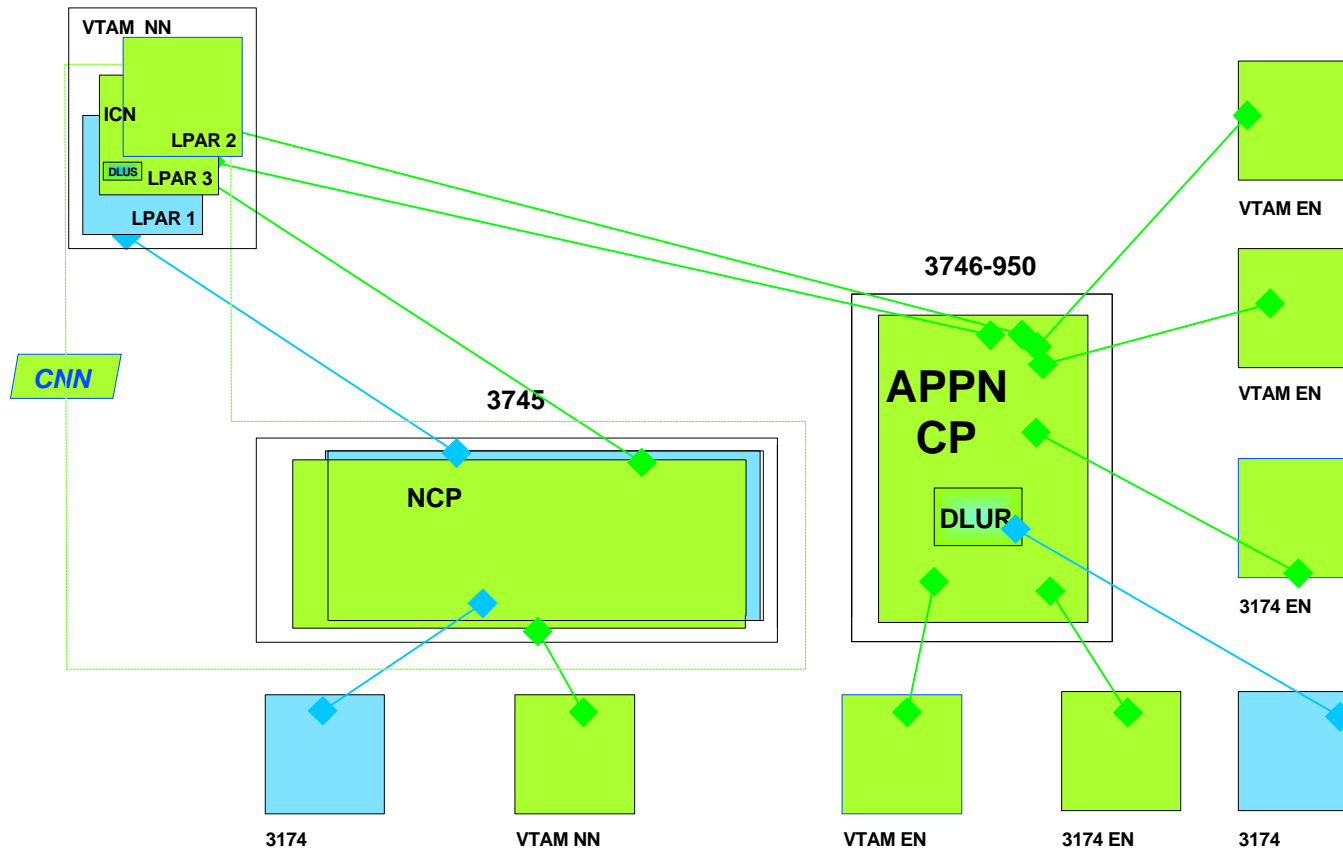

Evolution from 3745 to 3746-950 (20)

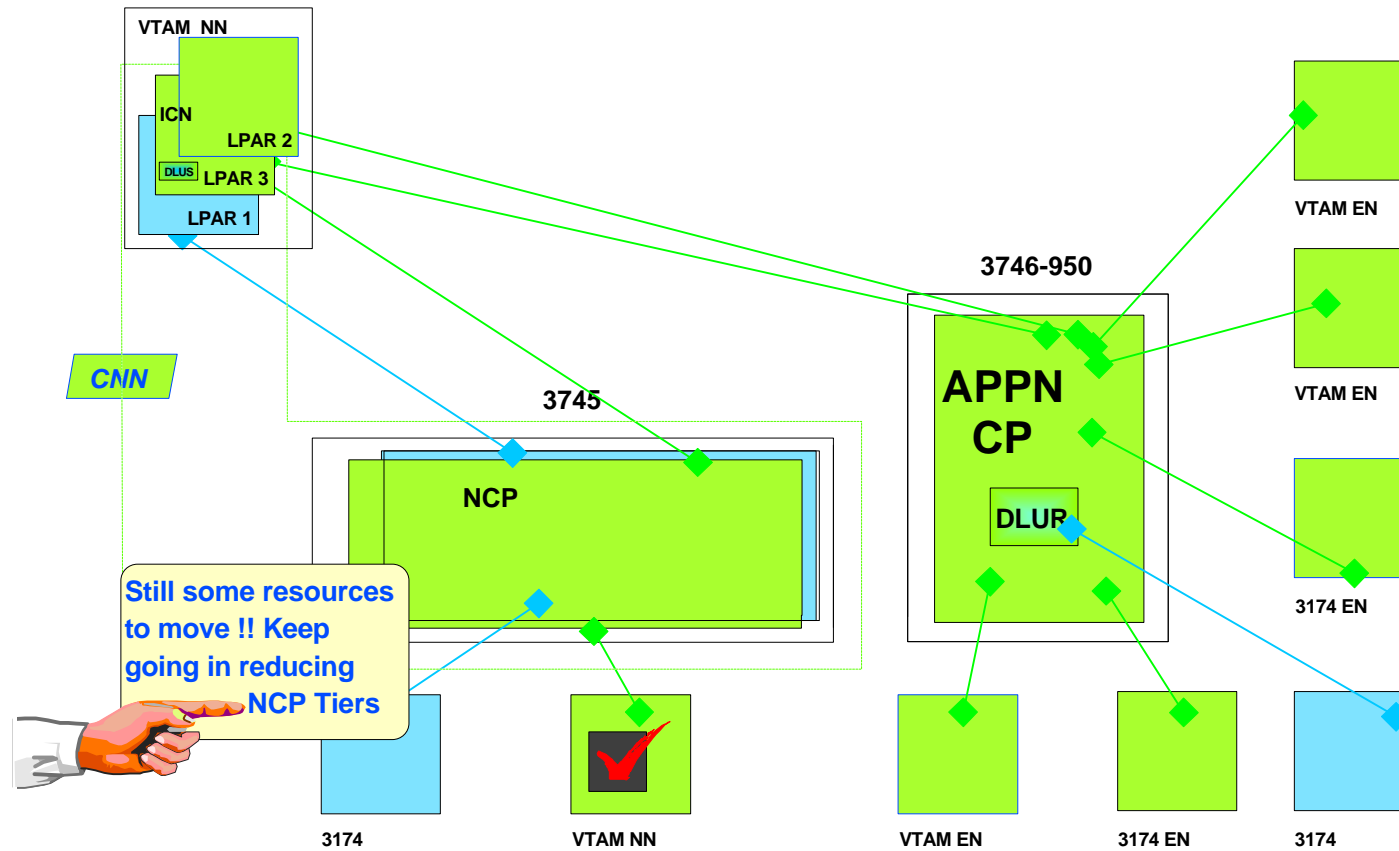

Evolution from 3745 to 3746-950 (21)

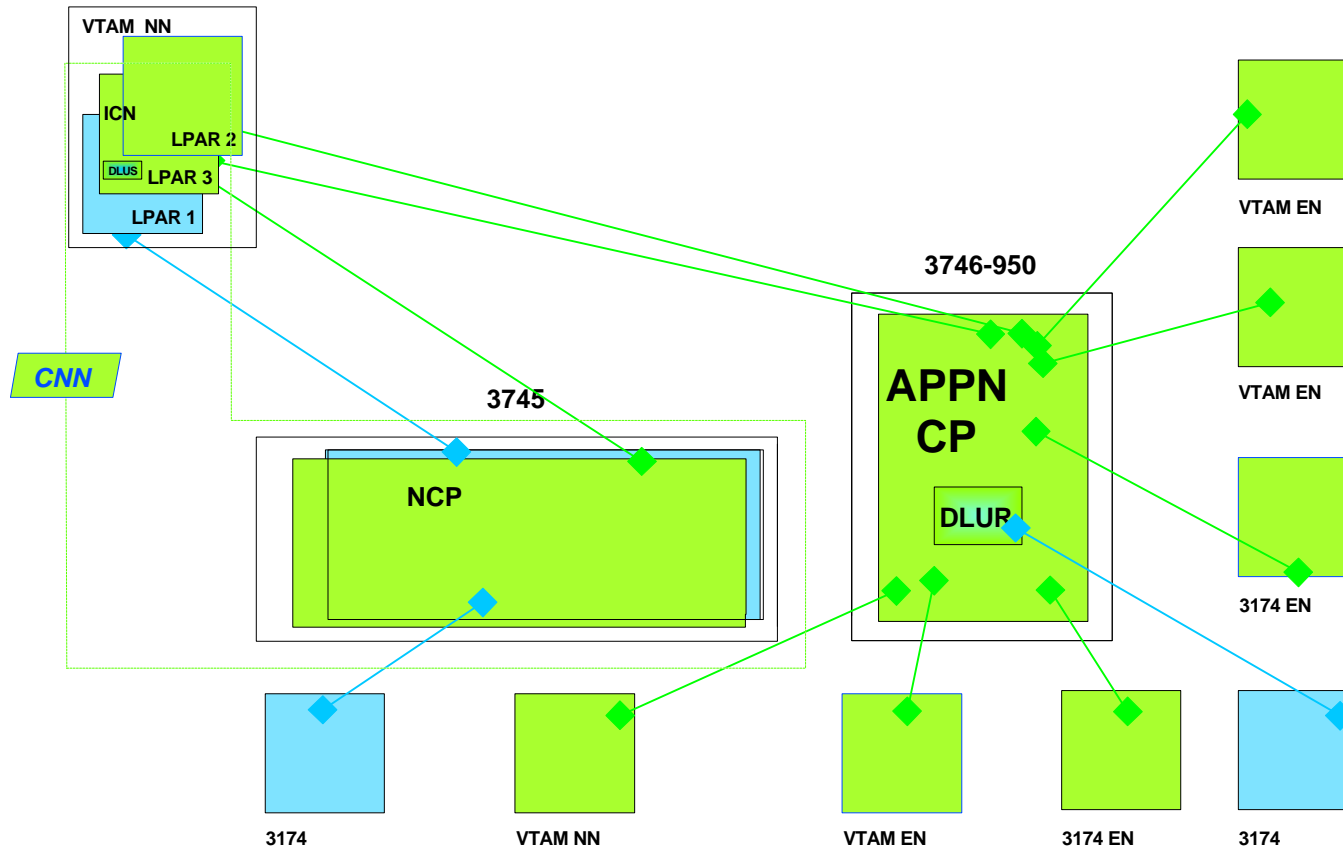

Evolution from 3745 to 3746-950 (21)

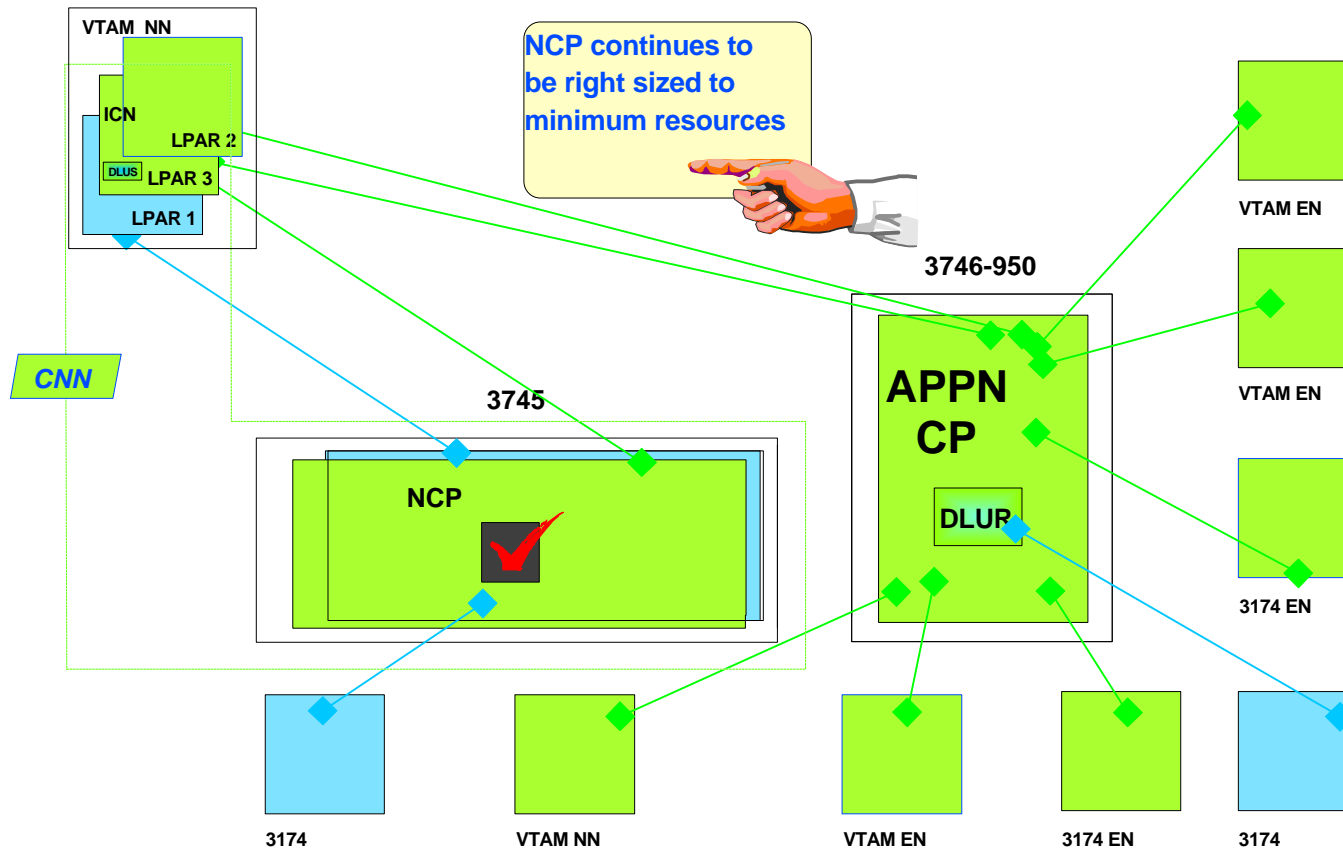

Evolution from 3745 to 3746-950 (22)

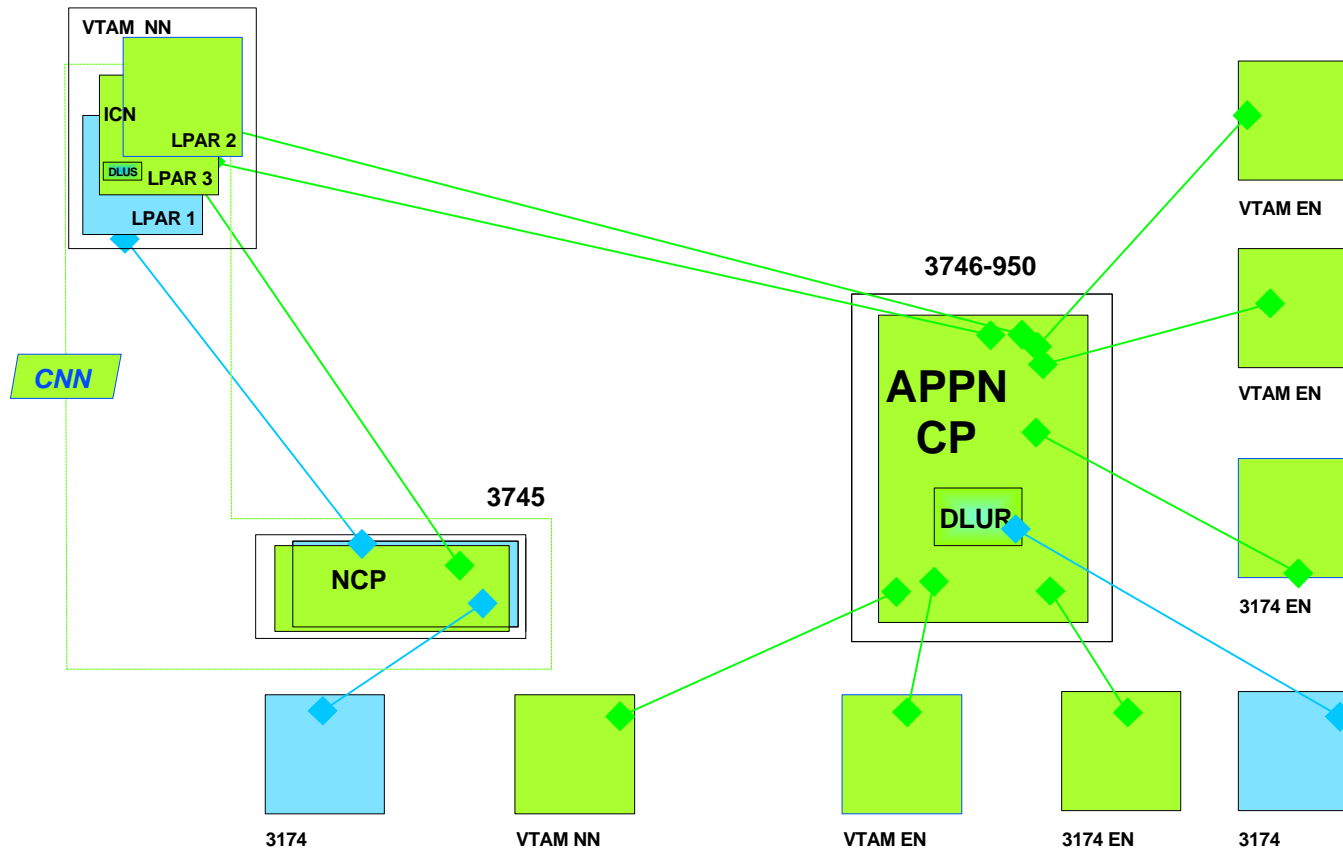

Evolution from 3745 to 3746-950 (22)

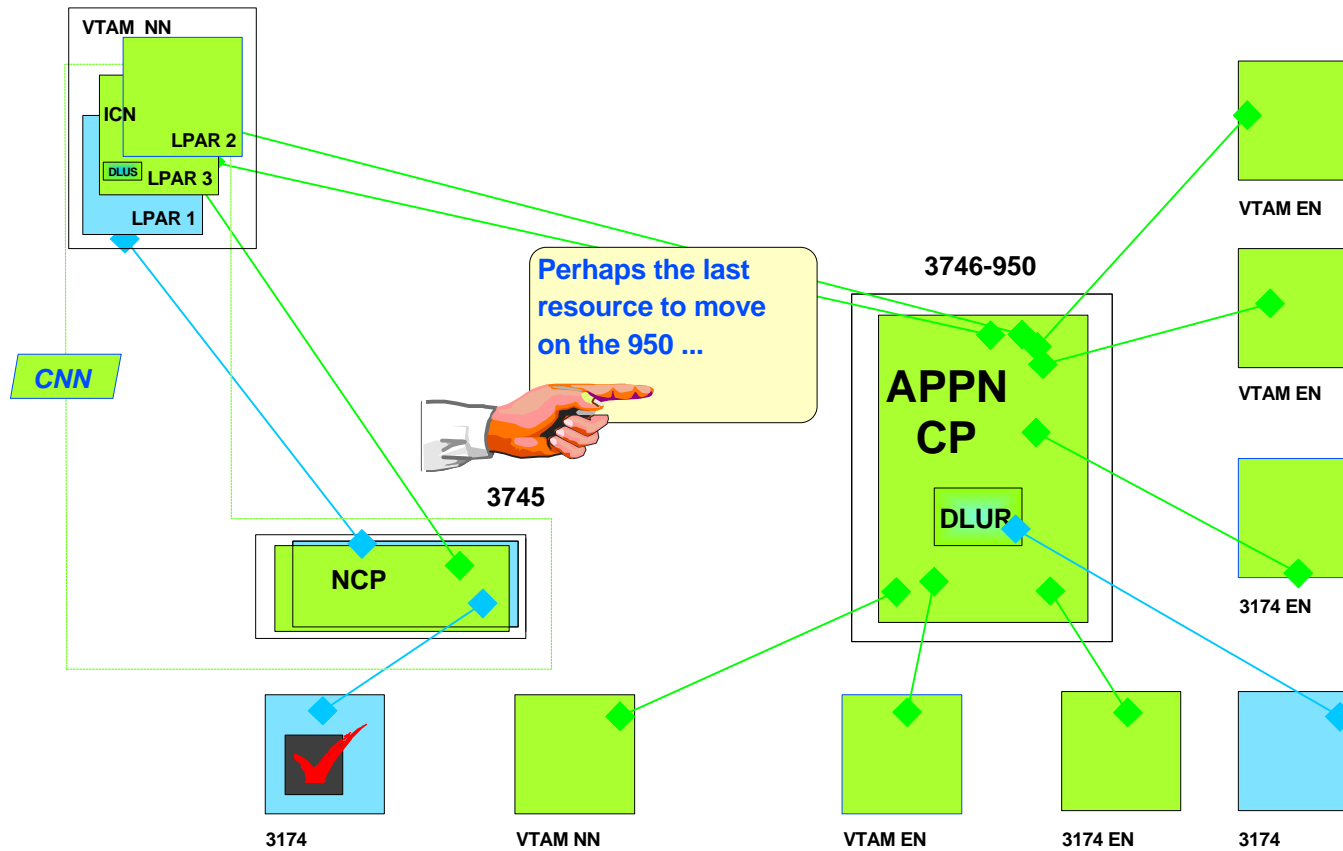

Evolution from 3745 to 3746-950 (23)

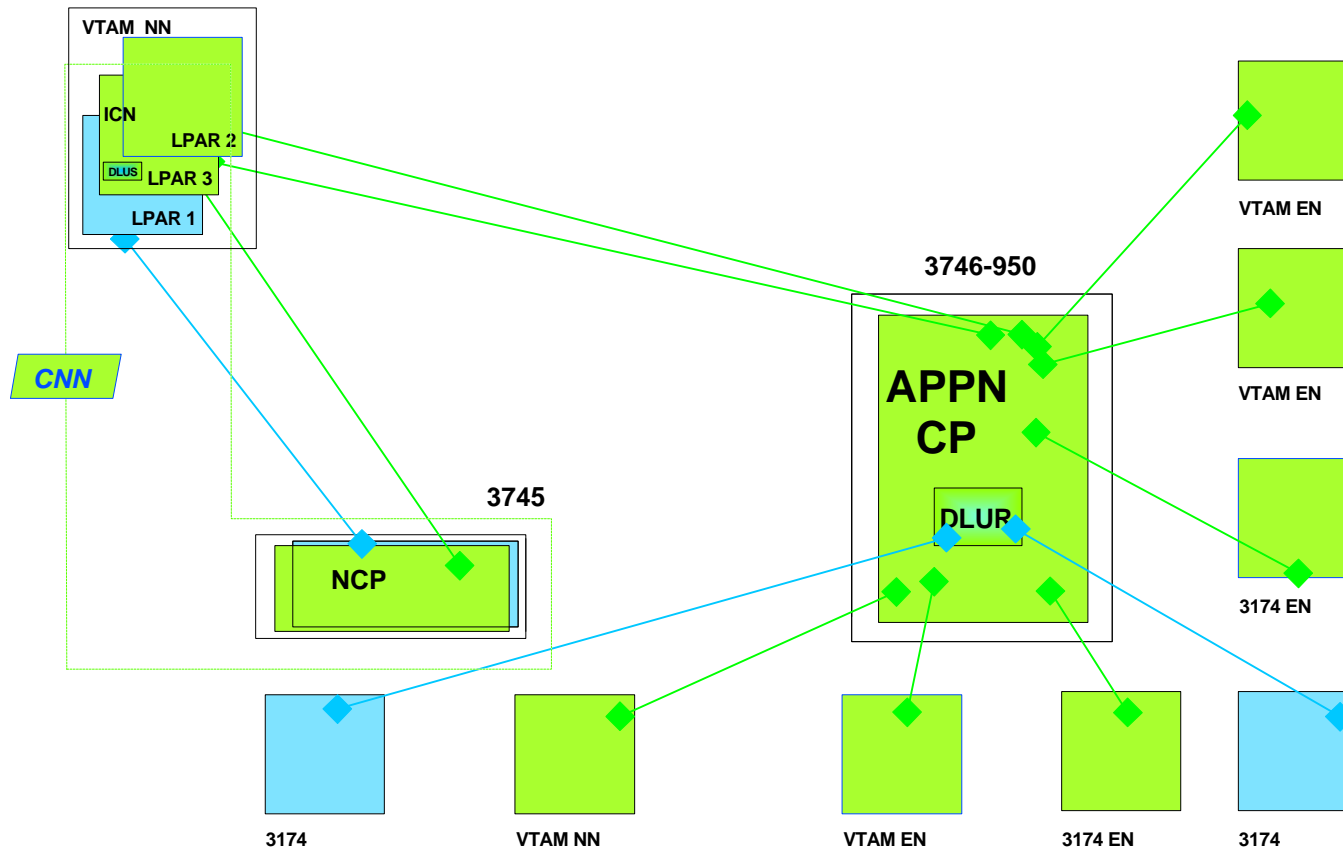

Evolution from 3745 to 3746-950 (23)

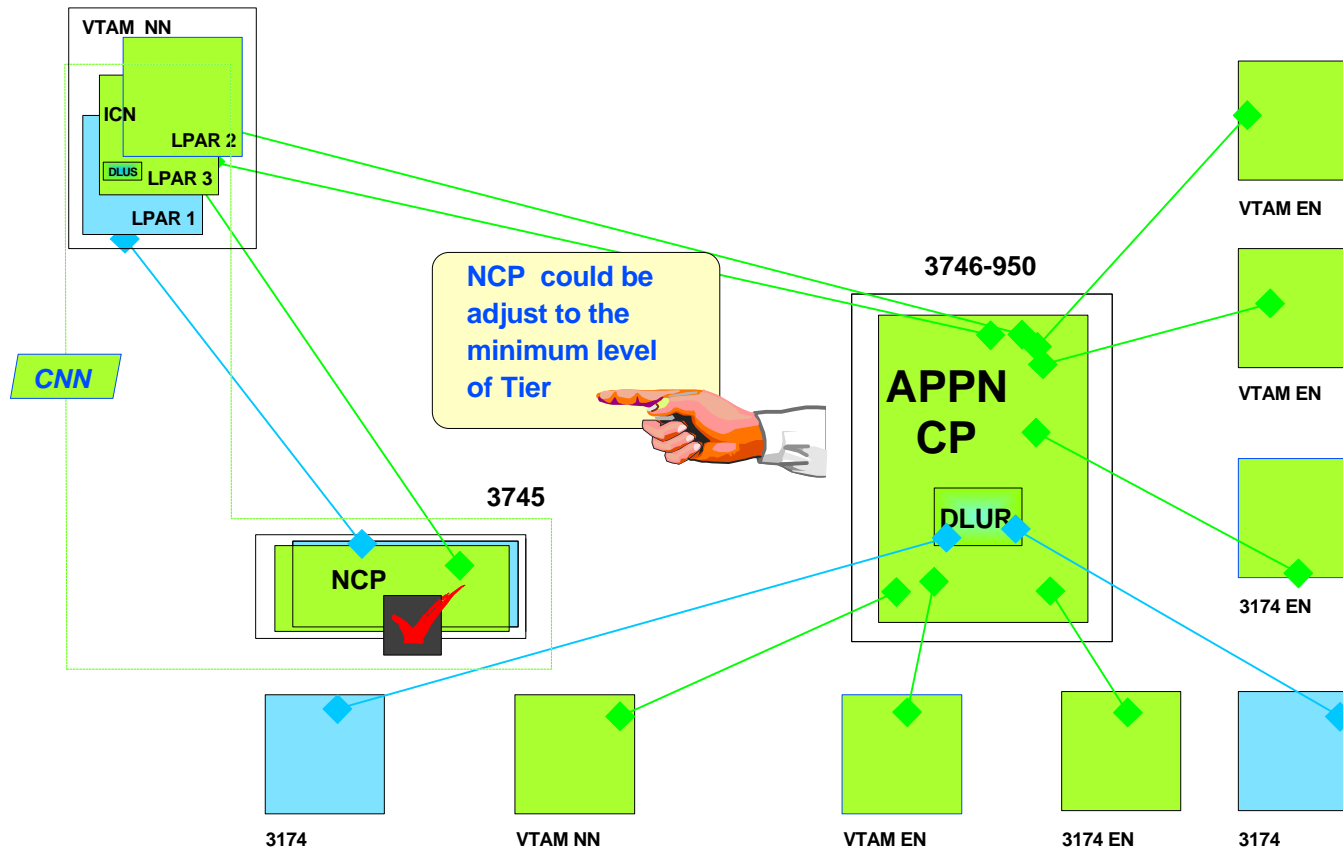
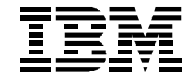

Evolution from 3745 to 3746-950 (24)

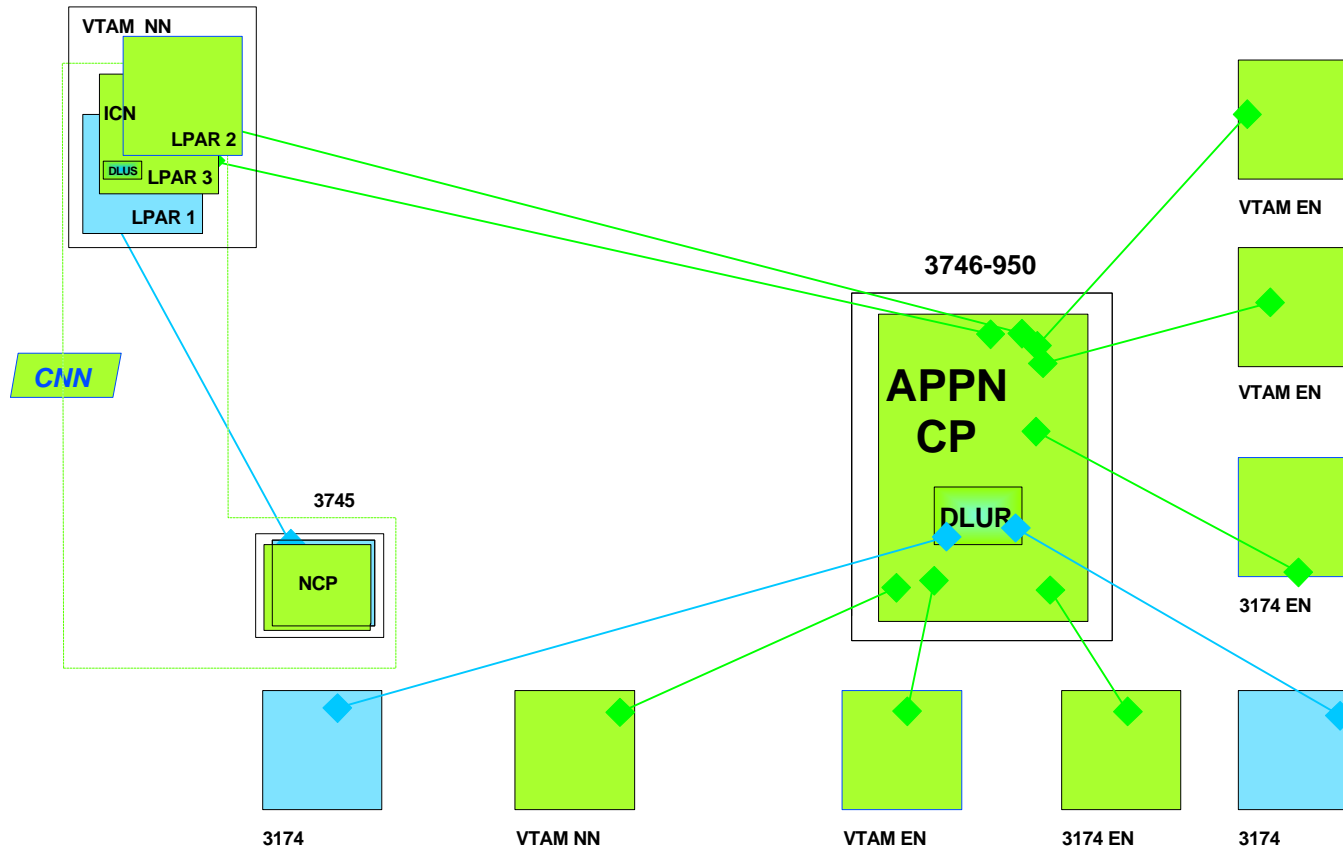

Evolution from 3745 to 3746-950 (24)

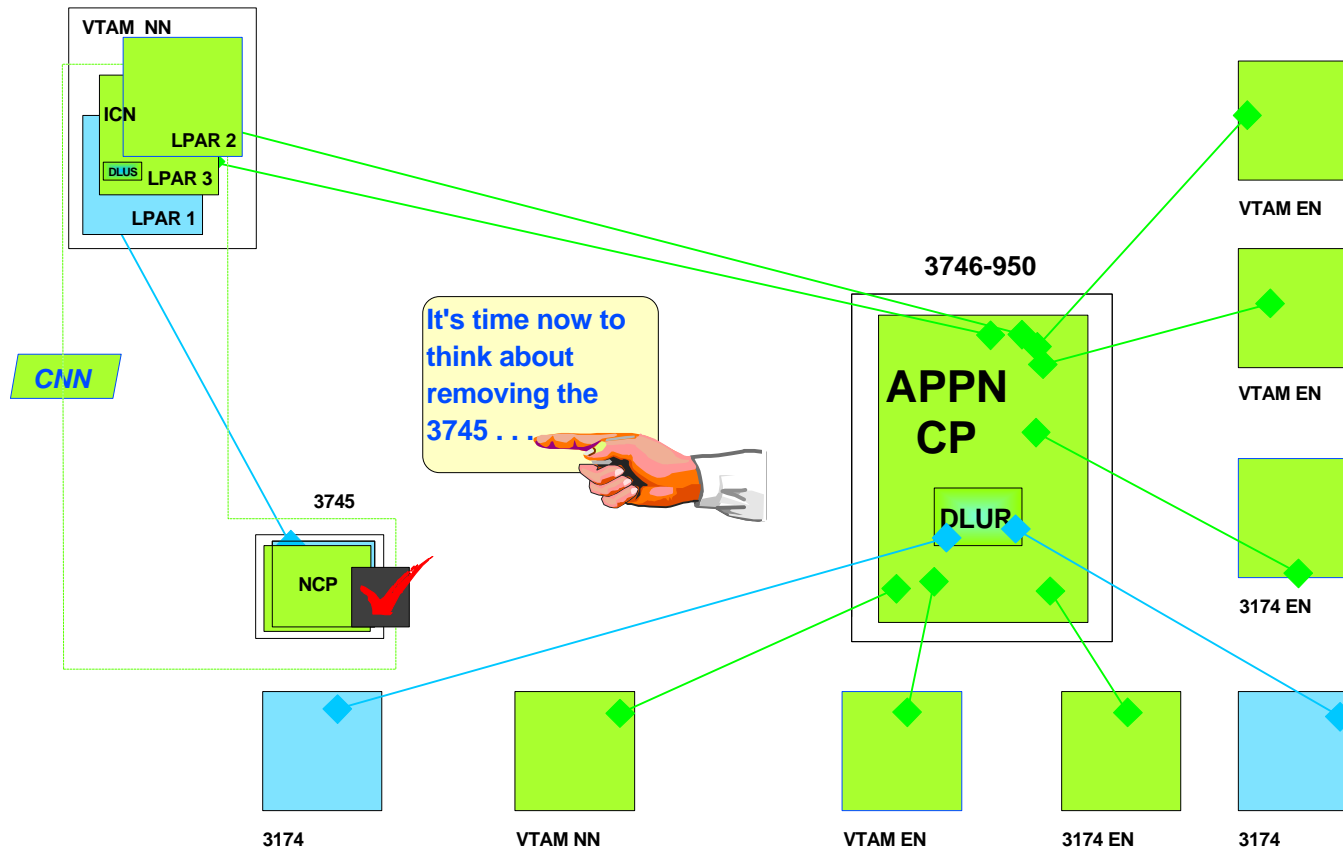

Evolution from 3745 to 3746-950 (25)

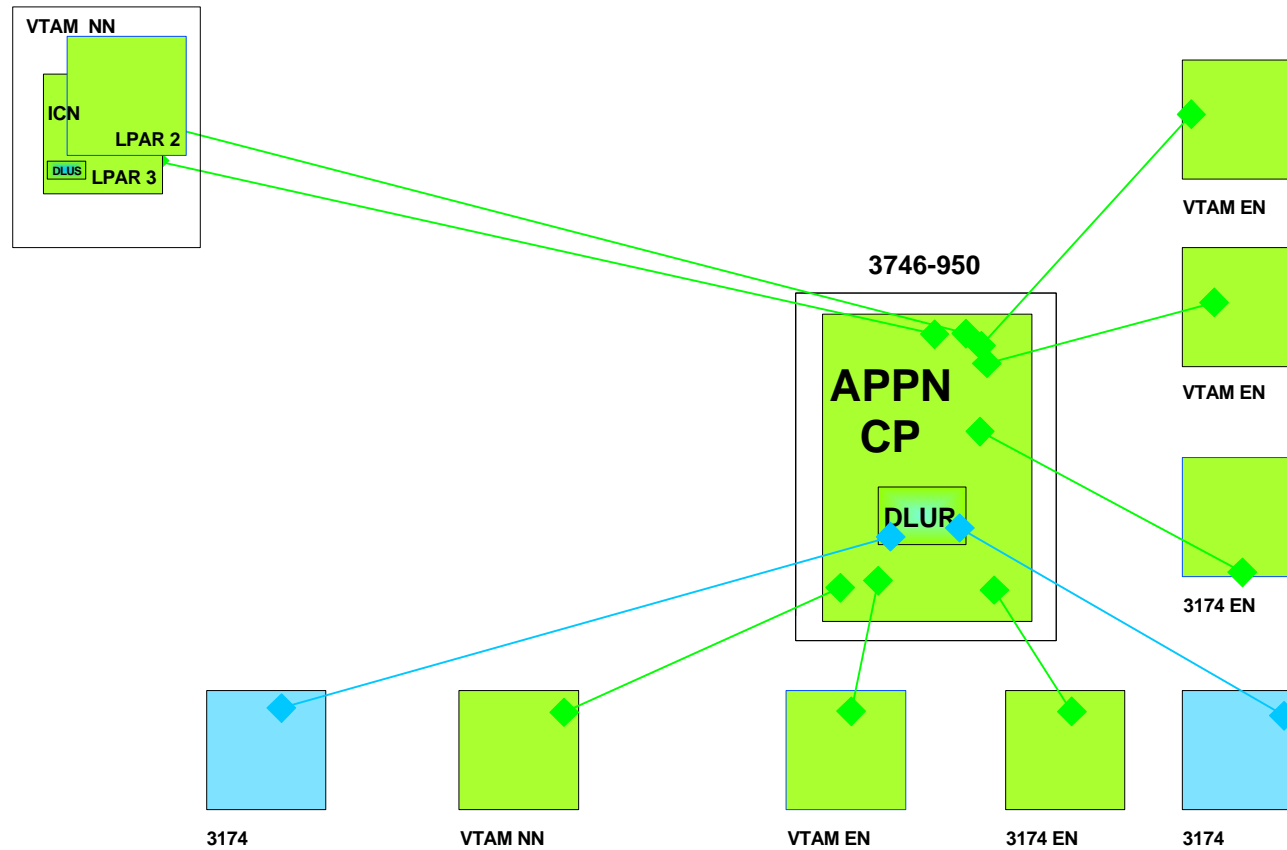

Evolution from 3745 to 3746-950 (25)

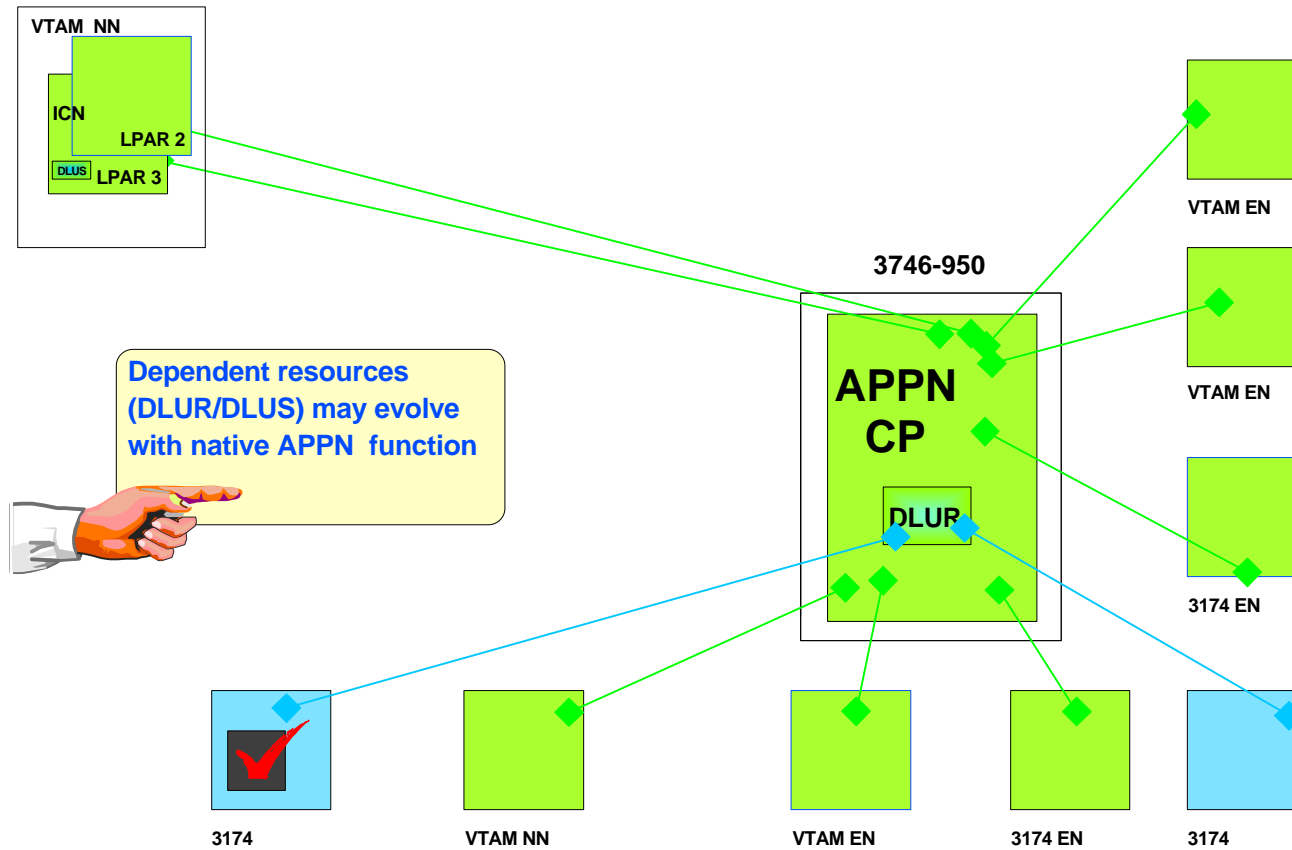

Evolution from 3745 to 3746-950 (26)

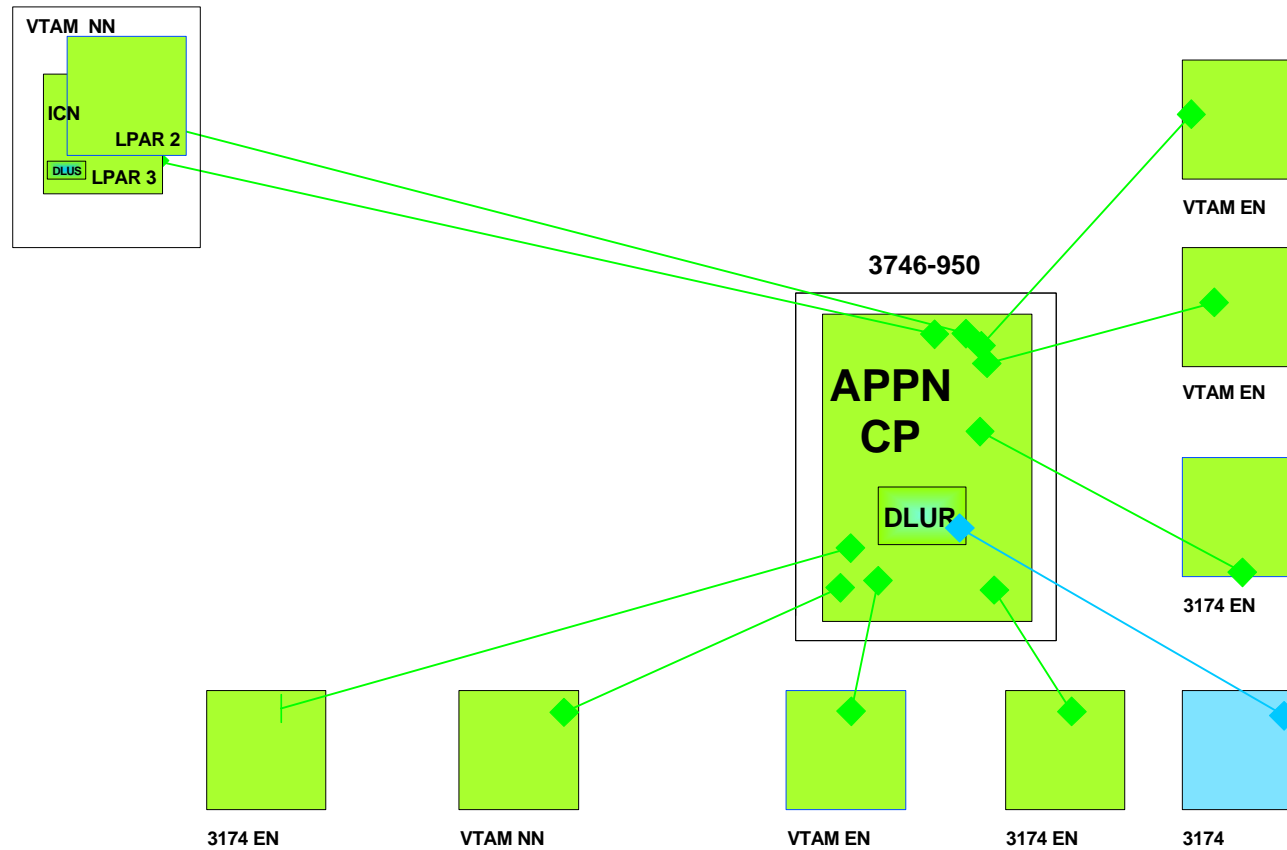

Evolution from 3745 to 3746-950 (26)

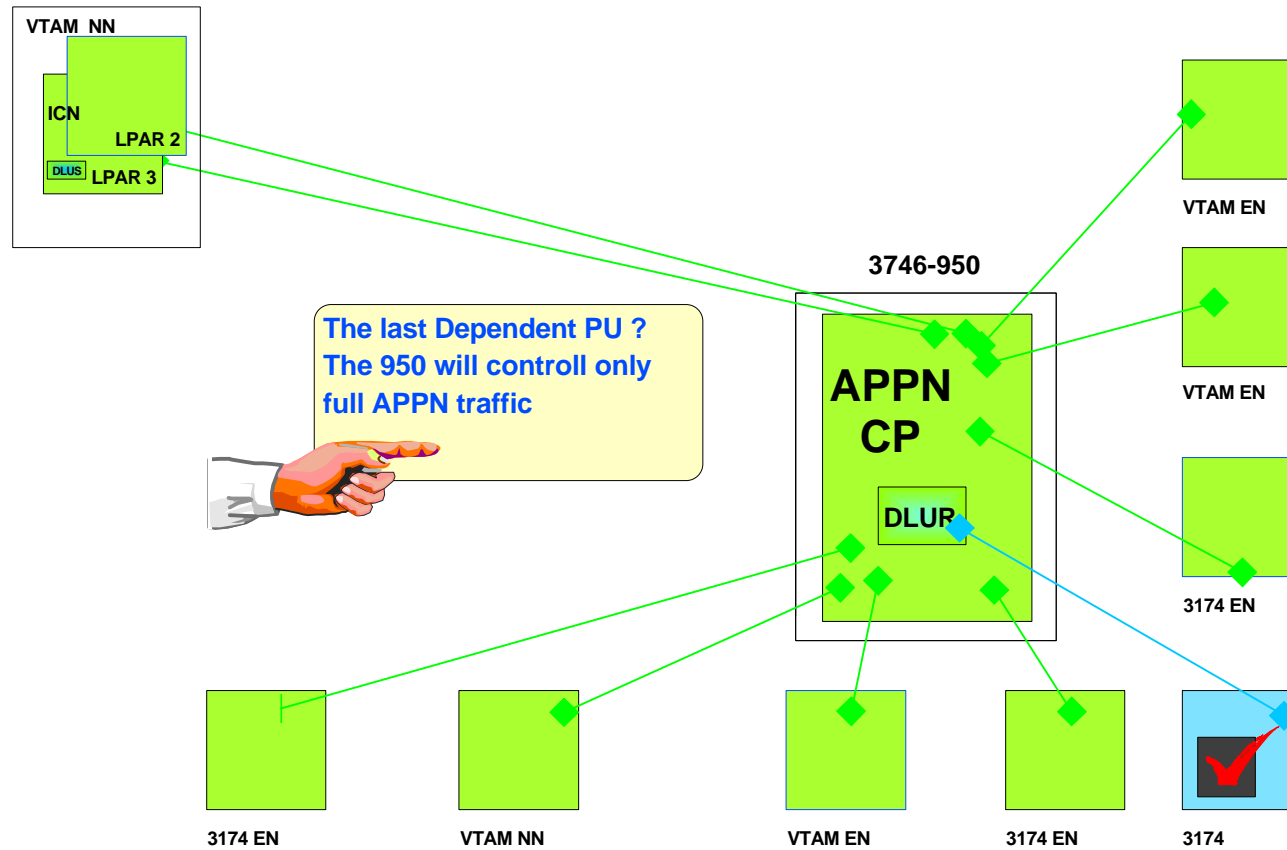

Evolution from 3745 to 3746-950 (27)

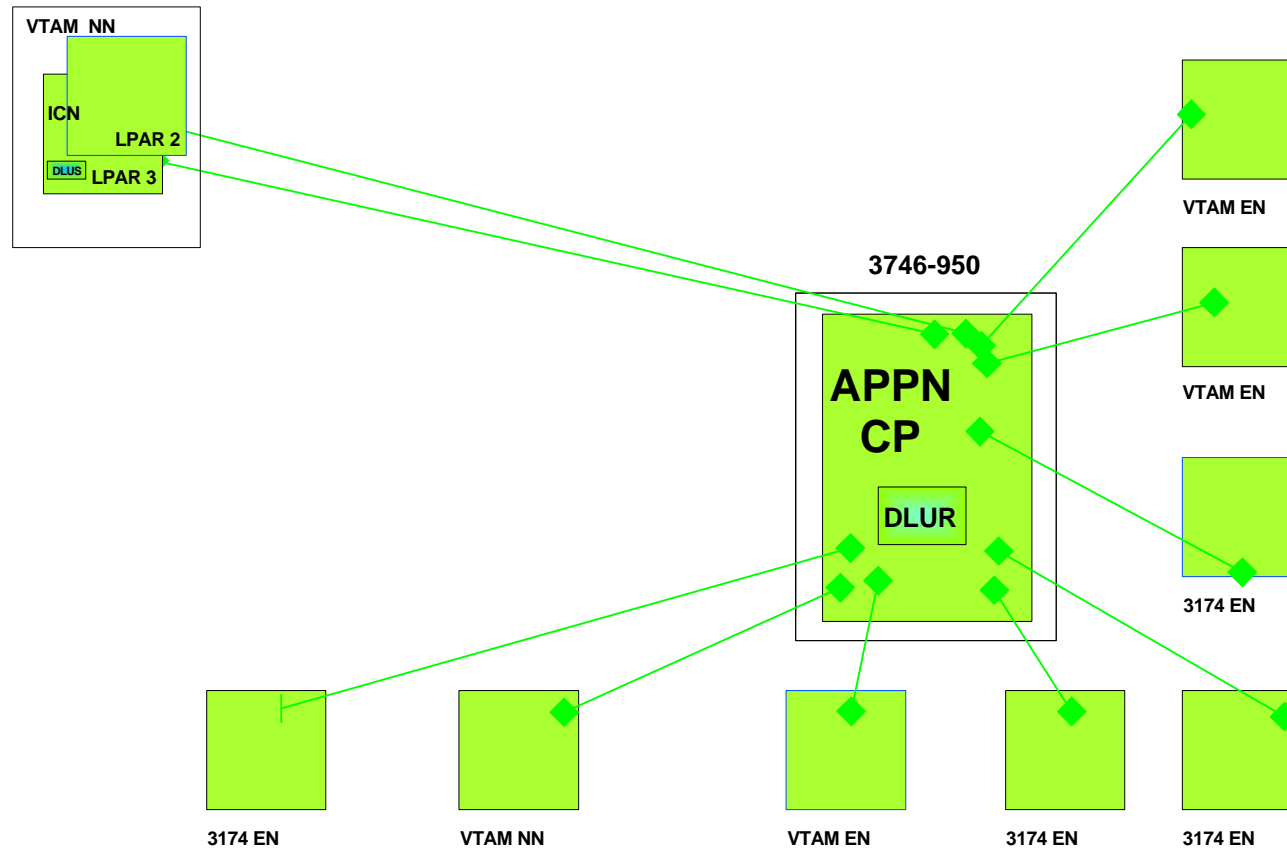

Evolution from 3745 to 3746-950 (27)

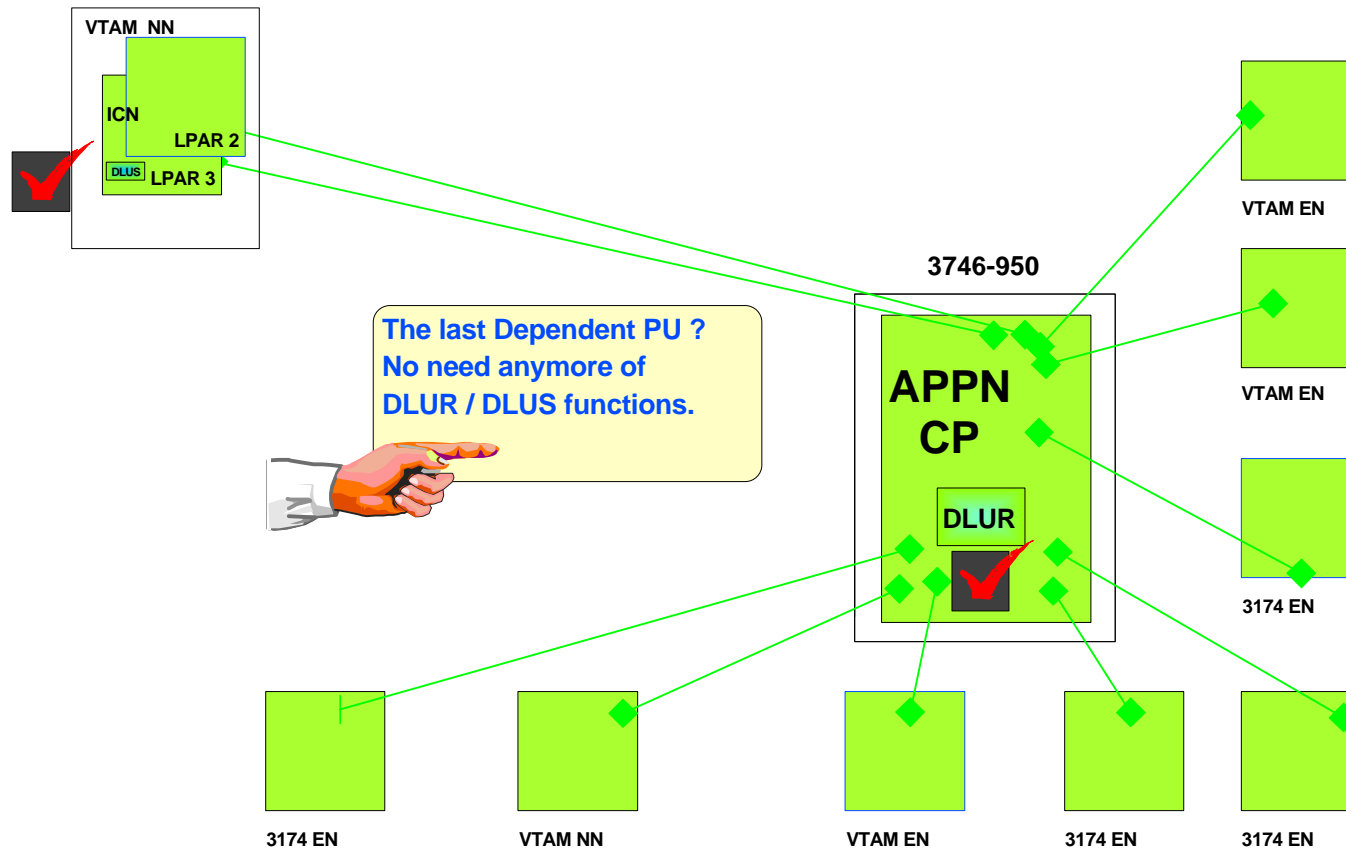

Evolution from 3745 to 3746-950 (28)

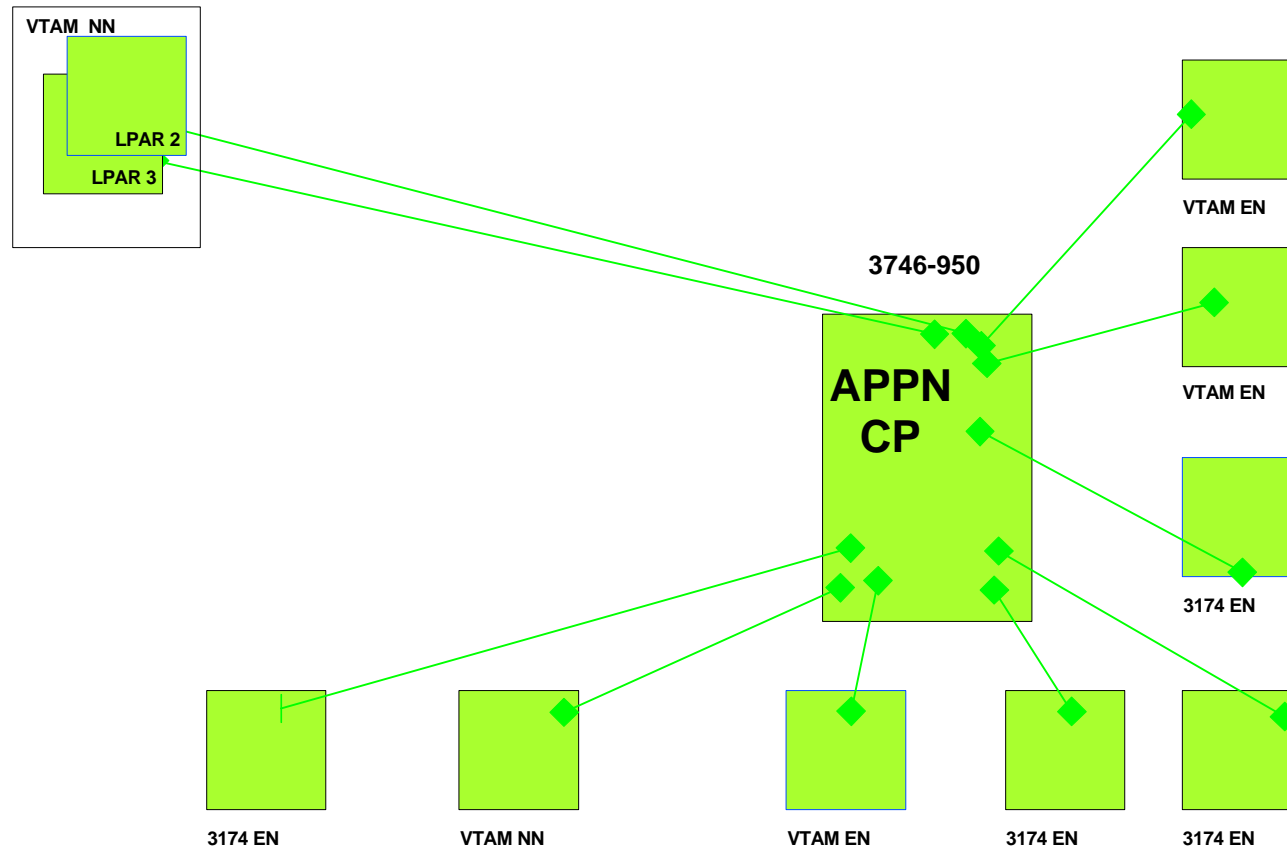

Evolution from 3745 to 3746-950 (28)

