

IBM System z9
Technology Innovation
A System z9 for Everyone



© 2006 IBM Corporation

OVP000

IBM Systems

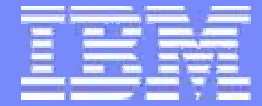

IBM System z9
Technology Innovation
A System z9 for Everyone



© 2006 IBM Corporation

OVP000

IBM Systems

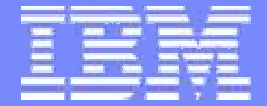

IBM System z9
Technology Innovation
A System z9 for Everyone

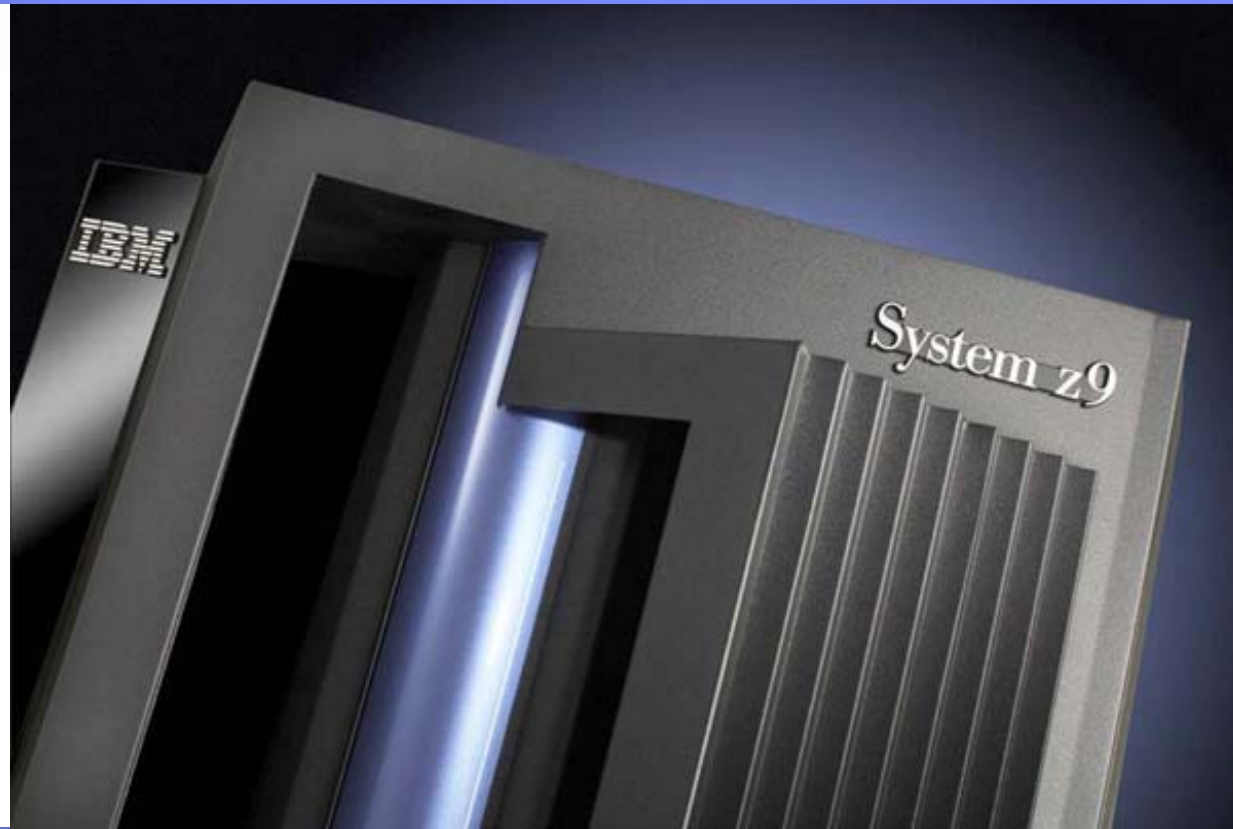

© 2006 IBM Corporation

OVP000

IBM Systems

Trademarks

The following are trademarks of the International Business Machines Corporation in the United States and/or other countries.

AIX*	GDPS*	Parallel Sysplex*	VisualAge*
CICS*	HiperSockets	PR/SM	VM/ESA*
DB2*	IBM*	RACF*	VSE/ESA
DB2 Connect	IBM eServer	Rational*	VTAM*
DB2 Universal Database	IBM logo*	RMF	WebSphere*
DirMaint	IMS	System i	z/Architecture
Domino	Language Environment*	System z	z/OS*
DRDA*	Lotus*	System z9	z/VM*
Enterprise Storage Server*	MQSeries*	System Storage	z/VSE
ESCON*	Multiprise*	Tivoli*	zSeries*
FICON*	OMEGAMON*	TotalStorage*	zSeries Entry License Charge
FlashCopy*	OS/390*	Virtualization Engine	

* Registered trademarks of IBM Corporation

The following are trademarks or registered trademarks of other companies.

Intel is a trademark of Intel Corporation in the United States, other countries, or both.

Java and all Java-related trademarks and logos are trademarks of Sun Microsystems, Inc., in the United States and other countries

Linux is a trademark of Linus Torvalds in the United States and other countries..

UNIX is a registered trademark of The Open Group in the United States and other countries.

Microsoft is a registered trademark of Microsoft Corporation in the United States and other countries.

* All other products may be trademarks or registered trademarks of their respective companies.

Notes:

Performance is in Internal Throughput Rate (ITR) ratio based on measurements and projections using standard IBM benchmarks in a controlled environment. The actual throughput that any user will experience will vary depending upon considerations such as the amount of multiprogramming in the user's job stream, the I/O configuration, the storage configuration, and the workload processed. Therefore, no assurance can be given that an individual user will achieve throughput improvements equivalent to the performance ratios stated here.

IBM hardware products are manufactured from new parts, or new and serviceable used parts. Regardless, our warranty terms apply.

All customer examples cited or described in this presentation are presented as illustrations of the manner in which some customers have used IBM products and the results they may have achieved. Actual environmental costs and performance characteristics will vary depending on individual customer configurations and conditions.

This publication was produced in the United States. IBM may not offer the products, services or features discussed in this document in other countries, and the information may be subject to change without notice. Consult your local IBM business contact for information on the product or services available in your area.

All statements regarding IBM's future direction and intent are subject to change or withdrawal without notice, and represent goals and objectives only.

Information about non-IBM products is obtained from the manufacturers of those products or their published announcements. IBM has not tested those products and cannot confirm the performance, compatibility, or any other claims related to non-IBM products. Questions on the capabilities of non-IBM products should be addressed to the suppliers of those products.

Prices subject to change without notice. Contact your IBM representative or Business Partner for the most current pricing in your geography.

NOTE TO PRESENTER

This slide provides a map for customized presentations

Name of presentation	Suggested order of slides
<p>Combined z9 EC and z9 BC 'Roadshow' presentation:</p> <p>IBM System z9 Technology Innovation: <i>A System z9 for Everyone</i></p>	<p>OVP000, OVPTM1, OVP010, OVP020, OVP030, OVP040, OVP050, OVP060, OVP070, OVP080, OVP090, OVP100, OVP110, OVP115, OVP120, OVP130, OVP140, OVP150, OVP160, OVP170, OVP180</p>
<p>Standalone z9 EC Presentation:</p>	<p>OVP000, OVPTM1, OVP320, OVP330, OVP370, OVP070, OVP080, OVP380, OVP390, OVP290, OVP420, OVP430, OVP400, OVP110, OVP410, OVP120, OVP130, OVP450, OVP460, OVP470, OVP140, OVP150, OVP030, OVP050, OVP200, OVP180, OVP310, OVP340, OVP350, OVP360, OVP440, OVP210, OVP220, OVP230, OVP240, OVP250, OVP260, OVP270, OVP280, OVP600, OVP610, OVP620, OVP630, OVP640, OVP650</p>
<p>Standalone z9 BC Presentation</p>	<p>OVP000, OVPTM1, OVP500, OVP490, OVP030, OVP040, OVP520, OVP050, OVP060, OVP290, OVP100, OVP560, OVP230, OVP110, OVP115, OVP120, OVP130, OVP530, OVP540, OVP550, OVP570, OVP583, OVP140, OVP150, OVP585, OVP580, OVP588, OVP480, OVP200, OVP250, OVP260, OVP270, OVP280, OVP240, OVP590, OVP210, OVP220, OVP600, OVP610, OVP620, OVP630, OVP640, OVP650</p>

IBM System z9

The server designed to help protect, grow and meet the demands of enterprise of all sizes

The IBM System z9™ Enterprise Class (z9 EC) – formerly called z9-109 – and the new IBM System z9 Business Class (z9 BC) deliver excellence in enterprise computing and are designed and optimized for on demand business

- **Built on more than 40 years of industry leadership and taking that leadership to new levels**
 - ▶ Scalability
 - ▶ Availability
 - ▶ Security

- **It's time to rethink the role of the mainframe**
 - ▶ A mainframe for everyone
 - ▶ Helping to drive increased value from data and applications including the announcing of the availability of System z9 Integrated Information Processor (zIIP)
 - ▶ Helping to simplify management and reduce costs of storage subsystems with new connectivity options

z9 EC



z9 BC

Now there is a System z9 for everyone

System z9 EC . . . built to help protect and grow with your business

- **Capacity to meet your business objectives**
 - ▶ Capacity on demand for minimal downtime
 - ▶ Large mainframe server in a single footprint with the S54
 - ▶ Leadership capabilities to help improve I/O access *

- **Helping lower risk of downtime**
 - ▶ Leader in Parallel Sysplex® clustering and GDPS® services
 - ▶ Superior access to applications via comprehensive protection from unplanned and planned outages

- **Security features to help address compliance**
 - ▶ Industry certifications and regulatory compliance ☀
 - ▶ Leadership capabilities in cryptography and encryption



Now the System z9 BC does it too – but in a smaller package ☀

* Performance is based on measurements and projections using standard IBM benchmarks in a controlled environment. The actual throughput or performance that any user will experience will vary depending upon considerations such as the amount of multiprogramming in the user's job stream, the I/O configuration, the storage configuration, and the workload processed. Therefore, no assurance can be given that an individual user will achieve throughput or performance improvements equivalent to the numbers stated here.

z9 BC – The modern mainframe for the small to medium enterprise

- **Based on System z9 technology**
- **Designed for flexibility in 2 new models**
- **More engines for more workloads**
 - ▶ System z™ Application Assist Processor (zAAP), Integrated Facility for Linux (IFL), Internal Coupling Facility (ICF), zIIP
- **On demand upgrade capability**
 - ▶ Exceptional upgradeability
 - ▶ On/Off Capacity on Demand (On/Off CoD) functions available
- **Enhanced networking and connectivity options**
- **Built with System z9's cryptographic and encryption functions**
 - ▶ ATM/POS Remote Key Load
- **EWLC and Tiered EWLC Software Pricing Structure**
- **Operating system support – similar to z9 EC**
 - ▶ SOD for z/VSE™ V4 - intends to deliver enhanced pricing options
 - ▶ z/OS.e continues to be supported

Low entry point and more choices



z9 BC – Delivering increased capacity and performance

Flexibility for growth

■ Greater granularity and scalability

- ▶ Two models with one machine type (2096)
 - 1 to 4-way high performance server standard engines
 - Entry model with 1 to 3-way standard engines
 - Up to a 7-way with specialty engines
- ▶ 73 capacity settings for a 2.6 times increase in flexibility over IBM eServer™ zSeries® 890 (z890)
- ▶ Delivers over 37% more capacity with the same low entry point as the z890
- ▶ Up to 37% hardware performance improvement for Linux® (IFLs), Java™ (zAAPs) and coupling (ICFs)
- ▶ New zIIP for data serving workloads
- ▶ Double the memory – up to 64 GB per server

■ Improved I/O Performance

- ▶ 40% more FICON® channels – up to 112
- ▶ Up to 170% more bandwidth than z890
- ▶ Can improve FICON performance with Modified Indirect Data Address Word (MIDAW) facility
- ▶ Double the FICON concurrent I/O operations from 32 to 64 on FICON channel
- ▶ Multiple Subchannel Sets (MSS) for an increased number of logical volumes

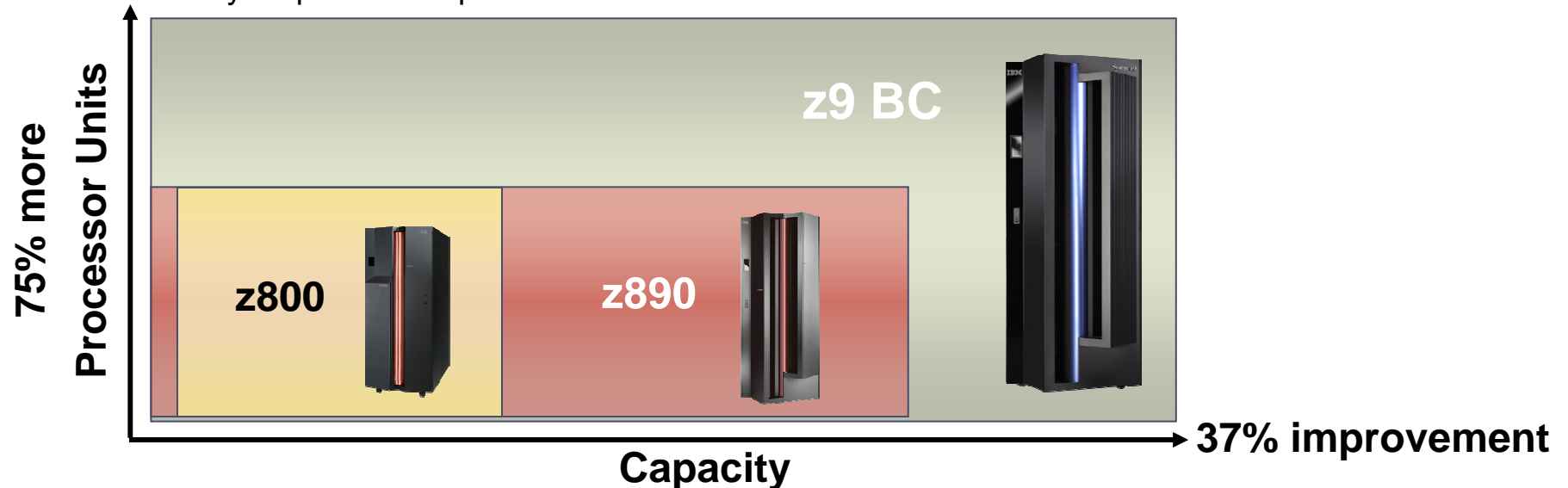

IBM System z9 BC model comparison

Model R07

- **Processor Units (PUs)**
 - ▶ 7 PUs + 1 SAP
 - ▶ 1 - 3 CPs
 - ▶ 0 – 3 zAAPs or zIIPs
 - ▶ 0 – 6 IFLs or ICFs
 - ▶ 20 Capacity Settings

- **Memory**
 - ▶ 8 – 64GB

- **I/O**
 - ▶ 240 ESCON®
 - ▶ 64 FICON Express4
 - ▶ 32 OSA-Express2 (2-port); with 24 on A01
 - ▶ 8 Crypto Express2
 - ▶ 16 STIs



Model S07

- **Processor Units (PUs)**
 - ▶ 7 PUs + 1 SAP
 - ▶ 0 - 4 CPs
 - ▶ 0 – 3 zAAPs or zIIPs
 - ▶ 0 – 7 IFLs or ICFs
 - ▶ 53 Capacity Settings

- **Memory**
 - ▶ 8 – 64GB

- **I/O**
 - ▶ 420 ESCON
 - ▶ 112 FICON Express4
 - ▶ 48 OSA-Express2 (2-port)
 - ▶ 16 Crypto Express2
 - ▶ 16 STIs

Both models have Sub-capacity CBU CPs and Specialty Engine CBU capabilities for more robust disaster recovery possibilities



Extending sub-capacity to the z9 EC

Increased business flexibility with more choices

- Choose a server sized to meet your business objectives**
 - ▶ Introducing sub-capacity engines on the z9 EC
 - ▶ Four capacity settings per engine
 - ▶ New lower entry – 66% smaller than z9 EC current entry
 - ▶ A total of 24 new settings, each with less capacity than the full capacity 8-way
 - ▶ Additional engines can be specialty engines or CBUs
- Availability of all current z9 EC features and functions when running with sub-capacity processors ***
 - ▶ Enhanced book availability and advanced driver maintenance functions are available on multi book systems
- Any to any upgradeability available within the new sub-capacity matrix, as well as to current z9 EC capacity settings**
- Sub-capacity CBUs now available on z9 EC (and z9 BC)**



Granularity, bringing the System z9 to a new set of customers

* Only 8 general purpose processors can be sub-capacity

Finding the server that meets your business needs

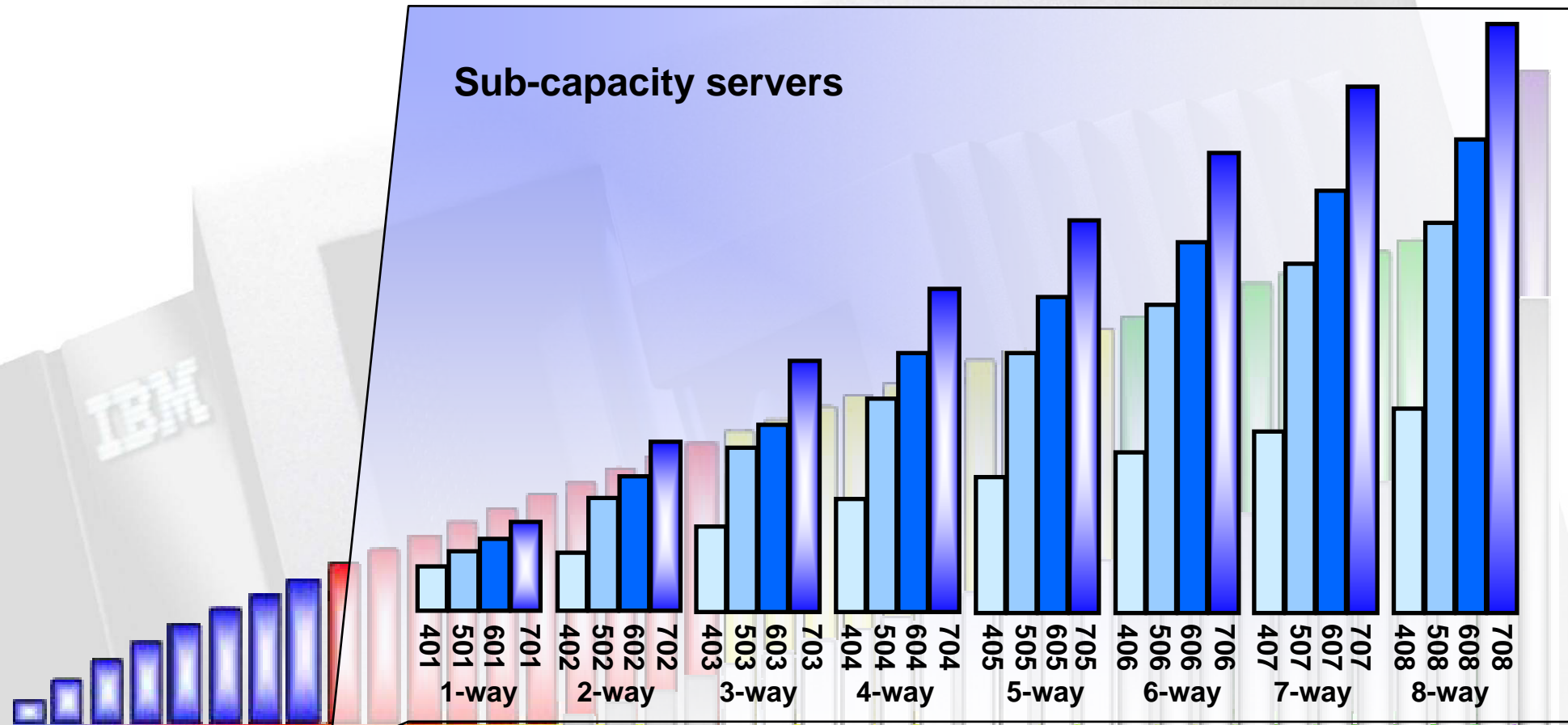

- The z9 EC will now offer 24 additional sub-capacity settings with the first eight general purpose (CP) engines
- Entry point is approximately one third the capacity of the 701
- All general purpose processors must be the same capacity within one z9 EC

Protecting your investment in IBM System z technology

- Designed to protect your investment by offering upgrades from zSeries servers to System z9 servers and upgradeability within the System z9 family
- Growth can be initiated when you need it – either temporarily or permanently
- On/Off Capacity on Demand upgrades can now be tested by your staff ☀
- New options for reconfiguring specialty engines if business demands it ☀
- Capacity BackUp (CBU) enhancements too ☀

Upgrade to z9 BC

Upgrade to z9 EC





* z800 Model 004 only

** All models except z900 Model 100

Helping customers integrate data across the enterprise

The new IBM System z9 Integrated Information Processor (IBM zIIP)

Announcing
Availability

- **z/OS and z/OS.e manages and directs work between the general purpose processor and the zIIP**
 - ▶ No changes anticipated to DB2 Universal Database™ (UDB) for z/OS V8 applications
 - ▶ Number of zIIPs per System z9 not to exceed number of general purpose processors
 - ▶ Price for each zIIP on z9 BC is \$95,000 (US) * 
 - ▶ Price for each zIIP on z9 EC is \$125,000 (US) *
 - ▶ No IBM software charges on the zIIP – consistent with other specialty engines
- **DB2 UDB for z/OS V8 will be first IBM exploiter of the zIIP with:**
 - ▶ System z9 EC and z9 BC 
 - ▶ z/OS and z/OS.e 1.6 or later
 - ▶ DB2 UDB for z/OS V8
- **Portions of the following DB2 UDB for z/OS V8 workloads may benefit from zIIP**:**
 - ▶ ERP, CRM, Business Intelligence and other enterprise applications – via DRDA® over a TCP/IP connection
 - ▶ Data warehousing applications** – requests that utilize star schema parallel queries
 - ▶ DB2 UDB for z/OS V8 utilities** – select internal DB2® utility functions used to maintain index maintenance structures

* Prices may vary outside the US

** The zIIP is designed so that a program can work with z/OS to have all or a portion of its enclave Service Request Block (SRB) work directed to the zIIP. The above types of DB2 V8 work are those executing in enclave SRBs, of which portions can be sent to the zIIP.

NOTE: z/OS.e is supported only on z9 BC

System z9 designed to improve data access

- Can improve scalability with support for more FICON channels and more devices
- Can help improve channel efficiency and improve throughput with the MIDAW facility designed to allow many applications to take advantage of higher link speeds
- Designed to improve FCP(SCSI) channel resource sharing across LPARs with open standard N_Port ID Virtualization (NPIV)
- The IBM TotalStorage® DS8000 series and IBM TotalStorage DS6000 series works with the System z9 in support of the MIDAW facility and MSS





Introducing FICON Express4 for System z9

- **Designed to improve capacity and performance with next generation 4 Gbps FICON/FCP**
 - ▶ Up to 25% improvement in FICON channel throughput when processing a mix of read and write data transfers¹
 - ▶ Up to 65% improvement in FICON channel throughput when processing all read or all write data transfers¹
 - ▶ 220% cumulative MB/sec throughput improvement in DB2 table scan tests for extended format data sets with FICON Express4 on z9 EC with the MIDAW facility compared to FICON Express2 with the IDAW facility on z9-109²
- **Helps to support reduced cost of storage operations and shorter backup windows with faster channel link data rates**
- **Enables migration to higher performance with 1/2/4 Gbps auto-negotiating links**
- **Cost-effective FICON exploitation for midrange and small enterprises with additional price granularity with 2-port or 4-port cards for z9 BC**

1. Large sequential data transfers on z9 EC with FICON Express4 operating at 4 Gbps (running z/OS V1.7) when compared to FICON Express2 on z9-109 (running z/OS V1.6)
2. Results of internal DB2 table scan tests with the z9 EC, the MIDAW facility, FICON Express4 operating at 4 Gbps (running z/OS V1.7), and the DS8000 compared to z9-109, and FICON Express2 operating at 2 Gbps (running z/OS V1.6)

Next generation 4 Gbps FICON/FCP ... helping to improve capacity and performance

IBM Storage Ready for System z9 and FICON Express4

IBM System z9 and IBM storage 4 Gbps FICON/FCP connectivity may help to:

- Support faster link speeds and shorter backup windows
- Enable channel and link consolidation to help simplify management and reduce the cost of the storage infrastructure
- Support easier migration to 4 Gbps bandwidth with auto-negotiating links



*IBM has a full range of
Disk, SAN, Tape, Software,
& Services for System z9*

Disk

DS8000 – 4 Gbps FICON/FCP Planned 2Q06*
DS6000 – 2 Gbps FICON/FCP

SAN

IBM SAN256B and SAN32B-2 4 Gbps FCP, FICON planned 2Q06
IBM SAN 140M, SAN32M and SAN256M (Planned 2006*) 4 Gbps FICON/FCP
Cisco MDS 9500 and 9216 4 Gbps FICON/FCP

Virtualization

IBM SVC 4 Gbps FCP for Linux on System z Planned 2Q06*
VTS 2 Gbps FICON/FCP
TS7510 Virtualization Engine™ – 2 Gbps FCP for Linux on System z Planned 2Q06*

Tape

IBM TS1120 4 Gbps FCP Tape Drive
IBM TS1120 Tape Controller 4 Gbps FICON Planned 2Q06*
IBM LTO Gen 3 - 4 Gbps FCP for Linux on System z Planned 2006*
IBM 3494 and 3584 Tape Libraries
IBM TS3310 Tape Library - 4 Gbps FCP for Linux on System z Planned 2Q06*

Tape Encryption with Key Management on System z

Why z/OS centralized key management?

- Can help to protect and manage keys
 - Highly secure and available key data store
 - Long term key management
 - Disaster recovery capabilities
- Single point of control
- Over a decade of production use

Encryption Facility for z/OS, V1.1

Data Encryption
in the Server

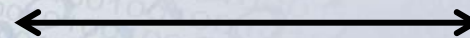
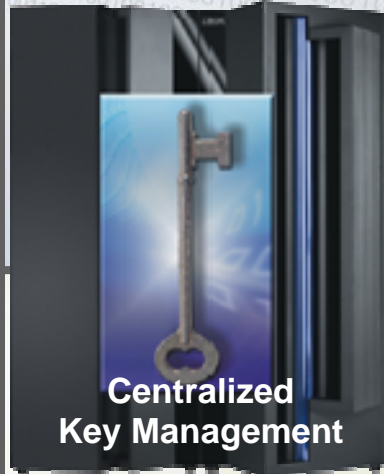

Data Encryption in
TS1120*



Plans for encryption
in IBM System
Storage™ 2H2006*



Enterprise scope

- Flexible options for business partner exchange
- Partners can encrypt and decrypt using no-charge Java client
- Supports public key or password based exchange
- Plans to support OpenPGP standard*

- Highly secure tape library
- High performance archive encryption
- Transparent to existing processes and applications
- Can help provide audit compliance

System z9 operating system software

- **Helping to unify the infrastructure as you build and deploy new applications**
- **Support that can allow for mainframe qualities of service for data serving**
 - ▶ Scalability, security, availability
- **Extending leadership strengths across the infrastructure**

Using the System z operating systems to help you manage your IT infrastructure

z9 EC and z9 BC operating system software

Operating System	ESA/390 (31-bit)	z/Arch (64-bit)
z/OS Version 1 Release 4*, 5*, 6, 7, 8	No	Yes
z/OS.e# Version 1 Release 4*, 5*, 6, 7, 8	No	Yes
Linux, 64-bit distribution	No	Yes
Linux, 31-bit distribution	Yes	No
z/VM® Version 5 Release 1, 2	No	Yes
z/VM Version 4 Release 4 **	Yes	Yes
z/VSE*** 3.1, VSE/ESA™ 2.7 ****	Yes	No
z/VSE V4 ***** (Preview – no GA announced)	No	Yes
z/TPF Version 1	No	Yes
TPF Version 4 Release 1 (ESA mode only)	Yes	No

z/OS.e - z800, z890 and z9 BC only

* Support for z/OS 1.4 and 1.5 will end on March 31, 2007

** Support for z/VM V 4.4 will end September 30, 2006

*** z/VSE V3 can execute in 31-bit mode only. It does not implement z/Architecture™ and specifically does not implement 64-bit mode capabilities. z/VSE V3 is designed to exploit select features of IBM System z hardware.

**** Support for VSE 2.7 will end February 28, 2007

***** z/VSE V4 is designed to exploit 64-bit real memory addressing, but will not support 64-bit virtual memory addressing

Note: Please refer to the latest PSP bucket for latest PTFs for new functions/features.

Now there is a System z9 for everyone . . .



. . . which one is right for you?

A System z9 for everyone

If you ...

- ... need an entry size mainframe*
- ... have smaller I/O attachment requirements*
- ... want IFL options without making a big CPU requirement*
- ... are smaller, but still growing - just in small increments*
- ... don't have a large support staff*
- ... use z/VSE to run your business.*

If you ...

- ... want to replace your server with one that has the same number of engines – but would like more IFLs, zAAPs or zIIPs*
- ... want to replace your standalone coupling facility or Linux only server with a machine that has more capacity per engine and better I/O bandwidth*
- ... like to grow in smaller increments but want help with investment protection, or need a larger server*
- ... agree that availability is important – but one book is enough.*

If you ...

- ... have a large disk installation so in turn have large I/O requirements*
- ... need a current mainframe that can replace your z900 ... with more and smaller processors*
- ... require maximum availability, with things like enhanced book availability*
- ... have a CBU farm – and like the control of having your disaster recover site right in your own shop.*

The System z9 offers management capabilities, security and scalability - to help you stay competitive.

The z9 BC R07 may be the perfect option.

The z9 BC S07 is just what you asked for.

The enhanced z9 EC is for you.



Leadership in systems innovation

- **New family member and capacity settings gives you a choice in selecting the right sized mainframe for your business**
- **Leadership in data and transaction serving with continued IBM platform focus to enable on demand business across the enterprise**
- **Helping to improve capacity and performance in accessing data with the next generation of 4 Gbps FICON/FCP**



System z continues to leverage its leadership in security and resiliency, intelligent management, and business integration capabilities and offers new options for managing the IT infrastructure

BACKUP – Miscellaneous combined slides

IBM System z family

IBM eServer zSeries 990 – z990 (2084)



- **Announced 5/03 – first zSeries Superscalar Server**
- **4 models – Up to 32-way**
- **Specialty Engines**
 - ▶ CP, IFL, ICF, zAAP
- **On Demand Capabilities**
 - ▶ CUoD, CIU, CBU, On/Off CoD
- **Memory – up to 256 GB**
- **Channels**
 - ▶ Four LCSSs
 - ▶ Up to 1024 ESCON channels
 - ▶ Up to 240 FICON Express2 channels
 - ▶ Token-Ring, GbE, 1000BASE-T Ethernet
 - ▶ Coupling Links
- **Crypto Express2**
- **Parallel Sysplex clustering**
- **HiperSockets™ – up to 16**
- **Up to 30 logical partitions**
- **Operating Systems**
 - ▶ z/OS, z/VM, VSE/ESA, z/VSE, TPF, z/TPF, Linux on zSeries

IBM eServer zSeries 890 – z890 (2086)



- **Announced 4/04 – zSeries Superscalar Server for mid range**
- **1 model – Up to 4-way**
 - ▶ 28 capacity settings
- **Specialty Engines**
 - ▶ CP, IFL, ICF, zAAP
- **On Demand Capabilities**
 - ▶ CUoD, CIU, CBU, On/Off CoD
- **Memory – up to 32 GB**
- **Channel**
 - ▶ Two LCSSs
 - ▶ Up to 420 ESCON channels
 - ▶ Up to 80 FICON Express2 channels
 - ▶ Networking Adapters (OSA)
 - ▶ Coupling Links
- **Cryptographic Coprocessors**
- **Parallel Sysplex clustering**
- **HiperSockets – up to 16**
- **Up to 30 partitions**
- **Operating Systems**
 - ▶ z/OS, z/OS.e, z/VM, VSE/ESA, z/VSE, TPF, z/TPF, Linux on zSeries

IBM System z9 EC – z9 EC (2094)



- **Announced 7/05**
- **Superscalar Server**
- **5 models – Up to 54-way**
- **Granular Offerings for 8 CP engines and below**
- **Specialty Engines**
 - ▶ CP, IFL, ICF, zAAP, zIIP
- **On Demand Capabilities**
 - ▶ CUoD, CIU, CBU, On/Off CoD
- **Memory – up to 512 GB**
- **Channels**
 - ▶ Four LCSSs
 - ▶ Multiple Subchannel Sets
 - ▶ MIDAW facility
 - ▶ 63.75 subchannels
 - ▶ Up to 1024 ESCON channels
 - ▶ Up to 336 FICON channels
 - ▶ Enhanced FICON Express4 Gbps
 - ▶ 10 GbE, GbE, 1000BASE-T
 - ▶ Coupling Links
- **Configurable Crypto Express2**
- **Parallel Sysplex clustering**
- **HiperSockets – up to 16**
- **Up to 60 partitions**
- **Enhanced Availability**
- **Operating Systems**
 - ▶ z/OS, z/VM, VSE/ESA, z/VSE, TPF, z/TPF, Linux on System z

IBM System z9 BC – z9 BC (2096)



- **Announced 4/06**
- **Superscalar Server**
- **2 models – 7 configurable PUs**
- **Extreme Granularity**
- **Specialty Engines**
 - ▶ CP, IFL, ICF, zAAP, zIIP
- **On Demand Capabilities**
 - ▶ CUoD, CIU, CBU, On/Off CoD
- **Memory – up to 64 GB**
- **Channels**
 - ▶ Two LCSSs
 - ▶ Multiple Subchannel Sets
 - ▶ MIDAW facility
 - ▶ 63.75 subchannels
 - ▶ Up to 420 ESCON channels
 - ▶ Up to 112 FICON channels
 - ▶ Enhanced FICON Express4 Gbps
 - ▶ 10 GbE, GbE, 1000BASE-T
 - ▶ Coupling Links
- **Configurable Crypto Express2**
- **Parallel Sysplex clustering**
- **HiperSockets – up to 16**
- **Up to 30 partitions**
- **Enhanced Availability**
- **Operating Systems**
 - ▶ z/OS, z/OS.e, z/VM, VSE/ESA, z/VSE, TPF, z/TPF, Linux on System z

System z9 Minimum Operating System Support for functions – 1

	z/OS.e z/OS	z/VM	Linux on System z	z/VSE VSE/ESA ⁽¹⁾	z/TPF TPF ⁽²⁾
Basic System z9 support	1.4 ⁽⁴⁾	4.4	SLES 9 RHEL 4	3.1 2.7 ⁽¹⁾	1.1 4.1 ⁽²⁾
60 Logical Partitions (30 for z9 BC)	1.4 ⁽⁴⁾	4.4	SLES 9 RHEL 4	3.1	1.1 4.1 ⁽²⁾
63.75K Subchannels	1.4 ⁽⁴⁾	4.4	SLES 9 RHEL 4		
OSA-Express2 1000BASE-T Ethernet	1.4 ⁽⁴⁾	4.4	SLES 9 RHEL 4	3.1 2.7 ⁽¹⁾	1.1 4.1 PUT 13 ⁽²⁾
MIDAW Facility	1.6	Not supported	N/A		
CPACF Enhancements	1.6 ⁽⁴⁾	4.4	SLES 9 SP3 ⁽⁵⁾ RHEL 4 U3 ⁽⁵⁾	3.1	
Crypto Express2 exploitation	1.6 ⁽⁴⁾	5.1	SLES 9	3.1 2.7 ⁽¹⁾	
HiperSockets IPv6	1.7	5.2	N/A		
OSA-Express2 Large send	1.6	Not supported	SLES 9 SP2 IBM work with LDPs ⁽³⁾		
OSA-Express2 CDLC support	1.4 ⁽⁴⁾	5.1	SLES 9 SP3 RHEL 4 U3	3.1 2.7 ⁽¹⁾	1.1
Multiple Subchannel Sets (MSS)	1.7	Not supported	IBM work with LDPs ⁽³⁾		
FICON Link Incident Report	1.7	4.4	IBM work with LDPs ⁽³⁾		
Single System Image	1.6 up to 32	5.1 up to 24	SLES 9 up to 32 RHEL 4 up to 32		1.1 up to 54
Enhanced Perf Assists for z/VM Guests	N/A	5.2	IBM work with LDPs ⁽³⁾		

1. indicates VSE/ESA
2. indicates TPF
3. IBM is working with its Linux Distribution Partners (LDPs) that this function will be provided in future Linux on System z distribution releases/service updates
4. Additional features or Web downloads required
5. IBM is working with LDPs on Kernel space exploitation⁽³⁾

Note: Please refer to the latest PSP bucket for latest PTFs for new functions/features z/OS.e - z800, z890 and z9 BC only

SLES = SUSE Linux Enterprise Server
RHEL = Red Hat Enterprise Linux

System z9 Minimum Operating System Support for functions – 2

	z/OS.e z/OS	z/VM	Linux on System z	z/VSE VSE/ESA⁽¹⁾	z/TPF TPF⁽²⁾
N_Port ID Virtualization	N/A	4.4 (guest)	SLES 9 SP3 IBM work with LDPs ⁽³⁾	3.1	
FCP Program Directed re-IPL	N/A	Not supported	SLES 9 SP3 IBM work with LDPs ⁽³⁾		
sub-capacity	1.4 ⁽⁴⁾	4.4	IBM Software Group products are enabled ⁽⁶⁾	3.1 2.7 ⁽¹⁾	1.1 4.1 16 ⁽²⁾
zIIP Support	1.6	Not supported	N/A	Not Supported	Not supported
Crypto Remote Key Loading	1.6 ⁽⁴⁾	5.1	N/A		
Crypto ISO 16609	1.6 ⁽⁴⁾	5.1	N/A		
FICON Express4 (CHIPD type FC)	1.4 ⁽⁴⁾	4.4	SLES 9 RHEL 4	3.1 2.7 ⁽¹⁾	1.1 4.1PUT 16 ⁽²⁾
FICON Express4 (CHIPD type FCP)	N/A	4.4	SLES 9 RHEL 4	3.1	

1. indicates VSE/ESA

2. indicates TPF

3. IBM is working with its Linux Distribution Partners (LDPs) that this function will be provided in future Linux on System z distribution releases/service updates

4. Additional features or Web downloads required

5. IBM is working with LDPs on Kernel space exploitation⁽³⁾

6. Linux and z/VM do not support it, the IBM Software Group products are enabled for it on all distributions

Note: Please refer to the latest PSP bucket for latest PTFs for new functions/features z/OS.e - z800, z890 and z9 BC only

SLES = SUSE Linux Enterprise Server
RHEL = Red Hat Enterprise Linux

z9 BC and z9 EC – Enhanced performance on FICON

Modified Indirect Data Address Word (MIDAW) Facility

- **MIDAW facility – new system architecture and software exploitation designed to improve FICON performance**
 - ▶ Can improve FICON performance for
 - Extended format data sets – including DB2 and VSAM
 - ▶ Can improve channel utilization and can significantly improve I/O response times
 - Internal IBM DB2 Table Scan tests(*) with the z9 EC, FICON Express2 and the DS8000 control unit comparing MIDAW facility configurations to pre-MIDAW configurations showed:
 - 36% to 58% reduction in response times
 - 35% to 56% reduction in channel busy
 - 56% to 126% improvement in I/O throughput
 - ▶ Supported on z/OS 1.6 and above and corresponding supporting devices

* See Backup slide “Parallel DB2 Table Scan, EF 4K (single channel)” This document contains performance information

Performance is based on measurements and projections using standard IBM benchmarks in a controlled environment. The actual throughput or performance that any user will experience will vary depending upon considerations such as the amount of multiprogramming in the user’s job stream, the I/O configuration, the storage configuration, and the workload processed. Therefore, no assurance can be given that an individual user will achieve throughput or performance improvements equivalent to the numbers stated here.

Parallel DB2 Table Scan, EF 4K (single channel)

I/O Response Time (sec)

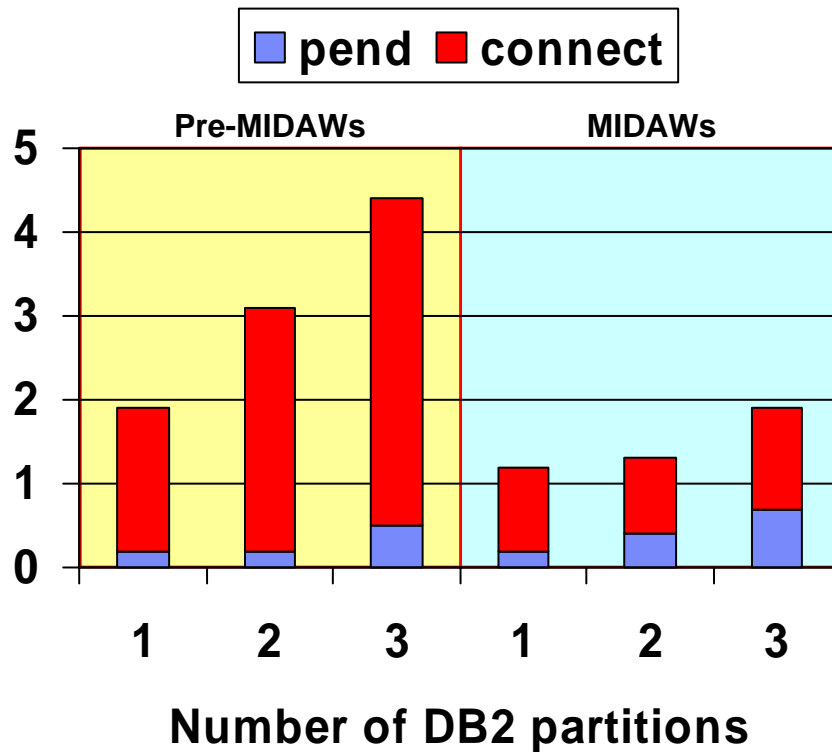

Configuration:

MIDAW : z/OS 1.7
 Pre-MIDAW: z/OS 1.4

 DB2 for z/OS Version 8
 4000 byte row size
 System z9 EC
 FICON Express2
 2 Gbit/sec link
 DS8000 control unit

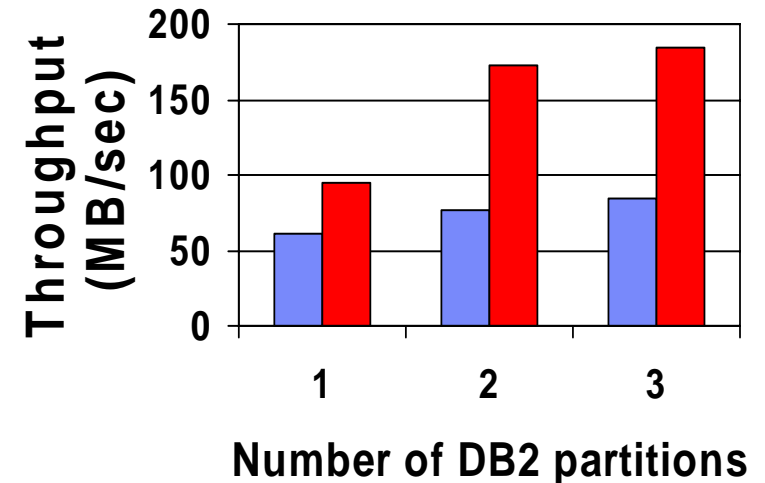
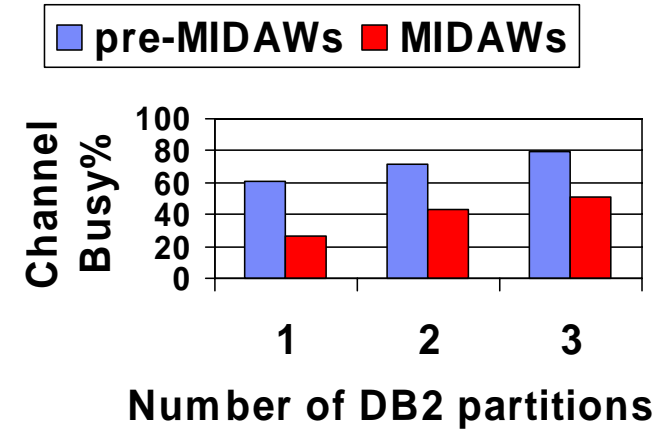

- This document contains performance information
- Performance is based on measurements and projections using standard IBM benchmarks in a controlled environment. The actual throughput or performance that any user will experience will vary depending upon considerations such as the amount of multiprogramming in the user's job stream, the I/O configuration, the storage configuration, and the workload processed. Therefore, no assurance can be given that an individual user will achieve throughput or performance improvements equivalent to the numbers stated here.

Directions for Data Encryption in IBM Storage

Statement of Direction

- ▶ Support of encryption capabilities within storage environments such that the capability does not require the use of host server resources (so called "outboard" encryption capabilities)
- ▶ Includes the intent to support outboard encryption and to leverage the centralized key management provided by z/OS ICSF
- ▶ First implementation of outboard encryption is planned for the IBM System Storage TS1120 Tape Drive in the second half of 2006. Plan is to include:
 - A chargeable microcode and hardware upgrade option for older TS1120 Tape Drives shipped before availability of the encryption feature
 - A new software program for management of encryption keys for tape drives across the enterprise – the new software may use standard key repositories, including ICSF on z/OS

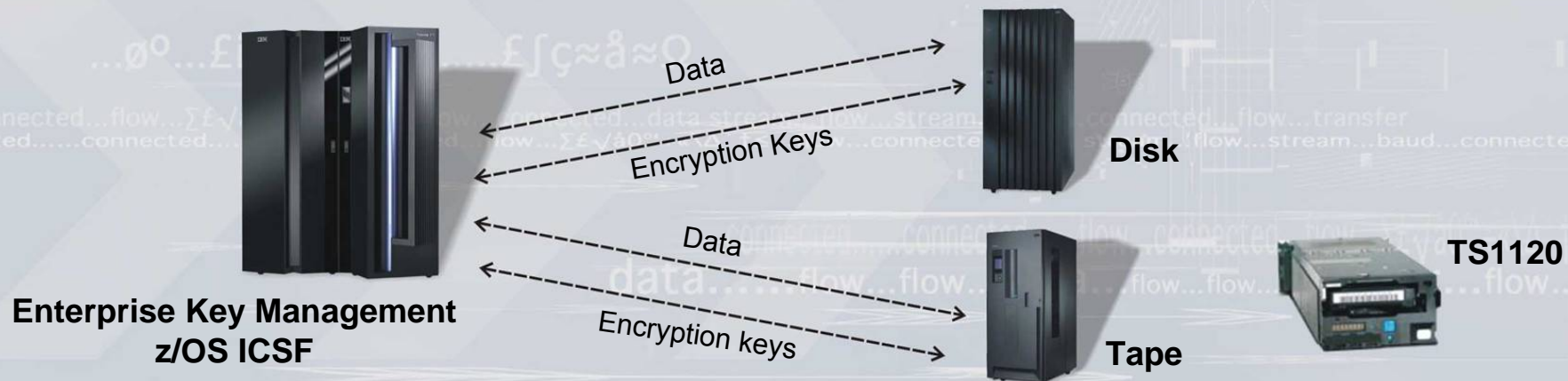

Improve data protection and resiliency across the IT infrastructure

IBM System Storage Disk: Supports FICON Express4



New Standard in Pricing and Packaging



DS6000

- Affordable pricing with the capabilities of traditional enterprise products
- Great performance in a modular package
- Can start small and grow in physical capacity – a great entry to midrange solution
- Up to 8 2 Gbps FICON/FC host ports

- Supports major types of servers including IBM System z, System i™, Linux, UNIX®, Microsoft® Windows®, . . .

- Industry leading copy services - compatible between DS6000, DS8000, IBM TotalStorage Enterprise Storage Server® (ESS) 800, ESS 750

- Common management tools and interfaces
- Designed for enterprise class reliability to help support continuous operations

New Standard in Functionality, Performance, TCO

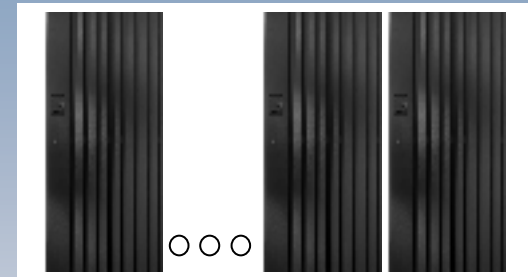

DS8000

- Excellent performance
- First class storage consolidation platform with physical capacity up to 192TB
- Options for model-to-model field upgrades help protect investment
- Up to 128 4 Gbps FICON/FC ports or 64 ESCON ports

IBM System Storage SAN: Supports FICON Express4



Midrange pricing with 4 Gbps performance



SAN Switches

- Affordable pricing with the capabilities of traditional enterprise directors
- Portfolio of 4 Gbps support for performance in a small form factor package
- Scalability features enable a “buy-and-grow” strategy
- Great entry to midrange solutions
- 16, 24, 32 FICON/FC port options
- Range of products supporting cascading with enterprise directors for tiered storage networks

- Supports major types of servers including IBM System z, System i, Linux, UNIX, Windows, . . .
- Industry leading SAN fabric interoperability
- Advanced automated management software
- Designed for enterprise class reliability to help support continuous operations
- Metro and global distance capability to support business continuity solutions

Enterprise availability and scalability with 4 Gbps performance



SAN Directors

- Enterprise class availability with built-in redundancy
- Support for SAN consolidation platform
- Scalability with support for non-disruptive upgrades
- 4 Gbps field upgrade options can help protect director investment
- Up to 256 FICON/FC ports
- 10 Gbps metropolitan links over optical networks
- Gigabit Ethernet global links over IP networks

IBM System Storage Tape: Supports FICON Express4



Tape Drives

- **LTO Gen 3 tape drive^{1,2}**
 - ▶ Supports up to 400 GB cartridge capacity⁴
 - ▶ Up to 80 MB/sec throughput⁴
- **TS1120 tape drive/controller**
 - ▶ Second generation tape drive
 - ▶ Controller supports ESCON & FICON
 - ▶ Tape drive data encryption in plan³
 - ▶ 100 & 500 GB cartridge capacity⁴



Tape Libraries

- **TS3310 tape library^{1,2}**
 - ▶ Stackable modular design
 - ▶ LTO Gen 3 only
- **3584 tape library**
 - ▶ Linear scalable design
 - ▶ LTO Gen 3^{1,2} & TS1120 tape drive
 - ▶ Advanced management function



Virtualization

- **TS7510 Virtualization Engine^{1,2}**
 - ▶ Up to 600 MB/sec throughput⁴
 - ▶ Up to 46 TB cartridge capacity⁴
- **Virtual Tape Server²**
 - ▶ Standalone or PtP deployment
 - Third site support in plan³
 - ▶ Advanced function
 - ▶ GDPS support

¹Linux on System z support only; ² 2 Gbps/sec only; ³Statement of Direction included in June 27, 2005 announcement; ⁴Uncompressed Capacity

More choice for your business

Evolution of specialty engines

Building on a strong track record of technology innovation with specialty engines, IBM introduces the System z9 Integrated Information Processor 



**IBM System z9
Integrated Information
Processor (IBM zIIP)** 

Designed to help improve resource optimization for eligible data workloads within the enterprise



**IBM System z
Application Assist
Processor (zAAP)
2004**

Designed to help improve resource optimization for z/OS Java technology-based workloads



**Integrated Facility
for Linux (IFL)
2001**

Support for new workloads and open standards

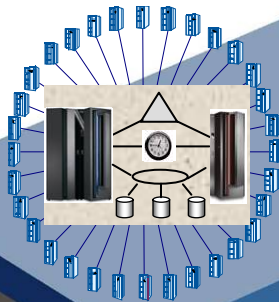

**Internal Coupling
Facility (ICF) 1997**

Centralized data sharing across mainframes

System z9 EC and BC – delivering new functions and features



- New IBM zIIP
- Granularity with entry one third the size of the 701
- Up to 54 configurable CPs
- Premier Availability server – with Enhanced Book Availability, RII and Enhanced Driver Maintenance
- MIDAW Facility
- FICON Express4
- Enhanced CPACF and Crypto Express2
- ATM/POS remote key loading
- Administrative On/Off CoD test
- Sub-capacity CBUs



- New low entry model
- New IBM zIIP
- Extreme Granularity
- Up to 7 PUs
- 37% more uni processor, up to 64 GB memory, 170% more bandwidth
- Sub-capacity CBUs and Administrative On/Off CoD Test
- Enhanced Driver Maintenance and RII
- MIDAW Facility and MSS
- NPIV and IPV6 Support for HiperSockets OSA-Express2 OSN (OSA for NCP)
- Enhanced CPACF with AES, PRNG and SHA-256 and Configurable Crypto Express2
- Temporary state changes allowed and new test/training option for On/Off CoD

Finding the server that meets your business needs

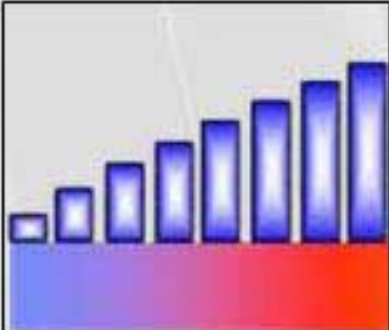
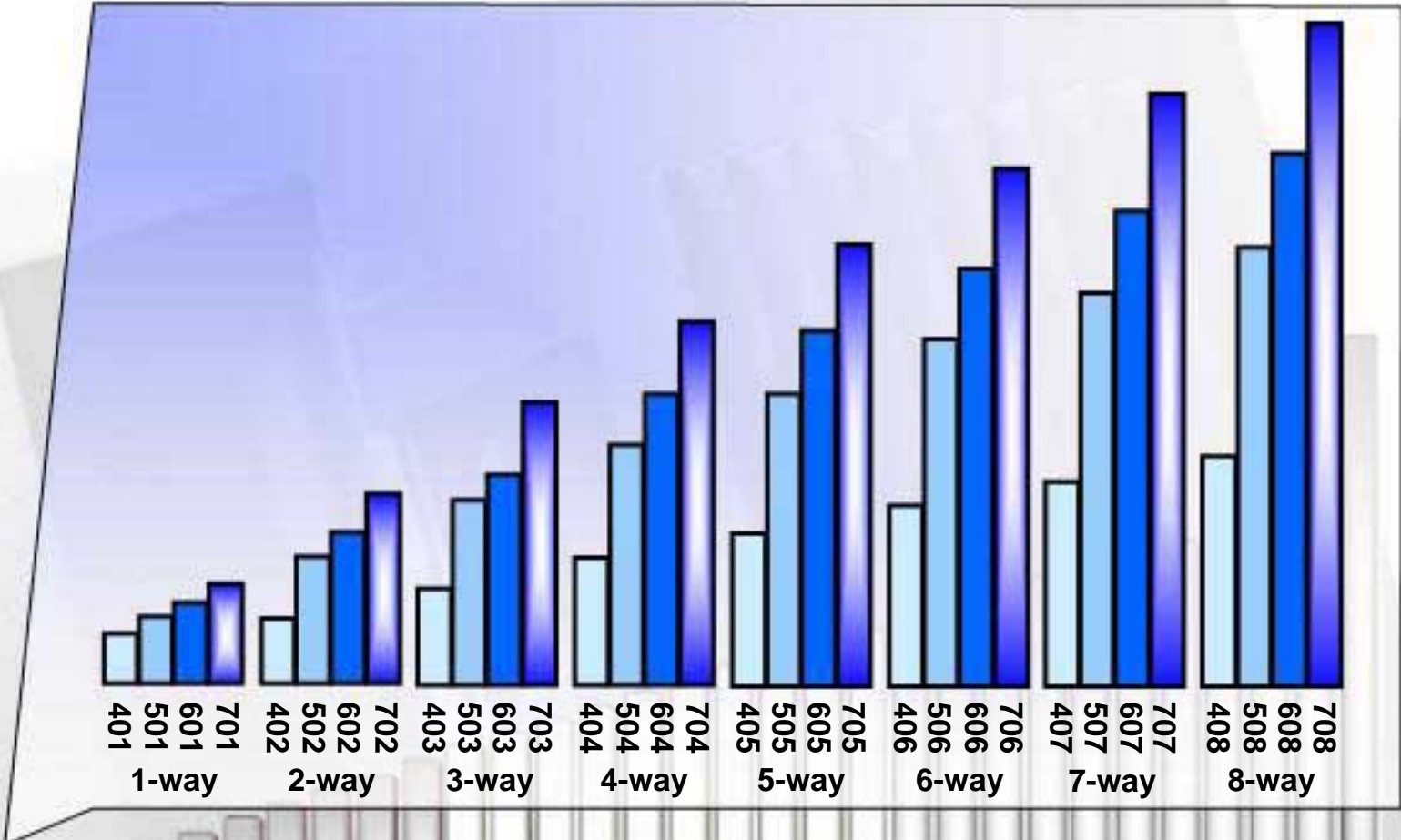

- The z9 EC will now offer 24 additional sub-capacity settings with the first eight general purpose (CP) engines
- Entry point is approximately one third the capacity of the 701
- All general purpose processors must be the same capacity within one z9 EC

z9 EC BACKUP foils

IBM System z9

The server designed to help protect, grow and meet the demands of enterprise of all sizes

The IBM System z9 Enterprise Class (z9 EC) – formerly called z9-109 – delivers excellence in enterprise computing and is designed and optimized for on demand business

- **Built on more than 40 years of industry leadership and taking that leadership to new levels**
 - ▶ Scalability
 - ▶ Availability
 - ▶ Security

- **It's time to rethink the role of the mainframe**
 - ▶ A mainframe for everyone
 - ▶ Helping to drive increased value from data and applications including announcing the availability of the System z9 Integrated Information Processor (zIIP)
 - ▶ Helping to simplify management and reduce costs of storage subsystems with new connectivity options

z9 EC



Bringing z9 EC innovation to a broader range of customers

System z9 EC . . . built to help protect and grow with your business

- **Capacity to meet your business objectives**
 - ▶ Capacity on demand for minimal downtime
 - ▶ Large mainframe server in a single footprint with the S54
 - ▶ Leadership capabilities to help improve I/O access *

- **Helping lower risk of downtime**
 - ▶ Leader in Parallel Sysplex clustering and GDPS services
 - ▶ Superior access to applications via comprehensive protection from unplanned and planned outages

- **Security features to help address compliance**
 - ▶ Industry certifications and regulatory compliance
 - ▶ Leadership capabilities in cryptography and encryption



* Performance is based on measurements and projections using standard IBM benchmarks in a controlled environment. The actual throughput or performance that any user will experience will vary depending upon considerations such as the amount of multiprogramming in the user's job stream, the I/O configuration, the storage configuration, and the workload processed. Therefore, no assurance can be given that an individual user will achieve throughput or performance improvements equivalent to the numbers stated here.

z9 EC Model Structure

A flexible model structure that can be optimized for your business

- **One machine type – 2094 – five models – S08, S18, S28, S38, and S54**
- **Model number indicates PUs available for characterization**
 - ▶ Single serial number
 - ▶ PU characterization is identified by number of features ordered
- **2 System Assist Processors (SAPs) per book**
- **2 spares standard per server**
- **z9 EC software models**
 - ▶ 700, 401 to 408, 501 to 508, 601 to 608 and 701 to 754
 - ▶ nxx, where n = the capacity setting of the engine, and xx = the number of PU characterized as CPs in the CEC
 - ▶ Once xx exceeds 08, then all CP engines are full capacity

Models	MCMs	Available PUs	Max Available Sub-capacity CP PUs 	Standard SAPs	Standard Spares	CP/IFL/ICF/zAAP/zIIP *****	Max Memory	Max Channels
S08*	1	12	8	2	2	8	128 GB	960 **
S18*	2	24	8	4	2	18	256 GB	1024 ***
S28*	3	36	8	6	2	28	384 GB	1024 ***
S38*	4	48	8	8	2	38	512 GB	1024 ***
S54*	4	64	8	8	2	54	512 GB	1024 ***

Notes:

* Must have a minimum of 1 CP, IFL or ICF

** There is a max of 64 ESCON features/960 active channels and a max of 64 FICON features/256 channels on Model S08.

*** The one for one relationship of zAAP or zIIP to CP still exists, but one CP can satisfy requirement for either or both specialty engines

**** Maximum of 16 ICFs

IBM System z9 EC overview

- **Machine Type**

- ▶ 2094

- **5 Models**

- ▶ S08, S18, S28, S38 and S54

- **Processor Units (PUs)**

- ▶ 12 PUs (16 for Model S54) per book
- ▶ 2 SAPs per book, standard
- ▶ 2 spares per server
- ▶ 8, 18, 28, 38 or 54 PUs available
 - CPs, IFLs, ICFs, zAAPs, zIIPs, optional SAPs

- **Memory**

- ▶ Minimum of 16 GB
- ▶ Up to 128 GB per book
 - 16 GB increments
- ▶ Up to 512 GB

- **I/O**

- ▶ Up to 16 STIs per book
 - 2.7 GB/s for each I/O and 2.0 GB/s for ICBs
- ▶ Total system I/O bandwidth capability of 172.8 GB*
- ▶ Up to 4 Logical Channel SubSystems (LCSSs)

* z9 EC exploits a subset of its designed I/O capacity



IBM System z9 EC Model S54

- **2094 Model S54**

- ▶ Four books required

- **Processor Units (PUs)**

- ▶ 16 PUs in each of four books
- ▶ 2 SAPs per book, standard
- ▶ 2 spares per server
- ▶ 1 - 54 PUs available
 - CPs, IFLs, ICFs, zAAPs, zIIPs, optional SAPs

- **Memory**

- ▶ Minimum of 16 GB
- ▶ Up to 512 GB
 - 16 GB increments at 128 GB per book

- **I/O**

- ▶ Up to 16 STIs per book
 - 2.7 GB/s for each I/O and 2.0 GB/s for ICBs
- ▶ Total system I/O bandwidth capability of 172.8 GB*
- ▶ Up to 4 Logical Channel SubSystems (LCSSs)

- **Upgradeability**

- ▶ Disruptive upgrade from zSeries and from other z9 EC models

* z9 EC exploits a subset of its designed I/O capacity



z9 EC – Delivering increased capacity and performance

▪ Delivering new levels of scalability

- ▶ Built on modular book design – one to four books
- ▶ Five models with one machine type
 - 1 to 38-way high performance server (four models)
 - Up to 54-way enhanced model for high performance and maximum capacity
- ▶ The z9 EC full capacity uniprocessor is expected to deliver 35% more capacity than the z990 uniprocessor *
- ▶ The S54 offers 95% more server capacity than z990 **
- ▶ Two spare processor units per server
- ▶ Increased memory – up to 512 GB per server
- ▶ Multiple Subchannel Sets (MSS) for an increased number of logical volumes
- ▶ Up to 60 logical partitions (2X improvement)

▪ Improved I/O Performance

- ▶ Up to 80%*** more bandwidth than the IBM eServer zSeries 990 (z990)
- ▶ Can improve FICON performance with Modified Indirect Data Address Word (MIDAW) facility
- ▶ New generation of FICON/FCP 

* LSPR mixed workload average. z9 EC-701 Vs z990-301

** This is a comparison of the z9 EC 54-way and the z990 D32 and is based on LSPR mixed workload average.

*** When comparing a z990 Model A08 with a z9 EC Model S08

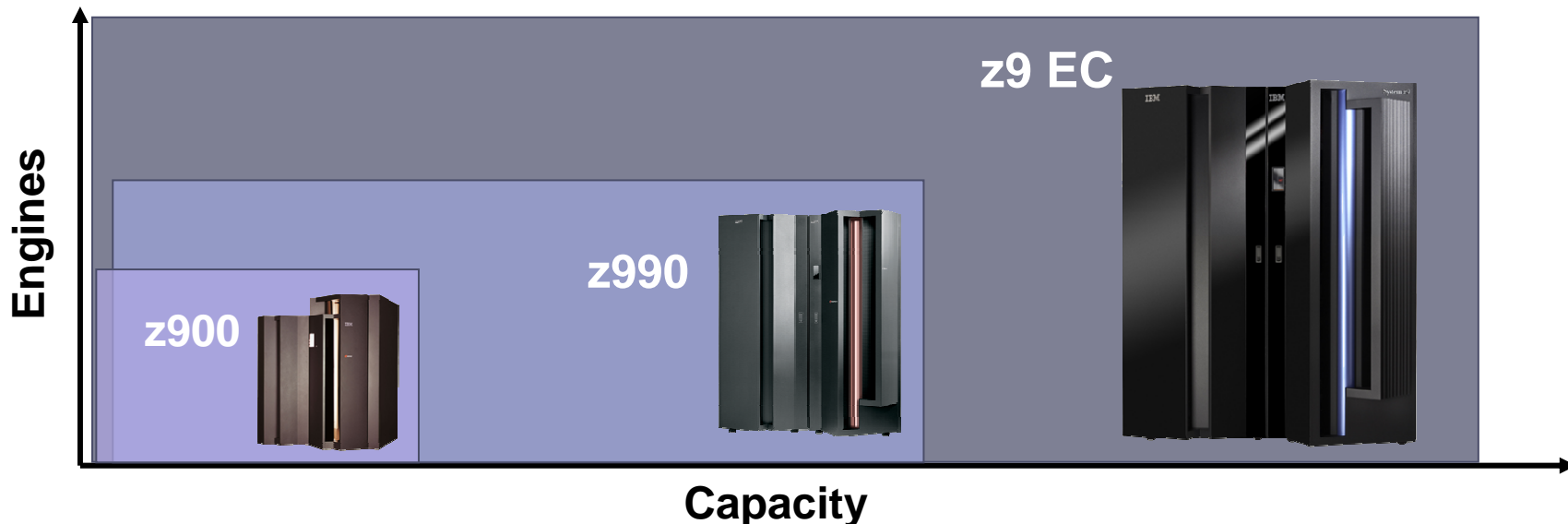

z9 EC – Providing new levels of availability

- **Improving the application of hardware driver maintenance:***
 - ▶ Potentially reducing planned outages using enhanced driver maintenance
- **New enhanced back availability and redundant I/O interconnect – increasing z9 EC's availability by helping to avoid unplanned outages:***
 - ▶ Enhancing recovery of resources
 - ▶ Improving ability to nondisruptively add and repair memory resources
- **Extending capability for Capacity Backup Upgrade (CBU) to include specialty engines**
- **Improving memory availability with flexible memory offering**

* Customer pre-planning is required and may require purchasing additional hardware resources



z9 EC – Enhancing security

- **Integrated cryptography features offer more security options on z9 EC**
 - ▶ Advanced Encryption Standard (AES) support in z9 EC hardware
 - ▶ Stronger hash algorithm with SHA-256
 - ▶ Pseudo Random Number Generator
 - ▶ ATM/POS remote key loading support ☀
- **Crypto Express2 improved flexibility and speed**
 - ▶ Configurability options, two coprocessors, two accelerators or one of each
 - ▶ With both adapters configured as accelerators each Crypto Express2 card is designed to provide up to 6000 SSL handshakes per second *
- **Secure encryption facility for z/OS to help protect data shared with partners, suppliers, and customers**
 - ▶ Designed to leverage z/OS key management and high performance hardware encryption
- **Can help to achieve higher levels of certifications and compliance** ☀
- **Virtualized cryptographic capabilities for card sharing by Linux virtual servers**
- **Complementary IBM technology and vendors' advanced security solutions**
 - ▶ Can enable a cross-platform model that can extend RACF® capabilities to the enterprise
 - ▶ Expansion of ISV community ensures application availability



z9 EC – Delivering enhanced connectivity for the system

Within the server, between servers, to the data and to the network



Within the Server

- Network in a box with HiperSockets
- Integrated console controller
- Integrated communications controller support (OSA for NCP)

To the Data

- Next generation 4 Gbps FICON/FCP 
- Up to 336 FICON or 1024 ESCON channels
- NPIV provides channel virtualization for Fibre channels
- FICON performance improvement with MIDAW facility

To the Network

- Performance assists for z/VM guests
- HiperSockets IPv6 support
- New 1000BASE-T support
- VLAN Mgmt – GVRP

For Clustering

- Parallel Sysplex
- Preview STP



Introducing FICON Express4 for System z9

- **Designed to improve capacity and performance with next generation 4 Gbps FICON/FCP**
 - ▶ Up to 25% improvement in FICON channel throughput when processing a mix of read and write data transfers¹
 - ▶ Up to 65% improvement in FICON channel throughput when processing all read or all write data transfers¹
 - ▶ 220% cumulative MB/sec throughput improvement in DB2 table scan tests for extended format data sets with FICON Express4 on z9 EC with the MIDAW facility compared to FICON Express2 with the IDAW facility on z9-109²
- **Helps to support reduced cost of storage operations and shorter backup windows with faster channel link data rates**
- **Enables migration to higher performance with 1/2/4 Gbps auto-negotiating links**

1. Large sequential data transfers on z9 EC with FICON Express4 operating at 4 Gbps (running z/OS V1.7) when compared to FICON Express2 on z9-109 (running z/OS V1.6)
2. Results of internal DB2 table scan tests with the z9 EC, the MIDAW facility, FICON Express4 operating at 4 Gbps (running z/OS V1.7), and the DS8000 compared to z9-109, and FICON Express2 operating at 2 Gbps (running z/OS V1.6)

Next generation 4 Gbps FICON/FCP ... helping to improve capacity and performance

Helping customers integrate data across the enterprise

The new IBM System z9 Integrated Information Processor (IBM zIIP)

Announcing
Availability

- **z/OS manages and directs work between the general purpose processor and the zIIP**
 - ▶ No changes anticipated to DB2 UDB for z/OS V8 applications
 - ▶ Number of zIIPs per z9 EC not to exceed number of general purpose processors
 - ▶ Price for each zIIP on the z9 EC is \$125,000 (US) *
 - ▶ No IBM software charges on the zIIP – consistent with other specialty engines
- **DB2 UDB for z/OS V8 will be first IBM exploiter of the zIIP with:**
 - ▶ System z9 EC
 - ▶ z/OS 1.6 or later
 - ▶ DB2 UDB for z/OS V8
- **Portions of the following DB2 UDB for z/OS V8 workloads may benefit from zIIP**:**
 - ▶ ERP, CRM, Business Intelligence and other enterprise applications – via DRDA over a TCP/IP connection
 - ▶ Data warehousing applications** – requests that utilize star schema parallel queries
 - ▶ DB2 UDB for z/OS V8 utilities** – select internal DB2 utility functions used to maintain index maintenance structures

* Prices may vary outside the US

** The zIIP is designed so that a program can work with z/OS to have eligible portions of its enclave Service Request Block (SRB) work directed to the zIIP. The above types of DB2 V8 work are those executing in enclave SRBs, of which portions can be sent to the zIIP.

z9 EC – Specialty engines

Delivering improved price/performance for new applications

- **Continuing support for integrated hardware specialty engines**
 - ▶ System z9 Integrated Information Processor (zIIP) 
 - ▶ System z Application Assist Processor (zAAP)
 - ▶ Integrated Facility for Linux (IFL)
 - ▶ Internal Coupling Facility (ICF)
- **z9 EC specialty engines provide price / performance improvements over z990**
- **Capacity BackUp (CBU) extended to specialty engines**
- **Management of specialty engines as individual types/pools**

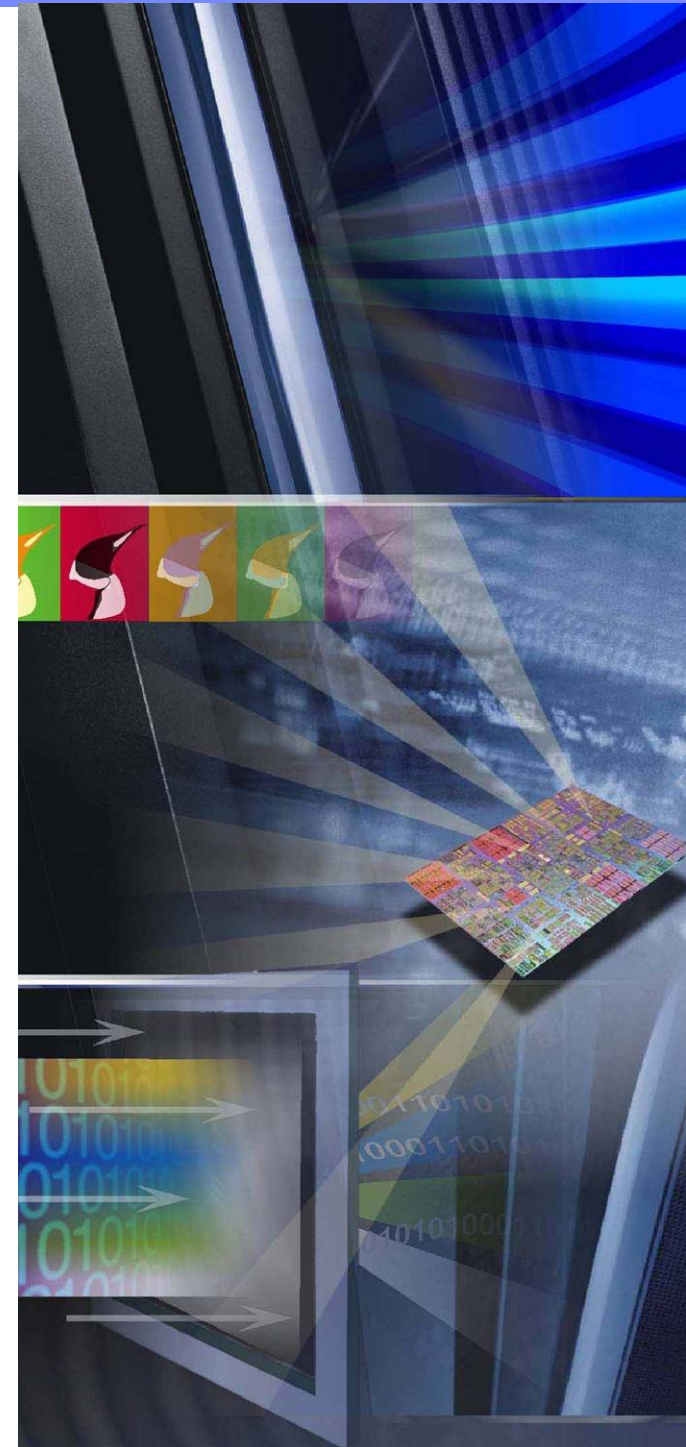

z9 EC Granular Capacity for up to 8 CPs

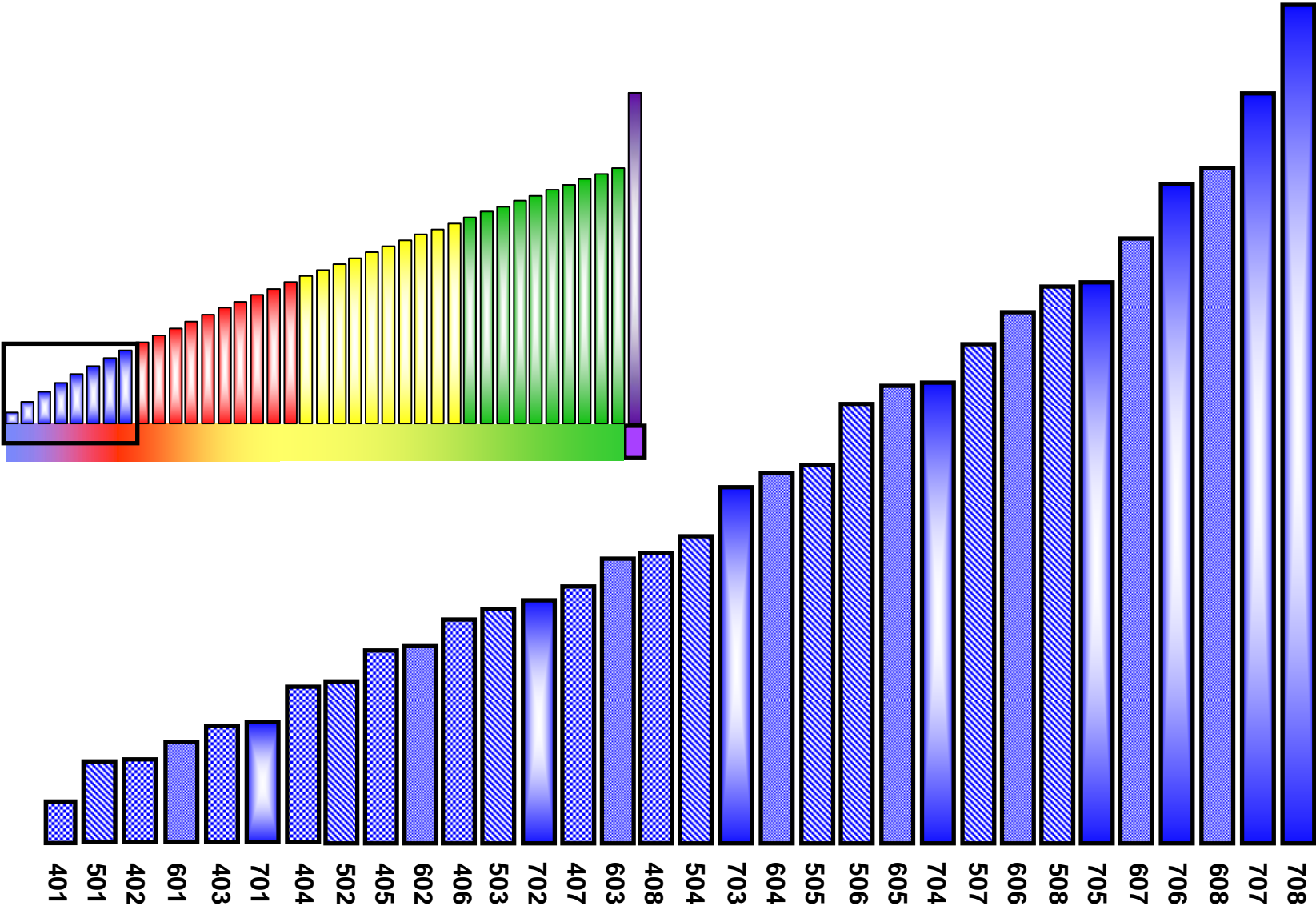

Protecting Your Investment in System z Technology

Enhanced flexibility for upgradeability

- **Full upgrades within the z9 EC**

- ▶ Including any to any upgradeability in the 32 sub-capacity matrix 🌟

- **Any to any upgrade from the IBM eServer zSeries 990 (z990), IBM eServer zSeries 900 (z900) - except Model 100, or IBM System z9 BC Model S07 🌟**

- **Capability of the System z9 servers to nondisruptively increase computing resources within the server such as processors, memory and I/O***

- ▶ Can enable dynamic and flexible capacity growth for mainframe servers
- ▶ Temporary capacity upgrade available through On/Off Capacity on Demand of CP processors, IFLs, ICFs, zAAPs or zIIPs 🌟
- ▶ New options for reconfiguring specialty engines if the business demands it 🌟
- ▶ New options for changing On/Off CoD configurations 🌟
- ▶ Sub-capacity CBU engines 🌟

* When properly configured. Also, upgrading to an S54 from other z9 EC models will require a planned outage

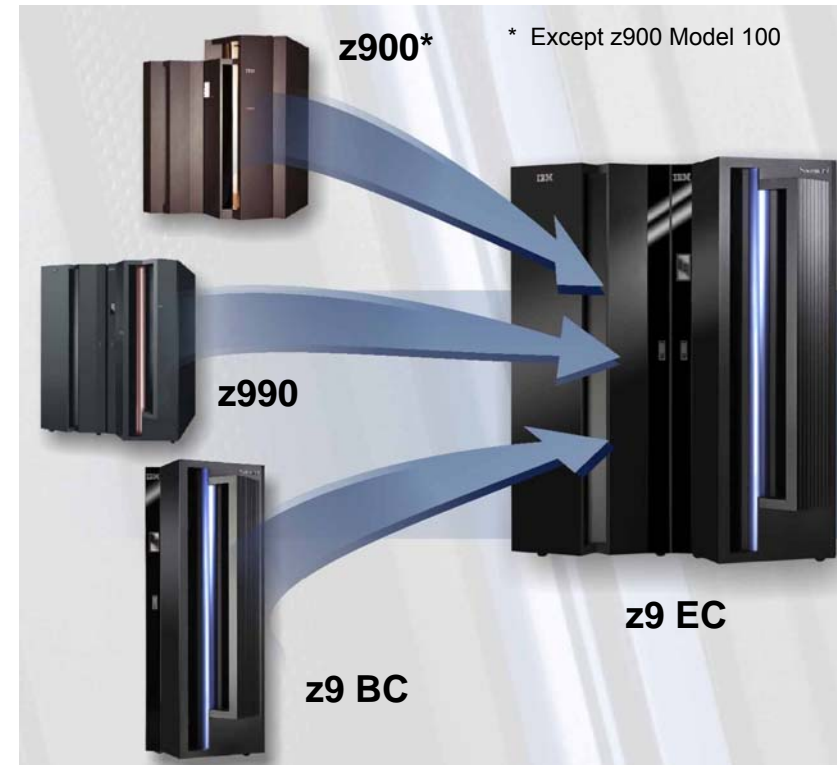

z9 EC delivering new functions and features



- New IBM zIIP
- 24 new sub-capacity models
- 5 New Hardware Models
- Faster Uni Processor *
- Up to 54 CPUs
- Up to 512 GB Memory
- Up to 60 LPARs
- CBU for specialty engines and sub-capacity
- Separate PU Pool Management
- Redundant I/O Interconnect
- Enhanced Driver Maintenance
- Enhanced Book Availability
- Dynamic Oscillator Switchover
- New FICON Express4
- Faster 2.7 GB STI and more of them *
- MIDAW facility
- MSS and 63.75K Subchannels for Set-0
- Up to 336 FICON Channels
- N_Port ID Virtualization
- IPv6 Support for HiperSockets
- OSA-Express2 1000BASE-T
- OSA-Express2 OSN (OSA for NCP)
- Enhanced CPACF with AES, PRNG and SHA-256 and Configurable Crypto Express2
- Capable of remote loading of ATM/POS keys
- Temporary state changes allowed and new test/training option for On/Off CoD

* Compared to z990

z9 EC – Under the covers (Model S38 or S54)

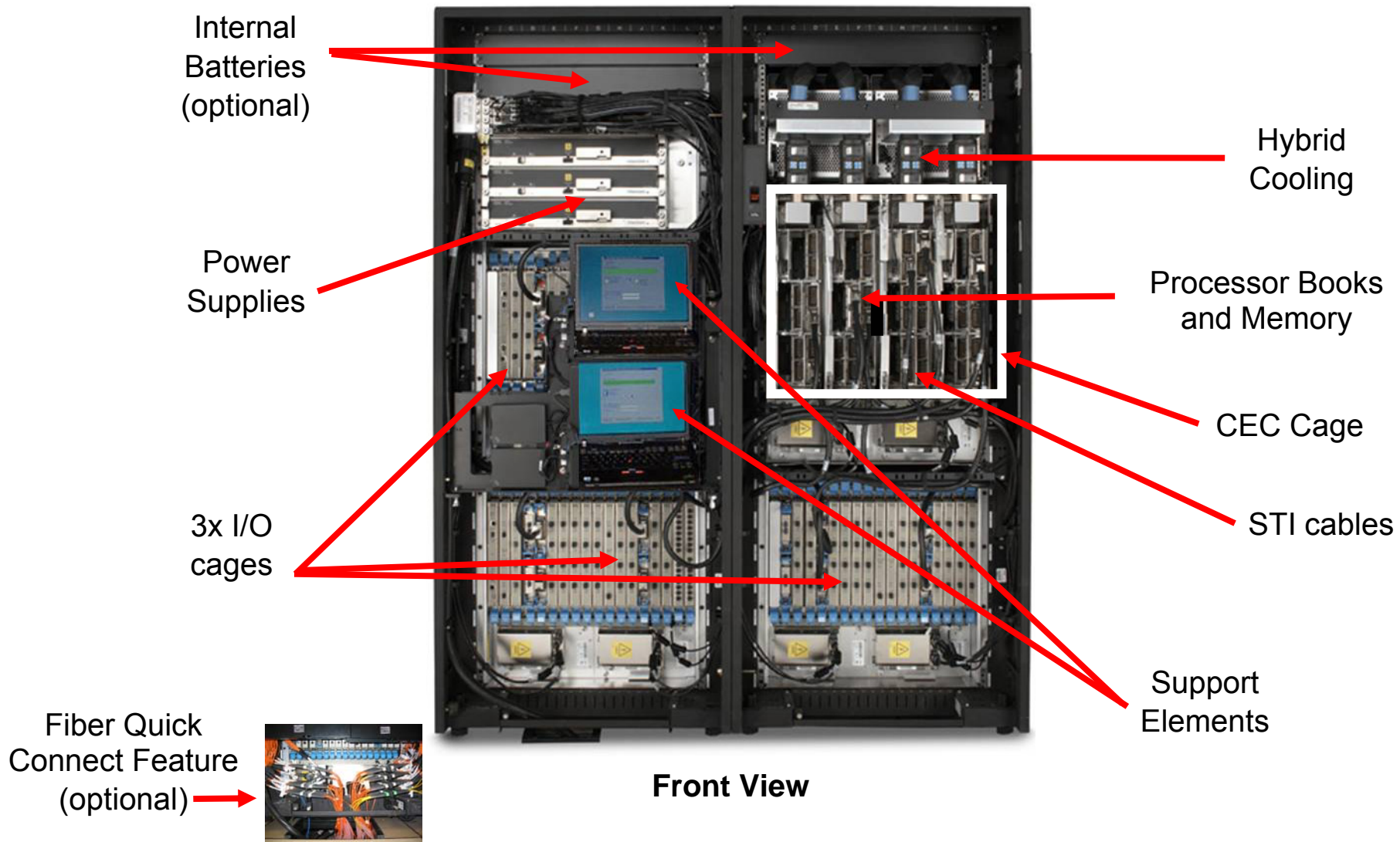

BACKUP z9 BC foils

The Mainframe Charter – Providing a Strategic Framework

It is our intention to...



Innovation

- Provide leadership in innovation to enhance the use of the IBM mainframe to support increasingly integrated and flexible business processes for the on demand business.*



Value

- Enhance the value proposition and lower the cost of computing of mainframe solutions in a way that is compelling, clear, and consistent.*



Community

- Support programs designed to foster vitality in the IBM mainframe community, helping to promote a strong application portfolio and world-class support services.*

* Excerpted from the Mainframe Charter – August 2003

Introducing the IBM System z9 BC

The server designed to protect, grow and meet the demands of enterprises of all sizes

The IBM System z9™ Business Class (z9 BC) delivers excellence in midrange and small enterprise computing and is designed and optimized for the on demand business



- **Built on more than 40 years of industry-acknowledged leadership and taking that leadership to new levels**
 - ▶ Scalability
 - ▶ Availability
 - ▶ Security
 - ▶ Virtualization
- **Breaking new ground**
 - ▶ A mainframe for everyone
 - ▶ Driving increased value from data and applications including announcing the availability of System z9 Integrated Information Processor (zIIP)
 - ▶ Simplifying management and reducing costs of storage subsystems with new connectivity options

z9 BC – Model R07 – An entry mainframe for the small enterprises

More flexibility, more specialty engines, more choices

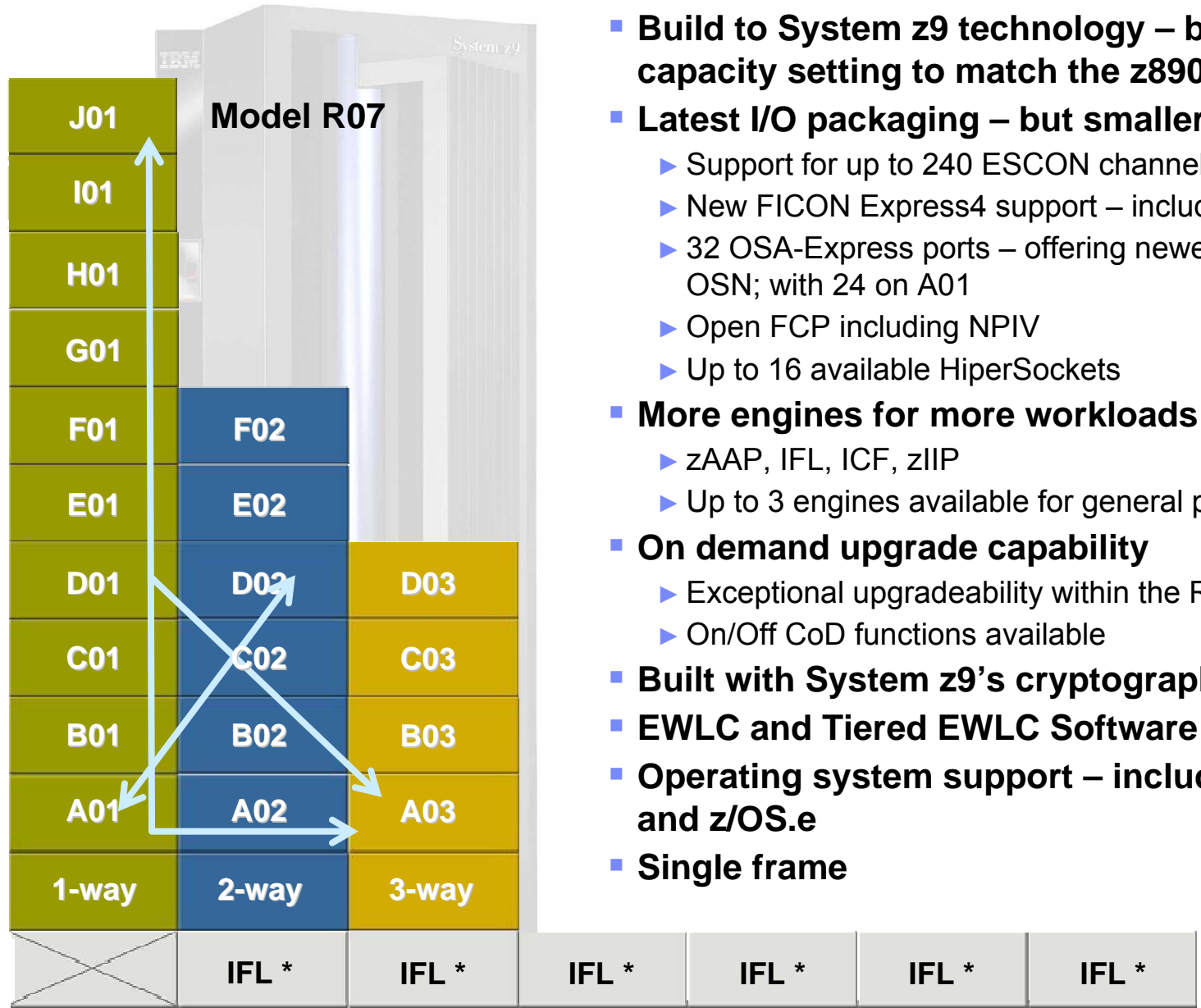

- **Build to System z9 technology – but available in the smallest capacity setting to match the z890 110**
- **Latest I/O packaging – but smaller capacity**
 - ▶ Support for up to 240 ESCON channels and/or 64 FICON channels
 - ▶ New FICON Express4 support – including a new 2-port card
 - ▶ 32 OSA-Express ports – offering newest functions like OSA ICC and OSN; with 24 on A01
 - ▶ Open FCP including NPIV
 - ▶ Up to 16 available HiperSockets
- **More engines for more workloads**
 - ▶ zAAP, IFL, ICF, zIIP
 - ▶ Up to 3 engines available for general purpose (CP)
- **On demand upgrade capability**
 - ▶ Exceptional upgradeability within the R07 and to the S07
 - ▶ On/Off CoD functions available
- **Built with System z9’s cryptographic and encryption functions**
- **EWLC and Tiered EWLC Software Pricing Structure**
- **Operating system support – including new versions of z/VSE and z/OS.e**
- **Single frame**

z9 BC – Model R07 – An entry mainframe for the small enterprises

More flexibility, more specialty engines, more choices

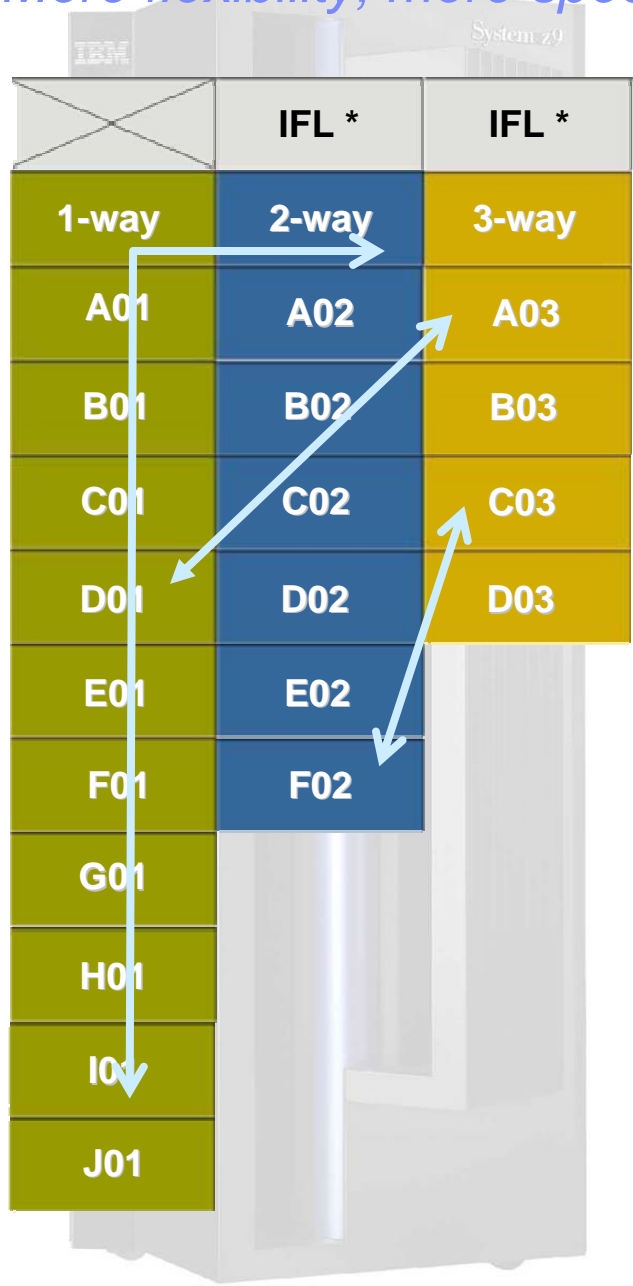

- **Build to System z9 technology – but available in the smallest capacity setting to match the z890 110**
- **Latest I/O packaging – but smaller capacity**
 - ▶ Support for up to 240 ESCON channels and/or 64 FICON channels
 - ▶ New FICON Express4 support – including a new 2-port card
 - ▶ 32 OSA-Express ports – offering newest functions like OSA ICC and OSN; with 24 on A01
 - ▶ Open FCP including NPIV
 - ▶ Up to 16 available HiperSockets
- **More engines for more workloads**
 - ▶ zAAP, IFL, ICF, zIIP
 - ▶ Up to 3 engines available for general purpose (CP)
- **On demand upgrade capability**
 - ▶ Exceptional upgradeability within the R07 and to the S07
 - ▶ On/Off CoD functions available
- **Built with System z9’s cryptographic and encryption functions**
- **EWLC and Tiered EWLC Software Pricing Structure**
- **Operating system support – including new versions of z/VSE and z/OS.e**
- **Single frame**

Performance Comparison

More flexibility for your business

- **Machine Type, 2 Models**

- ▶ 2096
- ▶ R07 and S07

- **8 Processor Units (PUs)**

- ▶ 1 SAP standard, 7 configurable PUs
- ▶ R07-up to 3 CPs and 4 Specialty engines
- ▶ S07-up to 4 CPs and 3 Specialty engines

- **Memory**

- ▶ Minimum 8 GB, maximum 64 GB, 8 GB increments

- **STI I/O Bandwidth**

- ▶ Up to 16 STIs at 2.7 GB/s
- ▶ Total system I/O bandwidth capability of 43 GB/s

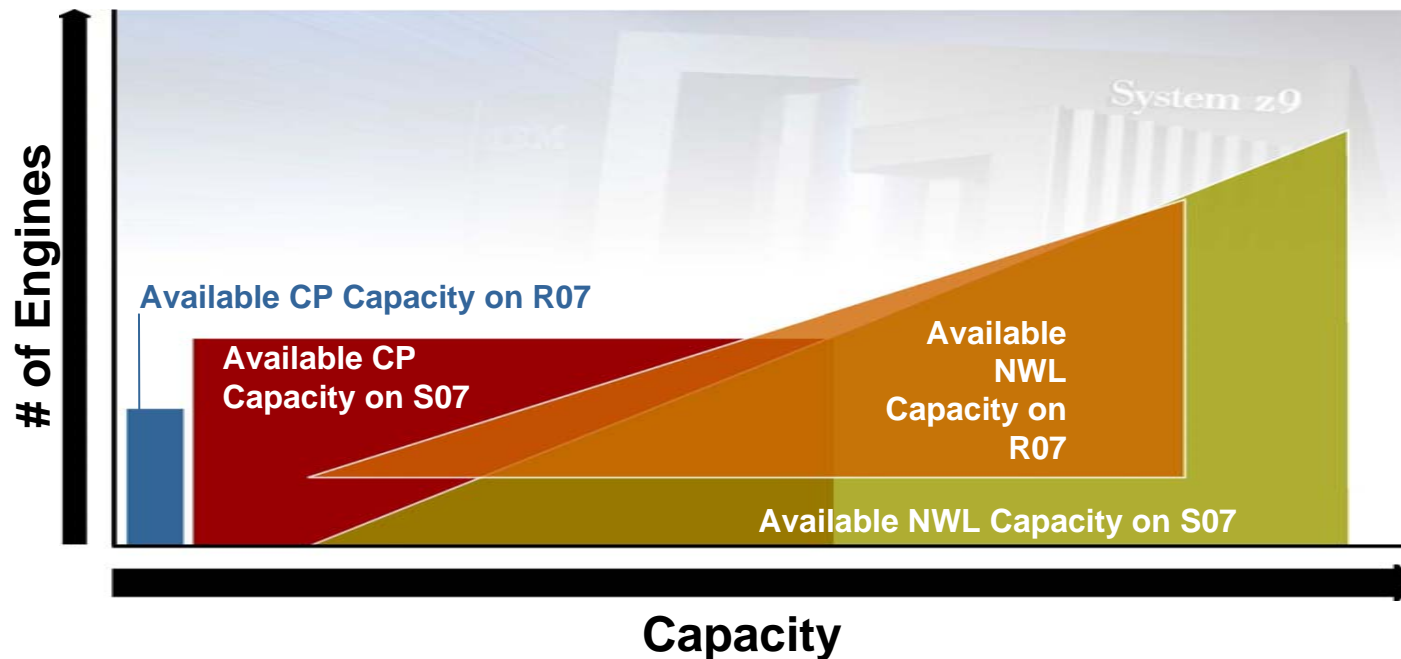

IBM zSeries 890 to System z9 BC comparison

z890

- **Processor Units (PUs)**
 - ▶ 4 PUs + 1 SAP
 - ▶ 0 - 4 CPs
 - ▶ 0 – 2 zAAPs (*no zIIPs*)
 - ▶ 0 – 4 IFLs or ICFs
 - ▶ 28 Capacity Settings

- **Memory**
 - ▶ 8 – 32GB

- **I/O**
 - ▶ 420 ESCON
 - ▶ 80 FICON Express2
 - ▶ 40 OSA-Express2 (2-port)
 - ▶ 16 Crypto Express2
 - ▶ 8 STIs

- **Coupling Links (64 max)**
 - ▶ 32 IC
 - ▶ 48 ISC-3 (peer mode only)
 - ▶ 16 ICB-3
 - ▶ 8 ICB-4



Model S07

- **Processor Units (PUs)**
 - ▶ 7 PUs + 1 SAP
 - ▶ 0 - 4 CPs
 - ▶ 0 – 3 zAAPs or zIIPs
 - ▶ 0 – 7 IFLs or ICFs
 - ▶ 53 Capacity Settings
(73 capacity settings on z9 BC)

- **Memory**
 - ▶ 8 – 64GB

- **I/O**
 - ▶ 420 ESCON
 - ▶ 112 FICON Express4
 - ▶ 48 OSA-Express2 (2-port)
 - ▶ 16 Crypto Express2
 - ▶ 16 STIs

- **Coupling Links (64 max)**
 - ▶ 32 IC
 - ▶ 48 ISC-3
 - ▶ 16 ICB-3
 - ▶ 16 ICB-4

z9 BC models have Sub-capacity CBU CPs and Specialty Engine CBU capabilities for more robust disaster recovery possibilities

z9 BC – Delivering Enhanced Connectivity for the System within the Server, Between Servers, to the Data and to the Network



Within the Server

- Network in a box with HiperSockets
- Integrated console controller
- Integrated communications controller support (OSA for NCP) ☀

To the Data

- Next generation 4 Gbps FICON/FCP ☀
- Up to 112 FICON ☀
- NPIV provides channel virtualization for Fibre channels ☀
- FICON performance improvement with MIDAW facility ☀

To the Network

- Performance assists for z/VM guests ☀
- HiperSockets IPv6 support ☀
- New 1000BASE-T support ☀
- VLAN Mgmt – GVRP

For Clustering

- Parallel Sysplex
- Preview STP

z9 BC – Enhancing Security

Protecting critical business data

- **New integrated cryptography features offer more security options**
 - ▶ Advanced Encryption Standard (AES) support in z9 BC hardware
 - ▶ Stronger hash algorithm with SHA-256 than available on z890
 - ▶ Pseudo Random Number Generator
 - ▶ ATM/POS Remote Key Loading support
- **Crypto Express2 improved flexibility and speed**
 - ▶ Configurability options, two coprocessors, two accelerators or one of each
 - ▶ With both adapters configured as accelerators each Crypto Express2 card is designed to provide up to 6000 SSL handshakes per second *
- **Encryption Facility for z/OS to help protect data shared with partners, suppliers, and customers**
 - ▶ Designed to leverage z/OS key management and high performance hardware encryption
- **Can help to achieve higher levels of certifications and compliance**
- **Virtualized cryptographic capabilities for card sharing by Linux virtual servers**
- **Complementary IBM technology and vendors' advanced security solutions**
 - ▶ Can enable a cross-platform model that can extend RACF capabilities to the enterprise
 - ▶ Expansion of ISV community ensures application availability



z9 BC – Providing new levels of availability

- **Improving the application of hardware driver maintenance:**
 - ▶ Potentially reducing planned outages using enhanced driver maintenance
- **Redundant I/O interconnect helps to avoid unplanned outages***
 - ▶ Designed to help maintain critical connections to I/O devices
- **Extending capability for Capacity Backup Upgrade (CBU) to include specialty engines**
 - ▶ Improving disaster recovery capabilities by extending temporary activation of IFLs, ICFs, zIIPs, and/or zAAPs
- **Dynamic Oscillator switchover**
 - ▶ Transparent switch over in the event of failure of the primary oscillator card

* Customer pre-planning is required and may require purchasing additional hardware resources



z9 BC – Specialty engines

Delivering improved price/performance for new applications

- **Continuing support for integrated hardware specialty engines**
- **z9 BC specialty engines provide price / performance improvements over z890**
- **Capacity BackUp (CBU) extended to specialty engines**
- **Management of specialty engines as individual types/pools**

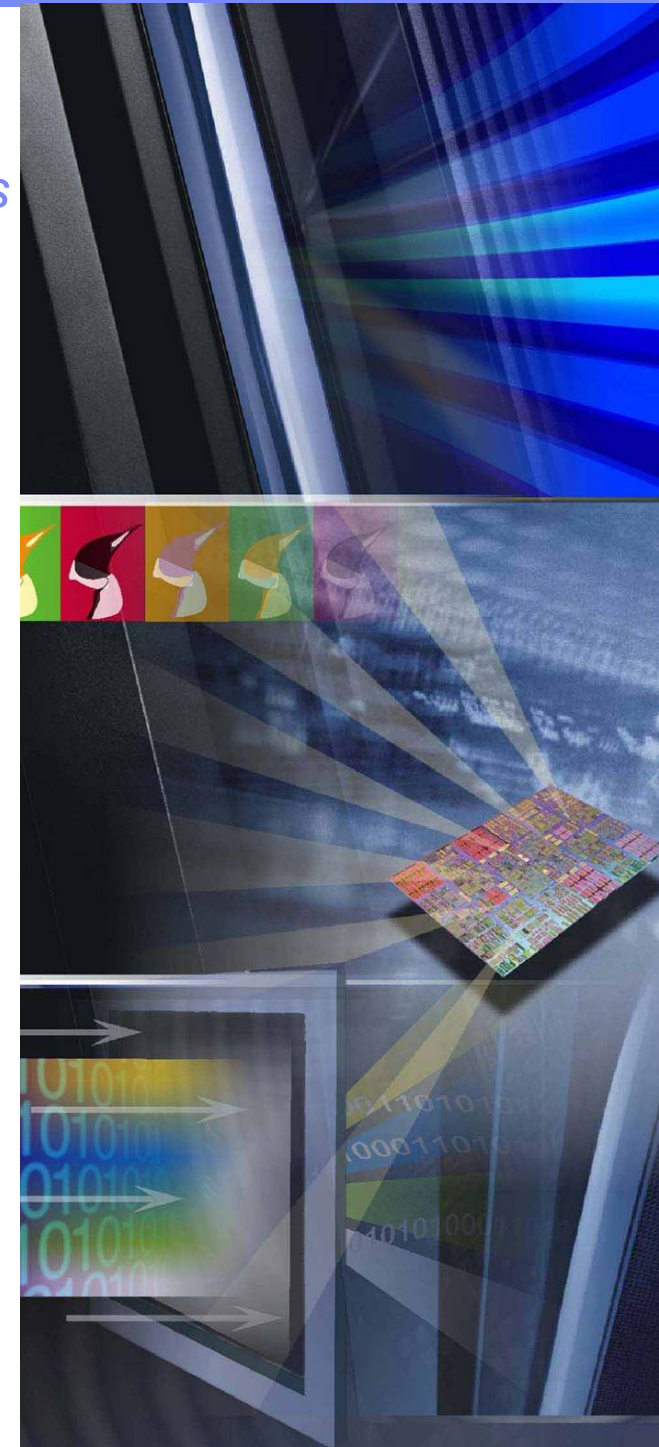

Protecting your investment in System z technology

- **Full upgrades within the z9 (R07 to S07 to z9 EC)** ☀
- **Any to any upgrade from the z890**
- **Upgrade from the z800 model 004**
- **No charge MES upgrades on IFLs and zAAPs**
- **Capability of the System z9 servers to nondisruptively increase computing resources within the server**
 - ▶ Can enable dynamic and flexible capacity growth for mainframe servers
 - ▶ Temporary capacity upgrade available through On/Off Capacity on Demand
 - ▶ Temporary, nondisruptive addition of CP processors, IFLs, ICFs, zAAPs or zIIPs ☀
 - ▶ New options for reconfiguring specialty engines ☀ if the business demands it
 - ▶ New options for changing On/Off CoD ☀ configurations
 - ▶ Sub-capacity CBU engines ☀

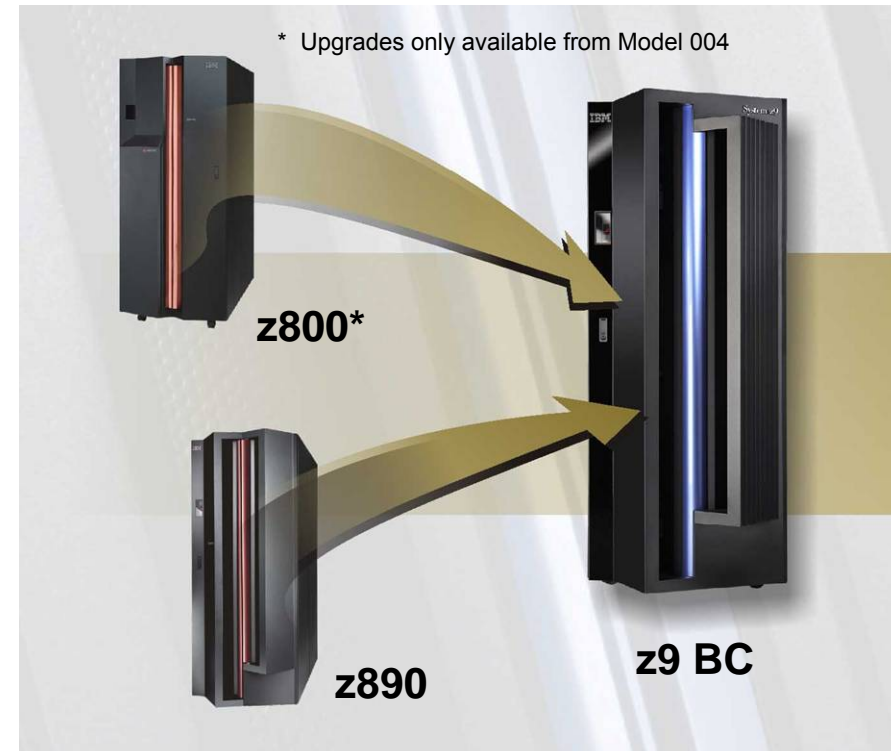

z9 BC delivering new functions and features

Leadership in Systems Innovation



*The server built to
protect and grow
with your on
demand enterprise*

- Two New Hardware Models
- Extremely High Granularity
- 37% Faster Uni Processor – up to 8 PUs*
- Full capacity specialty engine – ICF, IFL, zAAP and zIIP
- Up to 64 GB Memory
- CBU for specialty engines and sub-capacity
- Enhanced Driver Maintenance
- Redundant I/O Interconnect
- Dynamic Oscillator Switchover
- Separate PU Pool Management
- Faster 2.7 GB/s STI and more of them
- On/Off CoD Change State
- Up to 112 FICON Channels
- New FICON Express4 Channels
- New 2-port FICON Express4 card
- MIDAW facility
- Multiple Subchannel Sets per LCSS
- N_Port ID Virtualization
- IPv6 Support for HiperSockets
- OSA-Express2 1000BASE-T
- OSA-Express2 OSN (OSA for NCP)
- Enhanced CPACF with AES, PRNG and SHA-256
- Configurable Crypto Express2

* Compared to z890

z9 BC – Under the covers

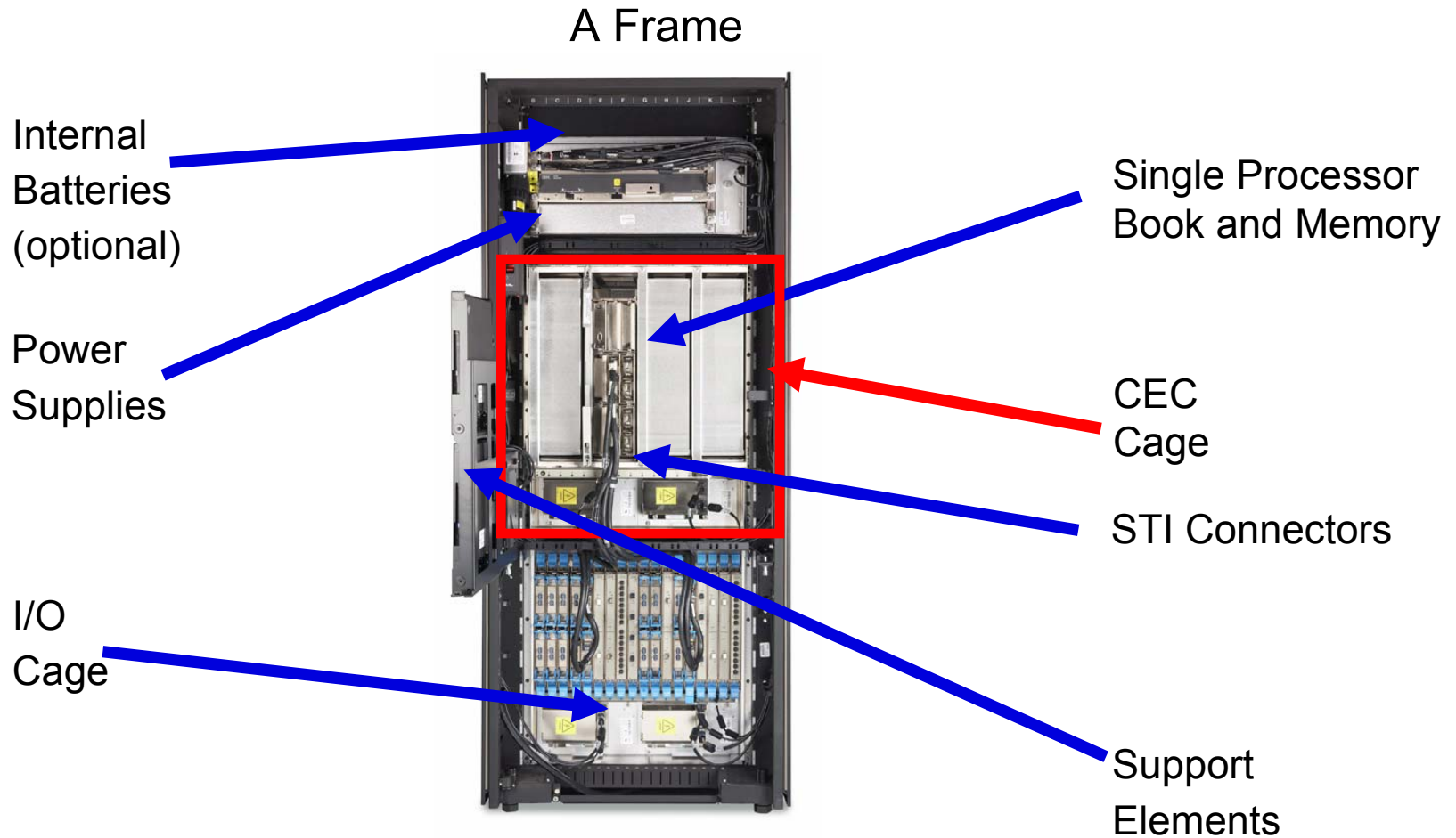

Fiber Quick Connect Feature (optional)



Front View

Standalone z9 BC Software Pricing

For Sub-Capacity Eligible Products *
 Entry Workload License Charges (EWLC)

For non Sub-Capacity Eligible Products
 EWLC Tiered Price Structure

EWLC Price Structure

Base	3 MSUs
Level 1	4 - 17 MSUs
Level 2	18 - 30 MSUs
Level 3	31 - 45 MSUs
Level 4	46 - 87 MSUs
Level 5	88 - 175 MSUs
Level 6	176 - 260 MSUs
Level 7	261+ MSUs

cumulative monthly pricing

EWLC Tiered Price Structure

Tier A	1-11 MSUs
Tier B	12-15 MSUs
Tier C	16-40 MSUs
Tier D	41 - 75 MSUs
Tier E	76 - 1500 MSUs
Tier F	1501+ MSUs



Flat monthly pricing.
 Select the tier based on the MSU rating of your server

* Note: The z9 BC Model A01 is priced using zSeries Entry License Charges (zELC).

Leadership in systems innovation

- **New family member and capacity settings gives you a choice in selecting the right sized mainframe for your business**
- **Leadership in data and transaction serving with continued IBM platform focus to enable on demand business across the enterprise**
- **Helping to improve capacity and performance in accessing data with the next generation of 4 Gbps FICON/FCP**



System z continues to leverage its leadership in security and resiliency, intelligent management, and business integration capabilities and offers new options for managing the IT infrastructure

BACKUP Operating System Foils

z/OS: At a glance

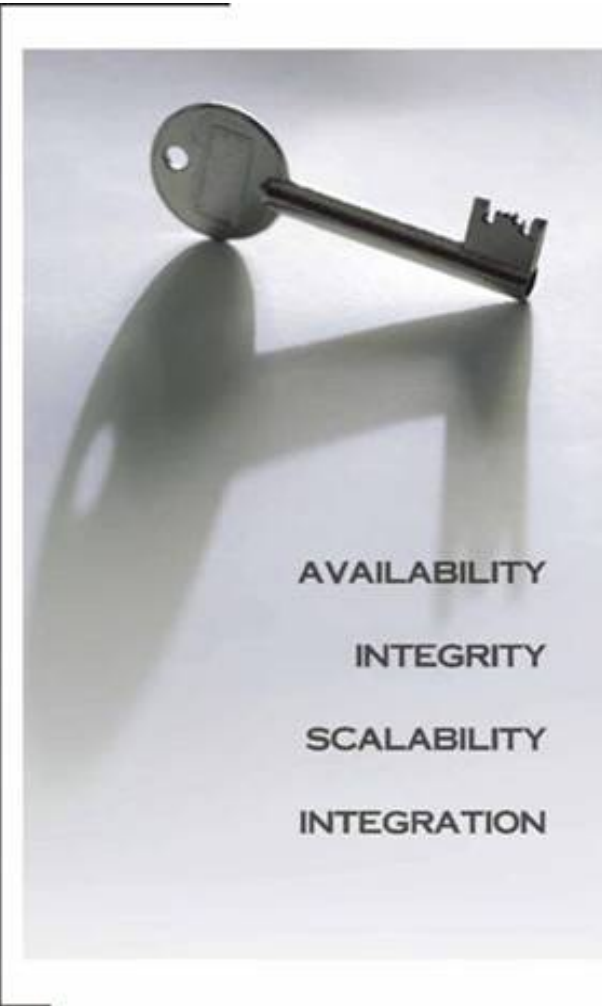

World-class computing for
On Demand Business

z/OS 1.7 GA: September 2005

Simplifying z/OS management for new IT professionals

- ▶ Easier to configure with “best practices”
- ▶ Simplified networking and network security
- ▶ New user interface for z/OS management

Extending z/OS capabilities and qualities of service

- ▶ Extending z/OS resiliency and security
- ▶ Further performance optimization for TCP/IP networking
- ▶ Improved scale with support for large I/O configurations (Requires System z9)
- ▶ Enhancements for business integration and application security

z/OS 1.6 GA: September 2004

▪ Integrating new applications

- ▶ Improved Java integration with support for zAAP
- ▶ Increased scale and performance with 64-bit C/C++ and 64-bit Java

▪ Increased availability and scale

- ▶ TCP/IP Sysplex enhancements
- ▶ 32-way single image in z990 logical partition

▪ Increased optimization of resources

- ▶ DFSMS placement of critical datasets on Parallel Access Volumes

z/VM on System z9

Using the System z9 operating systems to help you control your IT infrastructure

■ Unify the infrastructure

- ▶ z/VM V5.2 provides enhanced exploitation of large real memory which may provide constraint relief and cost savings and improved memory management between z/VM and Linux on System z *

■ Leverage the mainframe data serving strengths

- ▶ z/VM V5.2 provides improved performance of SCSI disk I/O **
- ▶ z/VM V5.2 exploitation of the IBM TotalStorage including support for Parallel Access Volumes (PAVs) for z/VM system data and guest data

■ A secure and flexible business environment

- ▶ z/VM V5.2 supports Crypto Express2 as an accelerator card for Crypto sharing among Linux guests
- ▶ z/VM V5.2 improves FCP channel sharing with support for N_Port ID Virtualization ***
- ▶ z/VM V5.2 offers enhanced performance assists for guests

■ Leverage strengths across the infrastructure

- ▶ z/VM V5.2 simplifies user administration with the coordination of DirMaint™ and RACF changes
- ▶ z/VM virtualization technologies host all System z operating systems, including Linux on System z

* Compared to previous releases of z/VM

** Compared to z/VM V5.1

*** Compared to FCP LUN Access Control



z/VSE on System z9

Using the System z9 operating systems to help you control your IT infrastructure



■ Unify the infrastructure

- ▶ z/VSE V3* connectors and web services (SOAP and XML).

■ Leverage the mainframe data serving strengths

- ▶ z/VSE V4** (when available) Previews exploitation of z/Architecture and 64-bit real memory
- ▶ z/VSE V3* supports SCSI disk I/O
- ▶ z/VSE V3* exploitation of IBM TotalStorage, including support for VTS

■ A secure and flexible business environment

- ▶ z/VSE V3* supports Crypto Express2 and CPACF
- ▶ z/VSE V3* Basic Security Manager (BSM) enhancements
- ▶ z/VSE V3* supports N_Port ID Virtualization

■ Leverage strengths across the infrastructure

- ▶ z/VSE V3* connectors and Web services (SOAP and XML)
- ▶ z/VSE V3* supports or interfaces with key IBM Middleware.

* z/VSE V3 can execute in 31-bit mode only. It does not implement z/Architecture, and specifically does not implement 64-bit mode capabilities. z/VSE V3 is designed to exploit selected features of IBM System z hardware.

** All statements regarding IBM's plans, directions, and intent are subject to change or withdrawal without notice,...

SOD: It is IBM's intent to provide new software pricing for z/VSE V4 when running on select processors, subject to applicable terms and conditions. IBM expects this new software pricing metric to provide more granularity and a sub-capacity pricing option.

Linux on IBM System z9

Using the System z9 operating systems to help you control your IT infrastructure

■ **Unify the infrastructure**

- ▶ IT optimization and server consolidation based on virtualization technology and Linux
- ▶ Linux can help to simplify systems management with today's heterogeneous IT environment

■ **Leverage the mainframe data serving strengths**

- ▶ New solution deployed in less time, accessing core data on DB2 on z/OS
- ▶ Reduced networking complexity and improved security network “inside the box”

■ **A secure and flexible business environment**

- ▶ Linux open standards support for easier application integration
- ▶ Virtual growth instead of physical expansion on Intel® or RISC servers

■ **Leverage strengths across the infrastructure**

- ▶ Superior performance, simplified management, security rich environment
- ▶ Backup and restore processes, Parallel Sysplex and GDPS for Disaster Recovery

* All statements regarding IBM future direction and intent are subject to change or withdrawal without notice, and represents goals and objectives only.

Utilize open and industry based standards with System z9

Help meet unified IT infrastructure objectives with System z virtualization technology and Linux

IBM can help you build an optimized, unified IT infrastructure for your applications

Infrastructure Simplification

- Virtual growth instead of physical expansion on Intel or RISC servers
- Consolidation of many physical servers, quickly and easily provisioned and deployed
- Optimal resource utilization through sharing of resources and applications
- Network simplification through highly virtualized internal network
- Easier systems management through Single-Point-of-Control for administration and operation

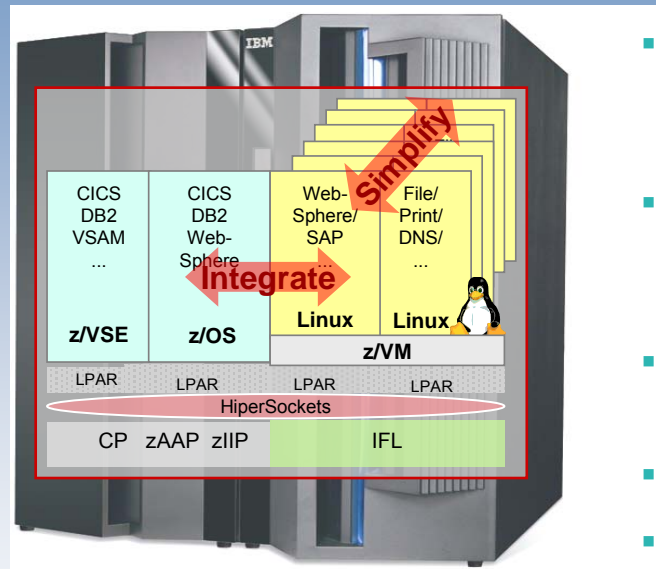

Business Integration

- New solutions deployed in less time, and with more efficient transaction processing
- Rapid access to enterprise data and applications through the internal network
- Superior performance, simplified management, security rich environment
- Offsite disaster recovery with GDPS
- Integration is supported by IBM middleware from DB2, Lotus®, Rational®, Tivoli® and WebSphere®.

Linux on System z can help to integrate and simplify distributed applications to minimize cost and maximize manageability.

z/TPF on System z9

Using the System z9 operating systems to help you control your IT infrastructure

▪ Unify the infrastructure

- ▶ Server consolidation allowing you to choose the right platform for the business process while
 - Reducing cross platform latency
 - Simplifying systems management

▪ Leverage the mainframe data serving strengths

- ▶ z/TPF V1
 - Clusters from 1 of up to 1728 processors
 - Accessing 40K (nearly 1000 TB) TotalStorage database
 - z/Architecture exploitation

▪ A secure and flexible business environment

- ▶ z/TPF V1 open systems development environment combined with the scalability and availability of the mainframe
- ▶ z/TPF Cryptography Support*
- ▶ z/TPF V1 Workload Pricing Option**

▪ Leverage strengths across the infrastructure

- ▶ TPF and z/TPF Web Based Protocols
 - Web Services, SOAP, XML, WebSphere MQSeries® for TPF, http, POP3, IMAP, SMTP

* TPF 4 and z/TPF V1 supports CPACF and PCICA cryptography cards with a Statement of Direction to support the Crypto Express/2 on z/TPF V1

** Workload pricing for z/TPF SOD 10/05