

System Automation for OS/390



CICS Automation Programmer's Reference and Operator's Guide

Version 2 Release 2

System Automation for OS/390



CICS Automation Programmer's Reference and Operator's Guide

Version 2 Release 2

Note!

Before using this information and the product it supports, be sure to read the general information under "Notices" on page ix.

Sixth Edition (December 2002)

This edition applies to System Automation for OS/390 Version 2 Release 2 (5645-006), an IBM licensed program, and to all subsequent releases and modifications until otherwise indicated in new editions.

References in this publication to IBM products, programs, or services do not imply that IBM intends to make these available in all countries in which IBM operates.

A form for readers' comments appears at the back of this publication. If the form has been removed, address your comments to:

IBM Deutschland Entwicklung GmbH
Department 3248
Schoenaicher Strasse 220
D-71032 Boeblingen
Federal Republic of Germany

FAX: (Germany) 07031-16-3456
FAX: (Other countries) (+49)+7031-16-3456

Internet: s390id@de.ibm.com

When you send information to IBM, you grant IBM a nonexclusive right to use or distribute the information in any way it believes appropriate without incurring any obligation to you.

© Copyright International Business Machines Corporation 1990, 2002. All rights reserved.

US Government Users Restricted Rights – Use, duplication or disclosure restricted by GSA ADP Schedule Contract with IBM Corp.

Contents

Figures v

Tables vii

Notices ix

Programming Interface Information ix
Trademarks x

About This Book. xi

Who Should Use This Book xi
What's in This Book xi
Notation for Format Descriptions xi
Related Publications xii
 The System Automation for OS/390 Library xii
 Related Product Information xiii
 Using LookAt to look up message explanations xiv
 Accessing z/OS™ licensed documents on the
 Internet xv

Part 1. Introducing CICS Automation 1

Chapter 1. Concepts of SA OS/390 . . . 3

Automation Policies 3
Goal-Driven Automation 4
Dependencies, Request Propagation, and Desired
State 4
Persistency of Requests and Conflicting Requests 6
Triggers 7
Service Periods 8
Application Groups 8
SA OS/390 and the NetView Message Automation
Table 9

**Chapter 2. Functions of CICS
Automation 11**

Link Monitoring 11
Health Checking 11
State/Action Tables 11
Recovery 13
Program-to-Program Interface 13
 NetView Components 13
 CICS Components 13
 Communication Components 13

**Part 2. Customizing CICS
Automation 15**

**Chapter 3. Customizing CICS
Automation 17**

CICS Automation Definitions in NetView 17
 Step 1: Basic CICS Automation Common Policy
 Definitions 17

 Step 2: Basic CICS Application Definitions 17
 Step 3: The Program-to-Program Interface
 Initialization Member (EVENTASK) 19
 Step 4: Adding a New CICS Automation Status
 File Record 19
 Step 5: Installing CICSplex SM REXX API 19
Extended CICS Definitions 19
 Step 1: Health Check Programs 20
 Step 2: Program-to-Program Interface
 Initialization Member (CICS) 20
 Step 3: Add or Change the CICS Transient Data
 Messages 21
 Step 4: Add or Change the USER Transient Data
 Messages 21
 Step 5: Echoplex Back-End Programs 21
 Step 6: Security Considerations 21
 Step 7: Define a NetView PPI receiver task 22
 Step 8: Define a CICS PPI receiver task 23
CICS Automation Definitions for CICSplex System
Manager (CPSM) 23
 Automating Coordinating Address Space (CAS)
 Startup and Shutdown. 23
 Automating CICSplex SM Address Space
 (CMAS) Startup and Shutdown. 23
Migration and Coexistence 24
 Migration 24
 Coexistence between V1R4 and V2R2. 26

**Chapter 4. How to Set Up the
Functions of CICS Automation 27**

Defining the SDF States for CICS Automation 27
Automating Recovery For Transactions 28
 How to Define Transaction Recovery 29
 How to Set Up the State/Action Tables 32
 How to Set Up Health Checking 33
 How to Set Up Link Monitoring 35
 Setting Up Echoplexing 35
Security Checking Using CICS 35
Adding Local Applications to the CICS Automation
Operator Interface 36
Using Linemode Functions 38
 Health Checking. 38
 SIT Override 38
 Link Monitoring. 38
 Message options. 38
 CICSPOST. 38
 CEMTPPI 39
How to Implement Remote Site Recovery for VSAM
RLS (CICS TS Function Only) 39
Special Considerations for RACF-Protected
Subsystems 39
Special Considerations for Collecting CPSM alerts 40

**Chapter 5. MESSAGES/USER DATA
Entries for CICS Automation 41**

Translating Format Descriptions into MESSAGES/USER DATA Entries	41
CICS-Specific MESSAGES/USER DATA Keywords	46
ABCODESYSTEM—System abend recovery	48
ABCODETRAN—Transaction Abend Recovery	50
HEALTHCHK—Health Checking	52
LISTSHUT—Transaction Purging During Shutdown	54
RCVRAUTO—Autoinstall Time Limit	55
RCVRSOS—Short-On-Storage Handling	56
RCVRTRAN—Transaction Recovery	58
RCVRVIOL—Storage Violation Handling	59
CICSINFO - Display Information	60

**Chapter 6. CICS Automation Routines,
Commands, and Definition Members . . . 61**

Subroutines	62
CICSQRY—Name Lookup	63
CICSRCMD—Request a CICS Function	66
Commands and Common Routines	67
CEMTPPI—CEMT PPI Short Syntax	69
CICSDLY—Change the Shutdown Delay Time	70
CICSPOST—Post An External Event	71
CICSPURG—Purge Transactions	72
CICSRSYC—CICS Resync	73
CICSSHUT—Shutdown Processor	74
EVEED003—Critical Message Handler for the Status Display Facility	76
EVEERDMP—CICS Dump	77
EVEEMIGR—Migrate Subsystem to CICS/TS	78
EVEEY00S—Common State Handler for State/Action Tables	79
CICSHLTH—Linemode Health Checking	80
CICSOVRD—Linemode SIT Override	82
CICSLM—Linemode Link Monitor	84
CICSMHDR—Linemode Message Options	87
CMASSHUT—CICSplex SM Address Space (CMAS) Shutdown	89
INGCICS - Issue CICS Operator Commands	90
Definition Members	91
EVESPINM—CICS PPI Initialization Member	92
EVENTASK—NetView PPI Initialization Member	94
EVESCMT3—Message Exit Table for CICS	96
EVESCMT4—XTDOUT Exit Table for CICS	98

Part 3. Using CICS Automation 101

**Chapter 7. Using Panels and Working
with Subsystems 103**

Using CICS Automation Panels	103
--	-----

Using the Main Menu	103
Selecting and Viewing Subsystems	104
Selecting a Subsystem	104

**Chapter 8. Starting and Stopping
Resources. 107**

Startup	107
Shutdown	109

**Chapter 9. Monitoring Your CICS
Subsystems 111**

Link Monitoring	111
Displaying Links	112
Health Checking	115

Chapter 10. Broadcasting Messages 119

**Chapter 11. The Status Display
Facility 121**

Chapter 12. NMC Display Support . . . 125

**Appendix. CICS Automation and the
Program-to-Program Interface 127**

Program-to-Program Interface Components in NetView and CICS	127
NetView Requests Using the Program-to-Program Interface	128
CONVERSE from NetView	128
SEND from NetView	129
CANCEL from NetView	130
CICS Requests Using the Program-to-Program Interface	131
CONVERSE from CICS	131
SEND from CICS	132
Programming Interface	133
EVESNCCI—NetView to CICS Communication Interface	135
EVESNRSP - Common Response Handler from CICS	140
EVESCCCI - CICS to NetView Communication Interface	141
EVEMPINT—EVESCCCI Parameter List Copy Book	144

Glossary of CICS and Other Terms 149

Index 153

Figures

1. Example of Start Dependencies	5	16. CICS Automation Main Menu	103
2. Example of Conflicting Requests	6	17. Selection Panel for CICS Resources	105
3. Example of a Request Involving a Group	9	18. Input Panel for the INGREQ Command	107
4. Short-on-Storage State/Action Table Example	12	19. Verification Panel for INGREQ.	109
5. Defining Minor Resources for Transactions	29	20. Input Panel for INGREQ Command	110
6. Automation Flag Panel.	30	21. CICS Automation Monitoring Panel	111
7. Thresholds Definitions Panel.	31	22. Monitoring Links Panel	112
8. Code Processing Panel	31	23. Display Links Panel	113
9. Command Processing Panel	32	24. Health Checking Panel	116
10. Defining a Health Check Program to CICS Automation	34	25. Broadcast Messages Panel	119
11. Message Processing Panel of the Customization Dialogs 1	42	26. Status Display Facility Main Panel	122
12. CMD Processing Panel of the Customization Dialogs	43	27. The CICS Monitor Panel	123
13. User-Defined Data Panel of the Customization Dialogs	44	28. The CICS Link Monitor Panel	123
14. Message Processing Panel of the Customization Dialogs 2	45	29. The Detail Status Display Panel	124
15. Code Processing Panel of the Customization Dialogs	46	30. Program-to-Program Interface Components in NetView and CICS.	127
		31. An EVESNCCI CONVERSE Request	129
		32. An EVESNCCI SEND Request	130
		33. An EVESCCCI CONVERSE Request	132
		34. An EVESCCCI SEND Request	133

Tables

1. System Automation for OS/390 Library	xii	8. Resource Names of Alerts	125
2. Related Products Books	xiii	9. Further Resource Names of Alerts	125
3. CICS-Specific Correspondences between ACF Keywords and Policy Objects/Items	24	10. EVESCCCI CONVERSE Request Parameter List	141
4. Minor Resource Names for Problem Areas	28	11. EVESCCCI Fields Returned to Caller from CONVERSE Request	142
5. CICSQRY Return Codes	64	12. EVESCCCI SEND Request Parameter List	143
6. CICSRCMD Return Codes	66		
7. EVEEMIGR Return Codes	78		

Notices

References in this publication to IBM® products, programs, or services do not imply that IBM intends to make these available in all countries in which IBM operates. Any reference to an IBM product, program, or service is not intended to state or imply that only that IBM product, program, or service may be used. Any functionally equivalent product, program, or service that does not infringe any of the intellectual property rights of IBM may be used instead of the IBM product, program, or service. The evaluation and verification of operation in conjunction with other products, except those expressly designated by IBM, are the responsibility of the user.

IBM may have patents or pending patent applications covering subject matter in this document. The furnishing of this document does not give you any license to these patents. You can send license inquiries, in writing, to the

IBM Director of Licensing
IBM Corporation
North Castle Drive
Armonk, NY 10504-1785
USA

Licensees of this program who wish to have information about it for the purpose of enabling: (i) the exchange of information between independently created programs and other programs (including this one) and (ii) the mutual use of the information which has been exchanged, should contact:

IBM Deutschland Entwicklung GmbH
Department 3248
Schoenaicher Strasse 220
D-71032 Boeblingen
Federal Republic of Germany

Such information may be available, subject to appropriate terms and conditions, including in some cases, payment of a fee.

Programming Interface Information

This book documents programming interfaces that allow the customer to write programs to obtain the services of System Automation for OS/390.

Trademarks

The following terms are trademarks of the IBM Corporation in the United States or other countries:

CICS	DB2	NetView
CICS/ESA	IBM	OS/390
CICS/MVS	IMS/ESA	RACF
CICSplex	MVS	VTAM

NetView is a trademark of Tivoli Systems Inc. in the United States, or other countries, or both.

About This Book

This book describes how to customize and operate CICS Automation. CICS Automation provides a simple and consistent way to monitor and control all of the CICS regions, both local and remote, within your organization. This automates, simplifies, and standardizes console operations and the management of component, application, and production related tasks.

Who Should Use This Book

This book is intended for the following users:

- System programmers, system designers, and application designers who will automate CICS using CICS Automation.

For these users, all three parts of the book are of interest.

Installing and customizing CICS Automation requires a programmer's understanding of NetView[®], CICS, SA OS/390, and CICS Automation, because most of the definitions are done in these programs. Also, you will modify JCL, command lists, and programs for some of the automation functions.

- Operators and administrators who manage and monitor CICS subsystems.

These users mainly need part 1 and part 3.

For operators, a working knowledge of CICS will be assumed.

What's in This Book

This book contains the following:

Part 1, "Introducing CICS Automation"

Explains the concepts of SA OS/390 and describes the functions of CICS Automation.

Part 2, "Customizing CICS Automation"

Describes the customization of CICS Automation and contains reference sections for MESSAGES policy items and for the programming interface.

Part 3, "Using CICS Automation"

Describes the operator interface of CICS Automation.

Notation for Format Descriptions

The reference sections of this manual contain format descriptions of commands and of entries in the SA OS/390 policy database. The notation used for these descriptions is as follows:

- Items shown in braces { } represent alternatives. You must choose one. For example,

{A|B|C}

indicates that you must specify one item only: A, B, or C.

- Items shown in brackets [] are optional. You may choose one. For example,

[A|B|C]

indicates that you may enter A, B, or C, or you may omit the operand.

- Three periods (...) indicate that a variable number of items may be included in the list.
- An underscored item shows the default that the system will choose if you do not specify an item. For example,

[A|B|C]

indicates that if no operand is specified, B is assumed.

- Lowercase italicized items are variables; substitute your own value for them.
- Uppercase items must be entered exactly as shown.
- Parentheses must be entered as shown.
- Where operands can be abbreviated, the abbreviations are shown in capital letters. For example, ALL can be entered as A or ALL.
- Commas are used as delimiters between parameters. The last parameter does not require a comma after it. Because of this, we place the comma in front of a parameter to show that if you add this parameter, you need a comma as, for example, in

XYZ [A[,B[,C]]]

However, the comma must be placed after the preceding parameter and on the same line as that parameter.

Related Publications

The System Automation for OS/390 Library

The following table shows the information units in the System Automation for OS/390 library:

Table 1. System Automation for OS/390 Library

Title	Order Number
<i>System Automation for OS/390 Planning and Installation</i>	SC33-7038
<i>System Automation for OS/390 Customizing and Programming</i>	SC33-7035
<i>System Automation for OS/390 Defining Automation Policy</i>	SC33-7039
<i>System Automation for OS/390 User's Guide</i>	SC33-7040
<i>System Automation for OS/390 Messages and Codes</i>	SC33-7041
<i>System Automation for OS/390 Operator's Commands</i>	SC33-7042
<i>System Automation for OS/390 Programmer's Reference</i>	SC33-7043
<i>System Automation for OS/390 CICS Automation Programmer's Reference and Operator's Guide</i>	SC33-7044
<i>System Automation for OS/390 IMS Automation Programmer's Reference and Operator's Guide</i>	SC33-7045
<i>System Automation for OS/390 OPC Automation Programmer's Reference and Operator's Guide</i>	SC23-7046
<i>System Automation for OS/390 Licensed Program Specifications</i>	SC33-7037

The System Automation for OS/390 books (except Licensed Program Specifications) are also available on CD-ROM as part of the following collection kit:

IBM Online Library z/OS Software Products Collection (SK3T-4270)

SA OS/390 Homepage

For the latest news on SA OS/390, visit the SA OS/390 homepage at <http://www.ibm.com/servers/eserver/zseries/software/sa>

Related Product Information

The following table shows the books in the related product libraries that you may find useful for support of the SA OS/390 base program.

Table 2. Related Products Books

Title	Order Number
<i>ISPF User's Guide</i>	SC34-4484
<i>ISPF Dialog Management Guide and Reference</i>	SC34-4266
<i>MVS/ESA MVS Configuration Program Guide and Reference</i>	GC28-1817
<i>MVS/ESA Planning: Dynamic I/O Configuration</i>	GC28-1674
<i>MVS/ESA Support for the Enterprise Systems Connection</i>	GC28-1140
<i>MVS/ESA Planning: APPC Management</i>	GC28-1110
<i>MVS/ESA Application Development Macro Reference</i>	GC28-1822
<i>OS/390: MVS System Commands</i>	GC28-1781
<i>MVS/ESA SPL Application Development Macro Reference</i>	GC28-1857
<i>OS/390 Hardware Configuration Definition: User's Guide</i>	SC28-1848
<i>OS/390 Information Roadmap</i>	GC28-1727
<i>OS/390 Information Transformation</i>	GC28-1985
<i>OS/390 Introduction and Release Guide</i>	GC28-1725
<i>OS/390 JES Commands Summary</i>	GX22-0041
<i>OS/390 Licensed Program Specifications</i>	GC28-1728
<i>OS/390 Printing Softcopy Books</i>	S544-5354
<i>OS/390 Starting Up a Sysplex</i>	GC28-1779
<i>OS/390 Up and Running!</i>	GC28-1726
<i>Planning for the 9032 Model 3 and 9033 Enterprise Systems Connection Director</i>	SA26-6100
<i>Resource Access Control Facility (RACF) Command Language Reference</i>	SC28-0733
<i>S/390 MVS Sysplex Overview – An Introduction to Data Sharing and Parallelism</i>	GC23-1208
<i>S/390 MVS Sysplex Systems Management</i>	GC23-1209
<i>S/390 Sysplex Hardware and Software Migration</i>	GC23-1210
<i>S/390 MVS Sysplex Application Migration</i>	GC23-1211
<i>S/390 Managing Your Processors</i>	GC38-0452
<i>Tivoli/Enterprise Console User's Guide Volume I</i>	GC31-8334
<i>Tivoli/Enterprise Console User's Guide Volume II</i>	GC31-8335
<i>Tivoli/Enterprise Console Event Integration Facility Guide</i>	GC31-8337
<i>Tivoli NetView for OS/390 Administration Reference</i>	SC31-8222
<i>Tivoli NetView for OS/390 Application Programming Guide</i>	SC31-8223

Table 2. Related Products Books (continued)

Title	Order Number
<i>Tivoli NetView for OS/390 APPN Topology and Accounting Agent</i>	SC31-8224
<i>Tivoli NetView for OS/390 Automation Guide</i>	SC31-8225
<i>Tivoli NetView for OS/390 AON Customization Guide</i>	SC31-8662
<i>Tivoli NetView for OS/390 AON User's Guide</i>	GC31-8661
<i>Tivoli NetView for OS/390 Bridge Implementation</i>	SC31-8238
<i>Tivoli NetView for OS/390 Command Reference Vol. 1</i>	SC31-8227
<i>Tivoli NetView for OS/390 Command Reference Vol. 2</i>	SC31-8735
<i>Tivoli NetView for OS/390 Customization Guide</i>	SC31-8228
<i>Tivoli NetView for OS/390 Customization: Using Assembler</i>	SC31-8229
<i>Tivoli NetView for OS/390 Customization: Using Pipes</i>	SC31-8248
<i>Tivoli NetView for OS/390 Customization: Using PL/I and C</i>	SC31-8230
<i>Tivoli NetView for OS/390 Customization: Using REXX and CLIST Language</i>	SC31-8231
<i>Tivoli NetView for OS/390 Data Mode Reference</i>	SC31-8232
<i>Tivoli NetView for OS/390 Installation: Getting Started</i>	SC31-8767
<i>Tivoli NetView for OS/390 Installation: Migration Guide</i>	SC31-8768
<i>Tivoli NetView for OS/390 Installation: Configuring Graphical Components</i>	SC31-8770
<i>Tivoli NetView for OS/390 Installation: Configuring Additional Components</i>	SC31-8769
<i>Tivoli NetView for OS/390 Messages and Codes</i>	SC31-8237
<i>Tivoli NetView for OS/390 MultiSystem Manager User's Guide</i>	SC31-8607
<i>Tivoli NetView for OS/390 NetView Management Console User's Guide</i>	GC31-8665
<i>Tivoli NetView for OS/390 User's Guide</i>	SC31-8241
<i>Tivoli NetView for OS/390 RODM and GMFHS Programming Guide</i>	SC31-8233
<i>Tivoli NetView for OS/390 Security Reference</i>	SC31-8606
<i>Tivoli NetView for OS/390 SNA Topology Manager and APPN Accounting Manager Implementation Guide</i>	SC31-8239
<i>Tivoli Management Platform Reference Guide</i>	GC31-8324
<i>TSO/E REXX/MVS User's Guide</i>	SC28-1882
<i>TSO/E REXX/MVS Reference</i>	SC28-1883
<i>VM/XA SP GCS Command and Macro Reference</i>	SC23-0433
<i>VSE/SP Unattended Node Support</i>	SC33-6412
<i>VTAM Messages and Codes</i>	SC31-6493
<i>VTAM Network Implementation Guide</i>	SC31-6404
<i>VTAM Network Implementation Guide</i>	SC31-6434

Using LookAt to look up message explanations

LookAt is an online facility that allows you to look up explanations for most messages you encounter, as well as for some system abends and codes. Using

LookAt to find information is faster than a conventional search because in most cases LookAt goes directly to the message explanation.

You can access LookAt from the Internet at:

<http://www.ibm.com/eserver/zseries/zos/bkserv/lookat/>

or from anywhere in z/OS where you can access a TSO/E command line (for example, TSO/E prompt, ISPF, z/OS UNIX System Services running OMVS). You can also download code from the *z/OS Collection* (SK3T-4269) and the LookAt Web site that will allow you to access LookAt from a handheld computer (Palm Pilot VIIx suggested).

To use LookAt as a TSO/E command, you must have LookAt installed on your host system. You can obtain the LookAt code for TSO/E from a disk on your *z/OS Collection* (SK3T-4269) or from the **News** section on the LookAt Web site.

Some messages have information in more than one document. For those messages, LookAt displays a list of documents in which the message appears.

Accessing z/OS™ licensed documents on the Internet

z/OS licensed documentation is available on the Internet in PDF format at the IBM Resource Link™ Web site at:

<http://www.ibm.com/servers/resourceLink>

Licensed documents are available only to customers with a z/OS license. Access to these documents requires an IBM Resource Link user ID and password, and a key code. With your z/OS order you received a Memo to Licensees, (GI10-0671), that includes this key code.¹

To obtain your IBM Resource Link user ID and password, log on to:

<http://www.ibm.com/servers/resourceLink>

To register for access to the z/OS licensed documents:

1. Sign in to Resource Link using your Resource Link user ID and password.
2. Select **User Profiles** located on the left-hand navigation bar.

Note: You cannot access the z/OS licensed documents unless you have registered for access to them and received an e-mail confirmation informing you that your request has been processed.

Printed licensed documents are not available from IBM.

You can use the PDF format on either **z/OS Licensed Product Library CD-ROM** or IBM Resource Link to print licensed documents.

1. z/OS.e™ customers received a Memo to Licensees, (GI10-0684) that includes this key code.

Part 1. Introducing CICS Automation

This part describes the concepts of SA OS/390, including some NetView-related information, and gives an overview of the functions provided by CICS Automation.

Chapter 1. Concepts of SA OS/390

This chapter describes the concepts of SA OS/390. For more detailed information refer to the SA OS/390 documentation.

Automation Policies

System automation primarily deals with starting and stopping applications in accordance with their inter-relationships. These include dependencies of applications on other applications, or being a component application of an application complex. System automation also supports the permanent availability of an application by moving it to another system if there is an unrecoverable abend (see “Application Groups” on page 8).

All applications and systems that you may want to include in automation must be defined to SA OS/390 in an automation *policy database*. This database contains the objects to be managed by SA OS/390, and the rules according to which automation of these objects proceeds. You access the policy database from *customization dialogs*, which are described in *System Automation for OS/390 Defining Automation Policy*.

The objects that are defined in the policy database are called *policy objects* or *entries*. Applications and systems, for example, are policy objects. Every policy object belongs to an *entry type* which is identified by a three letter code. This way applications belong to the entry type APL.

Policy objects have automation-related properties and are associated with one another. These properties and connections are called *policy items*. For example, there is a policy item STARTUP for applications that specifies how SA OS/390 is to start the application.

What you enter in the policy database are policy objects. However, objects that can be automated are not these policy objects, but *resources* which are automatically generated from the policy objects.

This is important for applications because the resources that correspond to an application always represent a *subsystem*. This is a combination of the application with a system on which it is intended to run. This way one application can correspond to several subsystems. These resources are generated when an application is linked to a system in the policy database. Note also that some properties and connections are defined at the application (policy object) level (see “Triggers” on page 7) and passed to all corresponding resources. Others are specified at the resource level (see “Dependencies, Request Propagation, and Desired State” on page 4), and therefore only apply to that resource.

The names of the resources have the following format:

resource_name/entry_type[/system_name]

The most common entry types are APL (application), APG (application group), and SYS (system). The system name is omitted when the resource is associated with a sysplex, and not a single system.

The policy database must be converted into an *automation control file* (ACF) in order to be accessible to SA OS/390.

Goal-Driven Automation

A basic concept of SA OS/390 is to distinguish between the *desired* state and the *actual* state of a resource. Every resource has a desired state, which is either AVAILABLE or UNAVAILABLE; AVAILABLE is the default. This desired state, which is also called the automation *goal*, can be different from the actual state; a resource whose desired state is to be running (AVAILABLE), can be down. SA OS/390 tries to keep the actual state in line with the desired state, but sometimes this is not possible.

SA OS/390 is called *goal driven* because all requests that can be made refer to the desired state of the target resource. When an operator passes a start request for a resource to SA OS/390, this is a request to set the desired state of the resource to AVAILABLE. It is up to SA OS/390 to decide whether (1) this is at all possible, and if so, whether (2) the actual state can be modified accordingly:

1. Making a request does not automatically lead to a change of the desired state of the target resource. Rather, SA OS/390 compares the *priority* of the new request with that of the last successful request. Only when the new request has a higher priority does SA OS/390 change the desired state of the resource. Note that this presupposes that the old request is still available. For more details on this topic, see “Persistence of Requests and Conflicting Requests” on page 6.
2. The latter decision depends on the *dependencies* between the target resource and other resources, and on the *triggers* that may have been associated with it. Dependencies and triggers are defined in the policy database. For more information, see “Dependencies, Request Propagation, and Desired State”, and “Triggers” on page 7.

Dependencies, Request Propagation, and Desired State

One of the main tasks of system automation when starting or stopping a resource is to consider the dependencies between the resource to be started/stopped and other resources. Certain resources can only be started when certain other resources are already running (start dependencies), and certain resources can only be stopped when certain other resources are already down (stop dependencies). Note that start and stop dependencies are independent of each other, although if A can only be started when B is running, then it will, as a rule, not be possible to stop B unless A has been stopped before.

Such dependencies can be specified in the policy database. The only restriction is that the dependent and the supporting resource must belong to the same sysplex (they need *not* reside on the same system). SA OS/390 takes dependencies into account when it is requested to start or to stop a resource. By default, it will try to start/stop all resources on which the target resource of the request directly or indirectly depends. The mechanism by which this is accomplished is called *request propagation*. It is best explained with an example.

Example 1: Let A, B, and C be resources so that A can only be started when B is running, and B can only be started when C is running. C is supposed to have no start dependencies. Suppose, furthermore, that A, B, and C are all actually down, and that this conforms to their desired state (which is UNAVAILABLE).

Finally, assume that A, B, and C are not associated with any trigger (for the significance of this, see “Triggers” on page 7), and that there are no requests pending for any of the three resources (see “Persistence of Requests and Conflicting Requests” on page 6).

This situation is displayed in Figure 1. The labels of the arrows specify the dependency type. **MakeAvailable/WhenAvailable** is the format in which SA OS/390 specifies that the dependent (lower) resource, which is referred to by **MakeAvailable**, can only be started when the supporting (upper) resource, referred to by **WhenAvailable**, is running.

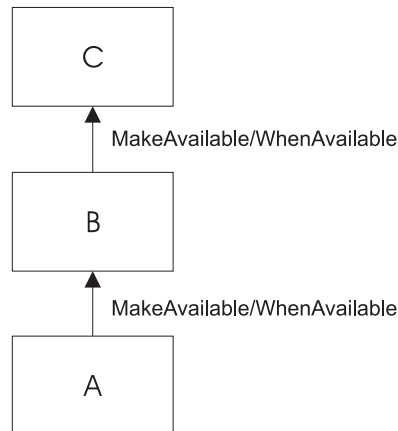

Figure 1. Example of Start Dependencies

When SA OS/390 receives a request to start A, the processing is as follows:

1. The request is propagated:
 - a. Because A can only be started when B is running, a start request is put to B.
 - b. Because B can only be started when C is running, a start request is put to C.
2. As a result of these requests, the desired state of all three resources is changed to AVAILABLE.
3. SA OS/390 tries to change the actual state of the resources according to their desired state:
 - a. At first, only C, which has no start dependencies, can be started. B and A cannot be started because C and B are not yet running.
 - b. Then B will be started, because C is now available.
 - c. Finally, A is started.

The propagated requests are usually called *votes* instead of requests.

In example 1, the request propagation is uniform; the desired state of all three resources is set to AVAILABLE because the condition of the dependency relationships is **WhenAvailable** in both cases. This is not always the case, as the following example shows.

Example 2: Modify example 1 to the effect that B can only be started when C is *unavailable*, and that C is running, in accordance with its desired state AVAILABLE, when the request comes in.

To reflect this modification, the upper arrow label of Figure 1 would have to be changed to **MakeAvailable/WhenDown**. This expresses that

the dependent (lower) resource can only be started when the supporting (upper) resource is unavailable (down).

In example 2, the request must be transformed when propagated from B to C, because in order to start B and then A, C must be down. Therefore, SA OS/390 would put a *stop* request to C in this case, and the desired state of C would be set to UNAVAILABLE.

By propagating requests, SA OS/390 actively supports the start or stop request. You can also switch off request propagation for a resource. If this were to be done for resource A in example 1, then A would not be started because B is not available, and SA OS/390 would do nothing to start B. In this case A would only be started after B had been started, directly or indirectly, through another request.

Persistency of Requests and Conflicting Requests

Requests (and the votes derived from them) are persistent. They are stored in SA OS/390 and continue to be taken into account until you explicitly remove them. This implies that there can be more than one request (vote) for the same resource at the same time, and these requests (votes) can be contradictory, as shown in the following example.

Example 3: Expand example 1 by a resource D, also depending on C, which can only be started if C is down. A, B, and C are as in Figure 1 on page 5; D is supposed to be down, and its desired state to be UNAVAILABLE.

Figure 2 contains a graphical presentation of example 3.

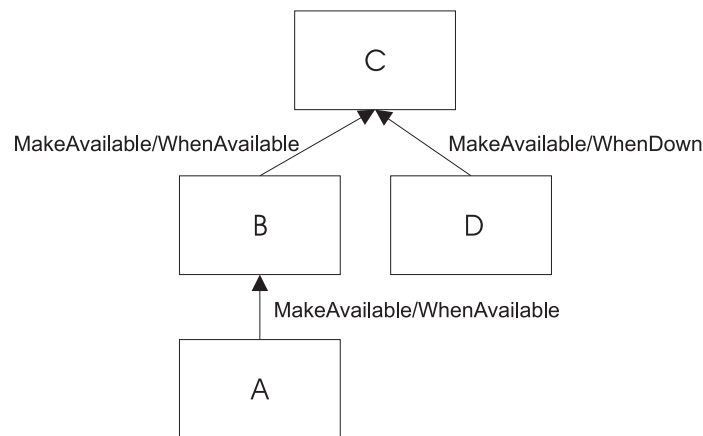

Figure 2. Example of Conflicting Requests

Now assume that first a request to start A and then a request to start D are passed to SA OS/390. The first request results in setting the desired state of C to AVAILABLE. Thereafter the propagation of the start request for D results in a vote to stop C. Since votes are persistent, the previous vote to start C is still existent, and we have two contradictory votes for C. In such a situation, SA OS/390 uses the *priority* of the original requests to decide which one of the two votes wins.

When the priority of the old start vote for A is higher than that of the new vote to start D, then the desired state of D will be changed to AVAILABLE, but that of C will remain AVAILABLE; accordingly, SA OS/390 will not try to stop C, and thus D cannot be started. If, on the other hand, the vote to stop C has the higher

priority, then the desired state of C is changed to UNAVAILABLE, and SA OS/390 will try to stop C in accordance with its desired state, and then to start D. When two contradictory votes have the same priority, a start vote wins over a stop vote.

The persistency concept implies that the losing vote is not automatically discarded. If, for instance, the start request for A wins, the start request for D and the propagated stop vote for C continue to be stored in SA OS/390, and can still be fulfilled after the request for A, and therefore also the start vote for C which was derived from it, have been removed by an operator. After the removal, SA OS/390 will determine the desired state of C again and will set it to UNAVAILABLE in response to the stop vote propagated from the start request for D, if no other vote is pending for C. After that, C will be stopped, and then D will be started.

Note that persistency of requests does not apply to successive requests of the same operator. In this case the second request will replace the earlier one.

Triggers

Triggers specify necessary conditions for starting or stopping an application; 'necessary' means that the application can only be started or stopped when that condition is satisfied. Triggers are defined independently of applications, so the same trigger can be associated with more than one application. Triggers are defined and linked to an application in the policy database.

The conditions contained in a trigger are either startup conditions or shutdown conditions; there can be more than one startup condition, and also more than one shutdown condition. When a trigger is associated with an application, the resources generated from this application can only be started if *at least one* of the startup conditions in this trigger is satisfied; analogously, they can only be stopped if at least one of the shutdown conditions is fulfilled.

A trigger condition consists of a set of *events*. An SA OS/390 event represents an external event that is not under the control of SA OS/390, but is relevant to the state of the application associated with the trigger. The information that the external event has or has not occurred is passed to SA OS/390 by *setting* or *unsetting* the SA OS/390 event; this must be done by an operator or by an automation procedure. A trigger condition is only satisfied when *all* of its events are set.

The following example illustrates the use of triggers and their interrelations with dependencies and request propagation.

Example 4: Expand example 1 to the effect that resource C is associated with a trigger that contains only one startup condition. This condition consists of two events, EVENT1 and EVENT2. EVENT1 is set, EVENT2 is unset.

When the request to start A arrives at SA OS/390, it will set off the same sequence of events as with example 1 up to step 2 on page 5. Since, however, the only startup condition of the trigger is not satisfied, C will not be started, and therefore B and A will not be started either. In order to start A, EVENT2 must be set, for example, by an operator. This will lead to a re-evaluation of the startup condition. Since this condition is now satisfied, SA OS/390 will start C, and subsequently B and A.

Service Periods

So far we have always assumed that the start or stop requests are made by a human operator. However, SA OS/390 also provides the possibility to make start and stop requests at specified points in time independently of human intervention. The objects that are able to do this are called *service periods*. Service periods are defined in the policy database.

A service period is a set of time intervals, called *service windows*, during which an application should be available or unavailable. Service periods are defined independently of applications and can then be associated with one or more applications or application groups (see “Application Groups”). When an application is associated with a service period, the service period makes a start request for the application whenever the start time of a service window arrives; this request is canceled when the stop time of the service window arrives. You can also specify service windows during which the application should be unavailable; in this case, a stop request is made at the start, and canceled at the stop time of the service window. The following example is again an expansion of example 1.

Example 5: Resource A of example 1 is associated with a service period that contains at least one service window during which A should be available.

If the start time of this service window arrives, the same sequence of events will occur as with example 1.

An operator can temporarily modify a service period (this is called a *schedule override*). If there is a conflict between a request made by an operator and a request from a service period, the operator request wins if its priority is not lower than that of the service period request.

Application Groups

Modern applications often consist of more than one component, and these different components can be distributed among different systems. SA OS/390 provides the possibility to combine different components of an application on one or more systems within a sysplex into an *application group*. This allows you to start and stop a complex application with a single command, and to integrate it into automation processes as a whole.

Example 6: Suppose that resource B of example 1 is an application *group* with the members B1 and B2, and declare A dependent on group B (not on the individual group members), and B dependent on C. You can define B so that every request made to the group as a whole is automatically propagated to every group member.

Figure 3 on page 9 contains a graphical presentation of example 6.

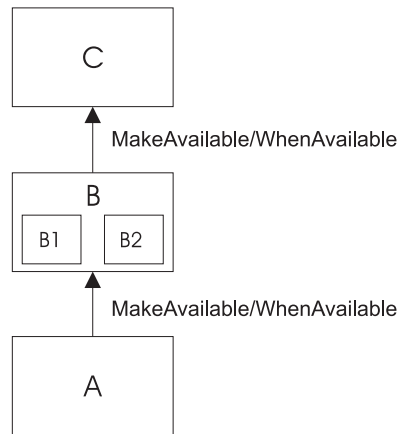

Figure 3. Example of a Request Involving a Group

Then, if you request A to be started, SA OS/390 will first, as before, propagate the request to group B and to application C. After C has been started and therefore group B can be started (step 3b on page 5 of example 1), a start vote will be propagated to every member of B. After the desired state of B1 and B2 has been set to AVAILABLE and both resources have been started, B will be considered available, and only then will SA OS/390 start A.

In this type of group (which is called BASIC) the group members form a complex entity, and therefore the group is only considered available when *all* its members are available.

The group concept is also used to move applications from their primary system to a backup system when the primary system has failed (group type MOVE). In this case the members of the group are instances of the same application on different systems. In accordance with their purpose, MOVE groups are declared available when *exactly one* of their members is available. You assign preferences to the elements in order to determine which group member is to be started when a start request is put to the group, and which group member takes over when the currently available member is not restartable any more.

SERVER groups are a third type of group. They are a variant of move groups and differ from these mainly in that you can specify how many of its members must be available before the group is considered available. As with move groups, you assign preferences to the members to determine which of them are to be started when a start request is put to the group, and which group members takes over when one of the currently available members is no longer restartable.

Groups can be nested. Suppose, for example, that you have a complex application that you want to be able to move from one system to another. Here you can first define two basic groups G1 and G2, each containing the application on a different system, and then define a move group that contains G1 and G2 as its members.

SA OS/390 and the NetView Message Automation Table

The implementation of SA OS/390 is based on NetView. One important area, where SA OS/390 relies on NetView functionality, is the NetView Message Automation Table (MAT). This table serves to automate operator responses to messages that are sent to NetView. It contains instructions of the general form:

When message ABC arrives then issue command XYZ.

Whenever NetView receives a message, it scans the MAT. If it finds an entry for the message, it issues the command specified in that entry.

With applications controlled by SA OS/390, the command will typically be one of the generic routines that are shipped with SA OS/390 (see *System Automation for OS/390 Programmer's Reference*). Many of these routines retrieve information from the ACF and then act according to that information.

A typical example for such information is the MESSAGES/USER DATA policy item of the APPLICATION policy object. Within the MESSAGES/USER DATA policy item, you can associate a command with a message ID (see *System Automation for OS/390 Defining Automation Policy*). If you connect this message ID with the generic routine ISSUECMD in the MAT, then NetView will execute ISSUECMD when the application sends the message in question to NetView. ISSUECMD, in its turn, will search for the message ID in the ACF entry for this application, and if the message ID is associated there with a command, it will issue this command. For more information on ISSUECMD, see *System Automation for OS/390 Programmer's Reference*.

For example, you could associate the message ID AHL031I, which is the ID of the startup message sent by the application GTF, with the command MVS \$DMRO'GTF IS NOW UP' in the MESSAGES/USER DATA policy item for GTF. Then the MAT would have to contain an entry like the following:

```
IF MSGID = 'AHL031I'  
THEN EXEC(CMD('ISSUECMD AUTOTYP=START') ROUTE(ONE *));
```

When NetView receives the AHL031I message it extracts the job name from the message and calls ISSUECMD. ISSUECMD knows where to find the job name and searches the ACF for the associated application. When it finds GTF, it will look for the AHL031I entry in the MESSAGES/USER DATA policy item and will issue the command that is associated with AHL031I for GTF,

```
MVS $DMRO'GTF IS NOW UP'.
```

For more information on the MAT, see *Tivoli NetView for OS/390 Automation Guide*. IMS Automation also has some special generic routines, see Chapter 6, "CICS Automation Routines, Commands, and Definition Members" on page 61.

Chapter 2. Functions of CICS Automation

CICS Automation is integrated into SA OS/390. This way, CICS regions must be generated in the policy database as subsystems, by linking CICS applications to systems, in order to be available to CICS Automation. Triggers and service periods for CICS regions are also defined as for any other application.

Link Monitoring

CICS communicates with other systems or subsystems using either intersystem communication (ISC) or interregion communication (IRC). Link monitoring verifies that the IRCs and ISCs are active. This is done by issuing CEMT INQUIRE at certain intervals to check the status of these connections. When a link failure is detected, link monitoring will perform automatic recovery actions.

Basic link monitoring only ensures that the link is active on the origin subsystem. With the echo facility, you can also control the remote subsystem at the other end of the link. This facility is supported for links to CICS and IMS.

Health Checking

Through health checking, you execute programs that check the state of certain components of an application running under CICS. CICS Automation initiates a health check program by sending a request across the program-to-program interface to CICS. CICS invokes the program, and sends back an Acknowledgement (ACK), indicating that the program executed as expected; or it sends a Negative Acknowledgement (NACK), indicating that the program did not execute as expected. A NACK includes data describing the error. Up to ten health check programs can be associated with any CICS application that is defined to SA OS/390.

Health check routines are usually executed automatically at timed intervals. When CICS Automation receives an abnormal response from CICS (NACK) or when a timeout occurs, CICS Automation sends out notification messages.

State/Action Tables

The MAT (see “SA OS/390 and the NetView Message Automation Table” on page 9) contains instructions on what to do when certain messages are sent to NetView. Here the action to be taken only depends on one event (the message).

There are, however, cases where not only the actual event, but also previous events must be taken into consideration in order to determine the necessary action. Assume, for example, that a CICS subsystem reports that its storage supply is back to normal. If the preceding message had reported a storage shortage and this had triggered certain actions, these actions will have to be revoked; if, however, no error message had occurred before, the actual message should simply be ignored.

To meet this requirement, resources are associated with a *state*. When an event, usually a message, occurs that is relevant for the resource in question, the action to be taken is inferred not only from the event, but also from the actual state of the resource; that is, the same event can lead to different actions, depending on the

state. Also, the state of the resource will usually be changed on account of the event and the previous state. The current state reflects the history of the resource.

State/Action Tables serve to define such a state-dependent event processing. They form a two-dimensional matrix, where the rows correspond to the possible events (messages) and the columns to the possible states. The individual cells specify the action to take and the new state in the case that the respective event occurs when the resource is in the respective state.

For an example, consider the following table:

```

/*****
/* STATES:          NORMAL          SINGLE          DOUBLE          */
/*                HALTED           HALTED           */
/* STATE VALUES:  0                1                2                */
/*****
EVENT=DFH0506     EVEES101/1       NA              NA
EVENT=DFH0507     NOP             EVEES102/0     NA
EVENT=DFHSM0100I  EVEES101/1     /2             NA
EVENT=DFHSM0101I  EVEES101/1     /2             NA
EVENT=DFHSM0106I  NOP            EVEES102/0     /1
EVENT=DFHSM0107I  NOP            EVEES102/0     /1
EVENT=CICSDN      NOP            EVEES103/0     EVEES103/0
EVENT=CICSINIT    NOP            EVEES103/0     EVEES103/0

```

Figure 4. Short-on-Storage State/Action Table Example

The table must be read as follows:

- If an action must be taken and/or the status be changed, the cells contain the name of the action command list to be called and/or the code of the new state, separated by a slash.
- NOP signifies that nothing is to be done.
- NA signifies that this event/state combination cannot occur.

The sample table serves to manage the storage supply resource for CICS applications. There are three possible states for storage supply, 0=NORMAL, 1=SINGLE HALTED, and 3=DOUBLE HALTED. The following scenario illustrates how the table works:

1. Assume that the actual state of storage supply is 0.
2. Message DFH0506 is issued. This message contains the information that CICS is short on storage.
3. Row 1, column 1 of the table is consulted.
4. The state of storage supply changes to 1.
5. The action command list EVEES101 is called. EVEES101 schedules a timer, on the expiration of which the operator is alerted, the SDF is updated, and an MVS dump taken.
6. Message DFH0507 is issued. This message contains the information that storage supply is back to normal.
7. Row 2, column 2 of the table is consulted.
8. The state of storage supply changes to 0.
9. The action command list EVEES102 is called. EVEES102 cancels the timer and removes any SDF messages that are associated with this error occurrence.

Recovery

You can automate recovery for transactions and for certain problems. Transaction recovery can be automated globally and for individual transactions. This is achieved by combining some of the basic functions of the product with CICS-specific policy items and several CICS-specific message IDs.

Program-to-Program Interface

NetView's program-to-program interface provides the ability to communicate between a NetView application and other address spaces on the same host, such as CICS and IMS. CICS Automation uses this program-to-program interface to:

- Initiate, from NetView, the execution of a CICS program.
- Process a response from this CICS program.
- From CICS initiate, the execution of a command list or command processor in NetView.
- Process a response from this command list or command processor.

There are CICS Automation program-to-program interface components in CICS as well as in NetView. Chapter 3, "Customizing CICS Automation" on page 17 provides you with step-by-step procedures that tell you how to install these components so that the interface can be implemented.

If you want to use the CICS Automation program-to-program interface code for your own purposes, refer to "CICS Automation and the Program-to-Program Interface" on page 127 for further information.

NetView Components

There is an optional task (EVENTASK), an initialization member for this optional task, and command processors. The initialization member is described in "EVENTASK—NetView PPI Initialization Member" on page 94. The command processors are described in "EVESNCCI—NetView to CICS Communication Interface" on page 135, and "EVESNRSP - Common Response Handler from CICS" on page 140.

CICS Components

There is a long-running transaction COPC, as well as start and stop transactions to start and stop the CICS program-to-program interface component; there is also a subroutine which is described in "EVESCCCI - CICS to NetView Communication Interface" on page 141, and an initialization member which is described in "EVESPINM—CICS PPI Initialization Member" on page 92.

Communication Components

An ID (RECEIVERID) is defined at both ends of the program-to-program interface, so CICS Automation knows which NetView to sign on to. This RECEIVERID is contained in the initialization members described above. The VTAM[®] applid is used by CICS to sign on to the program-to-program interface. NetView determines which applid relates to which subsystem from the **APPLid** field of the CICS CONTROL policy item.

The CICS Automation program-to-program interface cannot function if the RECEIVERIDs in the initialization members do not match, or if the VTAM applid

of the **APPLid** field of the CICS CONTROL policy item does not match the VTAM applid. The customization sections describe how to define the RECEIVERID and the VTAM applid.

Part 2. Customizing CICS Automation

This part describes how to customize and set up CICS Automation. It also contains reference information for CICS-specific MESSAGES keywords and for common routines which request information or perform tasks associated with CICS Automation.

Chapter 3. Customizing CICS Automation

This chapter explains how to customize NetView, CICS and SA OS/390 for CICS Automation. The customization consists of the following steps:

1. Define CICS Automation to CICS.
2. CICS Automation definitions in NetView. In this step you define the policy objects in the SA OS/390 policy database that are necessary for CICS Automation.

CICS Automation Definitions in NetView

This section describes the definitions to be made in NetView. For the necessary definitions in the policy database, a number of sample APPLICATION classes and instances for CICS have been supplied with the sample policy databases for SA OS/390. Use these samples as a guideline to assist you with defining your CICS Automation policies. The names of the classes have the format:

CLASS_CICS_xxxx

The name format of the instances is:

CICSxxxx
CMASxxxx

where xxxx is the version suffix, for example, TS11.

Step 1: Basic CICS Automation Common Policy Definitions

For each NetView domain, set up the CICS Automation environment according to the following list:

1. Verify that the system environment is defined as described in the SA OS/390 documentation.
2. Ensure that the Automation Operators that are used for CICS are defined in the AOP entry type. The following entries are necessary:

Automated Function	Operator ID	Message Classes
CICSMSTR	AUTCICS	EVE*
CICSCPPI	AUTCPPI	

3. Define sets of State/Action Tables in the CSA entry type.
4. Define link monitoring connections by first creating links (in the CCN entry type) and link monitoring service periods (in the CVP entry type), and then associating service periods to connections in the MONITORING PERIOD policy item of the CCN entry type.

Step 2: Basic CICS Application Definitions

For each CICS application, set up the CICS Automation specifications in the customization dialogs according to the following list:

1. Specify the basic information for the CICS applications (APL entry type). The **Application Type** field of the **Define New Entry** panel must be set to CICS for CICS applications.

Important!

Note that the subsystem name as specified in the **Subsystem Name** field of the **Define New Entry** panel must not exceed *eight* characters for applications of type CICS. This contrasts with standard applications where 11 characters are allowed.

2. Check the CICS CONTROL policy item and enter any required values. You must specify values for the **APPLid** and **Major node** fields.
3. Specify the automation flags in the AUTOMATION FLAGS policy item.
4. Specify the thresholds of the application in the THRESHOLDS policy item.
5. Specify the startup commands in the STARTUP policy item. Note that the possible startup types depend on the CICS version as follows:

Start Type	Explanation	Valid for
AUTO	Uses the restart data set to determine the startup type.	All releases
COLD	Initiates a cold start.	All releases
INITIAL	Initiates a cold start with additional processing for CICS TS resources.	CICS TS V1R1 and above
LOGTERM	Initiates a startup, and then a shutdown as soon as the startup is complete.	Pre CICS TS V1R1
NORM	This is the same as AUTO.	
STANDBY	Initiates a start for an XRF backup.	All releases

6. Specify the shutdown commands in the SHUTDOWN policy item.
7. Link the application to the required CICS STATE ACTION policy object (CSA) in the STATE ACTION policy item.
8. If you want to use service periods or triggers, link these to the application in the SERVICE PERIOD or TRIGGER policy item.
9. If you want to use link monitoring, link the application to a CICS connection (CCN entry type) in the CICS CONNECTION policy item.
10. Specify the ACORESTART keyword in the MESSAGES/USER DATA item of the APPLICATION policy object. The command associated with this keyword must be CICSRSYC, see “CICSRSYC—CICS Resync” on page 73.
11. If you want to use the health check function, specify the HEALTHCHK keyword in the MESSAGES/USER DATA item. For details, see “HEALTHCHK—Health Checking” on page 52.
12. Review the supplied CICS sample classes and instances for the the message keywords described in “CICS-Specific MESSAGES/USER DATA Keywords” on page 46. Customize these entries as required.
13. If you need thresholds for the RCVRAUTO, RCVRSOS, RCVRTRAN (RCVRTRAN.*tranid*), or RCVRVIOL message keywords (see “CICS-Specific MESSAGES/USER DATA Keywords” on page 46 for these keywords), define resource thresholds for them with the names of AUTO, SOS, TRAN (TRAN.*tranid*), or VIOL, in the CICS-specific RESOURCE THRESHOLDS policy item. For more details on recovery, see “Automating Recovery For Transactions” on page 28.

Step 3: The Program-to-Program Interface Initialization Member (EVENTASK)

You only need to change this member if:

1. The BUFFQL is set to 20. If you get error messages indicating that 20 is not enough, increase this number. Refer to the *buffer queue limit* description in *NetView Application Programming: Program-to-Program Interface* for specific error messages and buffer queue guidelines.

The following is the default:

```
BUFFQL=20
```

2. If you are running CICS Automation in more than one domain on the same MVS system, provide unique RECEIVERIDs in this member. Also change this in the corresponding CICS program-to-program interface initialization member EVESPINM. The following is the default:

```
RECEIVERID=NETCVPP1
```

3. If you are not using the default program-to-program interface automation operator ID, change that ID in the SERVER entries. The default is AUTCPPI, as shown in the following:

```
SERVER=REQUEST, LMT, AUTCPPI, EVEEYPPS  
SERVER=RESPONSE, CEMT, AUTCPPI, EVESNRSP  
SERVER=RESPONSE, LMT, AUTCPPI, EVESNRSP  
SERVER=REQUEST, NACK, AUTCPPI, EVESNACK  
SERVER=RESPONSE, NACK, AUTCPPI, EVESNACK
```

Step 4: Adding a New CICS Automation Status File Record

If you define a new CICS region to CICS Automation and attempt to start using the operator interface, the startup fails because there is no status record for CICS Automation to read. To solve this problem, you must build a status file record for each new CICS region, or you must trap a message for that region prior to attempting the manual startup. Any message trapped by CICS Automation for a CICS subsystem (such as IEF403I or DFH1500), will result in a status file record being built for that subsystem if one does not already exist. CICS Automation will dynamically build a status file record for each CICS subsystem upon trapping the first message for it.

To create a new status file record, enter:

```
EVEEMIGR NAME=cics_subsystem_name NEWVERSION=cics_version
```

For more information on EVEEMIGR, see “EVEEMIGR—Migrate Subsystem to CICS/TS” on page 78.

Step 5: Installing CICSplex SM REXX API

To manage CICSplex[®] SM CMAS address spaces the CPSM REXX API is required. This can be installed in NetView by adding the CICSplex SM library SEYUAUTH before the library that contains module IRXFLOC. If there are no existing IRXFLOC modules the library can be placed at the end of the //STEPLIB concatenation.

Alternatively, module IRXFLOC can be customized according to the instructions in the section “Installing the REXX function package” in manual *CICSplex SM Setup*.

Extended CICS Definitions

This chapter describes the CICS Automation definitions. These steps must be performed on each CICS region.

Step 1: Health Check Programs

Note: This step assumes that the health check routines are already written and that you know the transaction name, program name, and language of each. If you need more information, read “How to Set Up Health Checking” on page 33 before performing this step.

If you want to use the health check feature, define the program name and language for each health check routine (there can be up to ten for each CICS subsystem) as follows:

```
DEFINE PROGRAM(program) LANGUAGE(language)
```

Note: The program name must correspond to a program name defined in the **Data** field in the HEALTHCHK keyword in the MESSAGES/USER DATA policy item message ID for the respective subsystem. For more information on HEALTHCHK, see “HEALTHCHK—Health Checking” on page 52.

Step 2: Program-to-Program Interface Initialization Member (CICS)

Note: This step is only required if the initialization member requires modification. Modification is needed when:

- The RECEIVERID is changed. This value must be the same as the value defined in “Step 3: The Program-to-Program Interface Initialization Member (EVENTASK)” on page 19.
- You are using the program-to-program interface for your own transactions.

The purpose of this initialization member is to relate program-to-program interface function names to CICS transaction names. The member looks something like this:

```
EVEMPINM TYPE=INITIAL,      INITIAL ENTRY
  BUFFQL=4,                 BUFFER QUEUE LIMIT
  RECEIVERID=NETVCPPI,      NPDS RECEIVER IDENTIFICATION
  USERID=YES                USE CICS 4.1 SECURITY

EVEMPINM TYPE=ENTRY,        DEFINE A FUNCTION
  FUNCTION=LMT,             FUNCTION NAME
  TRANSID=COLR              TRANSACTION NAME

EVEMPINM TYPE=ENTRY,        DEFINE A FUNCTION
  FUNCTION=CEMT,            FUNCTION NAME
  TRANSID=COMT              TRANSACTION NAME

EVEMPINM TYPE=ENTRY,        DEFINE A FUNCTION
  FUNCTION=HEALTH,          FUNCTION NAME
  TRANSID=COHR              TRANSACTION NAME

EVEMPINM TYPE=FINAL        REQUIRED END
```

If this member requires changes, do the following:

1. Edit EVESPINM. USERID=YES means that CICS security checking is required, USERID=NO means that CICS security checking is not required.
2. Assemble the program-to-program interface initialization member with the EVESJ020 sample job.

Note: This JCL is also used for assembling EVESCMT3. Edit the JCL and make sure that the member name to be assembled is EVEMPINM.

3. Place the assembled member into one of the libraries in the CICSDFHRPL chain.

Step 3: Add or Change the CICS Transient Data Messages

If you want to add or change the CICS transient data messages:

1. Edit EVESCMT3 and make the required changes.
2. Assemble the table with the EVESJ020 sample job.

Note: This JCL is used for assembling EVEMPINM as well. Edit the JCL and make sure that the member name to be assembled is EVESCMT3.

3. Place the assembled member into one of the libraries in the CICSDFHRPL chain.

Step 4: Add or Change the USER Transient Data Messages

If you want to add or change the USER transient data messages:

1. Edit EVESCMT4 (only available for CICS/ESA and CICS/TS) and make the required changes.
2. Use the JCL shown in sample job EVESJ020 to assemble and link-edit this table.

Note: This JCL is also used for assembling EVEMPINMI. Edit the JCL to assemble and link-edit EVESCMT4.

3. Place the assembled member into one of the libraries in the CICS DFHRPL concatenation.

Step 5: Echoplex Back-End Programs

Echoplexing can be implemented for target subsystems of subtype IMS or CICS. For IMS target subsystems, no installation is required.

For CICS target subsystems, install the back-end echoplex program to the remote systems as follows:

```
DEFINE TRANSACTION(ECHO) PROGRAM(EVESYCB7)
DEFINE PROGRAM(EVESYCB7) LANGUAGE(ASSEMBLER)
```

Note: The transaction name ECHO may be changed for your installation. Whatever name is used, it must be specified in the **Echo** field of the CICS LINK policy object (CCN entry type) that is associated with the corresponding subsystem in the policy database. See *System Automation for OS/390 Defining Automation Policy*.

Step 6: Security Considerations

If you want to use non-terminal transaction security, refer to the *CICS Release Guide* for CICS-specific information about non-terminal transaction security and the security manager domain.

1. Define all NetView operators which will invoke CICS functions defined to RACF® (or your SAF-compliant security system). This will include:
 - Regular NetView operators
 - NetView autotasks which perform CICS-related actions. These autotasks include autotasks specifically defined for CICS Automation use, and may include the autotasks which process shutdown functions or resynchronization functions.

2. Define SAF surrogate authorization for CICS. Since CICS Automation is started from the PLTPI, surrogate authorization for the PLTPIUSR is recommended for all CICS Automation NetView users. Define surrogate profile types of DFHINSTL for PLTPI processing and DFHSTART for normal-started task processing.
3. Define TCICSTRN profiles for all the transactions which will use non-terminal transaction security. The following transactions are supplied with CICS Automation:
 - COHO
 - COPC
 - COPP
 - COPS
 - COMC
 - COMT
 - COHR
 - CORL
 - COLO
 - COLR
 - COLC
 - COLE
4. Connect the NetView operators to the CICS resources which they need to access, such as transactions, programs, and files. This connection is done through your SAF security manager (such as RACF).
5. Enable non-terminal transaction security in CICS by modifying the CICS SIT to specify XTRAN=YES and XUSER=YES.
6. Modify PLTPIUSR and PLTPISEC as required.

If you do want to use the non-terminal transaction security in CICS, disable this function in CICS Automation by modifying the EVESPINM member and specifying USERID=N0 to disable extended support. Reassemble the member using sample job EVESJ020.

Step 7: Define a NetView PPI receiver task

A PPI receiver is required to allow CICS subsystems to communicate with NetView. This is a required step and must be done for correct automation of a CICS subsystem.

1. If you are using a policy database (PDB) that has been converted from a previous release, then use the migration function to migrate EVECFPPI in SINGSAMP into the PDB. This will create the subsystem classes for the PPI interface.
2. Define an application to represent the PPI receiver in a NetView. This application must be defined as NON-MVS and the job name must be EVENTASK. Specify the monitoring routine to be AOFATMON.
3. Link the application to the CLASS_CICS_NV_PPI class.
4. Do not specify any relationships, so that the application will be started as soon as possible.
5. Specify a Where Used APG that is connected to every system that runs a SA OS/390 NetView agent. This will ensure that resource will be created for every SA OS/390 agent in the sysPlex. It is recommended to use a SYSTEM

APG that is linked to all the systems rather than a SYSPLEX APG. This allows for the APG to be shut down on a system by system basis.

Step 8: Define a CICS PPI receiver task

A PPI receiver is required to allow NetView to communicate with CICS subsystems. This is an optional step. It enables operator control of the PPI receivers in each CICS subsystem.

Note: A CICS PPI subsystem may be defined for any CICS subsystem for which the operator wishes to start or stop the PPI receivers in the CICS address space.

1. If you are using a policy database (PDB) that has been converted from a previous release, then use the migration function to migrate EVECFPPI in SINGSAMP into the PDB. This will create the subsystem classes for the PPI interface.
2. Define an application to represent the PPI receiver in a CICS subsystem. This application must be defined as NON-MVS and the job name must be APPLID of the CICS subsystem. Specify the monitoring routine to be AOFAPMON.
3. Link the application to the CLASS_CICS_PPI class.
4. Specify the following relationships:
 - hasParent(StartsMeAndStopsMe) -> CICS subsystem
 - Relationship Type of hasParent and Condition of StartsMeAndStopsMe.
5. Specify a Where Used APG of which the CICS subsystem is a member.

CICS Automation Definitions for CICSplex System Manager (CPSM)

This section helps you define CICSplex System Manager components to Automation.

Automating Coordinating Address Space (CAS) Startup and Shutdown

The CAS applications are not CICS systems. They should be defined in the policy database with application type STANDARD, not CICS.

To help with the definition of the CAS, CICS Automation supplies NetView message automation table entries to let Automation know when the CAS is UP. These definitions are stored in member EVEMEYU1 in the ING.SINGNPRM.

To assist in the task of building the policy, a sample subsystem definition for a CAS is provided. The name of the sample CAS region is EYUCAS1A.

Automating CICSplex SM Address Space (CMAS) Startup and Shutdown

The CMAS regions are CICS regions, and so they should be defined in the policy database with application type CICS. The CMAS regions execute only CICSplex SM code. (CICSplex SM recommends that only CICSplex code be run in CMAS regions. User transactions should not be run in CMAS regions.)

The Automation required to manage the CMAS regions is less than a normal CICS region because there is no need to have PPI and other CICS-monitoring functions. However, CMAS CICS regions need to be shut down via the CICSplex SM SHUTDOWN command. To allow CICS Automation to shutdown the CMAS, the

CMASSHUT command is provided. Use it instead of the normal CICSSHUT command in the policy definition for CMAS regions.

Note: The use of CEMT PERFORM SHUTDOWN is not recommended for CMAS regions.

CPSM recommends that CMAS regions be started prior to MAS regions they manage. This can be achieved via relationships as supported by System Automation for OS/390.

Migration and Coexistence

This section contains information on migrating from CICS Automation Version 1 Release 4 to CICS Automation Version 2 Release 1, and on compatibility between Version 1 Release 4 and Version 2 Release 1.

Migration

The general migration process is described in *System Automation for OS/390 Defining Automation Policy*.

The following table provides every ACF keyword of Version 1 Release 3 that is CICS specific, or has a CICS-specific application to the corresponding policy item of Version 2 Release 1. Comments are added as required.

Table 3. CICS-Specific Correspondences between ACF Keywords and Policy Objects/Items

ACF keyword	Policy object/item	Comments
ABCODESYSTEM	Keyword for MESSAGES/USER DATA policy item of APPLICATION objects	
ABCODETRAN	Keyword for MESSAGES/USER DATA policy item of APPLICATION objects	
AREA	STATE/ACTIONTABLES object (CSA entry type)	These objects must be linked to applications through the STATE ACTION TABLE policy item of CICS applications.
AUTOOPS	AUTO OPERATORS policy object (AOP entry type)	The CICSOP n auto operators are obsolete.
CICSCNTL	CICS CONTROL policy item for APPLICATION objects of type CICS	
CONNECTION	CICS CONNECTION policy item for APPLICATION objects of type CICS	
CICSGROUP	—	Obsolete. Use standard application groups.
EXTCOND	—	Obsolete. Use standard triggers.
ENVIRON SETUP	—	The entry and the EVEEIIINT exit are obsolete.
ENVIRON TIMEOUT (CEMT keyword)	TIMEOUT SETTINGS object (TMO entry type)	This policy object must be linked to SYSTEM objects.

Table 3. CICS-Specific Correspondences between ACF Keywords and Policy Objects/Items (continued)

ACF keyword	Policy object/item	Comments
HEALTHCHK	Keyword for MESSAGES/USER DATA policy item of APPLICATION objects	
LISTSHUT	Keyword for MESSAGES/USER DATA policy item of APPLICATION objects	
INITSTART	AUTOMATION FLAGS item of APPLICATION object	The EVEEIEXT exit is obsolete.
PRODUCT	STATE/ACTIONTABLES object (CSA entry type)	These objects must be linked to applications through the STATE ACTION TABLE policy item of CICS applications.
RCVRAUTO	Keyword for MESSAGES/USER DATA policy item of APPLICATION objects	
RCVRSOS	Keyword for MESSAGES/USER DATA policy item of APPLICATION objects	
RCVRTRAN	Keyword for MESSAGES/USER DATA policy item of APPLICATION objects	
RCVRVIOL	Keyword for MESSAGES/USER DATA policy item of APPLICATION objects	
RECOVERY	MINOR RESOURCE FLAGS item of the APPLICATION object	For the names of the minor resources, see “Automating Recovery For Transactions” on page 28.
RESTART	AUTOMATION FLAGS item of APPLICATION object	The EVEEIEXT exit is obsolete.
SERVICE	—	Obsolete. Use standard service periods.
THRESHOLDS (CICS specific thresholds in minor resource format)	CICS specific RESOURCE THRESHOLDS policy item for application of type CICS	For the minor resource names, see “Automating Recovery For Transactions” on page 28.
TRIGGER	—	Obsolete. Use standard triggers.

Note that additional customization is necessary for the migrated policy database, because there are policy items that are required in CICS Automation V2R2 but have no counterpart in CICS Automation V1R4.

Do the following:

Define the startup commands for the individual CICS startup types in the STARTUP policy item of the CICS applications. For the valid startup types, see “Startup” on page 107; for specifying startup commands in the STARTUP policy item, see *System Automation for OS/390 Defining Automation Policy*.

The CICS-specific trace function no longer exists. CICS Automation V2R2 uses the trace function of SA OS/390. Note, however, that most components of CICS Automation only support the global debug setting. For details on the trace function of SA OS/390, see the description of AOCTRACE in the *System Automation for OS/390 Operator’s Commands*.

The **Set Cold Start Indicator** panel is no longer available. Instead, the update panel of the SA OS/390 INGLIST command is displayed when you select this option on the **Support Functions** panel.

Coexistence between V1R4 and V2R2

Generally, you can control CICS subsystems running on a CICS Automation V1R4 target system from CICS Automation V2R2 (downward compatibility), and conversely CICS subsystems running on a CICS Automation V2R2 target system from CICS Automation V1R4 (upward compatibility). There is, however, the following restriction:

Service periods and triggers.

You can access the triggers and service periods of a CICS subsystem running on a CICS Automation V1R4 target system from CICS Automation V2R2; in this case, the CICS-specific panels of CICS Automation V1R4 are displayed. However, you cannot access a CICS subsystem running on a CICS Automation V2R2 target system from the **Service Periods Functions** or the **Triggers List** panels of CICS Automation V1R4. Therefore service periods and triggers are only downward compatible.

Chapter 4. How to Set Up the Functions of CICS Automation

This chapter explains how to set up the functions of CICS Automation for your specific needs. For the setup of base functions, for example, starting and stopping subsystems, see the SA OS/390 documentation.

Defining the SDF States for CICS Automation

The Status Display Facility uses color to represent the various subsystem resource statuses, for example, error, warning, action, or informational states. A subsystem shown in green on a Status Display Facility status panel indicates that it is up, whereas red indicates a stopped or problem state. For more information, see *System Automation for OS/390 Programmer's Reference*.

Priority, highlight level, and color definitions of the states are defined in the customization dialogs in a STATUS DETAILS policy object (SCR entry type). For CICS Automation, the following states must be available:

CICSTRAN	CICS Transactions.
CICSHLTH	Health checking.
CICSLMT	Link monitoring.
CICSTIMR	CICS timers.
CICSVIOL	Storage violations (CICS storage).
CICSSOS	Short on storage conditions (CICS storage).
VTAMACB	VTAM ACB errors.
CRITMSG	The default critical messages definition (CICS Critical Message).
CRITMSGA	Messages ending in A (CICS Critical Message).
CRITMSGE	Messages ending in E (CICS Critical Message).
CRITMSGW	Messages ending in W (CICS Critical Message).
CRITMSGI	Messages ending in I (CICS Critical Message).

Each of these categories except the suffixed **CRITMSGx** keywords corresponds to an item on the **CICS MONITOR PANEL** (see Chapter 11, "The Status Display Facility" on page 121). The color definitions indicate which color to use when a message is logged against a specific category. **CRITMSGA** through **CRITMSGI** are subcategories of **CRITMSG**. These subcategories are associated with different priorities, and the color of the **CICS Critical Messages** panel item, which corresponds to **CRITMSG**, is determined by the message that belongs to the subcategory with the highest priority.

The default specifications assign messages ending in I as having the lowest priority. Messages ending in W have the next highest, messages ending in E have the next highest, and messages ending in A have the highest priority. If a message ending in A is logged, the **CICS Critical Messages** item will turn to the color defined for those messages (probably red), overriding any other message color.

Automating Recovery For Transactions

CICS Automation provides automated recovery for::

- Short-on-storage conditions
- Storage violations
- Autoinstall problems
- VTAM ACB failures

You can control automated recovery through the following policy items of the APPLICATION object:

MINOR RESOURCE FLAGS

With these flags, you can switch automated recovery on and off for transactions or for a certain problem area. To do this, define a minor resource and set its **Recovery** flag as required. For the definition of minor resources, see *System Automation for OS/390 Defining Automation Policy*. The names of these minor resources must be as follows:

Table 4. Minor Resource Names for Problem Areas

Problem area	Minor resource name
Short-on-storage conditions	SOS
Storage violations	VIOL
Autoinstall problems	AUTO
VTAM ACB failures	VTAMACB
Transaction recovery	TRAN[.trans_id]

For transaction recovery, you can also define second-level minor resources by suffixing TRAN with the transaction name. The recovery flag of the TRAN minor resource applies to all transactions of the respective application; TRAN.trans_id only applies to the trans_id transaction. The transaction-specific recovery flag overrides the general TRAN flag.

When no minor resources are defined, CICS Automation acts according to the recovery setting of the application (AUTOMATION FLAGS policy item). When no second-level minor resource is defined for a transaction, the TRAN minor resource is applied. If that does not exist either, the application setting is applied. You only need to define minor resources when the recovery setting for a lower level is to be different from the next higher level.

RESOURCE THRESHOLDS

With this CICS-specific policy item, you determine the threshold at which recovery should stop. This threshold is defined by the number of errors within a certain time interval. As with the recovery flags, you must associate the threshold definition with the transaction/problem area by giving it one of the names listed in Table 4; you can also specify thresholds for a single transaction.

MESSAGES/USER DATA

For every recovery type, there are one or more keywords that are used to specify how recovery is to proceed. These keywords are:

Problem area	Keywords
Short-on-storage conditions	RCVRSOS (see page 56)

Problem area	Keywords
Storage violations	RCVRVIOL (see page 59)
Autoinstall problems	RCVRAUTO (see page 55)
VTAM ACB failures	—
Transaction recovery	ABCODETRAN (see page 50), RCVRTRAN (see page 58)

Transaction recovery is the most complex of these recovery types. Therefore this type is used to explain recovery configuration in more detail.

How to Define Transaction Recovery

Customization of transaction recovery consists of:

- Identifying the transactions that will have recovery automation.
- Identifying the error threshold level when recovery should be stopped.
- Identifying specific abend codes when you want recovery procedures to take place (there are probably several that you would want to ignore).
- Specifying the recovery procedure, which usually consists of invoking a command, a routine, and/or sending notification to an operator.

The recovery itself is typically triggered from the MAT by calling the EVEERTRN routine when certain messages arrive at NetView. EVEERTRN then consults the ACF in order to learn what it has to do for recovery.

The following sections illustrate the configuration process by an example.

Specifying the Transactions to be Recovered

If recovery is enabled for the CICS1 application on the application level, and you want to enable it also for transactions PAYR, DBTS, and BLNG, but not for any other transaction, you must define four minor resources for CICS1 in the customization dialogs:

```

COMMANDS  HELP
-----
Command ==>          Minor Resource Selection          Row 1 to 10 of 24
                    SCROLL==> PAGE

Entry Type : Application      PolicyDB Name  : SCENARIO
Entry Name  : CICS1           Enterprise Name : TEST

Major Resource: CICS1

Select minor resource option to be altered.

s  TRAN_____
-  TRAN.BLNG_____
-  TRAN.DBTS_____
-  TRAN.PAYR_____
-  _____
-  _____
-  _____
-  _____
-  _____

F1=HELP  F2=SPLIT  F3=END    F4=RETURN  F5=RFIND  F6=RCHANGE
F7=UP    F8=DOWN   F9=SWAP   F10=LEFT   F11=RIGHT F12=RETRIEVE

```

Figure 5. Defining Minor Resources for Transactions

Set the recovery automation flag to NO for TRAN and to YES for the three second level minor resources. For example, to do this for TRAN, enter s in the **Select** column and press ENTER. The following panel is displayed:

```

COMMANDS  ACTIONS  HELP
-----
                                Flag Automation Specification
Command ==>

Entry Type : Application          PolicyDB Name  : SCENARIO
Entry Name  : CICS1              Enterprise Name : TEST
                                           More:      +

Resource: CICS1.TRAN
Enter level of automation desired.

Automation Flags: Y = Yes      N = No      E = Exits
Assist Flags:     D = Display  L = Log     N = None

Actions  Flag      Auto      Assist  Exits
Automation .
Recovery . . NO
Start. . . .
ShutDown . .
Initstart. .
Restart. . .

F1=HELP    F2=SPLIT    F3=END     F4=RETURN  F5=RFIND   F6=RCHANGE
F7=UP      F8=DOWN     F9=SWAP   F10=LEFT   F11=RIGHT  F12=RETRIEVE

```

Figure 6. Automation Flag Panel

Here you specify which flags are set and which are not. For more information, see *System Automation for OS/390 Defining Automation Policy*.

Defining Recovery Thresholds

You can specify that recovery is to be stopped when the number of abends within a certain time interval reaches a certain threshold. To do this, define thresholds in the CICS-specific RESOURCE THRESHOLDS item of the APPLICATION policy object. The thresholds must have the name TRAN or TRAN.*tranid*, where the values of the TRAN thresholds will be used for all transactions *tranid* for which no TRAN.*tranid* thresholds exist. The **Critical** value of the thresholds will be used.

If you want to stop recovery specifically for PAYR if two or more abends occur within one hour, you must enter the values on the **Thresholds Definitions** panel as follows

```

COMMANDS  HELP
-----
                                Thresholds Definition                Policy saved
Command ==>>>

Entry Type : Application          PolicyDB Name  : SCENARIO
Entry Name  : CICS1              Enterprise Name : TEST

Resource:   CICS1.TRAN.PAYR
Description:

Specify the number of times an event must occur to define a particular level.

----- Levels -----
Resource          Critical          Frequent          Infrequent
                  Number Interval    Number Interval    Number Interval
                  (hh:mm)      (hh:mm)          (hh:mm)
CICS1.TRAN.PAYR   2          01:00            2          05:00            2          24:00

F1=HELP  F2=SPLIT  F3=END    F4=RETURN  F5=RFIND  F6=RCHANGE
F7=UP    F8=DOWN   F9=SWAP   F10=LEFT   F11=RIGHT  F12=RETRIEVE

```

Figure 7. Thresholds Definitions Panel

For more details, see *System Automation for OS/390 Defining Automation Policy*.

Selecting the Abend Codes

The abend codes for which recovery is to take place are specified through the ABCODETRAN keyword in the MESSAGES/USER DATA policy item for CICS1. If you want to initiate recovery for transaction PAYR only when the abend code is AEI0 or AKC3, you must create the ABCODETRAN entry in the **Message Processing** panel and associate codes with this entry as displayed in Figure 8:

```

COMMANDS  HELP
-----
                                Code Processing                Row 1 to 6 of 21
                                SCROLL==>> PAGE
Command ==>>>

Entry Type : Application          PolicyDB Name  : SCENARIO
Entry Name  : CICS1              Enterprise Name : TEST

Subsystem   : CICS1
Message ID  : ABCODETRAN.PAYR

Enter the value to be passed to the calling CLIST when this resource
issues the selected message and the following codes are contained in
the message.

Code 1          Code 2          Code 3          Value Returned
-----
                AEI0           _____    INCLUDE _____
                AKC3           _____    INCLUDE _____
                *              _____    EXCLUDE _____
                _____
                _____
                _____

F1=HELP  F2=SPLIT  F3=END    F4=RETURN  F5=RFIND  F6=RCHANGE
F7=UP    F8=DOWN   F9=SWAP   F10=LEFT   F11=RIGHT  F12=RETRIEVE

```

Figure 8. Code Processing Panel

For more details, see “ABCODETRAN—Transaction Abend Recovery” on page 50.

Specifying Recovery Actions

You specify the commands to be issued for recovery in the **CMD Processing** panel for the RCVRTRAN message keyword entry of CICS1. For example:

```
COMMANDS  HELP
-----
Command ==>          CMD Processing          Row 1 to 2 of 20
                               SCROLL==> PAGE

Entry Type : Application      PolicyDB Name  : SCENARIO
Entry Name  : CICS1           Enterprise Name : TEST

Subsystem   : CICS1
Message ID  : RCVRTRAN.PAYR

Enter commands to be executed when resource issues the selected message.

Pass/Selection Automated Function/'*'
Command Text
-----
MSG OP1, TRAN &EHKCFGV1 FAILED_____
_____
_____

F1=HELP    F2=SPLIT   F3=END     F4=RETURN   F5=RFIND   F6=RCHANGE
F7=UP      F8=DOWN     F9=SWAP    F10=LEFT    F11=RIGHT  F12=RETRIEVE
```

Figure 9. Command Processing Panel

For more details, see “RCVRTRAN—Transaction Recovery” on page 58.

How to Set Up the State/Action Tables

In CICS Automation, state/action tables are used for recovery of:

- Short-on-storage-conditions
- Storage violations
- Autoinstall problems
- VTAM ACB failures

State/action tables work independently of service periods and external triggers and are referenced when messages occur that are relevant to these entities. For an explanation on what state/action tables are and how they work, see “State/Action Tables” on page 11.

If you want to enable automated recovery for one of the problem areas listed above with respect to a CICS application, proceed as follows:

- If the recovery flag of the application (AUTOMATION FLAGS policy item) is set to NO, define a minor resource for the respective problem area in the customization dialogs in the MINOR RESOURCE FLAGS policy item of the CICS application and set its recovery flag to YES. For details, see “Automating Recovery For Transactions” on page 28.
- Associate the respective CICS application with a set of state/action tables. To do this, you must perform two steps in the customization dialogs:
 1. Define a set of state/action tables as a CICS STATE/ACTION policy object for CICS (CSA entry type).
 2. Link the set to the subsystem in the STATE ACTION TABLE policy item of the APPLICATION object.

The state/action tables are read and the actions or state changes performed by the EVEEY00S routine (see “EVEEY00S—Common State Handler for State/Action Tables” on page 79). EVEEY00S is invoked from the MAT. It determines which set of state/action tables is associated with the subsystem that issued the message, and then refers to the appropriate table. In addition to EVEEY00S, the following components for support of state/action processing are provided with CICS Automation:

- Default state/action tables for recovery actions:

Topic	Name of state/action table
Short-on-storage condition	EVEESA01
Storage violations	EVEESA02
Autoinstall problems	EVEESA03
VTAM ACB failures	EVEESA04

- Common routines to be used by the action routines
- Action routines

Note: Some of these routines make use of the information specified in the RCVRAUTO, RCVR SOS, and RCVRVIOL entries. For information on these entries, see Chapter 5, “MESSAGES/USER DATA Entries for CICS Automation” on page 41.

Every state/action table is associated with an *area* and a *product*. The area tag specifies for which of the problem areas the table is intended, the product tag says whether the table is to be used by CICS Automation or by IMS Automation. These tags must be specified in the first two rows of the table. The format for CICS Automation is:

```
PRODUCT=CICS
AREA={AUTO|SOS|VIOL|VTAMACB}
```

In the third row of the table, you must specify the initial state of the table, that is, the state that is assumed when the table is consulted for the first time. Thus, the header of the sample table in Figure 4 on page 12 would have to look like this:

```
PRODUCT=CICS
AREA=SOS
STATE=0
```

How to Set Up Health Checking

Health checking allows you to execute programs that check the health of an application running under CICS. CICS Automation initiates a health check program by sending a request across the program-to-program interface to the target CICS. CICS receives the request, processes the program, and sends the results back to NetView.

Note: Sample health check code is provided with CICS Automation. This code can be modified and used to check the availability of critical resources, such as DB2® or IMS.

Health checking is set up in the following manner:

Step 1: The health check program is written

The actual health check program is executed on the target CICS. According to the health check protocol, one of the following is returned:

- An acknowledgment (ACK) stating that the program completed successfully.
- A negative acknowledgment (NACK) stating that the program did not complete successfully. If a NACK response is given, data can be passed back to NetView describing the error condition.

The ACK or NACK are returned through the use of a DFHCOMMAREA. The user-written health check program is linked to by a CICS Automation health check program, which passes the 104-byte DFHCOMMAREA. The first four bytes are reserved for the characters ACK or NACK. The last 100 bytes can be used for a NACK message if the user-written program encounters an error. Refer to the samples for the format of the DFHCOMMAREA, and for an example of how to use the DFHCOMMAREA to return the response.

Step 2: The health check programs are defined to CICS

Use either the *CICS/MVS Resource Definition (Online)* or the *CICS/ESA Resource Definition (Online)* publication to do this.

Step 3: The health check program is defined to CICS Automation

The health check program is defined to CICS Automation in the MESSAGES/USER DATA policy item HEALTHCHK (see “HEALTHCHK—Health Checking” on page 52 on the **User Defined Data** panel. For example:

```

COMMANDS  HELP
-----
User Defined Data                                Row 1 to 2 of 20
Command ==>                                     SCROLL==> PAGE

Entry Type : Application      PolicyDB Name  : SCENARIO
Entry Name  : CICS1           Enterprise Name : TEST

Subsystem   : CICS1
Message ID  : HEALTHCHCK

To change keyword-data pair, specify the following:

Keyword
Data
FUNCTION
(0,PAYCHECK,00:02:00,15,, 'Check payroll')_____

_____

_____

F1=HELP    F2=SPLIT   F3=END     F4=RETURN   F5=RFIND   F6=RCHANGE
F7=UP      F8=DOWN     F9=SWAP    F10=LEFT    F11=RIGHT  F12=RETRIEVE

```

Figure 10. Defining a Health Check Program to CICS Automation

Up to 10 health check programs can be defined for each CICS subsystem. Zero (0) is the first one defined. One (1) would be the second one, two (2) the third one, and so on. The program name, in this case PAYCHECK, is used to identify the specific health check program. You will also indicate how often you want the program executed (every two minutes) and how long you want to wait for a response before sending operator notification (fifteen seconds). The description (for example ‘Check payroll’) is used on the CICS Automation Health Checking panel, see “Health Checking” on page 115.

How to Set Up Link Monitoring

CICS communicates with other systems or subsystems using either intersystem communication (ISC) or interregion communication (IRC). In either ISC or IRC, communication between different systems or subsystems takes place across predefined sessions. Sessions are logical links that are allocated whenever there is a need to communicate.

In order to activate link monitoring, perform the following steps:

1. Define the link in a CICS LINK policy object (CCN entry type).
2. Define the monitoring periods in a MONITORING PERIOD policy object (CVP entry type).
3. Connect the monitoring periods to the link in the MONITORING PERIOD item of the CICS LINK object.
4. Connect the link to a CICS application in the CICS CONNECTION item of the APPLICATION policy object.

For more details, see *System Automation for OS/390 Defining Automation Policy*.

Setting Up Echoplexing

Basic link monitoring ensures that VTAM connections are acquired and available but does not detect problems at the other end of the link. CICS Automation provides the ability to verify the other end of the link by sending data across it and waiting for a response. This is referred to as *echoplexing*. You can echoplex to any system or subsystem as long as the:

1. Link is defined on the primary CICS region.
2. Type of connection is either multiregion operation (MRO), LU6.1 or LU6.2.
Note: LU6.2 is not supported for links to IMS systems.
3. Target system is either CICS, or IMS.

SA OS/390 is not required on the target systems. With IMS target systems, no additional programming is required; CICS Automation uses the IMS /TEST function to get a response from IMS.

A CICS target subsystem requires access to EVESYCB7 (a CICS Automation program), and the definitions required for this program are made as shown:

```
DEFINE TRANSACTION(ECHO) PROGRAM(EVESYCB7)
DEFINE PROGRAM(EVESYCB7) LANGUAGE(ASSEMBLER)
```

Note: The default name for the transaction is ECHO. This can be changed as long as the transaction definition on the target system matches the transaction name on the primary system that is identified with the ECH0= keyword.

Security Checking Using CICS

You can use CICS-supplied security to restrict which operators can access defined resources within a CICS environment.

The security check works by using the NetView operator ID that invoked the CICS Automation function. When the function to be performed is invoked in the NetView environment, the invoking operator ID is passed to the CICS system on which the action will be taken. The appropriate transaction or function is invoked, and the NetView operator ID is used in all CICS security checks.

To use this security, you must:

- Define all NetView operators which will invoke CICS functions to RACF (or your SAF-compliant security system). This will include:
 - Regular NetView operators
 - NetView autotasks which perform CICS-related actions. These autotasks include those autotasks specifically defined for CICS Automation use, and may include the autotasks which process shutdown functions or resynchronization functions.
- Define RACF surrogate authorization for CICS.
- Connect the NetView operators to the CICS resources which they will need to access, such as transactions, programs and files. This connection is done through your SAF security manager (such as RACF).
- Enable the security by modifying the EVESPINM member and specifying USERID=YES to enable extended support. For more information on EVESPINM, see “EVESPINM—CICS PPI Initialization Member” on page 92.
- Enable non-terminal transaction security in CICS by modifying the CICS SIT to specify XTRAN=YES and XUSER=YES. Additional CICS definitions may require similar modification, such as PLTPIUSER.

Note: In order to perform any of the basic functions of CICS Automation, like displaying subsystem information, an operator must be authorized to use the ACF command. For this command, see *System Automation for OS/390 Operator's Commands*.

Adding Local Applications to the CICS Automation Operator Interface

Option 99, Local Functions, from the CICS Automation main menu, provides you with a way to add your local applications to the CICS Automation interface.

To do this, write a module named EVEEU000 using the programming notes described below. This is the module that is called when option 99 is selected.

These programming notes assume that you understand how to write a NetView panel handler exec. These notes clarify unique functions or conventions used with CICS Automation. For your panel to be logically consistent with the CICS Automation interface, incorporate these functions.

Programming notes:

1. To exit CICS Automation (PF2) or to return to the main menu (PF4), code the following after displaying your panel and accepting the input:

```
WHEN VIEWAID = 'PF2' | VIEWAID = 'PF14' THEN
DO
  EVE_PF2 = 'YES'
  'GLOBALV PUTT EVE_PF2'
  EXIT 0
END
```

and

```
WHEN VIEWAID = 'PF4' | VIEWAID = 'PF16' THEN
DO
  EVE_PF4 = 'YES'
  'GLOBALV PUTT EVE_PF4'
  EXIT 0
END
```

2. When you call a module and you return from that module, you should exit if the called module displays a panel and PF2 or PF4 was pressed. To check for this, code the following after the call.

```
'GLOBALV GETT EVE_PF2'
IF EVE_PF2 = 'YES' THEN
DO
  EXIT 0
END
```

and

```
'GLOBALV GETT EVE_PF4'
IF EVE_PF4 = 'YES' THEN
DO
  EXIT 0
END
```

3. To handle a fast-path command entered on your panel:
 - a. Add the following to the beginning of the program:

```
'SIGNAL ON HALT'
```

- b. Add the following routine into the program:

```
HALT:
  EVE_PF2 = 'YES'
  'GLOBALV PUTT EVE_PF2'
  EXIT 0
```

- c. Add the following code after displaying your panel and accepting input:

```
WHEN VIEWAID = 'ENTER' & CMD ^= '' THEN
DO
  IF SUBSTR(CMD,1,1) = '=' THEN
DO
  PARSE VAR CMD '=' REST
  CMD = 'EVEE0000 ' || REST
  END
  'CMD HIGH 'CMD
END
```

Note: In this code, CMD is the command line on the NetView panel.

4. If you code a menu panel, add the following code to check for fast-path when your program is entered:

```
'GLOBALV GETT EVE_SELECTION'
IF EVE_SELECTION ^= ''
DO
  PARSE EVE_SELECTION MYSELECTION '.' EVE_SELECTION
  'GLOBALV PUTT EVE_SELECTION'
END
```

5. On entry, or returning from a called program, to get the CICS subsystem name (if the previous program had a valid name and saved it) code the following:

```
'GLOBALV GETT EVESELNM'
MYNAME = EVESELNM
```

6. Always validate a new CICS name before storing it for other programs to use. The following is an example of validation:

```
'CICSQRY REQ=VALIDATE,TYPE=CICS,NAME='MYNAME
IF RC ^= 0
DO
  write your error message
END
ELSE
EVESELNM=MYNAME
'GLOBALV PUTT EVESELNM'
```

Using Linemode Functions

Linemode functions allow the operator or user-written routines to access the following special CICS Automation functions without using the CICS Automation panels:

- Health checking
- SIT override
- Link monitoring
- Message options
- CICSPOST
- CEMTPPI

The linemode routines allow the extension of automation from user-written routines. The user-written routine issues the linemode command during NetView initialization or at a specific time or day. A message and return code is given to the calling routine to verify that the requested operation was successful.

Health Checking

Linemode health checking makes it possible to manipulate health-check routines from a user-written command. A health-check program is a user-written routine which executes periodically to ensure that a critical application is capable of supporting its users. The actions supported include suspending and resuming the health-check program. Other actions are supported.

SIT Override

Linemode SIT overrides give user-written routines the capability of setting the SIT overrides, which can then be used by CICS Automation to control the startup of the CICS. A typical use of this linemode command will be to enable automation to perform cold startups on a given day of the week. For example, using SA OS/390 timer facilities, a user could set a timer to set the overrides to cold-start every Monday morning. Then, using service periods, the CICS system could be recycled, and a cold start would be performed.

Link Monitoring

Linemode link monitoring provides support for the link monitoring functions of CICS Automation. Support for most of the link monitoring capabilities are provided; excluded are system news update, service period update and recover-all-links functions.

Message options

Linemode message options enables a user-written routine to change the message header options which display on the operator panel. Typical use of this command is during NetView initialization, when a user-written routine would set the domain-wide defaults.

CICSPOST

You can use the CICSPOST routine to set trigger conditions. Internally, the INGEVENT command of SA OS/390 is called. See *System Automation for OS/390 Operator's Commands* for more information on INGEVENT.

CEMTPPI

CEMTPPI allows you to code a CEMT command:

1. In your own automation routines.
2. In the NetView message automation table.
3. In the policy database in certain items of the APPLICATION policy object such as STARTUP or SHUTDOWN, or in certain message IDs, for example RCVRSOS.

It accepts CEMT input as data, sends it across the program-to-program interface, and sends a response back to the originating task.

How to Implement Remote Site Recovery for VSAM RLS (CICS TS Function Only)

CICS TS provides support for remote site recovery where VSAM data sets are used in RLS mode at the primary site. Using this RLS support for remote recovery, you can switch over to the remote site without suffering indeterminate or unreported loss of data integrity.

To invoke CICS RLS support for off-site recovery, you must start CICS systems with INGREQ using start type AUTO and specifying OFFSITE=YES in the **Appl Parm**s field of the INGREQ input panel. See "Startup" on page 107.

With RLS recovery in operation during an emergency restart, CICS prevents any data sets from being accessed in RLS mode until CICS has completed all outstanding RLS recovery work and it has received a 'GO' response to WTOR DFHFC0575.

The operator should reply 'GO' to the message only when all the CICS regions being restarted with OFFSITE=YES have issued message DFHFC0575 indicating that they have completed their RLS recovery.

CICS TS provides a sample REXX exec DFH\$OFAR to be used to automatically reply 'GO' to the WTOR for each participating CICS system, when appropriate.

To be able to use the CICS TS-provided sample REXX exec DFH\$OFAR, you will need to copy it from the CICS TS DFHSAMP library into a DSICLD concatenated library. Refer to the CICS TS documentation for more information.

DFH\$OFAR requires that a unique control file (a sequential data set) be defined containing all the participating CICS systems. This control file must be accessible from any participating MVS image within the sysplex. Refer to the prolog in the REXX exec DFH\$OFAR for more detailed information.

CICS Automation provides the MAT entries required to drive the CICS TS-provided REXX exec DFH\$OFAR. Merge these entries into your own MAT to be able to use this function.

Special Considerations for RACF-Protected Subsystems

When a CICS subsystem is RACF protected, the CICS autotask must first sign on to the subsystem to be able to issue commands. The user exits EVEEX080 and EVEEX081 are supplied as user-modifiable samples.

Tailoring:

Module EVEEX081 must be modified to your specific CICS names, operator sign-on IDs and passwords. For example, in EVEEX081 in the statement `evecesn.CICS10AA.opid = 'CICSn'` change CICS10AA to your CICS jobname and change CICSn to your operator sign-on ID. In `evecesn.CICS10AA.pswd = 'CICSn'` change CICS10AA to your CICS jobname and change CICSn to your password. You have as many of these pairs of statements as you have CICS jobs that you want to protect with RACF.

RACF Consideration:

You need to define the operator sign-on ID to RACF with NOINTERVAL so the password does not have to be changed at certain intervals. The operator sign-on ID needs to have RACF authority for CEMT commands.

Changing Password:

If you need to change the password for the CICS operator sign-on, change the following statement in EVEEX081 from:

```
evecesn.CICS10AA.newpswd = ''
```

to:

```
evecesn.CICS10AA.newpswd = 'CICS9'
```

where CICS9 is the new password and CICS10AA is your CICS job name.

Note: After EVEEX080 is executed, which will sign the operator on with the new password, be sure to change the password in EVEEX081 to the new password and erase the new password as follows:

from:

```
evecesn.CICS10AA.pswd = 'CICS1'  
evecesn.CICS10AA.newpswd = 'CICS9'
```

to:

```
evecesn.CICS10AA.pswd = 'CICS9'  
evecesn.CICS10AA.newpswd = ''
```

where CICS1 is the former password and CICS9 is the new/current password.

Special Considerations for Collecting CPSM alerts

Alerts generated by CPSM SAM, MRM and RTA functions can be displayed in SDF and on NMC. If no actions are taken, these alerts are logged against the CPSM CMAS address space that issues them. However, by defining the CMAS subsystem as a CMAS to CICS Automation, the function determines the CICS subsystem that has the problem and will log the alert against the appropriate CICS subsystem.

To achieve this, define the name of the CMAS in the CMASid field of the CICS Control policy item for the CMAS subsystem.

Chapter 5. MESSAGES/USER DATA Entries for CICS Automation

You must specify any information for CICS Automation in the SA OS/390 policy database through the customization dialogs. In most cases the customization dialogs determine the format in which this information must be entered. There are, however, a number of CICS application-specific automation parameters that must be specified as entries in the MESSAGES/USER DATA policy item of the appropriate application. For further information about the MESSAGES/USER DATA policy item, see *System Automation for OS/390 Defining Automation Policy*.

The following chapter contains detailed descriptions of these automation entries. However, a general understanding of the MESSAGES/USER DATA policy item is assumed.

Translating Format Descriptions into MESSAGES/USER DATA Entries

The following examples show how to convert the formal descriptions of the keyword parameters into entries in the MESSAGES/USER DATA panels of the customization dialogs.

The first example is the RCVRSSOS keyword. With this entry, you specify that the operator is notified and optionally one or more commands be issued when CICS is short on storage for a certain amount of time (see “RCVRSSOS—Short-On-Storage Handling” on page 56 for more details). The format description of RCVRSSOS is as follows:

Format
<pre>RCVRSSOS TIMELIMIT=<i>mm:ss</i> [CMD=(,<i>Command_Text</i>)] . . . [CMD=(,<i>Command_Text</i>)]</pre>

The NAME=value pairs are called the *attributes* of the entry. RCVRSSOS has two attributes, TIMELIMIT and CMD. TIMELIMIT must occur exactly once, CMD can occur zero or more times. For general information on the format descriptions, see “Notation for Format Descriptions” on page xi.

If you want the operator to be notified and a dump to be produced when the subsystem CICS1 is short on storage for more than 30 seconds. To specify a RCVRSSOS entry for CICS1 in the customization dialogs, you must call the **Message Processing** panel for that subsystem:

```

COMMANDS  ACTIONS  HELP
-----
Message Processing                               Row 1 to 4 of 20
Command ==>                                     SCROLL==> PAGE

Entry Type : Application           PolicyDB Name : SCENARIO
Entry Name : CICS1                 Enterprise Name : TEST

Subsystem : CICS1

Enter messages issued by this resource that will result in automated actions.
Actions: CMD = Command  REP = Reply  CODE = CODE  USER = User defined values

Action  Message ID                               Cmd  Rep  Code  User
Description
CMD_____RCVRSOS_____
How to react to storage shortage_____
_____
_____
_____
_____

F1=HELP   F2=SPLIT   F3=END   F4=RETURN   F5=RFIND   F6=RCHANGE
F7=UP     F8=DOWN    F9=SWAP  F10=LEFT   F11=RIGHT  F12=RETRIEVE

```

Figure 11. Message Processing Panel of the Customization Dialogs 1

In this panel you specify the keyword of the entry (RCVRSOS in our example) in the **Message ID** field. The attributes are specified through the **Action** field. Here, two cases must be distinguished according to the following rule:

Rule

- The attribute names **CMD**, **CODE**, and **REP** must be entered in the **Action** field; the values for these attributes are specified in a follow-on panel.
- For all other attributes, you must enter **USER** in the **Action** field; in this case, both name and value are entered in a follow-on panel.

The fields on the right side of the panel specify how many actions of the respective type are associated with the message ID of the respective line.

To specify the value for the (optional) **CMD** attribute enter **CMD** in the **Action** field and press **ENTER**. This invokes the **CMD Processing** panel:

```

COMMANDS  HELP
-----
Command ==>          CMD Processing          Row 1 to 2 of 20
                   SCROLL==> PAGE

Entry Type : Application      PolicyDB Name  : SCENARIO
Entry Name  : CICS1           Enterprise Name : TEST

Subsystem   : CICS1
Message ID  : RCVRSOS

Enter commands to be executed when resource issues the selected message.

Pass/Selection Automated Function/'*'
Command Text
-----
EVEERDMP CICS1 _____
_____
_____

F1=HELP    F2=SPLIT   F3=END     F4=RETURN   F5=RFIND   F6=RCHANGE
F7=UP      F8=DOWN     F9=SWAP    F10=LEFT    F11=RIGHT  F12=RETRIEVE

```

Figure 12. CMD Processing Panel of the Customization Dialogs

Every entry in this panel consists of three fields that correspond to the three items of the value list for the CMD attribute. This way, the general format for the CMD attribute is

`CMD=([Pass/Selection],[Automated_Function],Command_Text)`

The format description of the CMD attribute for a certain keyword specifies what type of information you must enter in the three fields. For the RCVRSOS keyword, the omission of the first two values signifies that the fields **Pass/Selection** and **Automated Function** are to be left blank. A command text must be specified in the third field.

For the CMD, REP, and CODE attributes, the following notational conventions apply:

Notational Conventions for CMD, CODE, REP Attributes

- The '=' sign, the parentheses enclosing the value list, and the commas separating the individual values must not be entered in the panels. They just serve to make the format description more readable and to identify uniquely the panel field with which a value specification is associated.
- When the format of any value is specified in more detail, and this specification contains a comma, the value is enclosed in single quotes; these quotes must also not be entered in the respective panel field.

For the other attributes, the conventions are different; see "Notational Conventions for USER Attributes" on page 44.

For more information on the panel fields, see *System Automation for OS/390 Defining Automation Policy*. For the EVEERDMP command, see "EVEERDMP—CICS Dump" on page 77.

The second (required) attribute of RCVRSOS is TIMELIMIT. To enter the time limit, return to the **Message Processing** panel, where the number '1' is displayed in the **Cmd** field of the RCVRSOS entry. Specify USER in the **Action** field on the RCVRSOS line according to the rule stated on page 42, and press ENTER. The following panel is invoked:

```

COMMANDS  HELP
-----
Command ==>          User Defined Data          Row 1 to 2 of 20
                   SCROLL==> PAGE

Entry Type : Application      PolicyDB Name   : SCENARIO
Entry Name  : CICS1           Enterprise Name : TEST

Subsystem   : CICS1
Message ID  : RCVRSOS

To change keyword-data pair, specify the following:

Keyword
Data
TIMELIMIT _____
00:30 _____

-----
F1=HELP    F2=SPLIT   F3=END     F4=RETURN   F5=RFIND   F6=RCHANGE
F7=UP      F8=DOWN     F9=SWAP    F10=LEFT    F11=RIGHT  F12=RETRIEVE

```

Figure 13. User-Defined Data Panel of the Customization Dialogs

As you can see from Figure 13, you must enter the attribute name in the **Keyword** field and the attribute value(s) in the **Data** field.

For attributes of the USER action type, the following conventions apply:

Notational Conventions for USER Attributes

- The '=' sign must not be entered in the panels.
- Everything to the right of the '=' sign, including parentheses, commas, and single quotes, *must* be entered in the **Data** field.

When you return to the **Message Processing** panel, the number '1' will be displayed in the **User** field.

The ABCODETRAN entry (see “ABCODETRAN—Transaction Abend Recovery” on page 50) supplies the second example. This entry specifies conditions for transaction recovery (for more details on transaction recovery, see “How to Define Transaction Recovery” on page 29). The format of the ABCODETRAN entry is as follows:

```

Format
ABCODETRAN[.tran]
    CODE=(tran,abend1,pgm,{INCLUDE|EXCLUDE})
    [CODE=(tran,abend1,pgm,{INCLUDE|EXCLUDE})]
    .
    .
    .
    [CODE=(tran,abend1,pgm,{INCLUDE|EXCLUDE})]

```

For ABCODETRAN, you must specify one or more instances of the CODE attribute.

If you want transaction recovery to be performed for transaction PAYR on CICS1 for all abend codes except AKC3, you must enter the ABCODETRAN entry for CICS1 as follows:

First specify the keyword in the **Message Processing** panel:

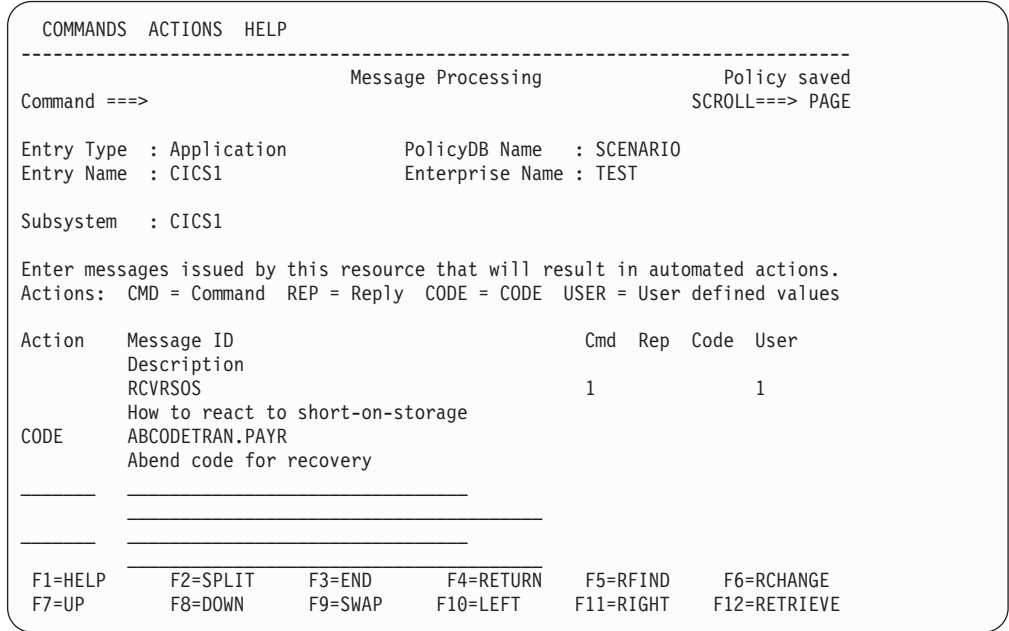

Figure 14. Message Processing Panel of the Customization Dialogs 2

Note that the keyword is expanded by the transaction name in order to restrict the application of the specified codes to transaction PAYR.

You must enter CODE in the **Action** column according to the rule stated on page 42. When you press ENTER, the **Code Processing** panel is displayed:

```

COMMANDS  HELP
-----
Code Processing                               Row 1 to 6 of 20
Command ==>                                SCROLL==> PAGE

Entry Type : Application                      PolicyDB Name : SCENARIO
Entry Name : CIGS1                           Enterprise Name : TEST

Subsystem : CIGS1
Message ID : ABCODETRAN.PAYR

Enter the value to be passed to the calling CLIST when this resource
issues the selected message and the following codes are contained in
the message.

Code 1      Code 2      Code 3      Value Returned
* _____ AKC3 _____ * _____ EXCLUDE _____
* _____ * _____ * _____ INCLUDE _____
_____
_____
_____
_____
_____
_____
F1=HELP    F2=SPLIT  F3=END     F4=RETURN  F5=RFIND   F6=RCHANGE
F7=UP      F8=DOWN   F9=SWAP    F10=LEFT   F11=RIGHT  F12=RETRIEVE

```

Figure 15. Code Processing Panel of the Customization Dialogs

Here you must specify the values of the CODE attribute as displayed in Figure 15. The general format of the CODE attribute is:

CODE=([Code_1], [Code_2], [Code_3], Value_Returned)

For the ABCODETRAN keyword, **Code 1** must be a transaction name, **Code 2** an abend code, and **Code 3** the name of a program that abended. **Value Returned** must specify whether to include in, or to exclude from, recovery the combination specified by **Code 1** to **Code 3**. For other keywords, however, the fields can have a quite different function.

An asterisk (*) is admitted as a *trailing* wildcard character for the three **Code** fields; that is, you can specify simply * and ABC*, but not *ABC.

CICS-Specific MESSAGES/USER DATA Keywords

The following keywords are specific for CICS Automation.

Entry	Description
"ABCODESYSTEM—System abend recovery" on page 48.	Use this ID to define actions to be taken for specific abend codes.
"ABCODETRAN—Transaction Abend Recovery" on page 50.	Use this ID to define actions to be taken for transaction abend codes.
"HEALTHCHK—Health Checking" on page 52.	This ID is used to define the health check routines.
"LISTSHUT—Transaction Purging During Shutdown" on page 54.	Use this ID to define those transactions running under this CICS subsystem that should or should not be purged during a shutdown.
"RCVRSOS—Short-On-Storage Handling" on page 56.	Use this ID if you want CICS Automation to take action for short on storage conditions.
"RCVRVIOL—Storage Violation Handling" on page 59.	Include this ID to define commands to be executed as a result of recursive storage violations.

Entry	Description
"RCVRAUTO—Autoinstall Time Limit" on page 55.	Use this ID to send alerts to the operator if a CICS autoinstall takes longer than the specified time.
"RCVRTRAN—Transaction Recovery" on page 58.	Use this ID to define actions to be taken when this specific transaction has abended.

ABCODESYSTEM—System Abend Recovery

ABCODESYSTEM—System abend recovery

Use this entry to either include specific abend codes in recovery or exclude them from recovery.

Format

```
ABCODESYSTEM CODE=(msg,abend1,abend2,{RESTART|NORESTART})  
[CODE=(msg,abend1,abend2,{RESTART|NORESTART})]  
.  
.  
[CODE=(msg,abend1,abend2,{RESTART|NORESTART})]
```

Keyword and Parameter Definitions

CODE

Defines which abends are restartable, as shown in the following descriptions:

msg

The abend message ID.

abend1 and *abend2*

The specific abend codes or qualifiers.

RESTART|NORESTART

Indicates whether or not to initiate a restart for this subsystem when this specific message/abend code(s) occur(s).

Comments and Usage Notes

1. Abend qualifiers vary depending on the MAT. Refer to sample tables to determine the qualifiers for each message.
2. If a CICS message (DFHxxxxx) is trapped and included in the ABCODESYSTEM table, then it is not usually necessary to code the corresponding IEF450I message with the same user abend code (Uxxxx) in the table. An exception to this may be DFHKE1800, which is issued so closely in time to IEF450I that it may be processed before the DFHKE1800. It is therefore recommended that you either:
 - Add both DFHKE1800 and IEF450I with U1800 to the table, or
 - Exclude DFHKE1800 from the table and from the MAT as well.
3. When CICS issues one of the following abend messages:

DFHLG0736	DFHLG0738	DFHLG0740	DFHRM0134	DFHRM0136
DFHRM0144	DFHRM0401	DFHDM0106	DFHTM0400	DFHSI1542

a restart of CICS requires INITIAL to be specified as the startup type. In these cases CICS Automation prevents a restart by ARM. Rather, the restart policy must be defined with the ABCODESYSTEM entry.

Examples of Usage

```

COMMANDS  HELP
-----
Code Processing                               Row 1 to 6 of 20
Command ==>                                SCROLL==> PAGE

Entry Type : Application                      PolicyDB Name : SCENARIO
Entry Name : CICS1                           Enterprise Name : TEST

Subsystem : CICS1
Message ID : ABCODESYSTEM

Enter the value to be passed to the calling CLIST when this resource
issues the selected message and the following codes are contained in
the message.

Code 1      Code 2      Code 3      Value Returned
IEF450I_____ S222_____ *_____ RESTART_____
DFH0607_____ *_____ *_____ RESTART_____
DFH3784_____ *_____ *_____ RESTART_____
DFH0408_____ *_____ *_____ NORESTART_____

-----
F1=HELP    F2=SPLIT   F3=END     F4=RETURN  F5=RFIND   F6=RCHANGE
F7=UP      F8=DOWN    F9=SWAP    F10=LEFT   F11=RIGHT  F12=RETRIEVE
    
```

In this example, a restart will be initiated for message IEF450I if the qualifier is S222. If messages DFH607 or DFH3784 are issued, restarts will be initiated. No restart will be initiated for message DFH0408.

ABCODETRAN—Transaction Abend Recovery

ABCODETRAN—Transaction Abend Recovery

Use this entry to define actions to be taken for transaction abend codes.

Format

```
ABCODETRAN[.tran]
    CODE=(tran,abend1,pgm,{INCLUDE|EXCLUDE})
    [CODE=(tran,abend1,pgm,{INCLUDE|EXCLUDE})]
    .
    .
    [CODE=(tran,abend1,pgm,{INCLUDE|EXCLUDE})]
```

Keyword and Parameter Definitions

ABCODETRAN[.tran]

You can add the name of a transaction as a suffix to the keyword. In this case the specifications of the CODE attribute(s) will only apply to this transaction.

CODE

Defines which abends are recoverable, as shown in the following descriptions:

tran

The transaction ID.

abend1

The abend code.

pgm

The program that abended.

INCLUDE|EXCLUDE

Indicates whether or not to initiate a recovery for this transaction, abend code, and program. Use INCLUDE to initiate a recovery and EXCLUDE if you do not want a recovery initiated.

Comments and Usage Notes

The transaction name is either specified as **ABCODETRAN.tran** or as the first value of the CODE attribute. Use **ABCODETRAN.tran** when you want all of the specifications to apply to one specific transaction. Use the CODE attribute when you want to code several transactions.

ABCODETRAN—Transaction Abend Recovery

Examples of Usage

```
COMMANDS  HELP
-----
Code Processing                               Row 1 to 6 of 20
Command ==>                                SCROLL==> PAGE

Entry Type : Application                      PolicyDB Name : SCENARIO
Entry Name : CICS1                           Enterprise Name : TEST

Subsystem : CICS1
Message ID : ABCODETRAN

Enter the value to be passed to the calling CLIST when this resource
issues the selected message and the following codes are contained in
the message.

Code 1      Code 2      Code 3      Value Returned
CSFE_____ ATNI_____ *_____ EXCLUDE_____
CSFE_____ AKC3_____ *_____ EXCLUDE_____
*_____ *_____ *_____ INCLUDE_____
_____
_____

F1=HELP    F2=SPLIT    F3=END      F4=RETURN   F5=RFIND    F6=RCHANGE
F7=UP      F8=DOWN     F9=SWAP     F10=LEFT    F11=RIGHT   F12=RETRIEVE
```

In this example, recovery will not take place for transaction CSFE if the abend code is ATNI or AKC3. Recovery will take place for all other transaction and abend codes.

HEALTHCHK—Health checking

HEALTHCHK—Health Checking

Use this entry to define the health check routines.

Format

```
HEALTHCHK FUNCTION=(0,pgm,int,resp,{AUTO|NOAUTO},'desc')
      .
      .
      .
      [FUNCTION=(9,pgm,int,resp,{AUTO|NOAUTO},'desc')]
```

Keyword and Parameter Definitions

0 through 9

Up to 10 health check entries can be specified for each CICS subsystem. 0 to 9 identifies a health check entry.

pgm

The program name as defined to the CICS region.

int

The interval, expressed in hours, minutes, and seconds, in which this health-check program is to be initiated. The format is *hh:mm:ss*. The maximum is 99:59:59.

Note: The interval must be greater than the response time limit.

resp

How long to wait for a response before sending an alert to the operator. This is expressed in seconds. The maximum is 120 seconds.

AUTO|NOAUTO

Specify NOAUTO if you only want this health check routine to be activated through the operator interface. The default AUTO activates the routine automatically when the CICS subsystem status is changed to UP, and deactivates it when the CICS subsystem terminates.

desc

The description of this health check routine as it appears on the CICS Automation Health Checking panel. Up to 20 characters can be used.

Comments and Usage Notes

1. It is recommended that the AUTO default be used with the HEALTHCHK parameter.
2. Refer to “How to Set Up Health Checking” on page 33 for more information about health checking.

Examples of Usage

```

COMMANDS  HELP
-----
Command ==>          User Defined Data          Row 1 to 2 of 20
                   SCROLL==> PAGE

Entry Type : Application      PolicyDB Name : SCENARIO
Entry Name  : CICS1           Enterprise Name : TEST

Subsystem   : CICS1
Message ID  : HEALTHCHK

To change keyword-data pair, specify the following:
Keyword
Data
FUNCTION
(0,HCPAY1,00:02:00,15,, 'Check payroll database')_____

FUNCTION
(1,IMS,00:02:00,15,, 'Check IMS001')_____

F1=HELP      F2=SPLIT      F3=END      F4=RETURN      F5=RFIND      F6=RCHANGE
F7=UP        F8=DOWN       F9=SWAP     F10=LEFT       F11=RIGHT     F12=RETRIEVE

```

There are two health check programs that will be run, HCPAY1 and IMS, and these will be run every 2 minutes. If no response arrives within 15 seconds, the operator is notified.

LISTSHUT—Transaction purging during shutdown

LISTSHUT—Transaction Purging During Shutdown

Use this entry to define those transactions running under this CICS application that should or should not be purged during a shutdown.

Format

```
LISTSHUT {EXCLUDE|INCLUDE}=transid  
        [{EXCLUDE|INCLUDE}=transid]  
        .  
        .  
        .  
        [{EXCLUDE|INCLUDE}=transid]
```

Keyword and Parameter Definitions

EXCLUDE

Do not purge this transaction during a shutdown.

INCLUDE

Purge this transaction during a shutdown.

Comments and Usage Notes

1. If this entry is not used, no transactions are purged.
2. When the LISTSHUT entry is used for this application, the CICSPURG command list must be coded in the shutdown policy for this application. For information on CICSPURG, see “CICSPURG—Purge Transactions” on page 72.

Examples of Usage

```
COMMANDS  HELP  
-----  
User Defined Data                                Row 1 to 2 of 20  
Command ==>                                     SCROLL==> PAGE  
  
Entry Type : Application                          PolicyDB Name : SCENARIO  
Entry Name : CICS1                               Enterprise Name : TEST  
  
Subsystem : CICS1  
Message ID : LISTSHUT  
  
To change keyword-data pair, specify the following:  
  
Keyword  
Data  
EXCLUDE _____  
PAYR _____  
_____  
  
EXCLUDE _____  
BAT1 _____  
_____  
  
F1=HELP    F2=SPLIT    F3=END      F4=RETURN   F5=RFIND    F6=RCHANGE  
F7=UP      F8=DOWN     F9=SWAP    F10=LEFT   F11=RIGHT   F12=RETRIEVE
```

This example specifies that the PAYR and BAT1 transactions are specifically not purged during a shutdown of CICS1.

RCVRAUTO—Autoinstall Time Limit

Use this entry to send notifications to the operator if a CICS autoinstall takes longer than the specified time.

Format

```
RCVRAUTO TIMELIMIT=hh:mm:ss
```

Keyword and Parameter Definitions

TIMELIMIT

Use this attribute to determine if and when the Status Display Facility is updated with the error condition. The counter starts when the failure event occurs and stops at the completion of a successful install. If the install completes within the time specified, the Status Display Facility is not updated. If the install does not complete within the time specified, the Status Display Facility is updated.

Comments and Usage Notes

1. The **Critical** value of the AUTO thresholds of the subsystem is used to determine how often the update of the Status Display Facility is allowed to occur within a specific time frame. The AUTO thresholds must be defined in the customization dialogs under the CICS-specific RESOURCE THRESHOLDS policy item.
2. The RCVRAUTO entry is used by the EVEES302 action routine that is provided by CICS Automation. This routine is called from the sample AUTO state/action table. On state/action tables, see “How to Set Up the State/Action Tables” on page 32 and “State/Action Tables” on page 11.

Examples of Usage

```

COMMANDS  HELP
-----
User Defined Data          Row 1 to 2 of 20
Command ==>                SCROLL==> PAGE

Entry Type : Application    PolicyDB Name  : SCENARIO
Entry Name  : CICS1         Enterprise Name: TEST

Subsystem   : CICS1
Message ID  : RCVRAUTO

To change keyword-data pair, specify the following:

Keyword
Data
TIMELIMIT _____
00:05:00 _____
_____
_____

F1=HELP   F2=SPLIT  F3=END    F4=RETURN  F5=RFIND  F6=RCHANGE
F7=UP     F8=DOWN   F9=SWAP   F10=LEFT  F11=RIGHT F12=RETRIEVE

```

The Status Display Facility is updated if an autoinstall stays suspended for longer than 5 minutes.

RCVRSOS—Short-On-Storage Handling

RCVRSOS—Short-On-Storage Handling

Use this entry to notify the operator and optionally issue a command when a short-on-storage condition exceeds the specified time limit.

Format

```
RCVRSOS TIMELIMIT=mm:ss
        [CMD=(,cmd)]
        .
        .
        [CMD=(,cmd)]
```

Keyword and Parameter Definitions

TIMELIMIT

Specifies the time limit that a short-on-storage condition can exist before the commands specified by the CMD attribute are executed.

CMD

The command or commands to be issued when the short-on-storage condition exceeds the time limit specified with the TIMELIMIT attribute.

Comments and Usage Notes

1. There is a sample command list, EVEERDMP, that can be specified for the CMD attribute when a dump is to be produced.
2. The **Critical** value of the SOS thresholds of the subsystem is used to determine how often the specified commands are allowed to be issued within a specific time frame. The SOS thresholds must be defined in the customization dialogs under the CICS-specific RESOURCE THRESHOLDS policy item.
3. The RCVRSOS entry is used by the EVEES104 action routine that is shipped with CICS Automation. This routine is called from the sample SOS state/action table. On state/action tables, see “How to Set Up the State/Action Tables” on page 32 and “State/Action Tables” on page 11.

Examples of Usage

The following panel shows how the TIMELIMIT attribute can be specified:

```
COMMANDS  HELP
-----
Command ==>>>                                User Defined Data                Row 1 to 2 of 20
                                                SCROLL==>> PAGE

Entry Type : Application                    PolicyDB Name   : SCENARIO
Entry Name  : CICS1                         Enterprise Name : TEST

Subsystem   : CICS1
Message ID  : RCVRSOS

To change keyword-data pair, specify the following:

Keyword
Data
TIMELIMIT _____
00:30 _____

-----
F1=HELP    F2=SPLIT   F3=END     F4=RETURN   F5=RFIND   F6=RCHANGE
F7=UP      F8=DOWN     F9=SWAP    F10=LEFT    F11=RIGHT  F12=RETRIEVE
```

RCVRSOS—Short-On-Storage Handling

The following panel shows how the CMD attribute can be specified:

```
COMMANDS  HELP
-----
Command ==>          CMD Processing          Row 1 to 2 of 20
                               SCROLL==> PAGE

Entry Type : Application      PolicyDB Name  : SCENARIO
Entry Name  : CICS1           Enterprise Name : TEST

Subsystem   : CICS1
Message ID  : RCVRSOS

Enter commands to be executed when resource issues the selected message.

Pass/Selection Automated Function/'*'
Command Text
-----
EVEERDMP CICS1 _____
_____
_____

F1=HELP    F2=SPLIT   F3=END     F4=RETURN  F5=RFIND   F6=RCHANGE
F7=UP      F8=DOWN     F9=SWAP    F10=LEFT   F11=RIGHT  F12=RETRIEVE
```

The example specifies that the operator is notified and a dump produced if CICS is short on storage for more than 30 seconds.

RCVRTRAN—Transaction Recovery

RCVRTRAN—Transaction Recovery

Use this entry to define actions to be taken when transaction abends occur.

Format

```
RCVRTRAN[.tran]
      CMD=(,cmd)
      [CMD=(,cmd)]
      .
      .
      .
      [CMD=(,cmd)]
```

Keyword and Parameter Definitions

tran

A specific transaction. If this is not used, then the commands apply to all transactions.

CMD

The command or commands to be issued when the transaction abends.

Comments and Usage Notes

1. The **Critical** value of the TRAN, respectively TRAN.*tranid*, thresholds for the subsystem, is used to indicate how many abends can occur before automation is stopped. The thresholds must be defined in the customization dialogs under the CICS-specific RESOURCE THRESHOLDS policy item.
2. The SA OS/390 variable EHKVAR1 is set with the name of the transaction. This allows you to tailor your commands using the transaction name, such as disabling the transaction.
3. The RCVRTRAN entry is used by the EVEERTRN routine shipped with CICS Automation. EVEERTRN is typically called from the MAT.

Examples of Usage

```
COMMANDS  HELP
-----
                                CMD Processing                Row 1 to 2 of 20
Command ==>                                SCROLL==> PAGE

Entry Type : Application           PolicyDB Name  : SCENARIO
Entry Name  : CICS1                Enterprise Name : TEST

Subsystem   : CICS1
Message ID  : RCVRTRAN

Enter commands to be executed when resource issues the selected message.

Pass/Selection Automated Function/'*'
Command Text

MSG OP1,TRAN &EHKVAR1 FAILED_____
_____
_____

F1=HELP    F2=SPLIT   F3=END      F4=RETURN   F5=RFIND    F6=RCHANGE
F7=UP      F8=DOWN    F9=SWAP    F10=LEFT   F11=RIGHT   F12=RETRIEVE
```

This entry states that the command shown is to be executed for all transactions that do not have specific entries for them. It is the default command.

RCVRVIOL—Storage Violation Handling

Use this entry to set a trace as a result of recursive storage violations or to execute other commands.

Format

```
RCVRVIOL CMD=([ON|OFF]),,cmd
           [CMD=([ON|OFF]),,cmd)]
           .
           .
           [CMD=([ON|OFF]),,cmd)]
```

Keyword and Parameter Definitions

CMD

The command or commands to be issued in the event of recursive storage violations. ON or OFF is used to set and unset a trace. Refer to the example.

Comments and Usage Notes

1. The **Critical** value of the VIOL threshold for the subsystem is used to determine how often the specified commands are allowed to be issued within a specific time frame. The VIOL threshold must be defined in the customization dialogs under the CICS specific RESOURCE THRESHOLDS policy item.
2. The RCVRVIOL entry is used by the EVEES202 and EVEES203 action routines that are shipped with CICS Automation. These routines are called from the sample VIOL state/action table. On state/action tables, see “How to Set Up the State/Action Tables” on page 32 and “State/Action Tables” on page 11.

Examples of Usage

```
COMMANDS  HELP
-----
                                CMD Processing                Row 1 to 2 of 20
Command ===>                                SCROLL===> PAGE

Entry Type : Application           PolicyDB Name  : SCENARIO
Entry Name  : CICS1                Enterprise Name: TEST

Subsystem   : CICS1
Message ID  : RCVRVIOL

Enter commands to be executed when resource issues the selected message.

Pass/Selection Automated Function/'*'
Command Text
ON _____
MVS F CICS1 CSFE DEBUG,FAQE=ON_____

OFF _____
MVS F CICS1 CSFE DEBUG,FAQE=OFF_____

F1=HELP    F2=SPLIT    F3=END      F4=RETURN   F5=RFIND   F6=RCHANGE
F7=UP      F8=DOWN      F9=SWAP     F10=LEFT    F11=RIGHT  F12=RETRIEVE
```

When the entry is coded this way, a trace is set on the first occurrence, then set off at the second occurrence. The third occurrence sets the trace back on and the fourth sets it off. This scenario continues until the **Critical** value of the VIOL threshold is exceeded.

CICSINFO - Display Information

These commands are issued when the INGCICS REQ=INFO command is used to display the state of the selected CICS region. The commands are issued via the MODIFY subsystem ID on an MVS EMCS console and the resulting messages are either displayed on the INGCICS panel or written to the users NetView console.

For further information about the INFO request, see the description of the INGCICS command in *System Automation for OS/390 Operator's Commands*.

Format

```
CICSINFO , CICS_CMD = (description, CICS command)
```

Keyword and Parameter Definitions

description

The description is text that will be placed before the output of the CICS command. This can be used to identify the command output in the output stream. The description can be any string, but must be enclosed in quotes.

CICS command

The CICS command is the command to be executed. This command will be appended to a MODIFY subsystem and issued as an MVS command to an EMCS console. The output will be collected and displayed. The command can be any valid CICS transaction that will write to an MVS console. The command must be enclosed in quotes.

Comments and Usage Notes

This policy is required for correct operation of the INGCICS command and also PF10 of the DISPINFO panel.

Examples of Usage

```

COMMANDS  HELP
-----
Command ==>                                User Defined Data                Row 1 to 7 of 20
                                           SCROLL==> PAGE

Entry Type : Application                    PolicyDB Name   : SA22_KEYPLEX
Entry Name  : EYUMAS1A                      Enterprise Name : KEY1FAMILY

Subsystem   : EYUMAS1A
Message ID  : CICSINFO

To change keyword-data pair, specify the following:

Keyword
Data
CICS_CMD
('DISPLAY ACTIVE TASKS','CEMT I TA')

CICS_CMD
('DISPLAY SYSTEM INFORMATION', 'CEMT I SYS'

F1=HELP    F2=SPLIT    F3=END     F4=RETURN   F5=RFIND   F6=RCHANGE
F7=UP      F8=DOWN     F9=SWAP    F10=LEFT    F11=RIGHT  F12=RETRIEVE

```

Chapter 6. CICS Automation Routines, Commands, and Definition Members

This section is intended to help system and application programmers write programs that use the CICS Automation function. The following are described:

Subroutines

These subroutines provide generic functions for expanding automation capabilities beyond those supplied and supported by CICS Automation. They are typically invoked from other programs.

Commands and common routines

These commands and common routines can be called from the control file or the message table to invoke CICS Automation routines.

Definition members

These are modified during customization to provide additional function.

For general information on the format descriptions of the commands, see "Notation for Format Descriptions" on page xi.

Subroutines

The CICS Automation subroutines are:

“CICSQRY—Name Lookup” on page 63

Retrieves CICS subsystem information.

“CICSRCMD—Request a CICS Function” on page 66

Provides the ability to perform commands on any CICS region, local or remote.

CICSQRY—Name Lookup

Use this routine to retrieve CICS subsystem information.

Note that CICSQRY does not recognize subsystems that are in FALLBACK or MOVED status.

Syntax

```
CICSQRY {REQ=VALIDATE,
        NAME={subsystem|resource_name|jobname},
        [TYPE={CICS|GROUP|DOMAIN|ANY|JOBNAME}] |
        REQ=GET,
        NAME={subsystem|resource_name|jobname}}
```

Keyword and Parameter Definitions

REQ=

The request type. The request types are:

VALIDATE

A search is made for the name (NAME=) and type (TYPE=) specified so that the name can be validated.

GET

CICS Automation searches for a specific CICS subsystem to retrieve the subsystem characteristics.

NAME= *subsystem* | *resource_name* | *jobname*

Used with VALIDATE to provide a specific group, domain, or jobname. Used with GET to provide a specific subsystem value. Valid values for the NAME= variable are:

subsystem

The name by which a CICS subsystem is known to SA OS/390.

resource_name

The resource name in the *name/APL/system* format; thus, for example, APG is not accepted as the resource type.

jobname

The jobname by which a CICS subsystem is known to SA OS/390.

TYPE=

Used to provide a specific type. The types are:

CICS (default)

Search for a specific CICS subsystem name, as it is known to SA OS/390.

ANY

Search for a CICS name first, then a domain, then a group name. If the name is longer than 5 characters the search for a domain is bypassed.

DOMAIN

The NetView domain name coded in DSIDMKN with the NCCFID parameter.

GROUP

If you specify GROUP, CICSQRY returns the name of the group to which the subsystem belongs in the EVELOOKUP_GROUP variable.

JOBNAME

Used with GET to provide a specific jobname. Works only when NAME=jobname.

CICSQRY—Name lookup

Comments and Usage Notes

1. The return codes are:

Table 5. CICSQRY Return Codes

RC	Meaning
0	Good.
4	An internal error occurred.
8	A timeout occurred on a request forwarded to a remote system.
12	An internal error occurred.
20	A subsystem, group, or domain was not found for the search criteria specified.
24	The parameters for this request are invalid.
28	An internal error occurred.

2. The following are set in the caller's variable pool:

EVELOOKUP_NAME

Unless TYPE=JOBNAME, set to the value of the NAME= parameter. If TYPE=JOBNAME, set EVELOOKUP_NAME to the subsystem name. Otherwise, set to null.

EVELOOKUP_TYPE

Set to the value of the TYPE= parameter, unless TYPE=ANY or JOBNAME, in which case it is set to CICS or DOMAIN or GROUP as appropriate.

EVELOOKUP_JOBNAME

The jobname associated with the subsystem.

EVELOOKUP_DOMAIN

The NetView domain on which SA OS/390, managing this subsystem, is running.

EVELOOKUP_AUTOOPS

The NetView automated operator that handles automation for this subsystem.

EVELOOKUP_USERVAR

The VTAM USERVAR (or generic application ID) associated with this subsystem. This is set to '*****' if a VTAM USERVAR is not defined.

EVELOOKUP_APPLID

The specific VTAM application ID associated with this subsystem.

EVELOOKUP_RESHOME

The location of the resource in the following format:

sysplex.domain.system\VxRyMz

EVELOOKUP_RESLIST

The resource name in the following format

name/type/system

EVELOOKUP_AGENTDATA

Information about the agent responsible for the subsystem in the following format

agent_name sysplex_name system domain agent_version [netview_version]

EVELOOKUP_GROUP

The name of the group(s) to which the resource belongs.

CICSRCMD—Request a CICS Function

CICSRCMD—Request a CICS Function

This common routine is used to perform the requested function (CMD=) on the domain where the named CICS subsystem resides, whether local or remote. The calling program does not have to be aware of where the CICS subsystem resides. It is particularly useful with single point of control as CICSRCMD first determines the domain in which the subsystem resides before building and issuing the request. It then either calls the requested function if the subsystem is on the local domain, or it forwards the command to the remote domain, thus allowing cross-domain communications.

Syntax

```
CICSRCMD NAME=name, [RESP=YES|ACK,] [OPER=operator,] CMD=cmd
```

Keyword and Parameter Definitions

NAME=

The name by which the target CICS subsystem is known to SA OS/390.

RESP=

Send back a response (YES) or just send an acknowledgment (ACK).

OPER=

The operator, on the target domain, that will execute this command. If this is omitted, BASEOPER is used.

CMD=

The requested function to be performed. This may be delimited by single quotes, double quotes, or slashes.

Comments and Usage Notes

Table 6. CICSRCMD Return Codes

RC	Meaning
0	Good.
4	Subsystem name was not supplied.
8	Function to be performed was not supplied.
12	Incorrect keyword supplied.
20	Subsystem was not found on any domain.

Commands and Common Routines

The CICS Automation subroutines are:

“CEMTPPI—CEMT PPI Short Syntax” on page 69

Allows you to code a CEMT command:

1. In your own automation routines.
2. In the MAT.
3. In the **CMD Processing** panel of the customization dialogs (for example SHUTDOWN or MESSAGES policy items).

“CICSDLY—Change the Shutdown Delay Time” on page 70

This routine is used to change the default shutdown delay time specified in the **Shut Delay** field of the AUTOMATION INFO item of the APPLICATION policy. The shutdown delay time is used during a shutdown process where user-defined shutdown commands are used and multiple passes are specified.

“CICSPPOST—Post An External Event” on page 71

Use this routine to set trigger conditions in the status file.

“CICSPURG—Purge Transactions” on page 72

If you are using the MESSAGES/USER DATA keyword described in “LISTSHUT—Transaction Purging During Shutdown” on page 54, then you need to code this command so that CICS Automation checks for transactions that should or should not be purged during a shutdown.

“CICSRSYC—CICS Resync” on page 73

The purpose of this routine is to resynchronize CICS information with what is currently operational in the system (such as the VTAM ACB status). When NetView is initialized, the routine updates the status file.

“CICSSHUT—Shutdown Processor” on page 74

This is an extended command list that determines whether or not this CICS subsystem is running with XRF so that the extensions can be called with the shutdown invocation.

“EVEED003—Critical Message Handler for the Status Display Facility” on page 76

This routine is used to identify those messages that are to be displayed on the Status Display Facility critical messages panels.

“EVEERDMP—CICS Dump” on page 77

Creates dumps for specific CICS problems. Dumps the associated MVS region using the MVS DUMP command. It can be used for situations such as short-on-storage conditions when you want an MVS dump instead of a CICS internal dump.

“EVEEMIGR—Migrate Subsystem to CICS/TS” on page 78

Use this routine to migrate a subsystem from versions of CICS prior to CICS/TS.

“EVEEY00S—Common State Handler for State/Action Tables” on page 79

This routine is used to drive actions defined in the state/action tables.

“CICSHLTH—Linemode Health Checking” on page 80

This command allows you to perform linemode health checking.

“CICSOVRD—Linemode SIT Override” on page 82

This command allows you to perform linemode SIT overrides.

“CICSLM—Linemode Link Monitor” on page 84

This command allows you to perform linemode link monitoring.

“CICSMHDR—Linemode Message Options” on page 87

This command allows you to set message header options.

“CMASSHUT—CICSplex SM Address Space (CMAS) Shutdown” on page 89

This routine invokes CICSplex SM (CPSM) Application Programming Interface calls to shut the selected CMAS down.

CEMTPPI—CEMT PPI Short Syntax

CEMTPPI allows you to code a CEMT command:

1. In your own automation routines.
2. In the MAT.
3. In the **CMD Processing** panel of the customization dialogs (for example, SHUTDOWN or MESSAGES policy items).

It accepts CEMT input as data, sends it across the program-to-program interface, and sends a response back to the originating task.

Syntax

```
CEMTPPI subsys cemt-command-stream
```

Keyword and Parameter Definitions

subsys

The symbolic name by which this CICS subsystem is known to SA OS/390.

cemt-command-stream

The CEMT command stream, such as SET TASK DISABLE. Do not prefix the command with CEMT.

Comments and Usage Notes

1. This command can route across domains.
2. The CEMT PERFORM SHUTDOWN option is not allowed across the program-to-program interface. Therefore, it cannot be issued with CEMTPPI.

CICSDLY—Change the Shutdown Delay Time

CICSDLY—Change the Shutdown Delay Time

This routine is used to change the default shutdown delay time specified in the **Shut Delay** field of the AUTOMATION INFO item of the APPLICATION policy object. The shutdown delay time is used during a shutdown process where user-defined shutdown commands are used and multiple passes are specified. It indicates how long to wait for the shutdown before executing the next command in the sequence. Multiple passes are only used when the shutdown does not occur within the specified time frame.

Syntax

```
CICSDLY hh:mm:ss
```

Keyword and Parameter Definitions

hh:mm:ss

How long to wait for the previous command request to complete before executing the command specified in the next pass.

Comments and Usage Notes

If a delay time is not specified on a particular pass, the time defaults back to the entry in the policy database. This common routine needs to be used on each pass that you want the default delay time changed.

Examples of Usage

```
COMMANDS  HELP
-----
Command ==>>          CMD Processing          Row 1 to 2 of 20
                               SCROLL==>> PAGE

Entry Type : Application      PolicyDB Name  : SCENARIO
Entry Name  : CICS1           Enterprise Name : TEST

Subsystem   : CICS1
Message ID  : SHUTFORCE

Enter commands to be executed when resource issues the selected message.

Pass/Selection Automated Function/ '*'
Command Text
PASS1_____
CICSDLY 00:00:30_____

-----
F1=HELP    F2=SPLIT   F3=END     F4=RETURN  F5=RFIND   F6=RCHANGE
F7=UP      F8=DOWN     F9=SWAP    F10=LEFT   F11=RIGHT  F12=RETRIEVE
```

CICSPOST—Post An External Event

Use this routine to set trigger conditions. Internally, the INGEVENT command of SA OS/390 is called. Therefore, the TYPE parameter is ignored. For information on INGEVENT, see *System Automation for OS/390 Operator's Commands*.

Syntax

```
CICSPOST NAME=subsys,FUNCTION={SET|UNSET},EVENT=event
[,TYPE={STARTUP|SHUTDOWN}]
```

Keyword and Parameter Definitions

NAME=

Is used to define the symbolic name by which this CICS subsystem is known to SA OS/390.

FUNCTION=

Specified whether the trigger is to be SET or UNSET.

EVENT=

The name of the external condition that this trigger represents.

TYPE=

Specifies whether this is a STARTUP or SHUTDOWN trigger. This keyword is ignored by INGEVENT.

Comments and Usage Notes

As CICSPOST calls INGEVENT internally, the TYPE parameter is ignored.

CICSPURG—Purge Transactions

CICSPURG—Purge Transactions

If you are using the LISTSHUT keyword under the MESSAGES policy item (see “LISTSHUT—Transaction Purging During Shutdown” on page 54), then you need to code this command in the SHUTDOWN policy so that CICS Automation checks for transactions that should, or should not, be purged during a shutdown.

Syntax

```
CICSPURG [subsys]
```

Keyword and Parameter Definitions

subsys

The symbolic name by which this CICS subsystem is known to SA OS/390.

Comments and Usage Notes

If a subsystem name is not specified, the TGLOBAL SUBSAPPL, which is set by AOCQRY, is used.

Examples of Usage

```
COMMANDS  HELP
-----
Shutdown Command Processing          Row 1 to 2 of 20
Command ==>                          SCROLL==> PAGE

Entry Type : Application              PolicyDB Name : SCENARIO
Entry Name : CICS1                    Enterprise Name : TEST

Subsystem      : CICS1
Shutdown Phase: NORM

Enter commands to be executed when the selected shutdown phase is invoked
for this subsystem.

Pass/Selection Automated Function/'*'
Command Text
PASS1_____
CICSSHUT NORMAL_____

PASS2_____
CICSPURG_____

F1=HELP   F2=SPLIT   F3=END   F4=RETURN   F5=RFIND   F6=RCHANGE
F7=UP     F8=DOWN    F9=SWAP  F10=LEFT   F11=RIGHT  F12=RETRIEVE
```

In this example, CICSPURG is used on the second attempt to shutdown this subsystem.

CICSRSYC—CICS Resync

The purpose of this routine is to resynchronize CICS information with what is currently operational in the system (such as the VTAM ACB status). If a CICS subsystem should be active, and health checking and link monitoring are defined for this subsystem, CICSRSYC will activate these monitoring functions. When you define the ACORESTART keyword under the MESSAGES policy item for a CICS application, you must specify CICSRSYC as the command. For ACORESTART, see *System Automation for OS/390 Defining Automation Policy*.

The format is:

<p>Syntax</p> <p>CICSRSYC <i>subsys</i></p>

Keyword and Parameter Definitions

subsys

The symbolic name by which this CICS subsystem is known to SA OS/390.

Comments and Usage Notes

If *subsys* is not specified, CICSRSYC will access task global SUBSAPPL, which will probably not contain the correct value. The resync process may therefore be attempted on the wrong subsystem.

Examples of Usage

```

COMMANDS  HELP
-----
Command ===>                                CMD Processing                                Row 1 to 2 of 20
                                                SCROLL===> PAGE

Entry Type : Application                      PolicyDB Name  : SCENARIO
Entry Name  : CICS1                           Enterprise Name : TEST

Subsystem  : CICS1
Message ID : ACORESTART

Enter commands to be executed when resource issues the selected message.

Pass/Selection Automated Function/ '*'
Command Text
CICSRSYC CICS1 _____
_____
_____

F1=HELP    F2=SPLIT   F3=END     F4=RETURN   F5=RFIND   F6=RCHANGE
F7=UP      F8=DOWN     F9=SWAP    F10=LEFT    F11=RIGHT  F12=RETRIEVE

```

In this example, the command is used with the ACORESTART keyword to determine whether or not CICS1 should be active.

CICSSHUT—Shutdown Processor

CICSSHUT—Shutdown Processor

This is an extended command list that determines whether or not this CICS subsystem is running with XRF, so that the proper shutdown command can be called for the shutdown invocation.

Syntax

```
CICSSHUT {NORMAL|IMMED|TAKEOVER|DUMP} [cicsname] [SDTRAN=tranid|NONE]
```

Keyword and Parameter Definitions

cicsname

The job name or subsystem name of the CICS. *cicsname* is an optional parameter.

SDTRAN=*tranid* | NONE

tranid is the name of a CICS transaction that is to run at shutdown. The specified transaction overrides the SIT SDTRAN= specification, or the default CICS-supplied shutdown assist transaction CESD. If 'NONE' is specified, it will be translated into 'NOSDTRAN', meaning that no shutdown assist transaction is to run at shutdown.

The SDTRAN= parameter is optional and valid only for CICS TS for OS/390 V1R1 and higher versions. It is ignored for lower releases of CICS.

This routine invokes CICS transactions and the parameters perform the shutdown as described in the CICS operator manuals. If you are running in XRF and the backup system is active, CEBT is used to perform the shutdown. Otherwise, CEMT is used.

Comments and Usage Notes

1. The CEMT PERFORM SHUTDOWN types are passed as parameters to this command.
2. CICSSHUT is recommended for all shutdown policies for subsystems automated by CICS Automation.
3. These commands are issued across the console. You may have to sign the console on first before issuing the command.

Examples of Usage

```

COMMANDS  HELP
-----
Shutdown Command Processing          Row 1 to 2 of 20
Command ==>                          SCROLL==> PAGE

Entry Type : Application              PolicyDB Name  : SCENARIO
Entry Name : CICS1                   Enterprise Name : TEST

Subsystem   : CICS1
Shutdown Phase: NORM

Enter commands to be executed when the selected shutdown phase is invoked
for this subsystem.

Pass/Selection Automated Function/'*'
Command Text
PASS1_____
CICSSHUT NORMAL_____

PASS2_____
CICSPURG_____

F1=HELP   F2=SPLIT  F3=END   F4=RETURN  F5=RFIND  F6=RCHANGE
F7=UP     F8=DOWN   F9=SWAP  F10=LEFT  F11=RIGHT F12=RETRIEVE
    
```

EVEED003—Critical Message Handler for the Status Display Facility

EVEED003—Critical Message Handler for the Status Display Facility

This routine is used to list messages in the critical message Status Display Facility panel.

Syntax

```
EVEED003 msgtext
```

Keyword and Parameter Definitions

msgtext

The message text and message identifier passed to the critical message panel.

Comments and Usage Notes

This must be called from the MAT because it uses the job name associated with the message.

Examples of Usage

Example 1

```
* CICS STARTUP NUCLEUS MODULE NOT FOUND - NEEDS REPLY
IF MSGID='DFH1596' & TEXT = MESSAGE
  & HDRMTYPE = '>'
  THEN EXEC(CMD('EVEED003 'MESSAGE) ROUTE(ALL *))
      EXEC(CMD('ISSUEREP AUTOTYP=START') ROUTE(ALL *))
      DISPLAY(N) BEEP(N) HOLD(N) NETLOG(Y) SYSLOG(Y);
```

Example 2

```
IF MSGID='DFH0964' & TEXT = MESSAGE
  THEN EXEC(CMD('EVEED003 'MESSAGE) ROUTE(ALL *))
      DISPLAY(N) BEEP(N) HOLD(N) NETLOG(Y) SYSLOG(Y);
```

EVEERDMP—CICS Dump

EVEERDMP will create a dump for specific CICS problems. It dumps the associated MVS region using the MVS DUMP command. It can be used for situations such as short on storage conditions if you want an MVS dump instead of a CICS internal dump.

Syntax

```
EVEERDMP {jobname|subsys}
```

Keyword and Parameter Definitions

jobname

The jobname for this CICS.

subsys

The symbolic name by which this CICS subsystem is known to SA OS/390.

Examples of Usage

```

COMMANDS  HELP
-----
                                CMD Processing           Row 1 to 2 of 20
Command ===>                                SCROLL===> PAGE

Entry Type : Application           PolicyDB Name   : SCENARIO
Entry Name  : CICS1                Enterprise Name : TEST

Subsystem   : CICS1
Message ID  : RCVRSOS

Enter commands to be executed when resource issues the selected message.

Pass/Selection Automated Function/'*'
Command Text

EVEERDMP CICS1 _____
_____
_____

F1=HELP   F2=SPLIT  F3=END    F4=RETURN  F5=RFIND   F6=RCHANGE
F7=UP     F8=DOWN    F9=SWAP   F10=LEFT  F11=RIGHT  F12=RETRIEVE

```

EVEEMIGR—Migrate Subsystem to CICS/TS

EVEEMIGR—Migrate Subsystem to CICS/TS

Use this routine to migrate a subsystem from versions of CICS prior to CICS/TS.

Syntax

```
EVEEMIGR NAME=subsys,NEWVERSION=version
```

Keyword and Parameter Definitions

NAME=

The name by which the CICS subsystem is known to SA OS/390.

NEWVERSION=

Is used to define the new version of CICS/TS that you want to migrate to.

Valid versions are:

- V1R1
- V1R2
- V1R3
- V2R1
- V2R2

Comments and Usage Notes

1. The return codes are:

Table 7. EVEEMIGR Return Codes

RC	Meaning
0	Function performed (normal exit)
1	Invalid keyword entered
2	Invalid CICS system NAME entered
3	Invalid NEWVERSION entered
4	The specified CICS system name does not exist
> 4	An unexpected error occurred and processing has not completed.

2. This command applies when migrating to CICS/TS V1R1, V1R2, V1R3, V2R1, and V2R2.
3. The version entries in both the status file and the currently active Cglobal for the selected system will be modified.

Examples of Usage

Example

The following command must be issued after migrating CICS/TS from Version 4 to CICS/TS V1R1.

```
EVEEMIGR NAME=CICSA,NEWVERSION=V1R1
```

EVEEY00S—Common State Handler for State/Action Tables

This routine is used to drive actions defined in the state/action tables. It is typically invoked from the MAT (see the examples).

Syntax

```
EVEEY00S [MSGID=msgid]
          [,JOB=jobname]
          [,MSGSTR=msgstring]
```

Keyword and Parameter Definitions**MSGID=**

The message passed to the state/action table as an event.

JOB=

The jobname associated with the event.

MSGSTR=

The message string associated with the message. MSGSTR= cannot be coded unless MSGID= is coded.

Comments and Usage Notes

1. If MSGID= is not specified, the message that invoked the routine is used as the event.
2. If JOB= is not specified, the jobname associated with the message is used.
3. If the routine is **not** invoked from the automation table, MSGID= and JOB= **must** be coded.
4. Refer to “How to Set Up the State/Action Tables” on page 32.

Examples of Usage**Example 1**

```
* VTAMACB STATE ACTION - VTAM DISCOVERED DOWN BY CICS
IF (MSGID = 'DFH3463I'
   | MSGID = 'DFH511572'
   | MSGID = 'DFH1572' )
& (TEXT = . 'X'52' . | TEXT= . 'X'5C' .
 | TEXT = . '=52.' . | TEXT= . '=5C.' .)
THEN EXEC(CMD('EVEEY00S MSGID=VTAMDN') ROUTE(ALL *));
```

Example 2

```
* VTAMACB STATE ACTION - ACB CLOSED BY CICS
IF MSGID = 'DFH2316I'
THEN EXEC(CMD('EVEEY00S MSGID=ACBCLS') ROUTE(ALL *));
```

CICSHLTH—Linemode Health Checking

CICSHLTH—Linemode Health Checking

CICSHLTH allows an operator or user-written routine to control health checking without using the CICS Automation operator interface.

Syntax

```
CICSHLTH NAME=subsys, {ACTION=START, PROGRAM=programe |  
ACTION=STATUS, PROGRAM=programe |  
ACTION=RESUME, PROGRAM=programe |  
ACTION=SUSPEND, PROGRAM=programe |  
ACTION=STOP, PROGRAM=programe |  
ACTION=CHECK, PROGRAM=programe}
```

Keyword and Parameter Definitions

subsys

The name of the CICS subsystem.

programe

The name of the user-written health check program.

ACTION=START

Used to initiate health check processing.

ACTION=STATUS

Used to determine if the health check program is active or inactive, and normal or abnormal regarding its most recent execution.

ACTION=RESUME

Used to continue a process that was temporarily suspended.

ACTION=SUSPEND

Used to temporarily stop a process.

ACTION=STOP

Used to stop health check processing.

ACTION=CHECK

Used to submit a status check regardless of the status and scheduled time interval of the health check program.

Comments and Usage Notes

Actions can only be performed using programs that are specified under the HEALTHCHK keyword in the MESSAGES/USER DATA item of the APPLICATION policy object for the subsystem.

Examples of Usage

Example 1 — Status on a Health Check Program

Command:

```
CICSHLTH NAME=CICS01A, ACTION=STATUS, PROGRAM=EVECHLTH
```

Message Response:

```
C AOF01 EVE441I HEALTH CHECK PROGRAM EVECHLTH STATUS INACTIVE  
C AOF01 EVE445I ABNORMAL RESPONSE ON 05/25/95 09:51:35 -
```

Example 2 - Start of a Health Check Program

Command

```
CICSHLTH NAME=CICS01A,ACTION=START,PROGRAM=EVECHLTH
```

Message Response:

```
C A0F01    EVE436I  CICS01A HEALTH START FOR EVECHLTH SUCCESSFUL.
```

CICSOVRD—Linemode SIT Override

CICSOVRD—Linemode SIT Override

CICSOVRD allows you to set CICS SIT override conditions prior to CICS startup. (Otherwise, CICS Automation only allows you to set override conditions through the INGREQ input panel; see Chapter 8, “Starting and Stopping Resources” on page 107.)

Syntax

```
CICSOVRD NAME=subsys,STARTTYPE=type,  
          ACTION=SET,OVERRIDE=delimdatadelim,  
          KEYPOINT=[REQuired|OPTional]  
  
          ACTION=STATUS
```

Keyword and Parameter Definitions

type

The type of startup.

subsys

The name of the CICS subsystem.

ACTION=SET

Used to change the SIT override for a CICS subsystem.

ACTION=STATUS

Used to inquire about the SIT options for a CICS subsystem.

delim

The character that is used to delimit the override data. The first character after the '=' sign is taken to be this delimiter.

data

The override data to be used to override the SIT options.

KEYPOINT=[REQuired|OPTional]

Used to specify if a warm keypoint is required for the CICS subsystem, before these overrides can be used.

Comments and Usage Notes

1. The CICSOVRD command does not start the named CICS. The overrides are saved and used for subsequent starts of the CICS. The SIT overrides can be displayed by using the **ACTION=STATUS** option.
2. This linemode command returns the following message to the invoking routine:

```
C AOF01   EVE556I  CICSOVRD Completed successfully
```

To clear an override, enter:

```
CICSOVRD NAME=subsys,ACTION=SET,OVERRIDE=%%
```

Examples of Usage

Example—Add an override for the PLTPI for CICS01A

Command:

```
CICSOVRD NAME=CICS01A,ACTION=SET,OVERRIDE=%PLTPI=02%
```

Message Response:

```
C AOF01   EVE556I  CICSOVRD Completed successfully
```

Example—Change the Keypoint option for CICS01A

Command:

```
CICSOVRD NAME=CICS01A,ACTION=SET,KEYPOINT=OPT
```

Message Response:

```
C AOF01 EVE556I CICSOVRD Completed successfully
```

CICSLM—Linemode Link Monitor

CICSLM provides a linemode interface for the link monitoring functions of CICS Automation.

Syntax

```
CICSLM NAME=subsys, {ACTION=STARTLMT |  
ACTION=STATUSLMT |  
ACTION=CONNINFO |  
ACTION=STOPLMT |  
ACTION=STATUS, CONNECTION=conname |  
ACTION=RECOVER, CONNECTION=conname |  
ACTION=SUSPEND, CONNECTION=conname  
[, FUNCTION={ECHO|MONITOR}]} |  
ACTION=RESUME, CONNECTION=conname  
[, FUNCTION={ECHO|MONITOR}]}
```

Keyword and Parameter Definitions

subsys

The name of the CICS subsystem.

ACTION=STARTLMT

Used to start link monitoring processing.

ACTION=STATUSLMT

Used to determine if link monitoring is started or stopped.

ACTION=CONNINFO

Used to acquire information on connection information.

ACTION=STOPLMT

Used to stop link monitoring processing.

ACTION=STATUS

Used to acquire status on a named connection.

ACTION=RECOVER

Used to start a series of repair actions for a named connection.

ACTION=SUSPEND

Used to temporarily stop link monitoring processing.

ACTION=RESUME

Used to restart link monitoring processing after it was suspended.

conname

This is the 4-character CICS name for a connection

FUNCTION=ECHO

Used to run the echoplexing transaction over the named connection.

FUNCTION=MONITOR

Used to run monitoring for the named connection.

Comments and Usage Notes

ACTION=STATUS, **RECOVER**, **SUSPEND**, and **RESUME** require the use of the **CONNECTION** keyword.

Examples of Usage

Example—Get connection information for CICS01A

Command:

```
CICSLM NAME=CICS01A,ACTION=CONNINFO
```

Message Response:

```
C AOF01 EVE793I AUTOMATION DISPLAY - CONNINFO
C AOF01 EVE794I CURRENT ITEM - CONNID=C10A
C AOF01 EVE795I DATA IS APPLID=CICS10AA
C AOF01 EVE795I DATA IS DESCRIPTION=FROM CICS01A TO
C AOF01 EVE795I DATA IS DESIRED=DOWN
C AOF01 EVE795I DATA IS ACTUAL=UNKNOWN
C AOF01 EVE795I DATA IS MONITOR=ON
C AOF01 EVE795I DATA IS LASTCHK=
C AOF01 EVE795I DATA IS ECHOPLEX=
C AOF01 EVE796I END OF CONNINFO DISPLAY
```

Example—Get status information for specific connection

Command:

```
CICSLM NAME=CICS01A,ACTION=STATUS,CONNECTION=C10A
```

Message Response:

```
C AOF01 EVE793I AUTOMATION DISPLAY - STATUS
C AOF01 EVE794I CURRENT ITEM - CONN=C10A
C AOF01 EVE795I DATA IS LOCAL=CICS01A
C AOF01 EVE795I DATA IS REMOTE=CICS10AA
C AOF01 EVE795I DATA IS DESCRIPTION=FROM CICS01A TO
C AOF01 EVE795I DATA IS CONNTYPE=LU62
C AOF01 EVE795I DATA IS CRITICAL=NO
C AOF01 EVE795I DATA IS TIMEZONE=00:00 EAST
C AOF01 EVE795I DATA IS MONSTATUS=ON
C AOF01 EVE795I DATA IS ECHOSTATUS=
C AOF01 EVE795I DATA IS LASTCHK=
C AOF01 EVE795I DATA IS RESPONSE=
C AOF01 EVE795I DATA IS DESTLINK=DOWN
C AOF01 EVE795I DATA IS ACTIVELINK=UNKNOWN
C AOF01 EVE795I DATA IS SERVICE=UNKNOWN
C AOF01 EVE795I DATA IS ACQUIRE=UNKNOWN
C AOF01 EVE795I DATA IS INTERVAL=27:00
C AOF01 EVE795I DATA IS REPAIR=3
C AOF01 EVE795I DATA IS RD=05
C AOF01 EVE795I DATA IS AD=05
C AOF01 EVE795I DATA IS ED=
C AOF01 EVE795I DATA IS SYSTEM=CICS
C AOF01 EVE795I DATA IS ECHOPROC=
C AOF01 EVE796I END OF STATUS DISPLAY
```

CICSLM—Linemode Link Monitor

Example—Resume monitoring for a specific connection

Command:

```
CICSLM NAME=CICS01A,ACTION=RESUME,CONNECTION=C10A,FUNCTION=MONITOR
```

Message Response:

```
C AOF01    EVE968I  LINK MONITORING REQUEST RESUME(MONITOR) FOR  
CONNECTION C10A WAS SUCCESSFUL
```

CICSMHDR—Linemode Message Options

CICSMHDR allows you to change the message header options which display on the operator panel.

Syntax

```
CICSMHDR NAME=[domain],ACTION=SET
                OPID=opname
                DOMAIN=[ON|OFF]
                OPERATOR=[ON|OFF|DEFAULT]

                ACTION=STATUS
                OPID=opname
```

Keyword and Parameter Definitions

[domain]

The name of the NetView domain.

ACTION=SET

Used to change the message options for a domain or operator.

ACTION=STATUS

Used to inquire about the message options for a domain or operator.

opname

The NetView operator ID.

DOMAIN=[ON|OFF]

For ACTION=SET, this keyword turns message ID on or off for the domain and/or operator. Both can be set in a single command.

OPERATOR=[ON|OFF|DEFAULT]

For ACTION=SET, this keyword turns message ID on or off for the operator specified on the OPID keyword. A value of default allows the message id options to be controlled by the domain setting.

Comments and Usage Notes

1. If the NAME keyword is not supplied, a default of the current domain is used.
2. For ACTION=SET, both the OPID and OPERATOR keywords must be used if either is specified.
For ACTION=STATUS, no additional keywords are required.
3. This linemode command returns the following message to the invoking routine:

```
C AOF01    EVE449I  CICSMHDR NAME=AOF01 DOMAIN=OFF OPID=  OPERATOR=
```

Examples of Usage

Example—Turn message ID on for an operator

Command:

```
CICSMHDR ACTION=SET,OPID=GULLA,OPERATOR=ON
```

Message Response:

```
C AOF01    EVE449I  CICSMHDR NAME=AOF01 DOMAIN=OFF OPID=GULLA
                OPERATOR=ON
```

CICSMHDR—Linemode Message Options

Example—Turn message id on for a domain

Command:

```
CICSMHDR ACTION=SET,DOMAIN=ON
```

Message Response:

```
C AOF01 EVE449I CICSMHDR NAME=AOF01 DOMAIN=ON OPID= OPERATOR=
```

Example—Reset message options for a domain and operator

Command:

```
CICSMHDR ACTION=SET,DOMAIN=OFF,OPID=GULLA,OPERATOR=DEFAULT
```

Message Response:

```
C AOF01 EVE449I CICSMHDR NAME=AOF01 DOMAIN=OFF OPID=GULLA  
OPERATOR=DEFAULT
```

CMASSHUT—CICSplex SM Address Space (CMAS) Shutdown

CMASSHUT—CICSplex SM Address Space (CMAS) Shutdown

This is a command list that determines whether or not this CICS subsystem is running a CICSplex SM Address Space (CMAS). It then uses the CPSM REXX API to shut down the CMAS.

Syntax

```
CMASSHUT [cmasname]
```

Keyword and Parameter Definitions

cmasname

The job name or subsystem name of the CICSplex SM Address Space (CMAS). *cmasname* is an optional parameter. If *cmasname* is not specified, the SUBSAPPL task global value is used.

This routine invokes the CICSplex SM (CPSM) Application Programming Interface calls to shut the selected CMAS down.

Comments and Usage Notes

CMASSHUT is intended as a shutdown command that is to be defined as a shutdown pass in the policy database. It is recommended that this be used to shutdown CICSplex SM Address Space (CMAS) subsystems.

Examples of Usage

```
COMMANDS  HELP
-----
Command ==>>          CMD Processing          Row 1 to 2 of 20
                               SCROLL==>> PAGE

Entry Type : Application      PolicyDB Name  : SCENARIO
Entry Name  : CMAS1           Enterprise Name : TEST

Subsystem   : CMAS1
Message ID  : SHUTNORM

Enter commands to be executed when resource issues the selected message.

Pass/Selection Automated Function/ '*'
Command Text
PASS1_____
CMASSHUT_____

PASS2_____
MVS C CMAS1_____

F1=HELP    F2=SPLIT    F3=END     F4=RETURN   F5=RFIND   F6=RCHANGE
F7=UP      F8=DOWN      F9=SWAP    F10=LEFT    F11=RIGHT  F12=RETRIEVE
```

A normal shutdown of the CMAS is being requested with the first pass.

INGCICS

INGCICS - Issue CICS Operator Commands

The INGCICS command lets you:

- Issue any console-enabled CICS transaction
- Broadcast messages to all or selected CICS users
- Issue a list of defined transactions and view the output
- Display the output of CICS transactions in full-screen or pipeable line mode

For a detailed description of the INGCICS command, refer to *System Automation for OS/390 Operator's Commands*.

Definition Members

The definition members are:

“EVESPINM—CICS PPI Initialization Member” on page 92.

This member is used on the CICS side of the program-to-program interface to:

1. Set the program-to-program interface buffer queue limit. This is the number of outstanding buffers that can be stored in the receiver buffer queue.
2. Define the program-to-program interface receiver identifier for the EVESNPPI NetView subtask program.
3. Provide the identifier of the console on which the long-running COPC transaction is started.
4. Define the relationships between function names and CICS transaction names.

“EVENTASK—NetView PPI Initialization Member” on page 94

This member is used on the NetView side of the program-to-program interface to:

1. Set the program-to-program interface buffer queue limit. This is the number of outstanding buffers that can be stored in the receiver buffer queue.
2. Define request programs and autotasks to be used for specific functions.
3. Define response programs and autotasks to be used for specific functions.
4. Define the program-to-program interface receiver identifier for the EVESNPPI NetView subtask program.

“EVESMT3—Message Exit Table for CICS” on page 96.

Identifies which transient data queue messages require automation for CICS Version 3 and higher.

EVESPINM—CICS PPI Initialization Member

EVESPINM—CICS PPI Initialization Member

This member is used on the CICS side of the program-to-program interface to:

1. Set the program-to-program interface buffer queue limit. This is the number of outstanding buffers that can be stored in the receiver buffer queue.
2. Define the program-to-program interface receiver identifier for the EVESNPPI NetView subtask program.
3. Provide the identifier of the console on which the long-running COPC transaction is started.
4. Define the relationships between function names and CICS transaction names.

Note: There is a corresponding initialization member on the NetView side. See “EVENTASK—NetView PPI Initialization Member” on page 94.

The following is an example of the information contained in the EVESPINM program-to-program interface initialization member:

```
EVEMPINM TYPE=INITIAL,    INITIAL ENTRY
      BUFFQL=4,          BUFFER QUEUE LIMIT
      RECEIVERID=NETVCPPI, NPDS RECEIVER IDENTIFICATION
      USERID=[YES|NO],   INVOKE TRANSACTION WITH REAL USERID
      CONSOLE=           TERMID OF CONSOLE FOR COPC

EVEMPINM TYPE=ENTRY,     DEFINE A FUNCTION
      FUNCTION=CEMT,     FUNCTION NAME
      TRANSID=COMT      TRANSACTION NAME

EVEMPINM TYPE=ENTRY,     DEFINE A FUNCTION
      FUNCTION=LMT,     FUNCTION NAME
      TRANSID=COLR      TRANSACTION NAME

EVEMPINM TYPE=ENTRY,     DEFINE A FUNCTION
      FUNCTION=HEALTH,  FUNCTION NAME
      TRANSID=COHR      TRANSACTION NAME

EVEMPINM TYPE=ENTRY,     DEFINE A FUNCTION
      FUNCTION=TEST,    FUNCTION NAME
      TRANSID=TSTL      TRANSACTION NAME

EVEMPINM TYPE=FINAL     REQUIRED END
```

Keyword and Parameter Definitions

TYPE=

Indicates the type of entry this is. Valid types are:

- INITIAL** The first EVEMPINM type specified. Only one INITIAL entry can be specified.
- ENTRY** This type associates a function with a CICS transaction.
- FINAL** Indicates that this is the final entry. Only one FINAL entry can be specified.

BUFFQL=

Specifies the buffer queue limit for the CICS receiver side of the program-to-program interface to NetView. A minimum value of 1 and a maximum value of 15 can be specified. If this keyword is omitted, a default value of 3 is assumed. This keyword is only valid with TYPE=INITIAL.

RECEIVERID=

Specifies the identifier of the NetView receiver. If this keyword is omitted, NETVCPPI is assumed. This keyword is only valid with TYPE=INITIAL.

EVEPINM—CICS PPI Initialization Member

USERID=[YES|NO]

Specifies that the transaction will be invoked with the NetView user ID that invoked the PPI process. The default is NO.

CONSOLE=

Specifies the 1- to 4-character terminal identifier of the console on which the long-running COPC transaction is started. If this specification is omitted, COPC is started without a terminal. This keyword is only valid with TYPE=INITIAL.

FUNCTION=

The name of the function to be executed. The function name can be from 1 to 8 characters and must not start with the characters EVE.

TRANSID=

The name of the CICS transaction associated with this function. This transaction will be executed when the function is requested.

Comments and Usage Notes

1. A function name may not start with EVE.
2. EVEPINM must be link-edited into one of the CICS DFHRPL libraries.
3. At least one valid TYPE=ENTRY must be specified.
4. There must be a TYPE=ENTRY definition for each function that uses the CICS Automation program-to-program interface. The corresponding NetView side initialization member entry looks like this:

```
SERVER=RESPONSE,CEMT,AUTCPPI,EVESNRSP
```

where CEMT is the function.

5. If you are running CICS Automation in more than one NetView domain on the same MVS system, then you need to provide unique RECEIVERIDs in this member. This must also be changed in the corresponding NetView program-to-program interface initialization member. See "EVENTASK—NetView PPI Initialization Member" on page 94, which explains where the matching RECEIVERID is changed for that member.

EVENTASK—NetView PPI initialization member

EVENTASK—NetView PPI Initialization Member

This member is used on the NetView side of the program-to-program interface to:

1. Set the program-to-program interface buffer queue limit. This is the number of outstanding buffers that can be stored in the receiver buffer queue.
2. Define request programs and autotasks to be used for specific functions.
3. Define response programs and autotasks to be used for specific functions.
4. Define the program-to-program interface receiver identifier for the EVESNPPI NetView subtask program.

Note: There is a corresponding initialization member on the CICS side. See “EVESPINM—CICS PPI Initialization Member” on page 92.

The following is an example of the information contained in the EVENTASK program-to-program interface initialization member:

Syntax

```
BUFFQL=20
SERVER=REQUEST,LMT,AUTCPPI,EVEEYPPS
SERVER=RESPONSE,CEMT,AUTCPPI,EVESNRSP
SERVER=RESPONSE,LMT,AUTCPPI,EVESNRSP
SERVER=REQUEST,NACK,AUTCPPI,EVESNACK
SERVER=RESPONSE,NACK,AUTCPPI,EVESNACK
RECEIVERID=NETVCPPI
```

Keyword and Parameter Definitions

BUFFQL

This is a 2- or 3-digit numeric value. The minimum value is 10 and the maximum is 999. If this entry is omitted, a value of 15 is assumed.

SERVER=

These entries define:

1. Whether this function is a REQUEST or a RESPONSE. A REQUEST is used to identify a receiver program to be invoked if NetView gets a CONVERSE or SEND from CICS. A RESPONSE is used to identify a sender program to be invoked if CICS sends a RESPONSE. See “EVESCCCI - CICS to NetView Communication Interface” on page 141.
2. The function, such as LMT (link monitor) or CEMT.
3. The operator ID under which the program runs, for example, AUTCPPI.
4. The command list or command processor used for this function, such as EVEEYPPS (the receiver program for LMT functions from CICS) and EVESNRSP (the common response handler).

RECEIVERID=

The program-to-program interface receiver identifier for the NetView side program-to-program interface subtask program. If omitted, NETVCPPI is assumed.

Comments and Usage Notes

1. A function name may not start with EVE.
2. At least one valid SERVER must be specified.
3. There must be a SERVER entry for each function that uses the CICS Automation program-to-program interface. The corresponding CICS side initialization member entry looks like this:

EVENTASK—NetView PPI initialization member

```
EVEMPINM TYPE=ENTRY,      DEFINE A FUNCTION  
      FUNCTION=LMT,        FUNCTION NAME  
      TRANSID=COLR         TRANSACTION NAME
```

4. If you are running CICS Automation in more than one NetView domain on the same MVS system, then you need to provide unique RECEIVERIDs in this member. This must also be changed in the corresponding CICS program-to-program interface initialization member EVESPINM. See “EVESPINM—CICS PPI Initialization Member” on page 92.

EVESCMT3—Message exit table for CICS

EVESCMT3—Message Exit Table for CICS

Message automation works with messages sent to an MVS console. Some CICS messages are not sent to an MVS console, but to transient data queues instead. The purpose of EVESCMT3 is to identify which of these messages require automation so that they can be sent to an MVS console for automation to take place.

A macro, EVEMXMET, is used to do this. To define the messages to be automated, edit EVESCMT3 and use the following EVEMXMET macro format:

Syntax

```
EVEMXMET TYPE=ENTRY  
        ,QUEUE=queue  
        ,MSGID=msgid
```

Keyword and Parameter Definitions

QUEUE=

The actual queue name to which this message is sent.

MSGID=

The message ID (without the A, I, or W suffix).

Comments and Usage Notes

1. The queue specifications for the EVEMXMET macros must contain the actual queue names.
2. EVESCMT3 must be link edited together with the appropriate EVESCMxx exit program in one of the CICS DFHRPL libraries. Refer to sample job EVESJ020 for details.
3. A sample EVESCMT3 member is provided. You will see in this member that EVEMXMET has several TYPEs:

```
EVEMXMET TYPE=INITIAL  
EVEMXMET TYPE=ENTRY  
EVEMXMET TYPE=FINAL  
EVEMXMET TYPE=DSECT
```

The only TYPE that you should work with is ENTRY. Do not disturb the other TYPEs.

Examples of Usage

Example 1

The following is used for VTAM ACB messages:

```
EVEMXMET TYPE=ENTRY,  
        QUEUE=CSNE,  
        MSGID=DFHZC3463
```

Example 2

The following is used for program and transaction abend messages:

```

EVMXMET TYPE=ENTRY,
        QUEUE=CSMT,
        MSGID=DFHAC2230

EVMXMET TYPE=ENTRY,
        QUEUE=CSMT,
        MSGID=DFHAC2236

EVMXMET TYPE=ENTRY,
        QUEUE=CSMT,
        MSGID=DFHAC2237

EVMXMET TYPE=ENTRY,
        QUEUE=CSMT,
        MSGID=DFHAC2238

EVMXMET TYPE=ENTRY,
        QUEUE=CSMT,
        MSGID=DFHAC2240

EVMXMET TYPE=ENTRY,
        QUEUE=CSMT,
        MSGID=DFHAC2241

EVMXMET TYPE=ENTRY,
        QUEUE=CSMT,
        MSGID=DFHAC2242

EVMXMET TYPE=ENTRY,
        QUEUE=CSMT,
        MSGID=DFHAC2243
    
```

Example 3

The following is used for autoinstall error messages:

```

EVMXMET TYPE=ENTRY,
        QUEUE=CSNE,
        MSGID=DFHZC3482

EVMXMET TYPE=ENTRY,
        QUEUE=CSNE,
        MSGID=DFHZC3483

EVMXMET TYPE=ENTRY,
        QUEUE=CADL,
        MSGID=DFHZC5966
    
```

EVESCMT4—Message exit table for CICS

EVESCMT4—XTDOOUT Exit Table for CICS

Message automation works with messages sent to an MVS console. Some CICS messages are not sent to an MVS console, but to transient data queues instead. CICS system messages sent to transient data queues are handled by message exit table EVESCMT3 as described in “EVESCMT3—Message Exit Table for CICS” on page 96. User-defined messages, sent to user defined transient data queues, are handled by the XTDOOUT message exit and message exit EVESCMT4. The purpose of EVESCMT4 is to identify which user-defined messages, directed to transient data queues should also be sent to an MVS console to allow for automation to take place.

The EVEMCMXT macro is used to define the message exit table and its contents. To define messages to be automated, edit EVESCMT4 and use the following EVEMCMXT macro format:

Note: Enabling the XTDOOUT exit by defining the EVESCMT4 exit table may impact the performance of some CICS systems.

Syntax

```
EVEMXMET TYPE=ENTRY
          ,QUEUE=queue
          ,STARTPOS=starting position for MTEXT
          ,MTEXT=text string
```

Keyword and Parameter Definitions

QUEUE=

The actual queue name to which the message is sent.

STARTPOS=

The starting position in the CICS message where the MTEXT is to be found. The default is 1.

MTEXT=

Any text string from 1 to 256 characters in length.

Comments and Usage Notes

1. This table and associated exit (XTDOOUT) can be used for CICS Version 3 and higher.
2. The table must be compiled and linked into one of the CICS DFHRPL libraries. Refer to sample job EVESJ020 for details.
3. A sample EVESCMT4 is provided. In this sample member EVEMXMET has several TYPEs:

```
EVEMCMXT TYPE=INITIAL
EVEMCMXT TYPE=ENTRY
EVEMCMXT TYPE=FINAL
EVEMCMXT TYPE=DSECT
```

The only TYPE that you should work with is ENTRY. Do not change the other TYPEs.

4. This table is optional. If it does not reside in any of the CICS DFHRPL libraries, or if is available but does not contain ENTRY types, then the XTDOOUT exit is not enabled during processing by EVESTIEX.

Examples of Usage

Example 1

```
EVECMXT TYPE=ENTRY,  
  QUEUE=ABCD,  
  MSGID=MSG1234I
```

Example 2

```
EVECMXT TYPE=ENTRY,  
  QUEUE=ABCD,  
  STARTPOS=10  
  MSGID='message text'  
EVECMXT TYPE=ENTRY,  
  QUEUE=USR1,  
  MSGID=DFHAC2236  
  STARTPOS=1  
  MSGID=PAY0001I
```

EVESCMT4—Message exit table for CICS

Part 3. Using CICS Automation

This part describes the tasks of the operator who manages CICS subsystems through CICS Automation.

Chapter 7. Using Panels and Working with Subsystems

This chapter explains how to use the CICS Automation panels and how to work with subsystems. It assumes that you are familiar with the SA OS/390 operator interface. This chapter describes the characteristics of CICS Automation. To thoroughly understand your role as the CICS Automation operator, some hands-on experience with SA OS/390 is useful.

Using CICS Automation Panels

This section explains how to work with the CICS Automation main panel. To start a CICS Automation operator session and display the CICS Automation Main Menu, enter CICS on a NetView command line.

Using the Main Menu

The main menu lists all tasks available with the operator interface.

```
EVEK0000          SA OS/390 - Command Dialogs
Domain ID   = IPSFM   ----- CICS -----   Date = 08/30/02
Operator ID = NETOP1                               Time = 17:14:47

Resource      =>                                     Format: name/type/system
System        =>                                     System name, domain ID or sysplex name

    1. Inquire          Display CICS Information      INGCICS REQ=INFO
    2. Start            Start a CICS subsystem        INGREQ REQ=START
    3. Shutdown         Shutdown a CICS subsystem    INGREQ REQ=STOP
    4. Triggers         Display trigger conditions  DISPTRG
    5. Service Periods  Perform scheduling functions  INGSCHED
    6. Master Terminal  Perform master terminal cmds  INGCICS REQ=CMD
    7. Monitoring       Perform monitoring functions
    8. Broadcast        Send messages to users        INGCICS REQ=BROADCAST

    99. Local Functions Provide access to user defined local functions

Command ==>
PF1=Help   PF2=End   PF3=Return          PF6=Ro11
                                         PF12=Retrieve
```

Figure 16. CICS Automation Main Menu

resource

The following describes the options you can select on the main menu:

1. Inquire

This option invokes the INGCICS REQ=INFO command which will execute a preset sequence of commands and display the results.

2. Start

This option initiates the startup process of a resource. By choosing this option you issue the INGREQ command. See "Startup" on page 107.

3. Shutdown

This option initiates the shutdown process of a resource. By choosing this option you issue the `INGREQ` command. See Chapter 8, “Starting and Stopping Resources” on page 107.

4. Triggers

This option displays the triggers associated with a resource. By choosing this option you issue the `DISPTRG` command. See *System Automation for OS/390 Operator's Commands*.

5. Service Periods

Use this option if you want to display or override the schedule associated with a resource. By choosing this option you call the `INGSCHEd` command. See *System Automation for OS/390 Operator's Commands*.

6. Master Terminal

This option invokes the `INGCICS REQ=CMD` command which allows you to enter a command to be executed on the CICS subsystem. The output of the commands will be displayed.

7. Monitoring

Use this option to work with link monitoring and health checking. See Chapter 9, “Monitoring Your CICS Subsystems” on page 111.

8. Broadcast

This option invokes the `INGCICS REQ=BROADCAST` command which allows you to specify the parameters for the `CMSG` transaction. It will then execute the transaction and return the results to the display.

99. Local Functions

CICS Automation allows your system programmer to add functions to this operator interface. If functions have been added at your installation, you would select this option to view a menu of them.

Note: The options 7 and 99 are only valid for the local sysplex. You cannot access a remote sysplex with any of these functions.

Selecting and Viewing Subsystems

This section explains how to select a resource from a list of available resources and how to display detailed information about a subsystem.

Selecting a Subsystem

You can specify the resource you want to work with by entering its name in the Subsystem or Resource field of the panel. On the CICS-specific panels you can display a list of the CICS subsystems by entering a question mark in the Subsystem or Resource field. On the SA OS/390 panels (`INGREQ`, `INGSCHEd`, `DISPTRG` commands), you can use an asterisk (*) as a wildcard.

Figure 17 on page 105 shows a sample list of CICS subsystems:

```

INGKYSTS          SA OS/390 - Command Dialogs          Line 1 of 16
Domain ID = IPSFM ----- Selection Panel ----- Date = 04/25/00
Operator ID = NETOP1          Sysplex = KEY1PLEX          Time = 09:26:29

CMD: S Select / scroll
CMD Name      Type System      Compound      Desired      Observed      Nature
-----
s CICSK1G     APL KEY1      SATISFACTORY UNAVAILABLE  SOFTDOWN
CICSK1H     APL KEY1      SATISFACTORY AVAILABLE    AVAILABLE
CICSK3A     APL KEY1      PROBLEM      AVAILABLE    PROBLEM
CICSK3B     APL KEY1      PROBLEM      AVAILABLE    HARDDOWN
CICSK3E     APL KEY1      PROBLEM      AVAILABLE    HARDDOWN
CICSK4C     APL KEY2      SATISFACTORY AVAILABLE    AVAILABLE
CICSK4D     APL KEY2      PROBLEM      AVAILABLE    HARDDOWN
CICSK4F     APL KEY2      PROBLEM      AVAILABLE    HARDDOWN
EYUCMS1A    APL KEY1      SATISFACTORY AVAILABLE    AVAILABLE
EYUCMS1B    APL KEY2      SATISFACTORY AVAILABLE    AVAILABLE
EYUCMS2A    APL KEY1      PROBLEM      AVAILABLE    HARDDOWN
EYUCMS2B    APL KEY2      INHIBITED    AVAILABLE    SOFTDOWN
EYUMAS1A    APL KEY1      PROBLEM      AVAILABLE    PROBLEM

Command ==>
PF1=Help      PF2=End      PF3=Return      PF6=Ro11
PF8=Forward   PF9=Refresh  PF10=Previous  PF11=Next      PF12=Retrieve

```

Figure 17. Selection Panel for CICS Resources

The list contains all subsystems of the KEY1PLEX sysplex that are defined to SA OS/390. You can use it to select a subsystem (by entering s in the CMD column), and to get an overview of the systems in the sysplex. Columns 3 through 5, for example, contain status information of the subsystems. For more details about the different status types, see *System Automation for OS/390 User's Guide*.

Chapter 8. Starting and Stopping Resources

CICS Automation uses the INGREQ command of SA OS/390 for starting and stopping resources. For information on INGREQ, see *System Automation for OS/390 Operator's Commands*. The following describes things to consider when starting or stopping a CICS resource.

Startup

If you select option 2, Startup, on the main menu, the INGREQ command dialog is displayed:

```

INGKYRU0          SA OS/390 - Command Dialogs
Domain ID = IPSFM  ----- INGREQ -----      Date = 05/03/00
Operator ID = NETOP1                               Time = 12:34:09

Resource => CICS1H/APL/KEY1          format: name/type/system
System   =>                          System name, domain ID or sysplex name

Request  => START                    Request type (START, UP or STOP, DOWN)
Type     => NORM                      Type of processing (NORM/IMMED/FORCE/user) or ?
Scope    => ONLY                      Request scope (ONLY/CHILDREN/ALL)
Priority  => LOW                       Priority of request (FORCE/HIGH/LOW)
Expire   =>                          , Expiration date(yyyy-mm-dd), time(hh:mm)
Timeout  => 0 / MSG                   Interval in minutes / Option (MSG/CANCEL)
AutoRemove =>                        Remove when (SYSGONE, UNKNOWN)
Restart  => NO                        Restart resource after shutdown (YES/NO)
Override => NO                        (ALL/NO/TRG/FLG/DPY/STS/UOW/INIT)
Verify   => YES                       Check affected resources (YES/NO/WTOR)
Precheck => YES                       Precheck for flags and passes (YES/NO)
Appl Parm =>

AOF710A VERIFY/REVISE INPUT AND THEN PRESS ENTER
Command ==>>
PF1=Help   PF2=End   PF3=Return           PF6=Roll
PF12=Retrieve
  
```

Figure 18. Input Panel for the INGREQ Command

The CICS-specific features apply to the **Type**, the **Override**, and the **Appl Parm** fields:

Type In this field, you can specify the start type. The possible values depend on the CICS version as follows:

Start Type	Explanation	Valid for
AUTO	Uses the restart data set to determine the startup type.	All releases
COLD	Initiates a cold start.	All releases
INITIAL	Initiates a cold start with additional processing for CICS TS resources.	CICS TS V1R1 and above
LOGTERM	Initiates a startup, and then a shutdown as soon as the startup is complete.	Pre CICS TS V1R1
NORM	This is the same as AUTO.	
STANDBY	Initiates a start for an XRF backup.	All releases

INGREQ accepts all these types, regardless of the CICS version to which the resource belongs; thus, for example, LOGTERM is accepted for a CICS TS subsystem. It is up to the automation programmer to map the INITIAL type to an accepted start type for CICS4, and similarly for LOGTERM and CICS TS. This is done in the STARTUP policy item for the application in the policy database.

When you want to see the startup types that have actually been defined for the subsystem to be started, enter a question mark in the **Type** field and press ENTER. Then you will see a panel like the following:

```

A0FKSEL3          SA OS/390 - Command Dialogs          Line 1 of 4
Domain ID = IPSFM  ----- INGREQ -----             Date = 05/03/00
Operator ID = SCHR                                     Time = 12:34:12

The following start types are defined for CICS1H/APL/KEY1
Select one item to be processed, then press ENTER.

Sel  Start types
---  -----
-    AUTO
-    COLD
-    INITIAL
-    NORM

Command ==>
PF1=Help    PF2=End    PF3=Return
PF6=Roll                                         PF12=Retrieve

```

Enter **s** in the **Sel** column to select the desired type.

Note: When you select a startup type that is valid for CICS, but has not been defined in the STARTUP policy item of the target resource, INGREQ issues the command defined for the NORM startup type in the STARTUP item. If that entry does not exist either, the command MVS START *jobname* is issued.

Override

The following values are CICS specific:

Value	Condition overridden
INIT	This override allows you to select a start type other than INITIAL although an INITIAL start has been requested for CICS.
UOW	This override allows you to select the INITIAL or COLD startup type, although <ol style="list-style-type: none"> 1. The field Keypoint req of the CICS CONTROL policy item is set to YES in the policy database for this application, AND 2. Indoubt units of work were detected during the last shutdown of CICS, or no warm keypoint was taken during the last execution.

Appl Parm

You can enter overrides to the system initialization table (SIT) in the following format:

KEYWORD=value

For details see the CICS documentation.

Note: To use this function, your CICS must be set up to allow SIT overrides input from the console.

You can specify more than one parameter in this field. The entries must be separated by a blank or a comma.

If you have not changed the default value of YES for the **Verify** field, CICS Automation will display a verification panel (see Figure 19) after you have pressed ENTER. This panel displays the target resource and in addition all the resources which SA OS/390 will try to start because the startability of the selected resource directly or indirectly depends on them.

```
AOFKVFY1          SA OS/390 - Command Dialogs          Line 1 of 3
Domain ID = IPSFM  ----- INGREQ -----             Date = 05/03/00
Operator ID = SCHR                                         Time = 12:34:11

Verify list of affected resources for request START

CMD: S show overrides  T show trigger details  V show votes
Cmd Name      Type System  TRG SVP  W Action Type  Observed Stat
-----
CICSK4C      APL KEY2                Y        AUTO  UNAVAILABLE
JES2         APL KEY2                Y        AUTO  UNAVAILABLE
VTAM         APL KEY2                Y        AUTO  UNAVAILABLE

Command ==>
PF1=Help PF2=End  PF3=Return          PF6=Ro11
PF10=GO   PF11=CANCEL  PF12=Retrieve
```

Figure 19. Verification Panel for INGREQ

For more information on the verification panel of INGREQ, see *System Automation for OS/390 Operator's Commands*.

Shutdown

When you select option 3, Shutdown, from the main menu panel, the INGREQ panel displays as follows.

```

INGKYRU0          SA OS/390 - Command Dialogs
Domain ID = IPSFM ----- INGREQ ----- Date = 05/03/00
Operator ID = SCHR                               Time = 16:43:22

Resource => CICSK4C/APL/KEY2          format: name/type/system
System   =>                          System name, domain ID or sysplex name

Request  => STOP                      Request type (START, UP or STOP, DOWN)
Type     => NORM                      Type of processing (NORM/IMMED/FORCE/user) or ?
Scope   => ONLY                      Request scope (ONLY/CHILDREN/ALL)
Priority => LOW                      Priority of request (HIGH/LOW)
Expire   =>                          , Expiration date(yyyy-mm-dd), time(hh:mm)
Timeout => 0 / MSG                  Interval in minutes / Option (MSG/CANCEL)
AutoRemove =>                      Remove when (SYSGONE, UNKNOWN)
Restart  => NO                      Restart resource after shutdown (YES/NO)
Override => NO                      (ALL/NO/TRG/FLG/DPY/STS/UOW/INIT)
Verify   => YES                      Check affected resources (YES/NO/WTOR)
Precheck => YES                      Precheck for flags and passes (YES/NO)
Appl Parns =>

Command ==>
PF1=Help   PF2=End   PF3=Return
PF6=Roll   PF12=Retrieve

```

Figure 20. Input Panel for INGREQ Command

Chapter 9. Monitoring Your CICS Subsystems

CICS Automation provides two functions to monitor CICS subsystems:

- Link monitoring
- Health checking

Select option 7, Monitoring, from the main menu to display the CICS Automation Monitoring panel, as shown:

```
EVEKM000          SA/CICS - Monitoring                               Date: 08/30/02
                                                            Time: 12:35
Resource          => CICSK1H/APL/KEY1                            (? for list)

1. Link monitoring
2. Health checking

Command ==>>
F1=Help      F2=End      F3=Return      F6=Roll
```

Figure 21. CICS Automation Monitoring Panel

The following sections, “Link Monitoring” and “Health Checking” on page 115 provide further information about these two functions.

Link Monitoring

Link monitoring verifies that the interregion and intersystem connections (IRC and ISC) are active. This verification occurs at fixed intervals. When a link failure is detected, link monitoring performs automatic recovery actions.

Basic link monitoring only ensures that the VTAM connections are available. To verify the other end of the link, the so-called echo facility, also referred to as *echoplexing*, must be activated. This is supported for links to CICS and IMS.

You can access the Link Monitoring interface in two ways, from NetView and from CICS. To access Link Monitoring from NetView, use option 7 from the CICS Automation main menu. To access Link Monitoring from CICS, log on to CICS and issue C0L0 as a transaction. This action will invoke the Link Monitoring interface running under CICS.

From the Monitoring panel of the CICS Automation operator interface, select option 1 to display the following:

```

EVEKM100          SA/CICS - Link Monitoring
                                     Date: 08/30/02
                                     Time: 14:19

Resource          => CICSK1H/APL/KEY1      (? for list)

Current monitor status . : UNKNOWN

      1. Start          Start link monitor
      2. Stop           Stop link monitor
      3. Display        Display links
      4. News           Update system news

Command ==>>
F1=Help      F2=End      F3=Return      F5=Refresh  F6=Roll

```

Figure 22. Monitoring Links Panel

The **Current Monitor Status** field shows the status of the link monitor for this subsystem. You can choose among the options listed to start or stop the link monitor, display the link, or update system news.

Note: If an option is preceded by an asterisk instead of a number, the option is not valid with the current status. For example, START would not be a valid option if the monitor status is ON.

Starting or restarting link monitoring for a subsystem is useful after a system configuration change because all definitions controlling link monitoring are re-loaded. When you display the links, option 3, the system news, is also displayed.

Displaying Links

Select the "Display" option from the Link Monitoring panel to view the following panel:

```

EVEKM130          SA/CICS - Display Links
Resource . . . . . CICS2      (? for list)      Date: 01/03/02
Time: 10:20
More:
Select a command: 1. mon on   3. echo on   5. recover
                  2. mon off  4. echo off  6. details  7. periods

Cmd  Conn  Applid  Description      Desired  Actual  Mon  Last  Echoplex
      status status
-   C01A  CICS1   CICS2 TO CICS1  UP       UP      ON   11:32 ON
-   C01B  CICS3   CICS2 TO CICS2  UP       DOWN    ON   10:00 ON
-   C01C  IMS01   CICS2 TO IMS01  UP       UP      ON   11:31 ON
-   C01D  AS400   CICS2 TO AS400  UP       UP      ON   11:33 ON

.....
SYSTEM NEWS: CICS3 will be unavailable 01/05/00 from 0800-1200 for
system maintenance.
.....

F1=Help      F2=End      F3=Return   F4=CICS menu  F5=Refresh   F6=Roll

```

Figure 23. Display Links Panel

From this panel, you can:

- Reactivate monitoring for a link.
- Deactivate monitoring for a link.
- Reactivate the echo facility for a link. You use this function when the echo facility has been turned off or when it has been disabled by link monitoring.
- Deactivate the echo facility for a link.
- Initiate a recovery action for a link.
- View details about a specific link.
- View a day’s schedule.
- View the schedule for seven days.
- Override the schedule. This is similar to service period overrides.

The Display Links panel displays the following information:

Subsystem	The symbolic name by which this CICS subsystem is known to SA OS/390.
Conn	The four-character symbolic name by which this link is known to this CICS subsystem. This is defined on the CICS subsystem itself (SYSID) and in the Connection id field of the CICS CONNECTION policy object.
Applid	The symbolic name by which the remote subsystem is identified to VTAM.
Description	A short description of the link.
Desired status	What the status of this link should be: UP Current time is within a link monitoring period. DOWN Current time is outside a link monitoring period.
Actual status	The last status obtained. Statuses are: UP Link is available. DOWN Link is not available. TROUBLE Link is being recovered after a link failure. UNKNOWN Connection has not yet been monitored, or the current time is outside the monitoring period of the link.
Mon	Specifies the status of link monitoring for the link: ON Link monitoring is active. OFF Link monitoring has been deactivated by the operator.
Last check	Specifies the time in hours and minutes of the last check for this link.
Echoplex	Specifies the status of the echo facility for the link: blanks The echo facility is not being used. nnnnnnnn Number of messages sent and received to and from the remote system. PROBLEMS The echo facility did not receive a response from the remote system within the echo delay time specified in the Echo field of the CICS CONNECTION policy object linked to the subsystem. FAILED The echo facility detected an error. DISABLED The echo facility could not recover from a failure and is inoperative. OFF The echo facility has been deactivated by operator. ON Echoplexing is done when the link status changes to UP.
System News	Specifies up to 210 characters of installation-specific information that can be entered by the operator with the System News option.

If you select option 6, Details, from the Display links panel you will see the following information:

Local application ID	The symbolic name by which this CICS subsystem
-----------------------------	--

	is identified to VTAM and is defined in the APPLid field of the CICS CONTROL policy item.
Remote application ID	The symbolic name by which the remote subsystem (at the other end of the link) is identified to VTAM.
Connection type	Specifies the type of communication: MRO, LU6.1, or LU6.2.
Time zone location	Specifies the difference in hours and minutes between the remote link subsystem and Greenwich time. EAST and WEST indicate where the subsystem is situated compared to Greenwich.
Last monitoring check	Specifies the time in hours and minutes of the last check for this link.
Echoplex status	Specifies the status of the echo facility for the link.
Average response time	Average response time of the echo facility over the last five minutes.
Service status	Specifies whether the link is in service.
Acquire status	Specifies whether the link is acquired.
Check interval	Specifies the interval after which the status of the link is checked regularly.
Max. recovery actions	Specifies the maximum number of automatic recovery actions after detection of a link failure, as defined in the Max repair tries field of the CICS CONNECTION policy object.
Release delay time	Specifies the time delay between a CICS request to release the link and the next CICS request for that link, as defined in the Release delay field of the CICS CONNECTION policy object.
Acquire delay time	Specifies the time delay between a CICS request to acquire the link and the next CICS request for that link, as defined in the Acquire delay field of the CICS CONNECTION policy object.
Remote system type	Specifies the type of the remote system.
Remote echo process	Specifies the name of the remote echo process as defined in the Echo field of the CICS CONNECTION policy object.
Echo delay time	Specifies the time delay after which an echo response must have been received from the remote system.
Monitoring periods	Specifies the intervals (in the remote system's local time) during which the link is monitored.

Health Checking

Through health checking, you execute programs that check the health of an application running under CICS. CICS Automation initiates a health check program by sending a request across the program-to-program interface to CICS. CICS invokes the program, and sends back an Acknowledgement (ACK),

indicating that the program executed as expected, or it sends a Negative Acknowledgement (NACK), indicating that the program did not execute as expected. A NACK includes data describing the error.

Because health checking is application specific, the actual health checking programs must be written by programmers in your installation. CICS Automation does, however, provide some samples for system programmers in the CICS Automation source library.

Health check routines are executed automatically at timed intervals. When CICS Automation receives an abnormal response from CICS (NACK) or when a timeout occurs, CICS Automation sends out notification messages. CICS Automation panels can also be used to manually work with health checking.

Select option 2, Health checking, from the CICS Automation Monitoring panel to display the following:

```

EVEKM200          SA/CICS - Health Checking          Page: 1 of 1
Resource . . . . . CICS2      (? for list)          Date: 01/09/02
                                                    Time: 10:20

Select a command:  1. Start          3. Suspend          5. Detail
                  2. Stop           4. Resume           6. Immed check

                                Last Status Check
CMD Program Description      Status      Date      Time      Response
- HCPAY1 CHECK PAYROLL DATA BASE ACTIVE      01/09/00 10:32:00 ABNORMAL
- HCEDI5 ACCESS TO EDITOR      INACTIV    01/06/00 09:00:00 NORMAL
- HCFULL 95% FULL CONDITION    ACTIVE     01/09/00 11:30:05 NORMAL
- HCACTV 95% ACTIVE CONDITION  ACTIVE     01/09/00 09:09:59 NORMAL
- HCAREC ACCOUNTS RECEIVABLE  ACTIVE     01/09/00 11:33:00 ABNORMAL
- HCTERMA 95% TERMINALS ACTIVE INACTIV    01/06/00 09:00:00 NORMAL
- HCOU1 ACCESS TO OUTMAIL FILE ACTIVE      01/09/00 11:33:10 ABNORMAL
- HGIN1 ACCESS TO INMAIL FILE  INACTIV    01/06/00 09:10:00 ABNORMAL
- HCPAY2 PAYROLL SUBMIT        ACTIVE     01/09/00 08:32:55 NORMAL
- HCTERM2 REMOTE TERMINAL PROGRAM INACTIV    01/03/00 08:00:00 NORMAL

Command====>
F1=Help      F2=End      F3=Return   F4=CICS menu F5=Refresh  F6=Ro11

```

Figure 24. Health Checking Panel

The Health Checking panel lists the health check routines for a particular subsystem. The list includes:

- The program name
- The description
- The status (ACTIVE, INACTIV, or SUSPEND, which shows whether automatic execution is active)
- A time stamp of the last time the routine ran
- The response (NORMAL or ABNORMAL).

From this panel, you can:

- | | |
|--|--|
| <ol style="list-style-type: none"> 1. Start 2. Stop 3. Suspend 4. Resume | <ul style="list-style-type: none"> Initiate automation of a routine Stop automation of a routine Temporarily stop automation execution of a routine Continue with a process that was temporarily stopped |
|--|--|

5. Detail

Expand upon the given information to show the details of a health check routine

6. Immed check

Immediately submit a status check regardless of status and scheduled time interval

Chapter 10. Broadcasting Messages

INGCICS REQ=BROADCAST allows you to send messages to any user of the CICS subsystem. Figure 25 shows a sample Broadcast Messages panel:

```
EVEKYCMD          SA OS/390 - Command Dialogs          Line
Domain ID   = IPSFM   ----- INGCICS -----          Date = 08/30/02
Operator ID = NETOP1                                     Time = 18:45:43

Resource      => CICSK1H/APL/KEY1                      Format: name/type/system
System        =>                                           System name, domain ID or sysplex name
Request       => BROADCAST                               CMD, BROADCAST or INFO
CICS Transaction => MSG R=&ROUTE, '&MESSAGE', HEADING=YES, S
CICS Route    => ALL
CICS Message  =>
               =>

AOF145I PARAMETER MISSING
Command ==>>
PF1=Help      PF2=End      PF3=Return  PF4=DISPINFO  PF6=Ro11
               PF9=Refresh                                PF12=Retrieve
```

Figure 25. Broadcast Messages Panel

The &ROUTE and &MESSAGE items are placeholders for the information in the Route and Message lines. The CICS transaction field is automatically filled with the text above. You can make changes to it before pressing Enter to execute the transaction. Specify the routing information in the route field - routing information format is the same as specified for the MSG transaction. Specify the message in the two message fields provided.

Chapter 11. The Status Display Facility

The Status Display Facility uses color to represent the various subsystem resource statuses such as error, warning, action, or informational states. Typically, a subsystem shown in green on a Status Display Facility status panel indicates that it is up, whereas red indicates a stopped or problem state.

The Status Display Facility status display panels can be tailored to present the status of system components in a hierarchical manner. The hierarchical display of status information is implemented using tree structures. A tree structure always starts with the system name as the root component. The “leaves” of the tree are the monitored resources.

Color can be propagated up or down the leaves of the tree structure based on the order of dependencies. The effect of propagation is to consolidate, at the root component, the status of all the monitored resources in that system. In this way, the color of the root component reflects the most important or critical status in a computer operations center. If all the monitored resources are green, the root component (the system) will be green.

CICS Automation provides additional Status Display Facility panels that monitor events that occur in the following areas for all CICS regions defined to CICS Automation:

Health

Messages associated with health checking are routed to the Status Display Facility health checking panels.

VTAM ACB

Messages associated with VTAM ACBs are routed to the Status Display Facility VTAM ACB panels.

Autoinstall

Messages associated with autoinstalls are routed to the Status Display Facility autoinstall panels.

Link Monitor

Messages associated with link monitoring are routed to the Status Display Facility link monitoring panels.

CICS Storage

Short-on-storage and storage violation messages are routed to the Status Display Facility storage panels.

CICS Monitor

CPSM and critical messages associated with timers are routed to the Status Display Facility CICS monitor panels.

CICS Transaction

Messages associated with transactions are routed to the Status Display Facility transactions panels.

To use the CICS Automation Status Display Facility panels, enter **SDF** on a NetView panel command line. A panel similar to the following is displayed:

SYSTEM						SA OS/390 - SUPPORT SYSTEMS					
System	Subsystems	WTORs	Gateways	Products	System						
KEY1	IMS712M1	IM631C4	IPUFMI	C I D O	P V M B T U						
KEY2	CICSK4D	NETATST2	IPSFNO	C I D O	P V M B T U						
KEY3			IPSF00	C I D O	P V M B T U						
KEY4				C I D O	P V M B T U						

08/16/00 07:37

===>

1=HELP 2=DETAIL 3=RETURN 6=ROLL 8=NEXT SCR 10=LEFT 11=RIGHT 12=TOP

Figure 26. Status Display Facility Main Panel

Note: Sample Status Display Facility panels are provided with CICS Automation. The programmer customizes the panels for your specific environment, so the panels shown here will not look exactly like your panels.

This could be your primary panel that lists the systems and their status. The color of KEY1 through KEY4 will reflect the most critical status of any resource in that system.

If you place the cursor under the letter **C** on the panel displayed in Figure 26 and press PF8, the following panel displays (assuming you are using the default sample panels):

```

KEY1C          KEY1 CICS MONITOR PANEL

Health
VTAM ACB
Autoinstall
Link Monitor
CICS Storage
CICS Monitor
CICS Transaction

                                09/03/02 15:25

===>
PF1=HELP 2=DETAIL 3=END 6=ROLL 7=UP 8=DN          12=TOP

```

Figure 27. The CICS Monitor Panel

This shows several categories in which CICS status is important. If the letter C shown on the previous panel was red, then at least one of the items on the CICS Monitor panel will be red. Tab down to the red item and press PF8. This displays the messages logged against that item, as shown in the following:

```

KEY1CLM1      CICS Link Monitor

                System   Message text
09/03/02 10:31:31 CICSK1H  "EVE819I CICSK1H : IM4A - CRITICAL CONNECTION TO

                                09/03/02 15:30

===>
PF1=HELP 2=DETAIL 3=RET          6=ROLL 7=UP 8=DN          11=RT 12=TOP

```

Figure 28. The CICS Link Monitor Panel

Note: If the full message is not displayed on the screen, press PF11 to shift to the right.

To see the details of a message, tab down to that message and press PF2. This displays the following:

```
----- DETAIL STATUS DISPLAY -----
                                         1 OF 4

COMPONENT: CICSA                      SYSTEM : KEY2
COLOR   : RED                          PRIORITY : 200
DATE    : 04/16/95                     TIME     : 08:00:32
REPORTER : GATAOF06                    NODE     : AOF06
REFERENCE VALUE: CICSA_TI_
'START DENIED BY OTHER EXIT'

===>
PF3=RET 4=FPI 6=ROLL 7=UP 8=DN 9=AST 10=DEL 11=BOT 12=TOP
```

Figure 29. The Detail Status Display Panel

To delete a message, press PF10.

Note: If any of the panels have 1 of X in the upper-right corner of the screen, where X is a number greater than 1, subsequent panels contain additional data. Press PF8 to scroll forward to view the information. Press PF7 to scroll back.

Chapter 12. NMC Display Support

The following messages and events are displayed on NMC for the subsystem that they occur in.

The alerts are attached to the subsystem as a minor resource. They have the following resource names:

Table 8. Resource Names of Alerts

Alert	Resource Name
Messages	plexname.resname/APL/sysname.MSG/message_id.
Health Checking	plexname.resname/APL/sysname.HEALTH
VTAM ACBs	plexname.resname/APL/sysname.ACB
Autoinstall	plexname.resname/APL/sysname.AUTO_INSTALL
Link Monitoring	plexname.resname/APL/sysname.LMT
CICS Storage	plexname.resname/APL/sysname.STORAGE
CICS Transactions	plexname.resname/APL/sysname.TRAN/traname

In addition, for systems with CPSM active and SAM and RTA monitors writing to consoles via WTO, the following alerts will be attached to the subsystem as minor resources:

Table 9. Further Resource Names of Alerts

Alert	Resource Name
Transaction Dumps	plexname.resname/APL/sysname.RTA/SAM/TDM/abcode/userid/termid/tranid
System Dumps	plexname.resname/APL/sysname.RTA/SAM/SDM/abcode/userid/termid/tranid
Short on Storage	plexname.resname/APL/sysname.RTA/SAM/SOS/dsaname
Max. Task	plexname.resname/APL/sysname.RTA/SAM/MAX
Stall	plexname.resname/APL/sysname.RTA/SAM/STL/type
Any user defined RTA	plexname.resname/APL/sysname.RTA/restype/resname/defname

Appendix. CICS Automation and the Program-to-Program Interface

Warning!

CICS Automation uses the program-to-program interface for issuing CEMT transactions from the operator interface, for link monitoring, and for health checking. If you are considering using the CICS Automation program-to-program interface code for your own purposes, remember that this interface is release sensitive. The significance of this is that you may need to recompile or make changes to your code to be compatible with new releases of CICS Automation or NetView.

Program-to-Program Interface Components in NetView and CICS

Figure 30 illustrates CICS Automation program-to-program interface components in NetView and in CICS.

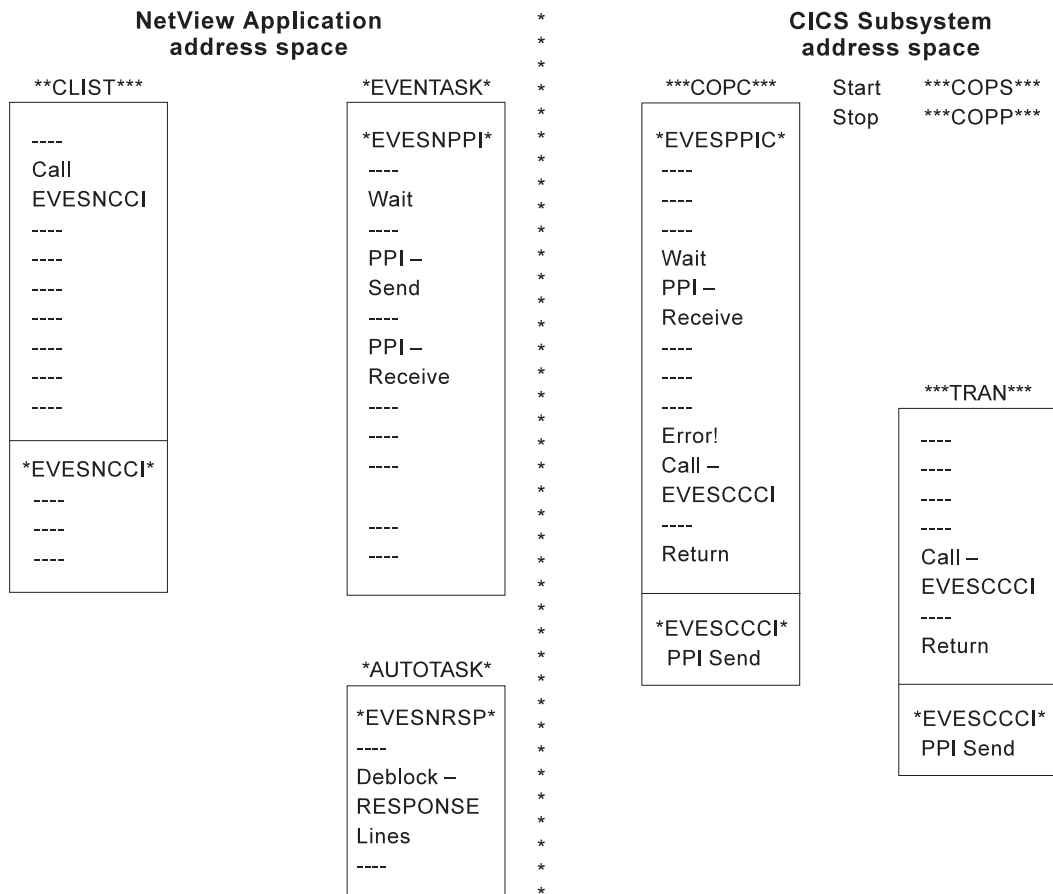

Figure 30. Program-to-Program Interface Components in NetView and CICS. Two of the programs shown in this figure have not been previously mentioned: EVESNPPI and EVESPPIC. EVESNPPI is the NetView subtask program. EVESPPIC is the CICS long-running receiver program. These are internal programs and are not described in this manual.

NetView Requests Using the Program-to-Program Interface

The following requests from NetView are described in this section:

- CONVERSE
- SEND
- CANCEL

EVESNCCI is used for these requests. This section only provides an overview of how EVESNCCI works. The programming details, such as command syntax, return codes, and segment support, are provided in “EVESNCCI—NetView to CICS Communication Interface” on page 135.

CONVERSE from NetView

A CONVERSE request from a NetView command list (or command processor) starts a CICS transaction on the same host. The CICS transaction is expected to return a response to a specified NetView task in a named NetView domain. The response can have the form of a RESPONSE, an ACK, or a NACK.

The EVESX001 (CICSSEC) and EVESX022 (CICSQRY) command processors are called to verify the authorization of the caller and to obtain the VTAM application identifier, which is used as the program-to-program interface receiver identification. EVESNCCI returns a message and a return code indicating whether the command was successful or not. If the command is accepted, it is forwarded to the EVENTASK optional task.

The EVENTASK optional task uses the program-to-program interface to notify CICS that the transaction is to be started.

The started transaction retrieves the input data. The CICS transaction returns a response to NetView. The response is sent back to the EVENTASK optional task using the program-to-program interface. The processing of the response sent to NetView differs for the various response types, as described below:

A for ACK

The following message is sent to the requestor:

```
EVE128I POSITIVE ACKNOWLEDGEMENT
```

N for NACK

The following message is sent to the requestor:

```
EVE129E response-data
```

where *response-data* is the data returned by the CICS program.

R for RESPONSE

When this request type is used, the NetView program-to-program interface initialization member is interrogated to locate the function requested so that the command list can be identified. The request is then scheduled under the autotask associated with the requested function, after which the data is sent to the requestor.

The following figure illustrates the flow of events initiated by an EVESNCCI CONVERSE request:

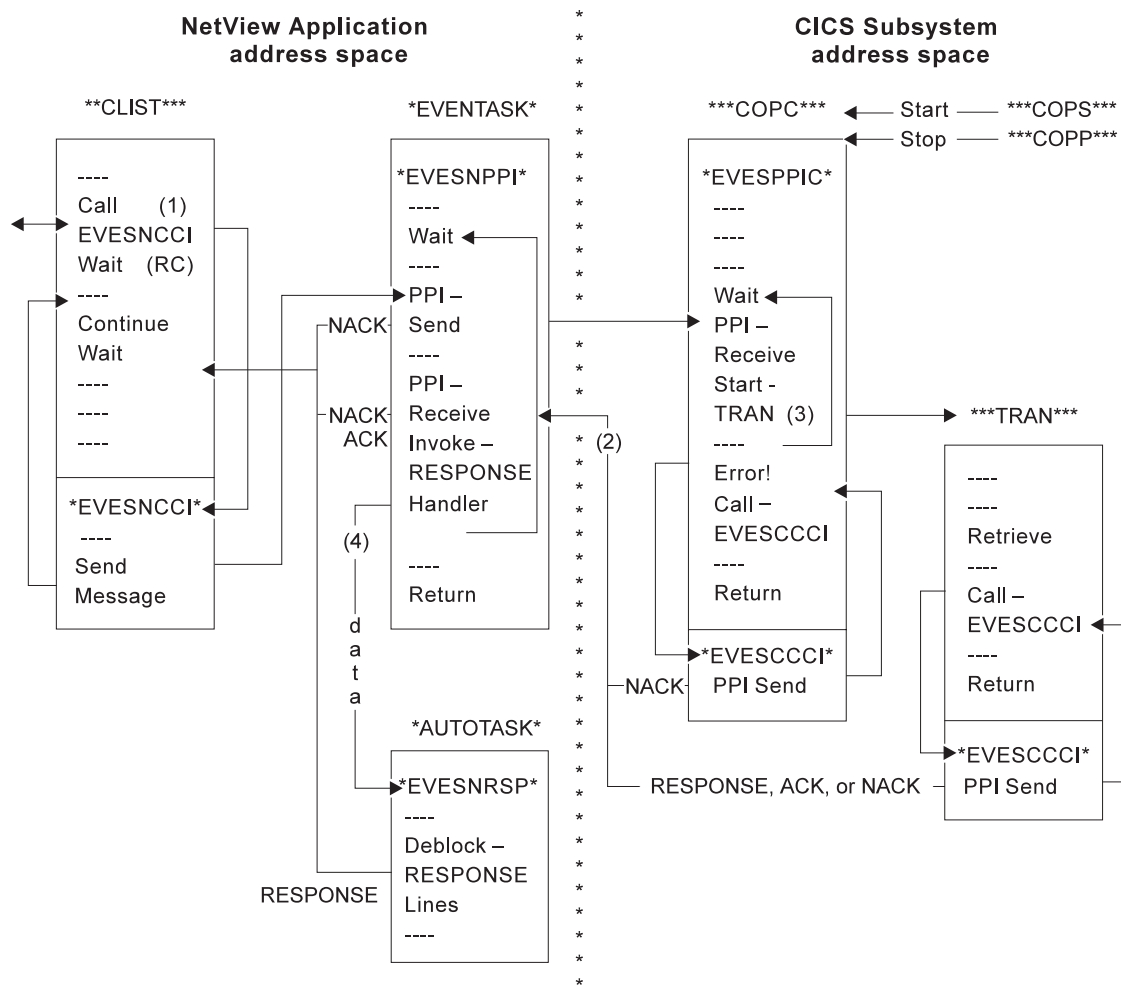

Figure 31. An EVESNCCI CONVERSE Request

Notes:

1. Parameters passed with EVESNCCI indicate the request type (in this case C for CONVERSE), the target CICS, the name of the function to be invoked, data (if required), and the requesting operator ID and domain ID.
2. The responses (RESPONSE, ACK, or NACK) are returned from CICS to the requestor (operator ID and domain ID).
3. The function name is used to locate the transaction name in the CICS initialization member. If the transaction name cannot be found, a NACK response is returned.
4. The name of the autotask and the name of the command processor or command list in NetView are obtained using the function name in the NetView initialization member. If the name or names cannot be found, or if the scheduling of the autotask fails, a NACK response is returned.

SEND from NetView

A SEND request from a NetView command list starts a CICS transaction on the same host. No response is returned. The EVESX001 (CICSSEC) and EVESX022 (CICSQRY) command processors verify the authorization of the caller and obtain the VTAM application identifier, which is used as the program-to-program interface receiver identification. EVESNCCI returns a message and return code

indicating whether the command was successful or not. If the command is accepted, it is forwarded to the EVENTASK optional task. This task uses the program-to-program interface to notify CICS to start the transaction.

Errors found by EVESNCCI are returned to the caller. Other errors detected during the processing of a SEND request are not returned. These errors are only logged.

Refer to the following figure:

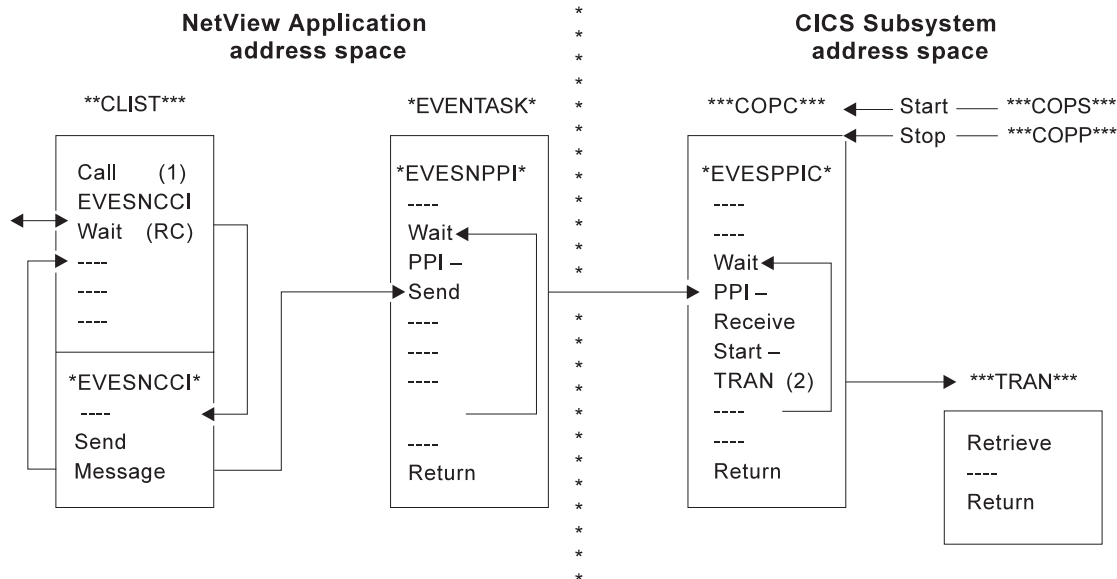

Figure 32. An EVESNCCI SEND Request

Notes:

1. Parameters passed with EVESNCCI indicate the request type (in this case S for SEND), the target CICS, the name of the function to be invoked, and data (if required).
2. The function name is used to locate the transaction name in the CICS initialization member.

CANCEL from NetView

The maximum amount of text that can be specified on the EVESNCCI command is limited to 240 bytes, including the command name EVESNCCI. The maximum amount of data that can be specified varies with the particular EVESNCCI command, but it is always less than 240 bytes. The CICS Automation program-to-program interface implementation provides segment support which allows up to 32656 bytes to be sent from NetView to another program-to-program interface receiver. Segment support is described in "EVESNCCI—NetView to CICS Communication Interface" on page 135 (refer to the SEGMENT= keyword and the usage notes).

The EVESNCCI CANCEL request is used when the segment assembly process must be terminated. This request type causes all saved segments for the specified segment identifier to be freed. If the command is accepted, it is always successful, whether saved segments with the specified segment identifier exist or not.

Users of the segment function are requested to use CANCEL when applicable. This prevents the NetView application system from being filled with unused data.

Errors found by EVESNCCI are returned to the caller. Each CANCEL is logged.

CICS Requests Using the Program-to-Program Interface

The following requests from CICS are described in this section:

- CONVERSE
- SEND

EVESCCCI is used for these requests. This section only provides an overview of EVESCCCI. The programming details, such as command syntax and return codes, are provided in “EVESCCCI - CICS to NetView Communication Interface” on page 141.

CONVERSE from CICS

A CONVERSE request from a CICS transaction starts a command list or a command processor in the NetView application system on the same host. The command list or command processor is expected to return a response to the CICS transaction. The response can have the form of a RESPONSE, an ACK, or a NACK.

If the request is accepted, EVESCCCI sends the request to the EVENTASK optional task. The EVENTASK optional task translates the function specification to a command list or command processor name using the EVENTASK initialization member. The autotask under which the command list or processor is to be executed is also obtained from the EVENTASK initialization member.

Errors found by EVESCCCI are returned to the caller. When other errors are detected during the processing of a CONVERSE request, the CICS Automation uses the program-to-program interface to return a NACK response to the CICS transaction. The NACK response data indicates the type of error that occurred. The NACK response is logged via message EVE180E.

Refer to Figure 33 on page 132.

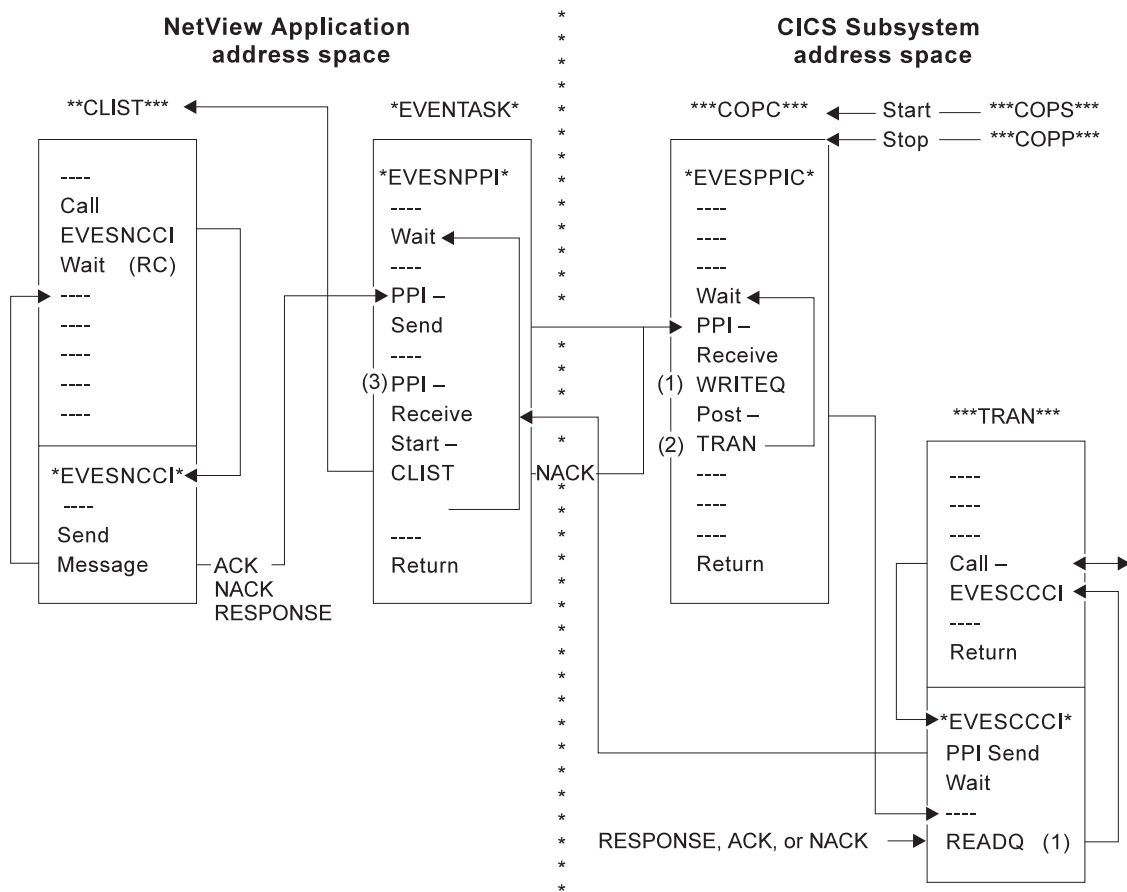

Figure 33. An EVESCCCI CONVERSE Request

Notes:

1. The received data is saved and obtained from temporary storage.
2. The Post-tran is actually a CANCEL of an interval control request.
3. The EVENTASK optional task translates the function specification to a command list or command processor name using the EVENTASK initialization member. The autotask under which the command list or processor is to be executed is also obtained from the EVENTASK initialization member. If the name cannot be obtained or if the scheduling of the command list fails, a NACK response is returned.

SEND from CICS

A SEND request from a CICS transaction starts a command list or a command processor in NetView. No response is returned by the command list or command processor to the CICS transaction.

If the request is accepted, EVESCCCI sends the request to the EVENTASK optional task. The EVENTASK optional task translates the function specification to a command list or command processor name using the EVENTASK initialization member. The autotask under which the command list or processor is to be executed is also obtained from the EVENTASK initialization member. Then, the NetView command processor or command list returns to NetView.

Errors found by EVESCCCI are returned to the caller via a return code and an error code. Other errors detected during the processing of a SEND request are not returned to the requestor. The errors are only logged.

Refer to the following figure:

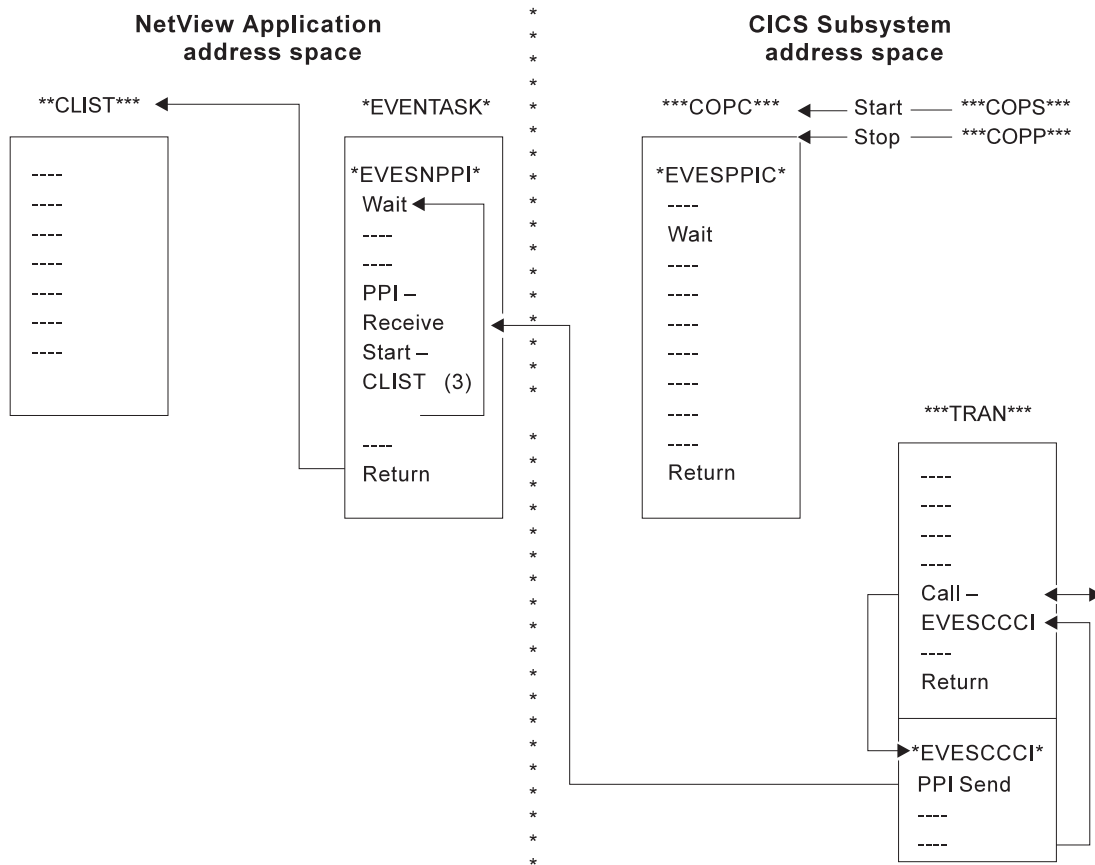

Figure 34. An EVESCCCI SEND Request

Programming Interface

The CICS Automation CICS to NetView program-to-program interface members are:

“EVESNCCI—NetView to CICS Communication Interface” on page 135

Allows you to:

- Initiate, from NetView, the execution of a CICS transaction.
- Send a response to a CICS transaction.

“EVESNRSP - Common Response Handler from CICS” on page 140

The maximum length of a RESPONSE response line is 216 characters. EVESNRSP unblocks the response data in NetView and turns it into a multi-line WTO by calling the EVESX002 (CICSBSMSG) command processor for each response line.

“EVESCCCI - CICS to NetView Communication Interface” on page 141.

Use this subroutine to request, from a CICS transaction, the initiation of a NetView command, a command list, or command processor in NetView.

“EVEMPINT—EVESCCI Parameter List Copy Book” on page 144.
The EVEMPINT copy book describes the CICS Automation program-to-program interface parameter list on the CICS side.

EVESNCCI—NetView to CICS Communication Interface

Use this subroutine to:

- Initiate, from NetView, the execution of a CICS transaction.
- Send a response to a CICS transaction.

Syntax

```
EVESNCCI TYPE=C|S|R|A|N|X
         ,NAME=subsnm
         ,FUNC=function
         [,DATA=data]
         [,REQID=reqid]
         [,SEGMENT=segment]
         [,ID=id]
```

Keyword and Parameter Definitions

TYPE=

Specifies the type of command. Valid command types are:

- C** For CONVERSE: Starts a process at the other end. A response is expected.
- S** For SEND: Starts a process at the other end. No response is expected.
- R** For RESPONSE: This is used to send data to the CICS transaction that issued the CONVERSE request.
- A** For ACK: Signals the successful completion of a CONVERSE request. No data is provided.
- N** For NACK: Signals the unsuccessful completion of a CONVERSE request. Data can optionally be provided (maximum of 100 bytes).
- X** For CANCEL: Use this request type to cancel the segment assembly process.

NAME=

Specifies the CICS subsystem name as it is known to CICS Automation.

FUNC=

Specifies the symbolic name of a process to be initiated or to be responded to, such as a CICS transaction or a NetView command list. The relation between a function name and a process name is contained in the EVENTASK and EVESPINM initialization members.

DATA=

Specifies the request or response data. Not accepted for ACK responses. The maximum data length on a NACK response is 100 bytes. If omitted, no data is passed.

Three data delimiter pairs are supported: single quotes, double quotes, or parentheses. These delimiters must be used when the data contains blanks or commas, or starts with one of the data delimiters itself. Data delimiters are stripped off before passing the data on.

REQID=

Specifies the request identification. This field relates the response to the CICS transaction requesting the response. The value is provided on the CICS

EVESNCCI - NetView to CICS Communication Interface

CONVERSE request and should simply be copied. The request identification may not contain commas or blanks. It is required and only accepted for responses.

SEGMENT=

Use this keyword when the EVESNCCI command must be longer than 240 bytes. The SEGMENT= parameters are:

- F** First segment.
- M** Neither the first and nor the last segment.
- L** Last segment.

When the SEGMENT= keyword is used, the ID= keyword is used to identify the segment chain within a NetView task.

ID=

Identifies the segment chain within a NetView task. This data field is 16 bytes. The segment chain identification may not start with DSI or EVE and may not contain commas or blanks.

Comments and Usage Notes

1. The old parameters **DOMAIN=** and **OPID** are ignored.
2. The requested function must be defined in the CICS Automation program-to-program interface initialization members, as shown for the CEMT function:

In NetView (EVENTASK)

```
SERVER=RESPONSE,CEMT,AUTCPPI,EVESNRSP
```

In CICS (EVEMPINM)

```
EVEMPINM TYPE=ENTRY,      DEFINE A FUNCTION  
          FUNCTION=CEMT,   FUNCTION NAME  
          TRANSID=COMT     TRANSACTION NAME
```

3. The maximum amount of text that can be specified on the EVESNCCI command is limited to 240 bytes, including the command name EVESNCCI.
4. The maximum amount of text that can be specified with a segment chain is 32656 bytes.
5. EVESNCCI saves the segments until the final segment is received. After receiving the final segment, EVESNCCI assembles the segments into one block which is sent to the specified receiver using the EVENTASK optional task.

Note: It is assumed that the user of the segment function provides the segments in the correct order and that the segment identification is unique within the NetView task.

6. If an internal error is found during processing of a segment request, such as a GETMAIN failure, all existing segments are deleted.
7. All CANCEL commands (initiated when TYPE=X is used) are logged together with their results. The CANCEL command is always successful. Users of the segment function are requested to use TYPE=X when applicable to prevent NetView from being filled with unused data.

EVESNCCI - NetView to CICS Communication Interface

8. The following matrix shows the required (R), optional (O), and invalid (¬) keywords for the various command types.

TYPE=	NAME	FUNC	DATA	OPID	DOMA	REQUI	SEGM	ID
C	R	R	O	O	O	¬	O _a	O _d
S	R	R	O	¬	¬	¬	O _a	O _d
R	R	R	O	¬	¬	R	O _a	O _d
N	R	R	O _b	¬	¬	R	¬	¬
A	R	R	¬	¬	¬	R	¬	¬
X	¬	¬	¬	¬	¬	¬	¬	R
none	¬	¬	O	¬	¬	¬	R _c	R _d

Notes:

- a. SEGMENT=F only can be used with these TYPEs.
 - b. The length of the data must be less than 101 bytes.
 - c. SEGMENT=M or SEGMENT=L can only be used when no TYPE is specified.
 - d. When a SEGMENT is specified, an ID must also be given.
9. EVESNCCI returns the following return codes and error messages to the caller. Some of the messages are written to the NetView log. Message EVE122E is also sent to the authorized receiver.

RC=0 EVE120I COMMAND ACCEPTED FOR *subsys*, APPLID = *applid*

The command has been forwarded to the EVENTASK optional task, where *subsys* is the symbolic name by which this CICS subsystem is known to CICS Automation, and *applid* is the generic VTAM application identifier of the target CICS subsystem.

RC=4 EVE121E ERROR ON DSI_{xxx} REQUEST IN EVESNCCI, RC=*ccc*

The command has not been forwarded to the EVENTASK optional task, where *xxx* identifies the DSI request (such as GET, FRE, FIND, PUSH, or POP), and *ccc* is the return code returned by the DSI_{xxx} function.

RC=8 EVE122E EVENTASK TASK NOT ACTIVE

The command has not been forwarded to the EVENTASK optional task.

RC=12 EVE123E INPUT ERROR AT DISPLACEMENT *ddd*, CODE=*ccc*

The command has not been forwarded to the EVENTASK optional task, where *ddd* contains the location in the command string where the error was detected, and *ccc* is one of the following:

- 004** Unrecognized keyword.
- 008** Syntax error.
- 012** Operand error.
- 016** Duplicate keyword.
- 020** Conflicting keyword.
- 024** Required keyword(s) omitted.
- 028** Incorrect data length. The data length on an ACK

EVESNCCI - NetView to CICS Communication Interface

response was not zero, or the data length on a NACK response was larger than 100 bytes.

RC=16

EVE124E SEGMENT ERROR, CODE = *ccc*

The command has not been forwarded to the EVENTASK optional task. All existing segments that have the current ID are deleted, except when the segment-chain was corrupted, where *ccc* is one of the following:

004 SEGMENT SEQUENCE ERROR. A middle or last segment has been offered while no first segment with an identical ID was available, or a first segment has been offered while another first segment with the same ID already exists.

008 TOO MUCH DATA. In a series of segments with identical ID the total amount of data exceeds 32656 bytes.

012 SEGMENT-CHAIN CORRUPTED. Storage used for saving segment data has been overwritten.

RC=20

EVE125E NO STORAGE AVAILABLE ON DSI_{xxx} REQUEST IN EVESNCCI

The command has not been forwarded to the EVENTASK optional task.

RC=24

ERROR ON EVESX_{mmm} CALL IN EVESNCCI, RC = *ccc*

The command has not been forwarded to the EVENTASK optional task. EVESNCCI calls the EVESX001 (CICSSEC) and EVESX022 (CICSQRY) command processors. A non-zero return code from either of these command processors results in this return code and error message. This error implies (normally) that either the caller is not authorized for the function on the specified subsystem, or the specified subsystem is not defined.

10. When other errors are detected during the processing of a CONVERSE request, CICS Automation program-to-program interface returns a NACK response to the requestor. The NACK response data indicates the type of error that occurred. The errors are also logged.

The following NACK responses can be expected:

EVE129E text

EVE122E *task* TASK NOT ACTIVE

EVE136E ERROR ON PPI REQUEST *rrr*, RC = *ccc*

EVE137E NETVIEW SUBSYSTEM NOT AVAILABLE

EVE141E INCORRECT MQS BUFFER RECEIVED IN *progrname*

EVE142E FUNCTION *funcname* NOT FOUND IN *membrname*

EVE171E *procname* : ERROR IN *progrname*(*tran*), CODE = *cccc*

EVE175E *procname* : FUNCTION *funcname* NOT FOUND IN EVESPINM

EVE181E *procname* : ERROR ON TRANSACTION START *tran* FOR FUNCTION *funcname*

Examples of Usage

Example 1

```
"EVESNCCI TYPE=C,"||,
  "NAME=CICS1,"||,
  "FUNC=CEMT,"||,
  "DATA='I PR(E*)'"
```

This command starts a CEMT transaction in the CICS *subsystem* known to CICS Automation as CICS1.

Example 2

```
"EVESNCCI TYPE=R,"||,
  "NAME=CICS2,"||,
  "FUNC=LMT,"||,
  "DATA=(1st segment of LMT response),"||,
  "REQID=1234567890123456,"||,
  "SEGMENT=F,"||,
  "ID=QAZWSXEDCRFVTGBY"

"EVESNCCI SEGMENT=M,"||,
  "DATA=(2nd segment of LMT response),"||,
  "ID=QAZWSXEDCRFVTGBY"

"EVESNCCI SEGMENT=L,"||,
  "DATA=(3rd segment of LMT response),"||,
  "ID=QAZWSXEDCRFVTGBY"
```

This is a link monitor response, which is in 3 segments. Error logic is not included.

EVESNRSP - Common Response Handler from CICS

EVESNRSP - Common Response Handler from CICS

The maximum length of a RESPONSE response line is 216 characters. EVESNRSP deblocks the response data in NetView and turns it into a multi-line WTO by calling the EVESX002 (CICSBMSG) command processor for each response line.

Comments and Usage Notes

1. The request data is scanned for the presence of NL (X'15') characters within the maximum response line length. If an NL character is found, it delimits the current response line. If no NL character is found, a maximum length response line is assumed, or the end of the response data delimits the current response line.

2. The following EVESX002 (CICSBMSG) commands are issued by EVESNRSP:

```
EVESX002 START,"domainid,opid
EVESX002 DATA,C,EVE790I PPI RESPONSE FROM applid FOR FUNCTION function maxln
totln
EVESX002 DATA,D,response line text
EVESX002 DATA,E,EVE792I END"
```

This results in the following multi-line WTO to be sent to *opid* on *domainid*:

```
EVE790I PPI RESPONSE FROM applid FOR FUNCTION function maxln totln
response line text
:
response line text
EVE792I END
```

where *maxln* and *totln* contain the maximum response line length and the total length of the RESPONSE response data sent to NetView.

3. The maximum value of the total response data length is 32656 bytes. If this number of bytes is sent on a CEMT response, the CEMT response may be truncated.
4. Errors found during EVESNRSP processing are logged. The following error messages may be displayed:

```
EVE121E ERROR ON DSIxxx REQUEST IN EVESNRSP, RC = ccc
EVE125E NO STORAGE AVAILABLE ON DSIxxx REQUEST IN EVESNRSP
EVE127E ERROR ON EVESX002 CALL IN EVESNRSP, RC = ccc
EVE141E INCORRECT MQS BUFFER RECEIVED IN EVESNRSP
```

EVESCCCI - CICS to NetView Communication Interface

Use this subroutine to request, from a CICS transaction, the initiation of a NetView command, a command list, or command processor in NetView. There are three types of EVESCCCI requests:

1. A CONVERSE request, which expects a response from NetView.
2. A SEND request, which does not expect a response from NetView.
3. RESPONSE.

The request is initiated by setting up a parameter list and linking to the EVESCCCI routine, as shown in the following assembler example:

EXEC CICS LINK PROGRAM(EVESCCCI) COMMAREA(*area*) LENGTH('60')

The parameter list is located in *area*. The following is an example of a parameter list built for a CONVERSE request (see Table 12 on page 143 for a SEND request parameter list example):

Table 10. EVESCCCI CONVERSE Request Parameter List

Name	Disp.	Length	Contents and description
OUTIDENT	000	08	"POUT0001"
OUTREQID	008	16	Not used (set by EVESCCCI)
OUTFNAME	024	08	<i>function</i>
OUTRTYPE	032	01	"C"
	033	01	Reserved (binary zeros)
OUTWAITC	034	02	CONVERSE wait time in seconds
OUTDATAL	036	04	Length of request data area (binary)
OUTDATAA	040	04	Address of request data area

Note: Sample copy books for this parameter list are included in the CICS Automation sample library. Refer to "EVEMPINT—EVESCCCI Parameter List Copy Book" on page 144 for field descriptions and important usage information.

If the request data address is located below the line, the response area (if any) is allocated below the line as well. If no data is passed on the CONVERSE request, the length field (OUTDATAL) must be zero. The address field is still used to determine the location of the response area in this case.

If the request is accepted, EVESCCCI sends the request to the NetView EVENTASK optional task, which translates the function into a command list or command processor.

EVESCCCI waits *nm* seconds (see OUTWAITC) for the response to arrive. If the OUTWAITC value is zero, the default wait time is 30 seconds. Valid specifications in the OUTWAITC field range from 1 up to and including 999 (seconds).

If the response does not arrive within the expected interval, the timeout return code is passed to the caller.

EVESCCCI - CICS to NetView Communication Interface

EVESCCCI returns the following fields to the caller of the CONVERSE request.

Table 11. EVESCCCI Fields Returned to Caller from CONVERSE Request

Name	Disp.	Length	Contents and description
OUTRESPA	044	4	Address of response area
OUTRESPL	048	4	Length of response area
OUTRTRNC	052	4	Binary return code: 0 Successful request 4 Timeout on CONVERSE 8 Program-to-program interface not available (see OUTABNDC for error code) 12 Incorrect parameter list 16 Internal processing error (see OUTABNDC for error code)
OUTABNDC	056	4	Error code (character) <ul style="list-style-type: none"> • OUTRTRNC = 8 <ul style="list-style-type: none"> C003 Program-to-program interface not active C015 CICS LOAD/LINK failure C017 No CICS storage available C2XX Program-to-program interface request error • OUTRTRNC = 16 <ul style="list-style-type: none"> A... CICS abend codes C012 CICS READQ failure C016 CICS POST failure C018 CICS FREEMAIN failure C960 Incorrect TS item length C961 RQE chain corrupted

Note: Refer to “EVEMPINT—EVESCCCI Parameter List Copy Book” on page 144 for field descriptions and important usage information.

The response area contains the response (if any) on the CONVERSE request. It may contain a RESPONSE, an ACK, or a NACK. The area has the format as described by the EVEMPINT copy book. **It is the responsibility of the caller of EVESCCCI to free the response area via EXEC CICS FREEMAIN.**

The response area format is similar to the transaction input data passed on a CONVERSE or SEND request from NetView:

Name	Disp.	Length	Contents and description
INTIDENT	000	08	“PINT0001”
INTREQID	008	16	<i>domainid opid</i>
INTFNAME	024	08	<i>function</i>
INTRTYPE	032	01	Response type: “R”, “A”, or “N”
	033	03	Reserved (binary zeros)
INTDATAL	036	04	Length of <i>data</i> (binary). Zero for ACK response
INTSDATA	040	<i>nn</i>	<i>data</i>

Errors found by EVESCCCI are returned to the caller via a return code and an error code. When other errors are detected during the processing of a CONVERSE request, CICS Automation returns a NACK response to the CICS transaction. The

EVESCCCI - CICS to NetView Communication Interface

NACK response data indicates the type of error that occurred. The NACK response is logged via message EVE180E. The following NACK responses can be expected:

```
EVE180E text
      EVE121E ERROR ON DISxxx REQUEST IN progname, RC = ccc
      EVE122E tttttttt TASK NOT ACTIVE
      EVE125E NO STORAGE AVAILABLE ON DSIxxx REQUEST IN progname
      EVE142E FUNCTION funcname NOT FOUND IN memname
```

The following is an example of a parameter list built by a SEND request:

Table 12. EVESCCCI SEND Request Parameter List

Name	Disp.	Length	Contents and description
OUTIDENT	000	08	"POUT0001"
OUTREQID	008	16	Not used (set by EVESCCCI)
OUTFNAME	024	08	<i>function</i>
OUTRTYPE	032	01	"S"
	033	01	Reserved (binary zeros)
	034	02	Not used for SEND (binary zeros)
OUTDATAL	036	04	Length of request data area (binary)
OUTDATAA	040	04	Address of request data area

Note: Refer to "EVEMPINT—EVESCCCI Parameter List Copy Book" on page 144 for field descriptions and important usage information.

If no data is passed on the SEND request, the length field (OUTDATAL) must be 0 (zero).

On a SEND request, errors found by EVESCCCI are returned to the caller via a return code and an error code. Other errors detected during the processing of a SEND request are not returned to the requestor. The errors are only logged.

EVEMPINT—EVESCCCI Parameter List Copy Book

EVEMPINT—EVESCCCI Parameter List Copy Book

The EVEMPINT copy book describes the CICS Automation program-to-program interface parameter list on the CICS side. It consists of two parts: one part describes the input data for CICS transactions, and the other part describes the format of output requests from CICS transactions.

The following data area is passed to a started CICS transaction as result of a NetView CONVERSE or SEND request. The same data area is passed in the response area as result of a NetView RESPONSE, ACK, or NACK response. See “EVESNCCI—NetView to CICS Communication Interface” on page 135.

Note: The started transaction must obtain the input data using an EXEC CICS RETRIEVE command.

Name	Disp.	Length	Contents and description
INTIDENT	000	08	Provides an eye-catcher and a block format level.
INTREQID	008	16	This field contains the request identifier which is used to relate a response to a specific request. For a CONVERSE request from NetView, it contains the <i>domainid</i> <i>opid</i> concatenation specified on the EVESNCCI command. For responses from NetView, it contains the request identifier allocated by the EVESCCCI routine on a CICS CONVERSE request. This field is not used for a SEND request.
INTFNAME	024	08	Contains the function name specified with the EVESNCCI FUNCTION= keyword.
INTRTYPE	032	01	The response type: C for CONVERSE, S for SEND, R for RESPONSE, A for ACK, and N for NACK.
	033	03	Reserved (binary zeros)
INTDATAL	036	04	Contains the length of the request or response data. This field may have a 0 (zero) value. For an ACK response, this field is 0 (zero).
INTSDATA	040	<i>nn</i>	The request or response data, if any. The length of the response data is contained in the INTDATAL field.

The following fields are set by the caller of the EVESCCCI routine.

Name	Disp.	Length	Contents and description
OUTIDENT	000	08	Provides an eye-catcher and a block format level. Must be set to POUT0001.
OUTREQID	008	16	This field is used as a request identifier to relate a response to a specific CONVERSE request. For CICS CONVERSE requests this field is set by the EVESCCCI routine. For CICS responses, the field must be set by the caller (copied from INTREQID). This field is not used for SEND requests.
OUTFNAME	024	08	Specifies the function name. The EVENTASK initialization member must contain a SERVER=REQUEST entry (for CONVERSE or SEND) or a SERVER=RESPONSE entry (for RESPONSE) specification. For responses, this field is normally copied from the transaction input data (INTFNAME field) Note: If the name is less than eight characters, pad it with blanks.

EVEMPINT—EVESCCCI Parameter List Copy Book

Name	Disp.	Length	Contents and description
OUTRTYPE	032	01	Specifies the type of command as REQUEST, SEND, RESPONSE, ACK, or NACK. REQUEST (also referred to as CONVERSE) and SEND are requests. RESPONSE, ACK, and NACK are responses. REQUEST starts a command processor or a command list in NetView. A response is expected. SEND also starts a command processor or a command list in NetView, but no response is expected. RESPONSE is used to send data to a NetView task. ACK signals the successful completion of a CONVERSE request. No data is provided. NACK signals the unsuccessful completion of a CONVERSE request. Data may optionally be provided (maximum of 100 bytes). It is recommended for health checking.
	033	01	Reserved (binary zeros)
OUTWAITC	034	02	Specifies the number of seconds (binary value) to wait for a response on a CONVERSE request. If the response does not arrive within the specified time interval, the timeout return code is passed to the caller. If binary zero is specified, the default wait interval (30 seconds) is used. The maximum binary value that can be specified is 999. The field must contain binary zeros for all requests other than CONVERSE.
OUTDATAL	036	04	This field must be set to the length of the CONVERSE or SEND request data area or to the length of the RESPONSE or NACK response area. The maximum length of a CONVERSE or SEND request area or a RESPONSE response area is 32656 bytes. The maximum length of a NACK response area is 100 bytes.
OUTDATAA	040	04	Specifies the address of the CONVERSE or SEND request area or the address of the RESPONSE or NACK response area. If the request data address is located below the line, the response area (if any) is allocated below the line as well. If no data is passed on the CONVERSE request, the length field (OUTDATAL) must be zero. The address field is still used to determine the location of the response area in this case.

The following fields are set by EVESCCCI upon return to the caller:

Name	Disp.	Length	Contents and description
OUTRESPA	044	04	Address of response area allocated by EVESCCCI. It may contain a RESPONSE, ACK, or NACK response. This field is only returned on a successful CONVERSE request (OUTRTRNC=0). It is the responsibility of the caller of EVESCCCI to free the response area using EXEC CICS FREEMAIN.
OUTRESPL	048	04	Contains the length of the response area addressed by the OUTRESPA field.
OUTRTRNC	052	04	Contains the return code which will have one of the following binary values: 000 Successful request. 004 Timeout on CONVERSE. 008 Program-to-program interface not available (see OUTABNDC for error codes). A transaction dump is provided depending on the error code. 012 Incorrect parameter list. No transaction dump is provided. 016 Internal processing error (see OUTABNDC for error codes). A transaction dump is provided.

EVEMPINT—EVESCCCI Parameter List Copy Book

Name	Disp.	Length	Contents and description
OUTABNDC	056	04	<p>This field contains an error code for return codes 008 and 016. For return code 008 the field will have one of the following character values:</p> <p>C003 The CICS component of the program-to-program interface is not active. Use the COPS transaction to start it. No transaction dump is provided. An error message is logged.</p> <p>C015 A CICS LOAD of or LINK to a required module was not successful. Ensure that EVESPERR and EVESPMMSG have been properly installed and are enabled. A transaction dump is provided. An error message is logged.</p> <p>C017 No CICS storage is available. No transaction dump is provided.</p> <p>C2xx A program-to-program interface request error occurred, where <i>xx</i> contains the program-to-program interface request return code. For error codes C220, C222, C223, C225, C231, C233, C236, C240, and C290, a transaction dump is provided and an error message is logged.</p> <p>For return code 016 the field will have one of the following character values:</p> <p>A*** A CICS abend has occurred. A transaction dump is provided. An error message is logged for most A*** errors.</p> <p>C012 An unexpected error has occurred on a READQ command. A transaction dump is provided. An error message is logged.</p> <p>C016 An unexpected error has occurred on a POST command. A transaction dump is provided. An error message is logged.</p> <p>C018 An unexpected error has occurred on a FREEMAIN command. A transaction dump is provided.</p> <p>C961 Internal error. Incorrect TS item length. A transaction dump is provided. An error message is logged.</p> <p>C962 Internal error. The RQE chain is corrupted. A transaction dump is provided. An error message is logged.</p>

When a RESPONSE response (R) is sent, *function* is used to locate the name of a command processor or command list in the EVENTASK initialization member. This command is scheduled under a task (also defined in the initialization member) with the following command text:

Name	Disp.	Length	Contents and description
	000	8	Command processor or command list name
	008	8	" " (8 blanks)
RHDRCVID	016	8	Program-to-program interface receiver identification
RHDSNDID	024	8	Generic applid (Program-to-program interface sender identification)
RHDPRCNM	032	8	Program-to-program interface sender's JOB- or STC-name
RHDDOMID	040	8	<i>domainid</i>
RHDTSKID	048	8	<i>opid</i>
RHDFNAME	056	8	<i>function</i>
RHDRTYPE	064	1	"R"
	065	7	"*****" (7 asterisks)
RHDSDATA	072	n	Response data (n = OUTDATAL)

A common response processor, EVESNRSP, is available that turns the response data into a multi-line WTO (EVE79xI), which is sent to *opid* in *domainid*.

Examples of Usage

Example 1

This assembler example shows the processing of a CICS CONVERSE request.

```

*****
*          ISSUE A CONVERSE REQUEST          *
*****
*
*      XC  CISPOUTP,CISPOUTP  ZERO PARAMETER LIST
*      LA  R6,CISPOUTP        ADDRESS PARAMETER LIST
*      USING OUTDSECT,R6      ESTABLISH ADDRESSABILITY
*      SPACE 1
*      MVC OUTIDENT,=C'POUT0001' SET EYE CATCHER/BLOCK LEVEL
*      MVC OUTFNAME,=CL8'TESTCLST' SET FUNCTION NAME
*      MVI OUTRTYPE,OUTRTYPC  SET CONVERSE REQUEST TYPE
*      LA  R1,L'CONVTEXT      LENGTH OF VARIABLE DATA
*      ST  R1,OUTDATAL        SET LENGTH OF VARIABLE DATA
*      LA  R1,CONVTEXT        ADDRESS OF VARIABLE DATA
*      ST  R1,OUTDATAA        SET ADDRESS OF CONVERSE DATA
*      MVC CISHWORD,=Y(OUTHL) LENGTH OF PARAMETER LIST
*
*      EXEC CICS LINK,        REQUEST PROGRAM LINK, TO          *
*      PROGRAM('EVESCCI'), CPDS COMMUNICATION INTERFACE      *
*      COMMAREA(CISPOUTP), PARAMETER LIST                    *
*      LENGTH(CISHWORD)  PARAMETER LIST LENGTH
*
*      L    R15,OUTRTRNC      PICK UP THE RETURN CODE
*      Process the return code and error code please!
*
*      L    R4,OUTRESPA       ADDRESS RESPONSE AREA
*      USING INTDSECT,R4      ESTABLISH ADDRESSABILITY
*
*      LA  R14,INTSDATA       ADDRESS RESPONSE DATA
*      L   R15,INTDATAL       LENGTH RESPONSE DATA
*      Do some meaningful processing please!
*
*      CONVTEXT DC  C'CONVERSE TEXT FROM CICS'
*
*      DFHEISTG ,
*
*      CISPOUTP DS  CL(OUTHL)  RESPONSE PARAMETER LIST
*      CISHWORD DS  H          PARAMETER BLOCK LENGTH
*
*      DFHEIEND ,
*
*      EVEMPINT ,            DEFINE INTERFACE DSECT

```

EVEMPINT—EVESCCCI Parameter List Copy Book

Example 2

This assembler example shows the processing of a NetView CONVERSE request in CICS.

```

*****
*      RETRIEVE TRANSACTION INPUT DATA      *
*****
*
*      EXEC  CICS RETRIEVE,      GET INPUT DATA      *
*            SET(R4),           RETURN ADDRESS HERE    *
*            LENGTH(CISHWORD)   RETURN LENGTH HERE    *
*
*      USING INTDSECT,R4      ESTABLISH ADDRESSABILITY
*
*      LA   R14,INTSDATA      ADDRESS REQUEST DATA
*      L    R15,INTDATAL     LENGTH REQUEST DATA
*      Do some meaningful processing please!
*
*****
*      RETURN A 'NORMAL' RESPONSE          *
*****
*
*      XC   CISPOUTP,CISPOUTP  ZERO PARAMETER LIST
*      LA   R6,CISPOUTP       ADDRESS PARAMETER LIST
*      USING OUTDSECT,R6      ESTABLISH ADDRESSABILITY
*
*      MVC  OUTIDENT,=C'POUT0001' SET EYE CATCHER/BLOCK LEVEL
*      MVC  OUTREQID,INTREQID  SET REQUEST IDENTIFIER
*      MVC  OUTFNAME,INTFNAME  SET FUNCTION NAME
*      MVI  OUTRTYPE,OUTRTPR  SET RESPONSE RESPONSE TYPE
*      LA   R1,L'RESPTEXT     LENGTH OF VARIABLE DATA
*      ST   R1,OUTDATAL       SET LENGTH OF VARIABLE DATA
*      LA   R1,RESPTEXT       ADDRESS OF VARIABLE DATA
*      ST   R1,OUTDATAA       SET ADDRESS OF RESPONSE DATA
*      MVC  CISHWORD,=Y(OUTHL) LENGTH OF PARAMETER LIST
*
*      EXEC  CICS LINK,        REQUEST PROGRAM LINK, TO   *
*            PROGRAM('EVESCCCI'), CPDS COMMUNICATION INTERFACE *
*            COMMAREA(CISPOUTP), PARAMETER LIST          *
*            LENGTH(CISHWORD)  PARAMETER LIST LENGTH    *
*
*      L    R15,OUTRTRNC      PICK UP THE RETURN CODE
*      Process the return code and error code please!
*
*      RESPTEXT DC  C'RESPONSE TEXT FROM CICS'
*
*      DFHEISTG ,
*
*      CISPOUTP DS  CL(OUTHL)  RESPONSE PARAMETER LIST
*      CISHWORD DS  H          LENGTH OF PARAMETER BLOCK
*
*      DFHEIEND ,
*
*      EVEMPINT ,           DEFINE INTERFACE DSECT

```

Glossary of CICS and Other Terms

This glossary defines special CICS terms used in the library and words used with other than their everyday meaning. In some cases, a definition may not be the only one applicable to a term, but gives the particular sense in which it is used in the CICS Automation library.

abend. Abnormal end of task.

ACB. Access method control block (VTAM and VSAM).

ACK. Acknowledgement.

APAR. Authorized program analysis report.

application program. (1) A program written for or by a user that applies to the user's work. (2) In data communication, a program used to connect and communicate with stations in a network, enabling users to perform application-oriented activities.

ASCII. American National Standard Code for Information Interchange.

batch. An accumulation of data to be processed.

CEC. Central Electronic Complex.

CEMT. The CICS master terminal transaction.

central electronic complex (CEC). A conglomeration of several processors and other devices in one or more physical units. This usually means several processors running under the control of a single MVS/ESA operating system. For example, a 3090 model 400 processor complex can run as a 4-processor CEC, or can be partitioned into the equivalent of two 3090 model 200s, each of which runs as a CEC with its own operating system.

CICS. Customer Information Control System.

command. In CICS, an instruction similar in format to a high-level programming language statement. (Contrast with macro.) CICS commands invariably include the verb EXECUTE (or EXEC). They may be issued by an application program to make use of CICS facilities.

command-language statement. In CICS, synonym for command.

concurrent. Pertaining to the occurrence of two or more activities within a given interval of time.

data security. The protection of data against unauthorized disclosure, transfer, modifications, or destruction, whether accidental or intentional.

data set. The major unit of data storage and retrieval, consisting of a collection of data in one of several prescribed arrangements and described by control information to which the system has access.

end user. In CICS, anyone using CICS to do a job, usually by interacting with an application program (transaction) by means of a terminal.

exception. An abnormal condition such as an I/O error encountered in processing a data set or a file, or using any resource.

initial program load (IPL). The initialization procedure that causes an operating system to commence operation.

initialization. (1) Actions performed by CICS to construct the environment in the CICS region to enable CICS applications to be run. (2) A process started by SA OS/390 and CICS Automation to construct the environment in which automation is to occur.

installation. (1) A particular computing system, in terms of the work it does and the people who manage it, operate it, apply it to problems, service it and use the work it produces. (2) The task of making a program ready to do useful work. This task includes generating a program, initializing it, and applying PTFs to it.

intercommunication facilities. A generic term covering intersystem communication (ISC) and multiregion operation (MRO).

interregion communication (IRC). The method by which CICS provides communication between a CICS region and another region in the same processor. Used for multiregion operation.

intersystem communication (ISC). Communication between separate systems by means of SNA networking facilities or by means of the application-to-application facilities of an SNA access method. ISC links CICS systems, and may be used for user application to user application communication, or for transparently executing CICS functions on a remote CICS system.

IPL. Initial Program Load.

IRC. Interregion communication.

ISC. Intersystem communication.

keyword. (1) A symbol that identifies a parameter. (2) A part of a command operand that consists of a specific

character string. (3) An operand in a CEDDA definition. Key-sequenced data set—a VSAM database organization.

local. In data communication, pertaining to devices that are attached to a controlling unit by cables, rather than data links.

local device. A device, such as a terminal, whose control unit is directly attached to a computer's data channel. No data link or control unit is used. Contrast with remote device.

local system. In CICS intercommunication, the CICS system from whose point-of-view intercommunication is being discussed.

NACK. Negative Acknowledgement.

network. (1) An interconnected group of nodes. (2) The assembly of equipment through which connections are made between data stations.

network configuration. In SNA, the group of links, nodes, machine features, devices, and programs that make up a data processing system, a network, or a communication system.

online. (1) Pertaining to a user's ability to interact with a computer. (2) Pertaining to a user's access to a computer via a terminal.

operating system. Software that controls the execution of programs; an operating system may provide services such as resource allocation, scheduling, input/output control, and data management.

parameter. (ISO) A variable that is given a constant value for a specified application and that may denote the application.

processor. (ISO) In a computer, a functional unit that interprets and executes instructions.

program temporary fix (PTF). A temporary solution or by-pass of a problem diagnosed by IBM field engineering as the result of a defect in a current unaltered release of the program.

PTF. Program Temporary Fix.

PUT. Program update tape.

recovery routine. A routine that is entered when an error occurs during the performance of an associated operation. It isolates the error, assesses the extent of the error, and attempts to correct the error and resume operation.

remote. In data communication, pertaining to devices that are connected to a data processing system through a data link.

remote device. A device, such as a terminal, connected to a data processing system through a data link.

remote system. In CICS intercommunication, a system that the local CICS system accesses via intersystem communication or multiregion operation.

resource. Any facility of the computing system or operating system required by a job or task, and including main storage, input/output devices, the processing unit, data sets, and control or processing programs.

security. Prevention of access to or use of data or programs without authorization.

service. The carrying out of effective problem determination, diagnosis, and repair on a data processing system or software product.

SIT. System Initialization Table.

SNA. Systems Network Architecture.

software. (ISO) Programs, procedures, rules, and any associated documentation pertaining to the operation of a computer.

startup. The operation of starting up CICS by the system operator.

subsystem. (1) A secondary or subordinate system. (2) A resource defined to SA OS/390 and CICS Automation.

system. In CICS, an assembly of hardware and software capable of providing the facilities of CICS for a particular installation.

system initialization table (SIT). A table containing user-specified data that will control a system initialization process.

systems network architecture (SNA). The description of the logical structure, formats, protocols, and operational sequences for transmitting information units through and controlling the configuration and operation of networks.

task. (1) (ISO) A basic unit of work to be accomplished by a computer. (2) Under CICS, the execution of a transaction for a particular user.

terminal. (1) A point in a system or communication network at which data can either enter or leave. (2) In CICS, a device, often equipped with a keyboard and some kind of display, capable of sending and receiving information over a communication channel.

terminal operator. The user of a terminal.

transaction. A transaction may be regarded as a unit of processing (consisting of one or more application programs) initiated by a single request, often from a

terminal. A transaction may require the initiation of one or more tasks for its execution.

update. To modify a file with current information.

VTAM. An acronym for the Virtual Telecommunications Access Method. This is one of the ways CICS communicates with terminals.

Index

A

ABCODEPROG 48
ABCODETRAN 31, 50
abend codes 31
ACK response 128
application groups
 BASIC 9
 defined 8
 MOVE 9
 nesting of 9
 SERVER 9
application samples 17
applications
 policy items
 CICS CONNECTION 35
 CICS CONTROL 13, 18, 108
 MESSAGES/USER DATA 28, 41
 MINOR RESOURCE FLAGS 28
 RESOURCE THRESHOLDS 28, 30
 STARTUP 18, 108
 STATE ACTION TABLE 32
automation
 goal-driven 4
 operators 17

B

broadcasting messages 119

C

CANCEL
 from NetView 130
CEMTPPI 39
CEMTPPI—CEMT PPI short syntax 69
CICS Automation panels
 Broadcast Messages panel 119
 CICS Monitor 123
 Display Links 112
 Health Checking 116
 Link Monitoring 111
 main menu 103
 Messages 124
 Monitoring 111
CICS receiver program 128
CICSDLY—Change the shutdown delay time 70
CICSHLTH—Linemode health checking 80
CICSINFO 60
CICSLM—Linemode link monitor 84
CICSMHDR—Linemode message options 87
CICSOVRD—Linemode SIT override 82
CICSplex SM address space (CMAS) 23
CICSplex SM REXX API
 installing 19
CICSPPOST—Post an external event 71
CICSPURG—Purge transactions 72

CICSQRY—Name lookup 63
CICSRCMD—Request a CICS Function 66
CICRSYC—CICS resync 73
CICSSHUT—Shutdown processor 74
CMASSHUT—CICSplex SM Address Space (CMAS) shutdown 89
coexistence 26
cold start indicator 26
commands
 CEMTPPI 69
 CICSDLY 70
 CICSHLTH 80
 CICSLM 84
 CICSMHDR 87
 CICSOVRD 82
 CICSPPOST 71
 CICSPURG 72
 CICSQRY 63
 CICSRCMD 66
 CICRSYC 73
 CICSSHUT 74
 CMASSHUT 89
 EVEED003 76
 EVEEMIGR 78
 EVEERDMP 77
 EVEEY00S 33, 79
 INGCICS 90
conflicting requests 6
CONVERSE
 from CICS 131
 from NetView 128
coordinating address space (CAS) 23
COPC 13
CPSM alerts 40
critical messages 27

D

dependencies
 start 4
 stop 4
DISPTRG 104
documents, licensed xv
dump 77

E

echoplexing 35
 back-end programs 21
 CICS target system 35
 IMS target system 35
entry (*see* policy object) 3
entry type 3
EVEED003—Critical message handler for the Status Display Facility 76
EVEEMIGR—Migrate subsystem to CICS/TS 78
EVEERDMP—CICS dump 77

EVEEY00S—Common State Handler for State/Action Tables 33, 79
EVEMPINT—EVESCCCI parameter list copy book 144
EVENTASK 13, 19, 94
EVESCCCI - CICS to NetView communication interface 141
EVESCMT3 - message exit table for CICS 21
EVESCMT3—Message exit table for CICS 96
EVESCMT4—XTDOUT exit table for CICS 21
EVESCMT4—XTDOUT exit table for CICS 98
EVESNCCI—NetView to CICS Communication Interface 135
EVESNPPI 128
EVESNRSP - Common response handler from CICS 140
EVESPINM 20, 92
EVESPPIC 128

G

goal 4
goal-driven automation 4

H

health checking 11, 33, 115
 programs 20
HEALTHCHK 52

I

INGCICS 90
INGEVENT 38, 71
INGREQ 39, 107
 Appl Parms field 108
 Override field 108
 Type field 107
INGSCHED 104
ISSUECMD 10

L

licensed documents xv
link monitoring 11, 35, 111
 access from CICS 111
 access from CICS Automation 111
 display links 112
 echoplexing 35
 CICS target system 35
 IMS target system 35
LISTSHUT 54
local functions 36
LookAt message retrieval tool xv

M

- main menu 103
- MAT (*see* NetView message automation table) 9
- message retrieval tool, LookAt xiv
- messages
 - broadcasting 119
- messages, critical 27
- MESSAGES/USER DATA keywords
 - ABCODEPROG 48
 - ABCODETRAN 31, 50
 - ACORESTART 18
 - format descriptions 41
 - notational conventions 43, 44
 - translation rule 42
 - HEALTHCHK 34, 52
 - LISTSHUT 54
 - RCVAUTO 55
 - RCVRSOS 56
 - RCVRTRAN 32, 58
 - RCVRVIOL 59
- MESSAGES/USER DATA policy item 41
 - attributes 41
 - CMD 42
 - CODE 45
 - others 44
- migration 24
- minor resources
 - definitions for component recovery 28

N

- NACK response 128
- NetView message automation table 9
- NetView subtask program 128
- NMC display support 125
- notational conventions
 - for CMD, REP, CODE attributes 43
 - for USER type attributes 44
 - general xi

P

- persistence of requests 6
- policy item 3
- policy object 3
 - MESSAGES/USER DATA policy item 10
- policy objects
 - CICS LINK 35
 - CICS STATE/ACTION 32
 - MONITORING PERIOD 35
 - STATUS DETAILS 27
- PPI (*see* program-to-program interface) 13
- PPI receiver task 22, 23
- program-to-program interface 13
 - CICS components 13
 - CICS requests 131
 - CONVERSE 131
 - SEND 132
 - communication components 13
 - EVENTASK 13, 19, 94
 - EVESPINM 92
 - customization 20

- program-to-program interface (*continued*)
 - NetView requests 128
 - CANCEL 130
 - CONVERSE 128
 - SEND 129

R

- RACF-protected subsystems 39
- RCVAUTO 55
- RCVRSOS 56
- RCVRTRAN 32, 58
- RCVRVIOL 59
- recovery 13
 - abend codes 31
 - autoinstall problems 28
 - minor resources 29
 - RCVRTRAN 32
 - short-on-storage condition 28
 - storage violations 28
 - thresholds 30
 - transactions 29
 - VTAM ACB failures 28
- remote site recovery
 - for VSAM RLS 39
- requests 4
 - conflicting 6
 - persistence of 6
 - priority 4, 6, 8
 - propagation 4
- RESPONSE response 128

S

- SA OS/390 definitions for CICS 17
- SA OS/390 operator commands
 - DISPTRG 104
 - INGEVENT 38, 71
 - INGREQ 39, 107
 - INGSCHED 104
- SDF (*see* status display facility) 121
- SDF states 27
- security checking 21, 35
- segment support in NetView 136
- SEND
 - from CICS 132
 - from NetView 129
- service periods 8
- service windows 8
- short-on-storage 27
- start dependencies 4
- startup
 - types 26, 107
- state/action tables 11, 32
 - area 33
 - default tables 33
 - product 33
- status display facility 121
 - states 27
- status file record
 - creation for new subsystem 19
- stop dependencies 4
- storage violations 27
- subsystems
 - creating status file record 19
 - monitoring 111

- subsystems (*continued*)
 - name length 18
 - RACF protection 39
 - selecting 104
 - shutting down 109
 - starting 107
- system initialization table 22, 36

T

- thresholds for recovery 28
- timers 27
- trace function 26
- transactions
 - recovery 29
- transient data messages
 - EVESCMT3 21
 - EVESCMT4 21
- triggers 7
 - events 7
 - shutdown conditions 7
 - startup conditions 7

V

- VSAM RLS 39
- VTAM ACM errors 27

Readers' Comments — We'd Like to Hear from You

System Automation for OS/390
CICS Automation
Programmer's Reference
and Operator's Guide
Version 2 Release 2

Publication No. SC33-7044-03

Overall, how satisfied are you with the information in this book?

	Very Satisfied	Satisfied	Neutral	Dissatisfied	Very Dissatisfied
Overall satisfaction	<input type="checkbox"/>	<input type="checkbox"/>	<input type="checkbox"/>	<input type="checkbox"/>	<input type="checkbox"/>

How satisfied are you that the information in this book is:

	Very Satisfied	Satisfied	Neutral	Dissatisfied	Very Dissatisfied
Accurate	<input type="checkbox"/>	<input type="checkbox"/>	<input type="checkbox"/>	<input type="checkbox"/>	<input type="checkbox"/>
Complete	<input type="checkbox"/>	<input type="checkbox"/>	<input type="checkbox"/>	<input type="checkbox"/>	<input type="checkbox"/>
Easy to find	<input type="checkbox"/>	<input type="checkbox"/>	<input type="checkbox"/>	<input type="checkbox"/>	<input type="checkbox"/>
Easy to understand	<input type="checkbox"/>	<input type="checkbox"/>	<input type="checkbox"/>	<input type="checkbox"/>	<input type="checkbox"/>
Well organized	<input type="checkbox"/>	<input type="checkbox"/>	<input type="checkbox"/>	<input type="checkbox"/>	<input type="checkbox"/>
Applicable to your tasks	<input type="checkbox"/>	<input type="checkbox"/>	<input type="checkbox"/>	<input type="checkbox"/>	<input type="checkbox"/>

Please tell us how we can improve this book:

Thank you for your responses. May we contact you? Yes No

When you send comments to IBM, you grant IBM a nonexclusive right to use or distribute your comments in any way it believes appropriate without incurring any obligation to you.

Name

Address

Company or Organization

Phone No.



Fold and Tape

Please do not staple

Fold and Tape



NO POSTAGE
NECESSARY
IF MAILED IN THE
UNITED STATES

BUSINESS REPLY MAIL

FIRST-CLASS MAIL PERMIT NO. 40 ARMONK, NEW YORK

POSTAGE WILL BE PAID BY ADDRESSEE

IBM Deutschland Entwicklung GmbH
Department 3248
Schönaicher Strasse 220
D-71032 Böblingen
Federal Republic of Germany
72031-0000



Fold and Tape

Please do not staple

Fold and Tape



Program Number: 5645-006

Printed in U.S.A.

SC33-7044-03

