

System Automation for OS/390



Programmer's Reference

Version 2 Release 2

System Automation for OS/390



Programmer's Reference

Version 2 Release 2

Note!

Before using this information and the product it supports, be sure to read the general information under "Notices" on page ix.

Tenth Edition (July 2003)

This edition applies to System Automation for OS/390 Version 2 Release 2 (5645-006), an IBM licensed program, and to all subsequent releases and modifications until otherwise indicated in new editions or technical newsletters.

Order publications through your IBM representative or the IBM branch office serving your locality. Publications are not stocked at the address given below.

A form for readers' comments appears at the back of this publication. If the form has been removed, address your comments to:

IBM Deutschland Entwicklung GmbH
Department 3248
Schoenaicher Strasse 220
D-71032 Boeblingen
Federal Republic of Germany

FAX: (Germany): 07031+16-3456

FAX: (Other countries): (+49)+7031-16-3456

Internet e-mail: s390id@de.ibm.com

When you send information to IBM, you grant IBM a nonexclusive right to use or distribute the information in any way it believes appropriate without incurring any obligation to you.

© Copyright International Business Machines Corporation 1996, 2003. All rights reserved.

US Government Users Restricted Rights – Use, duplication or disclosure restricted by GSA ADP Schedule Contract with IBM Corp.

Contents

Figures	v
--------------------------	----------

Tables	vii
-------------------------	------------

Notices	ix
--------------------------	-----------

Programming Interface Information	ix
Trademarks	ix

About This Book.	xi
---------------------------------	-----------

Who Should Use This Book	xi
Where to Find More Information	xi

Part 1. Introduction 1

Chapter 1. Introduction 3

Overview of Commands	3
Format of Syntax Diagrams	3

Part 2. SA OS/390 System Operations — Common Routines . . . 5

Chapter 2. Common Routines 7

Using System Operations Common Routines for Programming	7
ACF	7
ACFCMD	13
ACFFQRY	21
ACFREP	28
AOCGETCN	35
AOCMSG	36
AOCQRES.	41
AOCQRY	42
AOCUPDT	56
AOFADMON.	60
AOFAJMON	61
AOFAPMON	62
AOFATMON	62
AOFCPMSG	63
AOFCPSM.	65
AOFEXCMD	66
AOFTREE	67
AOFUXMON.	71
ASF	72
ASFUSER	77
CDEMATCH	80
CHKSUBS.	85
CHKTHRES	86
INGPOST	89
INGPW.	94
INGRCLUP	98
INGRTCMD	98
INGSTOBS	99
INGUSS	101

ISQMTSYS	103
MDFYSHUT.	103

Part 3. SA OS/390 System Operations — Generic Routines . . . 105

Chapter 3. Generic Routines 107

Using SA OS/390 Generic Routines for Programming	107
ACTIVMSG	107
AOCFILT.	109
FWDMSG	111
HALTMSG	112
ISSUECMD	114
ISSUEREP	118
OUTREP	123
TERMMSG	126

Part 4. SA OS/390 I/O Operations Commands (API) 131

Chapter 4. I/O Operations Commands (API) 133

Using I/O Operations Commands for Programming	133
FICON Switches	134
FICON Cascaded Switches	135
Common Parameters	135
DELETE FILE	141
QUERY ENTITY CHP	141
QUERY ENTITY CNTLUNIT	146
QUERY ENTITY DEV	149
QUERY ENTITY HOST	152
QUERY ENTITY SWITCH	157
QUERY FILE	160
QUERY INTERFACE CNTLUNIT.	162
QUERY INTERFACE SWITCH	168
QUERY RELATION CHP	176
QUERY RELATION CNTLUNIT	178
QUERY RELATION DEV	180
QUERY RELATION HOST	188
QUERY RELATION SWITCH	190
QUERY SWITCH	193
REMOVE and RESTORE CHP.	196
REMOVE and RESTORE DEV.	199
WRITEFILE	205
WRITEPORT	207
WRITESWCH	211

Part 5. Status Display Facility Definitions 219

Chapter 5. SDF Initialization

Parameters 221

DCOLOR	221
DPFKnn	222
DPFKDESC1	223
DPFKDESC2	224
EMPTYCOLOR	224
ERRCOLOR	225
INITSCRN	226
MAXOPS	226
PFKnn	227
PRIORITY	228
PRITBSZ	230
PROPDOWN	230
PROPUP	231
SCREENSZ	231
TEMPERR	231

Chapter 6. SDF Definition Statements 233

AOFTREE	233
PANEL	236

STATUSFIELD	237
STATUSTEXT	240
TEXTFIELD	241
TEXTTEXT	243
PFKnn	244
ENDPANEL	245
Example SDF Definition	245

Chapter 7. SDF Commands 253

SDFTREE	253
SDFPANEL	254
SCREEN	255

Appendix. Invoking I/O Operations By a REXX EXEC 259

Rules for Calls by a REXX EXEC	259
--	-----

Glossary 267

Index 287

Figures

1. Flag Automation Specification Sample Panel	12	15. DISPACF Command Dialog Panel	130
2. Automation Disable Sample Panel	12	16. QUERY SWITCH Command - Sample Output	196
3. DISPFLGS Sample Panel	52	17. Example Tree Structure Definitions: System SY1	235
4. DISPACF Sample Panel	53	18. Example Tree Structure Definitions: System SY2	235
5. DISPINFO Sample Panel Showing Captured Messages	65	19. SDF Example: Tree Structure Definition for SY1	246
6. Subsystem Dependent Tree	67	20. SDF Example: Hierarchy Defined by SY1 Tree Structure	246
7. Message Processing Sample Panel	82	21. SDF Example: System Panel Definition Statements	247
8. Code Processing Sample Panel	82	22. SDF Example: Status Component Panel Definition Statements for SY1SYS	249
9. INGPW Example	96	23. Sample SY1 SDF Panel	250
10. INGPW Shared SAF Database Example	97	24. Default Values for SDF Displays	252
11. DISPACF Sample Panel	117		
12. SA OS/390 Policy Selection Panel	121		
13. Code Processing Panel for an Application Resource	124		
14. Code Processing Panel for the MVSESA Resource	125		

Tables

1. System Automation for OS/390 Library	xi	9. Code Match Actions for OUTREP.	124
2. Related Products Books	xii	10. TERMMSG Status Transitions	126
3. Overview of Commands	3	11. Standard SA OS/390 Array Format	137
4. Output from ACFFQRY	23	12. Standard SA OS/390 Array Format for QUERY ENTITY HOST	154
5. AOCQRY Subsystem TGLOBALs	48	13. Variables for the DPFknn Command	223
6. AOCQRY Parent TGLOBALs.	49	14. Variables for the PFKnn Command	227
7. AOCQRY Automation Flag TGLOBALs	51	15. Variables for PF Keys	244
8. Exits and associated resources	100		

Notices

References in this publication to IBM[®] products, programs, or services do not imply that IBM intends to make these available in all countries in which IBM operates. Any reference to an IBM product, program, or service is not intended to state or imply that only IBM product, program, or service may be used. Subject to IBM's valid intellectual property or other legally protectable rights, any functionally equivalent product, program, or service may be used instead of the IBM product, program, or service. The evaluation and verification of operation in conjunction with other products, except those expressly designated by IBM, are the responsibility of the user.

IBM may have patents or pending patent applications covering subject matter in this document. The furnishing of this document does not give you any license to these patents. You can send license inquiries, in writing, to:

IBM Director of Licensing
IBM Corporation
North Castle Drive
Armonk, NY 10504-1785
USA

Licensees of this program who wish to have information about it for the purpose of enabling: (i) the exchange of information between independently created programs and other programs (including this one) and (ii) the mutual use of the information which has been exchanged, should contact:

IBM Deutschland Entwicklung GmbH
Department 3248
Schoenaicher Strasse 220
D-71032 Boeblingen
Federal Republic of Germany

Such information may be available, subject to appropriate terms and conditions, including in some cases, payment of a fee.

Any pointers in this publication to non-IBM web sites are provided for convenience only, and do not in any manner serve as an endorsement of these web sites. IBM accepts no responsibility for the content or use of non-IBM web sites specifically mentioned in this publication or accessed through an IBM web site that is mentioned in this publication.

Programming Interface Information

This book documents programming interfaces that allow the customer to write programs to obtain the services of System Automation for OS/390[®].

Trademarks

The following terms, used in this book, are trademarks of the IBM Corporation in the United States or other countries:

CICS	OS/390
DB2	RACF
ESCON	RMF

IBM	SP
IMS/ESA	S/390
Micro Channel	System/390
MVS	VTAM
MVS/ESA	3090
NetView	

C-bus is a trademark of Corollary, Inc. in the United States, other countries, or both.

Java and all Java-based trademarks are trademarks of Sun Microsystems, Inc. in the United States, other countries, or both.

Microsoft, Windows, Windows NT, and the Windows logo are trademarks of Microsoft Corporation in the United States, other countries, or both.

NetView is a trademark of Tivoli Systems Inc. in the United States, or other countries, or both.

PC Direct is a trademark of Ziff Communications Company in the United States, other countries, or both and is used by IBM Corporation under license.

UNIX is a registered trademark in the United States and other countries licensed exclusively through The Open Group.

About This Book

This book describes the programming interfaces of System Automation for OS/390. It provides detailed reference material you need to operate, maintain and program for System Automation for OS/390.

The sample material in this book is based on System Automation for OS/390 running on NetView[®] V1R4.

Throughout this publication references to MVS[™] refer either to MVS/ESA[™], or to the MVS element of OS/390.

Who Should Use This Book

This information is primarily for system programmers and automation programmers, but may also be useful for others, for example, help desk personnel and customer engineers.

Where to Find More Information

The System Automation for OS/390 Library

The following table shows the information units in the System Automation for OS/390 library:

Table 1. System Automation for OS/390 Library

Title	Order Number
<i>System Automation for OS/390 Planning and Installation</i>	SC33-7038
<i>System Automation for OS/390 Customizing and Programming</i>	SC33-7035
<i>System Automation for OS/390 Defining Automation Policy</i>	SC33-7039
<i>System Automation for OS/390 User's Guide</i>	SC33-7040
<i>System Automation for OS/390 Messages and Codes</i>	SC33-7041
<i>System Automation for OS/390 Operator's Commands</i>	SC33-7042
<i>System Automation for OS/390 Programmer's Reference</i>	SC33-7043
<i>System Automation for OS/390 CICS Automation Programmer's Reference and Operator's Guide</i>	SC33-7044
<i>System Automation for OS/390 IMS Automation Programmer's Reference and Operator's Guide</i>	SC33-7045
<i>System Automation for OS/390 OPC Automation Programmer's Reference and Operator's Guide</i>	SC23-7046
<i>System Automation for OS/390 Licensed Program Specifications</i>	SC33-7037

The System Automation for OS/390 books (except Licensed Program Specifications) are also available on CD-ROM as part of the following collection kit:
IBM Online Library z/OS Software Products Collection (SK3T-4270)

SA OS/390 Homepage

For the latest news on SA OS/390, visit the SA OS/390 homepage at <http://www.ibm.com/servers/eserver/zseries/software/sa>

Related Product Information

The following table shows the books in the related product libraries that you may find useful for support of the SA OS/390 base program.

Table 2. Related Products Books

Title	Order Number
<i>ISPF User's Guide</i>	SC34-4484
<i>ISPF Dialog Management Guide and Reference</i>	SC34-4266
<i>MVS/ESA MVS Configuration Program Guide and Reference</i>	GC28-1817
<i>MVS/ESA Planning: Dynamic I/O Configuration</i>	GC28-1674
<i>MVS/ESA Support for the Enterprise Systems Connection</i>	GC28-1140
<i>MVS/ESA Planning: APPC Management</i>	GC28-1110
<i>MVS/ESA Application Development Macro Reference</i>	GC28-1822
<i>OS/390: MVS System Commands</i>	GC28-1781
<i>MVS/ESA SPL Application Development Macro Reference</i>	GC28-1857
<i>OS/390 Hardware Configuration Definition: User's Guide</i>	SC28-1848
<i>OS/390 Information Roadmap</i>	GC28-1727
<i>OS/390 Information Transformation</i>	GC28-1985
<i>OS/390 Introduction and Release Guide</i>	GC28-1725
<i>OS/390 JES Commands Summary</i>	GX22-0041
<i>OS/390 Licensed Program Specifications</i>	GC28-1728
<i>OS/390 Printing Softcopy Books</i>	S544-5354
<i>OS/390 Starting Up a Sysplex</i>	GC28-1779
<i>OS/390 Up and Running!</i>	GC28-1726
<i>Planning for the 9032 Model 3 and 9033 Enterprise Systems Connection Director</i>	SA26-6100
<i>Resource Access Control Facility (RACF) Command Language Reference</i>	SC28-0733
<i>S/390 MVS Sysplex Overview – An Introduction to Data Sharing and Parallelism</i>	GC23-1208
<i>S/390 MVS Sysplex Systems Management</i>	GC23-1209
<i>S/390 Sysplex Hardware and Software Migration</i>	GC23-1210
<i>S/390 MVS Sysplex Application Migration</i>	GC23-1211
<i>S/390 Managing Your Processors</i>	GC38-0452
<i>Tivoli/Enterprise Console User's Guide Volume I</i>	GC31-8334
<i>Tivoli/Enterprise Console User's Guide Volume II</i>	GC31-8335
<i>Tivoli/Enterprise Console Event Integration Facility Guide</i>	GC31-8337
<i>Tivoli NetView for OS/390 Administration Reference</i>	SC31-8222
<i>Tivoli NetView for OS/390 Application Programming Guide</i>	SC31-8223

Table 2. Related Products Books (continued)

Title	Order Number
<i>Tivoli NetView for OS/390 APPN Topology and Accounting Agent</i>	SC31-8224
<i>Tivoli NetView for OS/390 Automation Guide</i>	SC31-8225
<i>Tivoli NetView for OS/390 AON Customization Guide</i>	SC31-8662
<i>Tivoli NetView for OS/390 AON User's Guide</i>	GC31-8661
<i>Tivoli NetView for OS/390 Bridge Implementation</i>	SC31-8238
<i>Tivoli NetView for OS/390 Command Reference Vol. 1</i>	SC31-8227
<i>Tivoli NetView for OS/390 Command Reference Vol. 2</i>	SC31-8735
<i>Tivoli NetView for OS/390 Customization Guide</i>	SC31-8228
<i>Tivoli NetView for OS/390 Customization: Using Assembler</i>	SC31-8229
<i>Tivoli NetView for OS/390 Customization: Using Pipes</i>	SC31-8248
<i>Tivoli NetView for OS/390 Customization: Using PL/I and C</i>	SC31-8230
<i>Tivoli NetView for OS/390 Customization: Using REXX and CLIST Language</i>	SC31-8231
<i>Tivoli NetView for OS/390 Data Mode Reference</i>	SC31-8232
<i>Tivoli NetView for OS/390 Installation: Getting Started</i>	SC31-8767
<i>Tivoli NetView for OS/390 Installation: Migration Guide</i>	SC31-8768
<i>Tivoli NetView for OS/390 Installation: Configuring Graphical Components</i>	SC31-8770
<i>Tivoli NetView for OS/390 Installation: Configuring Additional Components</i>	SC31-8769
<i>Tivoli NetView for OS/390 Messages and Codes</i>	SC31-8237
<i>Tivoli NetView for OS/390 MultiSystem Manager User's Guide</i>	SC31-8607
<i>Tivoli NetView for OS/390 NetView Management Console User's Guide</i>	GC31-8665
<i>Tivoli NetView for OS/390 User's Guide</i>	SC31-8241
<i>Tivoli NetView for OS/390 RODM and GMFHS Programming Guide</i>	SC31-8233
<i>Tivoli NetView for OS/390 Security Reference</i>	SC31-8606
<i>Tivoli NetView for OS/390 SNA Topology Manager and APPN Accounting Manager Implementation Guide</i>	SC31-8239
<i>Tivoli Management Platform Reference Guide</i>	GC31-8324
<i>TSO/E REXX/MVS User's Guide</i>	SC28-1882
<i>TSO/E REXX/MVS Reference</i>	SC28-1883
<i>VM/XA SP GCS Command and Macro Reference</i>	SC23-0433
<i>VSE/SP Unattended Node Support</i>	SC33-6412
<i>VTAM Messages and Codes</i>	SC31-6493
<i>VTAM Network Implementation Guide</i>	SC31-6404
<i>VTAM Network Implementation Guide</i>	SC31-6434

Using LookAt to look up message explanations

LookAt is an online facility that lets you look up explanations for most messages you encounter, as well as for some system abends and codes. Using LookAt to find information is faster than a conventional search because in most cases LookAt goes directly to the message explanation.

You can access LookAt from the Internet at:
<http://www.ibm.com/eserver/zseries/zos/bkserv/lookat/> or from anywhere in z/OS or z/OS.e where you can access a TSO/E command line (for example, TSO/E prompt, ISPF, z/OS UNIX System Services running OMVS).

The LookAt Web site also features a mobile edition of LookAt for devices such as Pocket PCs, Palm OS, or Linux-based handhelds. So, if you have a handheld device with wireless access and an Internet browser, you can now access LookAt message information from almost anywhere.

To use LookAt as a TSO/E command, you must have LookAt installed on your host system. You can obtain the LookAt code for TSO/E from a disk on your z/OS *Collection* (SK3T-4269) or from the LookAt Web site's **Download** link.

Accessing z/OS™ licensed documents on the Internet

z/OS licensed documentation is available on the Internet in PDF format at the IBM Resource Link™ Web site at:

<http://www.ibm.com/servers/resourceLink>

Licensed documents are available only to customers with a z/OS license. Access to these documents requires an IBM Resource Link user ID and password, and a key code. With your z/OS order you received a Memo to Licensees, (GI10-0671), that includes this key code.¹

To obtain your IBM Resource Link user ID and password, log on to:

<http://www.ibm.com/servers/resourceLink>

To register for access to the z/OS licensed documents:

1. Sign in to Resource Link using your Resource Link user ID and password.
2. Select **User Profiles** located on the left-hand navigation bar.

Note: You cannot access the z/OS licensed documents unless you have registered for access to them and received an e-mail confirmation informing you that your request has been processed.

Printed licensed documents are not available from IBM.

You can use the PDF format on either **z/OS Licensed Product Library CD-ROM** or IBM Resource Link to print licensed documents.

1. z/OS.e™ customers received a Memo to Licensees, (GI10-0684) that includes this key code.

Part 1. Introduction

Chapter 1. Introduction	3	Format of Syntax Diagrams	3
Overview of Commands	3		

This part describes System Automation for OS/390 commands in general — how to enter them, the format, and the various types of commands.

Chapter 1. Introduction

Overview of Commands

Table 3 gives a brief overview of the System Automation for OS/390 commands. This overview lists the various types of commands, their functions and where they can be entered.

Table 3. Overview of Commands

Type of command	Function	Where entered	Notes
System operations commands			
	Control and maintain resources in the enterprise from a single point of control	NetView console, or NMC	
I/O operations commands			
	Control input/output devices	TSO/ISPF, API, operator console	
Processor operations commands			
	Common commands for automation	API, NetView console, or NMC	Precede with ISQCCMD command
	Control hardware processors	NetView console or NMC	

Format of Syntax Diagrams

The description of each command and routine includes the format of the command in a syntax diagram. The diagram shows the operands for the commands. Use blanks to separate the operands, unless otherwise stated or diagrammed.

To construct a command from the diagram, follow the diagram from left to right, choosing the path that suits your needs. Following is a sample syntax diagram that explains how to use it to construct a command. This command is for illustration only. Do not attempt to enter it.

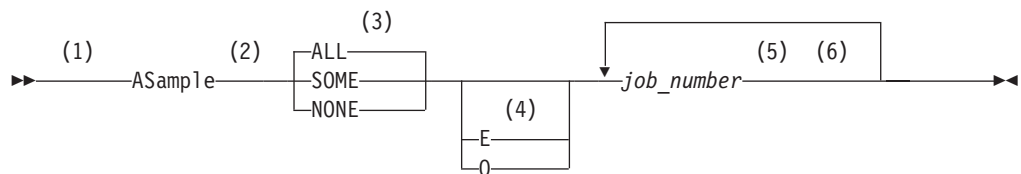

Notes:

- 1 Start here. ►► indicates the start of the diagram.
- 2 Type ASAMPLE, or abbreviate to AS. The uppercase characters are the abbreviation. Operands on the main line are required.

- 3 Choose one of the options. The default is always above the main line. In this case, ALL is the default. If the option includes punctuation marks, include them too: =(), .
- 4 Choose E, Q, or neither. Operands below the main line are optional.
- 5 Repeat *job_number* any number of times. Variables are shown in italics. Replace them with a real name or value.
- 6 End here. → indicates the end of the command.

If a command continues to the next line, you see → and ▶.
|and| indicates a fragment for a specific condition or option.

Examples:

```
====> asample none q DAF00821 DAF00832 ELD00824  
====> as some DLR01445
```

Part 2. SA OS/390 System Operations — Common Routines

Chapter 2. Common Routines	7	AOFCPSM.	65
Using System Operations Common Routines for		AOFEXCMD		66
Programming	7	AOFTREE		67
ACF	7	AOFUXMON.	71
ACFCMD	13	ASF		72
ACFFQRY	21	ASFUSER		77
ACFREP	28	CDEMATCH		80
AOCGETCN	35	CHKSUBS.		85
AOCMSG	36	CHKTHRES		86
AOCQRES.	41	INGPOST		89
AOCQRY	42	INGPW.		94
AOCUPDT	56	INGRCLUP		98
AOFADMON.	60	INGRTCMD		98
AOFAJMON	61	INGSTOBS		99
AOFAPMON	62	INGUSS		101
AOFATMON	62	ISQMTSYS		103
AOFCPMSG	63	MDFYSHUT.		103

This part describes SA OS/390 common commands — specifics of how to enter them and their format.

Refer to *System Automation for OS/390 User's Guide* for general information about the SA OS/390 commands.

Chapter 2. Common Routines

Using System Operations Common Routines for Programming

SA OS/390 provides common and generic routines for in automation procedures. Common and generic routines are convenience routines that provide your automation procedures with a simple, standard way of interfacing with the automation control file, automation status file, and NetView log file. It is strongly recommended to use these routines wherever possible in your own code.

Using common and generic routines in automation procedures provides you with the following advantages:

- Reduced development time, because less code has to be written.
- Portable code, because automation policy information unique to an enterprise can be kept in the automation control file rather than distributed among many automation procedures. The automation procedures implement a number of different rules for handling a situation and the automation control file is used to select which rules are applicable to the current situation.
- A consistent, documented interface.

Refer to Part 3, “SA OS/390 System Operations — Generic Routines”, on page 105 for further information on how to use generic routines.

ACF

Purpose

The ACF command loads, displays, and modifies automation control file entries.

For modification and display actions to work, the automation control file must be loaded into storage. Once loaded, the displays and modifications affect an in-storage version of the automation control file, allowing you to make *temporary* changes. To make permanent changes, change the automation policy using the customization dialogs, generate the automation control file member, then reload the new version using ACF, or INGAMS.

Alternatively, temporary changes to the automation control file can be made semi-permanent by saving the automation environment to a warm start cache with the ACF SAVE command. This enables your changes to be restored on a subsequent warm start. It is recommended that you change the associated policy using the customization dialogs to ensure that the policy is applied upon a cold start.

See also the related command, “ACFFQRY” on page 21.

Recommendations

- Changes to automation policy using the SA OS/390 command dialogs, or the ACF command are temporary. They modify the current in-storage version of the automation control file directly. They do not modify the automation control file stored on disk. The ACF SAVE command can be used to save any changes to a warm start cache for subsequent restoration using the ACF WARM command, or warm start. To change an automation policy setting permanently, make sure you also change the automation control file (using the customization dialogs) stored on disk.
- If the customization dialogs are used to rebuild the policy on disk, then the changed data on disk will replace the data in storage at ACF REFRESH. It will also replace the data on CACHE if you specify the SAVE option.
- Use scope-checking to limit operator use of ACF to loading, saving and display operations.

Syntax

The following syntax diagrams show how to use the ACF command to perform the different functions ACF supports. Do not combine syntax from the separate diagrams in the same ACF call.

To display information in the automation control file use the following syntax:

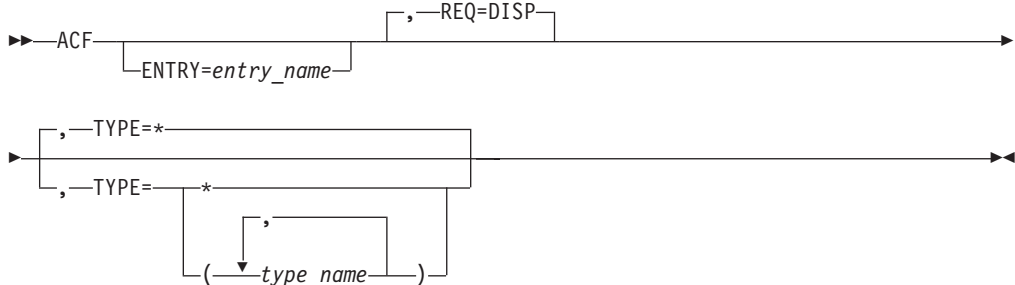

To delete information in the automation control file use the following syntax:

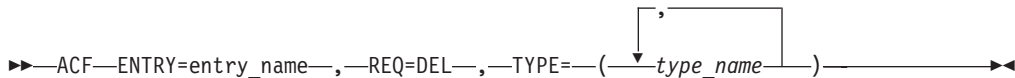

To replace or add information in the automation control file use the following syntax:

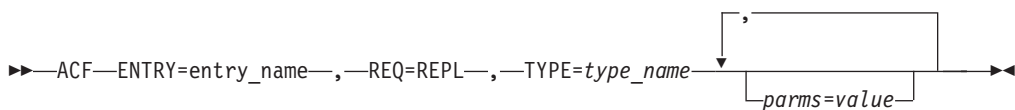

Note: The ACF command is free-form: commas are optional; more than one space can separate keywords; keywords can be specified in any sequence; any parameters specified must follow the keyword to which they apply.

Parameters

REQ=

The type of request for automation control file information the ACF command performs. This value can be one of the following:

Value Description

- | | |
|-------------|---|
| DISP | Displays information in the automation control file. This value is the default if this parameter is not coded. |
| DEL | Deletes information in the automation control file. This value must be coded when using ACF to delete automation control file information. |
| REPL | Replaces or adds information in the automation control file. This value must be coded when using ACF to replace automation control file information. REPL adds the entry specified on the ENTRY parameter if the entry does not already exist in the automation control file. |

REQ=REPL will update data in place. That is, only data that is to be replaced needs to be specified in the command. All other existing data will be retained.

ENTRY=

The entry field of the automation control file. This value can be up to 32 characters long, without imbedded blanks, commas, or quotes.

If information in the automation control file is displayed (REQ=DISP), and no value is specified in the entry field, ENTRY=* is used.

TYPE=

The type field in the automation control file. The following values can be specified:

- * Specifying * returns all type fields associated with a given entry_name, for example, all SUBSYSTEM or NTFYOP entries. * is the default value when REQ=DISP (display). REQ=DISP supports the use of * as a wildcard character when specifying type names, with the following restrictions:
 - The wildcard character, '*', must be the last character in the type name. If an asterisk appears in any other position in a type name then it will be treated as a literal. If an asterisk appears in any other position in a type name with an asterisk as the last character then no wildcard processing occurs and *both* asterisks are treated as literals.
 - You must specify the ENTRY= operand without a wildcard.
 - If no matches are found, a final search is performed with a type name of DEFAULTS.

For other ACF request types (delete and replace), you must specify an actual type name.

type_name

The name of the type field. REQ=REPL requests allow you to enter only one type_name.

When ENTRY=SUBSYSTEM, type_name can be up to 11 bytes long. In all other cases, type_name can be up to 32 characters long, without imbedded blanks, commas, or quotes.

(type_name,type_name,...)

Multiple types may be specified for DISP and DEL requests. Type

ACF

names should be enclosed in parentheses and separated by commas. For REQ=DISP, only the first type name found is displayed. For REQ=DEL requests, all the type names will be deleted.

parms=value

The data associated with the specified ENTRY and TYPE fields. This field is valid only with the REQ=REPL option. Specify this field as the parameter value, an equal (=) sign, and the value, without any spaces in between; for example, AUTO=NO.

The value can be any character data. It can have imbedded quotes, commas, and blanks, provided that single quotes or parentheses frame the value.

SA OS/390 defines several ENTRY, TYPE, and parms=value fields. A parms=value example is the JOB=jobname parameter in the SUBSYSTEM automation control file entry.

Note: REQ=REPL will update data in place. That is, only modified data is updated. All data will be retained.

Restrictions and Limitations

- The ACF command should be used with care to change or delete automation policy settings. Temporary changes can be saved to a warm start cache. Changes saved to a warm start cache are restored upon a warm start or an ACF WARM command.
- ACF is used as an API to the automation control file. It could also be used as an operator command, for example, ACF STATUS, to get information about the automation control file. For further information about ACF as an operator's command refer to *System Automation for OS/390 Operator's Commands*.
- The number of entries in the automation control file is limited only by the amount of storage in the SA OS/390 address space or region. If you have a very large configuration, you may have to increase the REGION size in the SA OS/390 procedure.
- The size of the pre-allocated Save/Restore database is the only limiting factor in saving an automation environment. Ensure that secondary extents are defined. See *NetView Administration Guide* for more information on defining Save/Restore databases.
- Not all data can be changed using ACF REQ=REPL, for example, service periods, events, triggers, dependencies and groups cannot be changed. ACF REQ=DEL and ACF REQ=REPL cannot be used to add or delete a subsystem. Use the customization dialogs to define these items.

Usage

- When you use ACF REQ=DISP to request a certain ENTRY value with one or more specific TYPE values, ACF searches for those types in the order specified in the command. When the first match is found, the information is returned to the requester as a multiline message. If there are no matches, it performs a final search with a type_name of DEFAULTS for that ENTRY value. If there is still no match, a message is returned to the requester. If the type_name DEFAULTS is found, that information is returned to the requester.
- When ACF is used to display an automation control file entry, if a specific TYPE is found, it is treated as a complete entry. Only that specific entry is displayed.

Messages

The following lists messages that are issued during the operation of ACF.

For the delete and replace function:

```
AOF001I REQUEST REPL SUCCESSFUL FOR JES2-$HASP098
```

Note: In a display where the type_name is * (asterisk), multiple sets of AOF112I and AOF113I messages may be displayed. When the type is omitted or specified as *, the DESIRED TYPE is not displayed on the AOF112I message.

For the display function:

```
AOF041I UNABLE TO FIND type_name entry_name

AOF111I AUTOMATION CONFIGURATION DISPLAY - ENTRY= entry_name
AOF112I ACTIVE TYPE= act_type, DESIRED TYPE= desired_type ...
AOF113I DATA IS data=value
AOF002I END OF MULTILINE MESSAGE
```

For example, the following may occur:

```
AOF111I AUTOMATION CONFIGURATION DISPLAY - ENTRY= NTFYOP
AOF112I ACTIVE TYPE= NETOP1
AOF113I DATA IS OPER='OPER 1'
AOF113I DATA IS CLASS=(10,40)
AOF112I ACTIVE TYPE= NETOP2
AOF113I DATA IS CLASS=(10)
AOF002I END OF MULTILINE MESSAGE
```

Note: Use of the replace parameter (REPL) adds an entry if none exists, resulting in a successful message.

Generic error messages that can occur:

```
AOF013I SPECIFIED OPERAND operand INVALID FOR PARAMETER parameter.
AOF025I SYNTAX ERROR
```

Examples

This example shows a command to display the Start automation flag for the JES2 subsystem.

The Start flag is defined in the automation policy as shown in the following panels.

On the SA OS/390 Flag Automation panel for the CICST subsystem:

```

COMMANDS  ACTIONS  HELP
-----
                                Flag Automation Specification
Command ==>>

Entry Type : Application          PolicyDB Name : DATABASE_NAME
Entry Name : CICST               Enterprise Name : YOUR_ENTERPRISE

Resource: CICST
Enter level of automation desired.

Automation Flags: Y = Yes      N = No    E = Exits
Assist Flags:      D = Display L = Log   N = None

Actions  Flag      Auto      Assist  Exits
Automation . YES      0
Recovery . . YES      0
Start. . . .          0
ShutDown . .          0
Initstart. . YES      0
Restart. . . YES      0

Enter or Display times to disable automation . . NO      Yes  No
NOAUTO CONDITIONS EXIST FOR THIS RESOURCE.

F1=HELP      F2=SPLIT      F3=END      F4=RETURN      F5=RFIND      F6=RCHANGE
F7=UP        F8=DOWN       F9=SWAP     F10=LEFT      F11=RIGHT     F12=RETRIEVE

```

Figure 1. Flag Automation Specification Sample Panel

On the SA OS/390 Automation Disable panel for CICST:

```

COMMANDS  HELP
-----
                                Automation Disable                                Row 1 to 19 of 24
Command ==>>

Entry Type : Application          PolicyDB Name : DATABASE_NAME
Entry Name : CICST               Enterprise Name : YOUR_ENTERPRISE

Subsystem : CICST

Enter days, times (24 hour clock), and types of automation to be disabled.
Days: MO = Mon    TU = Tue    WE = Wed    TH = Thu    FR = Fri
      SA = Sat    SU = Sun    MF = Mon-Fri  SS = Sat-Sun  * = Daily
Flags: D = Disable

Day  -----Time-----  -----Flags-----
     Begin  End      Auto Recover  Start  Shut  Initstart Restart
MF   07:30  04:00    D
TH   03:00  05:00    D
*    12:00  13:00                D      D
SS   18:00  19:00                D

F1=HELP      F2=SPLIT      F3=END      F4=RETURN      F5=RFIND      F6=RCHANGE
F7=UP        F8=DOWN       F9=SWAP     F10=LEFT      F11=RIGHT     F12=RETRIEVE

```

Figure 2. Automation Disable Sample Panel

The ACF command to display this policy information is:

```
ACF REQ=DISP,ENTRY=START,TYPE=CICST
```

The response is:

```
AOF111I AUTOMATION CONFIGURATION DISPLAY - ENTRY= START
AOF112I ACTIVE TYPE= CICST      , DESIRED TYPE= CICST
AOF113I DATA IS AUTO=Y
AOF113I DATA IS NOAUTO=(TUESDAY,10:00,12:00)
AOF002I END OF MULTILINE MESSAGE
```

In this example, a Start automation flag exists for the CICST subsystem. The operator or automation procedure processes the command to display the entry, and the associated response is returned as a multiline message.

ACFCMD

Purpose

The ACFCMD routine allows an automation procedure to issue commands defined in the automation policy. It searches the automation control file for the specified entries, performs variable substitution for predefined variables, then issues the commands.

ACFCMD can also issue commands that are built dynamically by the calling automation procedure and passed to ACFCMD through a special TGLOBAL named EHKCMD.

In general you should consider using ISSUECMD from the automation table, rather than calling ACFCMD directly. ISSUECMD has the following advantages:

- It will check the automation flags for you, to ensure that automation is allowed.
- It is already available.
- It will check that the job which issued the message is known to SA OS/390.

Syntax

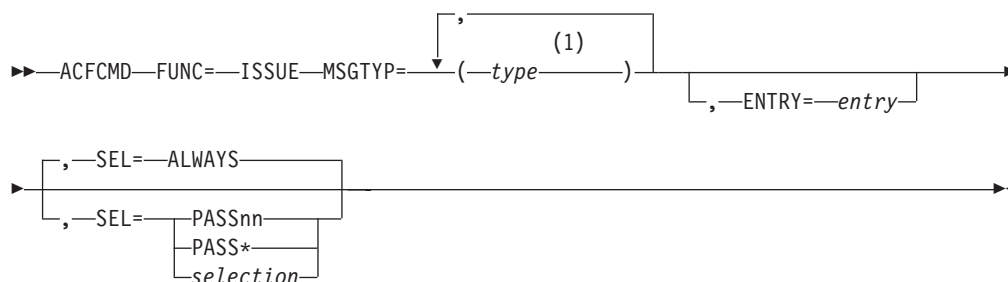

Notes:

- 1 Up to 5 types may be specified.

```
>>> ACFCMD—FUNC=—ISSUE—
```

Parameters

MSGTYP=*type*

This is the value entered in the *type* field in the automation control file entry for the command. MSGTYP is typically coded with the message ID or with a generic name, such as SPOOLSHORT or SPOOLFULL. One to five *type* fields can be coded. The *type* fields are searched in the order specified until an entry or *type* match occurs.

This parameter is mutually exclusive with the FUNC=ISSUE parameter.

ENTRY=*entry*

This is the value entered in the *entry* field in the automation control file. To understand the *entry* fields in an automation control file and how they relate to automation policy settings, refer to *System Automation for OS/390 Customizing and Programming* and to *System Automation for OS/390 Defining Automation Policy*. The default is the application name if the commands are issued for applications.

This parameter is mutually exclusive with the FUNC=ISSUE parameter.

SEL=

This parameter provides the criteria for the first field in the command entry. This field gives detailed criteria to select a command or commands from the automation control file. Based on the MSGTYP, ENTRY and SEL fields, any specific command can be retrieved from a group of commands associated with a message entry. This parameter is mutually exclusive with the FUNC=ISSUE parameter. If no SEL parameter is coded ACFCMD defaults to SEL=ALWAYS.

The commands associated with the specific pass selection value defined in the automation policy are issued, along with all commands defined without a selection value, and the commands associated with the PASS* selection value.

The following values can be specified for SEL:

ALWAYS

When SEL=ALWAYS is specified, all the commands defined in the automation policy are issued.

PASS nn

PASS nn values can range from 1 through 99 and must be coded without leading zeros, such as PASS1, PASS2, and PASS3.

PASS*

When SEL=PASS* is specified, commands associated with the PASS* selection value defined in the automation policy are issued along with all commands defined without a selection value.

selection

When SEL=*selection* is specified, the commands associated with the specific selection value defined in the automation policy are issued, along with all commands defined without a selection value, and the commands associated with the PASS* selection value.

FUNC=ISSUE

The command to be issued has been passed in the special TGLOBAL EHKCMD. ACFCMD issues and logs the command in the TGLOBAL EHKCMD.

This parameter is mutually exclusive with the MSGTYP, ENTRY, and SEL parameters.

Restrictions and Limitations

- This routine can be called only by another automation procedure or by a command processor. The common routine AOCQRY must be invoked first to set the TGLOBALs SUBSAPPL and SUBSTYPE.
- The ACF COLD command and the ACF WARM command temporarily disable automation. ACFCMD will not work while the automation control file is being reloaded. This is necessary to ensure that the SA OS/390 environment, as defined by the reloaded automation control file, is established correctly. Full automation resumes when the AOF540I - INITIALIZATION RELATED PROCESSING HAS BEEN COMPLETED message has been received.
- ACFCMD will handle a maximum of 120 commands from the automation control file.

Return Codes

Return codes are:

- | | |
|---|--|
| 0 | At least one command was found and issued. |
| 1 | No commands meeting the selection criteria were found. |
| 2 | The issued command returned a non-zero return code and return code checking was enabled through the customization dialogs. |
| 4 | Invalid parameters were used in the call. |
| 5 | Timeout or other error occurred. |
| 6 | SA OS/390 initialization incomplete, unable to process command request. |

Usage

- ACFCMD can issue multiple commands during a single instance of processing. Automation control file entries can be entered using one ENTRY and MSGTYP combination, with multiple detail entries having duplicate selection fields. During processing all duplicate selection fields are located and their associated commands are issued, provided selection fields match the selection criteria.
- When FUNC=ISSUE is used this routine can issue only one command during a single instance of processing.
- SA OS/390 variable CMDCNTHI is returned to the calling automation procedure as a TGLOBAL value. ACFCMD retrieves all command entries for a given ENTRY/MSGTYP and searches for the highest PASS nn number. The highest PASS nn number is returned in CMDCNTHI. You can use this number to determine whether all available commands are issued and an appropriate error message should be issued to the operator. If PASS nn is not coded, CMDCNTHI is zero.
- Nine variables are available to change the command entered in the automation control file. Variables &EHKVAR1 through &EHKVAR9 must be defined as TGLOBALs in the calling automation procedure and must be initialized with the data to change the commands. These variables are passed to ACFCMD. Whenever ACFCMD finds a detail command entry in the automation control file it scans the command entry looking for &EHKVAR n . If an &EHKVAR n variable is found, the value stored in the automation procedure variable replaces the &EHKVAR n in the command entry. Multiple &EHKVAR n variables can be coded in a single command entry. Delimiters are unnecessary, and the variables can be coded between any other text.

TGLOBALs

Name	Description
------	-------------

ACFCMD

EHKCMD

Contains the command issued when FUNC=ISSUE is coded.

CMDCNTHI

The number of the highest PASS m field found.

EHKVAR1 through EHKVAR9

Variable data to change the command entry; dependent on coding in the automation procedure.

If the AOCQRY common routine has been invoked to set the following TGLOBALs, they may be used to alter a command entered in the automation control file:

&SUBPAPPL
&SUBPCMDPFX
&SUBPDESC
&SUBPJOB
&SUBPSHUTDLY
&SUBSAPPL
&SUBSJOB
&SUBSDESC
&SUBSSHUTDLY
&SUBSCMDPFX
&SUBSPROC
&SUBSSPARM
&SUBSSCHEDSS

If a command is invoked for resource type USS, the following TGLOBALs can be used:

&SUBSASID
&SUBSFILE
&SUBSPATH
&SUBSPORT
&SUBSSUBTYPE
&SUBSUSER
&SUBSUSSJOB

These TGLOBALs are translated when found.

Examples

Example 1

This example shows the relationship between ACFCMD and the automation control file. The message to automate, \$HASP607, is produced by the JES2 subsystem and indicates that JES2 is not dormant. The automation procedure responds to this by calling ACFCMD to issue a command to stop the JES2 initiators, (MVS \$PI).

The command is defined in the automation policy through the customization dialog panels.

If you type DISPACF jes2 \$hasp607 a panel similar to the following is displayed:

```

AOFK3D0X          SA OS/390 - Command Response      Line 1   of 4
Domain ID  = IPSNO  ----- DISPACF -----         Date = 06/05/00
Operator ID = NETOP1                                     Time = 15:17:01

Command = ACF ENTRY=JES2,TYPE=$HASP607,REQ=DISP
SYSTEM = KEY3      AUTOMATION CONFIGURATION DISPLAY - ENTRY= JES2
-----
AUTOMATION CONFIGURATION DISPLAY - ENTRY= JES2
TYPE IS $HASP607
CMD          = (.,'MVS $PI')
END OF MULTI-LINE MESSAGE GROUP

Command ==>>
PF1=Help      PF2=End      PF3=Return    PF6=Ro11
               PF9=Refresh PF12=Retrieve

```

The automation procedure to issue this command is:

```

/* REXX CLIST to automate $HASP607                               */
/* Check whether automation allowed and set TGLOBALs            */
'AOCQRY ...'                                                    */
:
:
'ACFCMD MSGTYP=$HASP607,ENTRY=JES2,SEL=ALWAYS'
Select
  When rc = 0 Then Nop      /* Command issued OK                */
  When rc = 1 Then Do      /* No commands issued; warn if required */
:
  End
  Otherwise Do              /* Error; perform warning action      */
:
  End
End
Exit

```

The ENTRY, MSGTYP, and SEL parameters on ACFCMD correspond to values JES2, \$HASP607, and ALWAYS, respectively, in the automation policy definitions.

ACFCMD uses the parameters passed to it to find the corresponding values in the automation policy. This example uses all ACFCMD parameters except FUNC=ISSUE.

Upon return to the automation procedure, the rc special variable is checked to ensure a command was found in the automation control file. The automation procedure takes appropriate action if a command is not found or a processing error occurs in the ACFCMD routine.

Example 2

This example uses the same scenario as Example 1, but shows how you can use defaults to minimize coding. The message to automate, \$HASP607, is produced by the JES2 subsystem and indicates that JES2 is not dormant. The automation procedure responds by calling ACFCMD to issue a command to stop the JES2 initiators (\$PI).

ACFCMD

The command is defined in the automation policy as in Example 1.

The automation procedure to issue this command is:

```
/* REXX CLIST to automate $HASP607 */
/* Check whether automation allowed and set TGLOBALs */
'AOCQRY ...'
:
'ACFCMD MSGTYP='Msgid()
Select
  When rc = 0 Then Nop /* Command issued OK */
  When rc = 1 Then Do /* No commands issued; warn if required */
  :
  End
  Otherwise Do /* Error; perform warning action */
  :
  End
End
Exit
```

This example differs from Example 1 in the following ways:

- ACFCMD uses a NetView function for the MSGTYP field, assumes defaults for the ENTRY and SEL fields and uses task globals set up by AOCQRY for the entry default.
- The ENTRY field defaults to JES2 because the job name on the message was the job name for the JES2 subsystem, so the SUBSAPPL task global (which is the default entry type) currently contains JES2. Common routine AOCQRY must be called before ACFCMD for the ENTRY default to work correctly.
- The SEL field defaults to ALWAYS, which is the same as the automation policy value this example attempts to select.
- The MSGTYP field uses the NetView REXX function Msgid(), which contains the message identifier for the message that called the automation procedure. This message identifier is supplied only to an automation procedure called from the NetView automation table. This value can be used when calling ACFCMD.

Note: If your code issues a WAIT command before it issues the ACFCMD you must store the msgid() value in a temporary global as the NetView MSGREAD command overwrites the data from the message that invoked the procedure.

Assuming AOCQRY is invoked to check the Shutdown flag both the above examples are equivalent to invoking from the MAT for \$HASP607:

```
ISSUECMD AUTOTYP=TERMINATE
```

Example 3

This example shows the use of *PASS_{nm}* logic in an automation procedure. The message to automate, \$HASP607, is produced by the JES2 subsystem and indicates that JES2 is not dormant. The automation procedure responds the first time by stopping the JES2 initiators (\$PI command), and the second time by abending JES2 (\$P JES2,ABEND).

The commands are defined in the automation policy through the customization dialogs. The data is stored in the automation control file in the following way:

```

AOFK3D0X          SA OS/390 - Command Response      Line 1   of 5
Domain ID   = IPSNO  ----- DISPACF -----      Date = 06/06/00
Operator ID = NETOP1                                     Time = 13:09:05

```

```

Command = ACF ENTRY=JES2,TYPE=$HASP607,REQ=DISP
SYSTEM = KEY3      AUTOMATION CONFIGURATION DISPLAY - ENTRY= JES2
-----

```

```

AUTOMATION CONFIGURATION DISPLAY - ENTRY= JES2
TYPE IS $HASP607
CMD          = (PASS1,, 'MVS $PI')
CMD          = (PASS2,, 'MVS $P JES2,ABEND')
END OF MULTI-LINE MESSAGE GROUP

```

```

Command ==>
PF1=Help      PF2=End      PF3=Return    PF6=Roll
              PF9=Refresh  PF12=Retrieve

```

The automation procedure to issue the commands is:

```

/* REXX CLIST to automate $HASP607                                */
/* Check whether automation allowed and set TGLOBALs             */
'AOCQRY ...'                                                    */
:
/* Increase the counter unique to this automation procedure      */
'GLOBALV GETC HASP607_CNT'                                       */
If hasp607_cnt = ' ' Then hasp607_cnt = 1
Else hasp607_cnt = hasp607_cnt + 1
'GLOBALV PUTC HASP607_CNT'
/* Issue the ACF command for the pass number as determined     */
'ACFCMD MSGTYP='Msgid()',SEL=PASS'hasp607_cnt                    */
Select
  When rc = 0 Then Nop      /* Command issued OK                                */
  When rc = 1 Then Do      /* No commands issued; warn if required                    */
:
  End
  Otherwise Do              /* Error; perform warning action                            */
:
  End
End
Exit

```

This example differs from the previous examples in the following ways:

- The automation procedure uses a unique CGLOBAL variable, in this case HASP607_CNT, to maintain a PASS counter. The automation procedure adds 1 to this counter each time it is processed, then appends the counter to the SEL=PASS field. During processing, the counter is translated, and PASS1 or PASS2 is processed. Note that a null test is required to set the counter to 1 if it has not been set before. If the counter exceeds 2 then the ACFCMD will set a return code of 1 since there is no matching entry in the automation control file.

Note: This example assumes you are using one JES subsystem. If you are using multiple JES subsystems, you must use a different counter variable for each.

- Another automation procedure that resets the counter is necessary to complete the logic flow. For this example, the automation procedure runs when the final JES2 message or a startup message is received. Note that the counter is cleared

ACFCMD

rather than set to zero. This saves an entry in the NetView global dictionary unless the message \$HASP607 has occurred.

The automation procedure to reset the counter is:

```
/* REXX CLIST to reset the counter                                */
hasp607_cnt = ''
'GLOBALV PUTC HASP607_CNT'
Exit
```

Notes:

1. To ensure serialization of access to the NetView global dictionary and the correct ordering of the commands issued, the NetView automation table entry should route the command to a specific operator if the message may occur more than once in quick succession.
2. If AOCQRY is checking the Shutdown flag this example could be coded as:
ISSUECMD AUTOTYP=TERMINATE,PASSES=YES

The pass count will be reset when the application final termination message is processed.

Example 4

This example shows the use of EHKVAR n variables. It also shows the use of duplicate selection fields because two entries are coded, each with PASS1. The message to automate is given in response to the JES2 \$DU command, which displays all JES2 devices. The message ID produced by JES2 is \$HASP628. The example assumes the full text of the message is passed to the automation procedure. The automation procedure checks the resource type, and if the resource is a line, stops the line using the \$P LINE nn command, then stops current activity with a restart command, \$E LINE nn .

The commands are defined in the automation policy through the customization dialog panels. The data is stored in the automation control file in the following way:

```
AOFK3D0X          SA OS/390 - Command Response      Line 1   of 5
Domain ID   = IPSNO   ----- DISPACF -----      Date = 06/06/00
Operator ID = NETOP1                                Time = 13:00:51
```

```
Command = ACF ENTRY=JES2,TYPE=$HASP628,REQ=DISP
SYSTEM = KEY3      AUTOMATION CONFIGURATION DISPLAY - ENTRY= JES2
```

```
-----
AUTOMATION CONFIGURATION DISPLAY - ENTRY= JES2
TYPE IS $HASP628
CMD          = (PASS1,, 'MVS $P &EHKVAR1')
CMD          = (PASS1,, 'MVS $E &EHKVAR1')
END OF MULTI-LINE MESSAGE GROUP
```

```
Command ==>
PF1=Help      PF2=End      PF3=Return      PF6=Ro11
               PF9=Refresh  PF12=Retrieve
```

The automation procedure to issue the commands is:

```

/* REXX CLIST to automate $HASP628 */
/* Check whether automation allowed and set TGLOBALs */
'AOCQRY ...'
:
/* Assign EHKVAR1 to parameter 2 (resource name on $HASP628 msg)
then determine whether the first characters are LINE, if not, exit */
ehkvar1 = Msgvar(2)
If Left(ehkvar1,4) <> 'LINE' Then Exit
'GLOBALV PUTT EHKVAR1'
'ACFCMD MSGTYP='Msgid()',SEL=PASS1'
Select
  When rc = 0 Then Nop      /* Command issued OK */
  When rc = 1 Then Do      /* No commands issued; warn if required */
:
  End
  Otherwise Do             /* Error; perform warning action */
:
  End
End
Exit

```

Following are the processing steps the automation procedure performs:

1. The EHKVAR1 variable is assigned the value in the second parameter sent to the automation procedure, which for the \$HASP628 message is the resource type
2. The automation procedure verifies that the resource type is a LINE, then sets the variable into a TGLOBAL variable and calls ACFCMD
3. Assuming the second parameter is LINE21, two commands are issued from this automation procedure:

```

$P LINE21
$E LINE21.

```

ACFFQRY

Purpose

The ACFFQRY command provides a fast, pipeable means of accessing the SA OS/390 automation control file from your automation procedures.

See also the related command "ACF" on page 7.

Syntax

The following syntax diagram shows how to use the ACFFQRY command to query the automation control file.

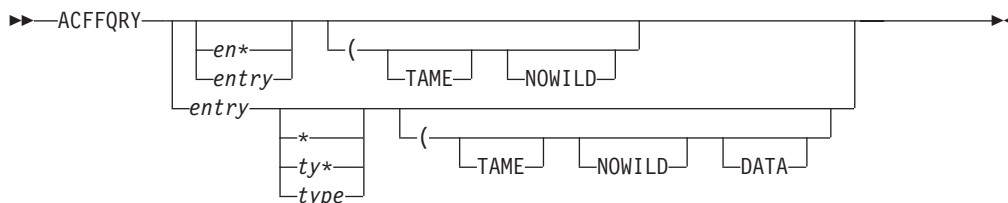

ACFFQRY

Parameters

entry

This is the *entry* value to be used to search the automation control file. The entry value may take the following forms:

* The entry value is the wildcard character, unless TAME is specified.

*en** The entry value ends with the wildcard character, unless TAME is specified.

entry A specific entry value is entered. You must enter a specific entry value if you want to specify a type value.

type

This is the *type* value to be used to search the automation control file. A type value can be specified *only* when a specific entry value is entered. The type value may take the following forms:

* The type value is the wildcard character, unless TAME or NOWILD is specified.

*ty** The type value ends with the wildcard character, unless TAME or NOWILD is specified.

type A specific type value is entered.

TAME

Wildcards in the entry and type name in the automation control file database are to be matched against the entry and type specified on the search. TAME allows for wildcards IN THE DATABASE you are searching. For example, with a constant query string, such as AAA 123 you can match on multiple entries in the automation control file, such as AAA 12*.

This means that if user entries and types have been set up in the automation control file with an asterisk for the last character they are taming candidates. This may be particularly useful for situations where generic rather than specific data is maintained and used in automation procedures.

NOWILD

The asterisk (*) character in the query string is to be treated as a literal.

DATA

The keyword=value data related to the entry/type pair is to be returned.

Restrictions and Limitations

A type value can be specified only if a specific entry value is specified.

Usage

It is most efficient if it is called within a PIPE, but may also be called within a TRAP/WAIT/MSGREAD.

TGLOBALS

None.

Messages

Output from ACFFQRY takes the form of a correlated multiline message, with one or two list items and data elements on each line of the message. There are no surrounding message IDs or details.

The first line of the multiline message is always the literal ACFFQRY:, followed by the return code from ACFFQRY. If output is present it begins on line two. This means that output returned in a stem must be processed from element two.

If keyword=data is returned, the entry and type will precede it. Your routines can differentiate entry/type output from data output by the presence of an equals (=) sign. For example:

```
If Pos('=' ,data.n) = 0 the Do
/* data line is an ENTRY TYPE */
End
Else Do
/* data line is an KEYWORD=VALUE */
End
```

- If both entry and type parameters are omitted, a list of all the entries is returned.
- If an entry is specified and the type is omitted, a list of the entry and all the types for that entry is returned.
- If both entry and type are specified, all the data for that entry/type combination is returned.
- If the parameters indicate an area where there is no data, a null list is returned.

Table 4 shows the result for various parameter combinations. An “-” means that an option is irrelevant to the output produced. An asterisk in the DATA column indicates that the keyword=value data is returned.

Table 4. Output from ACFFQRY

Entry	Type	TAME	NOWILD	DATA	Result
		-	-		List of all entries
en* or *		No	No		List of entries starting with “en”.
en* or *		Yes	No		List of all entries starting with en or taming en*.
entry		Yes	-	-	List of entries taming entry
entry		No	-	-	List of types for entry
entry	ty*	No	No	*	List of types for entry starting with ty
entry	ty*	Yes	No	*	List of types for entry starting with ty or taming ty*
entry	ty*	No	Yes	*	All data for entry entry and type ty*
entry	ty*	Yes	Yes	*	List of all types for entry taming ty*
entry	type	No	-	-	All data for entry entry and type type
entry	type	Yes	-	*	List of all types for entry taming type

Return Codes

These return codes appear on the first line of the returned data, after the literal ACFFQRY:.

- 0 Data returned.
- 1 There is no data for the specified parameters or SA OS/390 is not fully initialized.

ACFFQRY

- 2 Too many parameters before the opening parentheses. You can specify at most an entry and a type, each of which is a single word.
- 3 Entry/Type combination not allowed. If you have specified an entry including an *, you may not specify a type.
- 5 The SA OS/390 global variables containing internal automation control file information have been corrupted.
- 6 You have specified an invalid option.
- 7 You have specified an option more than once.

Examples

Example 1

An ACFFQRY specifying a full ENTRY value only

```
ACFFQRY SUBSYSTEM
```

returns all TYPE matches for that ENTRY.

```
ACFFQRY:0  
SUBSYSTEM SYSVSSI  
SUBSYSTEM SYSVIEW  
SUBSYSTEM VLF  
SUBSYSTEM LLA  
SUBSYSTEM JES  
SUBSYSTEM VTAM  
SUBSYSTEM TSO  
SUBSYSTEM RMF
```

Example 2

An ACFFQRY specifying a full ENTRY value and a full TYPE value

```
ACFFQRY SUBSYSTEM TSO
```

returns all KWD=DATA associated with the ENTRY/TYPE pair.

```
ACFFQRY:0
SUBSYSTEM TSO
JOB=TSO
DESC='Time Sharing Option'
SHUTDLY=00:01:30
```

Example 3

An ACFFQRY specifying a full ENTRY and a wild TYPE

```
ACFFQRY SUBSYSTEM V*
```

returns a list of all matching TYPES.

```
ACFFQRY:0
SUBSYSTEM VLF
SUBSYSTEM VTAM
```

Example 4

This example is the same as example 3, except that the DATA option is specified.

```
ACFFQRY SUBSYSTEM V* (DATA
```

The KWD=DATA values for all matches are returned.

```
ACFFQRY:0
SUBSYSTEM VLF
DESC='Virt Lib DEF'
SCHEDSUB=MSTR
JOBTYPE=MVS
IPLOPTIONS=START
RECYCLEOPT=START
RESTARTOPT=ALWAYS
PARMS=' ,SUB=MSTR,NN=00'
SHUTDLY=00:03:00
STRTDLY=00:02:00
TERMDLY=00:00:15
JOB=VLF
SUBSYSTEM VTAM
DESC='VTAM V4.1'
PARMS=' ,,,(LIST=FP)'
SHUTDLY=00:01:00
JOB=VTMN24E
```

Example 5

This example shows the use of the TAME option.

```
ACFFQRY CONTROLLER QLN37A07 (TAME
```

All ENTRY/TYPES that include a wildcard that matches the search string are returned.

```
ACFFQRY:0
CONTROLLER QLN*
CONTROLLER QLN37*
CONTROLLER Q*
```

ACFFQRY

Example 6

This example is the same as example 5 except that the DATA option is specified.

```
ACFFQRY CONTROLLER QLN37A07 (TAME DATA
```

All KWD=DATA values for the ENTRY/TYPE list are returned.

```
ACFFQRY:0
CONTROLLER QLN*
LOCATION=NEW_YORK
TYPE=LOCAL
OWNER='FRED SMITH'
CONTROLLER QLN37*
LOCATION='Episode 1, Level 3, Oil Refinery'
TYPE=LOCAL
START='MVS VARY 04AE,ONLINE'
OWNER='JIM SMITH'
CONTROLLER Q*
LOCATION=USA
TYPE=GLOBAL
OWNER='BILL SMITH'
```

Example 7

This example shows the result of the NOWILD option.

```
ACFFQRY CONTROLLER QLN37* (NOWILD
```

The asterisk (*) is treated as a literal in the search pattern.

```
ACFFQRY:0
CONTROLLER QLN37*
LOCATION='Episode 1, Level 3, Oil Refinery'
TYPE=LOCAL
START='MVS VARY 04AE,ONLINE'
OWNER='JIM SMITH'
```

Example 8

The following example shows how to find the job name for a subsystem from a REXX routine, using the NetView PIPE facility.

```
Get_Jobname:
Arg subsystem .
'PIPE NETVIEW ACFFQRY SUBSYSTEM' subsystem '| STEM ALL DATA.',
'| SEPARATE | LOCATE 1.4 /JOB=/ | TAKE 1 | STEM JOBNAME.'
If all_data.0 < 1 Then
  Call Terminal_Error 'PIPE 1 Failed'
If all_data.1 <> 'ACFFQRY:0' Then
  Return '
If jobname.0 = 0 Then
  Return subsystem
Parse var jobname.1 'JOB=' jobname .
Return jobname
```

Example 9

This example takes the name of a failing device and finds the appropriate person to notify. It makes use of the TAME option. The data being searched is:

```
DEVFAIL DEV1230,
CONTACT=MIK
DEVFAIL DEV12*,
CONTACT=JB
DEVFAIL DEV34*,
CONTACT=JAQUES
```

```

DEVFAIL DEV*,
CONTACT=MIK
CONTACT MIK,
page=00230936473
CONTACT JB,
page=00234628164
CONTACT JAKUES,
page=00237564815

```

The code fragment below takes the number of a failing device and returns the paging number for the person to be notified. Note the use of subroutines, which make it easy to write similar queries and could replace the previous example.

```

Get_Page_Num:
Procedure
Arg device_number .
match = Get_Best_Match('DEVFAIL',device_number)
If match = ' ' Then
  Return ' '
contact = Get_Key('CONTACT=', 'DEVFAIL',match)
If contact = ' ' Then
  Return ' '
Return Get_Key('page=', 'CONTACT',contact)

Get_Best_Match:
Procedure
Arg entry ., type .
'PIPE NETVIEW ACFFQRY' entry type '( TAME | STEM DATA.'
If data.0 < 1 Then
  Call Terminal_Error 'Get_Best_Match PIPE Failed'
If data.0 <> 'ACFFQRY:0' Then
  Return ' '
match = ' ' /* Longest match = best match */
match_len = 0
Do i = 2 to data.0
  If words(data.i) = 2 Then Do
    data_val = word(data.i,2)
    If Length(data_val) > match_len The Do
      match = data_val
      match_len = Length(match)
    End
  End
End
Return match

Get_Key:
Procedure
Arg key ., entry ., type .
'PIPE NETVIEW ACFFQRY' entry type '(NOWILD | STEM ALL_DATA.',
'| SEPARATE | LOCATE 1.' || length(key) '/' || key || '/',
'| TAKE 1 | STEM DATA.'
If all_data.0 < 1 Then
  Call Terminal_Error 'Get_Key PIPE Failed'
If all_data.1 <> 'ACFFQRY:0' Then
  Return ' '
parse var data.1 .=' data_val
Return data_val

```

ACFREP

Purpose

The ACFREP routine allows an automation procedure to issue replies defined in the automation policy. It searches the automation control file for the specified entries, performs variable substitution for predefined variables, then issues the reply.

ACFREP can also issue replies that are built dynamically by the calling automation procedure and passed to ACFREP through a special TGLOBAL named EHKRPY.

ACFREP issues replies to the resource identified by the TGLOBALs SUBSAPPL and SUBSTYPE, which are set by the common routine AOCQRY.

Syntax

To issue replies directly defined in the automation control file use the following syntax:

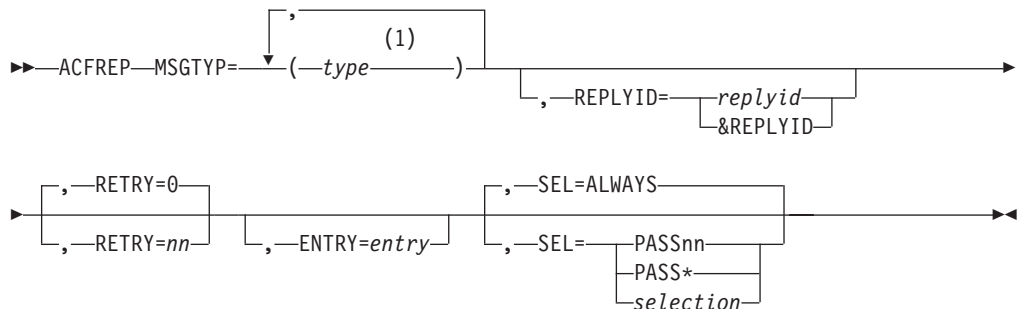

Notes:

- Up to 5 types may be specified.

To issue replies built dynamically by the calling automation procedure use the following syntax:

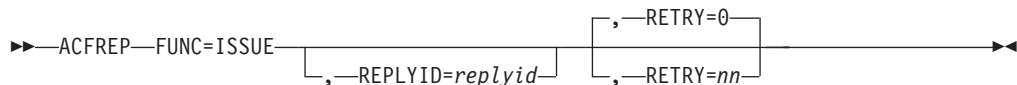

Parameters

MSGTYP=

This is the value entered in the *type* field in the automation control file entry for the reply. The default is the message ID. MSGTYP is typically coded with the message ID or with a generic name, such as SPOOLSHORT or SPOOLFULL. One to five type fields can be coded. The type fields are searched in the order specified until an entry or type match occurs. You can enter reply information to be called by ACFREP using the MESSAGES policy item of the application policy object. Refer to *System Automation for OS/390 Defining Automation Policy* for further information.

This parameter is mutually exclusive with the FUNC=ISSUE parameter.

REPLYID=

The MVS reply identifier associated with this reply. This reply identifier is supplied to an automation procedure through the NetView REXX function Replyid() or the NetView variable &REPLYID.

The replyid as supplied by the REXX Replyid() function.

&REPLYID

The NetView &REPLYID variable.

This parameter is optional. If it is not specified, the outstanding reply value is retrieved and used.

RETRY=

nn specifies the retry count if an outstanding reply is not available. Every two seconds, ACFREP attempts to retrieve an outstanding reply until the retry count is exhausted. When an outstanding reply ID is retrieved, the reply is issued. If no RETRY value is coded, ACFREP defaults to RETRY=0.

ENTRY=

The criteria for the entry field during the reply search. This value relates to the entry field in the automation control file. To understand the entry fields in an automation control file and how they relate to automation policy settings, refer to *System Automation for OS/390 Customizing and Programming* and to *System Automation for OS/390 Defining Automation Policy*. The default is the application name if the replies are issued for an application.

You can enter reply information using the MESSAGES policy item of the application policy object. Refer to *System Automation for OS/390 Defining Automation Policy* for further information.

SEL=

This parameter provides the criteria for the first field in the command entry. This field gives detailed criteria to select a command or commands from the automation control file. Based on the MSGTYP, ENTRY and SEL fields, any specific command can be retrieved from a group of commands associated with a message entry. This parameter is mutually exclusive with the FUNC=ISSUE parameter. If no SEL parameter is coded ACFREP defaults to SEL=ALWAYS.

The following values can be specified for SEL:

ALWAYS

When SEL=ALWAYS is specified, all the commands defined in the automation policy are issued.

PASS

PASS nn values can range from 1 through 99 and must be coded without leading zeros, such as PASS1, PASS2, and PASS3. The commands associated with the specific pass selection value defined in the automation policy are issued, along with all commands defined without a selection value, and the commands associated with the PASS* selection value.

PASS*

When SEL=PASS* is specified, commands associated with the PASS* selection value defined in the automation policy are issued along with all commands defined without a selection value.

selection

When SEL=*selection* is specified, the commands associated with the specific selection value defined in the automation policy are issued, along with all

ACFREP

commands defined without a selection value, and the commands associated with the PASS* selection value.

FUNC=ISSUE

The reply to be issued has been passed through the special TGLOBAL EHKRPY. ACFREP performs normal reply and log functions for the reply in the TGLOBAL EHKRPY.

This parameter is mutually exclusive with MSGTYP, ENTRY, and SEL parameters.

Restrictions and Limitations

This routine can be called only by another automation procedure or by a command processor. The common routine AOCQRY must be invoked first to set the TGLOBALS SUBSAPPL and SUBSTYPE.

ACFREP may only be run on the same autotask where the WTORs that ACFREP is to reply to would be processed by OUTREP if the WTOR reply number is passed to ACFREP as an input parameter. This is the case because the ACFREP command blocks the task while it is waiting for OUTREP to run. However, OUTREP cannot run because the task is busy. The OUTREP processing normally occurs on the task identified in the %AOFOPWTORS% automation table synonym, but the automation table may route the processing to a different autotask.

Return Codes

Return codes are:

- | | |
|---|---|
| 0 | A reply was found and issued. |
| 1 | No reply meeting the selection criteria was found. |
| 2 | No outstanding reply ID was found in the automation status file. |
| 3 | ACFREP successfully responded to only part of the defined replies. |
| 4 | Incorrect parameters were used in the call. |
| 5 | Timeout or other error occurred. |
| 6 | SA OS/390 initialization incomplete, unable to process command request. |

Usage

- Consider using ISSUEREPLY from the NetView automation table rather than using ACFREP directly.
- Multiple replies may exist for a given ENTRY, MSGTYP, and SEL field. For the second and subsequent replies, ACFREP always retrieves the outstanding reply number before issuing the reply. If an outstanding reply number does not exist when the reply should be issued, ACFREP attempts a retry if so defined. Retries may be defined either through the RETRY keyword of ACFREP or through the retry value specified in the policy entry. The retry value specified in your policy takes precedence over the RETRY keyword if both are specified. There is a 2-second delay between retry attempts.
- SA OS/390 variable EHKRPYHI is returned to the calling automation procedure as a TGLOBAL value. ACFREP retrieves all reply entries for a given ENTRY or MSGTYP value and searches for the highest PASS $_{nn}$ number. The highest PASS $_{nn}$ number is returned in variable EHKRPYHI. You can use this number to determine whether all available commands are issued and an appropriate error message should be issued to the operator. If PASS $_{nn}$ is not coded, EHKRPYHI is zero.
- Nine variables are available to change the reply entered in the automation control file. Variables &EHKVAR1 through &EHKVAR9 must be defined as TGLOBALS in the calling automation procedure and must be initialized with the

data to change the replies. These variables are passed to the ACFREP routine. Whenever ACFREP finds a detail reply entry in the automation control file, it scans the reply entry looking for &EHKVAR n . If an &EHKVAR n variable is found, the value stored in the variable replaces the &EHKVAR n in the reply entry. You can code multiple &EHKVAR; n variables in a single reply entry. Delimiters are unnecessary, and you can code the variables between any other text.

- If your automation procedure issues &WAIT commands, you must save the &MSGID variable upon entry, because this variable resets whenever a &WAIT command is issued.

TGLOBALS

Name	Description
EHKRPY	The reply to be issued when FUNC=ISSUE is coded.
EHKRPYHI	The number of the highest PASS m field found.
EHKVAR1 through EHKVAR9	Variable data to change the reply entry; dependent on coding in the automation procedure.

If the AOCQRY common routine has been invoked to set the following TGLOBALS they may be used to alter a reply entered in the automation control file:

- &SUBPJOB
- &SUBSAPPL
- &SUBSCMDPFX
- &SUBSDESC
- &SUBSJOB
- &SUBSPROC
- &SUBSSCHEDSS
- &SUBSSHUTDLY
- &SUBSSPARM

These TGLOBALS are translated when found.

Examples

Example 1

This example shows the relationship between ACFREP and automation policy. The message to automate, \$HASP426, is produced by the JES2 subsystem, requesting the JES2 startup specifications. The automation procedure responds to this by calling ACFREP to issue a reply of WARM,NOREQ from the automation control file.

The data is stored in the automation control file in the following way:

ACFREP

```
AOFK3D0X          SA OS/390 - Command Response      Line 1   of 4
Domain ID   = IPSNO  ----- DISPACF -----      Date = 06/06/00
Operator ID = NETOP1                                     Time = 13:30:53

Command = ACF ENTRY=JES2,TYPE=$HASP426,REQ=DISP
SYSTEM = KEY3      AUTOMATION CONFIGURATION DISPLAY - ENTRY= JES2
-----
AUTOMATION CONFIGURATION DISPLAY - ENTRY= JES2
TYPE IS $HASP426
REPLY      = (,,'WARM,NOREQ')
END OF MULTI-LINE MESSAGE GROUP

Command ==>
PF1=Help      PF2=End      PF3=Return      PF6=Roll
               PF9=Refresh      PF12=Retrieve
```

The automation procedure to issue this reply is:

```
/* REXX CLIST to automate the reply to $HASP426          */
/* Check whether automation allowed and set TGLOBALs     */
'AOCQRY ...'
:
'ACFREP MSGTYP=$HASP426,REPLYID='Replyid()',ENTRY=JES2,SEL=ALWAYS'
Select
  When rc = 0 Then Nop      /* Reply issued OK          */
  When rc = 1 Then Do      /* No reply issued; warn if required */
:
  End
  Otherwise Do              /* Error; perform warning action */
:
  End
End
Exit
```

ACFREP uses the parameters passed to the routine to find corresponding entries in the automation control file. For clarity, the example uses all ACFREP keywords.

Note that the function `Replyid()` is used for the `REPLYID` parameter. This function is a standard NetView REXX function which will only return a value to an automation procedure called from the NetView automation table, and only if a reply is required. You can use this value when calling ACFREP.

Upon return to the automation procedure, the `rc` special variable is checked to ensure that a reply was found in the automation control file. The automation procedure takes appropriate action if a reply is not found or a processing error occurs in ACFREP.

Note: Assuming that AOCQRY was checking the Start automation flag, this route could be replaced by coding:

```
ISSUEREP AUTOTYPE=START
```

Example 2

This example uses the same scenario as Example 1, but shows how you can use the defaults to minimize coding. The message to automate, \$HASP426, is produced by the JES2 subsystem and requests the JES2 startup specifications. The automation procedure responds to this by calling ACFREP to issue a reply of WARM,NOREQ from the automation control file.

The reply is defined in the automation policy in the same way as Example 1.

The automation procedure to issue the reply is:

```

/* REXX CLIST to automate the reply to $HASP426                */
/* Check whether automation allowed and set TGLOBALs          */
'AOCQRY ...'
:
'ACFREP MSGTYP='Msgid()',REPLYID='Replyid()'
Select
  When rc = 0 Then Nop      /* Reply issued OK                */
  When rc = 1 Then Do      /* No reply issued; warn if required */
:
  End
  Otherwise Do             /* Error; perform warning action   */
:
  End
End
Exit

```

This example differs from Example 1 in the following ways:

- ACFREP uses a NetView variable for the MSGTYP field and assumes the defaults for the ENTRY and SEL fields.
The entry defaults to the value of SUBSAPPL. AOCQRY will set this value to the name of the application with which AOCQRY was invoked. In this case the value is JES2.
The ENTRY field defaults to JES2. Routine AOCQRY must be called before ACFREP for the ENTRY default to work correctly.
- The SEL field defaults to ALWAYS, which is the same as the automation control file entry to be selected.
- The MSGTYP field uses the NetView REXX function Msgid(), which contains the message identifier for the message that called the automation procedure. This message identifier is supplied only to an automation procedure called from the NetView automation table. Use this value when calling ACFREP. Note that calling WAIT will replace the value of Msgid().

Note: Assuming AOCQRY was checking the Start flag, this example could be replaced with:

```
ISSUEREP AUTOTYP=START
```

Example 3

This example shows the use of PASS m logic in an automation procedure. The message to automate, \$HASP098, is produced by the JES2 subsystem and requests the JES2 shutdown options. The automation procedure responds to this, the first Reply time, by calling ACFREP to issue a REPLY of DUMP from the automation control file, and the second time by issuing a reply of PURG.

Reply information is defined in the automation policy through the customization dialogs. The data is stored in the automation control file in the following way:

ACFREP

```
AOFK3D0X          SA OS/390 - Command Response      Line 1    of 5
Domain ID   = IPSNO  ----- DISPACF -----      Date = 06/06/00
Operator ID = AFRANCK                                     Time = 13:36:31

Command = ACF ENTRY=JES2,TYPE=$HASP098,REQ=DISP
SYSTEM = KEY3      AUTOMATION CONFIGURATION DISPLAY - ENTRY= JES2
-----
AUTOMATION CONFIGURATION DISPLAY - ENTRY= JES2
TYPE IS $HASP098
REPLY          = (PASS1,, 'DUMP')
REPLY          = (PASS2,, 'PURG')
END OF MULTI-LINE MESSAGE GROUP

Command ==>
PF1=Help      PF2=End      PF3=Return    PF6=Roll
               PF9=Refresh  PF12=Retrieve
```

The automation procedure to issue these replies is:

```
/* REXX CLIST to automate $HASP098                                */
/* Check whether automation allowed and set TGLOBALs            */
'AOCQRY ...'                                                     */
:
/* Increase the counter unique to this automation procedure     */
'GLOBALV GETC HASP098_CNT'                                       */
If hasp098_cnt = ' Then hasp098_cnt = 1
Else hasp098_cnt = hasp098_cnt + 1
'GLOBALV PUTC HASP098_CNT'
/* Issue the ACF reply for the pass number as determined       */
'ACFREP MSGTYP='Msgid()',REPLYID='Replyid()',SEL=PASS'hasp098_cnt */
Select
  When rc = 0 Then Nop      /* Reply issued OK                */
  When rc = 1 Then Do      /* No reply issued; warn if required */
:
  End
  Otherwise Do              /* Error; perform warning action    */
:
  End
End
Exit
```

This example differs from the previous examples in the following ways:

- The automation procedure uses a unique CGLOBAL variable, in this case HASP098_CNT, to maintain a PASS counter. The automation procedure adds 1 to this counter each time it is processed, then appends the counter to the SEL=PASS field. During processing, the counter is translated, and PASS1 or PASS2 is run. Note that a null test is required to set the counter to 1 if it has not been set before. If the counter exceeds 2 then the ACFREP will set a return code of 1 since there is no matching entry in the automation control file.
- Another automation procedure that resets the counter is necessary to complete the logic flow. In this example, this automation procedure is processed when the final JES2 message or a startup message is received.

The automation procedure to reset the counter is:

```

/* REXX CLIST to reset the counter
hasp098_cnt = ''
'GLOBALV PUTC HASP098_CNT'
Exit
*/

```

Note: To ensure serialization of access to the NetView global dictionary and the correct ordering of the replies issued, the NetView automation table entry should route the command to a specific operator if the message may occur more than once in quick succession.

AOCGETCN

Purpose

The AOCGETCN command obtains an extended MCS console with a unique name for an operator or autotask issuing the command. If an MVS console is already associated with that task, it is released.

The default console name is the character A, followed by the last 5 characters of the task name concatenated with the last two characters of the system name.

Syntax

►►—AOCGETCN—*parameters*—◄◄

Parameters

Optionally, you may supply one or more parameters, which are valid for NetView's GETCONID, for example, ALERTPCT, MIGRATE, QLIMIT, QRESUME, or STORAGE.

If you specify more than one parameter, you can either separate them by blank or by comma, for example:

```
AOCGETCN MIGRATE=YES, STORAGE=1000
```

For further information and a list of valid GETCONID parameters and their descriptions, refer to the NetView documentation.

Restrictions and Limitations

- The previous console will be released even if AOCGETCN fails to obtain the new console.
- The GETCONID parameters `CONSOLE=xxxxxxxx` and `AUTH=yyyyyyy` are not supported. If you enter them, they will be ignored.

Usage

Console names within a sysplex must be unique. The task name is used if the console name is not specified. To avoid possible naming conflicts due to common task names AOCGETCN should be used to obtain a console with a unique name. The characters which are used in determining the unique console name can be tailored by updating the common global variable AOFNPMASK. Refer to *System Automation for OS/390 Customizing and Programming* for further information.

AOCGETCN

Examples

Task OPER1, on system FOC1, has obtained the default extended console name of OPER1. The command AOCGETCN is issued. The console AOPER1C1 will now be associated with OPER1.

AOCMSG

Purpose

AOCMSG displays and logs messages. AOCMSG merges variable data specified as parameter values in the AOCMSG call with fixed message text to produce an SA OS/390 message. You can display the resulting message on a NetView console and log it in the NetView log.

The message format depends on the message ID and variable data placed in the message.

If you specify one or more message classes in the message, AOCMSG also performs message class matching and sends the message as a notification message to one or more notification operators defined to receive those classes of notification messages.

AOCMSG uses the NetView message handling facilities, specifically NetView macros DSIMDS and DSIMBS. When you want to define user messages you must code a message definition module named AOFMaaa where aaa is the message prefix. Refer to *NetView Customization: Using Assembler* for the coding. Examples 1 and 2 in this section require a message definition module of AOFMABC.

The parsing within AOFMSG has been rewritten with an SA OS/390 parsing routine used instead of DSIPRS. This allows SA OS/390 to be more flexible in the handling of parameters. The parsing rules are:

- The only delimiter recognized in parsing the command is the comma.
- Tokens surrounded by single quotes will be stored without the quotes.
- A token containing two consecutive single quotes will be stored with only one of the quotes.
- Leading and trailing spaces are removed except that spaces inside quotes are not removed.
- Instead of rejecting a command with mismatched quotes an attempt is made to break the command into tokens.

The rules are illustrated by the following examples:

COMMAND	TOKENS
A,BCDEF, G	(A) (BCDEF) (G)
'A B C' , ' EF GH'	(A B C) (EF GH)
ABC,,DEF	(ABC) () (DEF)
'ABC,DEF,GHI	(ABC,DEF,GHI)
'ABC''DEF'	(ABC'DEF)
'ABC,DEF	('ABC) (DEF)
ABC'DEF	(ABC'DEF)
ABC'DEF'	(ABC'DEF')
'ABC'DEF	(ABC) (DEF)
'ABC'DEF'	(ABC) (DEF')
'ABC''DEF	(ABC) ('DEF)
ABC''	(ABC')

Note: AOCMSG has the facility to use MVS descriptor codes to control the message flow at the master console. Refer to *System Automation for OS/390 Messages and Codes* for a table of message types and descriptor codes used by AOCMSG.

Syntax

Parameters are positional.

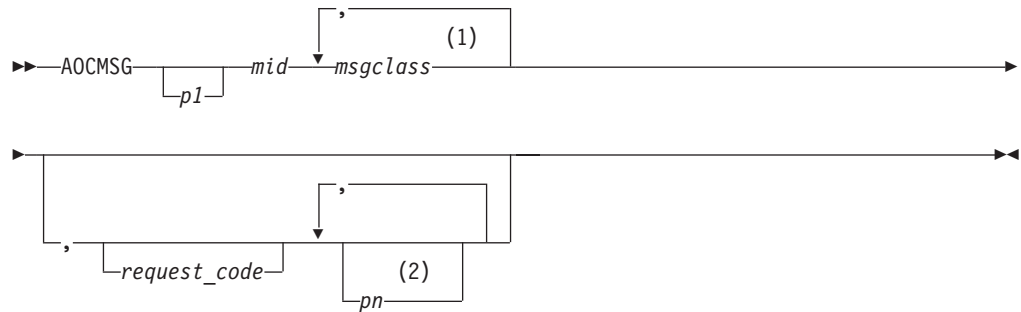

Notes:

- 1 Up to 10 optional message classes can be specified with the *mid* parameter. If used, message classes should be separated from the *mid* value and each other by at least **one** blank.
- 2 Parameters 2 to 9 may be specified here. Parameters are positional, so non-specified parameters must be represented by a comma.

Parameters

p1...p9

These are parameter values that are substituted into the message text (located in a NetView DSIMSG member) in place of NetView message variables &1 through &9, respectively. These parameter values are all optional. However, because parameters are positional, if you do not specify *p1*, you must code a comma for that parameter position, for example:

```
AOCMSG ,ABC123,,&DATE,&TIME
```

mid

The message ID to be issued. This parameter is required. The message ID must be a valid message installed in the NetView message library, that is, in data set members identified in DSIMSG. The message ID can be specified in the following ways:

- A 3-digit number, for which a prefix of AOF is assumed.
This message ID value relates to a message in DSIMSG member DSIAOF*nn*. For example, a message ID value of 203 is for SA OS/390 message AOF203I, which is in DSIMSG member DSIAOF20.
- A 6-digit ID consisting of a 3-character prefix followed by a 3-digit message ID number. The first character of the prefix must be alphabetic.
This message ID value relates to a message in DSIMSG member DSI*xxxnn*, where *xxx* is the prefix value and *nn* is the first two digits of the message ID number. For example, a message ID value of ABC123 is for message ABC123I, which is in DSIMSG member DSIABC12.

AOCMSG

- A 7-character ID consisting of a 4-character prefix followed by a 3-digit message ID number. The first character of the prefix must be alphabetic. The primary use for this type of message ID format is when coding a message ID for a message that has a 4-digit prefix.

When this type of message ID value is specified, AOCMSG drops the third of the four prefix characters to create the string used for searching DSIMSG members and retrieving the desired message. The actual message issued uses all four prefix characters.

For example, a message ID value of ABCD123 is used to retrieve message ABCD123I, which is in DSIMSG member DSIABD12 (note that the C is dropped in the DSIABD12 member name).

The message ID value can be up to 7 characters long.

Up to 10 optional dynamic message classes can be specified through the mid field. If specified, optional message classes will be merged with the message classes defined in the message member (if there are any) up to a maximum of 10 message classes. If the total number of message classes exceeds 10, then those specified on the AOCMSG call will take precedence over those specified in the message member.

The rules for dynamic message classes are the same as for those defined in the message member.

Message classes specified on the AOCMSG call will be taken into consideration for the following request_codes:

blank
LOG
MIM

When NOMID is used, any message classes specified on the AOCMSG call will be ignored. However, any message classes defined in the message member will continue to appear in the resulting message text.

request_code

This parameter specifies the type of message processing request the AOCMSG common routine performs. The value for this parameter can be one of the following:

Value Description

blank If you leave this parameter position blank, or enter any text other than the values listed below, AOCMSG will generate the message for display. This is the default.

LOG AOCMSG generates the message and logs the message in the NetView log instead of displaying it on the issuer's console.

MIM (Message in Message)

AOCMSG generates the message and strips the message ID value (*mid*) from the generated message, leaving only the message text. The first word in the message is treated as a valid message ID value (*mid*), and processing continues as if that word were the original *mid*. That is, AOCMSG performs message class matching and notification. See the AOCMSG examples for an example of how this parameter value affects the issued message.

NOMID (No Message ID)

AOCMSG generates the message and strips the message ID value (*mid*) from the generated message, leaving only the message text. AOCMSG does not perform message class matching and notification. See the AOCMSG examples for an example of how this parameter value affects the issued message.

Note: With the exception of the NOMID *request_code* value, forwarding of notification messages to notification operators occurs regardless of the value specified for this parameter.

Restrictions and Limitations

Each variable parameter value besides the message ID value (*mid*) can be up to 80 characters long, but the total maximum message length is 213 characters.

An operator can call this routine from an automation procedure or command processor, or issue it directly from a display station.

Return Codes

Return codes are:

0 AOCMSG processed normally.

>0 and <60

An error occurred while processing the NetView DSIPSS macro. The return code is actually from DSIPSS.

60 An error occurred while processing the NetView DSIGET macro to request storage. No storage space is available.

>60 An error occurred while processing the NetView DSIPRS macro.

Note: If you receive return codes other than 0 and 60, refer to *NetView Customization: Using Assembler* for information on resolving the NetView macro problems.

Error messages returned by AOCMSG are:

AOF262E MESSAGE ID mid INVALID, MUST BE "NNN", "ABCNNN", OR "ABCDNNN".

AOF263I MESSAGE ID NUMERIC "nnn" IS NOT NUMERIC.

AOF264I TOO FEW PARAMETERS ON AOCMSG COMMAND, 2 IS MINIMUM.

abc000I USER MESSAGE mid ISSUED BUT DOES NOT EXIST IN MESSAGE TABLE
DSIabcnn - CALL IGNORED.

Note: In message *abc000I*, the *abc* represents the product identifier portion of the message ID.

Usage

- Parameter values passed to AOCMSG depend on the format of the message entry as coded in the DSIMSG member *DSIxxxxm*.
- AOCMSG uses NetView message handling facilities, DSIMDS and DSIMBS in particular. Refer to *NetView Customization* for details on using DSIMDS for creating your own messages.

AOCMSG

- AOCMSG implements the SA OS/390 notification message function to allow you to forward messages to notification operators. This aspect of AOCMSG processing can be useful if you develop new messages and want notification operators to receive them.

The notification message function is implemented by assigning message classes to your messages. Message classes are assigned within the text of the messages in the DSIMSG member (DSI $xxxxm$). In the text for the message, specify the class or classes (up to five) after the message ID number and before the message text. For example, the following entry for a message assigns message classes 10 and 40 to the message. The message will be issued as a notification message to any notification operators defined to receive class 10 or 40 messages.

```
123I 10 40 THE EAGLE HAS &1
```

Examples

Example 1

Entries for messages in DSIMSG member DSIABC12 are as follows:

```
*****
120I ...
121I ...
122I &1 &2 ON THE &3
123I 10 40 THE EAGLE HAS &1
124I ...
*****
```

An automation procedure contains the following AOCMSG calls referencing messages ABC122 and ABC123.

```
<other automation procedure code>
:
AOCMSG HELP,ABC122,,IS,WAY
AOCMSG LANDED,ABC123
:
<other automation procedure code>
```

When AOCMSG is called as specified in the automation procedure, DSIMSG member DSIABC12 is searched for messages ABC122I and ABC123I. Variable substitution for the variables in the message entries occurs, resulting in the following messages being generated:

```
ABC122I HELP IS ON THE WAY
ABC123I THE EAGLE HAS LANDED
```

Note: Because the DSIMSG member entry for ABC122I does not specify message class information, only the issuer of the automation procedure receives the message, not any notification operators. Because the DSIMSG member entry for message ABC123I specifies message classes 10 and 40, notification operators defined to receive message classes 10 and 40 also receive message ABC123I.

Example 2

Use of the AOCMSG *request_code* parameter value NOMID has the following effect on the messages generated.

The same entries in DSIMSG member DSIABC12 are used.

The AOCMSG calls using the NOMID *request_code* parameter value are as follows:

```

<other automation procedure code>
:
AOCMSG HELP,ABC122,NOMID,IS,WAY
AOCMSG LANDED,ABC123,NOMID
:
<other automation procedure code>

```

These calls and the DSIABC12 entries result in the following messages:

```

HELP IS ON THE WAY
10 40 THE EAGLE HAS LANDED

```

Note: Note that in message ABC123I, the message classes 10 and 40 have not been processed as message classes and appear in the message text. No notification operators receive either message. This is an error for message ABC123. The message is not implemented to use the NOMID parameter value effectively.

Use of the AOCMSG *request_code* parameter value MIM has the following effect on the messages generated.

The same entries in DSIMSG member DSIABC12 are used.

The AOCMSG calls using the MIM request_code are as follows:

```

<other automation procedure code>
:
AOCMSG HELP,ABC122,MIM,IS,WAY
AOCMSG 'HELP 40',ABC122,MIM,IS,WAY
AOCMSG LANDED,ABC123,MIM
:
<other automation procedure code>

```

These calls and the DSIABC12 entries result in the following three messages:

HELP IS ON THE WAY

The text HELP is considered to be the new message ID. Because no message classes are in the AOCMSG call, no notification operators receive the message.

HELP IS ON THE WAY

In this case, the value 40 is processed as a message class. This processing causes notification operators defined to receive class 40 messages to also receive this message.

10 THE EAGLE HAS LANDED

The value 40 is processed as a message class, as in previous AOCMSG examples. In contrast, the value 10 is processed as the message ID, not a message class. Message ABC123 is not implemented to effectively use the MIM parameter value.

AOCQRES

Purpose

The AOCQRES routine examines and returns information about where a resource resides in a sysplex. Optionally, AOCQRES also tries to obtain status information on resources.

AOCQRES

Syntax



Parameters

subsystem_name

Specifies the name of the subsystem.

- * This causes the command to return information about all subsystems within the sysplex.

STATUS

If you specify STATUS, another column will be added to the output. This column contains the current automation status of each subsystem.

Return Codes

The following return codes can occur:

- 0 The AOCQRES command completed successfully.
- 1 An error occurred while processing the AOCQRES command. See the accompanying message for the cause of the error.
- 2 The specified subsystem is either unknown or currently not registered.

Usage

The command is to be used within a NetView PIPE statement.

Examples

When you issue the command:

```
PIPE NETV AOCQRES TSO (STATUS | SEP | STEM ABC.
```

within a REXX procedure and the system where this command is issued is in a sysplex with four systems, the stem variable ABC. will be assigned something similar to the following:

```
ABC.0 = 4
ABC.1 = TSO      TSO      KEY3      UP
ABC.2 = TSO      TSO      KEY4      AUTODOWN
ABC.3 = TSO      TSO      KEY5      STARTED
ABC.4 = TSO      TSO      KEY6      RESTART
```

The first token of the data is the subsystem name, the second token is the subsystem's job name, the third token is the system name and the last token is the subsystem's status.

AOCQRY

Purpose

The AOCQRY routine verifies that automation is allowed for a specific resource. AOCQRY does the following:

- Searches the automation policy to verify that the resource is defined to SA OS/390.

- Checks that the automation flags for that resource allow automation
- Initializes certain control variables for use by the calling automation procedure
- Drives automation flag exits
- Initializes AOCQRY TGLOBAL variables with application information

A call to AOCQRY is intended to be a standard component of most automation procedures. AOCQRY should be called whenever resource automation is required to verify whether automation should continue.

AOCQRY only works for applications that have been defined to automation using the application policy object of the customization dialogs.

Syntax

Parameters are positional.

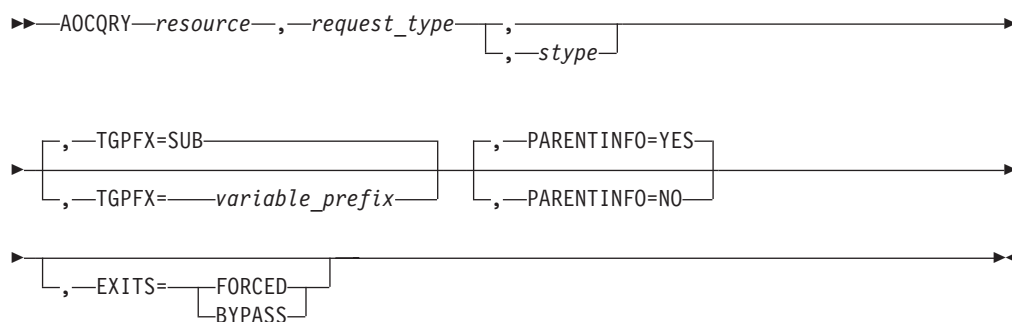

Parameters

For describing the AOCQRY command, minor resources are categorized as follows:

- Subsystem minor resources, for example, CICS.TRAN.APPL1
- MVS component minor resources, for example, MVSESA.SMF
- SUBSYSTEM default minor resources, for example, SUBSYSTEM.APPL
- Defaults minor resources, for example, DEFAULTS.APPL

resource

The resource name for which automation should be checked. This value can be a job name, subsystem name or a minor resource name. If *resource* is none of these and *stype* is coded, the resource is assumed to be an MVS component minor resource. For example, AOCQRY SMF RECOVERY MVSESA is equivalent to AOCQRY MVSESA.SMF RECOVERY MVSESA. When checking a minor resource, the application job name can be substituted for the application name. This parameter is required.

request_type

The type of automation checks and information retrieval functions AOCQRY performs. Request type is required and must be one of the following:

Value	Description
-------	-------------

AUTOMATION	Only the Automation flag is checked to determine whether automation is allowed. Data retrieval from the automation control file and
-------------------	---

automation status file occurs as described under the CFGINFO and STATUS options. If the third parameter, *stype*, is coded, data retrieval does not occur.

INITSTART

The Automation flag and the Initstart flag are checked in determining whether automation is allowed. Data retrieval from the automation control file and automation status file occur as described under the CFGINFO and STATUS options. If the *stype* parameter is coded data retrieval does not occur.

START

The Automation flag and the Start flag are checked in determining whether automation is allowed. Data retrieval from the automation control file and automation status file occur as described under the CFGINFO and STATUS options. If the *stype* parameter is coded data retrieval does not occur.

RECOVERY

The Automation flag and the Recovery flag are checked in determining whether automation is allowed. Data retrieval from the automation control file and automation status file occur as described under the CFGINFO and STATUS options. If the *stype* parameter is coded data retrieval does not occur.

TERMINATE

The Automation flag and the Shutdown flag are checked in determining whether automation is allowed. Data retrieval from the automation control file and automation status file occur as described under the CFGINFO and STATUS options. If the *stype* parameter is coded data retrieval does not occur.

RESTART

The Automation flag and the Restart flag are checked in determining whether automation is allowed. Data retrieval from the automation control file and automation status file occur as described under the CFGINFO and STATUS options. If the *stype* parameter is coded data retrieval does not occur.

CFGINFO

Selected information for an application is retrieved from the automation control file and returned to the calling automation procedure through predefined TGLOBALs. Information is retrieved for both the application and the application parent. This parameter is mutually exclusive with the *stype* parameter. Supported TGLOBALs are documented in "TGLOBALs" on page 47.

CFGONLY or CFG-ONLY

Selected information for an application is retrieved from the automation control file and returned to the calling automation procedure through predefined TGLOBALs. Information is retrieved only for the application. Parent TGLOBAL information is not affected by this option. If the resource is a minor resource, information retrieval will be performed for the application. This parameter is mutually exclusive with the *stype* parameter. Supported TGLOBALs are documented in "TGLOBALs" on page 47.

STATUS

Selected information for an application is retrieved from the automation control file, as previously noted under the CFGINFO

option, and from the automation status file. This information is returned to the calling automation procedure through predefined TGGLOBALS. Information is retrieved for both the application and the application parent. If the resource is an application minor resource, information retrieval will be performed for the application. This parameter is mutually exclusive with the *stype* parameter. Supported TGGLOBALS are documented in “TGGLOBALS” on page 47.

STATUS-ONLY

The only data returned for an application is the status from the automation status file. It is returned to the calling automation procedure through the predefined TGGLOBAL, SUBSSTAT which is described in the section on “TGGLOBALS” on page 47. No other TGGLOBALS are set. Retrieval is only done for the application. Parent information is not affected by this option. If the resource is an application minor resource, information retrieval will be performed for the application. This parameter is mutually exclusive with the *stype* parameter.

stype

The named resource is not defined as an application in the automation control file or as an application minor resource. This parameter is mutually exclusive with the *request_type* values CFGINFO, CFG-ONLY, CFGONLY, STATUS or STATUS-ONLY. For any other *request_type*, functions performed for the CFGINFO and STATUS options are bypassed if variable *stype* is coded. Checking automation flags occurs as normally performed for the specified *request_type*.

This value is usually coded for minor resources, in which case the value is explicitly coded as the variable AOFSYSTEM. AOFSYSTEM is a CGLOBAL containing MVSESA. This value is specified using the AUTOMATION SETUP policy item of the system policy object in the customization dialogs.

TGPFX=*variable_prefix*

Specifies the variable prefix used to create the TGGLOBAL variable names used with AOCQRY.

The value of *variable_prefix* must be 3 characters long and defaults to SUB.

If you are calling AOCQRY from a routine which is driven from the automation control file you must specify TGPFX=*something_other_than_sub* or you will corrupt the task globals used by the routine that is driving your routine. This can lead to unpredictable behavior.

PARENTINFO

Specifies whether parent TGGLOBAL information is retrieved.

The following values can be specified:

YES

Parent TGGLOBAL information is retrieved. If the dependency has a sequence number, then PARENTINFO defaults to YES. Otherwise, PARENTINFO=NO applies.

Note: If the subsystem has multiple dependencies with sequence numbering, then information is obtained for the resource with sequence number one only. If information is required for all the supporting resources, then AOCQRY must be issued for each of them. A list of the supporting resources can be obtained from the SUBSPARENT TGGLOBAL.

AOCQRY

NO

Parent TGLOBAL information is not obtained.

EXITS

This parameter determines how automation flag exits are invoked. The following values can be specified:

FORCED

When FORCED is specified, automation flag exits are invoked regardless of the automation flag setting.

BYPASS

When BYPASS is specified, regular processing will continue for the automation flag setting.

Restrictions and Limitations

This routine can only be called by another automation procedure or a command processor.

Return Codes

Return codes are:

- 0 Function completed successfully. If checking an automation flag, automation is allowed.
- 1 Global Automation flag is off.
- 2 The specific automation flag is turned off.
- 3 A valid application entry was not found in the automation control file. Not used if *stype* parameter is coded.
- 4 Incorrect parameters were used in the call.
- 5 Timeout or other error occurred.
- 6 SA OS/390 initialization incomplete, unable to process command request.

Note: If AOCQRY processes with a return code of > 3, confirm the TGLOBALs returned to the calling automation procedure. TGLOBAL values may not be set as expected when return codes > 3 occur.

Usage

- AOCQRY accesses the automation control file and automation status file. It uses the application definition information and automation flag settings to determine whether automation should continue.
- Return codes 1 and 2, which specify that automation is turned off, are set when Automation flags are set to NO or are disabled for a certain time.
- Return code 3 (application not defined to automation) indicates that messages for the application should not be automated.
- The AOCQRY routine searches the automation flags in a predefined sequence to decide whether automation should continue. The first Automation flag entry defined in the automation policy governs whether automation is allowed. The search order is:
 1. The flags associated with the SUBSAPPL TGLOBAL value.
Typically, this value is the application or resource name.
 2. The flags associated with the SUBSTYPE TGLOBAL value.
Typically, this value is the SUBSYSTEM or the &AOFSSYSTEM CGLOBAL value.
 3. The flags associated with DEFAULT.

Refer to “TGLOBALS” for descriptions of the contents of the TGLOBAL fields in different situations.

- If the *request_type* is coded as Initstart, Start, Recovery, Terminate or Restart, a two-level search is performed. The predefined sequence previously described is searched twice, once for the Automation flag, and again for the specific automation flag. If the Automation flag turns off automation, the second search is not performed and the AOCQRY processing terminates.
- Minor Resource flags are resolved as follows:

Begin the search with the lowest qualifier of the minor resource. Do until the flag is resolved:

 1. If the effective automation flag is not resolved, check the Automation flag else proceed to 2.

If the Automation flag is not set proceed to 2.

If the Automation flag is off or a user exit is coded that evaluates to off, the effective automation flag is off. If *request_type=automation* returns 2 (specific off) and terminate search, else return 1 (global automation off) and terminate search.

If the Automation flag is on, the effective automation flag is on. If *request_type=automation* return 0 (on) and terminate search. If the effective specific flag has been resolved, return “0” (on) and terminate search, else proceed to 2.
 2. If *request_type=automation* proceed to 3.

If the effective specific flag has not been resolved, check the specific flag else proceed to 3.

If the specific flag is not set proceed to 3.

If the specific flag is off or a user exit is coded that evaluates to off then the effective specific flag is off. Return “2” (specific off) and terminate search.

If the specific flag is on, then the effective specific flag is on. If the effective automation flag has been resolved (must be on), return “0” (on) and terminate search, else proceed to 3.
 3. Start the search at the next highest qualifier.

If this search fails to resolve the flag then the predefined sequence described previously is performed.

Note: Subsystem flags will always have a value, either defined explicitly in automation policy, or inherited from defaults.

TGLOBALS

There are three main groups of AOCQRY TGLOBALs:

- Application information TGLOBALs (SUBSxxxx)
- Parent information TGLOBALs (SUBPxxxx)
- Automation flag TGLOBALs

When *stype* is not coded in the AOCQRY call, the following apply:

- All TGLOBALs are modified unless parent information is not requested or parent information is not valid.
- Any application data fields not specified in the automation policy are null values, except:
 - SUBxSHUTDLY, which defaults to 00:02:00 (2 minutes)
 - SUBxSTRTCMD, which defaults to NO
 - SUBxRSTOPT, which defaults to ABENDONLY

AOCQRY

(The *x* value is either S or P, depending on whether the TGLOBAL is for the application or parent.)

- If an application entry is not found, the TGLOBALS are not altered from previous settings.

When *stype* is coded in the AOCQRY call and *stype* does not have a value of SUBSYSTEM, then only SUBSAPPL, SUBSTYPE and AUTOTYPE are modified. All other TGLOBALS retain their previous value.

Table 5 lists AOCQRY application TGLOBALS (SUBSxxxx TGLOBALS).

Table 5. AOCQRY Subsystem TGLOBALS

TGLOBAL	Description								
SUBSAAAUTO	The application Automation assist mode setting (DISPLAY, LOG, or NONE).								
SUBSAAISTRT	The application Initstart assist mode setting (DISPLAY, LOG, or NONE).								
SUBSAAARCVRY	The application Recovery assist mode setting (DISPLAY, LOG, or NONE).								
SUBSAAARSTRT	The application Restart assist mode setting (DISPLAY, LOG, or NONE).								
SUBSAAASTART	The application Start assist mode setting (DISPLAY, LOG, or NONE).								
SUBSAAATRMN8	The application Shutdown (Terminate) assist mode setting (DISPLAY, LOG, or NONE).								
SUBSAFAUTO	The application Automation flag setting. This TGLOBAL value may be: <table border="1"> <thead> <tr> <th>Value</th> <th>Description</th> </tr> </thead> <tbody> <tr> <td>Y</td> <td>Yes, automation on</td> </tr> <tr> <td>N</td> <td>No, automation off</td> </tr> <tr> <td>E</td> <td>Exit, an automation flag exit is used for this flag.</td> </tr> </tbody> </table>	Value	Description	Y	Yes, automation on	N	No, automation off	E	Exit, an automation flag exit is used for this flag.
Value	Description								
Y	Yes, automation on								
N	No, automation off								
E	Exit, an automation flag exit is used for this flag.								
	These values apply to other automation flag setting TGLOBALS.								
SUBSAFISTRT	The application Initstart automation flag setting (Y, N, or E).								
SUBSAFRVCVRY	The application Recovery automation flag setting (Y, N, or E).								
SUBSAFRSTRT	The application Restart automation flag setting (Y, N, or E).								
SUBSAFSTART	The application Start automation flag setting (Y, N, or E).								
SUBSAFTRMN8	The application Shutdown (Terminate) automation flag setting (Y, N, or E).								
SUBSAPPL	The application name from the automation control file. If <i>stype</i> was coded, this TGLOBAL contains the resource name.								
SUBSASID	The address space ID of the application. This is only available when SA OS/390 process monitoring is used for this resource.								
SUBSFILE	Contains the information which file this resource represents.								
SUBSCMDPFX	The application command prefix from the automation control file.								
SUBSDESC	The application description from the automation control file.								
SUBSEXTSTART	Contains the 'External Start' information.								
SUBSEXTSTOP	Contains the 'External Stop' information.								
SUBSIPOPT	The application IPL option from the automation control file.								
SUBSJOB	The application job name from the automation control file.								
SUBSJOBTYPE	The subsystem jobtype from the automation control file (MVS/NONMVS/TRANSIENT).								
SUBSMDATE	The date the last monitor cycle checked the subsystem.								
SUBSMTIME	The time the last monitor cycle checked the subsystem.								
SUBSOPER	The work operator assigned to the subsystem.								
SUBSPARENT	A list of the application parent names from the automation control file. The parent names are separated by blanks. This is only provided if dependencies with a sequence number were specified in the dialog.								
SUBSPATH	Contains the information which OS/390 UNIX process this resource represents.								
SUBSPORT	Contains the information which TCP port this resource represents.								
SUBSPROC	Contains the subsystem's PROCNAME.								
SUBSPROCESS	Contains the current process (START, STOP, or null).								
SUBSRCYOPT	The application recycle option from the automation control file.								
SUBSRSTOPT	The application restart information from the automation control file.								

Table 5. AOCQRY Subsystem TGLOBALs (continued)

TGLOBAL	Description
SUBSSCHEDSS	The application scheduling subsystem from the automation control file. If not specified, it defaults to the primary scheduling subsystem.
SUBSSDATE	The date the status of the subsystem was last updated.
SUBSSESS	The subsystem name from the automation control file.
SUBSSHUTDLY	The application shutdown delay value from the automation control file.
SUBSSHUTOPT	The application shutdown option from the automation control file. This will be null if SHUTOPT=NO, or will be a list of parents if SHUTOPT=PARENT or SHUTOPT=(parent list).
SUBSSPARM	The application parameter data from the automation control file.
SUBSSSTAT	The application status from the automation status file.
SUBSSTIME	The time the status of the subsystem was last updated.
SUBSSTRTCYC	The application start cycles from the automation control file.
SUBSSTRTDLY	The application start delay from the automation control file.
SUBSSUBTYPE	The subsystem type (JES2, JES3, DB2®, CICS®, or IMS).
SUBSTERMDLY	The application termination delay from the automation control file.
SUBSTRANTY	Used by transient subsystems to indicate whether or not they can be rerun.
SUBSTYPE	This TGLOBAL indicates the resource for which the automation flag checking is performed. For an application, the value for this TGLOBAL is SUBSYSTEM. For resources other than applications, the value for this TGLOBAL is the value coded for <i>stype</i> on the AOCQRY call. If an application entry was not found, the TGLOBAL value is NONE.
SUBSUSER	Contains the information which OS/390 UNIX user ID this resource belongs to.
SUBSUSSJOB	The real job name of the application. This is only available when SA OS/390 process monitoring is used for this resource.
SUBSWLMNAME	The workload manager name from the automation control file.

Table 6 lists AOCQRY parent TGLOBALs (SUBPxxxxx TGLOBALs).

Table 6. AOCQRY Parent TGLOBALs

TGLOBAL	Description
SUBPAAAUTO	The parent Automate assist mode setting (DISPLAY, LOG, or NONE).
SUBPAAISTRT	The parent Initialize assist mode setting (DISPLAY, LOG, or NONE).
SUBPAAARCVR	The parent Recover assist mode setting (DISPLAY, LOG, or NONE).
SUBPAAARSTRT	The parent Restart assist mode setting (DISPLAY, LOG, or NONE).
SUBPAAASTART	The parent Start assist mode setting (DISPLAY, LOG, or NONE).
SUBPAAATRMN8	The parent Shutdown (terminate) assist mode setting (DISPLAY, LOG, or NONE).
SUBPAFAUTO	The parent Automation flag setting (Y, N, or E).
SUBPAFISTR	The parent Initstart automation flag setting (Y, N, or E).
SUBPAFRVCVR	The parent Recovery automation flag setting (Y, N, or E).
SUBPAFRSTRT	The parent Restart automation flag setting (Y, N, or E).
SUBPAFSTART	The parent Start automation flag setting (Y, N, or E).
SUBPAFTRMN8	The parent Shutdown (Terminate) automation flag setting (Y, N, or E).
SUBPAPPL	The parent application name.
SUBPASID	The parent address space ID. This is only available when SA OS/390 process monitoring is used for this resource.
SUBPCMDPFX	The parent command prefix from the automation control file.
SUBPDESC	The parent description
SUBPEXTSTART	Contains the 'External Start' information.
SUBPEXTSTOP	Contains the 'External Stop' information.
SUBPFILE	Contains the information which file the parent represents.
SUBPIPLOPT	The parent IPL option from the automation control file.
SUBPJOB	The parent job name
SUBPJOBTYPE	The parent subsystem jobtype from the automation control file (MVS/NONMVS/TRANSIENT).

AOCQRY

Table 6. AOCQRY Parent TGLOBALs (continued)

TGLOBAL	Description
SUBPMDATE	The date the last monitor cycle checked the parent subsystem.
SUBPMTIME	The time the last monitor cycle checked the parent subsystem.
SUBPOPER	The work operator assigned to the parent.
SUBPPARENT	A list of the parent names from the automation control file. The parent names are separated by blanks. This is only provided if dependencies with a sequence number were specified in the dialog.
SUBPPATH	Contains the information which OS/390 UNIX process the parent represents.
SUBPPORT	Contains the information which TCP port the parent represents.
SUBPRCYCOPT	The parent subsystem recycle option from the automation control file.
SUBPPROC	Contains the subsystem's PROCNAME.
SUBPPROCESS	Contains the current process (START, STOP, or null).
SUBPRSTOPT	The parent restart information
SUBPSCHEDSS	The scheduling subsystem for the parent, from the automation control file. If not specified, it defaults to the primary scheduling parent.
SUBPSDATE	The date the status of the parent system was last updated.
SUBPSESS	The parent subsystem name from the automation control file.
SUBPSHUTDLY	The parent shutdown delay value
SUBPSHUTOPT	The application shutdown option from the automation control file. This will be null if SHUTOPT=NO, or will be a list of parents if SHUTOPT=PARENT or SHUTOPT=(parent list).
SUBPSPARM	The parent parameter data
SUBPSTAT	The parent status
SUBPSTIME	The time the status of the parent system was last updated.
SUBPSTRTCYC	The parent start cycles from the automation control file.
SUBPSTRTDLY	The parent start delay from the automation control file.
SUBPSUBTYPE	The subsystem type of the parent subsystem.
SUBPTERMDLY	The parent termination delay from the automation control file.
SUBPTRANTY	If the parent subsystem is a transient, this indicates whether or not it can be rerun.
SUBPTYPE	This TGLOBAL indicates the resource for which the automation flag checking is performed. For an application, the value for this TGLOBAL is SUBSYSTEM. For resources other than applications, the value for this TGLOBAL is the value coded for <i>stype</i> on the AOCQRY call. If an application entry was not found, the TGLOBAL value is NONE.
SUBPUSER	Contains the information which OS/390 UNIX user ID the parent belongs to.
SUBPUSSJOB	The real parent job name. This is only available when SA OS/390 process monitoring is used for this resource.
SUBPWLMNAME	The workload manager name from the automation control file.

Note: The SUBP variables are only available if dependencies with a sequence number were specified in the customization dialog.

Table 7 on page 51 lists AOCQRY automation flag TGLOBALs.

Table 7. AOCQRY Automation Flag TGLOBALs

TGLOBAL	Description
AUTOTYPE	<p>The AUTOTYPE TGLOBAL contains the value of the automation mode that is turned off. Depending on certain conditions, AUTOTYPE has the following values:</p> <p>Value Condition</p> <p>Null Automation is allowed.</p> <p>Null <i>request_type</i> does not check automation flags.</p> <p>GLOBAL Either the Automation (global) automation flag is off; or both Automation and specific flags are off.</p> <p>INITSTART Initstart automation flag is off.</p> <p>RECOVERY Recovery automation flag is off.</p> <p>RESTART Restart automation flag is off.</p> <p>START Start automation flag is off.</p> <p>TERMINATE Shutdown automation flag is off.</p>
ASSIST	The Assist Mode setting for the automation flag.
EHKEXITRSN	The return code from the exit if a nonzero return code.
EHKEXITNME	The name of the exit supplying the nonzero return code.

Examples

Example 1

This example shows the relationship between AOCQRY and automation policy values. The message to automate is produced by the CICST subsystem during termination. The particular message identifier is not important for this example. The example automation procedure verifies that automation is allowed by calling AOCQRY.

This example uses the following automation policy information:

```

AOFKAAU          SA OS/390 - Command Dialogs          Line 1 of 23
Domain ID = IPSNO ----- DISPFLGS -----          Date = 07/19/00
Operator ID = NETOP1                                     Time = 18:08:48
System = KEY3
Resource         Actual      Effective      Settings
                  A I S R D RS  A I S R D RS
-----
DEFAULTS        Y Y Y Y Y Y  Y Y Y Y Y Y  - No explicit setting
MVSESA          - - - Y - -  Y Y Y Y Y Y  N Turned off
LOGREC          - - - N - -  Y Y Y N Y Y  E Consult exit
MVSDUMP         - - - Y - -  Y Y Y N Y Y  Y Turned on
SCU0040         - - - Y - -  Y Y Y Y Y Y  ? Error
SCU0050         - - - Y - -  Y Y Y Y Y Y
SCU0060         - - - Y - -  Y Y Y Y Y Y  Flags
SCU0070         - - - Y - -  Y Y Y Y Y Y
SCU0080         - - - Y - -  Y Y Y Y Y Y
SCU0090         - - - Y - -  Y Y Y Y Y Y  A Automation
SMFDUMP         - - - Y - -  Y Y Y Y Y Y  I Initial start
SYSLOG          - - - N - -  Y Y Y N Y Y  S Start up
TAPES           - - - Y - -  Y Y Y Y Y Y  R Recovery
WTOBUF         - - - Y - -  Y Y Y Y Y Y  D Shut down
SUBSYSTEM      - - - - - -  Y Y Y Y Y Y  RS Restart
CICST           Y - - - - -  N N N N N N
TRAN            - - - Y - -  N N N N N N
ABC123         - - - N - -  N N N N N N
PIMS            - - - - - -  Y Y Y Y Y Y
DFS554A        - - - Y - -  Y Y Y Y Y Y
TRANS1         - - - N - -  Y Y Y N Y Y
TRANS2         - - - Y - -  Y Y Y Y Y Y
TRANS3         N - - - - -  N N N N N N

Command ==>
PF1=Help      PF2=End          PF3=Return      PF6=Roll
               PF9=Refresh      PF12=Retrieve
    
```

Figure 3. DISPFLGS Sample Panel

```

AOFK3D0X          SA OS/390 - Command Response          Line 1 of 13
Domain ID = IPSNO ----- DISPACF -----             Date = 07/19/00
Operator ID = ROLI                                     Time = 17:43:05

Command = ACF ENTRY=SUBSYSTEM,TYPE=CICST,REQ=DISP
SYSTEM = KEY3      AUTOMATION CONFIGURATION DISPLAY - ENTRY= SUBSYSTEM
-----
AUTOMATION CONFIGURATION DISPLAY - ENTRY= SUBSYSTEM
TYPE IS CICST
JOBTYPE          = MVS
RESTARTOPT       = ALWAYS
TERMDLY          = 00:00:12
EXTSTART         = NEVER
IPLOPTIONS       = NOSTART
JOB              = CICST
PARENT           = (VTAM)
SDESC            = 'TEST-CICS'
SHUTDLY          = 00:02:00
STRTDLY          = 00:03:00
END OF MULTI-LINE MESSAGE GROUP

Command ==>
PF1=Help      PF2=End      PF3=Return      PF6=Ro11
                PF9=Refresh  PF12=Retrieve

```

Figure 4. DISPACF Sample Panel

The automation procedure to call AOCQRY is:

```

/* REXX CLIST to check if termination automation is allowed for VTAM */
'AOCQRY CICST,TERMINATE'
Select
  When rc = 0 Then Do /* Automation on; perform actions req'd. */
    :
  End
  When rc = 1 | rc = 2 Then Do /* Automation off; If applicable log a
    message indicating unable to take
    action for message. */
    :
  End
  When rc = 3 Then Exit /* Subsystem not automated */
  Otherwise Do /* Error; log error message */
    :
  End
End
Exit

```

The subsystem CICST has a HasParent relationship to VTAM[®]. AOCQRY accesses both subsystem definitions to fill in the AOCQRY TGLOBALs. All the SUBSxxx TGLOBALs are filled in with the CICST subsystem information, and the SUBPxxx TGLOBALs are filled in with the VTAM information. The automation status file is accessed for the CICST and VTAM subsystems to fill in the SUBxSTAT field.

Following are processing steps the example automation procedure performs:

1. The automation procedure calls AOCQRY, supplying the subsystem name and TERMINATE as the *request_type*. AOCQRY gets the appropriate subsystem information, and then searches for the automation flags.
2. Upon return from AOCQRY, the automation procedure determines what the return code was, then takes the appropriate action.

Example 2

AOCQRY

This example uses the same scenario as in Example 1, but shows how to improve the coding technique. The message to automate is produced by the CICST subsystem during shutdown. The particular message identifier is not important for this example. The automation procedure verifies automation is allowed by calling AOCQRY.

The automation procedure to call AOCQRY is:

```
/* REXX CLIST to check if termination automation is allowed for a job
- generic check dependant on Jobname */
'AOCQRY 'Jobname()',TERMINATE'
Select
  When rc = 0 Then Do /* Automation on; perform actions req'd. */
  :
  End
  When rc = 1 | rc = 2 Then Do /* Automation off; If applicable log a
  message indicating unable to take
  action for message. */
  :
  End
  When rc = 3 Then Exit /* Subsystem not automated */
  Otherwise Do /* Error; log error message */
  :
  End
End
Exit
```

This example differs from Example 1 in the following way:

AOCQRY uses NetView REXX function Jobname() for the *resource* field. This function returns the name of the job issuing the message. Using a function, the automation procedure can be written to support a specific message for any job that can issue that message. This allows portability of the automation procedure to different systems without requiring changes to the automation procedure. The job name is supplied only to an automation procedure called from the NetView automation table. If your automation procedure issues WAIT commands, you must issue the Jobname() function upon entry, because the value returned resets whenever the WAIT command is issued.

Example 3

This example differs from Examples 1 and 2 by automating an MVS component. The message to automate is produced by MVS indicating that an SMF dump data set is full. The particular message identifier is not important for this example. The automation procedure verifies that automation is allowed by calling AOCQRY.

Automation policy information for this example is the same as for Examples 1 and 2.

The automation procedure to call AOCQRY is:

```
/* REXX CLIST to check if recovery automation is allowed for SMF */
'GLOBALV GETC AOFSYSTEM'
'AOCQRY SMFDUMP,RECOVERY,'aofsystem'
Select
  When rc = 0 Then Do /* Automation on; perform actions req'd. */
  :
  End
  When rc = 1 | rc = 2 Then Do /* Automation off; If applicable log a
  message indicating unable to take
  action for message. */
  :
  End
End
```

```

End
Otherwise Do          /* Error; log error message          */
:
End
End
Exit

```

This example differs from the previous examples in the following ways:

- When automating an MVS component, use a generic component as the *resource* name when calling AOCQRY. Using the message identifier is possible but not recommended, because several messages may relate to a single MVS component to be automated.
- The third parameter, *stype*, is coded. Coding *stype* tells AOCQRY to skip the process of finding subsystem entries. The example uses SA OS/390 variable AOFSYSTEM as the *stype* parameter. The value of the variable is MVSESA.
- Return code 3 is not valid, because the application entries in the automation control file are not checked.

All other coding notes in Examples 1 and 2 pertain to calling AOCQRY for an MVS component.

Example 4

This example shows the type of information retrieved by AOCQRY for minor resources given the flag settings of Example 1 on the SA OS/390 DISPFLGS panel:

Actual Resource	Effective											
	A	I	S	R	D	RS	A	I	S	R	D	RS
DEFAULTS	Y	-	-	-	-	-	Y	Y	Y	Y	Y	Y
MVSESA	-	-	-	-	-	-	Y	Y	Y	Y	Y	Y
DUMP	N	-	-	-	-	-	N	N	N	N	N	N
LOGREC	Y	-	-	-	-	-	Y	Y	Y	Y	Y	Y
SMFDUMP	-	-	-	N	-	-	Y	Y	Y	N	Y	Y
SUBSYSTEM	Y	-	-	-	-	-	Y	Y	Y	Y	Y	Y
TSO	Y	-	-	-	-	-	Y	Y	Y	Y	Y	Y
TRAN1	N	-	-	Y	-	-	N	N	N	N	N	N
ABC	Y	N	-	-	-	-	Y	N	Y	Y	Y	Y

These AOCQRY commands yield the following return codes and information:

AOCQRY Command	RC	Information Retrieved (see Key)
AOCQRY PIMS.DFS554A.TRANS1 AUTOMATION	2	ACF/ASF for PIMS,AF
AOCQRY PIMS.DFS554A.TRANS2 RECOVERY	0	ACF/ASF for PIMS,AF
AOCQRY PIMS.DFS554A.TRANS3 RECOVERY	1	ACF/ASF for PIMS,AF
AOCQRY PIMS CFGINFO	0	ACF for PIMS
AOCQRY IMS123 STATUS where IMS123 is the job name of PIMS	0	ACF/ASF for PIMS
AOCQRY SMFDUMP RECOVERY MVSESA	2	SUBSAPPL/TYPE,AF
AOCQRY MVSESA.SMFDUMP RECOVERY MVSESA	1	SUBSAPPL/TYPE,AF
AOCQRY MVSESA.SMFDUMP RECOVERY	3	

Key:

ACF Automation control file TGLOBALs
ASF Automation status file TGLOBALs
AF Automation flag TGLOBALs

AOCUPDT

Purpose

AOCUPDT performs several status update functions, including:

- Updating subsystem status.
- Identifying any messages associated with the subsystem status change and processing options performed for these messages:
 - Whether a message is issued and logged in the NetView log
 - Which message is issued
 - Whether the message is sent as a notification message to notification operators on a local system (distinct from forwarding to a focal-point system)
 - Whether the message is forwarded to a focal-point system

AOCUPDT calls common routine AOCMSG to handle processing of log and notification messages.

- Updating SDF status displays with the resource status change.
- Updating the automation manager OBSERVED status.

Syntax

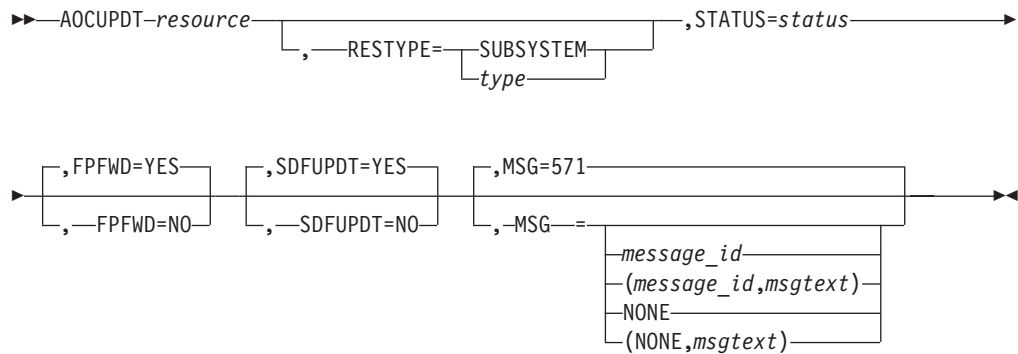

Parameters

resource

The name of the resource for which status or information updates specified by other AOCUPDT parameters are performed. This value is required and must be specified first on an AOCUPDT call. You can use the following formats for *resource*. Use the *inresource* variable to specify a resource on which the resource is dependent; that is, the parent resource.

Format	Example
<i>system_name.resource/inresource</i>	PROD.TSO/VTAM
<i>resource/inresource</i>	TSO/VTAM
<i>system_name.resource</i>	PROD.TSO
<i>resource</i>	TSO

The *system_name* variable defaults to AOFSYSNAME. The *inresource* variable defaults to the RESTYPE value. The specification or default to a value of SUBSYSTEM for *inresource* will result in a value of SUBSYS being used.

RESTYPE

Identifies the type of resource for the *resource* parameter. You can specify a resource type of your own choice, with the exception of SYSTEM which is reserved for internal use only. The default is SUBSYSTEM.

type

A resource type of your own choice

SUBSYSTEM

A resource type of SUBSYSTEM

STATUS

Specifies the new resource status value.

When you use this parameter to change status, some other AOCUPDT parameters perform default actions, unless otherwise coded. These parameters include:

MSG

FPFWD

SDFUPDT

If you specify STATUS to change status, but do not specify any of the parameters listed above (thereby using parameter defaults), the following occurs:

- SA OS/390 issues message AOF571I, *resource_name* SUBSYSTEM STATUS FOR JOB *jobname* IS *status—text* and also logs the message in the NetView log.
- Message AOF571I is forwarded to a focal point system, if one exists in your configuration.
- The specified status change is reflected in SDF status panels.

To change the values or actions performed by the MSG, FPFWD, and SDFUPDT parameters, or to preclude their use, you must specify those parameters and desired values.

If a status value which has a length greater than eight characters is used, the status value is truncated to a length of eight characters.

FPFWD

Determines whether the specified status is sent from a local system (the system on which AOCUPDT is issued) to a focal-point system.

YES

The status is sent. This is the default.

NO

The status is not sent.

Note: For status forwarding to a focal-point system to occur, you must already have configured an automation network and defined the automation network to SA OS/390. Refer to *System Automation for OS/390 User's Guide* for details.

SDFUPDT

Determines whether the specified status change is also reflected in SDF status displays.

AOCUPDT

YES

The status change is reflected in SDF status displays. This is the default if STATUS is specified.

NO

The status change is not reflected in SDF status displays. This is the default if STATUS is not specified.

MSG

This parameter identifies the message associated with the status change specified on the STATUS parameter. This message is issued to note when the status change occurs. This parameter is applicable only if the STATUS parameter is also specified.

The default is 571, the message ID for SA OS/390 status change message AOF571I, *resource_name* SUBSYSTEM STATUS FOR JOB *jobname* IS *status*—*text*.

This parameter value can be specified using the following formats:

message_id

Identifies the numeric part of a message ID. For example, 571 specifies SA OS/390 message AOF571I.

(*message_id*)

The complete message ID, including message prefix and message number, enclosed in parentheses, for example, (AOF123).

(*message_id,msgtext*)

The complete message ID, including message prefix and message number, plus message text to be substituted for message variables in the message text. This entire specification is enclosed in parentheses, for example, (123,AA,BB,CC). Quotation marks are not allowed in the message text.

The AOCMSG common routine substitutes the message text values into message variables &1 through &9 in the fixed message text located in the NetView message library. See “AOCMSG” on page 36 for details on how that common routine works. Some message variables are preset to certain values depending on the message ID and message text specified on the AOCUPDT call. Following are details on how the message variables are preset.

- Variable &1 is always set to AOFRUPDT, which is the name of the automation procedure in which the AOCUPDT command processor resides.
- If the message text is omitted, the following message variables are preset:

Var	Setting
&1	AOFRUPDT
&2	Time
&3	<i>system_name.resource</i>
&4	Resource type
&5	Subsystem name
&6	Subsystem job name
&7	Status

- If the message text is provided and the *message_id* number is 571, the following message variables are preset:

Var	Setting
&1	AOFRUPDT
&2	Time

&3	<i>system_name.resource</i>
&4	Resource type
&5	Subsystem name
&6	Subsystem job name
&7	Status

Variables &8 and &9 can be assigned values from the *msgtext* portion of this parameter.

- If the message text is provided and the *message_id* number is not 571, the following message variables are preset:

Var	Setting
&1	AOFRUPDT
&2	Time
&3	<i>system_name.resource</i>
&4	Resource type

Variables &5 through &9 can be assigned values from the *msgtext* portion of this parameter.

NONE

The operator is not notified that the update has taken place. The text string "RESOURCE *resource_name* STATUS UPDATED TO *status_value*" is written to SDF.

(NONE,*msgtext*)

The operator is not notified that the update has taken place. The text string "*msgtext*" is written to SDF.

Restrictions and Limitations

AOCUPDT has the following restrictions and limitations:

- Use AOCUPDT instead of ASF to perform dynamic status updates to SA OS/390 status files.
- AOCUPDT should only be issued from an automation procedure.
- Parentheses appearing within message text must be properly paired and balanced.
- Using AOCUPDT to change a resource status *only* changes the status. It does not initiate any associated status change processing that occurs if the status change is processed through a generic routine such as ACTIVMSG or TERMMSG. Also, the automation status remains unchanged. For example, if the resource is involved in a STARTUP, and the resource's status is changed to UP via AOCUPDT, then this process will not be affected because the automation status will not be changed to IDLE.

Return Codes

Return codes are:

- | | |
|----|---|
| 0 | AOCUPDT processed normally. |
| 4 | All requested actions were performed. However, the system detected that some of the data to be changed was the same as the modified data specified on the AOCUPDT call. |
| 8 | Incorrect keyword specifications were detected and ignored. All other keywords processed normally. |
| 12 | No function keyword was specified on the AOCUPDT call. A resource was identified, but no action to perform on the resource was specified. |

AOCUPDT

- 16 The specified *resource* was not found, when the specified resource type (RESTYPE value) is SUBSYSTEM and the system name is the system on which AOCUPDT is running.
- 20 The *resource* name length was longer than allowed. When the specified RESTYPE value is SUBSYSTEM, the resource name cannot be longer than 11 characters.
- 99 A timeout or another error occurred.

Usage

- Use this command instead of ASF to update SA OS/390 status information.
- When you use AOCUPDT to change resource status, the status change message is sent to notification operators defined to receive the message. Notification of a status change occurs whether automation flags for the resource are enabled or disabled (set to Yes or No). To suppress sending a message when a status change occurs, specify MSG=NONE along with the STATUS parameter.

Examples

Example 1

This example shows how to use AOCUPDT to change the status of the TSO subsystem to UP.

```
AOCUPDT TSO,STATUS=UP
```

Note: This will not cause any TSO UP commands to be issued.

Example 2

This example shows how to use AOCUPDT to:

- Change the status of subsystem IMSPROD to DOWN
- Issue a customer-defined message, ABC123
- Ensure that the status change is *not* reflected in SDF

```
AOCUPDT IMSPROD,STATUS=DOWN,MSG=ABC123,SDFUPDT=NO
```

Note: You should not change the status in this way if IMSPRODU is running.

AOFADMON

Purpose

The AOFADMON routine is used to determine the status of a job within the operating system using the MVS D A method. For performance reasons it is recommended to use AOFAJMON instead of AOFADMON.

Syntax

```
▶▶—AOFADMON—jobname—————▶▶
```

Parameters

jobname

The job name by which the operating system knows the associated application.

Restrictions and Limitations

AOFADMON should only be used as a programming facility since its only output is a return code.

Return Codes

Return codes are:

0	Job is active
4	Job is starting
8	Job is inactive
12	Parameter error

AOFAJMON

Purpose

The AOFAJMON routine is used to determine the status of a job within the operating system using the ASCB method. This is *not* the SA OS/390 status of the job. To determine the SA OS/390 status of a job, use AOCQRY.

Syntax

▶▶—AOFAJMON—*jobname*————▶▶

Parameters

jobname

The job name that the operating system knows the associated application as. This can be obtained from the *subsjob* task global variable returned by AOCQRY.

Restrictions and Limitations

AOFAJMON should only be used as a programming facility since its only output is a return code.

Return Codes

Return codes are:

0	Job is active
4	Job is starting
8	Job is inactive
12	Parameters are invalid

Examples

The following example exec can be used to display the operating system status of a job passed to it:

```
/* Simple Job Status REXX EXEC */
Parse Upper Arg jobname .
If jobname <> ' ' Then Do
  'AOFAJMON 'jobname
  Select
    When rc = 0 Then Say 'Job 'jobname' is active'
    When rc = 4 Then Say 'Job 'jobname' is starting'
    When rc = 8 Then Say 'Job 'jobname' is inactive'
    Otherwise      Say 'Job 'jobname' is invalid'
```

AOFAJMON

```
    End
End
Else Do
    Say 'No jobname provided'
End
Exit
```

Note: The command returns information about the first EXECUTING or STARTING address space it can find where the name of that address space matches the job name it was invoked with. A return code of 8 means that no address space with that name could be found. A return code of 12 means the parameters are invalid.

AOFAPMON

Purpose

The AOFAPMON routine is used to determine the status of a PPI receiver. It calls DISPPI and checks if a specific PPI receiver is active.

Syntax

```
▶▶—AOFAPMON—ppiname—————▶▶
```

Parameters

ppiname

The name of the PPI receiver this routine searches for. When the PPI receiver is active, the system issues return code 0. Otherwise return code 8 is issued.

Restrictions and Limitations

AOFAPMON should only be used as a programming facility because its only output is a return code.

Return Codes

The following return codes are issued:

0	Resource is active
8	Resource is inactive

AOFATMON

Purpose

The AOFATMON routine is used to determine the status of a task operating within the NetView environment. When the application is defined using the SA OS/390 customization dialogs, the application *jobname* must be defined to be the NetView task name.

Syntax

```
▶▶—AOFATMON—taskname—————▶▶
```

AOFCPMSG

SEVERITY

This parameter allows you to directly specify a severity and bypass the code matching process. To change the severity classification of a message you need to change the automation table.

The severity of a message can also be specified in a CDEMATCH against the subsystem. If no match is found against the subsystem, a match is attempted against the system issuing the message. The message ID for the code match is CAPMSGs. CODE1 is set to the message ID of the message being captured. CODE2 is set to the subsystem name of the subsystem that issued the message. CODE3 is set to the value specified in the CODE3= parameter. The value returned is one of the following severity codes:

IMPORTANT

The message is captured and its color is set to PINK.

IGNORE

The message is not captured.

NORMAL

The message is captured and its color is set to GREEN.

UNUSUAL

The message is captured and its color is set to YELLOW.

CRITICAL

The message is captured and its color is set to RED.

CLEAR

YES|NO

Specifies whether or not the existing messages that are recorded for the subsystem should be erased and SDF and NMC resources should be removed for the subsystem. This may be specified without a message being issued. The default is NO.

DOM

YES|NO

Specifies whether or not the message is a DOM for another message. If it is, the first message is found and removed from SDF and NMC and its severity in the globals is downgraded to NORMAL. A DOM record is recorded in the globals if the message had higher than NORMAL severity.

Restrictions and Limitations

To use the AOFCPMSG command system operations must be initialized. AOFCPMSG should only be executed as an automation table command. Excessive use of AOFCPMSG will reduce NetView storage because messages are stored in common global variables. It is recommended to restrict the use of AOFCPMSG to exception condition messages.

Usage

Add the AOFCPMSG routine to your message automation table.

Examples

```

AOFKINFO          SA OS/390 - Command Dialogs          Line 115 of 192
Domain ID   = IPSFM          ----- DISPINFO -----      Date = 06/28/02
Operator ID = KAT                                     Time = 09:20:53

Subsystem ==>  CICSK1H      System ==>  KEY1      System name, domain ID
                                                or sysplex name

Captured Messages for CICSK1H -

2002-06-28 09:19:25 :
  AOF571I 09:19:24 : CICSK1H SUBSYSTEM STATUS FOR JOB CICSK1H IS
                STARTED - STARTUP FOR CICSK1H/APL/KEY1 IN PROGRESS
  AOF570I 09:19 : ISSUED "MVS S
                CICS21TX,JOBNAME=CICSK1H,SUFF=K1H,PARM='SYSIN,START=AUTO'
                " FOR SUBSYSTEM CICSK1H - MSGTYPE IS STARTUP
2002-06-28 09:19:32 :
  IEF403I CICSK1H - STARTED - TIME=09.19.25
  AOF571I 09:19:32 : CICSK1H SUBSYSTEM STATUS FOR JOB CICSK1H IS
                ACTIVE - ACTIVE MESSAGE RECEIVED
2002-06-28 09:19:38 :
  DFHSI1502I IPSAMCIH CICS STARTUP IS WARM.
2002-06-28 09:19:42 :
  AOF571I 09:19:42 : CICSK1H SUBSYSTEM STATUS FOR JOB CICSK1H IS UP
                - UP MESSAGE RECEIVED
2002-06-28 09:19:43 :
  AOF570I 09:19 : ISSUED "MSG LOG,PERFORM UP PROCESSING" FOR
                SUBSYSTEM CICSK1H - MSGTYPE IS UP
2002-06-28 09:19:48 :
  AOF570I 09:19 : ISSUED "MSG LOG,PERFORM PPI UP PROC" FOR
                SUBSYSTEM CICSK1H - MSGTYPE IS PPIACTIVE

Policy Definitions for CICSK1H -

ABENDED :
  CMD=(,,'MSG LOG,PERFORM DOWN PROCESSING')

ACORESTART :
  CMD=(,,'CICRSYC')

Command ==>>
PF1=Help   PF2=End     PF3=Return   PF4=INGINFO   PF6=Roll
PF7=Back   PF8=Forward  PF9=Refresh  PF10=CICS Info PF12=Retrieve
    
```

Figure 5. DISPINFO Sample Panel Showing Captured Messages

AOFCPSM

Purpose

The AOFCPSM routine is a dedicated routine used to determine the status of processor operations using the ISQCHK service.

Syntax

▶▶—AOFCPSM—*jobname*—▶▶

Parameters

jobname

The job name by which SA OS/390 knows the processor operations application.

AOFCPSM

Restrictions and Limitations

AOFCPSM should only be used as a programming facility since its only output is a return code.

Return Codes

Return codes are:

- | | |
|----|------------------|
| 0 | Task is active |
| 4 | <i>Not used</i> |
| 8 | Task is inactive |
| 12 | <i>Not used</i> |

This routine uses the ISQCHK service to determine the status of processor operations. ISQCHK returns RC=0 if processor operations is operational, and RC=32 if it is not. These return codes are remapped to RC=0 (active) and RC=8 (inactive).

AOFEXCMD

Purpose

AOFEXCMD is used to execute a command on a specified autotask. If the autotask is not active, AOFEXCMD will try to execute the command on a backup autotask. This process is repeated until the command is successfully scheduled for execution, or the list of available backup autotasks is exhausted.

AOFEXCMD will attempt to execute the command on the following autotasks:

1. The primary autotask for *AUTOFUNC*
2. The secondary autotask for *AUTOFUNC*
3. The primary autotask for *SYSOPER*
4. The secondary autotask for *SYSOPER*
5. The primary autotask for *BASEOPER*
6. The primary autotask for *AUTO1*

If it cannot execute on any of these autotasks, an AOF572I message is issued.

SA OS/390 automation will attempt to restart any inactive autotasks called by AOFEXCMD.

Syntax

▶▶—AOFEXCMD—*autofunc*—, —*command*—▶▶

Parameters

autofunc

The automated function under which the autotask name is defined. Automated functions are established in the customization dialogs, and are assigned at SA OS/390 initialization.

If the automated function name is not supplied the procedure will attempt to issue the command on one of the backup automated functions (sysoper, baseoper or auto1.)

Note: If the automated function name is not supplied, a comma must be used as a placeholder for parsing so that the command is identifiable as the second operand.

command

The command which is to be scheduled to run on the autotask associated with the automated function.

Restrictions and Limitations

Do not define an operator ending with the character string #\$.

Issuing operators must be scope authorized to issue the command using EXCMD.

Messages

The following message is issued by AOFEXCMD when it has failed to execute on any of the available autotasks. This may occur if AOFEXCMD is issued before SA OS/390 initialization is complete.

```
AOF572I CGLOBALS NOT INITIALIZED FOR AUTOMATED FUNCTION autofunc -
UNABLE TO ROUTE COMMAND command, operand_1, operand_2, operand_3
```

Examples

The following command schedules a message to be sent from autotask AUTNET1 to operator OPER1. In this example, AUTNET1 is defined under the automated function NETOPER.

```
AOFEXCMD NETOPER,MSG OPER1 Logoff in 5 mins
```

AOFTREE

Purpose

The AOFTREE routine is used to extract information about an application and its dependent applications. The information returned for each application in the parent child hierarchy is:

- Name
- Job name
- Type of the resource (can be application group or subsystem)
- Position in the tree

The relationship of an application to its dependent applications can be illustrated using a tree structure as in Figure 6.

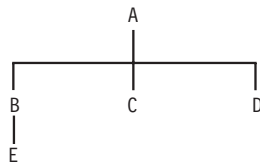

Figure 6. Subsystem Dependent Tree.

Where:

- A, B, C, D, and E are all applications.
- A is the root of the tree. All applications below A are its dependants.
- B, C, and D are direct children of A, that is, dependent on A.
- B, C, D, and E are all dependants of A.
- A is the parent of B, C, and D. B is the parent of E.

AOFTREE

- A is on level 1, B, C, and D are on level 2, and E is on level 3.
- E, C, and D have a position in the tree referred to as 'LOWEST'. A and B have a position in the tree referred to as 'UPPER'.

Syntax

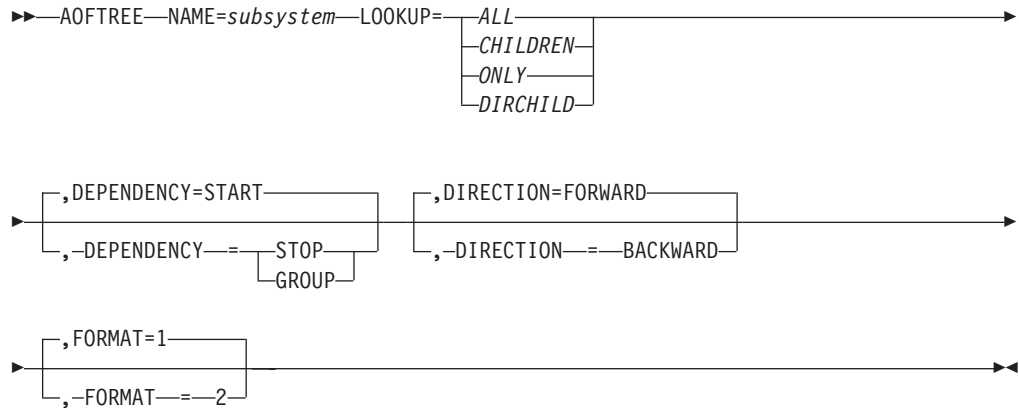

Parameters

NAME=

subsystem

The name of the application for which you wish to extract dependent applications.

LOOKUP=

The scope of the tree to be returned. The following values can be specified for lookup:

ALL

Returns details on the application and all its children.

CHILDREN

Returns details on all the children of the application.

ONLY

Returns details on the application only.

DIRCHILD

Returns details on the application and its direct children.

DEPENDENCY

Specifies the type of dependency (as defined in the policy database) for which the parent-child data should be returned. The following options are available:

START

Returns all resources that are a “parent” of the specified resource or that the resource has a start dependency on. This is the default.

STOP

Returns all resources that are a “child” of the specified resource or that the resource has a stop dependency on.

GROUP

Returns all members that the specified resource consists of.

DIRECTION

Specifies the direction for returning the tree data. The following options are available:

FORWARD

Means progressing from the top level of the tree towards the bottom. This is the default.

BACKWARD

Means progressing from the bottom of the tree towards the top.

FORMAT

Specifies the output format in which the information is returned. The following options are available:

- 1 The data is returned in NetView task globals (AOFPCCHILD.n). This is the default.
- 2 The data is returned in a multiline message.

Restrictions and Limitations

This command can only be issued for a local system.

Return Codes

Return codes are:

- | | |
|---|---|
| 0 | The command successfully executed. The results are in the TGLOBAL array AOFPCCHILD. |
| 1 | An invalid application name was used. |
| 4 | Invalid parameters were used. |
| 5 | Timeout or another error occurred. |

Usage

When control is returned to the calling automation procedure, if the return code is not zero the AOFPCCHILD array is set to null.

Note: The AOFPCCHILD array is NOT sorted in hierarchical order.

If you use the AOFTREE command within a PIPE and no parameters are passed, the contents of the default safe is taken and treated as input parameters. The output format is set to 2 (FORMAT=2).

TGGLOBALS**Name Description****AOFPCCHILD.0**

The number of elements in the array.

AOFPCCHILD.n

The nth element in the AOFPCCHILD array. This element contains the following details for a subsystem, separated by blanks:

- Name
- Job name
- Position in the tree

AOFTREE

Examples

The following results are obtained when calling AOFTREE with the following parameters, and the relationships between A, B, C, D, and E are as described in Figure 6 on page 67.

AOFTREE NAME=A,LOOKUP=ALL

```
AOFPCHILD.0      = 5
AOFPCHILD.1      = E Ejobname 0 LOWEST
AOFPCHILD.2      = B Bjobname 0 UPPER
AOFPCHILD.3      = C Cjobname 0 LOWEST
AOFPCHILD.4      = D Djobname 0 LOWEST
AOFPCHILD.5      = A Ajobname 0 UPPER
```

AOFTREE NAME=A,LOOKUP=ONLY

```
AOFPCHILD.0      = 1
AOFPCHILD.1      = A Ajobname 0 LOWEST
```

AOFTREE NAME=A,LOOKUP=DIRCHILD

```
AOFPCHILD.0      = 4
AOFPCHILD.1      = A Ajobname 0 UPPER
AOFPCHILD.2      = B Bjobname 0 UPPER
AOFPCHILD.3      = C Cjobname 0 LOWEST
AOFPCHILD.4      = D Djobname 0 LOWEST
```

AOFTREE NAME=B,LOOKUP=ALL

```
AOFPCHILD.0      = 2
AOFPCHILD.1      = E Ejobname 0 LOWEST
AOFPCHILD.2      = B Bjobname 0 UPPER
```

If you issue:

```
'PIPE NETVIEW AOFTREE NAME=TSPARENT,LOOKUP=ALL,FORMAT=2,DEPENDENCY=START',
'|STEM treedata.'
```

the contents of the treedata stem will look similar to the following:

```
TSPARENT/APL/AOC9  TSPARENT APL UPPER
STD005AA00/APL/AOC9 T005AA00 APL LOWEST
STD004AA00/APL/AOC9 T004AA00 APL LOWEST
STD003AA00/APL/AOC9 T003AA00 APL LOWEST
STD002AA00/APL/AOC9 T002AA00 APL LOWEST
STD002AA01/APL/AOC9 T002AA01 APL UPPER
STD001AA00/APL/AOC9 T001AA00 APL LOWEST
```

If you issue:

```
'PIPE NETV AOFTREE NAME=STD000AN10,LOOKUP=ALL,FORMAT=2,DEPENDENCY=START',
'|STEM treedata.'
```

the contents of the treedata stem will look similar to the following:

```
STD000AN1A/APL/AOC9 #000AN1A APL UPPER
STD000AN1B/APL/AOC9 #000AN1B APL LOWEST
STD000AN1X/APL/AOC9 #000AN1X APL LOWEST
STD000AN10/APL/AOC9 #000AN10 APL UPPER
STD000AN11/APL/AOC9 #000AN11 APL LOWEST
STD000AN12/APL/AOC9 #000AN12 APL LOWEST
```

AOFUXMON

Purpose

The AOFUXMON routine is used to determine the status of a resource with application type USS. This resource can either be an OS/390 UNIX process, a file in the OS/390 UNIX filesystem (HFS), or a TCP port. Depending on the kind of resource (process, file, or port) AOFUXMON decides which internal monitoring method to use.

Syntax

▶▶—AOFUXMON—jobname—▶▶

AOFUXMON

Parameters

jobname

The jobname that automation knows the associated application as. This can be obtained from the SUBSJOB task global variable returned by AOCQRY.

Restrictions and Limitations

AOFUXMON should only be used as a programming facility because its only output is a return code.

AOFUXMON uses active rather than passive monitoring for PORTs. Active monitoring will cause a connection to be established to an active port. If this is not desirable then a customer supplied monitoring routine should be used instead of AOFUXMON for PORT monitoring.

Return Codes

The following return codes are issued:

- 0 The resource is active
- 4 The resource is starting
- 8 The resource is inactive
- 12 JES is not active.
- 16 One of the following parameter errors occurred:
 - The jobname parameter was not specified.
 - The jobname parameter does not represent a USS type resource.
 - The jobname parameter does not represent a USS PATH, PORT or FILE.
- 20 A return code other than 0, 4 or 8 was returned from the USS ingccmd routine. Check for related messages or turn on debug for AOFUXMON (this also turns on debug for ingccmd).

ASF

Purpose

The ASF command is a file manager command that displays records in an automation status file. ASF allows other actions, but these uses should be restricted through scope-checking. The automation status file records are maintained in a VSAM data set. ASF interfaces with the VSAM file to maintain control information vital to SA OS/390 such as:

- Automation status
- Whether an error threshold is exceeded
- Time and date information for error conditions

Recommendations

- In automation procedures you create, use the AOCUPDT common routine instead of ASF to modify application status. Changing application status using ASF may lead to unpredictable results.
- The primary use of ASF as an operator command is to display entries in an automation status file rather than change its contents. You can also display the automation status file using the DISPASF SA OS/390 operator dialog, documented in *System Automation for OS/390 Operator's Commands*. The ASF command also allows adding, updating, displaying, and deleting automation status file records, but these uses of ASF are not recommended. Modifications to the automation status file using ASF may not be acted upon or noticed by SA OS/390. Instead, use the SETSTATE operator dialog, described in *System Automation for OS/390 User's Guide*, if at an operator console, or use the AOCUPDT common routine in automation procedures.
- Use scope-checking to limit the use of this command to performing the display operation.

Syntax

The following syntax diagrams show how to use the ASF command to perform the different functions ASF supports. Do not combine syntax from the separate presentations in the same ASF call.

To display multiple automation status file entries use the following syntax:

```

▶▶ ASF [REQ=DISP,] FROM=resource [ ,_T0=resource ]

```

To display a single automation status file entry use the following syntax:

```

▶▶ ASF [REQ=DISP,] ID=resource

```

To delete a single automation status file entry use the following syntax:

```

▶▶ ASF REQ=DEL , ID=resource

```

To replace an automation status file entry use the following syntax:

```

▶▶ ASF REQ=REPL ID,=resource [ ,_DATE=error_date ,_TIME=error_time ]
[ ,_JOBNAME=jobname ] [ ,_JOBNO=job_number ] [ ,_JOBTYPE=jobtype ]

```

JOBTYPE

The type of job, whether TSO user, STC, or JOB. Retain this value for job number checking.

MONITOR

The time a monitor or status change command is issued, in *hh:mm* format (00:00 through 23:59).

NOTIFY

Specifies whether a notification message is sent to the operator for a specified condition.

N A notification message is not sent.

Y A notification message is sent.

OPID

The NetView operator ID that requested or is performing the status update. If not supplied, the ASF command uses the current operator ID. This parameter is applicable only when you use the STATUS parameter. *operator_id* can be from 1 through 8 characters long.

REPLYid

The outstanding reply identifier for a subsystem. Use this value for retaining reply identifiers for applications that maintain an outstanding reply, such as NetView message DSI802I.

Note: When dealing with applications that have multiple replies this field will contain the number of the last reply issued. This is not necessarily the message that SA OS/390 will reply to if AOCREP is invoked.

STATUS

The resource status. This value can be from 1 through 8 characters long, and can be any valid status value. Refer to *System Automation for OS/390 Customizing and Programming* for more information on resource statuses and their use.

When REQ=REPL, and the entry to be added or replaced does not exist, this parameter defaults to a value of DOWN.

THRESHLD

The threshold that is exceeded. Use this value to allow the operator to monitor thresholds. Threshold can be one of the following:

CRIT

FREQ

INFR

TIME

The time of this error time stamp being recorded, in HH:MM format. Use this value for threshold purposes. The DATE and TIME parameters are mutually inclusive. If you specify DATE, also specify TIME.

TYPE

The resource type for display and summary purposes. This value is SUBSYSTEM for all application records. Other values can be defined, if desired. This value can be from 1 through 10 characters long.

Restrictions and Limitations

- ASF functions both as an operator command and as an API to the automation status file. Limit its use as an operator command by scope-checking.

ASF

- An ASF command to replace or update automation status file entries is limited to 240 characters.
- The ASF command is not pipeable.

Usage

- If an automation procedure performs a replace or update function, only those fields that need replacing must be specified. No change occurs to other automation status file fields.
- To modify automation status file fields reserved for your data, use the ASFUSER command. See "ASFUSER" on page 77 for details.

Messages

The following messages are issued during successful operation of the ASF command.

For delete and replace requests:

```
AOF001I REQUEST "request" WAS SUCCESSFUL FOR "resource"
```

For display requests, the following messages are issued. These messages use JES2 as an example status record for which status information is displayed. Message variables are filled in with JES2 information.

```
AOF150I STATISTICS DISPLAY REQUESTED FOR JES
AOF151I id= JES          , TYPE= SUBSYSTEM  , STATUS= UP
AOF152I LAST UPDATE BY OPERATOR AUTJES
AOF163I LAST THRESHOLD EXCEEDED -
AOF164I REPLYid= 0000 , JOB TYPE= tttt , NUMBER= nnnn, NAME= nnnnnnnn
AOF155I OPERATOR NOTIFIED: Y
AOF156I LAST STATUS CHANGE DATE= 05/16/97 , TIME= 13:41, OPER=AUTJES
AOF157I LAST MONITORED DATE= 05/16/97 , TIME= 13:41
AOF160I  ERROR COUNT    DATE      TIME
AOF161I          01     05/16/97   13:35
AOF161I          02     05/16/97   13:40
AOF002I END OF MULTILINE MESSAGE
```

Note: For display requests, if error time stamp information does not exist, messages AOF160I and AOF161I may be replaced with message AOF159I, NO ERROR DATA AVAILABLE.

The following messages are issued if the entry was not found.

For display requests:

```
AOF041I UNABLE TO FIND RECORD identifier
```

Note: An ASF replace request adds an entry if one does not exist, so a successful message would result. For an ASF delete request, if ASF cannot find the identifier, it also issues a successful message.

Any messages beginning with AOF0 other than those previously documented should be considered an error situation. For a description of all AOF0 messages and their associated actions refer to *System Automation for OS/390 Messages and Codes*.

Examples

This example shows a command to display the status record for JES2.

The ASF command to display the status record is:

```
ASF REQ=DISP,id=JES
```

The response is:

```

AOF150I STATISTICS DISPLAY REQUESTED FOR JES
AOF151I id= JES      , TYPE= SUBSYSTEM  , STATUS= UP
AOF152I LAST UPDATE BY OPERATOR AUTJES
AOF163I LAST THRESHOLD EXCEEDED -
AOF164I REPLYid= 03 , JOB TYPE= **** , NUMBER= nnnn, NAME= nnnnnnnn
AOF155I OPERATOR NOTIFIED: Y
AOF156I LAST STATUS CHANGE DATE= 07/12/97 , TIME= 09:17, OPER=AUTJES
AOF157I LAST MONITORED DATE= 07/12/97 , TIME= 09:17
AOF160I  ERROR COUNT   DATE       TIME
AOF161I           01    07/06/97    14:21
AOF002I END OF MULTILINE MESSAGE

```

In this example, the operator or automation procedures processes the command to display the entry, and the associated response is sent back as a multiline message.

ASFUSER

Purpose

The ASFUSER command is a file manager command that updates the ten user fields in the automation status file. The ASFUSER command has different formats depending on whether it is used to:

- Display multiple records
- Display, delete, or replace (update) a single record

Syntax

To display multiple records use the following syntax:

```

▶▶—ASFUSER—REQ=DISP,—FROM=resource—,—TO=resource—▶▶

```

To display a single record use the following syntax:

```

▶▶—ASFUSER—REQ=DISP,—ID=resource—▶▶

```

To delete a single record use the following syntax:

```

▶▶—ASFUSER—REQ=DEL—ID,=resource—▶▶

```

To replace (update) a record use the following syntax:

ASFUSER

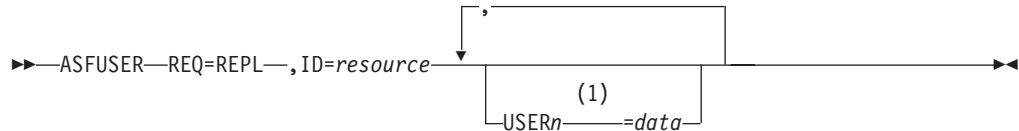

Notes:

- 1 *n* may be a number from 1 to 10

Parameters

REQ

The type of request for automation status file record information the ASFUSER command performs. This value may be one of the following:

Value	Description
-------	-------------

DISP	Displays a record in the automation status file. This value is the default if the REQ parameter is not coded.
-------------	---

DEL	Deletes a record in the automation status file.
------------	---

REPL	Replaces or adds a record in the automation status file.
-------------	--

If this parameter is specified, other parameters that describe the data to be displayed, deleted, or updated must be specified.

FROM

The resource ID that is the starting key when displaying multiple automation status file records. This value can be from 1 through 16 characters long.

TO

The resource ID that is the ending key when displaying multiple records. If not specified, the value defaults to the same key as the FROM parameter. This value can be from 1 through 16 characters long.

ID The resource ID that is the key to the automation status file record. This ID is the application name for application records. This ID can be from 1 through 16 characters long.

USER1=*data*...USER10=*data*

These parameters specify data stored in each of the 10 fields in the automation status file reserved for your information. All these parameters are optional. The specified data can be 1 through 20 characters long. These parameters are only used with ASFUSER replace requests (REQ=REPL).

Restrictions and Limitations

An ASFUSER command to replace or update automation status file entries is limited to 240 characters.

The ASFUSER command is not pipeable.

Usage

If your automation procedure performs a replace or update function, only those fields that need replacing must be specified. No change occurs to other automation status file fields.

Messages

- The following messages are issued during successful operation of the ASFUSER command.
 - For delete and replace requests:

```
AOF001I REQUEST "request" WAS SUCCESSFUL FOR "resource"
```
 - For display requests, the following messages are issued. These messages use status record MYRECORD as an example. Message variables are filled in with values for MYRECORD.

```
AOF150I STATISTICS DISPLAY REQUESTED FOR MYRECORD
AOF151I id=MYRECORD
AOF158I USER1=value
:
AOF158I USER10=value
AOF002I END OF MULTILINE MESSAGE
```
- The following message is issued if the entry was not found for an ASFUSER display request.

```
AOF041I UNABLE TO FIND RECORD identifier
```

Note: An ASFUSER replace request adds an entry if one does not exist, so a successful message would result. For an ASFUSER delete request, if ASFUSER cannot find the identifier, it also issues a successful message.

Examples

Example 1

This example shows a command to create an automation status file record for a resource with a resource ID of DASD.

The ASFUSER command to create the record is:

```
ASFUSER REQ=REPL,id=DASD,USER1=3350,USER2=3380
```

The response to the ASFUSER command is:

```
AOF001I REQUEST "REPLACE" WAS SUCCESSFUL FOR "DASD  "
```

Example 2

This example shows a command to display an automation status file record for DASD.

The ASFUSER command to display the record is:

```
ASFUSER id=DASD
```

The response to the ASFUSER command is:

```
AOF150I STATISTICS DISPLAY REQUESTED FOR DASD
AOF151I id=DASD
AOF158I USER1=3350
AOF158I USER2=3380
AOF002I END OF MULTILINE MESSAGE
```

Example 3

This example shows a command to update the DASD automation status file record to add a new DASD device type.

ASFUSER

The ASFUSER command to display the record is:

```
ASFUSER REQ=REPL, id=DASD, USER3=3990
```

The response to the ASFUSER command is:

```
AOF001I REQUEST "REPLACE" WAS SUCCESSFUL FOR "DASD  "
```

Note: Other values in record DASD remain as they were before the ASFUSER command was issued.

CDEMATCH

Purpose

The CDEMATCH routine performs a function similar to a table search. It uses code values specified in the automation policy to create a table. You define the table match criteria and a control keyword or result field. Results from the search are returned to the automation procedure and are typically used to alter the automation procedure logic flow or an automation procedure command or reply. A typical use is to extract feedback and return codes from the message you are automating, and then perform a search in the automation control file using those codes. The result of that search alters the action the automation procedure takes.

Syntax

```
▶▶ CDEMATCH MSGTYP=type [ , -CODE1=code ] [ , -CODE2=code ]  
[ , -CODE3=code ] [ , -ENTRY=entry ] ▶▶
```

Parameters

MSGTYP=*type*

The criteria for the type field during the code search; it also relates to the type field in the automation control file. MSGTYP is typically coded with the message ID or with a generic name, such as SPOOLSHORT or SPOOLFULL.

CODE1=*code* CODE2=*code* CODE3=*code*

The criteria used during the search. At least one code must be supplied and all three can be supplied, if desired. The codes can be specified in any order. The code is normally derived from the message detail. CODE1 relates directly to field 1 of the automation control file CODE format, CODE2 relates directly to field 2, and CODE3 to field 3.

ENTRY=*entry*

The criteria for the entry field during the command search. This value also relates to the entry field in the automation control file. Values for the CDEMATCH TGLOBALs named SUBSTYPE and SUBSAPPL determine the default for this parameter. See CDEMATCH TGLOBALs for more information. If the SUBSTYPE TGLOBAL value is SUBSYSTEM, the SUBSAPPL TGLOBAL value is the default ENTRY value. Otherwise, the SUBSTYPE TGLOBAL value is the default ENTRY value. The AOCQRY routine must be called before CDEMATCH for the defaults to work.

Restrictions and Limitations

This routine can be called only by another automation procedure or a command processor.

Return Codes

Return codes are:

- | | |
|---|---|
| 0 | A match was found. The result is in TGLOBAL field EHKACTION. |
| 1 | No match was found. |
| 4 | Incorrect parameters were used in the call. |
| 5 | Timeout or other error occurred. |
| 6 | SA OS/390 initialization incomplete, unable to process command request. |

Usage

- When control is returned to the calling automation procedure, TGLOBAL EHKACTION contains the data from the Value Returned field in the Code Processing panel of the customization dialogs. If no match occurs, EHKACTION contains nulls.
- Code matching specifications in the automation policy are order-dependent. The first match found is used.
- The format of code matching specifications in the automation policy allows the use of generic specifications, such as an asterisk (*) to indicate all remaining characters are ignored. When performing a search using CDEMATCH, pass the full text of the code. CDEMATCH truncates and compares as necessary.
- Code parameters (CODE1, CODE2, or CODE3) not specified when calling CDEMATCH are considered as matching whatever exists in the automation policy.
- Refer to *System Automation for OS/390 Customizing and Programming* for more information about the code matching feature.

TGLOBALS

Name Description

EHKACTION

The data specified in the Value Returned field in the Code Processing panel of the customization dialogs. In the automation control file generated from this customization dialog field, this field follows the code matching data (Code 1, Code 2, and Code 3 fields).

When the return code for CDEMATCH is greater than zero, the EHKACTION value is null.

Examples

Example 1

This example shows the relationship between CDEMATCH and the automation control file. The message to automate, \$HASP095, is produced by the JES2 subsystem and indicates that a catastrophic-level problem has occurred. This example assumes the full message text is passed to the automation procedure. The automation procedure breaks the message apart, then calls CDEMATCH to determine whether the error codes are in the automation control file.

The code matching information is specified in the automation policy as follows.

CDEMATCH

Select the MESSAGES policy item for the JES2 Application object. On the SA OS/390 Message Processing panel for the JES2 subsystem:

```

COMMANDS  ACTIONS  HELP
-----
AOFPISSM          SA OS/390 - Message Processing      ROW 1 TO 17 OF 20
Command ==>                               SCROLL==> PAGE

Entry Type : Application          PolicyDB Name : DATABASE_NAME
Entry Name : JES2                 Enterprise Name : YOUR_ENTERPRISE

Resource: JES2

Enter messages issued by this resource that will result in automated actions.
Actions: CMD= Command  REP= Reply  CODE= CODE

Action      Message id      Description                                Cmd Reply Code
-----
CODE        $HASP095          Codes for JES2 Catastrophic Msg

```

Figure 7. Message Processing Sample Panel

The SA OS/390 Code Processing panel for message \$HASP095 is displayed:

```

COMMANDS  HELP
-----
AOFPISSSE        SA OS/390 - Code Processing        ROW 1 TO 16 OF 20
Command ==>                               SCROLL==> PAGE

Entry Type : Application          PolicyDB Name : DATABASE_NAME
Entry Name : VTAM                 Enterprise Name : YOUR_ENTERPRISE

Resource:  VTAM
Message ID: $HASP095

Enter the value to be passed to the calling CLIST when this resource
issues the selected message and the following codes are contained in
the message.

Code 1      Code 2      Code 3      Value Returned
-----
ERROR*      $K03          Code 3      IPLREQ
ERROR*      $K08          Code 3      IPLREQ
ERROR*      $K15          Code 3      IPLREQ
ABEND*      SA22          Code 3      OPERCANCEL

```

Figure 8. Code Processing Sample Panel

The automation procedure is as follows:

```

/* REXX CLIST to respond to $HASP095 */
/* Check whether automation allowed and set TGLOBALs */
'AOCQRY ...'
:
/* Check for a match using the detail entries from the input message
** msg - $HASP095 JES2 CATASTROPHIC type CODE:= cde RC=rcde
**      (1) (2) (3) (4) (5) (6) (7) */
'CDEMATCH MSGTYP=$HASP095, CODE1='Msgvar(4)', CODE2='Msgvar(7)||',
', ENTRY=JES2'
Select
  When rc:= 0 Then Do /* Match found - check the action field */
    'GLOBALV GETT EHKACTION'
    Select
      When ehkaction:= 'IPLREQ' Then Do /* Warn operators */
        :
      End
      When ehkaction:= 'OPERCANCEL' Then Do /* Update log */
        :
    End
  End

```

```

        End
      Otherwise Nop
    End
  End
  When rc:= 1 Then Do    /* No match found; warn if required    */
  :
  End
  Otherwise Do          /* Error; perform warning action    */
  :
  End
End
Exit

```

The CDEMATCH parameters, automation policy values, and values in message \$HASP095 relate as follows:

CDEMATCH Parameter	Automation Policy Value	\$HASP095 Message Value
MSGTYP=\$HASP095	Message ID value (\$HASP095)	\$HASP095 (first message variable)
ENTRY=JES2	Subsystem name (JES2)	JES2 (second message variable)
'CODE1='Msgvar(4)	Code 1 values (ERROR* and ABEND*)	<i>type</i> (fourth message variable)
'CODE2='Msgvar(7)	Code 2 values (\$K03, \$K08, \$K15, and SA22)	<i>cde</i> (seventh message variable)

CODE3 is not used in this example, and is allowed to default. In the automation policy, the Code 3 field is left blank.

The automation procedure processing depends on actions taken in response to whether message \$HASP095 contains codes matching those in the automation policy. In the example, if \$HASP095 does not contain any of the automation policy-specified codes, RETCODE equals 1 and the message is ignored. If \$HASP095 contains error codes \$K03, \$K08, or \$K15, the operator is warned that an IPL is required to restart JES2. If \$HASP095 contains abend code SA22, a record is logged indicating that the operator terminated JES2.

Example 2

This example uses the same message as in Example 1, but shows a different technique for breaking the message apart and coding the automation control file. The message to automate, \$HASP095, is produced by the JES2 subsystem and indicates a catastrophic-level problem has occurred. This example assumes the full message text is passed to the automation procedure. The automation procedure breaks the message apart, then calls CDEMATCH to determine whether the error codes are in the automation policy.

The code matching information is specified in the automation policy as follows.

Select the MESSAGES policy item for the JES2 Application object. On the SA OS/390 Message Processing panel for the JES2 subsystem:

CDEMATCH

```

COMMANDS  ACTIONS  HELP
-----
Command ==> Message Processing Row 1 to 11 of 25
                SCROLL==> PAGE

Entry Type : Application      PolicyDB Name : DATABASE_NAME
Entry Name  : JES2_CLASS      Enterprise Name : YOUR_ENTERPRISE

Subsystem   : JES2_CLASS

Enter messages issued by this resource that will result in automated actions.
Actions: CMD = Command REP = Reply CODE = CODE USER = User defined values

Action  Message ID      Description      Cmd  Rep  Code  User
-----
        $HASP095      JES2 Catastrophic ABEND|ERROR      3
        $HASP098      Enter termination option      2
        $HASP099      All available functions completed      1
        $HASP426      Specify initialization options      1
        WTORs      Classification of WTORs      1

F1=HELP    F2=SPLIT    F3=END      F4=RETURN    F5=RFIND    F6=RCHANGE
F7=UP      F8=DOWN     F9=SWAP     F10=LEFT     F11=RIGHT   F12=RETRIEVE

```

The SA OS/390 Code Processing panel for message \$HASP095 is displayed:

```

COMMANDS  HELP
-----
Command ==> Code Processing Row 1 to 21 of 23
                SCROLL==> PAGE

Entry Type : Application      PolicyDB Name : DATABASE_NAME
Entry Name  : JES2_CLASS      Enterprise Name : YOUR_ENTERPRISE

Subsystem   : JES2_CLASS
Message ID  : $HASP095

Enter the value to be passed to the calling CLIST when this resource
issues the selected message and the following codes are contained in
the message.

Code 1      Code 2      Code 3      Value Returned
*           $PJ*           STOPPING
ERROR*     $K03           STOPPING
ABEND*     SA22           STOPPING

F1=HELP    F2=SPLIT    F3=END      F4=RETURN    F5=RFIND    F6=RCHANGE
F7=UP      F8=DOWN     F9=SWAP     F10=LEFT     F11=RIGHT   F12=RETRIEVE

```

The automation procedure is:

```

/* REXX CLIST to respond to $HASP095 */
/* Check whether automation allowed and set TGLOBALs */
'AOCQRY ...'
:

```

```

/* Parse the detail entries from the input message
** msg - $HASP095 JES2 CATASTROPHIC type CODE:= cde RC=rcde
**      (1)  (2)  (3)          (4) (5) (6) (7)
parmstr:= Arg(1)
Parse Var parmstr 'CATASTROPHIC' codelin 'CODE' '=' code2in .
codelin:= Strip(codelin)
code2in:= Strip(code2in)
/* Look for a match
'CDEMATCH MSGTYP=$HASP095,CODE1='codelin',CODE2='code2in
Select
  When rc:= 0 Then Do /* Match found - check the action field
    'GLOBALV GETT EHKACTION'
    Select
      When ehkaction = 'STOPPING' Then Do
        :
      End
      When ehkaction:= 'OPERCANCEL' Then Do /* Update log
        :
      End
      Otherwise Nop
    End
  End
  When rc:= 1 Then Do /* No match found; warn if required
    :
  End
  Otherwise Do /* Error; perform warning action
    :
  End
End
Exit

```

This example differs from Example 1 in several ways:

- CDEMATCH searches for different codes in message \$HASP095. Instead of searching for specific error codes \$K03, \$K08, and \$K15, CDEMATCH searches for \$HASP095 messages with generic error code \$PJ in the first three characters. This generic error code traps both \$PJ2 and \$PJF, which are P JES2,ABEND and \$P JES2,ABEND,FORCE, respectively. If codes match, the automation procedure logs a record indicating the operator shut down JES2.
- The ENTRY parameter is not coded and defaults to JES2. This default occurs only if AOCQRY was previously called and TGLOBAL SUBSTYPE is properly filled in. Refer to "AOCQRY" on page 42 for more information.
- The example uses a different method to parse, or break apart, the message. It uses the REXX Parse instruction to parse the message without relying on a field number (position) in the message. The message is obtained by assigning the REXX function Arg(1) to a variable PARMSTR which is then parsed using tokens in the message text. This example also uses the REXX Strip function to strip extraneous blanks that may remain in a parsed variable if the Parse instruction is used as shown. You can also break apart the message in the NetView automation table, and send only necessary fields to this automation procedure.

CHKSUBS

Purpose

This command exists for compatibility reasons. The processing is done by the automation manager automatically as a result of the status updates. The return code is always 0.

CHKTHRES

Purpose

The CHKTHRES routine checks the number of errors recorded in the automation status file against a preset error threshold. It also supports recording the error date and time in the automation status file.

CHKTHRES searches the automation control file for the applicable threshold for a specific resource. It then obtains the error status information from the automation status file and determines, based on the thresholds, whether any of the three definable thresholds are exceeded. If a threshold is exceeded, an error message is issued and an appropriate return code is generated.

Syntax

Parameters are positional.

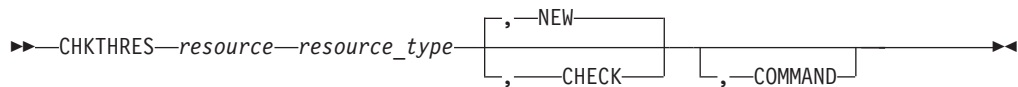

Parameters

resource

The name of the resource for which thresholds should be checked. This resource name can be an application name, a generic MVS component name, or any name you define up to 16 characters long. Examples of MVS component names are SMF and LOGREC. This parameter is required.

resource_type

The type of the resource. Normally, SUBSYSTEM is used for applications and MVSESA for MVS components. This value can be any name you define up to 10 characters long. This parameter is required.

NEW

An error is added to the error status information; then thresholds are checked.

CHECK

Specifies whether a new error should be added to the error status information.

Thresholds are checked based on the existing error information.

COMMAND

This parameter determines the messages that CHKTHRES issues when the infrequent, frequent, and critical error thresholds are exceeded and the resource type is either SUBSYSTEM or MVSESA.

If the automation procedure in which you use CHKTHRES issues commands when an error threshold is exceeded, specify this parameter.

Restrictions and Limitations

This routine can be called only by another automation procedure or by a command processor.

Return Codes

Return codes are:

0 No threshold is exceeded

- 1 Infrequent threshold is reached
- 2 Frequent threshold is reached
- 3 Critical threshold is reached
- 4 Incorrect parameters were used in the call
- 5 Timeout or other error occurred

Usage

- CHKTHRES accesses the automation policy to check the threshold definitions, and the automation status file to check the current status of the resource.
- CHKTHRES is used primarily to track error conditions that can be repetitive. By tracking the errors, operators can be notified of the repetitive error situation before it causes problems. SA OS/390 tracks a minimal number of situations, such as application abends, SPOOL shortages, and problems causing full LOGREC conditions. It does not track specific error messages. When coding new automation procedures, restrict using this routine to these types of situations.
- Up to 10 errors can be stored in each record in the automation status file. These errors are stored in order of date and time of error. No details about the error are stored.
- To ensure the integrity of the SA OS/390 abend threshold counter, do not add error status information using an application name. There is only one automation status file record for each application name, and this record is used to maintain the abend threshold counter.
- Each resource name in the automation status file must be unique. Select your resource names with care. Proper definition of the resource name gives meaning to the type of error and the job causing the error, particularly because the automation status file stores only the date and time of the error.
- CHKTHRES searches for the threshold in a predefined sequence to find the appropriate threshold.

When an error threshold is exceeded, one of the AOF58*n* messages is issued:

Message	Error Threshold
AOF587I	Critical
AOF588I	Frequent
AOF589I	Infrequent

Note: The issuing of commands is not a function of the CHKTHRES routine.

When an error threshold is exceeded, and COMMAND is not specified, one of the AOF57*n* messages is issued:

Message	Error Threshold
AOF577I	Critical
AOF578I	Frequent
AOF579I	Infrequent

If you are checking thresholds for resources that are not a subsystem, the following messages are issued:

Message	Error Threshold
AOF501I	Critical
AOF502I	Frequent
AOF503I	Infrequent

For a description of these messages, refer to *System Automation for OS/390 Messages and Codes*.

CHKTHRES

Examples

This example shows the relationship between a CHKTHRES call in an automation procedure and thresholds defined in the automation policy. The example involves thresholds set for the TSO subsystem. The automation procedure checks the thresholds by calling CHKTHRES.

The thresholds are defined in the automation policy on the SA OS/390 Thresholds Definition panel for the TSO subsystem, as follows:

```
COMMANDS  HELP
-----
AOFPIZTH          SA OS/390 - Thresholds Definition
Command ===>                                SCROLL===> PAGE

Entry Type : Application          PolicyDB Name : DATABASE_NAME
Entry Name  : TSO                 Enterprise Name : YOUR_ENTERPRISE

Resource:    TSO
Description: TSO Application

Specify the number of times an event must occur to define a particular level.

----- Levels -----
Critical      Frequent      Infrequent
Resource      Number      Interval Number Interval
(hh:mm)      (hh:mm)      (hh:mm)
TSO           08         2:00      04         4:00      04         08:00
```

The automation procedure to call CHKTHRES is:

```
/* REXX CLIST to check thresholds when a TSO error occurs */
/* Check whether automation allowed and set TGLOBALs */
'AOCQRY ...'
:
'CHKTHRES TSO,SUBSYSTEM,NEW'
Select
  When rc = 0 Then Do
/* perform actions required if no thresholds are exceeded */
:
  End
  When rc = 1 Then Do
/* perform actions required if infrequent thresholds are exceeded */
:
  End
  When rc = 2 Then Do
/* perform actions required if frequent thresholds are exceeded */
:
  End
  When rc = 3 Then Do
/* perform actions required if critical thresholds are exceeded. */
:
  End
  Otherwise Do
/* otherwise, an error occurred, RC=4/5, log error message */
:
  End
End
Exit
```

In this example, the threshold settings for TSO in the automation policy define:

- A critical threshold as 8 errors occurring in 2 hours
- A frequent threshold as 4 errors in 4 hours
- An infrequent threshold as 4 errors in 8 hours

The example automation procedure performs the following processing steps:

1. The automation procedure calls CHKTHRES using a *resource_name* value of TSO, a *resource_type* value of SUBSYSTEM, and the NEW keyword.
2. The error information is added to the automation status file, and the thresholds are checked.
3. Upon return to the automation procedure, the rc special variable is checked. If the value indicates a critical threshold is exceeded, the automation procedure should stop recovery to be consistent with the message issued by CHKTHRES.

INGPOST

Purpose

The INGPOST command posts status notifications to SA OS/390's NMC based user interface.

Syntax

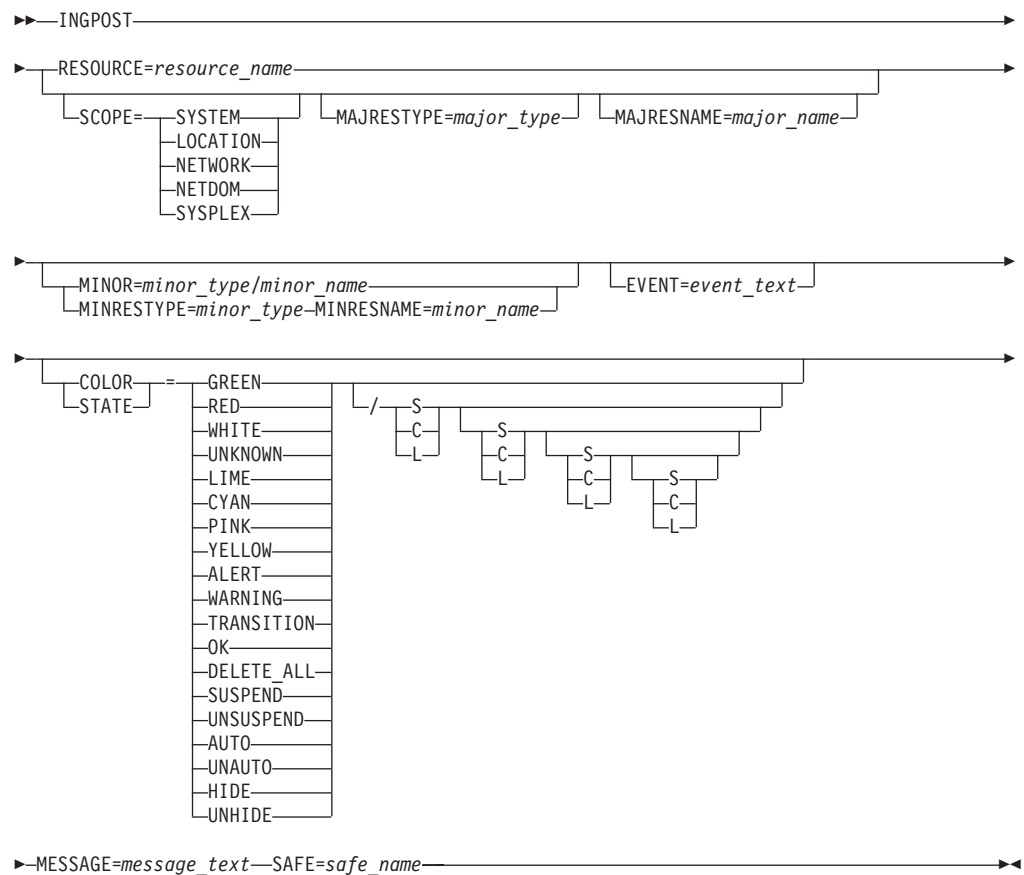

Parameters

RESOURCE

Specifies the name of the major resource that the notification is associated with.

resource_name

Is a standard SA OS/390 V2R1 resource name. The format is either *name/type* or *name/type[/system]*.

INGPOST

You should specify either a RESOURCE= parameter or (some of) the SCOPE=, MAJRESTYPE= and MAJRESNAME= parameters. If you do not, the resource name will be defaulted.

The default resource name depends on the situation when the program is called. If a job name is available, and can be mapped to a subsystem, then the default resource name is `subsys_name/APL/cursys`. If the job name cannot be mapped to a system, then the default resource name is `job name/JOB/cursys`. If no job name is available, then the default resource name is `cursys/SYS/cursys`. This should always be used with a minor resource name.

Note that there are a number of special resources which act as anchors for dynamic objects created by INGPOST. They are the following:

SYSPLEX

Is used for operations that affect the whole sysplex. It is equivalent to only specifying SCOPE=SYSPLEX.

WTOR

Is used with WTORs that are posted to NMC.

TAPE Is used with tape mount requests that are posted to NMC.

NET/netid

Is used for events related to a network. It is equivalent to specifying SCOPE=NETWORK.

domain/NET/netid

Is used for events related to a specific domain within a network. It is equivalent to specifying SCOPE=NETDOM.

LOCATION

Specifies that the location for the originating system given within the INGTOPOF file should be used. It is equivalent to specifying SCOPE=LOCATION.

SCOPE

Is used to specify the scope of the major resource. The scope can be one of the following:

SYSTEM

Indicates that the notification is tied to this particular system and that the value of `cursys()` should be used in the constructed resource name. This is the default.

LOCATION

Indicates that the notification is associated with the physical site that the system is located at. The value is taken from the INGTOPOF file on the focal point.

NETWORK

Indicates that the notification is associated with the system's network, and the value of `netid()` is used for the constructed resource name.

NETDOM

Indicates that the notification is associated with the system's domain within its network.

SYSPLEX

Indicates that the notification is connected to the sysplex, rather than to any particular system. The scope parameter is omitted from the constructed resource name, for example, just `name/type`.

This is used with the MAJRESTYPE= and MAJRESNAME= parameters to construct the name of the major resource the alert will be logged against.

MAJRESTYPE

Specifies the type of the major resource, normally a 3–digit code.

major_type

Specifies the type value to be used in the constructed resource name.

Within the automation manager, the following types are used:

- APL** An application.
- APG** A group of applications on the same system.
- SYS** A single, running system, including hardware and operating system.
- IMG** A proxy resource, enabling systems defined to processor operations to be controlled and monitored through the automation manager.
- SYG** A group containing all of the high-level resources on a particular system. Status for these resources is not posted to NMC.
- SYC** Means that a system is a member of the sysplex. It's state is maintained by the automation manager supervisor which monitors XCF. Status for these resources is not posted to NMC.
- GRP** A group of systems which may be a sysplex or a subset of a sysplex.
- PLX** A sysplex. The status for these resources is not posted to NMC.
- SVP** A service period. The status for these resources is not posted to NMC.
- EVT** An event. The status for these resources is not posted to NMC.

The following additional types occur for notifications not related to manager-owned resources:

- MSC** Miscellaneous, anything that does not fit in another category
- JOB** Notifications related to non-automated jobs and started tasks
- ETR** External time reference
- CFL** A coupling facility
- CDS** A couple data set

The default value will depend upon the context of the call and the other parameters. See the discussion under the RESOURCE= parameter.

MAJRESNAME

Specifies the name of the major resource that the notification is associated with.

major_name

This is the name of the major resource that will be used in the constructed resource name.

See the discussion of defaults under the other items.

The default value may be a subsystem name, a job name, cursys() or some other value, depending upon the context of the call.

MINOR

Specifies the minor resource name associated with the notification

INGPOST

minor_name

Is a more or less free-form field for specifying the minor resource name. The value must be valid as part of a RODM object name and may have requirements placed upon it by the customers BLDVIEWS implementation.

The MINRESTYPE= and MINRESNAME= parameters can be used as an alternative to the MINOR= parameter.

If not specified the minor resource name defaults to null.

MINRESTYPE

Specifies the type of the minor resource.

minor_type

Is the type of the minor resource. Typically this would be something like TRAN, for CICS and IMS transactions.

If this value is omitted, it defaults to a null.

MINRESNAME

Specifies the name of a minor resource when two-part construction is being used.

minor_name

Is the name of the minor resource. Typically it is a transaction name.

If a minor resource type is specified, a minor resource name should also be specified. If only a minor resource name is specified, it will be used as the complete minor resource name, the same as if the MINOR= parameter had been used.

EVENT

Specifies a short 'status' value which is appended to the resources DisplayResourceName.

event_text

Is a single word which will be folded to upper case and appended to the DisplayResourceName for the corresponding RODM object. It should be informative and short.

If not specified the event text will be null and only the resource name and the minor resource name will be present in the DisplayResourceName.

COLOR

Specifies the new DisplayStatus to be posted for the object within RODM.

GREEN or 129 or OK

Sets the object's DisplayStatus to Satisfactory

LIME or 144

Sets the object's DisplayStatus to Medium Satisfactory

CYAN or 145

Sets the object's DisplayStatus to Low Satisfactory

WHITE or 131 or TRANSITION

Sets the object's display status to Intermediate

YELLOW or 161 or WARNING

Sets the object's DisplayStatus to Low Unsatisfactory

PINK or 160

Sets the object's DisplayStatus to Medium Unsatisfactory

RED or 130 or ALERT

Sets the object's DisplayStatus to Unsatisfactory

UNKNOWN or 132

Sets the object's DisplayStatus to Unknown

Note that the syntax diagram does not show the numeric values for the statuses. However, they are accepted and processed correctly.

There are some special values which trigger different processing.

DELETE_ALL

Should be used with a major resource and deletes all minor resource objects associated with that major resource.

SUSPEND and UNSUSPEND

Changes the setting of the 'suspended from aggregation' part of the object.

AUTO and UNAUTO

Changes the setting of the 'automation in progress' part of the object.

HIDE and UNHIDE

Changes the setting of the 'excluded from exception views' part of the object.

The second part of the value is a set of up to 4 SCL flags. The first set applies to the 'operator marked' part, the second to the 'automation in progress' part, the third to the 'suspended from aggregation' part and the fourth to the 'exclude from exception views' part. The following are valid flags:

- S** Sets the bit
- C** Clears the bit
- L** Leaves the bit unchanged

These flags reduce the number of updates needed to perform a status change. Typically, when a resource changes from, for example, Awaiting Automation to Automation In Progress, one needs to:

1. Change its color and status
2. Clear its 'operator marked' bit
3. Set its 'automation in process' bit

With these bits, the update can be done with one single call, posting the status as 144/CS. Without these flags this would require three separate calls. When the resource status changes from Automation In Progress to Satisfactory or Degraded, one would post statuses of GREEN/LC or WHITE/LC.

MESSAGE

Specifies a message to be shipped with the status update. It ends up in the DisplayResourceOtherData field.

message_text

Is the text of the message.

The maximum text length is 140 characters.

INGPOST

If not specified, and if a message is available from the safe, then that message will be used.

SAFE

This specifies the name of the safe holding the message from which the default message text is to be taken.

safe_name

This is the name of the safe.

If not specified the default safe (called *) will be used.

If the safe is empty, then the default message text is null.

INGPW

Purpose

INGPW initializes the SA OS/390 password protection feature. The INGPW command processor maintains a VSAM file containing passwords for gateway operator IDs, called the SA OS/390 password data set. These passwords are used when establishing gateway sessions. The records in the SA OS/390 password data set are keyed using a combination of the user ID and domain ID. Each record has three fields:

- The *current-password* field
- The *new-password* field
- The *date-password-last-changed* field

Passwords are stored in encrypted format and are changed every 30 days.

Syntax

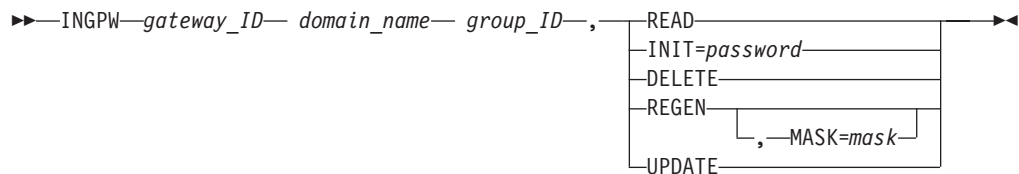

Parameters

gateway_id

The name of the gateway autotask.

domain_name

The domain for which password maintenance services are required.

Note: In a shared System Authorization Facility (SAF) data set environment, if the originating system logs on to two or more destination systems, the domain name specified for this parameter is the originating system, and must match the OWNER value specified in the Gateway Definitions customization dialog panel for the originating system.

group_id

This parameter is required only for environments where multiple shared SAF databases are in use. The *group_id* can be any 2 characters to identify each shared SAF database.

This parameter is required in situations where:

- The originating system logs on to two or more destination systems which reside within the same shared SAF database, and
- The originating system logs on to 2 or more shared SAF databases as described above.

You must code a blank between the *gateway_id* and *domain_name* and *group_id* values, as shown in the INGPW syntax diagram.

READ

Specifies that the desired password is retrieved from the data set. Every 30 days, INGPW generates a new password. This password generation causes SA OS/390 to change the actual RACF[®] password at the next gateway operator logon.

INIT

Used to create an entry in the SA OS/390 password data set for the specified *gateway_id* and *domain_name* values, and to specify an initial password value for the entry.

The *password* value must be between 4 and 8 characters long.

Using INGPW with the *INIT=password* parameter is required as part of installing the SA OS/390 password protection feature. Refer to *System Automation for OS/390 Planning and Installation* for details.

DELETE

Specifies that the record with the matching gateway ID and domain name is deleted.

REGEN

Causes a new password to be generated (satisfying the requirements of the mask if it is specified). The current and new passwords are shown by message AOF661I in response to INGPW REGEN and any subsequent INGPW READ until a INGPW UPDATE is done.

MASK

Describes the format to be used when generating new passwords for gateway autotasks. The password generation mask consists of 4 to 8 pairs of characters, each pair defining the attributes of a single password character. The first character of each pair determines how the second character is to be used.

- ! A password character of the value indicated by the following mask character is required.
- % A password character of the type indicated by the following mask character is required.
- ? A password character of the type indicated by the following mask character is optional.

The password mask is processed from left to right, and will generate a string of characters having a length minimally equal to the number indicated as being required. SA OS/390 requires passwords of at least 4 characters.

The password character type codes indicate the set of characters to be used when generating a new password. The valid type codes are as follows:

Char	Description	Values
\$	National only	@,#,\$
A	Alphabetic only	A-Z

Char	Description	Values
B	Alphabetic/national	A-Z, @, #, \$
C	Consonant (alphabetic, no vowels)	
E	Even numerics	0, 2, 4, 6, 8
N	Numeric only	0-9
O	Odd numerics	1, 3, 5, 7, 9
V	Vowels only	A, E, I, O, U
W	Alphanumeric (no vowels)	
X	Alphanumeric	A-Z, 0-9
Y	Alphabetic/national	A-Z, 0-9, @, #, \$
Z	Alphanumeric/National (no vowels)	

For example, a password mask of !N!N!T%\$%C?N%N%E would cause SA OS/390 to generate passwords beginning with 'NNT' followed by a national character, a consonant, and a two or three digit even number.

UPDATE

Will make the new password generated by REGEN become the current password.

Restrictions and Limitations

- Use a blank instead of a comma to separate the *gateway_id* and *domain_name* and *group_id* values.
- The *password* value must be 4-8 characters long.
- For security reasons, using NetView command-class checking on INGPW is strongly recommended.

Usage

Refer to *System Automation for OS/390 Planning and Installation* and *System Automation for OS/390 User's Guide* for more details on the SA OS/390 password protection feature and on how to use the INGPW command.

Examples

Example 1

This example involves three systems, AOF01, AOF02, and AOF03. The systems are connected as shown in Figure 9.

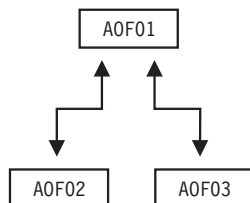

Figure 9. INGPW Example.

These systems do not share a SAF data set; each system maintains its own SAF data set. The following INGPW commands are issued on each system to initialize

password values for gateway operator IDs outbound from each system and inbound on the other systems in the SA OS/390 password data set for each system.

From system AOF01, the following INGPW commands are issued:

```
INGPW GATAOF01 AOF02,INIT=AAAAAAA
INGPW GATAOF01 AOF03,INIT=BBBBBBBB
```

From system AOF02, the following INGPW command is issued:

```
INGPW GATAOF02 AOF01,INIT=CCCCCCC
```

From system AOF03, the following INGPW command is issued:

```
INGPW GATAOF03 AOF01,INIT=DDDDDDD
```

If these systems shared a SAF data set, the only difference in INGPW commands issued is the following:

From system AOF01:

```
INGPW GATAOF01 AOF01,INIT=EEEEEEE
```

Example 2

This example deletes the record for GATCHI01 to log on to domain ATL01 from the SA OS/390 password data set.

```
INGPW GATCHI01 ATL01,DELETE
```

Example 3

This example involves five systems with multiple shared SAF databases. AOF02 and AOF03 share the same SAF data set, and AOF04 and AOF05 share another SAF data set. The systems are connected as shown in Figure 10.

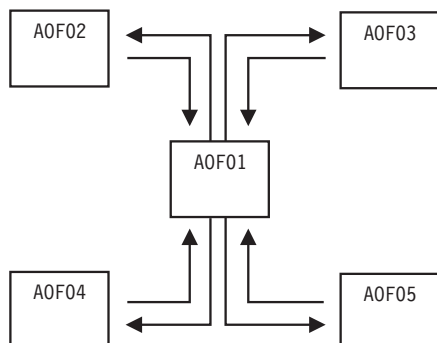

Figure 10. INGPW Shared SAF Database Example.

The following INGPW commands are issued on each system to initialize password values for gateway operator IDs, outbound from each system and inbound on the other systems in the SA OS/390 password data set for each system.

From system AOF01, the following INGPW commands are issued:

```
INGPW GATAOF01 AOF01 R1,INIT=AAAAAAA INGPW GATAOF01 AOF01 R2,INIT=BBBBBBBB
```

From system AOF02, the following INGPW command is issued:

```
INGPW GATAOF02 AOF01,INIT=CCCCCCC
```

INGPW

From system AOF03, the following INGPW command is issued:

```
INGPW GATAOF03 AOF01,INIT=DDDDDDDD
```

From system AOF04, the following INGPW command is issued:

```
INGPW GATAOF04 AOF01,INIT=EEEEEEEE
```

From system AOF05, the following INGPW command is issued:

```
INGPW GATAOF05 AOF01,INIT=FFFFFFFF
```

The SAF group identifiers R1 and R2 used in the INGPW command for AOF01 are necessary to identify each shared SAF database. The names chosen for the SAF group identifiers are user defined, however they must match the values specified on the SA OS/390 SAF Environment Definition panel of the customization dialogs.

INGRCLUP

Purpose

The INGRCLUP common routine is used to cancel address spaces that may be left over by a resource that did not properly shut down. Multiple address spaces with the same name can be canceled.

Syntax

```
▶▶—INGRCLUP—jobname—————▶▶
```

Parameters

jobname

The jobname of the address space(s) that must be canceled.

Restrictions and Limitations

The specified parameter cannot be the jobname of an SA OS/390 managed resource.

Primarily INGRCLUP is meant to be called from within the automation policy (that is, PRESTART or POSTSTART commands). If you want to call the INGRCLUP common routine from within an automation procedure you have to call AOCQRY before any INGRCLUP call.

Return Codes

Return codes are:

- 0 Processing was successful.
- 4 Parameters are invalid.

INGRTCMD

Purpose

The INGRTCMD command can be used as a second level NMC command exit for issuing commands from NMC. It takes an object ID and a command string and substitutes object parameters into the command string before routing it to the appropriate system for execution.

Syntax

►►—INGRTCMD—*object_id*—*cmd_string*—◄◄

Parameters

object_id

Is the RODM object ID that the command should be issued against. It is used to determine the substitution parameters as well as the target sysplex for the command. The command is sent to the system within the target sysplex which the currently received heartbeats and status change notifications originate from.

cmd_string

Is the command to be issued. It may include substitution tokens.

INGSTOBS

Purpose

The INGSTOBS routine lets you subscribe as a status observer for one or more resources. Whenever a status change occurs, the automation manager sends you a notification. The following five statuses are applicable:

Observed status	Is the current status of the resource monitored by the automation manager.
Desired status	Is the status the resource should be in. The automation manager attempts to put the resource into this state. This is also called the 'goal' of the resource.
Automation status	Is the current status of the resource within the automation process of SA OS/390.
Compound status	Is the summary of all statuses and a few other indicators.
Startability status	Indicates whether the resource is ready to be started when a start command is issued.

To register as a status observer, specify the name of a REXX exit. SA OS/390 invokes this exit for each status change. The following parameters are passed to the exit:

- The name of the resource, for example, TSO/APL/SYS1
- The observed status
- The automation status
- The desired status
- The compound status
- The startability status

The parameters are separated by a comma.

Syntax

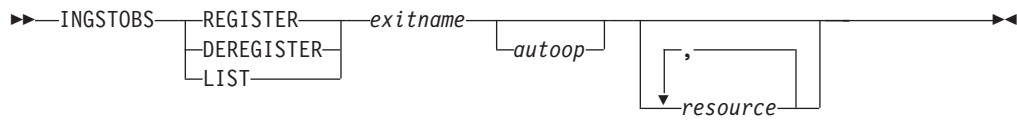

Parameters

REGISTER

Performs the subscription by linking the specified exit to each resource specified.

Each subsequent status change of the resource triggers the exit to be invoked.

DEREGISTER

Breaks the link between the exit and the resource. The exit is no longer invoked if a status change of the resource occurs.

LIST

Displays the resources that are subscribed and linked to the specified exit.

exitname

Specifies the name of the REXX exit to be invoked when a status change of the resource occurred.

autoop

Is the automated function from which the autotask name is defined. The exit is scheduled to run on the autotask associated with the automated function. If omitted, the exit runs on the SA OS/390 task responsible for communicating with the automation manager. It is recommended to use a different task.

resource

Specifies the name of the resource or family of resources, via wildcard, for example, TSO/APL/*. The resource names must be separated by a blank. Alternatively, the list of resources can be passed to the common routine with a NetView default Pipe Safe.

The parameters must be separated by a comma.

Restrictions and Limitations

The INGSTOBS command can only be issued for a local system.

Examples

To register TEST2 as a status observer exit for all resources starting with CICS, specify:

```
INGSTOBS REGISTER,TEST2,MSG2OPER,CICS*/APL/AOC8
```

When the exit is invoked it runs on the autotask associated with the MSG2OPER automated function:

To display the resources that are associated with the status observer exit TEST2, specify:

```
INGSTOBS LIST,TEST2
```

Table 8. Exits and associated resources

Resource	Exits
CICS1LST/APL/AOC8	TEST2/MSG2OPER
CICS1P21/APL/AOC8	TEST2/MSG2OPER

Table 8. Exits and associated resources (continued)

CICS1P22/APL/AOC8	TEST2/MSG2OPER
CICSD11/APL/AOC8	TEST2/MSG2OPER
CICSD12/APL/AOC8	TEST2/MSG2OPER
CICSD13/APL/AOC8	

INGUSS

Purpose

The INGUSS command allows an automation procedure to send commands to OS/390 UNIX System Services.

Syntax

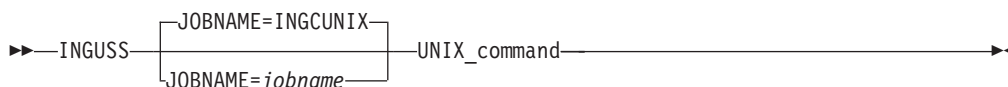

Parameters

JOBNAME=jobname

This is the MVS job name used for the newly created address space which runs the specified command. If you do not specify a job name, INGCUNIX is the default.

UNIX_command

This is the OS/390 UNIX command that is issued under the user ID of the resource this command belongs to. It is not possible to issue commands for other user IDs. It can be any OS/390 UNIX command or the name of a shell script (both fully qualified). The resource that issues this command must have an application type USS.

Restrictions and Limitations

The INGUSS command can be called only by another automation procedure or by a command processor. The common routine AOCQRY must be invoked first to set the necessary TGLOBALs.

Note: The INGUSS command can only be used if the primary JES is available.

Therefore, OS/390 UNIX resources using INGUSS need a HASPARENT dependency to JES. Most of all OS/390 UNIX applications have this dependency. If you want to issue prestart commands, an additional PREPAVAILABLE dependency is necessary. This is because SA OS/390 does not create an address space without JES.

Usage

The following variables can be used to obtain data of the resource, if INGUSS is issued from the automation policy:

&SUBSPATH

The path statement of the resource. The resource must be a process.

INGUSS

&SUBSFILE

The filename of the resource. The resource must be a file.

&SUBSPORT

The port number of the resource. The resource must be a port.

&SUBSUSSJOB

The job name assigned to a process. The resource must be a process.

&SUBSAPPL

The application name.

SUBSASID

The address space ID of the address space the process runs in. The resource must be a process.

The information for &SUBSUSSJOB and &SUBSASID is refreshed with each monitoring cycle. If a process forks and gets a new job name (normally a digit is appended at the end of the original job name), SA OS/390 will detect the new job name after the next scheduled monitoring. This works only if SA OS/390 internal process monitoring is used.

When the resource becomes inactive, the values of &SUBSUSSJOB and &SUBSASID are cleared.

In addition, for process resources %PID% can be used to get the PID of a process. The command `INGUSS /bin/kill %PID%` results in determining the PID of the process defined by the path of the resource and replacing %PID% by the real value of the process ID.

When issuing a command, SA OS/390 switches to the users home directory and sets the following environment variables for the user the resource belongs to:

- HOME
- USER
- SHELL

The login shell uses these environment variables to detect which UNIX profiles to execute. If the started program should get the whole environment of the user as if this user was logged on, you must use a login shell as start command.

Recommendation:

When using INGUSS to start applications, IBM recommends to use the JOBNAME parameter in order to get a unique job name. For example,

```
INGUSS JOBNAME=&SUBSJOB UNIX_start_command
```

Otherwise, all applications started by SA OS/390 without this parameter will have the same job name INGCUNIX (if the application itself does not change the job name).

If the job name is not unique, specify job type MVS.

Examples

To start the inetd through a login shell, issue the following command:

```
INGUSS JOBNAME=INETD /bin/sh -L -c '/usr/sbin/inetd /etc/inetd.conf'
```

JOBNAME=INETD

this is optional, it assigns the MVS job name 'INETD' to the started process

/bin/sh

the shell

-L option for login shell

-c option to the shell to execute the following command:

'/usr/sbin/inetd /etc/inetd.conf'

this is the command that is executed by the login shell

ISQMTSYS

Purpose

The ISQMTSYS routine monitors processor operations target system resources. It is used to verify the availability of a target system according to a timer defined by the user.

Syntax

▶▶—ISQMTSYS—*jobname*—————▶▶

Parameters

jobname

The job name by which SA OS/390 knows the processor operations target system.

Restrictions and Limitations

None.

Return Codes

The return codes are:

0	The target system is active
4	The target system is starting
8	The target system is inactive
12	The resource could not be found

MDFYSHUT

Purpose

MDFYSHUT sets the AOFSHUTMOD task global variable to whatever value is contained in the MDFYSHUT parameter string. The AOFSHUTMOD value is then used by the shutdown program.

MDFYSHUT also provides support for a SUSPEND function.

Syntax

MDFYSHUT

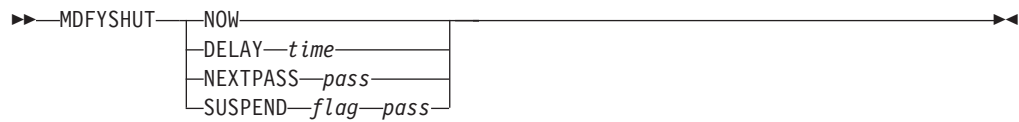

Parameters

NOW

The next shutdown pass will occur as soon as possible.

DELAY

The next shutdown pass will occur after *time* instead of the shut delay defined for the subsystem. Note that there is no validation of the time. If you set an invalid value the shutdown may abend.

NEXTPASS

The next shutdown pass that will be processed (after the subsystem shut delay) will be *pass*, not the current pass plus one.

SUSPEND

Determines how the shutdown is suspended, where:

flag

Is the name of a common global variable that is used to determine how the shutdown is suspended. If the flag is set off, the shutdown will be stopped and the flag will be checked again on the next pass. If the flag is set on the shutdown will continue, that is, it is no longer suspended.

pass

Is the number of the pass that the MDFYSHUT SUSPEND command is coded on. It must be included so that MDFYSHUT can return to this pass and recheck the flag.

Restrictions and Limitations

- MDFYSHUT can be used on any pass of the shutdown.
- The routine containing MDFYSHUT must run on the default task, that is, leave the task field blank.
- The routine containing MDFYSHUT cannot be rescheduled with a CMD LOW.

TGLOBALS

AOFSHUTMOD is a task global variable which is set by the MDFYSHUT command during the shutdown process. Its value affects the subsequent flow of the shutdown process. Possible values are any parameter string for the MDFYSHUT command except for suspend.

Part 3. SA OS/390 System Operations — Generic Routines

Chapter 3. Generic Routines	107	HALTMSG	112
Using SA OS/390 Generic Routines for		ISSUECMD	114
Programming	107	ISSUEREP	118
ACTIVMSG	107	OUTREP	123
AOCFLT	109	TERMMMSG	126
FWDMSG	111		

This part explains how to use the generic routines each of which perform a single, specialized function.

The routines described here may be used while automating any SA OS/390 application. In the context of SA OS/390, an *application* is defined as:

- An MVS subsystem
- An MVS job
- A non-MVS resource; that is, a resource which cannot be monitored using ASCB checks, or which does not respond to the usual MVS startup and shutdown commands
- Your own applications

Occasionally, you may see *subsystem* used to refer to applications in general.

Chapter 3. Generic Routines

Generic routines are routines which are complete in their own right. They can be called from the NetView automation table, from timers, or from other automation procedures.

Using SA OS/390 Generic Routines for Programming

Using common and generic routines in automation procedures provides you with the following advantages:

- Reduced development time, because less code has to be written.
- Portable code, because automation policy information unique to an enterprise can be kept in the automation control file rather than distributed among many automation procedures. The automation procedures implement a number of different rules for handling a situation and the automation control file is used to select which rules are applicable to the current situation.
- A consistent, documented interface.
- Normally, these routines are invoked directly from the message automation table (MAT).

Refer to Part 2, “SA OS/390 System Operations — Common Routines”, on page 5 for further information on how to use common routines in automation procedures.

ACTIVMSG

Purpose

You can use the ACTIVMSG generic routine to respond to ACTIVE and UP messages from your application by changing the SA OS/390 status of the application. ACTIVMSG can also call ISSUEREPLY to issue a reply if the message is a WTOR. Typically, ACTIVMSG is called from the NetView automation table.

ACTIVMSG can be called from the NetView automation table, in which case no parameters are required, or from an automation procedure (CLIST), in which case the JOBNAME parameter must be supplied, and REPLY, PASSES, and CODE1, CODE2, and CODE3 parameters are ignored.

Syntax

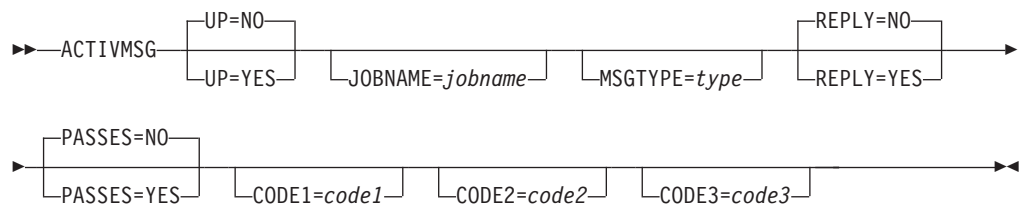

Parameters

UP

This parameter is used to distinguish between ACTIVE messages and UP

ACTIVMSG

messages. ACTIVE messages indicate that the job associated with an application is working but is not yet available for use. UP messages indicate that the job associated with an application is available for use.

NO

NO should be used if you are responding to an application ACTIVE message. The application is placed in ACTIVE status if it is not there already. UP=NO is the default.

YES

YES should be used if you are responding to an application UP message. The application is placed in UP status if it is not there already. If the application is a transient job then it is placed in RUNNING status.

JOBNAME

The name of the job the message is for, if the name cannot be obtained from the message job name field in the NetView automation table. You must supply a value for *jobname* if you are calling ACTIVMSG from a CLIST.

For ISQ900 messages the job name is identical with the processor operations target system name.

MSGTYPE

When ACTIVMSG is called it searches for ENTRY-TYPE pairs of *subsystem-type*, where *subsystem* is the subsystem name derived from the job name.

When a match occurs, the commands associated with the ENTRY-TYPE pair are issued. MSGTYPE=ACTIVE is the default if UP=NO. MSGTYPE=UP is the default if UP=YES.

You can use the MSGTYPE parameter to enter a *type* value to be searched for. For example, if you want to automate on different UP messages for the same application, you may want to use the message ID as the MSGTYPE value.

For ISQ900 messages the MSGTYPE= parameter becomes mandatory.

REPLY

This parameter determines whether ISSUEREP is called to reply to the message. If no REPLY value is coded, ACTIVMSG defaults to REPLY=NO.

YES

If the message being handled by ACTIVMSG is a WTOR, the ISSUEREP generic routine is called to provide the reply.

NO

ISSUEREP is not called.

PASSES

This parameter is passed to ISSUEREP if it is called to reply to the message. If no PASSES value is coded, ACTIVMSG passes PASSES=NO to ISSUEREP.

YES

PASSES=YES is passed to the ISSUEREP generic routine, if it is called.

NO

PASSES=NO is passed to the ISSUEREP generic routine, if it is called.

CODE1=*code1* CODE2=*code2* CODE3=*code3*

These parameters are passed to the ISSUEREP generic routine, if it is called.

Restrictions and Limitations

- An ACTIVMSG for an application that is already in UP status has no effect.

- An ACTIVMSG UP=NO for an application that is already in ACTIVE status has no effect.
- ISSUEREPI is called to reply to a WTOR only if the Start automation flag for the application is on.
- If this command is called on a task other than the AOFWRKxx auto operator that is responsible for the subsystem, ACTIVMSG will schedule itself to that AOFWRKxx auto operator. This means that when the calling procedure gets control again, the status of the subsystem may not have changed yet.

Usage

It is recommended that you use ACTIVMSG for all IEF403I (job started) messages.

If ACTIVMSG is called for a WTOR and ISSUEREPI is not called, OUTREP is called to track the WTOR.

If you are invoking ACTIVMSG for a generic message you should use AOCFILT to screen the message before invoking ACTIVMSG. See "AOCFILT" for more information.

If you are calling ACTIVMSG from an automation procedure, and this calling procedure is not running on the AOFWRKxx automation operator that is responsible for the affected subsystem, the ACTIVMSG routine will be routed to that operator. The ACTIVMSG routine will run asynchronously to the calling procedure. This means that when the calling procedure regains control, the status of the affected subsystem may not yet have changed.

Examples

The following example shows how to issue ACTIVMSG from the NetView automation table:

```
IF MSGID='IEF403I' & TOKEN(2)=SVJOB & DOMAINID = %AOFDOM%
THEN
EXEC(CMD('AOCFILT ' SVJOB 'ACTIVMSG JOBNAME=' SVJOB)
ROUTE(%AOFOPGSSOPER% ));
```

AOCFILT

Purpose

This generic routine is used to screen messages which invoke other generic routines. While it adds to the overhead of a useful invocation of a generic routine, it greatly reduces CPU used to detect an unnecessary invocation.

Syntax

```
▶▶—AOCFILT jobname command—▶▶
*
```

Parameters

jobname

This is the name of the job that the message refers to. If an * is specified then the default job name for the message, retrieved with the NetView Jobname() function, is checked.

AOCFILT

command

This command is issued (in a PIPE) if the *jobname* parameter is the name of a job known to SA OS/390. If the job name is not the name of a job of a SA OS/390-controlled application, the command is not issued.

Restrictions and Limitations

- The command should be invoked only when there is a message in the default safe. Normally this will be from the automation table.
- You must obtain the job name before you invoke AOCFILT.

Return Codes

AOCFILT returns a return code of 0.

Usage

The command should be coded in the automation table where you are using a generic message (such as IEF403I) to invoke one of the SA OS/390 generic routines (such as ACTIVMSG).

AOCFILT routes the passed command to the autooperator responsible for that particular subsystem.

AOCFILT is not as efficient as explicitly screening for the message in the automation table, but may be more efficient than negative screening. AOCFILT also makes the automation statement more portable, in that you will not have to update it if you define a new application to SA OS/390.

Examples

In the example below, the automation table is used to block out all IEF403I messages concerning jobs starting with the letters BAT, and AOCFILT is used to screen the other IEF403I messages.

```
IF MSGID = 'IEF' . & DOMAINID = %AOFDOM% THEN BEGIN;
...
  IF MSGID = 'IEF403I' THEN BEGIN;

      IF TOKEN(2) = 'BAT' . THEN Y DISPLA(N) NETLOG(Y);

      IF TOKEN(2) = SVJOB THEN
      EXEC(CMD('AOCFILT ' SVJOB ' ACTIVMSG JOBNAME=' SVJOB)
      ROUTE(ONE %AOFOPGSSOPER%));
      END;
      ...
      ALWAYS;
      END;
```

Related Commands

- ACTIVMSG (page 107)
- HALTMSG (page 112)
- ISSUECMD (page114)
- ISSUEREPL (page 118)
- TERMMSG (page 126)

FWDMSG

Purpose

FWDMSG can be invoked from the NetView automation table to forward messages from a remote system to a focal point system. By defining entries in the remote NetView automation table that invoke FWDMSG you can:

- Trap messages in which you are interested
- Assign specific message classes to those messages
- Forward the messages to the focal point system

Messages are received by focal point notification operators who are defined to receive messages of the assigned classes.

Syntax

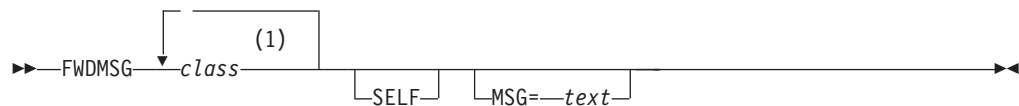

Notes:

- 1 Up to 10 classes may be specified. Classes should be separated by blanks.

Parameters

class

The message notification classes to be assigned to the message. You should specify at least one message class. If no class is specified, the message is sent to GATOPER's authorized receiver. You can specify up to ten blank-delimited message classes. There are no default message classes defined.

SA OS/390 notification classes are described in *System Automation for OS/390 Messages and Codes*. You can define your own message classes using the Environment Definition panels of the customization dialogs.

Note: The classes you assign here must match those defined using the Operator Notification panels of the customization dialogs.

SELF

If FWDMSG is invoked on a system that does not have a defined focal point, send the message to the appropriate notification operators on the issuing system. If FWDMSG is invoked on a system that does have a defined focal point, SELF is ignored.

MSG

The message text used for this message. If not coded, the messages in the message buffer are used. This parameter is valid for single-line messages only.

Restrictions and Limitations

- Do not use the MSG parameter for multiline messages.
- When FWDMSG is called from the NetView automation table, the message to be processed is in the message buffer. When FWDMSG is called from a command

FWDMSG

processor or other automation routine, the message text from the MSG= parameter is treated as the entire message to be forwarded, including the message ID.

- If invoked with a pipe, all messages in the pipe will be forwarded to the focal point as separate messages.

Return Codes

Return codes are:

- 0 Automation procedure processed correctly.
- 1 Processing error was encountered.

When the MSG parameter is used for a multiline message, the following message is issued:

```
AOF013: SPECIFIED OPERAND MSG= INVALID FOR msgid MLWTO
```

TGLOBALS

None.

Examples

Example 1

The following example sends individual messages for each line in the multiline response:

```
IF MSGID='IST075I' & DOMAINID = %AOFDOM%  
THEN EXEC(CMD('FWDMSG A1')ROUTE(ONE *));
```

Example 2

The following example sends all RACF messages to ensure notification of security violations:

```
IF MSGID='ICH' . & DOMAINID = %AOFDOM%  
THEN EXEC(CMD('FWDMSG A2')ROUTE(ONE *));
```

HALTMSG

Purpose

The HALTMSG generic routine changes the status of an application to HALTED status if its Recovery automation flag is on.

HALTMSG can be issued from the NetView automation table, in which case no parameters are required, or from an automation procedure (CLIST), in which case the JOBNAME parameter must be supplied and the REPLY parameter is ignored.

Syntax

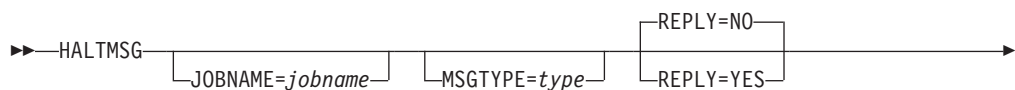

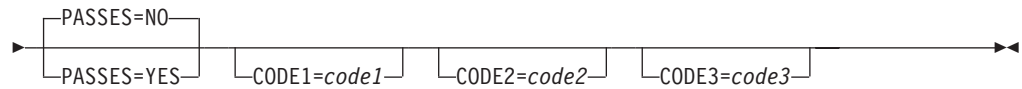

Parameters

JOBNAME

The name of the job the message is for, if the name cannot be obtained from the message job name field in the NetView automation table. You must supply a value for *jobname* if you are calling HALTMSG from a CLIST.

For ISQ900 messages the job name is identical to the processor operations target system name.

MSGTYPE

When HALTMSG is called it searches for ENTRY-TYPE pairs of *subsystem-type*, where:

- *Subsystem* is the subsystem name derived from the job name.
- *Type* defaults to the message ID if it is available, and to HALTED if it is not.

When a match occurs, the commands associated with the ENTRY-TYPE pair are issued.

You can use the MSGTYPE parameter to enter a *type* value to be searched for.

For ISQ900 messages the MSGTYPE= parameter becomes mandatory.

REPLY

Determines whether ISSUEREPLY is called to reply to the message. If no REPLY value is coded, HALTMSG defaults to REPLY=NO.

YES

If the message is a WTOR, the ISSUEREPLY generic routine is called to provide the reply.

NO

ISSUEREPLY is not called.

PASSES

This parameter is passed to ISSUEREPLY if it is called to reply to the message. If no PASSES value is coded, HALTMSG passes PASSES=NO to ISSUEREPLY.

YES

PASSES=YES is passed to the ISSUEREPLY generic routine, if it is called.

NO

PASSES=NO is passed to the ISSUEREPLY generic routine, if it is called.

CODE1=*code1* CODE2=*code2* CODE3=*code3*

These parameters are passed to the ISSUEREPLY generic routine, if it is called.

Restrictions and Limitations

- HALTMSG will not affect an application that is being shut down.
- HALTMSG will not affect an application that is not in UP or HALTED status.
- The application status is updated and the relevant commands are issued each time HALTMSG is run.
- ISSUEREPLY is called for the message only if the Recovery automation flag is on.

HALTMSG

- If this command is called on a task other than the AOFWRKxx auto operator that is responsible for the subsystem, HALTMSG will schedule itself to that AOFWRKxx auto operator. This means that when the calling procedure regains control, the status of the subsystem may not have changed yet.

Usage

Applications can be put into HALTED status when something occurs that leaves them running with reduced function. Use HALTMSG to put an application into HALTED status, and ACTIVMSG (or the SETSTATE command dialog) to change the status.

If HALTMSG is called for a WTOR and ISSUEREP is not called, OUTREP is called to process the WTOR.

If you are calling HALTMSG from an automation procedure, and this calling procedure is not running on the AOFWRKxx automation operator that is responsible for the affected subsystem, the HALTMSG routine will be routed to that operator. The HALTMSG routine will run asynchronously to the calling procedure. This means that when the calling procedure regains control, the status of the affected subsystem may not yet have changed.

Examples

The following example shows how to issue HALTMSG from the NetView automation table:

```
* IKT008I TCAS NOT ACCEPTING LOGONS
IF MSGID = 'IKT008I' & DOMAINID = %AOFDOM% THEN
  EXEC( CMD('HALTMSG')
  ROUTE(ONE %AOFOPGSSOPER%))
DISPLAY(Y) NETLOG(Y);
```

ISSUECMD

Purpose

ISSUECMD issues commands defined in the automation control file. You can use ISSUECMD to trigger your own commands from messages defined in the MESSAGES section of the Application Automation Definition policy item for an application.

ISSUECMD can be called from the NetView automation table or from an automation procedure (CLIST). If you call ISSUECMD from the NetView automation table you must supply the AUTOTYP parameter. If you call ISSUECMD from an automation procedure you must supply the AUTOTYP, ENTRY, and MSGTYP parameters.

Syntax

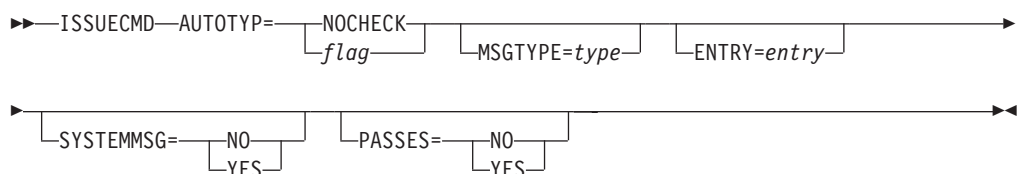

Parameters

AUTOTYP

The automation flag that is to be checked. If the flag is turned off the commands are not issued.

NOCHECK

If NOCHECK is specified, the Recovery flag is checked and the commands are issued regardless of its setting.

If NOCHECK is specified and SYSTEMMSG=YES, Automation and Recovery are the only valid flags.

flag

flag must be one of the following:

AUTOMATION
 INITSTART
 RECOVERY
 RESTART
 START
 TERMINATE (the shutdown flag)

MSGTYPE

This is the value entered in the *type* field in the automation control file entry for the command. It defaults to the ID of the message that initiated ISSUECMD, if ISSUECMD is called from the NetView automation table. If ISSUECMD is called directly from a CLIST you must supply this parameter.

For ISQ900 messages the MSGTYPE= parameter becomes mandatory.

ENTRY

This is the *entry* value to be used to search the automation control file for the commands to issue.

- If ISSUECMD is called from the NetView automation table:
 - *entry* defaults to the application name, as determined from the job name, for application messages
 - *entry* defaults to the system type (MVSESA) for system messages
- If ISSUECMD is called directly from a CLIST you must supply this parameter.

SYSTEMMSG

Indicates whether the message is a system message or an application message.

YES

The message has come from a system rather than from an application. SYSTEMMSG defaults to YES if the command is called from the NetView automation table, and the job name cannot be obtained from the message details.

NO

The message has come from an application.

PASSES

Specifies whether or not passes are used to issue the commands.

YES

Passes are used to issue the commands. The pass count is incremented only if the flag is turned on. The pass count is keyed by type. For normal messages the count is reset when the application is shut down. For system messages, the pass count is reset when NetView is recycled.

ISSUECMD

NO

Passes are not used to issue the commands.

Restrictions and Limitations

- ISSUECMD works best if it is called from the NetView automation table. From a CLIST it is recommended to call AOCQRY and ACFCMD directly rather than call ISSUECMD.
- When using the default of AUTOTYP=NOCHECK, the entry defaults to the job name rather than the application name.
- This command cannot run on an operator station task (OST).
- ISSUECMD will only work when SA OS/390 is fully initialized.

Usage

This routine can be coded into the NetView automation table to issue commands in response to a message. It can also be used on a timer to get automation flag control of timer-issued commands.

The message that caused the ISSUECMD call is stored in the SAFE named AOFMSAFE. All commands that are triggered through ISSUECMD have access to this SAFE.

If PASSES and SYSTEMMSG are not specified and AUTOTYPE=START is flagged, then the current start type will be taken as a selection for the command.

If AUTOTYP=TERMINATE is not specified and AUTOTYP=TERMINATE is flagged, the current stoptype will be taken as a selection for the command.

TGLOCALS

&EHKVAR1

If there is a WTOR contained in an ISQ900I message, ISSUECMD can send replies to this WTOR. When defining the reply in the customization dialogs, the variable &EHKVAR1 can be used for the reply ID. This variable will be substituted with the reply ID by ISSUECMD when a WTOR is received.

Examples

This example shows an automation procedure that calls the ISSUECMD generic routine for handling the HSM subsystem message, ARC0027I.

The automation policy looks as follows:

```

AOFK3D0X          SA OS/390 - Command Response      Line 1   of 4
Domain ID   = IPSNO   ----- DISPACF -----      Date = 07/19/00
Operator ID = ROLI                                         Time = 18:20:45

Command = ACF ENTRY=HSM,TYPE=ARC0027I,REQ=DISP
SYSTEM = KEY3          AUTOMATION CONFIGURATION DISPLAY - ENTRY= HSM
-----
AUTOMATION CONFIGURATION DISPLAY - ENTRY= HSM
TYPE IS ARC0027I
CMD          = (,,'MVS S HSMPL0GB')
END OF MULTI-LINE MESSAGE GROUP

Command ==>
PF1=Help      PF2=End      PF3=Return      PF6=Ro11
                PF9=Refresh  PF12=Retrieve

```

Figure 11. DISPACF Sample Panel

The NetView automation table entry to call ISSUECMD is:

```

IF MSGID = 'ARC0027I' & DOMAINID = %AOFDOM%
THEN EXEC(CMD('ISSUECMD AUTOTYP=START') ROUTE(ONE *));

```

The automation flag to check is Start, which is specified on ISSUECMD using AUTOTYP=START. ISSUECMD validates that automation is allowed by checking the HSM Automation flag before issuing the command. If automation is allowed and message ARC0027I is received for job DFHSM, a command is issued that saves the HSM data set. If message ARC0027I is received for any job other than DFHSM, the message is not automated.

If you specify a clist named MYCLIST instead of an MVS command for the message ARC0027I in the message policy of the customization dialog, this clist can access the original message that triggered ISSUECMD via the named safe AOFMSAFE. This way you are able to access the message attributes and all lines of a multiline message. The code to access this safe should look similar to the following:

```

/* MYCLIST */

...

/* Get the message from the SAFE called AOFMSAFE */
"PIPE (STAGESEP | NAME GETMSG)" ,
  "SAFE AOFMSAFE" ,
  "| STEM orig_msg."

...

Exit

```

ISSUEREP

Purpose

ISSUEREP issues replies defined in the automation control file. You can use ISSUEREP to issue your own replies using the MESSAGES section of the Application Automation Definition policy item for an application.

ISSUEREP can be called from the NetView automation table or from an automation procedure (CLIST). If you call ISSUEREP from the NetView automation table you must supply the AUTOTYP parameter. If you call ISSUEREP from an automation procedure you must supply the AUTOTYP, JOBNAME, and MSGTYP parameters.

Syntax

```

▶▶ ISSUEREP—AUTOTYP=—[NOCHECK—flag—] [MSGTYPE=type] [ENTRY=entry]
▶ [SYSTEMMSG=—YES—] [JOBNAME=jobname] [REPLYID=replyid]
▶ [NO]
▶ [CODE1=code1] [CODE2=code2] [CODE3=code3]
▶ [MSG=—'msgid—msgtext'—] [PASSES=—YES—]
▶ [NO]

```

Parameters

AUTOTYP

The automation flag that is to be checked. If the flag is turned off, no replies are issued.

NOCHECK

If NOCHECK is specified, the Recovery flag is checked and the replies are issued regardless of its setting.

If NOCHECK is specified and SYSTEMMSG=YES, Automation and Recovery are the only valid flags.

flag

The *flag* must be one of:

- AUTOMATION
- INITSTART
- RECOVERY
- RESTART
- START
- TERMINATE (the Shutdown flag)

MSGTYPE

This is the value entered in the *type* field in the automation control file entry for the command. It defaults to the ID of the message that initiated ISSUEREP, if ISSUEREP is called from the NetView automation table. If ISSUEREP is called directly from a CLIST you must supply this parameter.

ENTRY

This is the *entry* value to be used to search the automation control file for the replies to issue.

- If ISSUEREPE is called from the NetView automation table:
 - *entry* defaults to the application name, as determined from the job name, for application messages
 - *entry* defaults to the system type (MVSESA) for system messages
- If ISSUEREPE is called directly from a CLIST you must supply this parameter.

SYSTEMMSG

Indicates whether the message is a system message or an application message.

YES

The message has come from a system rather than from an application. SYSTEMMSG defaults to YES if the command is called from the NetView automation table, and the job name cannot be obtained from the message details.

NO

The message has come from an application.

PASSES

Indicates whether or not passes are used to issue the replies.

YES

Passes are used to issue the replies. The pass count is incremented only when the flag is turned on. The pass count is keyed by type, and for normal messages the count is reset when the application is shut down. For system messages, the pass count is reset when NetView is recycled.

NO

Passes are not used to issue the replies.

JOBNAME

This is used to pass the name of the job when ISSUEREPE is called from a CLIST initiated by the NetView automation table.

MSG

This is used to pass the message text when ISSUEREPE is called from a CLIST initiated by the NetView automation table.

REPLY

This is used to pass the replyid when ISSUEREPE is called from a CLIST initiated by the NetView automation table. This parameter is optional. If it is not specified, the outstanding reply value is retrieved and used.

CODE1

These are used to specify codes which are used in a code match. These codes cannot be used with PASSES=YES (they override it).

When specified, a search of 'entry type' occurs with the codes and whatever is found for the action is used to reply to the WTOR. When codes are specified, ISSUEREPE replies to the message directly rather than through ACFREP.

Restrictions and Limitations

ISSUEREPE may only be run on the same autotask where the WTORs that ISSUEREPE is to reply to would be processed by OUTREP if the ISSUEREPE is to reply to the message that it is invoked for. This is because the ISSUEREPE command blocks the task while it is waiting for OUTREP to run. However, OUTREP cannot run because the task is busy. The OUTREP processing normally occurs on the task

ISSUERE

identified in the %AOFOPWTORS% automation table synonym, but the automation table may route the processing to a different autotask.

If you code an ISSUERE call for a WTOR, you should not code an additional OUTREP call for the same WTOR. If ISSUERE cannot find a value to reply to the WTOR with, it automatically involves OUTREP to record the WTOR. This also happens if ISSUERE is called and finds that the automation for the message is turned off.

Usage

ISSUERE works best if it is called from the NetView automation table. From a CLIST it is recommended to call ACFREP directly rather than to call ISSUERE.

If a reply is not found by either ACFREP or by CDEMATCH, the WTOR is passed to OUTREP which adds it to the system SDF display.

If PASSES, SYSTEMMSG and CODEX are not specified and AUTOTYPE=START is flagged, then the current start type will be taken as a selection for the command.

If AUTOTYP=TERMINATE is not specified and AUTOTYP=TERMINATE is flagged, the current stoptype will be taken as a selection for the command.

Examples

This example shows how an automation procedure calls the ISSUERE generic routine for the GTF REPLY message, AHL125A.

The automation policy settings significant in this example are as follows:

Select the MESSAGES policy item from the SA OS/390 Policy Selection panel for the GTF subsystem.

```

ACTIONS  HELP
-----
AOFGEPOL          SA OS/390 Policy Selection          Row 1 to 17 of 17
Command ==>>>          SCROLL==>>> PAGE

Entry Type : Application          PolicyDB Name : DATABASE_NAME
Entry Name : GTF                  Enterprise Name : YOUR_ENTERPRISE

Action      Policy Name      Policy Description
-----
LINK TO CLASS      DESCRIPTION      Enter description
APPLICATION INFO   LINK TO CLASS    Link instance to class
INFO BRIDGE        APPLICATION INFO Enter and display Application information
AUTOMATION INFO    INFO BRIDGE      Enter INFO Bridge resource name
AUTOMATION INFO    AUTOMATION INFO Define Application automation information
AUTOMATION INFO    AUTOMATION INFO Define Application automation flags
s  MESSAGES        MESSAGES        Define Application messages
SHUTDOWN           SHUTDOWN        Define shutdown procedures
THRESHOLDS        THRESHOLDS      Define error thresholds
RESTART            RESTART         Define commands executed at restart
MINOR RESOURCES    MINOR RESOURCES Define Application sub-component flags
SYSTEM ASSOCIATION SYSTEM ASSOCIATION Define primary and secondary associations
TRIGGER            TRIGGER         Select Application trigger
-----
WHERE USED        WHERE USED      List ApplicationGroups linked to this entry
COPY              COPY           Copy data from an existing entry

F1=HELP      F2=SPLIT      F3=END      F4=RETURN      F5=RFIND      F6=RCHANGE
F7=UP        F8=DOWN       F9=SWAP     F10=LEFT      F11=RIGHT     F12=RETRIEVE

```

Figure 12. SA OS/390 Policy Selection Panel

The SA OS/390 Message Processing panel for the GTF subsystem is displayed, on which you enter the Message ID that is to trigger the reply. You enter REP in the action column to specify that a reply is to be called in response to message AHL125A.

On the SA OS/390 Message Processing panel for the GTF subsystem:

```

COMMANDS  ACTIONS  HELP
-----
AOFPISSM          SA OS/390 - Message Processing          ROW 1 TO 17 OF 21
Command ==>>>          SCROLL==>>> PAGE

Entry Type : Application          PolicyDB Name : DATABASE_NAME
Entry Name : GTF                  Enterprise Name : YOUR_ENTERPRISE

Resource: GTF

Enter messages issued by this resource that will result in automated actions.
Actions: CMD = Command  REP = Reply  CODE = CODE

Action      Message id      Description          Cmd Reply Code
-----
REP         AHL125A        Reply for AHL125A

```

When you press the ENTER key, the SA OS/390 Reply Processing panel for GTF message AHL125A is displayed, on which you can enter the reply text to be issued:

ISSUEREP

```
COMMANDS  HELP
-----
AOFPISSR          SA OS/390 - Reply Processing          ROW 1 TO 17 OF 20
Command ==>>>                                SCROLL==>>> PAGE

Entry Type : Application          PolicyDB Name : DATABASE_NAME
Entry Name : GTF                  Enterprise Name : YOUR_ENTERPRISE

Resource:  GTF
Message ID: AHL125A

Enter the replies to be issued when this resource issues the selected message.

Pass or   Retry  Reply Text
Selection Count
      U
```

The Automation Flags policy item for the GTF subsystem should be set up to allow automation of the message. By entering Y (YES) in the field for the Automation flag and the Start flag, you ensure that automation is allowed when an AHL125A message is issued.

```
COMMANDS  ACTIONS  HELP
-----
AOFGFAS1          SA OS/390 - Flag Automation Specification
Command ==>>>

Entry Type : Application          PolicyDB Name : DATABASE_NAME
Entry Name : GTF                  Enterprise Name : YOUR_ENTERPRISE

Resource:  GTF
Enter level of automation desired.

Automation Flags:  Y = Yes      N = No      E = Exits
Assist Flags:     D = Display  L = Log     N = None

Actions   Flag      Auto      Assist
Automation . Y
Recovery . .
Start. . . .
ShutDown . .
Initstart. .
Restart. . .
Enter or Display times to disable automation . . NO      Yes  No
```

The NetView automation table entry to call ISSUEREP is:

```
IF MSGID = 'AHL125A' & DOMAINID = %AOFDOM%
THEN EXEC(CMD('ISSUEREP AUTOTYP=START') ROUTE(ONE %AOFOPWTORS%));
```

The GTF job name is GTFPROD. The job name is entered on the SA OS/390 Define New Entry panel for the application when it is created, and cannot be changed.

The automation flag to check is Start, which is specified on ISSUEREP using AUTOTYP=START. ISSUEREP validates that automation is allowed by checking the GTF Automation flag before issuing the reply. If automation is allowed and message AHL125A is received for job GTFPROD, ISSUEREP replies with U. If message AHL125A is received for a job other than GTFPROD, the message is not automated.

OUTREP

status on the basis of the first word of the action returned and a priority on the basis of the second word. SA OS/390 replies to all WTORS with a priority of PRIMARY before replying to WTORS with a priority of SECONDARY.

The following table shows the valid actions and their corresponding WTOR statuses:

Table 9. Code Match Actions for OUTREP

WORD1	WORD2	STATUS	COLOR	DESCRIPTION
no action	PRI	UWTOR	Yellow	Either an unusual WTOR is found, or there was no match on either search.
IMPORT	PRI	IWTOR	Red	A serious primary WTOR
IMPORT	SEC	IWTOR	Red	A serious secondary WTOR
IMPORTANT	PRI	IWTOR	Red	A serious primary WTOR
IMPORTANT	SEC	IWTOR	Red	A serious secondary WTOR
NORMAL	PRI	NWTOR	Green	A normal primary WTOR
NORMAL	SEC	NWTOR	Green	A normal secondary WTOR
UNUSUAL	PRI	UWTOR	Yellow	An unusual (intermediate) primary WTOR
UNUSUAL	SEC	UWTOR	Yellow	An unusual (intermediate) secondary WTOR

The codes on which CDEMATCH is to search are entered against a message ID of WTORS in the Code Processing panels of the customization dialogs. Figure 13 shows an example of code entries for an application resource (AOFAPPL). Figure 14 on page 125 shows an example of code entries for the MVSESA resource.

```

COMMANDS  HELP
-----
AOFPISSSE          SA OS/390 - Code Processing          ROW 1 TO 8 OF 20
Command ===>                                           SCROLL===> PAGE

Entry Type : Application          PolicyDB Name  : DATABASE_NAME
Entry Name  : Example            Enterprise Name : YOUR_ENTERPRISE

Resource:    AOFAPPL
Message ID:  WTORS

Enter the value to be passed to the calling CLIST when this resource
issues the selected message and the following codes are contained in
the message.

Code 1          Code 2          Code 3          Value Returned
DSI802A         *                   *                   NORMAL PRI
  
```

Figure 13. Code Processing Panel for an Application Resource

```

COMMANDS  HELP
-----
AOFPISSSE          SA OS/390 - Code Processing          ROW 1 TO 8 OF 20
Command ==>>>          SCROLL==>>> PAGE

Entry Type : MVS Component          PolicyDB Name : DATABASE_NAME
Entry Name : Example                Enterprise Name : YOUR_ENTERPRISE

Resource:  MVSESA
Message ID: WTORS

Enter the value to be passed to the calling CLIST when this resource
issues the selected message and the following codes are contained in
the message.

Code 1          Code 2          Code 3          Value Returned
-----
DSI803A          *          NORMAL PRI
DFH*          PRODCS*          IMPORTANT PRI
DFH*          TESTCST1          IMPORT PRI
DFH*          TESTCSX1          NORMAL PRI
DFH*          TESTCSX2          IMPORT PRI
DFH*          TESTCSX3          NORMAL PRI
DFH*          DEVTCS*          NORMAL PRI
TEST01          WTORTWO          NORMAL
TEST02          WTORTWO          NORMAL SEC

```

Figure 14. Code Processing Panel for the MVSESA Resource

These code entries result in the following behavior:

- If job AOFAPPL issues message DSI802A it is assigned a status of NWTOR and is displayed as NORMAL (green) in SDF.
- If message DSI803A is issued it is assigned a status of NWTOR and is displayed as NORMAL(green) in SDF.
- All WTORS for all production CICS regions with a job name prefix of PRODCS are assigned a status of IWTOR.
- All WTORS for test CICS regions with job names of TESTCST1 or TESTCSX2 are assigned a status of IWTOR. All WTORS for TESTCSX1 and TESTCSX3 are assigned a status of NWTOR.
- All WTORS for all development CICS regions with a job name prefix of DEVTCS are assigned a status of NWTOR.
- Job WTORTWO issues two WTORS, TEST01 and TEST02. TEST02 is an UP message and TEST01 is a shutdown message. Both messages are assigned a priority of NWTOR. TEST01 is assigned a priority of PRI and TEST02 is assigned a priority of SEC to ensure that TEST01 is answered preferentially if ACFREP is called for the application.
- All other WTORS are considered unusual. They are assigned a status of UWTOR and are displayed in yellow in SDF.

Refer to *System Automation for OS/390 Customizing and Programming* for more information on WTOR statuses and code processing.

TGLOBALs

None.

Examples

The following is an example of calling the OUTREP routine directly from the NetView automation table:

OUTREP

```
IF MSGID='DSI802A' & DOMAINID = %AOFDOM%  
THEN  
EXEC(CMD('OUTREP') ROUTE(ONE %AOFOPWTORS%));
```

In this example, OUTREP is called for the NetView outstanding reply message, DSI802A. %AOFDOM% is a synonym defined to be the current domain. %AOFOPWTORS% is a cascade for processing WTORs. Both are defined in AOFMSGSY.

TERMMMSG

Purpose

You can use the TERMMMSG generic routine to change the SA OS/390 status of an application for which you have received a termination message. TERMMMSG can also call ISSUEREP to issue a reply if the termination message is a WTOR. Typically, TERMMMSG is called from the NetView automation table.

The status into which the application is placed by TERMMMSG depends on a number of conditions, including the values of the FINAL, ABEND, and BREAK parameters. The values of the FINAL, ABEND and BREAK parameters may in turn depend on the values of the CODE parameters. The following table shows the statuses which TERMMMSG may place an application in.

Table 10. TERMMMSG Status Transitions

Status	Description	Final	Abend	Break
STOPPING	Application terminated externally	N	N	N
ENDING	For transient applications	N	N	N
ABENDING	Application abend	N	Y	N
BREAKING	Non-recoverable abend	N	N	Y
STOPPED	Application shutdown externally	Y	N	N
ENDED	Transient application shutdown	Y	N	N
BROKEN	Non-recoverable abend	Y	N	Y
RESTART	Restart after abend	Y	Y	N
AUTOTERM	No change during shutdown	N	N	N
AUTODOWN or CTLDOWN or RESTART	System is being shutdown. The status will depend on the shutdown parameters.	Y	?	?
ZOMBIE	Occurs if there are problems with the address space cleanup.	Y	?	?

For information on how the CODE parameters can affect the values of F A and B see the description of the CODE parameter below.

TERMMMSG can be called from the NetView automation table, in which case no parameters are required, or from an automation procedure (CLIST), in which case the JOBNAME parameter must be supplied, and REPLY, PASSES, and CODE1, CODE2, and CODE3 parameters are ignored.

Syntax

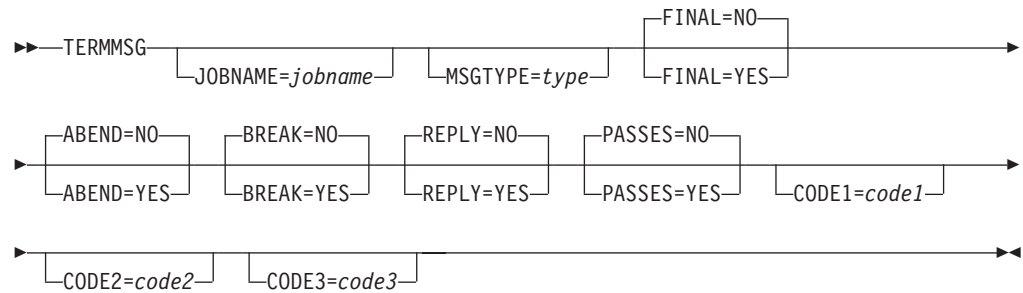

Parameters

JOBNAME

The name of the job the message is for, if the name cannot be obtained from the message job name field in the NetView automation table.

For ISQ900 messages the job name is identical to the processor operations target system name.

MSGTYPE

When TERMMMSG is called it searches for ENTRY-TYPE pairs of *subsystem-type*, where *subsystem* is the subsystem name derived from the job name.

When a match occurs, the commands associated with the ENTRY-TYPE pair are issued. The value of *type* defaults to the status that the application is placed into.

You can use the MSGTYPE parameter to enter a *type* value to be searched for.

For ISQ900 messages the MSGTYPE parameter becomes mandatory.

FINAL

Indicates whether this is the final termination message. If no FINAL value is coded, TERMMMSG defaults to FINAL=NO.

YES

The message is the final termination message for the application. The application will be placed into the appropriate status, depending on the values of the the ABEND and BROKEN parameters. See Table 10 on page 126 for details. If it is monitorable, the application is not placed into a down status until an application monitor check confirms that it has left the machine. If it is not monitorable, the application is placed into a down status after its termination delay time.

NO

This is not the final termination message.

ABEND

Indicates whether or not the application is suffering a recoverable abend. If no ABEND value is coded, TERMMMSG defaults to ABEND=NO.

YES

The application is suffering a recoverable abend. The application will be placed into the appropriate status, depending on the value of FINAL parameter. See Table 10 on page 126 for details.

TERMMSG

When the final termination message for an abending application (FINAL=YES) is received, the error threshold is checked and the application is restarted if it has not exceeded its critical error threshold.

NO

The application is not suffering a recoverable abend.

BREAK

Indicates whether or not the application is suffering a non-recoverable abend. The application will be placed into the appropriate status, depending on the value of the FINAL parameter. If no BREAK value is coded, TERMMSG defaults to BREAK=NO.

YES

The application is suffering a non-recoverable abend and should be placed into BREAKING status. When its final termination message is received (FINAL=YES) it is placed into BROKEN status, from which SA OS/390 will not restart it without human intervention through the SETSTATE command dialog.

NO

The application is not suffering a non-recoverable abend.

REPLY

Determines whether ISSUEREP is called to reply to the message. If no REPLY value is coded, TERMMSG defaults to REPLY=NO.

YES

If the message triggering TERMMSG is a WTOR, ISSUEREP is called to reply to it.

NO

ISSUEREP is not called.

PASSES

This parameter is passed to ISSUEREP if it is called to reply to the message. If no PASSES value is coded, TERMMSG passes PASSES=NO to ISSUEREP.

YES

PASSES=YES is passed to ISSUEREP.

NO

PASSES=NO is passed to ISSUEREP.

CODE1 CODE2 CODE3

These codes are used to search the automation control file for an action that modifies the other parameters. At first the ACF is searched for 'subsystem msgid' entries. If these cannot be found, the ACF is searched for 'MVSESA msgid' entries. The meaning of the codes depends on the NetView automation table entry that invoked TERMMSG. Valid actions are as follows:

Action	Final ?	Abend ?	Break ?
STOPPING	-	-	-
STOPPED	Yes	-	-
ABENDING	-	Yes	-
ABENDED	Yes	Yes	-
BREAKING	-	-	Yes
BROKEN	Yes	-	Yes

The codes are passed to ISSUEREP if it is called.

Restrictions and Limitations

- If a normal termination message (ABEND=NO,BREAK=NO) is received for an application that is not being shut down by SA OS/390 (and is already in the AUTOTERM status), it is placed into STOPPING status. When its final termination message has been processed, its Restart option is checked. If it is ALWAYS it is placed into RESTART status, if not it will be placed into STOPPED status.

This behavior can be changed using the AOFRESTARTALWAYS advanced automation option.

- Once an application has entered a serious error condition (status of AUTOTERM, STOPPING, ABENDING, or BREAKING), termination messages indicating less important error conditions are ignored.
- Commands for a status are only issued the first time the status is entered.
- If this command is called on a task other than the AOFWRKxx auto operator that is responsible for the subsystem, TERMMSG will schedule itself to that AOFWRKxx auto operator. This means that when the calling procedure gets control again, the status of the subsystem may not have changed yet.

Usage

If you are invoking TERMMSG for a generic message you should use AOCFILTR to screen the message before invoking TERMMSG. See "AOCFILTR" on page 109 for more information.

TERMMSG traps should be used for most applications. This ensures early detection of any problems. A single entry for IEF404I can be used to process the final termination message for all applications.

```
IF MSGID = 'IEF404I' & TOKEN(2) = SVJOB & DOMAINID = %AOFDOM%
THEN
DISPLAY(N) NETLOG(Y) SYSLOG(Y)
EXEC( CMD('TERMMSG FINAL=YES,JOBNAME=' SVJOB) ROUTE(ONE %AOFOPGSSOPER%));
```

Using the code entries can obviate the need to code multiple table entries or issue multiple commands from an entry.

```
IF MSGID = 'IEF450I' & TOKEN(2) = SVJOB & DOMAINID = %AOFDOM%
& TEXT = 'IEF450I' . 'ABEND=' SCODE UCODE
THEN
DISPLAY(N) NETLOG(Y) SYSLOG(Y)
EXEC CMD('TERMMSG JOBNAME=' SVJOB
',CODE1=' SVJOB ',CODE2=' SCODE ',CODE3=' UCODE)
ROUTE(ONE %AOFOPGSSOPER%);
```

If you specify `dispacf mvsesa ief450I`, a panel similar to the one following is displayed:

TERMMSG

```
AOFK3D0X          SA OS/390 - Command Response      Line 1   of 19
Domain ID   = IPSFN   ----- DISPACF -----      Date = 01/07/98
Operator ID = ROLI                                         Time = 14:56:33

Command = ACF ENTRY=MVSESA,TYPE=IEF450I,REQ=DISP
SYSTEM = KEY5      AUTOMATION CONFIGURATION DISPLAY - ENTRY= MVSESA
-----
AUTOMATION CONFIGURATION DISPLAY - ENTRY= MVSESA
TYPE IS IEF450I
CODE          = (*,S913,*, "BREAKING")
CODE          = (*,S306,*, "BREAKING")
CODE          = (AIMS,*,*, "BREAKING")
CODE          = (PIMS,*,*, "BREAKING")
CODE          = (IIMS,*,*, "ABENDING")
CODE          = (TIMS,*,*, "ABENDING")
CODE          = (AIMS*,*,U0002, "BREAKING")
CODE          = (PIMS*,*,U0002, "BREAKING")
CODE          = (IIMS*,*,U0002, "BREAKING")
CODE          = (TIMS*,*,U0002, "BREAKING")
CODE          = (*,S122,*, "STOPPED")
CODE          = (*,S222,*, "STOPPED")
CODE          = (*,S422,*, "STOPPED")
CODE          = (*,S522,*, "STOPPED")
CODE          = (TPX*,*,U0100, "BREAKING")
CODE          = (*,*,*, "ABENDING")
END OF MULTI-LINE MESSAGE GROUP

Command ==>
PF1=Help      PF2=End      PF3=Return    PF6=Ro11
                PF9=Refresh  PF12=Retrieve
```

Figure 15. DISPACF Command Dialog Panel

If you are calling TERMMSG from an automation procedure, and this calling procedure is not running on the AOFWRKxx automation operator that is responsible for the affected subsystem, the TERMMSG routine will be routed to that operator. The TERMMSG routine will run asynchronously to the calling procedure. This means that when the calling procedure regains control, the status of the affected subsystem may not yet have changed.

Part 4. SA OS/390 I/O Operations Commands (API)

Chapter 4. I/O Operations Commands (API) . . . 133	QUERY ENTITY SWITCH 157
Using I/O Operations Commands for	QUERY FILE 160
Programming 133	QUERY INTERFACE CNTLUNIT. 162
Calling the I/O Operations API 133	QUERY INTERFACE SWITCH 168
FICON Switches 134	QUERY RELATION CHP 176
FICON Cascaded Switches 135	QUERY RELATION CNTLUNIT 178
Common Parameters 135	QUERY RELATION DEV 180
Syntax. 136	QUERY RELATION HOST 188
Object Identifiers 137	QUERY RELATION SWITCH 190
Common Output Header 140	QUERY SWITCH 193
DELETE FILE 141	REMOVE and RESTORE CHP. 196
QUERY ENTITY CHP 141	REMOVE and RESTORE DEV. 199
QUERY ENTITY CNTLUNIT 146	WRITEFILE 205
QUERY ENTITY DEV 149	WRITEPORT 207
QUERY ENTITY HOST 152	WRITESWCH 211

This part describes SA OS/390 I/O operations commands that are available through the API only.

For general information about the SA OS/390 commands, refer to *System Automation for OS/390 User's Guide*.

All commands described in *System Automation for OS/390 Defining Automation Policy* are also available through the API.

Chapter 4. I/O Operations Commands (API)

Using I/O Operations Commands for Programming

In addition to the I/O operations commands described in *System Automation for OS/390 Operator's Commands*, the following commands are available to programmed API calls:

- DELeTe File
- Query Entity Chp
- Query Entity CntlUnit
- Query Entity Dev
- Query Entity Host
- Query Entity Switch
- Query File
- Query Interface CntlUnit
- Query Interface Switch
- Query Relation Chp
- Query Relation CntlUnit
- Query Relation Dev
- Query Relation Host
- Query Relation Switch
- Query Switch
- Remove and Restore Chp
- Remove and Restore Dev
- WRITEFILE
- WRITEPORT
- WRITESWCH

Calling the I/O Operations API

I/O operations application program interfaces support:

- Invocations from an EXEC written in the REXX programming language.
- Invocations from a user program written in a language that adheres to the Assembler Language CALL macro interface conventions used by MVS/ESA. This type of caller is referred to as a program that uses the CALL macro. For information on the CALL macro, refer to *MVS/ESA Application Development Macro Reference*. These callers can invoke IHVAPI; however IHVAPI2 is recommended.
- All variables, except arrays, data blocks, tables and tokens, must be in uppercase.
- Programs that use the CALL macro to invoke IHVAPI2 (preferred for the following reasons):
 - IHVAPI2 lets the caller choose between managing the command response area or letting I/O operations do so. IHVAPI requires the user to manage the response area.
 - IHVAPI2 can return data in a response area that exceeds 64KB; IHVAPI cannot.
 - IHVAPI2 accepts all the variables needed by the I/O operations commands, including multisystem commands. IHVAPI accepts only 24-character variables as input parameters except those that specify an array, data block, or table. For those operands, it accepts a variable long enough to contain the array or table.

- Tokens
- The MVS REXX Call invocation in addition to the Address Link invocation.
- TSO/E (optional). For further information about how to invoke I/O operations by a REXX EXEC call, refer to “Invoking I/O Operations By a REXX EXEC”, on page 259.

General Information about the Response Area

For most commands, I/O operations returns data to the caller in a response area.

The Data in the Response Area: When data is returned in the response area, it is either a single record or a concatenation of records in character or hexadecimal format, or both, which overlays any previous data.

For most commands, I/O operations returns at least one message in the response area. However, there are exceptions. For example, the multisystem commands can return no data, one or more messages, or a data block. Also, failed commands do not always return data in the response area.

When I/O operations returns a message, the first 3 characters are IHV, which identify I/O operations. Although the messages resulting from most commands are concatenated, up to four blank 80-character records can intervene between two successive I/O operations messages.

The Length of the Response Area: The amount of data that can be returned by a multisystem command can be very large, so the following approximate maximum lengths are provided.

For DISPLAY DEVICE, DISPLAY RESULTS, and DISPLAY VARY commands, assume that 65,528 bytes (64KB) suffice.

For REMOVE DEV, RESTORE DEV, and the QUERY commands, calculate $100 + (1 + x) * y * z$, where:

- x One of the following:
- The number of objects in a QUERY ENTITY, REMOVE DEV, or RESTORE DEV command
 - The number of interfaces in a QUERY INTERFACE command
 - The number of paths in a QUERY RELATION command (in this context, number is the number from one host’s perspective).
- y Number of hosts scoped in the command
- z Size of the output row (the following sizes are approximations):
- z 250 for a REMOVE DEV or RESTORE DEV command
 - z 300 for a QUERY ENTITY or QUERY INTERFACE command
 - z 500 for a QUERY RELATION command

For all other commands, assume that 25,600 bytes (24KB) suffice.

For invocations by a REXX EXEC, the final size should be doubled because I/O operations uses the IRXEXCOM facility to access ihvrc, ihvreas, and ihvresp, and it uses the STORE function of IRXEXCOM to set them.

FICON Switches

FICON switches allow imbedded space characters on port names. Consequently, I/O operations will no longer issue message IHVD106I when detecting imbedded blanks in port names of FICON switches.

However, I/O operations does not support imbedded blanks on port names, either in the ISPF dialogs or in the console command interface. The reason is that generic names and port names must not contain imbedded blanks when used in I/O operations console commands.

FICON Cascaded Switches

I/O operations supports cascaded switches with some restrictions:

1. For CTC connections on cascaded switches, I/O operations can neither display CTC control unit data nor manage CTC devices. The reason for this is that when I/O operations attempts to determine the attached NDs of such a device, it can get stuck behind a never-ending channel program on the device.
2. The Block command is not supported on Inter-Switch-Link ports (E_Ports). When an E_Port is affected by the command, it is rejected with return code 8 and reason code X'49'. In addition, the message IHVC913I is issued, showing the first or only port that is affected by the command.
3. All other I/O operations commands affecting E_Ports (Allow, Prohibit, Unblock, WRITEPORT and WRITESWCH) must specify the command option IGNore when an E_Port is involved. Otherwise the command is rejected with return code 8 and reason code X'49'. In addition, the message IHVC913I is issued, showing the first or only port that is affected by the command.
The IGNore option makes the issuer of the command aware that *safe-switching* can no longer be guaranteed. Safe-switching sets the paths and devices online or offline when the path from a chpid to a device becomes valid, or is no longer valid because of port manipulation.
4. If an attached Node Descriptor of a device cannot be determined because the path or channel is offline, the Display Device command does not show any control unit data for the particular channel path id.
5. A dynamic configuration change that results in the allocation/deallocation of a cascaded switch is currently **not** supported.

Note: It is recommended that all switches are defined to the Hardware Configuration Definition (HCD) including their device numbers. This allows I/O operations to show the LSN also for cascaded switches.

Common Parameters

Many of the commands described in this chapter share several parameters that are described in this section. To help make the command descriptions that follow a little clearer, the descriptions of these common parameters will not be repeated, you will be referred to this section.

These common parameters are:

- Object Identifier:
 - Value
 - Range
 - Array
 - Table
- I/O resource identifiers:
 - RNUM
 - HNUM
 - XNUM

- PTOK
- LTOK
- Host identifiers:
 - HOST
 - XSYS
 - SCOPE

Syntax

Object Format:

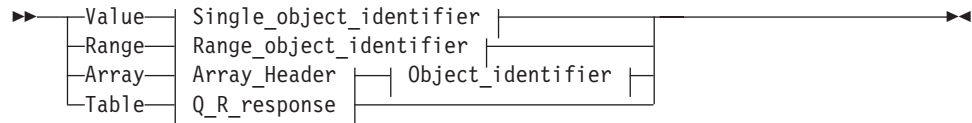

Single_object_identifier:

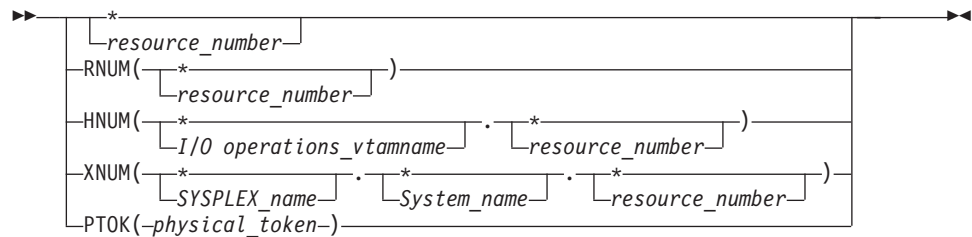

Range_object_identifier:

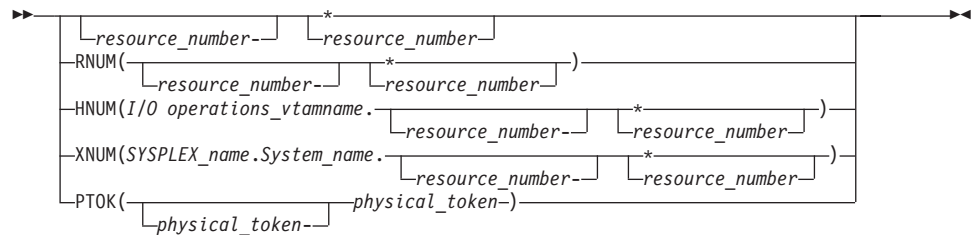

Scope:

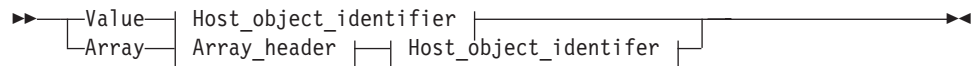

Host_object_identifier:

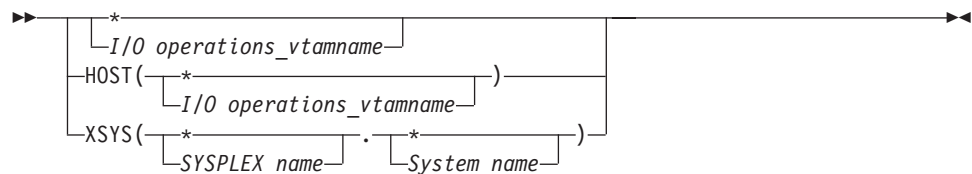

Object Identifiers

Value *value* | *

Specify V or VALUE. Then, specify either a single *element* or * for all *elements* known to the issuing I/O operations. (If * is specified, output array elements are sorted by searched element.)

Note: An element can either be a CHIPID, CONTROL UNIT or a DEVICE NUMBER.

Range *lower-upper* | *lower*-*

Specify R or RANGE. Specify the lower limit, followed by a hyphen, followed either by the upper limit of the range or an asterisk '*' to specify the highest number. Output array elements are sorted by number.

Array

Specify A or ARRAY. The output of array elements is returned in the input order. Specify the input array in the following format:

Note: Up to 32767 (decimal) CHPIDs can be entered for CHP, but for CNTLUNIT and DEV the overall size is restricted to 32000 control unit numbers or device numbers respectively.

Note: SA OS/390 continues to support the ESCON® Manager Release 2 format for input arrays. For information about this format, see *Using the Enterprise Systems Connection Manager*.

Table 11. Standard SA OS/390 Array Format. This format is the same as the ESCON Manager Release 3 array format.

Offsets					
Dec	Hex	Type	Len	Name (Dim)	Description
0	(0)	BIT	1		1 = SA OS/390 formatted array
0	(0)	UNSIGNED	4		Number of elements
4	(4)	UNSIGNED	1		Format ID. Only 0 is valid for SA OS/390 array
5	(5)	CHARACTER	3		Reserved
Array elements					
8	(8)	CHARACTER	38		Object identifier

Table

Specify T or TABLE. Requires CODE=1 and the RESPONDER host application name must match the scope host name to be operated on. The table format is identical to the output format of a QUERY RELATION command.

An I/O resource identifier type can be one of the following:

RNUM

RNUM is an identifier value that is a resource number. All I/O resource object types have a resource number. Each object type specifies it differently, such as:

CHP Channel path identifier

CU Control unit number

DEV Device number

SWITCH

Switch device number

The value for RNUM must be from 1 to 4 hexadecimal characters or an asterisk (*).

Examples:

```
*  
40  
40-*  
40-4F  
RNUM(*)  
RNUM(100)  
RNUM(100-*)  
RNUM(100-10F)
```

HNUM

HNUM is an identifier value that is qualified by an I/O operations host name. It is a specific host's resource number. HNUM must be 1 to 8 alphanumeric characters for the host name (or be an asterisk), followed by a period (.), followed by 1 or 2 hexadecimal characters for the resource number (or be an asterisk).

Examples:

```
HNUM(*.*)  
HNUM(*.40)  
HNUM(H1.*)  
HNUM(H1.40)  
HNUM(H1.40-*)  
HNUM(H1.40-4F)
```

XNUM

XNUM is an identifier value that is qualified by a sysplex name and a system name. It is a specific sysplex system's resource number. XNUM must be 1 to 8 alphanumeric characters for the sysplex name (or be an asterisk), followed by a period (.), followed by 1 to 8 alphanumeric characters for the system name (or be an asterisk), followed by a period (.), followed by 1 or 2 hexadecimal characters for the resource number (or be an asterisk).

Examples:

```
XNUM(*.*.*)  
XNUM(*.S1.40)  
XNUM(X1.*.40)  
XNUM(X1.S1.*)  
XNUM(X1.S1.40)  
XNUM(X1.S1.40-*)  
XNUM(X1.S1.40-4F)
```

PTOK

PTOK is an identifier value that is a physical token. PTOK is a 32-character field. Refer to *System Automation for OS/390 Operator's Commands* for further information about physical tokens.

Examples:

```
PTOK(.... 009032002IBM0200000000000100)  
PTOK(.... 009032002IBM0200000000000100-....009032002IBM02000009999999900)
```

LTOK

LTOK is an identifier value that is a logical token. LTOK is a 32-character field. Refer to *System Automation for OS/390 Operator's Commands* for further information about logical tokens.

Examples:

```
LTOK(0123456789ABCDEF0123456789ABCDEF)  
LTOK(0123456789ABCDEF0123456789ABCDEF-0123456789ABCDEF0123456789ABCDEF)
```

A host identifier type can be one of the following:

HOST

HOST is an identifier value that is an I/O operations's VTAM application name. HOST must be from 1 to 8 alphanumeric characters for the host name (or be an asterisk).

Examples:

```
HOST(*)
HOST(H1)
HOST(H1-*)
HOST(H1-H9)
```

XSYS

XSYS is an identifier value that is a sysplex name, or a system name, or both. The rules are:

- If both a sysplex name and system name are specified, then only that system in the sysplex is considered for the command
- If a specific sysplex name is specified, then only the systems in that sysplex are considered for the command
- If a specific system name is specified, then only the systems with that name are considered for the command

XSYS must be from 1 to 8 alphanumeric characters for the sysplex name (or be an asterisk), followed by a period (.), followed by 1 to 8 alphanumeric characters for the system name (or be an asterisk).

Examples:

```
XSYS(*.*)
XSYS(*.S1)
XSYS(X1.*)
XSYS(X1.S1)
XSYS(*.S1-*)
XSYS(*.S1-S9)
XSYS(X1.S1-*)
XSYS(X1.S1-S9)
```

SCOPE

SCOPE specifies the set of I/O operations hosts that respond to a multisystem command.

Notes:

1. When ARRAY is the *Object_format_type*, the *Object_Identifier_Types* can be mixed and every *Object_Identifier_Type* must match the class of the specified *Object_Type* (all must be I/O_resources or all must be Hosts). For example, Q E HOST can accept only HOST and XSYS entries in the array.
2. The Array_header contains the number of elements in the array.
3. PTOK is valid with RANGE but you should be fully aware of PTOK structure. For example, RANGE PTOK could be used to specify all of the serial numbers of a certain type of device. However, certain PTOK values may cause unpredictable results with RANGE.
4. When ARRAY is the *SCOPE_format_type*, the *Host_Object_Identifier_Types* can be mixed (HOST and XSYS).
5. Output from a QUERY ENTITY command consists of a header, which is identical for each entity with the exception of the "Eye-Catcher" (offset 0), followed by the substructures, which are unique to each type of entity.

6. If not otherwise stated at the particular command descriptions no input port information is returned by a QUERY RELATION command when the command specifies a switch that is the destination switch of a cascaded switch pair.

Common Output Header

Offsets		Dec	Hex	Type	Len	Name (Dim)	Description
Header for all Query Entity output structures Size = 80 bytes		0	(0)	STRUCTURE	*	QEU	
		0	(0)	CHARACTER	80	HDR	
		0	(0)	CHARACTER	4	EYE_CATCHER	see paragraph below
		4	(4)	UNSIGNED	2	HDR_SIZE	Size of this header substructure
		6	(6)	UNSIGNED	2	ROW_SIZE	Size of array element for this substructure
		8	(8)	CHARACTER	8	ESCM_HOST	Responding host VTAM application name
		16	(10)	CHARACTER	4	ESCM_REL	SA OS/390 version/release
		20	(14)	CHARACTER	32	HOST_PID	Host physical identifier
				111.		VALIDITY	0 = valid 1 = not current 2 = not valid
				...1 1111		*	Reserved
		21	(15)	CHARACTER	3	*	Reserved
		24	(18)	CHARACTER	6	TYPE_NUM	For example, 3090EX
		30	(1E)	CHARACTER	3	MODEL_NUM	For example, 60A
		33	(21)	CHARACTER	3	MFR	For example, IBM
		36	(24)	CHARACTER	2	PLANT	Where manufactured
		38	(26)	CHARACTER	12	SEQUENCE_NUM	(1990) first 7 bytes are 0, last 5 bytes are serial number
		50	(32)	CHARACTER	2	STATUS	Status of PID
				1...		AMBIGUOUS	Ambiguous state detected on PID
				.1...		REFLECTED	1=PID is derived from attached ND
		50	(32)	BITSTRING	1	*	Reserved
		52	(34)	UNSIGNED	4	NUM_ROWS	Dimension of array below
		56	(38)	UNSIGNED	1	FORMAT_ID	Identifies format of data
				1...		MORE_DATA	0=all data that satisfies query is returned here. 1=more data satisfies query (but won't fit now). Ask again with RANGE parameter type.
				.111 1111		*	Reserved
		58	(3A)	CHARACTER	8	PLEX_NAME	Sysplex name (blank if none)
		66	(42)	CHARACTER	8	SYST_NAME	System name
		74	(4A)	CHARACTER	2	*	Reserved
		76	(4C)	UNSIGNED	4	NUM_HOSTS	Number of hosts responding
End of Header							

The EYE_CATCHER, which represents the title of every mask, identifies the control block.

DELETE FILE

Purpose

Use the DELETE FILE command at the I/O operations API to delete a saved switch configuration that is stored at the switch specified in the command. The switch must be allocated to the issuing I/O operations.

Syntax

```
►►—DELeTe File—filename—swchdevn—►►
```

Parameters

filename

Specify the file name in 1 through 8 valid EBCDIC codes. Valid codes are uppercase alphabetical characters (A–Z), digital characters (0–9), and 2 special character: the underscore (_) and the hyphen (-). However, do not specify the following file names: AUX, COM*n* (where *n*=1–4), CON, IPL, LPT*n* (where *n*=1–3), NUL, or PRN.

swchdevn

Specify the switch device number in up to 4 hexadecimal digits. The switch must be allocated, or attached, to the issuing I/O operations. You can issue the DISPLAY SWITCH command to obtain a list of these switches.

Usage

You cannot delete the switch IPL file, which is supplied with each IBM Director and is activated automatically when the unit is powered on.

QUERY ENTITY CHP

Purpose

Use the QUERY ENTITY CHP command at the API to obtain data about the channel path (Chp) that you specify.

Syntax

```
►►—Query Entity Chp—| Object_format | Scope | Options |►►
```

Output

I/O operations returns output from the QUERY ENTITY CHP command in the following format.

Offsets					
Dec	Hex	Type	Len	Name (Dim)	Description
0	(0)	STRUCTURE	*	QEC	
Header for all Query Entity output structures					
Size = 80 bytes. For details see section "Common Output Header" on page 140.					
80	(50)	CHARACTER	184	CHPS (*)	Individual chpid data
80	(50)	UNSIGNED	1	CHPID	Channel path ID

QUERY ENTITY CHP

Offsets					
Dec	Hex	Type	Len	Name (Dim)	Description
81	(51)	BITSTRING	1	STATBITS	See below
		1... ..		VALID_DATA	1=this chpid is defined on host. Other bits are reserved
82	(52)	CHARACTER	32	CHP_PTOK	Physical Token
82	(52)	CHARACTER	32	ND_DET	Determined ND -- "who am I"
114	(72)	CHARACTER	32	ND_ATT	Attached ND -- "who are you"
146	(92)	UNSIGNED	1	TYPE	CHPID type. A character representation of this type (for example, CNC_P) is available in CHPDTYPE at offset 220. X'01' = block X'02' = byte X'03' = cnc_p (serial point-to-point) X'04' = cnc_s (serial switched) X'05' = cnc_? (serial unknown) X'06' = ctc_p (ctc point-to-point) X'07' = ctc_s (ctc switched) X'08' = ctc_? (ctc unknown) X'09' = cvc_p (converter point-to-point) X'0A' = cvc_? (converter unknown) X'0B' = native X'0C' = Coupling Facility sender X'0D' = Coupling Facility receiver X'0E' = cby_? (Byte converter) X'0F' = cby_p (Byte converter) X'10' = OSA X'11' = ISD Other values are reserved
147	(93)	CHARACTER	1	TRAITS	Chpid characteristics
		1... ..		ONLINE	1=chpid is operational on this host
		.1.. ..		DCM_MANAGED	1=chpid is DCM managed on this host
		..11 ..			Reserved
	 1111		PROTOCOL	Interface protocol used: 0 = unspecified 1 = LED 2 = Laser 3 = Laser-1 (shortwave) 4 = Laser-2 (shortwave) 5 = Laser-3 (longwave) Other values are reserved
Entity Attribute Mask					
148	(94)	BITSTRING	4	EAM	Logical Entity classification:
		1111 ..		LOG_CLASS	0000 = unspecified 0001 = host 0010 = chpid 0011 = switch 0100 = control unit 0101 = device 0110 = reserved 0111 = ambiguous (CHCU, etc) 1000-1111 are reserved

Offsets			Len	Name (Dim)	Description
Dec	Hex	Type			
	1111		PHYS_CLASS	Physical Entity classification: 0000 = unspecified 0001 = host 0010 = chpid 0011 = switch 0100 = control unit 0101 = device 0110 = ESCON Model 2 converter 0111 = ambiguous (link is static (no ND_ATT) and IODEF is ambiguous 1000 = CF internal path (only set for CUs) 1001-1111 are reserved
149	(95)	CHARACTER	2	STATE	State of the entity
	1...		LOGICAL	1=entity is logical
	.1..		P_CURR	1=entity is physically current
	..1.		P_HIST	1=entity is physical history
	...1		LOG_OTHER	1=logical by another interface
	1...		P_OTHER_CURR	1=physical by another interface
1..		P_OTHER_HIST	1=physical history by other interface
1.		P_INDIRECT	1=(for CU EAM) - the EAM validity was derived from the attached (ND) interfaces from the control unit. 0=(for CU EAM) - the EAM validity was obtained from the CU itself (can only be true for opened switches). 1=(for chp AEAM) - the attached ND for the entity being queried is history but we got the chpid's validity from the chpid's detached ND (which is always valid) so the AEAM is marked P_CURR for the (attached) chpid.. 0=(for chp AEAM) - that the attached ND and AEAM have the same validity.
1		P_AMB	1=physical ambiguous configuration on some interface
	1...		LOG_AMB	1=logical ambiguous configuration on some interface
	.1..		CLASS_AMB	1=logical and physical classes are not compatible
	..11	1111		*	Reserved
151	(97)	BITSTRING	1	*	Reserved
End of Mask					
Entity Attribute Mask					
152	(98)	BITSTRING	4	AEAM	

QUERY ENTITY CHP

Offsets					
Dec	Hex	Type	Len	Name (Dim)	Description
		1111		LOG_CLASS	Logical Entity classification: 0000 = unspecified 0001 = host 0010 = chpid 0011 = switch 0100 = control unit 0101 = device 0110 = reserved 0111 = ambiguous (CHCU, etc) 1000-1111 are reserved
	 1111		PHYS_CLASS	Physical Entity classification: 0000 = unspecified 0001 = host 0010 = chpid 0011 = switch 0100 = control unit 0101 = device 0110 = ESCON Model 2 converter 0111 = ambiguous (link is static (no ND_ATT) and IODEF is ambiguous 1000 = CF internal path (only set for CUs) 1001-1111 are reserved
153	(99)	CHARACTER	2	STATE	State of the entity
		1...		LOGICAL	1=entity is logical
		.1..		P_CURR	1=entity is physically current
		..1.		P_HIST	1=entity is physical history
		...1		LOG_OTHER	1=logical by another interface
	 1...		P_OTHER_CURR	1=physical by another interface
	1..		P_OTHER_HIST	1=physical history by other interface
	1.		P_INDIRECT	1=(for CU EAM) - the EAM validity was derived from the attached (ND) interfaces from the control unit.. 0=(for CU EAM) - the EAM validity was obtained from the CU itself (can only be true for opened switches). 1=(for chp AEAM) - the attached ND for the entity being queried is history but we got the chpid's validity from the chpid's detached ND (which is always valid) so the AEAM is marked P_CURR for the (attached) chpid.. 0=(for chp AEAM) - that the attached ND and AEAM have the same validity.
	1		P_AMB	1=physical ambiguous configuration on some interface
		1...		LOG_AMB	1=logical ambiguous configuration on some interface
		.1..		CLASS_AMB	1=logical and physical classes are not compatible
		..11 1111		*	Reserved
155	(9B)	BITSTRING	1	*	Reserved

End of Mask

Extrapolated Entity Descriptions

QUERY ENTITY CHP

Offsets					
Dec	Hex	Type	Len	Name (Dim)	Description
156	(9C)	CHARACTER	36	OTHERS	
156	(9C)	CHARACTER	32	ND	Extrapolation ND This field is only valid when AEAM.P_OTHER or AEAM.P_OTHER_HIST are set (on). This ND can be expected to contain a value when either: <ul style="list-style-type: none"> • The PID and ND validities differ (and the validity of this better be the same as the PID...if there is a PID) • There is more than 1 physical (only) path to an attached entity and the path that is being queried is not the most valid path -- this ND should contain the identity of the more (most) valid (physical) path.
	111.		NDVALID	Indicates validity of this ND. This (NDVALID) is the only field that IHVQEAM (Set_Others) explicitly references. This substructure CANNOT be DCL'd LIKE CHSC_ND as that causes bytes to be skipped in (at least) QEC where OTHERS is %INCLUDEd (because CHSC_ND is DCL'd BDY(DWORD)).
		...1	1111	*	Not explicitly referenced
157	(9D)	CHARACTER	31	*	Rest of ND
188	(BC)	UNSIGNED	2	LOG	Extrapolated logical ID... <p>This is the lowest logically defined configuration number assigned to the entity. This field is only valid when AEAM.LOG_OTHER is set (on).</p> <p>BDY gets rid of warning message that this BDY is used</p>
190	(BE)	CHARACTER	2	*	Reserved
End of OTHERS					
192	(C0)	CHARACTER	24	RESPONDER	Responding host id
192	(C0)	CHARACTER	8	APPLNAMER	Applname
200	(C8)	CHARACTER	8	SYSPLXR	Sysplex name
208	(D0)	CHARACTER	8	SYSTEMR	System name
216	(D8)	UNSIGNED	4	RCODE	Row return/reason code
220	(DC)	CHARACTER	5	CHPDTYPE	CHPID type as 5-character string (padded with blanks if required)
225	(E1)	CHARACTER	1	*	Reserved
226	(E2)	CHARACTER	38	CHPIDINFO	Resource Information
226	(E2)	CHARACTER	32	IODF_DESC	HCD User description
	111.		CONFIG_STATE	Configure state of channel: <ul style="list-style-type: none"> '001'b = online '010'b = offline/standby '110'b = offline/reserved '000'b = reserved
		...1	1111	*	Reserved (round to byte)

QUERY ENTITY CHP

Offsets					
Dec	Hex	Type	Len	Name (Dim)	Description
259	(103)	CHARACTER	1	*	Reserved (round to even)
260	(104)	BITSTRING	4	ERROR_STATE	Availability information Last known state of this path from CHSC Store SCH Path Info. (error_state=0 -> no data avail)
260	(104)	BITSTRING	1	CHSC_LEVEL	Level (scope) of info: '00'x = no information available (I/O operations') '10'x = error affects entire chpid '20'x = error affects destination link '30'x = error affects logical path '40'x = error affects I/O on the logical path
261	(105)	BITSTRING	2	CHSC_CODE	Status code with modifier
261	(105)	BITSTRING	1	STATCODE	Status code
262	(106)	BITSTRING	1	MODCODE	Status modifier value

QUERY ENTITY CNTLUNIT

Purpose

Use the QUERY ENTITY CNTLUNIT command at the API to obtain data about the specified control unit (CU).

Syntax

▶▶—Query Entity CntlUnit—| Object_format |—| Scope |—| Options |————▶▶

Output

I/O operations returns output from a QUERY ENTITY CNTLUNIT command in the following format.

Offsets					
Dec	Hex	Type	Len	Name (Dim)	Description
0	(0)	STRUCTURE	*	QEU	
Header for all Query Entity output structures Size = 80 bytes. For details see section "Common Output Header" on page 140.					
80	(50)	CHARACTER	200	CUS (*)	Control unit descriptions
80	(50)	UNSIGNED	2	CU_NUMBER	Control unit number
82	(52)	CHARACTER	1	STATBITS	See below
		1... ..		VALID_DATA	1=this control unit is defined in the IOCDs
		.1.. ..		CU_IS_SWITCH	1=this control unit is a switch control unit.
		..1.		CU_IS_CF	1=control unit is a coupling facility
		...1 1111		*	Reserved
83	(53)	UNSIGNED	1	CUADD	(IOCP) logical address
Physical (neighbor "who am I") Data					
84	(54)	CHARACTER	32	PID	CU's DERIVED physical identity (same overlay as HOST_PID)

QUERY ENTITY CNTLUNIT

Offsets					
Dec	Hex	Type	Len	Name (Dim)	Description
116	(74)	CHARACTER	32	CU_PTOK	Physical Token - remaps the NED (when the CU_IS_CF bit is off) or is an ND (when the CU_IS_CF bit is on (=1'b)). See macro IXYLMG for definition of the ND when the CU is a coupling facility.
116	(74)	CHARACTER	32	NED	Node Element Descriptor - CU's physical ID read from the control unit when this CU is not a coupling facility
116	(74)	CHARACTER	32	ND	Node Descriptor -- CF's PTOK
		111.		ND_VALID	Validity bits for PTOK=ND: 000 = valid, current 001 = valid, not current 010 = not valid
		11..		NED_VALID	Validity bits for PTOK=NED: 00 = unused (not valid) 01,10 are reserved 11 = valid NED
					Note: The NED is NOT AVAILABLE in SA OS/390 for non-switch control units. For these CUs the NED is set to indicate that the NED is invalid.
148	(94)	CHARACTER	4	*	Reserved
Entity Attribute Mask					
152	(98)	BITSTRING	4	EAM	
		1111		LOG_CLASS	Logical Entity classification: 0000 = unspecified 0001 = host 0010 = chpid 0011 = switch 0100 = control unit 0101 = device 0110 = reserved 0111 = ambiguous (CHCU, etc) 1000-1111 are reserved
	 1111		PHYS_CLASS	Physical Entity classification: 0000 = unspecified 0001 = host 0010 = chpid 0011 = switch 0100 = control unit 0101 = device 0110 = ESCON Model 2 converter 0111 = ambiguous (link is static (no ND_ATT) and IODEF is ambiguous 1000 = CF internal path (only set for CUs) 1001-1111 are reserved
153	(99)	CHARACTER	2	STATE	State of the entity
		1...		LOGICAL	1=entity is logical
		.1..		P_CURR	1=entity is physically current
		..1.		P_HIST	1=entity is physical history
		...1		LOG_OTHER	1=logical by another interface
	 1...		P_OTHER_CURR	1=physical by another interface
	1..		P_OTHER_HIST	1=physical history by other interface

QUERY ENTITY CNTLUNIT

Offsets					
Dec	Hex	Type	Len	Name (Dim)	Description
1.		P_INDIRECT	1=(for CU EAM) - the EAM validity was derived from the attached (ND) interfaces from the control unit. 0=(for CU EAM) - the EAM validity was obtained from the CU itself (can only be true for opened switches) 1=(for chp AEAM) - the attached ND for the entity being queried is history but we got the chpid's validity from the chpid's detached ND (which is always valid) so the AEAM is marked P_CURR for the (attached) chpid. 0=(for chp AEAM) - that the attached ND and AEAM have the same validity.
1		P_AMB	1=physical ambiguous configuration on some interface
	1...		LOG_AMB	1=logical ambiguous configuration on some interface
	.1..		CLASS_AMB	1=logical and physical classes are not compatible
	..11	1111		*	Reserved
155	(9B)	BITSTRING	1	*	Reserved
End of Mask					
156	(9C)	CHARACTER	48	IODFDATA	Information from HCD
156	(9C)	UNSIGNED	4	GROUP	Group class (encoded field) 6 DASD BIT, 1=DASD CU 6 TAPE BIT, 2=Tape CU 6 CLUSCNTL BIT, 3=Cluster controller 6 TELECOMM BIT, 4=Telecommunications CU 6 MICR BIT, 5=MICR/OCR CU 6 GRAF BIT, 6=Graphics systems CU 6 UNITREC BIT, 7=Unit record device 6 OTHR BIT, 255=other CU type
160	(A0)	CHARACTER	8	UNIT	Control Unit Type
168	(A8)	CHARACTER	4	MODEL	Control Unit Model
172	(AC)	CHARACTER	32	DESCRIPTION	HCD user description of this object
204	(CC)	BITSTRING	1	SCPSTATE	For Coupling Facility only
		1... ..		CONNECTED	1=MVS allows operations
		.1.. ..		MANAGED	1=MVS policy exists
		..1.		AVAILABLE	1=physical path exists
		...1		UNAVAILABLE	1=no physical path
205	(CD)	CHARACTER	3	*	Reserved
208	(D0)	CHARACTER	8	CFNAME	Coupling Facility name
216	(D8)	CHARACTER	32	CU_LTOK	Logical token (is binary zeros when not available)
End of include					
29 statements replaced by above include...					
248	(F8)	CHARACTER	24	RESPONDER	Responding host id
248	(F8)	CHARACTER	8	APPLNAMER	Applname
256	(100)	CHARACTER	8	SYSPLXR	Sysplex name
264	(108)	CHARACTER	8	SYSTEMR	System name
272	(110)	UNSIGNED	4	RCODE	Row return/reason code
276	(114)	CHARACTER	4	*	Reserved

QUERY ENTITY DEV

Purpose

Use the QUERY ENTITY DEV command at the API to obtain data about the specified device.

Syntax

►►—Query Entity Dev—| Object_format |—| Scope |—| Options |—►►

Output

The format of the output from QUERY ENTITY DEV is as follows:

Offsets					
Dec	Hex	Type	Len	Name (Dim)	Description
0	(0)	STRUCTURE	*	QED	
Header for all Query Entity output structures					
Size = 80 bytes. For details see section "Common Output Header" on page 140					
Max number of DEVs is calculated by QAGE					
80	(50)	CHARACTER	184	DEVS (*)	Individual device data
80	(50)	UNSIGNED	2	DEV_NUMBER	Device number
82	(52)	CHARACTER	1	STATBITS	See below
	1...		VALID_DATA	1=this device is defined
	.1..		DEV_IS_SWITCH	1=this device is a switch
	..1.		DEV_IS_CF	1=this device is a coupling facility
	...1		SELF_DESCR	1=this device supports self-description
	1111		*	Reserved
Entity Attribute Mask					
83	(53)	BITSTRING	4	EAM	
	1111		LOG_CLASS	Logical Entity classification: 0000 = unspecified 0001 = host 0010 = chpid 0011 = switch 0100 = control unit 0101 = device 0110 = reserved 0111 = ambiguous (CHCU, etc) 1000-1111 are reserved

QUERY ENTITY DEV

Offsets			Len	Name (Dim)	Description
Dec	Hex	Type			
	 1111		PHYS_CLASS	Physical Entity classification: 0000 = unspecified 0001 = host 0010 = chpid 0011 = switch 0100 = control unit 0101 = device 0110 = ESCON Model 2 converter 0111 = ambiguous (link is static (no ND_ATT) and IODEF is ambiguous 1000 = CF internal path (only set for CUs) 1001-1111 are reserved
84	(54)	CHARACTER	2	STATE	State of the entity
		1...		LOGICAL	1=entity is logical
		.1..		P_CURR	1=entity is physically current
		..1.		P_HIST	1=entity is physical history
		...1		LOG_OTHER	1=logical by another interface
	 1...		P_OTHER_CURR	1=physical by another interface
	1..		P_OTHER_HIST	1=physical history by other interface
	1.		P_INDIRECT	1=(for CU EAM) - the EAM validity was derived from the attached (ND) interfaces from the control unit. 0=(for CU EAM) - the EAM validity was obtained from the CU itself (can only be true for opened switches) 1=(for chp AEAM) - the attached ND for the entity being queried is history but we got the chpid's validity from the chpid's detached ND (which is always valid) so the AEAM is marked P_CURR for the (attached) chpid. 0=(for chp AEAM) - that the attached ND and AEAM have the same validity.
	1		P_AMB	1=physical ambiguous configuration on some interface
		1...		LOG_AMB	1=logical ambiguous configuration on some interface
		.1..		CLASS_AMB	1=logical and physical classes are not compatible.
		..11 1111		*	Reserved
86	(56)	BITSTRING	1	*	Reserved
End of Mask					
87	(57)	CHARACTER	20	*	Reserved
107	(6B)	CHARACTER	24	RESPONDER	Responding host id

Offsets			Len	Name (Dim)	Description
107	(6B)	CHARACTER	8	APPLNAMER	Applname
115	(73)	CHARACTER	8	SYSPLXR	Sysplex name
123	(7B)	CHARACTER	8	SYSTEMR	System name
131	(83)	CHARACTER	1	*	Reserved (for WORD boundary)
132	(84)	UNSIGNED	4	RCODE	Row return/reason code
136	(88)	CHARACTER	32	DEV_PTOK	Physical Token
136	(88)	CHARACTER	32	NED	Node Element Descriptor
168	(A8)	CHARACTER	6	VOLSER	Volume serial ID (DASD only, device NED indicates device type).
174	(AE)	CHARACTER	2	*	Reserved
Declare substructure					
176	(B0)	BITSTRING	4	SCPSTATE	Operating system state eliminate compiler messages
		1...		BOXED	1=Boxed
		.1..		NOTREADY	1=Not ready
		..1.		BUSY	1=Busy
		...1		RESERVED	1=Reserved
	 1...		ALLOCATED	1=Allocated
	1..		ONLINE	1=Online
	1.		UNLOAD	1=Unload pending
	1		MOUNT	1=Mount pending
		1...		RESPENDING	1=Reserve pending
		.1..		PENDING	1=Pending offline
		..1.		OFFALLOC	1=Offline -- allocated to SCP
		...1		OFFESCM	1=Offline due to I/O operations
	 1...		OFFCUIR	1=Offline due to CUIR
	1..		OFFTAPE	1=Offline due to tape
	1.		OFFHIERCH	1=Offline due to hierarchy reason
	1		OFFOPER	1=Offline due to operator
		1...		OFFLINE	1=Offline
		.1..		INUSE	1=Device is in use (message device only)
		..1.		OPERATIONAL	1=Device is operational (message device only)
		...1		NOTOP	1=Device is not operational (message device only)
	 1...		AUTOSW	1=Device is set autoswitch
End of include					
180	(B4)	CHARACTER	48	IODFDATA	HCD information

QUERY ENTITY DEV

Offsets					
Dec	Hex	Type	Len	Name (Dim)	Description
180	(B4)	UNSIGNED	4	GROUP	Generic type encode: 1 = DASD 2 = Tape 3 = Cluster controller 4 = Communications controller 5 = MICR/OCR 6 = Graphics 7 = Printer 8 = Card reader/punch 9 = Display 10 = Term printer 255 = other
184	(B8)	CHARACTER	8	UNIT	Unit
192	(C0)	CHARACTER	4	MODEL	Model
196	(C4)	CHARACTER	32	DESCRIPTION	HCD user description data
228	(E4)	CHARACTER	32	DEV_LTOK	Logical token (is binary zeros when not available)
260	(104)	CHARACTER	4	*	Reserved

QUERY ENTITY HOST

Purpose

Use the QUERY ENTITY HOST command at the API to obtain data about one or more SA OS/390 base programs (hosts) that are known to the issuing SA OS/390 (primary host).

Syntax

►► Query Entity Host | Object_format | Scope | Options | ◀◀

Object_format:

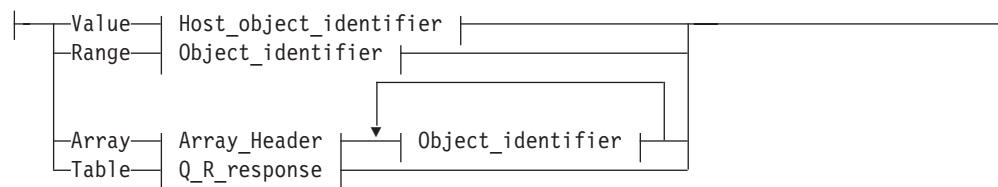

Object_identifier:

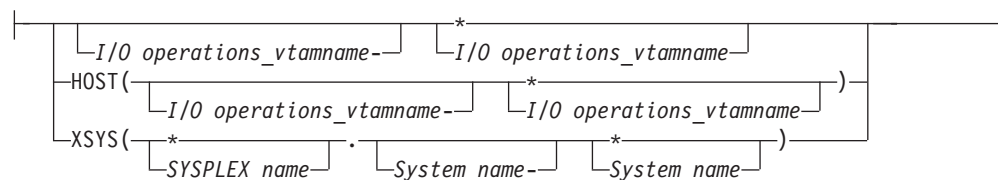

QUERY ENTITY HOST

Table 12. Standard SA OS/390 Array Format for QUERY ENTITY HOST. This format is the same as the ESCON Manager Release 3 array format.

Offsets					
Dec	Hex	Type	Len	Name (Dim)	Description
0	(0)	BIT	1		1 = SA OS/390 formatted array
0	(0)	UNSIGNED	4		Number of elements
4	(4)	UNSIGNED	1		Format ID. Only 0 is valid for SA OS/390 array
5	(5)	CHARACTER	3		Reserved
Array elements					
8	(8)	CHARACTER	38		Object identifier

Table *hex_query_relation_table_format*

Specify T or TABLE. Requires CODE=1 and the RESPONDER host application name must match the scope host name to be operated on.

SCOPE

Set of I/O operations hosts. Refer to page 139 for further details.

A host identifier type can be one of the following keywords:

HOST

VTAM application name. Refer to page 139 for further details.

XSYS

Sysplex and/or system name. Refer to page 139 for further details.

Notes:

1. When ARRAY is the *Object_format_type*, the *Object_Identifier_Types* can be mixed and every *Object_Identifier_Type* must match the class of the specified *Object_Type* (all must be I/O_resources or all must be Hosts). For example, Q E HOST can take only HOST and XSYS entries in the array.
2. The Array_header contains the number of elements in the array.
3. When ARRAY is the *SCOPE_format_type*, the *Host_Object_Identifier_Types* can be mixed (HOST and XSYS).

Output

Output from a QUERY ENTITY command consists of a header, which is identical for each entity with the exception of the "Eye-Catcher" (offset 0), followed by the substructures, which are unique to each type of entity.

I/O operations returns output in response to the QUERY ENTITY HOST command in the following format.

Offsets					
Dec	Hex	Type	Len	Name (Dim)	Description
0	(0)	STRUCTURE	*	QEH	
Header for all Query Entity output structures Size = 80 bytes					
0	(0)	CHARACTER	80	HDR	
0	(0)	CHARACTER	4	EYE_CATCHER	Identifies CB (For example, 'QEH')
4	(4)	UNSIGNED	2	HDR_SIZE	Size of this header substructure
6	(6)	UNSIGNED	2	ROW_SIZE	Size of array element for this substructure
8	(8)	CHARACTER	8	ESCM_HOST	Responding host VTAM application name
16	(10)	CHARACTER	4	ESCM_REL	I/O operations version/release

QUERY ENTITY HOST

Offsets					
Dec	Hex	Type	Len	Name (Dim)	Description
20	(14)	CHARACTER	32	HOST_PID	Host physical identifier
		111.		VALIDITY	0 = valid 1 = not current 2 = not valid
		...1 1111		*	Reserved
21	(15)	CHARACTER	3	*	Reserved
24	(18)	CHARACTER	6	TYPE_NUM	For example, 3090EX
30	(1E)	CHARACTER	3	MODEL_NUM	For example, 60A
33	(21)	CHARACTER	3	MFR	For example, IBM
36	(24)	CHARACTER	2	PLANT	Where manufactured
38	(26)	CHARACTER	12	SEQUENCE_NUM	(1990) first 7 bytes are 0, last 5 bytes are serial number
50	(32)	CHARACTER	2	STATUS	Status of PID
		1...		AMBIGUOUS	Ambiguous state detected on PID
		.1..		REFLECTED	1=PID is derived from attached ND
50	(32)	BITSTRING	1	*	Reserved
52	(34)	UNSIGNED	4	NUM_ROWS	Dimension of array below
56	(38)	UNSIGNED	1	FORMAT_ID	Identifies format of data
		1...		MORE_DATA	0=all data that satisfies query is returned here. 1=more data satisfies query (but won't fit now). Ask again with RANGE parameter type.
		.111 1111		*	Reserved
58	(3A)	CHARACTER	8	PLEX_NAME	Sysplex name (blank if none)
66	(42)	CHARACTER	8	SYST_NAME	System name
74	(4A)	CHARACTER	2	*	Reserved
76	(4C)	UNSIGNED	4	NUM_HOSTS	Number of hosts responding
End of HDR					
80	(50)	CHARACTER	180	HOSTS (*)	Indexed by QEH.HDR.NUM_ROWS
80	(50)	CHARACTER	8	APPL_NAME	VTAM application name
88	(58)	CHARACTER	1	STATBITS	See below
		1...		VALID_DATA	1=this host is known
		.1..		HOST_OFF	1=this host is reset off
		..1.		IN_SESSION	For primary host only; 1=I/O operations/VTAM communication ok 0=no I/O operations/VTAM communication. For secondary hosts only: 1=appl-to-appl session ok 0=no session setup
		...1		BACKING_OUT	1=backout in progress 0=no backout processing
	 1111		*	Reserved
89	(59)	CHARACTER	4	VER_REL	I/O operations version/release on this host
93	(5D)	CHARACTER	32	PID	This host PID (same format as HOST_PID above)
Entity Attribute Mask					
125	(7D)	BITSTRING	4	EAM	
		1111		LOG_CLASS	Logical Entity classification: 0000 = unspecified 0001 = host 0010 = chpid 0011 = switch 0100 = control unit 0101 = device 0110 = reserved 0111 = ambiguous (CHCU, etc) 1000-1111 are reserved

QUERY ENTITY HOST

Offsets			Len	Name (Dim)	Description
Dec	Hex	Type			
	 1111		PHYS_CLASS	Physical Entity classification: 0000 = unspecified 0001 = host 0010 = chpid 0011 = switch 0100 = control unit 0101 = device 0110 = I/O operations Model 2 converter 0111 = ambiguous (link is static (no ND_ATT) and IODEF is ambiguous 1000 = CF internal path (only set for CUs) 1001-1111 are reserved
126	(7E)	CHARACTER	2	STATE	State of the entity
		1...		LOGICAL	1=entity is logical
		.1..		P_CURR	1=entity is physically current
		..1.		P_HIST	1=entity is physical history
		...1		LOG_OTHER	1=logical by another interface
	 1...		P_OTHER_CURR	1=physical by another interface
	1..		P_OTHER_HIST	1=physical history by other interface
	1.		P_INDIRECT	1=(for CU EAM) - the EAM validity was derived from the attached (ND) interfaces from the control unit. 0=(for CU EAM) - the EAM validity was obtained from the CU itself (can only be true for opened switches) 1=(for chp AEAM) - the attached ND for the entity being queried is history but we got the chpid's validity from the chpid's detached ND (which is always valid) so the AEAM is marked P_CURR for the (attached) chpid. 0=(for chp AEAM) - that the attached ND and AEAM have the same validity.
	1		P_AMB	1=physical ambiguous configuration on some interface.
		1...		LOG_AMB	1=logical ambiguous configuration on some interface.
		.1..		CLASS_AMB	1=logical and physical classes are not compatible.
		..11 1111		*	Reserved
128	(80)	BITSTRING	1	*	Reserved
End of Mask					
129	(81)	CHARACTER	8	SYSPLEX	Sysplex name (blank if none)
137	(89)	CHARACTER	8	SYSTEM	System name
145	(91)	CHARACTER	24	RESPONDER	Responding host id
145	(91)	CHARACTER	8	APPLNAMER	Applname
153	(99)	CHARACTER	8	SYSPLEXR	Sysplex name
161	(A1)	CHARACTER	8	SYSTEMR	System name
169	(A9)	CHARACTER	3	*	Reserved
172	(AC)	UNSIGNED	4	RCODE	Row return/reason code
176	(B0)	CHARACTER	64	HCD_DATA	Obtained from HCD HOM program
176	(B0)	CHARACTER	44	IODF_DSN	HCD IODF dataset name
220	(DC)	UNSIGNED	4	IODFACT	Hardware and software (CSS/IODF) synch status. Possible values: 1 = hardware and software of the active IODF are in sync. 2 = hardware and software are out of sync. 3 = No valid hardware token exists.

QUERY ENTITY HOST

Offsets			Len	Name (Dim)	Description
Dec	Hex	Type			
224	(E0)	CHARACTER	16	IODFNAME	World-wide unique name of the active configuration
240	(F0)	CHARACTER	16	LOCKOWNER	Process lock owner. This field is only valid when this host is the same as the responding host. For other hosts, this field will be blank.
240	(F0)	CHARACTER	8	SYSTEML	Applname of user holding process lock
248	(F8)	CHARACTER	8	USER	Userid of lock owner
256	(100)	BITSTRING	1	R3_FNS	Additional functions installed beyond Release 3 of ESCON Manager
		1... ..		SPE1	'1'b = ESCON Director Model 3, byte converter, downlevel MVS, no switch dependency are supported. Other bits are reserved
257	(101)	CHARACTER	3	OSLEVEL	Operating system
257	(101)	CHARACTER	1	NAME	'M'=MVS, 'V'=VM
258	(102)	CHARACTER	1	VERSION	Decimal 0-9
259	(103)	CHARACTER	1	RELEASE	Decimal 0-9
260	(104)	CHARACTER	8	CPUID	Processor ID
268	(10C)	UNSIGNED	2	CPU_ADDRESS	Processor address
270	(10E)	CHARACTER	2	*	RESERVED
272	(110)	CHARACTER	8	RODM_DB_NAME	Name of RODM used for config. information
276	(114)	CHARACTER	8	RODM_NAME	RODM name
280	(118)	CHARACTER	8	DOMAIN_NAME	NetView domain name for this host
284	(11C)	CHARACTER	8	DOMAIN_NAME	Domain name

QUERY ENTITY SWITCH

Purpose

Use the QUERY ENTITY SWITCH command at the API to obtain data about the specified switch.

Syntax

►►—Query Entity Switch—| Object_format |—| Scope |—| Options |—►►

Output

I/O operations returns output from the QUERY ENTITY SWITCH command in the following format:

Offsets			Len	Name (Dim)	Description
Dec	Hex	Type			
0	(0)	STRUCTURE	*	QES	
Header for all Query Entity output structures					
Size = 80 bytes. For details see section "Common Output Header" on page 140.					
80	(50)	CHARACTER	192	SWITCHES (*)	Individual switch data
80	(50)	UNSIGNED	2	SW_DEVN	Switch device number
82	(52)	CHARACTER	1	STATBITS	See below

QUERY ENTITY SWITCH

Offsets			Len	Name (Dim)	Description
Dec	Hex	Type			
		1... ..		VALID_DATA	'1'=this switch is in database
		.1.. ..		VALID_SWDEVN	'1'=switch device number is valid
		..1.		*	Reserved
		...1		OPEN	1=switch is opened (by I/O operations)
	 1111		*	Reserved
83	(53)	UNSIGNED	1	LSN	Logical switch number
84	(54)	CHARACTER	32	SW_PTOK	Physical Token
84	(54)	CHARACTER	32	NED	Node Element Descriptor
116	(74)	CHARACTER	32	PID	Unique (physical) ID -- same format as HOST_PID
148	(94)	UNSIGNED	1	NPINST	Number of installed ports (cards installed)
149	(95)	UNSIGNED	1	NPIM	Number of implemented ports (ports able to be installed)
150	(96)	UNSIGNED	1	OP_STATUS	Operational status where: '00'x = unspecified '01'x = not open '02'x = in contention '03'x = hardware error '04'x = system error '05'x = i/o error '06'x = operational '07'x = reserved '08'x = read only (HCP set) '09'x-'FF'x = reserved
151	(97)	UNSIGNED	1	A_CUP	CUP port address
152	(98)	UNSIGNED	4	STATUS_CODE	Error code (if any)
Entity Attribute Mask					
156	(9C)	BITSTRING	4	EAM	
		1111		LOG_CLASS	Logical entity classification: 0000 = unspecified 0001 = host 0010 = chpid 0011 = switch 0100 = control unit 0101 = device 0110 = reserved 0111 = ambiguous (CHCU, etc) 1000-1111 are reserved
	 1111		PHYS_CLASS	Physical entity classification: 0000 = unspecified 0001 = host 0010 = chpid 0011 = switch 0100 = control unit 0101 = device 0110 = ESCON Model 2 converter 0111 = ambiguous (link is static (no ND_ATT) and IODEF is ambiguous 1000 = CF internal path (only set for CUs) 1001-1111 are reserved
157	(9D)	CHARACTER	2	STATE	State of the entity
		1... ..		LOGICAL	1=entity is logical
		.1.. ..		P_CURR	1=entity is physically current
		..1.		P_HIST	1=entity is physical history
		...1		LOG_OTHER	1=logical by another interface
	 1...		P_OTHER_CURR	1=physical by another interface
	1..		P_OTHER_HIST	1=physical history by other interface

QUERY ENTITY SWITCH

Offsets					
Dec	Hex	Type	Len	Name (Dim)	Description
	1.		P_INDIRECT	1=(for CU EAM) - the EAM validity was derived from the attached (ND) interfaces from the control unit. 0=(for CU EAM) - the EAM validity was obtained from the CU itself (can only be true for opened switches) 1=(for chpid AEAM) - the attached ND for the entity being queried is history but we got the chpid's validity from the chpid's detached ND (which is always valid) so the AEAM is marked P_CURR for the (attached) chpid. 0=(for chpid AEAM) - that the attached ND and AEAM have the same validity.
	1		P_AMB	1=physical ambiguous configuration on some interface
		1...		LOG_AMB	1=logical ambiguous configuration on some interface
		.1..		CLASS_AMB	1=logical and physical classes are not compatible.
		..11 1111		*	Reserved
159	(9F)	BITSTRING	1	*	Reserved
End of Mask					
160	(A0)	CHARACTER	32	IODFDESC	HCD's user description of this object
192	(C0)	CHARACTER	7	ECLEVEL	Hardware EC level
199	(C7)	UNSIGNED	1	LOWPORT	Lowest port address on this switch
Declare substructure					
200	(C8)	BITSTRING	4	SCPSTATE	Operating system state eliminate compiler messages
		1...		BOXED	1=Boxed
		.1..		NOTREADY	1=Not ready
		..1.		BUSY	1=Busy
		...1		RESERVED	1=Reserved
	 1...		ALLOCATED	1=Allocated
	1..		ONLINE	1=Online
	1.		UNLOAD	1=Unload pending
	1		MOUNT	1=Mount pending
		1...		RESPENDING	1=Reserve pending
		.1..		PENDING	1=Pending offline
		..1.		OFFALLOC	1=Offline -- allocated to SCP
		...1		OFFESCM	1=Offline due to I/O operations
	 1...		OFFCUIR	1=Offline due to CUIR
	1..		OFFTAPE	1=Offline due to tape
	1.		OFFHIERCH	1=Offline due to hierarchy reason
	1		OFFOPER	1=Offline due to operator
		1...		OFFLINE	1=Offline
		.1..		INUSE	1=Device is in use (message device only)
		..1.		OPERATIONAL	1=Device is operational (message device only)

QUERY ENTITY SWITCH

Offsets					
Dec	Hex	Type	Len	Name (Dim)	Description
	...1		NOTOP	1=Device is not operational (message device only)
	1...		AUTOSW	1=Device is set autoswitch
End of include					
204	(CC)	CHARACTER	32	SW_LTOK	Logical Token (inherited from CU for this switch - is binary zeros when not available.
End of include					
35 records replaced by above include					
236	(EC)	CHARACTER	24	RESPONDER	Responding host id
236	(EC)	CHARACTER	8	APPLNAMER	Applname
244	(F4)	CHARACTER	8	SYSPLXR	Sysplex name
252	(FC)	CHARACTER	8	SYSTEMR	System name
260	(104)	UNSIGNED	4	RCODE	Row return/reason code
264	(108)	CHARACTER	8	*	Reserved

QUERY FILE

Purpose

Use the QUERY FILE command at the API to retrieve either a single saved switch configuration or a list of all the configurations saved at a switch returned to the caller in the IHVRESP or other user-designated response area. The switch must be allocated, or attached, to the issuing I/O operations.

Syntax

```

▶▶ Query File [ * | filename ] swchdevn ▶▶

```

Parameters

- * Specify * to get a list of the saved switch configurations that are stored at the specified switch.

filename

Specify a file name in 1 through 8 valid EBCDIC codes to obtain a single saved configuration. Valid codes are uppercase alphabetical characters (A–Z), digital characters (0–9), and 2 special characters: the underscore (_) and the hyphen (-). However, the following file names are not valid: AUX, COM n (where $n=1–4$), CON, LPT n (where $n=1–3$), NUL, or PRN.

swchdevn

Specify the switch device number in up to 4 hexadecimal digits. The switch must be allocated, or attached, to the issuing I/O operations. You can use the Display Switch command to obtain a list of these switches.

Usage

- A maximum number of saved configurations can be stored at a switch. At an IBM Director, you can store 15 saved switch configurations. In addition, the IPL

file can be loaded from, and restored at, the IBM Director. The IPL file is supplied with the unit and activated automatically when the Director is powered on.

- You can query the IPL file only if the Active=Save mode is disabled, which means when any changes being made to the active file are not being saved. (For the status of this mode, see the QFILAS field in the format of the output returned from Q F *)

Output

The format of the output from Q F *filename* is an array of 257 80-byte records. The data is returned in IHVRESP if the caller is a REXX EXEC and in a return area designated by the user if the caller is an assembler program.

- One 80-byte record is returned for each of the 256 ports that can be addressed. The format for these records is the same as listed under the usage notes in the QUERY SWITCH command.
- One 80-byte record is returned to identify the file in the following format:

Offsets					
Dec	Hex	Type	Len	Name (Dim)	Description
0	(0)	STRUCTURE	*		Query file list QFIL
0	(0)	CHARACTER	8	QFILHDR	8-byte Header Area
0	(0)	BITSTRING	2	QFILBITS	bits
		11..		QFILFORM	format bits 00 = original format
		..1.		QFILAS	active=saved 0 = active=saved is off 1 = active=saved in on
0	(0)	BITSTRING	1	QFILRSVD	reserved bits
2	(2)	UNSIGNED	1	QFIL_MAX_CONFS	maximum number of configs
3	(3)	UNSIGNED	1	QFIL_NUM_CONFS	current number of configs
4	(4)	CHARACTER	4	QFIL_RESERVED	reserved area
8	(8)	CHARACTER	48	QFILBODY (*)	48-byte Body for Each File
8	(8)	CHARACTER	8	QFILNAME	filename
16	(10)	BITSTRING	1	QFILFLAG1	flag byte
		1...		QFILSVDF	Saved file 0 = file not saved 1 = file is currently saved
		.1..		QFILOPNF	Open file 0 = file is not open 1 = file is currently open
		..1.		QFILLOCKF	Locked file 0 = file is not locked 1 = file is locked
		...1 1111		*	reserved
17	(11)	CHARACTER	7	*	reserved
24	(18)	CHARACTER	24	QFILDESC	file descriptor
48	(30)	CHARACTER	4	QFILDATE	date file was saved
48	(30)	UNSIGNED	1	QFILMON	month (1-12)
49	(31)	UNSIGNED	1	QFILDAY	day (1-31)
50	(32)	UNSIGNED	2	QFILYEAR	year (0000-9999)
52	(34)	CHARACTER	4	QFILTIME	time file was saved
52	(34)	UNSIGNED	1	QFILHOUR	hour (0-23)
53	(35)	UNSIGNED	1	QFILMIN	minute (0-59)
54	(36)	UNSIGNED	1	QFILSEC	second (0,2,4...58)
55	(37)	UNSIGNED	1	*	reserved
56	(38)	CHARACTER		QFILEND	end of QFIL

QUERY INTERFACE CNTLUNIT

Purpose

Use the QUERY INTERFACE CNTLUNIT command at the API to obtain data from the specified control unit regarding its interfaces.

Syntax

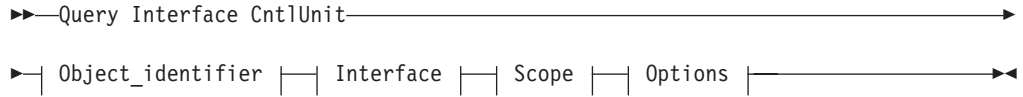

Object_identifier:

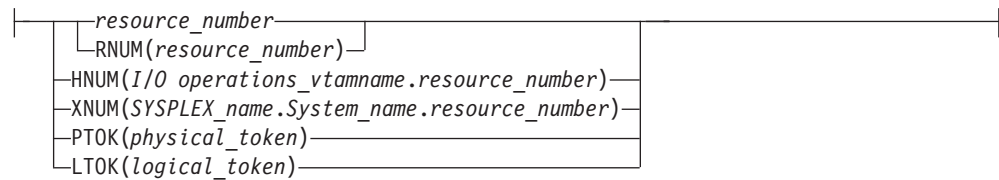

Interface:

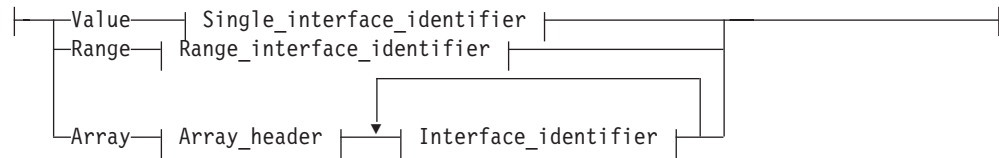

Single_interface_identifier:



Range_interface_identifier:

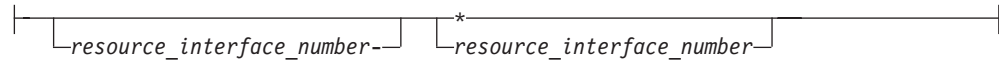

Scope:

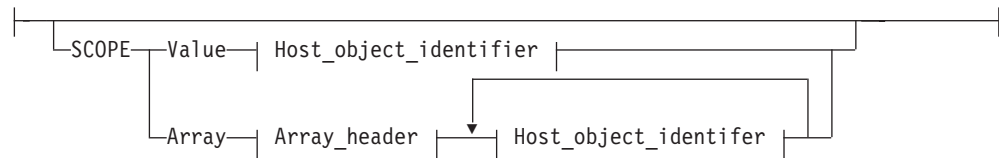

Host_object_identifier:

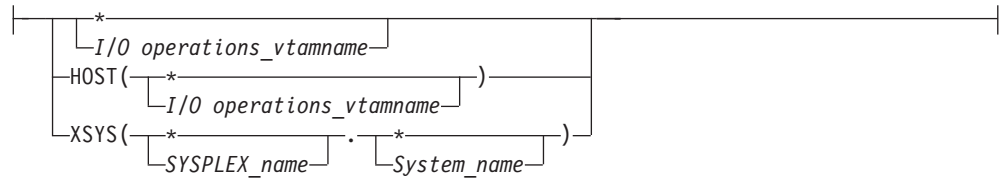

Parameters

The QUERY INTERFACE CONTROL UNIT command is designed to work only with ESCON control units because control unit interfaces are *physical* items and only ESCON control units support the architecture to return physical information. No IOCDS pathing information is used to obtain control unit interface responses unless a control specified is a coupling facility control unit. Only IOCDS pathing information is used to obtain the control unit interfaces.

The interface you specify in the command corresponds to the TAG (last 2 bytes, unsigned 2-byte value) field of the node descriptor (ND) associated with the control unit interface.

If the control unit you are querying is a dynamic switch, the interface you specify corresponds to the *port number* of the port that represents the interface.

- For *object_identifier*, specify the control unit number whose interfaces you want to query.
- For *interface_identifier*, specify a single physical interface for the specified control unit.
- Specify * if you want to receive data about all the physical interfaces for the specified control unit. Output array elements are sorted by the DTAG field.
For *Interface_identifier* with Range:
 - For *lower-upper*, specify an inclusive range of interfaces (or port numbers if the specified control unit is a switch control unit) on the specified control unit. Output array elements are sorted by the DTAG field.
 - Specify *lower-** if you want to receive data about the interfaces from the specified interface to (and including the highest interface. Output array elements are sorted by the DTAG field.

Output

The format of the output from the QUERY INTERFACE CONTROL UNIT command is as follows:

Offsets					
Dec	Hex	Type	Len	Name (Dim)	Description
Header for all Query Entity output structures					
Size = 80 bytes. for details see section "Common Output Header" on page 140..					
8	(8)	CHARACTER	8	ESCM_HOST	Responding host VTAM application name
80	(50)	CHARACTER	312	INTERFACES (*)	CU interface descriptions
		1...		VALID_DATA	1=this INTERFACES element valid
		.111 1111		*	Reserved
81	(51)	CHARACTER	7	*	Reserved
88	(58)	CHARACTER	32	ND_DET	Interface physical identity
88	(58)	CHARACTER	30	*	Node Params, Class..WWID
118	(76)	UNSIGNED	2	DTAG	Det. ND Tag (interface) eliminates compiler message

QUERY INTERFACE CNTLUNIT

Offsets					
Dec	Hex	Type	Len	Name (Dim)	Description
120	(78)	CHARACTER	32	ND_ATT	Interface neighbor physical ID
120	(78)	CHARACTER	30	*	Node Params, Class...WWID
150	(96)	CHARACTER	2	ATAG	Attached ND Tag (interface)
Entity Attribute Mask					
152	(98)	BITSTRING	4	AEAM	
		1111		LOG_CLASS	Logical Entity classification: 0000 = unspecified 0001 = host 0010 = chpid 0011 = switch 0100 = control unit 0101 = device 0110 = reserved 0111 = ambiguous (CHCU, etc) 1000-1111 are reserved
	 1111		PHYS_CLASS	Physical Entity classification: 0000 = unspecified 0001 = host 0010 = chpid 0011 = switch 0100 = control unit 0101 = device 0110 = ESCON Model 2 converter 0111 = ambiguous (link is static (no ND_ATT) and IODEF is ambiguous 1000 = CF internal path (only set for CUs) 1001-1111 are reserved
153	(99)	CHARACTER	2	STATE	State of the entity
		1...		LOGICAL	1=entity is logical
		.1..		P_CURR	1=entity is physically current
		..1.		P_HIST	1=entity is physical history
		...1		LOG_OTHER	1=logical by another interface
	 1...		P_OTHER_CURR	1=physical by another interface
	1..		P_OTHER_HIST	1=physical history by other interface
	1.		P_INDIRECT	1=(for CU EAM) - the EAM validity was derived from the attached (ND) interfaces from the control unit. 0=(for CU EAM) - the EAM validity was obtained from the CU itself (can only be true for opened switches) 1=(for chp AEAM) - the attached ND for the entity being queried is history but we got the chpid's validity from the chpid's detached ND (which is always valid) so the AEAM is marked P_CURR for the (attached) chpid. 0=(for chp AEAM) - that the attached ND and AEAM have the same validity.
	1		P_AMB	1=physical ambiguous configuration on some interface
		1...		LOG_AMB	1=logical ambiguous configuration on some interface
		.1..		CLASS_AMB	1=logical and physical classes are not compatible
		..11 1111		*	Reserved
155	(9B)	BITSTRING	1	*	Reserved
End of Mask					
Extrapolated Entity Descriptions					
156	(9C)	CHARACTER	36	OTHERS	

QUERY INTERFACE CNTLUNIT

Offsets					
Dec	Hex	Type	Len	Name (Dim)	Description
156	(9C)	CHARACTER	32	ND	Extrapolation ND This field is only valid when AEAM.P_OTHER or AEAM.P_OTHER_HIST are set (on). This ND can be expected to contain a value when either: <ul style="list-style-type: none"> • The PID and ND validities differ (and the validity of this better be the same as the PID...if there is a PID) • There is more than 1 physical (only) path to an attached entity and the path that is being queried is not the most valid path -- this ND should contain the identity of the more (most) valid (physical) path.
		111.		NDVALID	Indicates validity of this ND. This (NDVALID) is the only field that IHVQEAM (Set_Others) explicitly references. This substructure CANNOT be DCL'd LIKE CHSC_ND as that causes bytes to be skipped in (at least) QEC where OTHERS is %INCLUDEd (because CHSC_ND is DCL'd BDY(DWORD)).
		...1 1111	*		Not explicitly referenced
157	(9D)	CHARACTER	31	*	Rest of ND
188	(BC)	UNSIGNED	2	LOG	Extrapolated logical ID. This is the lowest logically defined configuration number assigned to the entity. This field is only valid when AEAM.LOG_OTHER is set (on). BDY gets rid of warning message that this BDY is used.
190	(BE)	CHARACTER	2	*	Reserved
End of OTHERS					
192	(C0)	CHARACTER	24	RESPONDER	Responding host id
192	(C0)	CHARACTER	8	APPLNAMER	Applname
200	(C8)	CHARACTER	8	SYSPLEXR	Sysplex name
208	(D0)	CHARACTER	8	SYSTEMR	System name
216	(D8)	UNSIGNED	4	RCODE	Row return/reason code
Entity1 Control Unit description					
220	(DC)	CHARACTER	168	CU	Level number was 2
220	(DC)	UNSIGNED	2	CU_NUMBER	Control unit number
222	(DE)	CHARACTER	1	STATBITS	See below
		1...	*		1=this control unit is defined in the IOCDS
		.1..		CU_IS_SWITCH	1=this control unit is a switch control unit.
		..1.		CU_IS_CF	1=CU is a coupling facility
		...1 1111	*		Reserved
223	(DF)	UNSIGNED	1	CUADD	(IOCP) logical address
Physical (neighbor "who am I") Data...					
224	(E0)	CHARACTER	32	PID	CU's DERIVED physical identity (same overlay as HOST_PID)

QUERY INTERFACE CNTLUNIT

Offsets					
Dec	Hex	Type	Len	Name (Dim)	Description
256	(100)	CHARACTER	32	CU_PTOK	Physical Token - remaps the NED (when the CU_IS_CF bit is off) or is an ND (when the CU_IS_CF bit is on (= '1'b)). See macro IXYLMG for definition of the ND when the CU is a coupling facility.
256	(100)	CHARACTER	32	NED	Node Element Descriptor - CU's physical ID read from the control unit when this CU is not a coupling facility
256	(100)	CHARACTER	32	ND	Node Descriptor - CF's PTOK
		111.		ND_VALID	Validity bits for PTOK=ND: 000 = valid, current 001 = valid, not current 010 = not valid
		11..		NED_VALID	Validity bits for PTOK=NED: 00 = unused (not valid) 01,10 are reserved 11 = valid NED
288	(120)	CHARACTER	4	*	Reserved
Entity Attribute Mask					
292	(124)	BITSTRING	4	EAM	
		1111		LOG_CLASS	Logical Entity classification: 0000 = unspecified 0001 = host 0010 = chpid 0011 = switch 0100 = control unit 0101 = device 0110 = reserved 0111 = ambiguous (CHCU, etc) 1000-1111 are reserved
	 1111		PHYS_CLASS	Physical Entity classification: 0000 = unspecified 0001 = host 0010 = chpid 0011 = switch 0100 = control unit 0101 = device 0110 = ESCON Model 2 converter 0111 = ambiguous (link is static (no ND_ATT) and IODEF is ambiguous 1000 = CF internal path (only set for CUs) 1001-1111 are reserved
293	(125)	CHARACTER	2	STATE	State of the entity
		1...		LOGICAL	1=entity is logical
		.1..		P_CURR	1=entity is physically current
		..1.		P_HIST	1=entity is physical history
		...1		LOG_OTHER	1=logical by another interface
	 1...		P_OTHER_CURR	1=physical by another interface
	1..		P_OTHER_HIST	1=physical history by other interface

QUERY INTERFACE CNTLUNIT

Offsets					
Dec	Hex	Type	Len	Name (Dim)	Description
	1.		P_INDIRECT	1=(for CU EAM) - the EAM validity was derived from the attached (ND) interfaces from the control unit. 0=(for CU EAM) - the EAM validity was obtained from the CU itself (can only be true for opened switches) 1=(for chp AEAM) - the attached ND for the entity being queried is history but we got the chpid's validity from the chpid's detached ND (which is always valid) so the AEAM is marked P_CURR for the (attached) chpid. 0=(for chp AEAM) - that the attached ND and AEAM have the same validity.
	1		P_AMB	1=physical ambiguous config on some interface
		1...		LOG_AMB	1=logical ambiguous configuration on some interface
		.1..		CLASS_AMB	1=logical and physical classes are not compatible.
		..11 1111		*	Reserved
295	(127)	BITSTRING	1	*	Reserved
End of Mask					
296	(128)	CHARACTER	48	IODFDATA	Information from HCD
296	(128)	UNSIGNED	4	GROUP	Group class (encoded field) 6 DASD BIT, 1=DASD CU 6 TAPE BIT, 2=Tape CU 6 CLUSCNTL BIT, 3=Cluster controller 6 TELECOMM BIT, 4=Telecommunications CU 6 MICR BIT, 5=MICR/OCR CU 6 GRAF BIT, 6=Graphics systems CU 6 UNITREC BIT, 7=Unit record device 6 OTHR BIT, 255=other CU type
300	(12C)	CHARACTER	8	UNIT	Control Unit Type
308	(134)	CHARACTER	4	MODEL	Control Unit Model
312	(138)	CHARACTER	32	DESCRIPTION	HCD user description of this object
344	(158)	BITSTRING	1	SCPSTATE	For Coupling Facility only
		1...		CONNECTED	1=MVS allows operations
		.1..		MANAGED	1=MVS policy exists
		..1.		AVAILABLE	1=physical path exists
		...1		UNAVAILABLE	1=no physical path
345	(159)	CHARACTER	3	*	Reserved
348	(15C)	CHARACTER	8	CFNAME	Coupling Facility name
356	(164)	CHARACTER	32	CU_LTOK	Logical token (is binary zeros when not available)
Replaced 29 records with the above include					
388	(184)	CHARACTER	4	*	Reserved

QUERY INTERFACE SWITCH

Purpose

Use the QUERY INTERFACE SWITCH command at the API to obtain data about the specified switch regarding its ports.

Syntax

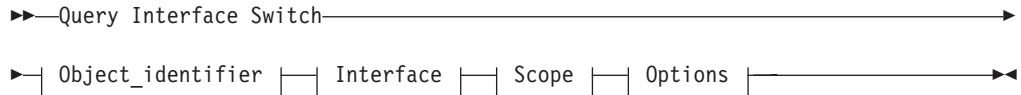

Object_identifier:

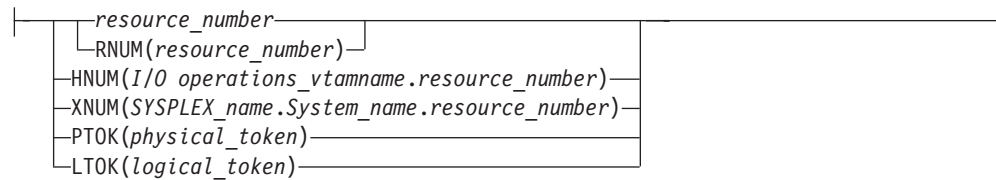

Interface:

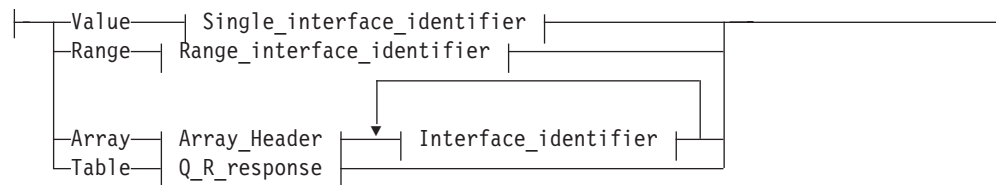

Single_interface_identifier:



Range_interface_identifier:

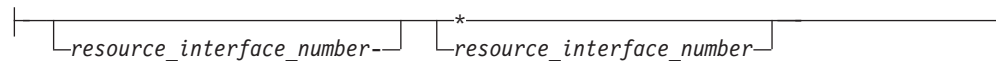

Scope:

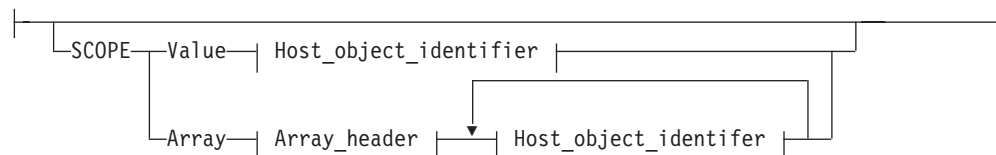

Host_object_identifier:

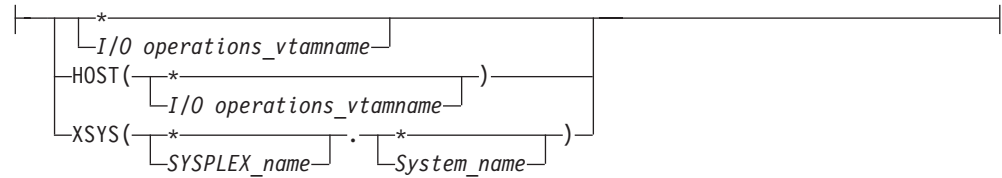

Parameters

- For *object_identifier*, specify the switch device number that you want to receive data about.
- For *interface_identifier* or *, a single addressable port on the switch or * for all the addressable ports on the specified switch. Output array elements are sorted by port address. **Do not enclose the port address in parentheses for this command.**
For *Interface_identifier* with Range:
 - For *lower-upper*, specify an inclusive range of port addresses on the specified switch. Output array elements are sorted by port address.
 - Specify *lower-**, if you want to receive data on port addresses, starting with the specified address * to the highest implemented port address on the specified switch.
- When the CODE value in a row is set to 1, the PORTIN and PORTOUT columns of the table are queried.

Output

The format of the output from the QUERY INTERFACE SWITCH command is as follows:

Offsets					
Dec	Hex	Type	Len	Name (Dim)	Description
Port Descriptions					
80	(50)	CHARACTER	360	PORTS (*)	Indexed by HDR.NUM_ROWS (above)
80	(50)	UNSIGNED	1	PORT_NUMBER	Port Number
81	(51)	UNSIGNED	1	PORT_ADDRESS	Port Address (interface value)
82	(52)	1... ..		VALID_DATA	1=this PORTS element contains valid data.
		.1..		MID_PORT	1=this port is midport in chain
		..1.		CHAINED	1=this port is chained
		...11....		DCM_STATE	10=this port is DCM eligible but not allowed for DCM activities 11=this port is DCM eligible but not allowed for DCM activities 0x=this port is DCM ineligible
	 1...		DCM_ALLOWED	1=this port is currently allowed for DCM activities
	111		*	Reserved
83	(53)	CHARACTER	37	PIB	Port Information Block
83	(53)	CHARACTER	4	PDB	Port Descriptor Bits
		1...		UNIMPLEMENTED	1 = unimplemented port
		.1..		BLOCKED	1 = port is blocked

QUERY INTERFACE SWITCH

Offsets					
Dec	Hex	Type	Len	Name (Dim)	Description
		..1.		SOME_PDCM_BIT_SET1	= at least 1 prohibit
		...1		STATIC	1 = this port has static connection
	 1...		*	Reserved
	111		PORT_TECH	Indicates technology of port hardware: '000' = either port not installed or technology is unknown '001' = this is an internal port '010' = reserved '011' = this port uses LED fiber '100' = this port uses LASER fiber technology 101-111 reserved
		1...		UNINSTALLED	1 = port is not installed
		.1..		LINK_FAIL	1 = Link failure (hardware fence)
		..1.		SPARE	1 = this is a spare port
		...1		OFFLINE	1 = offline (hardware fence)
	 1...		MAINT_MODE	1 = In diagnostic (maint) mode
	1..		CUP	1 = this port is a CUP
	1.		SERVICE	1 = Service required
	1		CFG_ERR	1 = Invalid (ND) attachment
85	(55)	BITSTRING			
		1...		B_PORT	1 = This is a bridge port
		.1..		PRT_NOTUSABLE	1 = Port number not usable
		..1.		B_PRT_DEGRADED	1 = Bridge port degraded
		...1 1...		*	Reserved
	111		B_PRT_BTYPE	X'0' = Bridge port held offline
86	(56)	BITSTRING			
		1...		ERR_THRESHOLD	1 = Error threshold exceeded
		.111		PORT_TT	Transceiver technology valid if PORT_TECH='100' 0 = unspecified 1 = GSM 2 = GLS 3 = GLX
		...1 1...		*	Reserved
	111		PORT_PT	Protocol type: 0 = Escon 1 = Reserved 2 = FC Bridge 3 = FC Fabric
85	(55)	BITSTRING	2	*	Reserved
87	(57)	UNSIGNED	1	OTHER_STATIC_PORT	Port that this port is connected to (on same switch)
Prohibit Dynamic Connectivity Mask					
88	(58)	BITSTRING	32	PDCM	0=communication is allowed 1=communication is not allowed
120	(78)	CHARACTER	24	LNAME	Port logical name

QUERY INTERFACE SWITCH

Offsets					
Dec	Hex	Type	Len	Name (Dim)	Description
144	(90)	UNSIGNED	1	IODEF	Port type, where: '0'x = unspecified '1'x = CH (channel) '2'x = CU '3'x = CHCU '4'x = CHCH '5'x = PC '6'x = PCCU '7'x = PCCH '8'x-'FFFFFF'x = Reserved
145	(91)	CHARACTER	3	*	Reserved
Physical (neighbor "who am I" and "who are you") Data					
148	(94)	CHARACTER	32	ND_DET	Determined ND -- "who am I"
180	(B4)	CHARACTER	32	ND_ATT	Attached ND -- "who are you"
Entity Attribute Mask					
212	(D4)	BITSTRING	4	AEAM	
		1111	LOG_CLASS	Logical Entity classification: 0000 = unspecified 0001 = host 0010 = chpid 0011 = switch 0100 = control unit 0101 = device 0110 = reserved 0111 = ambiguous (CHCU, etc) 1000-1111 are reserved
		1111	PHYS_CLASS	Physical Entity classification: 0000 = unspecified 0001 = host 0010 = chpid 0011 = switch 0100 = control unit 0101 = device 0110 = ESCON Model 2 converter 0111 = ambiguous (link is static (no ND_ATT) and IODEF is ambiguous 1000 = CF internal path (only set for CUs) 1001-1111 are reserved
213	(D5)	CHARACTER	2	STATE	State of the entity
		1...	LOGICAL	1=entity is logical
		.1..	P_CURR	1=entity is physically current
		..1.	P_HIST	1=entity is physical history
		...1	LOG_OTHER	1=logical by another interface
		1...	P_OTHER_CURR	1=physical by another interface
	1..	P_OTHER_HIST	1=physical history by other interface

QUERY INTERFACE SWITCH

Offsets									
Dec	Hex	Type	Len	Name (Dim)					Description
	1.		P_INDIRECT					1=(for CU EAM) - the EAM validity was derived from the attached (ND) interfaces from the control unit. 0=(for CU EAM) - the EAM validity was obtained from the CU itself (can only be true for opened switches) 1=(for chp AEAM) - the attached ND for the entity being queried is history but we got the chpid's validity from the chpid's detached ND (which is always valid) so the AEAM is marked P_CURR for the (attached) chpid. 0=(for chp AEAM) - that the attached ND and AEAM have the same validity.
	1		P_AMB					1=physical ambiguous configuration on some interface
		1...		LOG_AMB					1=logical ambiguous configuration on some interface
		.1..		CLASS_AMB					1=logical and physical classes are not compatible.
		..11 1111		*					Reserved
215	(D7)	BITSTRING	1	*					Reserved
End of Mask									
Extrapolated Entity Descriptions									
216	(D8)	CHARACTER	36	OTHERS					
216	(D8)	CHARACTER	32	ND					Extrapolation ND. This field is only valid when AEAM.P_OTHER or AEAM.P_OTHER_HIST are set (on). This ND can be expected to contain a value when either: <ul style="list-style-type: none"> The PID and ND validities differ (and the validity of this better be the same as the PID...if there is a PID) There is more than 1 physical (only) path to an attached entity and the path that is being queried is not the most valid path -- this ND should contain the identity of the more (most) valid (physical) path.
		111.		NDVALID					Indicates validity of this ND. This (NDVALID) is the only field that IHVQEAM (Set_Others) explicitly references. This substructure CANNOT be DCL'd LIKE CHSC_ND as that causes bytes to be skipped in (at least) QEC where OTHERS is %INCLUDEd (because CHSC_ND is DCL'd BDY(DWORD)).
		...1 1111		*					Not explicitly referenced
217	(D9)	CHARACTER	31	*					Rest of ND

QUERY INTERFACE SWITCH

Offsets					
Dec	Hex	Type	Len	Name (Dim)	Description
248	(F8)	UNSIGNED	2	LOG	Extrapolated logical ID... This is the lowest logically defined configuration number assigned to the entity. This field is only valid when AEAM.LOG_OTHER is set (on).
250	(FA)	CHARACTER	2	*	Reserved
End of OTHERS					
252	(FC)	CHARACTER	24	RESPONDER	Responding host id
252	(FC)	CHARACTER	8	APPLNAMER	Applname
260	(104)	CHARACTER	8	SYSPLEXR	Sysplex name
268	(10C)	CHARACTER	8	SYSTEMR	System name
276	(114)	UNSIGNED	4	RCODE	Row return/reason code
Switch description					
280	(118)	CHARACTER	156	SWITCH	(Entity1) switch description
280	(118)	UNSIGNED	2	SW_DEVN	Switch device number
282	(11A)	CHARACTER	1	STATBITS	See below
		1... ..		*	'1'=this switch is in database for QES reserved for QIS
		.1..		VALID_SWDEVN	'1'=switch device number valid for QIS reserved for QES
		..1.		*	Reserved
		...1		OPEN	1=switch is opened (by SA OS/390)
	 1111		*	Reserved
283	(11B)	UNSIGNED	1	LSN	Logical switch number
284	(11C)	CHARACTER	32	SW_PTOK	Physical Token
284	(11C)	CHARACTER	32	NED	Node Element Descriptor
316	(13C)	CHARACTER	32	PID	Unique (physical) ID -- same format as HOST_PID
348	(15C)	UNSIGNED	1	NPINST	Number of installed ports (cards installed)
349	(15D)	UNSIGNED	1	NPIM	Number of implemented ports (ports able to be installed)
350	(15E)	UNSIGNED	1	OP_STATUS	Operational status where: '00'x = unspecified '01'x = not open '02'x = in contention '03'x = hardware error '04'x = system error '05'x = i/o error '06'x = operational '07'x = reserved '08'x = read only (HCP set) '09'x - 'FF'x = reserved
351	(15F)	UNSIGNED	1	A_CUP	CUP port address
352	(160)	UNSIGNED	4	STATUS_CODE	error code (if any)
Entity Attribute Mask					
356	(164)	BITSTRING	4	EAM	

QUERY INTERFACE SWITCH

Offsets					
Dec	Hex	Type	Len	Name (Dim)	Description
	1111		LOG_CLASS	Logical Entity classification: 0000 = unspecified 0001 = host 0010 = chpid 0011 = switch 0100 = control unit 0101 = device 0110 = reserved 0111 = ambiguous (CHCU, etc) 1000-1111 are reserved
	1111		PHYS_CLASS	Physical Entity classification: 0000 = unspecified 0001 = host 0010 = chpid 0011 = switch 0100 = control unit 0101 = device 0110 = ESCON Model 2 converter 0111 = ambiguous (link is static (no ND_ATT) and IODEF is ambiguous 1000 = CF internal path (only set for CUs) 1001-1111 are reserved
357 (165)		CHARACTER	2	STATE	State of the entity
	1...		LOGICAL	1=entity is logical
	.1..		P_CURR	1=entity is physically current
	..1.		P_HIST	1=entity is physical history
	...1		LOG_OTHER	1=logical by another interface
	1...		P_OTHER_CURR	1=physical by another interface
1..		P_OTHER_HIST	1=physical history by other interface
1.		P_INDIRECT	1=(for CU EAM) - the EAM validity was derived from the attached (ND) interfaces from the control unit. 0=(for CU EAM) - the EAM validity was obtained from the CU itself (can only be true for opened switches) 1=(for chp AEAM) - the attached ND for the entity being queried is history but we got the chpid's validity from the chpid's detached ND (which is always valid) so the AEAM is marked P_CURR for the (attached) chpid. 0=(for chp AEAM) - that the attached ND and AEAM have the same validity.
1		P_AMB	1=physical ambiguous configuration on some interface

QUERY INTERFACE SWITCH

Offsets					
Dec	Hex	Type	Len	Name (Dim)	Description
	1...		LOG_AMB	1=logical ambiguous configuration on some interface
	.1..		CLASS_AMB	1=logical and physical classes are not compatible
	..11	1111		*	Reserved
359 (167)		BITSTRING	1	*	Reserved
End of Mask					
360 (168)		CHARACTER	32	IODFDESC	HCD's user description of this object
392 (188)		CHARACTER	7	ECLEVEL	Hardware EC level
399 (18F)		UNSIGNED	1	LOWPORT	Lowest port addr on this switch
Declare substructure					
400 (190)		BITSTRING	4	SCPSTATE	Operating system state
	1...		BOXED	1=Boxed
	.1..		NOTREADY	1=Not ready
	..1.		BUSY	1=Busy
	...1		RESERVED	1=Reserved
	1...		ALLOCATED	1=Allocated
1..		ONLINE	1=Online
1.		UNLOAD	1=Unload pending
1		MOUNT	1=Mount pending
	1...		RESPENDING	1=Reserve pending
	.1..		PENDING	1=Pending offline
	..1.		OFFALLOC	1=Offline -- allocated to SCP
	...1		OFFESCM	1=Offline due to SA OS/390
	1...		OFFCUIR	1=Offline due to CUIR
1..		OFFTAPE	1=Offline due to tape
1.		OFFHIERCH	1=Offline due to hierarchy reason
1		OFFOPER	1=Offline due to operator
	1...		OFFLINE	1=Offline
	.1..		INUSE	1=Device is in use (message device only)
	..1.		OPERATIONAL	1=Device is operational (message device only)
	...1		NOTOP	1=Device is not operational (message device only)
	1...		AUTOSW	1=Device is set autoswitch
End of include					
404 (194)		CHARACTER	32	SW_LTOK	Logical Token (inherited from control unit for this switch -- is binary zeros when not available.
End of include					
37 records replaced by above INCLUDE file					
436 (1B4)		CHARACTER	4	*	Reserved

QUERY RELATION CHP

Purpose

Use the QUERY RELATION CHP command at the API to obtain data regarding the IOCDS relationship between the two specified entities (objects). Output is based on IOCDS definitions, but it can be influenced by configuration mismatches that have been detected by I/O operations.

Syntax

►► Query Relation Chp ◄◄

►| Object_1_identifier | Object_2 | Scope | Options | ◄◄

Object_1_identifier:

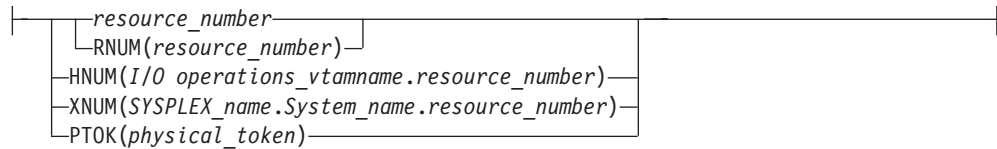

Object_2:



Object_2_type:

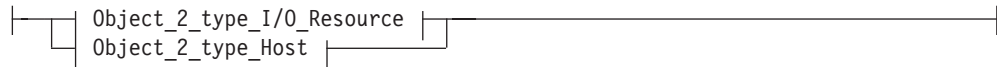

Object_2_type_I/O_Resource

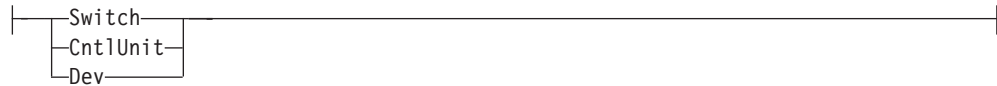

Object_2_type_Host



Object_2_format:

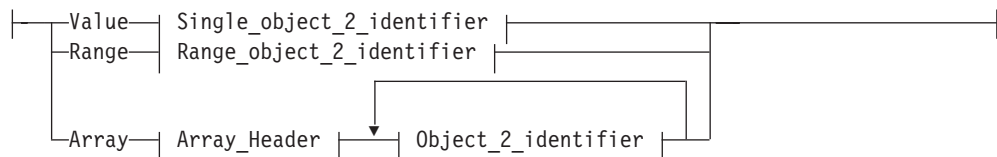

QUERY RELATION CHP

Parameters

- This command returns data about the logical relationships (in IOCDS) between the first entity, which is a single CHPID, and the second entity or entities.
- For a QUERY RELATION command, the first entity (host name) must be known to the issuing I/O operations (primary host). The command returns an indication whether the specified CHPID is defined in IOCDS to the issuing I/O operations.
- If you specify switches as the second entity, the command returns an indication whether the CHPID in the first entity has defined paths through the switches.

A host identifier type can be one of the following keywords:

NOPATHTEST

No checking to verify paths. Refer to page 190 for further details.

PATHTEST

Check to verify path. Refer to page 190 for further details.

QUERY RELATION CNTLUNIT

Purpose

Use the QUERY RELATION CNTLUNIT command at the API to obtain data regarding the IOCDS relationship between the two specified entities (objects). Output is based on IOCDS definitions, but it can be influenced by configuration mismatches that have been detected by I/O operations.

Syntax

►►—Query Relation CntlUnit—| Object_1_identifier |—| Object_2 |—| Scope |—►►

Object_1_identifier:

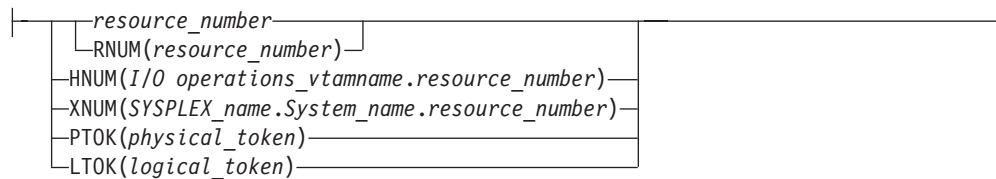

Object_2:

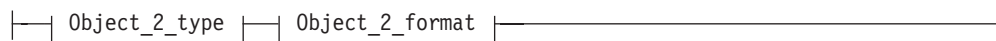

Object_2_type:



Object_2_format:

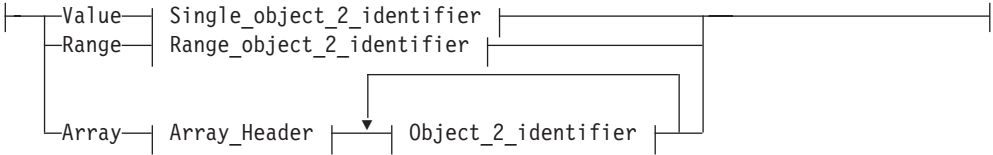

Single_object_2_identifier (when Object_2_type is I/O Resource):

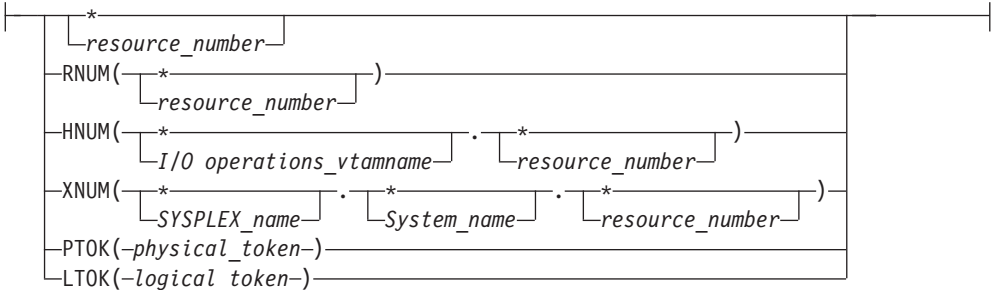

Range_object_2_identifier (when Object_2_type is I/O Resource):

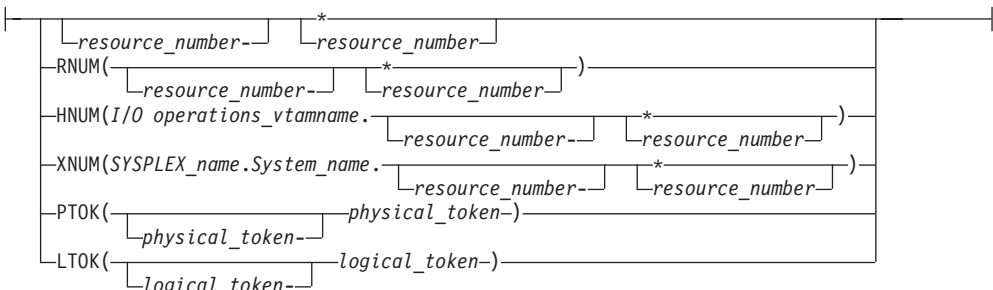

Object_2_identifier (when Object_2_type is HOST):

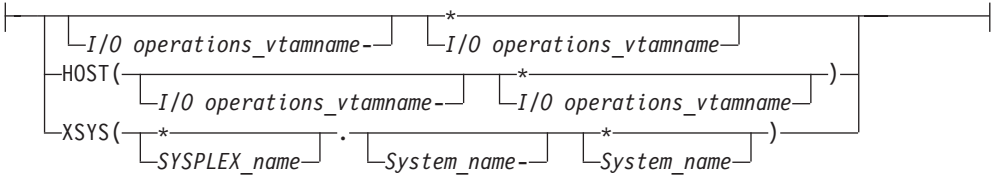

Scope:

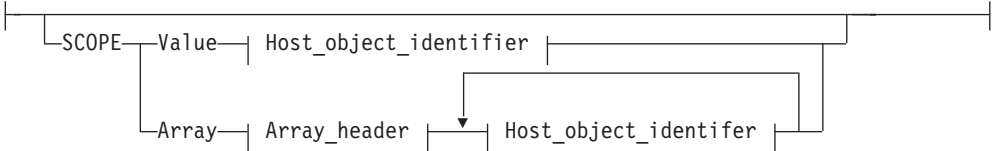

Host_object_identifier:

QUERY RELATION CNTLUNIT

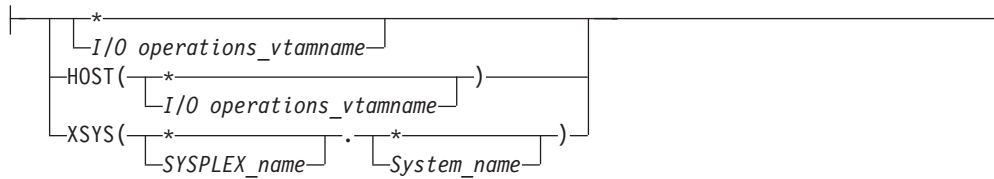

Parameters

- This command returns data about the relationships between the specified control unit and the second entity in the command.
- If the second entity is Host and the issuing I/O operations is included in the parameters, this command returns indications of what CHPIDs have (IOCDS) defined paths to the control unit specified in the first entity.
- If the second entity is Host and a voting I/O operations is included in the parameters, this command returns only an indication that the I/O operations (secondary host) known to the issuing I/O operations. No pathing data can be returned.
- If the second entity is Chp, the command returns indications of whether the specified CHPIDs have (IOCDS) defined paths to the specified control unit for the issuing I/O operations (primary host).
- If the second entity is Switch, the command returns indications of whether the control unit specified has (IOCDS) defined paths through the specified switch(es) for the issuing I/O operations.
If the switch specifies the entry switch of a cascaded switch pair in the path to the control unit the relationship will return.
 - no output port information
 - the input port information shows the port that the channel is connected toNote that a switch can be the path's entry switch as well as the path's entry and destination switch at the same time. In this case, 2 rows are returned.
- If the second entity is Dev, the command returns indications of whether the specified control unit has (IOCDS) defined paths through the specified devices for the issuing I/O operations.

QUERY RELATION DEV

Purpose

Use the QUERY RELATION DEV command at the API to obtain data regarding the IOCDS relationship between the two specified entities (objects). Output is based on IOCDS definitions, but it can be influenced by configuration mismatches that have been detected by I/O operations.

Syntax

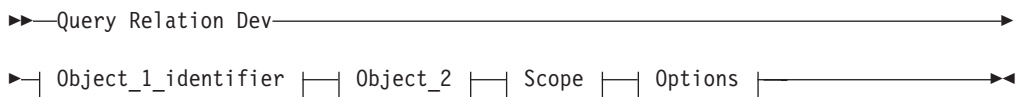

Object_1_identifier:

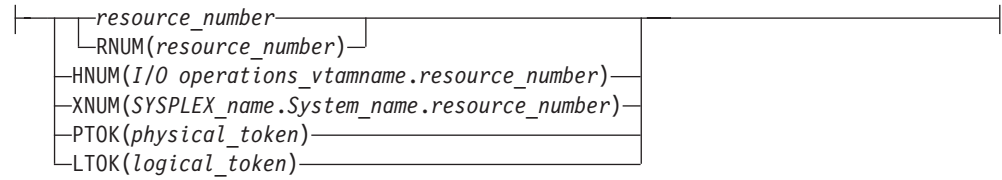

Object_2:



Object_2_type:

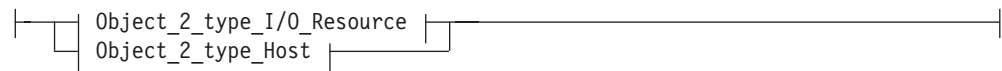

Object_2_type_I/O_Resource



Object_2_type_Host



Object_2_format:

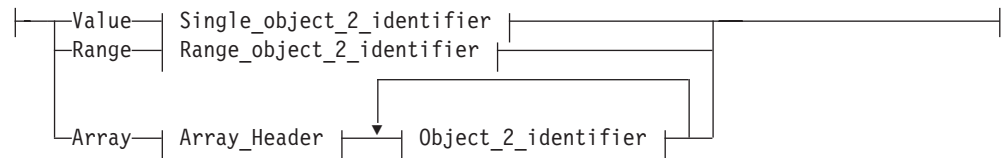

Single_object_2_identifier (when Object_2_type is I/O Resource):

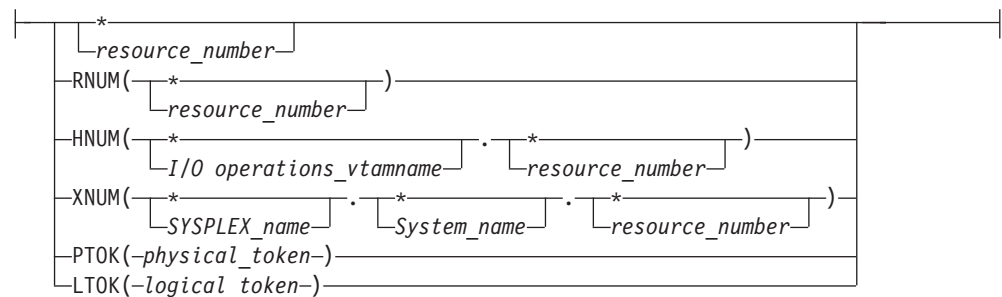

- If the second entity is Switch, the command returns indications of whether the control unit specified has (IOCDS) defined paths through the specified switch(es) for the issuing I/O operations.

If the switch specifies the entry switch of a cascaded switch pair in the path to the control unit the relationship will return...

- no output port information
- the input port information shows the port that the channel is connected to

Note that a switch can be both the path's entry switch as well as the paths entry and destination switch at the same time. In this case, 2 rows are returned.

- If the second entity is CntlUnit, the command returns indications of whether the specified control unit(s) have (IOCDS) defined paths through them to the specified device for the issuing I/O operations.

A host identifier type can be one of the following keywords:

NOPATHTEST

No checking is done on the command to verify that the path from the CHPID to the device exists.

PATHTEST

If you specify Pathtest on the command, then checking is done to verify that the device is physically there with relation to each CHPID.

Notes:

1. When ARRAY is the *Object_format_type*, the *Object_Identifier_Types* can be mixed and every *Object_Identifier_Type* must match the class of the specified *Object_Type* (all must be I/O_resources or all must be Hosts). For example, Q E HOST can accept only HOST and XSYS entries in the array.
2. The Array_header contains the number of elements in the array.
3. PTOK is valid with RANGE but you should be fully aware of PTOK structure. For example, RANGE PTOK could be used to specify all of the serial numbers of a certain type of device. However, certain PTOK values may cause unpredictable results with RANGE.
4. When ARRAY is the *SCOPE_format_type*, the *Host_Object_Identifier_Types* can be mixed (HOST and XSYS).
5. If you need to translate a QUERY RELATION command to a new format due to an overflow condition reported by a return code and reason code, you may need to begin the new command with the *last* value that was returned or some pathing information could be lost.

Output

The format of the output from the Query Relation Dev command is as follows:

Offsets					
Dec	Hex	Type	Len	Name (Dim)	Description
0	(0)	STRUCTURE	*	QRO	
0	(0)	CHARACTER	48	HDR	Header data
0	(0)	CHARACTER	4	EYE_CATCHER	Identifies control block ('QRO')
4	(4)	UNSIGNED	2	HDR_SIZE	Length of (this) QRO.HDR
6	(6)	UNSIGNED	2	ROW_SIZE	Length of 1 ROW
8	(8)	CHARACTER	8	ESCM_HOST	Responding host VTAM application name
16	(10)	CHARACTER	4	ESCM_REL	SA OS/390 Version/Release format is "VxRy" where x is the Version Number and y is the Release Number
20	(14)	UNSIGNED	4	NUM_ROWS	ROW dimension

QUERY RELATION DEV

Offsets					
Dec	Hex	Type	Len	Name (Dim)	Description
24	(18)	UNSIGNED	1	FORMAT_ID	Identifies format of table
		1... ..		MORE_DATA	0=entire Query response in QRO 1=Query response too large to fit in QRO (ask again, use RANGE)
		.1.. ..		PATHTEST	1=PATHTEST requested
		..11 1111		*	Reserved
26	(1A)	CHARACTER	8	PLEX_NAME	Sysplex name (blank if none)
34	(22)	CHARACTER	8	SYST_NAME	System name
42	(2A)	CHARACTER	2	*	Reserved
44	(2C)	UNSIGNED	4	NUM_HOSTS	Number of hosts responding
48	(30)	CHARACTER	372	ROW (*)	Path descriptions -- indexed by HDR.NUM_ROWS
48	(30)	CHARACTER	8	HOST_APPL	Host VTAM application name
56	(38)	UNSIGNED	1	CHPID	Channel path identifier (00-FFx)
57	(39)	UNSIGNED	1	PORTIN	When data is flowing from the host, the input port on the switch (if a switch is in the path)
58	(3A)	UNSIGNED	2	SW_DEVN	Switch device number (if a switch is in the path).
60	(3C)	UNSIGNED	1	LSN	Logical switch number (that goes with SW_DEVN) when a switch is in the path.
61	(3D)	UNSIGNED	1	PORTOUT	When data is flowing from the host, the output port on the switch (if a switch is in the path)
62	(3E)	UNSIGNED	2	CU_NUMBER	Control unit number
64	(40)	UNSIGNED	2	DEV_NUMBER	Device number

The following bits describe the validity of the data in the corresponding row.

66	(42)	BITSTRING	2	STATBITS	Indicate row data validity
		1... ..		VALID_DATA	1=this row contains a valid path 0=this row does not contain a valid path - either the entity2 is not found in the database at all or there is no relation between the entity1 and entity2 specified.
		.1.. ..		INCOMPLETE	0=Queried data is in database (not a proxy request) 1=Queried data not known (secondary host databases are not known)

The following bits describe switch data validity

		.1.		VALID_SW	1 = SW_DEVN is valid (switch either is or was operational)
		...1		VALID_LSN	1 = LSN is valid (path is switched)
	 1...		VALID_PORTIN	1 = PORTIN value is verified
	1..		VALID_PORTOUT	1 = PORTOUT value is verified

The following bits indicate which path elements are detected to be involved in an ambiguous state.

	1.		AMBIG_PORTIN	1 = CHCH, CHCU detected on PORTIN
	1		AMBIG_PORTOUT	1 = CHCU detected on PORTOUT

The following bits indicate which ports (paths) are involved with chained switches.

		1...		CHAIN_PORTIN	1 = PORTIN is part of CHAIN
		.1..		CHAIN_PORTOUT	1 = PORTOUT is part of CHAIN
		..1.		VALID_DEVNUM	1 = DEV_NUMBER contains data and the DEV_NUMBER is defined in the configuration
		...1		PATHTEST	1 = PATHTEST data is available
	 1...		VALID_CUNUM	1 = CU_NUMBER contains data and the CU_NUMBER is defined in the configuration
	1..		CU_ISA_CF	1 = CU in this row is a coupling facility so PTOk mapping is for ND (when '0'b, PTOk mapping is for NED)

Offsets

Dec	Hex	Type	Len	Name (Dim)	Description
	1.		VALID_CHP	1 = CHPID contains a value that is defined in the configuration
The following indicates whether the current row is to be processed when this table is used as input (to a Query Entity command).					
68	(44)	UNSIGNED	1	CODE	For QUERY ENTITY command. This space is used to tell IHV whether to operate on the given row. 0 = ignore this row 1 = operate on this row 2-255 = reserved (row ignored if specified)
69	(45)	CHARACTER	1	* MVS_MSG	Workarea for internals 1=PTMSG is from MVS
		1...			
70	(46)	CHARACTER	2	*	Reserved (round to word)
72	(48)	CHARACTER	8	SYSPLEX	Sysplex name (blank if none)
80	(50)	CHARACTER	8	SYSTEM	System name
88	(58)	CHARACTER	24	RESPONDER	Responder id
88	(58)	CHARACTER	8	APPLNAMER	Responder host applname
96	(60)	CHARACTER	8	SYSPLEXR	Responder host sysplex name
104	(68)	CHARACTER	8	SYSTEMR	Responder host system name
112	(70)	UNSIGNED	4	RCODE	Return/reason code for row
116	(74)	BITSTRING	4	PATH_AVAIL	Last known state of this path from CHSC "Store Sch Path Info" instruction
116	(74)	BITSTRING	1	CHSC_LEVEL	Level (scope) of information: '10'x = error affects entire chp '20'x = error affects destination link '30'x = error affects logical path '40'x = error affects I/O on logical path
117	(75)	BITSTRING	2	CHSC_CODE	Status code and modifier
117	(75)	BITSTRING	1	STATCODE	Status code

QUERY RELATION DEV

Offsets				Name (Dim)	Description
Dec	Hex	Type	Len		
118	(76)	BITSTRING	1	MODCODE	Modifier code X'0000' = no data available (ESCM value) X'00FF' = Available, operational last time used X'1010' = Chpid type does not match hardware type X'1020' = Serial CTC feature not installed X'1030' = ESCON chp connected to ESCON chp (defn err) X'1040' = SCTC connected to ESCON CU X'1050' = Non-CVC connected to converter X'1060' = CVC channel without converter X'1070' = CNC/multiple CU connection with no ESCD X'1080' = No CU link address defined X'1090' = Duplicate link address with port and CU X'10A0' = Msg facility channel connected to another msg facility channel. X'10C0' = Buffer sizes incompatible between msg facility channel and msg-processor intersystem channel. X'10xx' = Path in definition error X'2010' = Chpid not configured online X'2020' = Chpid is in check stop state X'2030' = Chpid is in permanent error X'20xx' = Chpid is unavailable X'30FF' = Wrap block is installed X'40FF' = Chpid is in terminal state X'5010' = Loss of signal or sync X'5020' = Not-op sequence recognized X'5030' = Sequence timeout X'5040' = Illegal sequence received X'50xx' = Link failure detected X'60FF' = In offline reception state X'7010' = Port reject – address invalid X'7011' = Undefined destination error X'7012' = Destination port malfunction X'7013' = Port intervention required X'70xx' = Port reject X'8001' = Link reject – transmit error X'8005' = Link reject – dest. address invalid or error X'8007' = Reserved field error

Offsets				
Dec	Hex	Type	Len	Name (Dim)
				Description
				X'8008' = Unrecognized link control function
				X'8009' = Protocol error
				X'800A' = ALA error
				X'800B' = Unrecognized device level
				X'80xx' = Link level reject encountered
				X'9010' = Connection error
				X'9020' = Channel detected transmission error
				X'9030' = Protocol error
				X'9040' = Destination address invalid
				X'9050' = Device level error
				X'90xx' = Channel link level error
				X'A001' = Pacing parameters error
				X'A002' = Logical path resource unavailable
				X'A004' = CU image does not exist
				X'A005' = Logical path precluded at CU
				X'A0xx' = Logical path unavailable
				X'B010' = CU-device initialization in progress
				= Unknown state or no further info available
				X'B020' = Link busy last encountered
				X'B030' = Port busy last encountered
				X'B040' = Chpid busy last encountered
				X'B0xx' = Path initialization in progress
				X'C010' = Select-in or address exception
				X'C0xx' = SCH path ok but device not operational
				X'FFFF'

120 (78) BITSTRING 1 SCPSTATE State of path from SCP
 1... .. ONLINE 1=path is online to SCP
 .1.. .. OFFLINE 1=path is offline to SCP Other bits are reserved

121 (79) CHARACTER 3 * Reserved

A LPE_STATUS.ESCON is returned whenever there is a chpid in the row.
 LPE_STATUS.LPE is ONLY returned when the row contains a valid chpid
 along with valid switch devnum, cunum or device number.

124 (7C) BITSTRING 1 LPE_STATUS Logical path established indicators
 1... .. ESCON 1=this path supports LPEs and LPE info is valid
 .1.. .. LPE 1=an ESCON logical path is established (CHSC info).
 LPE_STATUS.ESCON bit validates this field.
 0=no path established.
 PTMSG is returned ONLY when PATHTEST is specified in the command. If PATHTEST is not specified, binary zeros are returned in this field.

125 (7D) CHARACTER 71 PTMSG MVS or ESCM message due to issuing I/O down this path. Valid only when PATHTEST specfd. TOKS are returned for every command where the associated (RNUM) item is set. Additionally, control unit and device physical tokens are refreshed for each row when PATHTEST is specified.

196 (C4) CHARACTER 224 TOKS Logical/Physical tokens Note: Logical tokens consisting of 32 bytes of binary zeros denotes that the LTOK is not valid/available.

Chpid tokens

196 (C4) CHARACTER 32 CHP_PTOK Actually determined ND chpids do not have logical tokens

Switch tokens - For Query Relation Switch-Switch commands, the tokens returned here are for the entity2 (chained) switch.

QUERY RELATION DEV

Offsets					
Dec	Hex	Type	Len	Name (Dim)	Description
228	(E4)	CHARACTER	32	SWIT_PTOK	Switch NED if switch is OPEN, or PID if switch is not open (or defined?).
260	(104)	CHARACTER	32	SWIT_LTOK	Only valid if this switch is defined as a device to this host -- then inherited from CU for this switch.
Control unit tokens					
292	(124)	CHARACTER	32	CU_PTOK	NED (or ND if CU_ISA_CF)
324	(144)	CHARACTER	32	CU_LTOK	From HCD
Device tokens					
356	(164)	CHARACTER	32	DEV_PTOK	NED
388	(184)	CHARACTER	32	DEV_LTOK	From HCD
420	(1A4)	CHARACTER	*		Reserved (to round)

QUERY RELATION HOST

Purpose

Use the QUERY RELATION HOST command at the API to obtain data regarding the IOCDS relationship between the two specified entities (objects). Output is based on IOCDS definitions, but it can be influenced by configuration mismatches that have been detected by I/O operations.

Syntax

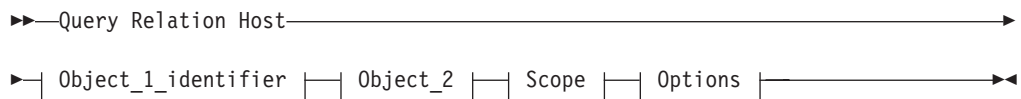

Object_1_identifier:

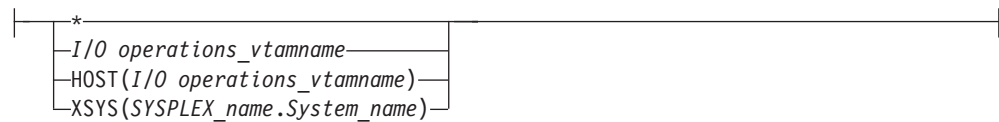

Object_2:



Object_2_type:



Object_2_format:

QUERY RELATION HOST

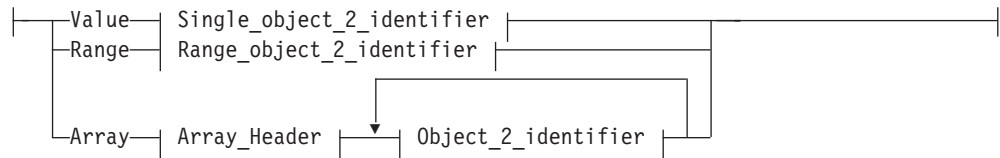

Single_object_2_identifier (when Object_2_type is I/O Resource):

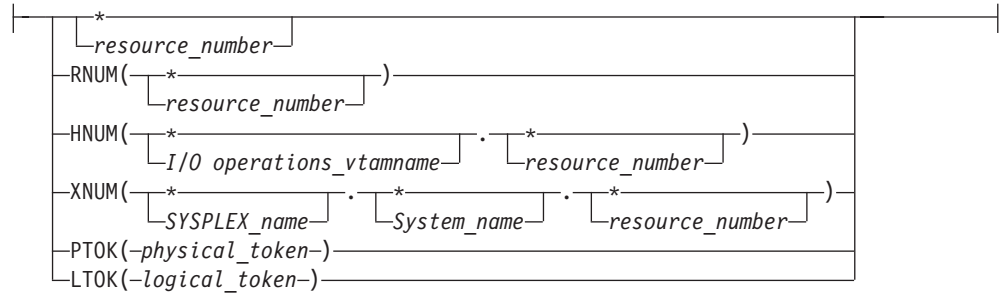

Range_object_2_identifier (when Object_2_type is I/O Resource):

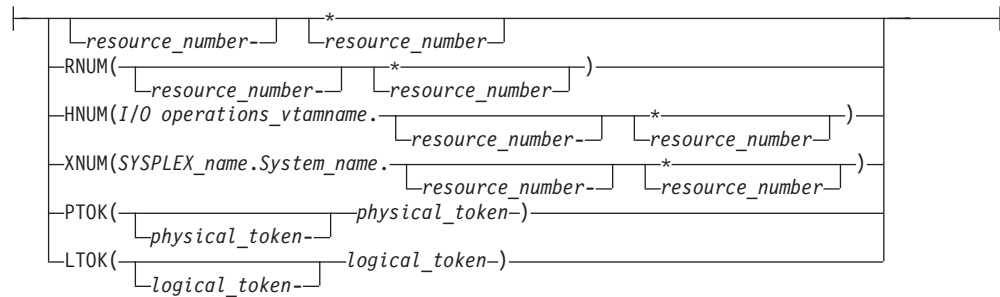

Object_2_identifier (when Object_2_type is HOST):

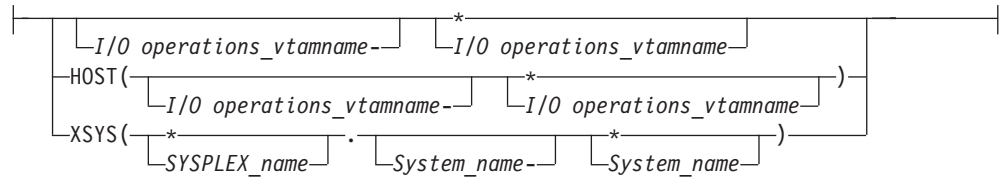

Scope:

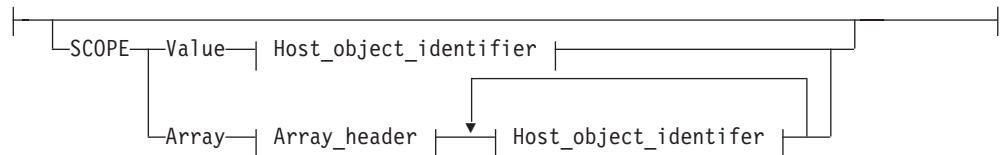

Host_object_identifier:

QUERY RELATION HOST

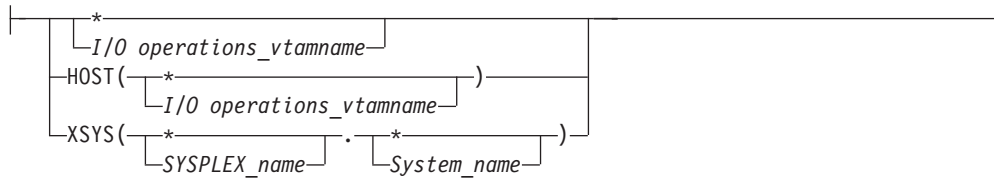

Options:



Parameters

- For a QUERY RELATION command, the first entity (host name) must be known to the issuing I/O operations (primary host).
- For Q R H S, you can specify any I/O operations that participates in vary path consensus processing initiated by the issuing I/O operations. However, data indicating CHPID attachments to the switches is returned only for the issuing I/O operations

A host identifier type can be one of the following keywords:

NOPATHTEST

No checking is done on the command to verify that the path from the CHPID to the device exists.

The NOPATHTEST option is only valid on the QUERY RELATION HOST to Device command.

PATHTEST

If you specify Pathtest on the command, then checking is done to verify that the device is physically there with relation to each CHPID.

The PATHTEST option is only valid on the QUERY RELATION HOST to Device command.

Notes:

1. When ARRAY is the *Object_format_type*, the *Object_Identifier_Types* can be mixed and every *Object_Identifier_Type* must match the class of the specified *Object_Type* (all must be I/O_resources or all must be Hosts). For example, Q E HOST can accept only HOST and XSYS entries in the array.
2. The Array_header contains the number of elements in the array.
3. PTOK is valid with RANGE but you should be fully aware of PTOK structure. For example, RANGE PTOK could be used to specify all of the serial numbers of a certain type of device. However, certain PTOK values may cause unpredictable results with RANGE.
4. When ARRAY is the *SCOPE_format_type*, the *Host_Object_Identifier_Types* can be mixed (HOST and XSYS).

QUERY RELATION SWITCH

Purpose

Use the QUERY RELATION SWITCH command at the API to obtain data regarding the IOCDS relationship between the two specified entities (objects).

QUERY RELATION SWITCH

Output is based on IOCDs definitions, but it can be influenced by configuration mismatches that have been detected by I/O operations.

Syntax

►►—Query Relation Switch—| Object_1_identifier |—| Object_2 |—| Scope |—►►

Object_1_identifier:

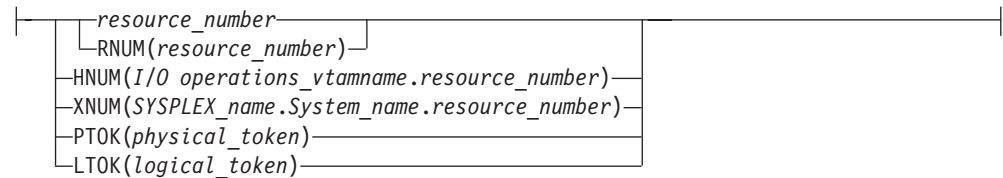

Object_2:

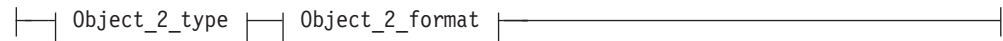

Object_2_type:

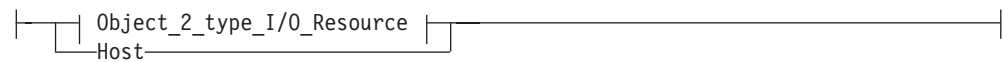

Object_2_type_I/O_Resource



Object_2_format:

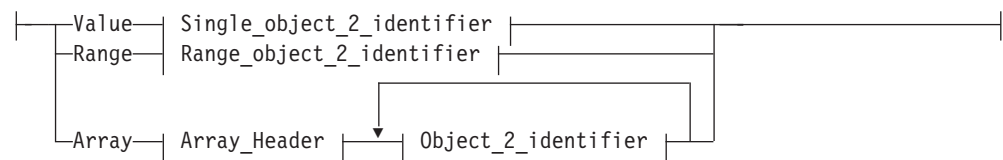

QUERY RELATION SWITCH

Single_object_2_identifier (when Object_2_type is I/O Resource):

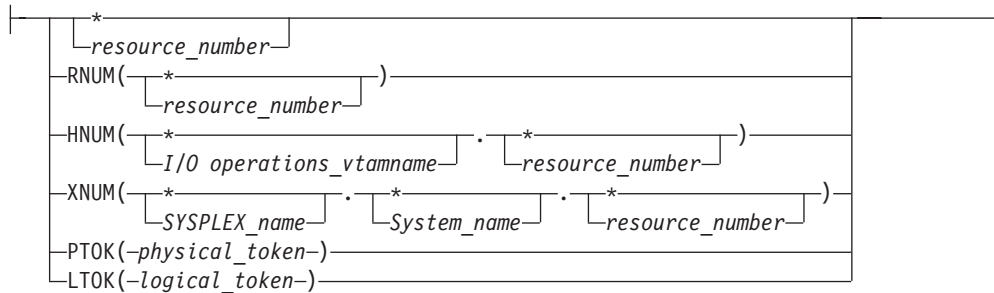

Range_object_2_identifier (when Object_2_type is I/O Resource):

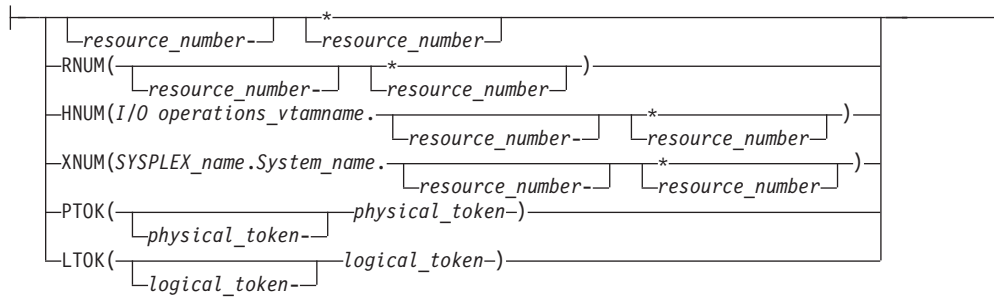

Object_2_identifier (when Object_2_type is HOST):

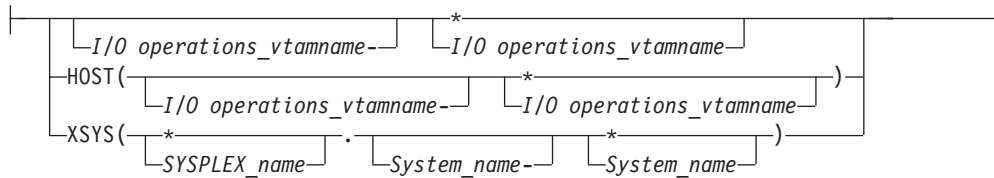

Scope:

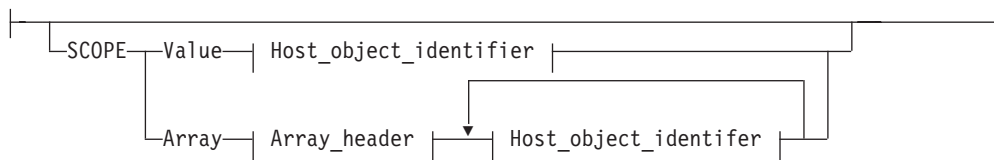

Host_object_identifier:

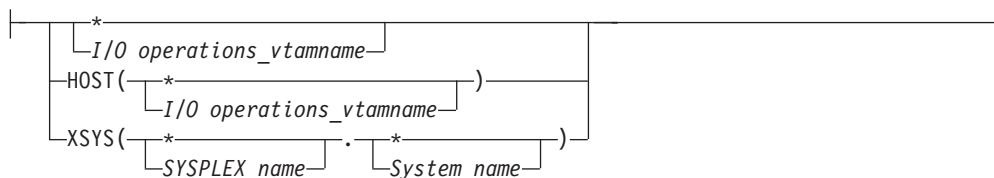

Parameters

- This command returns data about the relationships between the specified switch and the second entity in the command.
- If you specify the issuing I/O operations (host) as the second entity, 1 ROW is returned for each channel that I/O operations perceives as being connected to the switch. (If the physical settings at the switch indicate differently from the IOCDS, I/O operations “perceives” the physical settings to be accurate.)
If the switch specifies the destination switch of a cascaded switch pair the relationship will return one row for each CHP that defines a path to the CUP device of the switch with the following differing information...
 - no input port information
 - the output port information shows X'FE' indicating the CUP device of a cascaded switch
- If you specify a voting I/O operations (host) as the second entity, only 1 ROW is returned, indicating that the host is able to communicate with, and control, the switch. No CHPIDs are returned, and the incomplete bit is set for that host.
- If you specify CHP as the second entity, the command returns indications of what channel(s) are defined in IOCDS to be attached to the switch. To obtain data on what channels are defined to communicate with a switch, specify Q R CU C, specifying the control unit port, or the Q R D C, specifying the switch device number.
- If you specify Switch as the second entity, the command returns indications of what chains have been established with the first entity.
- If you specify CntlUnit or Dev as the second entity, the command returns indications whether the specified switch has IOCDS-defined paths through it to the specified control units or devices.
If the switch specifies the entry switch of a cascaded switch pair in the path to the control unit the relationship will return...
 - no output port information
 - the input port information shows the port that the channel is connected to

QUERY SWITCH

Purpose

Use the QUERY SWITCH command at the API to obtain an array of port information blocks (PIBs) and related data from the specified switch.

Syntax

►►—Query Switch—*swchdevn*—◄◄

Parameters

swchdevn

Specifies the switch to be queried. The switch must be allocated to, or attached to, the issuing I/O operations. Refer to *System Automation for OS/390 Operator's Commands* for further information about switches.

QUERY SWITCH

Output

The data is presented as an array of 80-byte entries, as shown below. 256 entries are returned. (The first array is for port address 00.)

Offsets					
Dec	Hex	Type	Len	Name (Dim)	Description
0	(0)	STRUCTURE	80	QSWT	
0	(0)	BITSTRING	1	QSWTFLAG1	Flag byte 1
		1... ..		QSWTLAST	Last bit - end of variable length list indicator (0=more records in list) (1=last record in list)
		.1.. ..		QSWTMDPT	Midport bit - if bit is set indicates that this port is a midport on a defined chain.
		..11 1111	*	*	Reserved
1	(1)	BITSTRING	1	QSWTFLAG2	Flag byte 2
		1111 11..	*	*	Reserved
	11		QSWT_DCM_STATE	10 = this port is DCM eligible but not allowed for DCM activities 11 = this port is DCM eligible and allowed for DCM activities 0x = this port is DCM ineligible
2	(2)	UNSIGNED	2	QSWTSWIT	Switch device number
4	(4)	CHARACTER	48	QSWTLAIB	Switch port information block
4	(4)	CHARACTER	1	*	Reserved
5	(5)	UNSIGNED	1	LAIBNUMB	Port number
6	(6)	UNSIGNED	1	LAIBADDR	Port address
7	(7)	CHARACTER	1	*	Reserved
8	(8)	BITSTRING	4	LAIBDESC	Port descriptor bits
		1... ..		LAIBUNMP	Port implemented bit (0=port is implemented) (1=port is not implemented)
		.1.. ..		LAIBFBIT	Port blocked bit (0=port not blocked) (1=port is blocked)
		..1.		LAIBIC	Port prohibit connection (0=No prohibits for this port) (1=Prohibits defined)
		...1		LAIBSBIT	Port connection bit (0=port not connected) (1=port is connected)
	 1...	*	*	Reserved
	111		LAIBLED	Port Hardware Bit (0=unknown port) (1=internal port) (3=LED port) (4=XDF port)
9	(9)	BITSTRING	1	*	Reserved
		1... ..		LAIBNBIT	Port installed bit (0=port is installed) (1=port is not installed)
		.1.. ..		LAIBLFBIT	Port link failure bit (0=no link failure) (1=link failure condition)
		..1.		LAIBSP	Port spare port bit (0=port is not a spare port) (1=port is a spare port)
		...1		LAIBOLBIT	Port offline bit (0=port is not offline) (1=port is offline)
	 1...		LAIBDMBIT	Port maintenance mode bit (0=port not in maintenance mode) (1=port in maintenance mode)
	1..		LAIBCUPBIT	Port CUP bit (0=port is not the control unit port) (1=port is the control unit port)

Offsets			Len	Name (Dim)	Description
Dec	Hex	Type			
	1.		LAIBSERVICE	Port service bit (0=port does not require service) (1=port requires service)
	1		LAIBINVATT	Port invalid attachment bit (0=port does not have an invalid attachment) (1=port has an invalid attachment)
10	(A)	BITSTRING			
		1...		LAIBBRGPRT	1 = This is a bridge port
		.1..		LAIBBPRTNU	1 = Port number not usable
		..1.		LAIBBPDEG	1 = Bridge port degraded
		...1 1...		*	Reserved
	111		LAIBBPROFF	<>0 = Bridge port held offline
11	(B)	BITSTRING			
		1...		LAIBETE	1 = Error threshold exceeded
		.111		LAIBTT	Transceiver technology: 0 = unspecified 1 = GSM 2 = GLS 3 = GLX
	 1...		*	Reserved
	111		LAIBPT	Protocol type: 0 = Escon 1 = Reserved 2 = FC Bridge 3 = FC Fabric
12	(C)	CHARACTER	1	*	Reserved - 1 BYTE
13	(D)	UNSIGNED	8	LAIBESVR	Num ESCON server ports
14	(E)	UNSIGNED	1	LAIBSADR	Static connection port address
15	(F)	CHARACTER	5	*	Reserved
20	(14)	CHARACTER	32	LAIBICM	Port prohibit dynamic connection mask (PDCM)
52	(34)	CHARACTER	24	QSWTNAME	Port logical name
76	(4C)	UNSIGNED	2	QSWTCSWIT	Switch device number for the chained switch
78	(4E)	UNSIGNED	1	QSWTCPORT	Chained port address
79	(4F)	BITSTRING	1	*	Reserved
80	(50)	CHARACTER		QSWTEND	End of QSWT

Examples

Note: If a port is not implemented, only the switch number, port address, and unimplemented bit contain valid data; all other fields are set to binary zeros.

The following sample output shows that port address *F3* has been assigned port name *0500X0600*. It is statically connected to port address *E1* on switch device number *0500*. As one would expect from the port name, port address *F3* is chained to port address *D0* on switch device number *0600*.

REMOVE and RESTORE CHP

Parameters

A host identifier type can be one of the following keywords:

Vary

This is the default option and it indicates that appropriate processing must be done at the host to support the REMOVE and RESTORE CHP commands.

NOVary

This option is not valid for the REMOVE and RESTORE CHP commands.

Force

This option says to execute the command in the best manner possible. For example, if one of the specified hosts does not respond, the command is still performed on all other hosts.

NOForce

This is the default option and indicates that if there is any failure, the command should not continue and a return and reason describing the failure will be returned.

NOCheck

The NOCheck option overrides the detection of two conditions that would cause the failure of the command under the default NOForce option:

1. Detection of systems in the scope of the command on which I/O operations is not operating.
2. Detection of downlevel I/O operations's operating on systems in the scope of the command.

If either of these conditions are detected, a return code of 4 is returned.

Backout

This is the default option and indicates that if any failure is reported by any of the participating systems, any successful REMOVE and RESTORE CHP actions for all the participating host systems will be backed out.

NOBackout

This option indicates that if any error condition is detected during the REMOVE and RESTORE CHP processing, I/O operations will not attempt to change any REMOVE and RESTORE CHP actions that have been performed.

CONDitional

This is the default option for both the REMOVE and RESTORE CHP commands. It indicates that no special configure offline or configure online action should be performed.

UNCONDitional

For the REMOVE CHP command, this option puts the specified chpids immediately into pending offline status, even if the chpids are currently active, allocated, or reserved.

For the RESTORE CHP command, this option brings the specified chpids online, even if there are no paths to the chpids, or if the chpids are pending offline and boxed.

OUTputALL

This is the default and it allows all results from REMOVE and RESTORE CHPs performed (regardless of return code) to be returned to the API invoker.

OUTputERRor

This option allows only error results (REMOVE and RESTORE CHPs that had

REMOVE and RESTORE CHP

a return code ≥ 4 , plus other errors that occurred during the processing of the command) to be returned to the API invoker.

OUTputNone

This option allows only the return and reason code (no text information) to be returned to the API invoker. If the return code from the command is ≥ 4 , a detailed message (IHVC00I, IHVC001I, or IHVC002I) is also returned.

Notes:

1. This form, with no keyword, is supported for compatibility with the previously existing syntax of this command.
2. ARRAY has no short form for this command (in other multisystem commands A is used as a short form). That is to avoid the need to look ahead in parsing "Remove Chp A..." to distinguish between removing the CHP with ID 'A' and removing an array of CHPs.
3. In this command, THIS-SYS is a means to refer to the primary host (the one to which the command is being input). It is accepted by the primary regardless of whether VTAM is operational or not.
4. When ARRAY is the *Object_format_type*, the *Object_Identifier_Types* may be mixed (for example, HOST and XSYS), and every *Object_Identifier_Type* must be an I/O resource type. For example, an HNUM and an XNUM entry can be in the same array.
5. The Array_header contains the number of elements in the array.
6. PTOK is valid with RANGE but you should be fully aware of PTOK structure. Certain PTOK values may cause unpredictable results with RANGE
7. When ARRAY is the *SCOPE_format_type*, the *Host_Object_Identifier_Types* may be mixed (for example, HOST and XSYS).

REMOVE and RESTORE DEV

Purpose

Use the REMOVE DEV command at the I/O operations API to configure a device or devices offline to one or more hosts.

Use the RESTORE DEV command at the I/O operations API to configure a device or devices online to one or more hosts.

Syntax

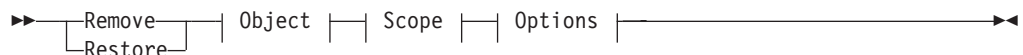

Object:



REMOVE and RESTORE DEV

Object_format

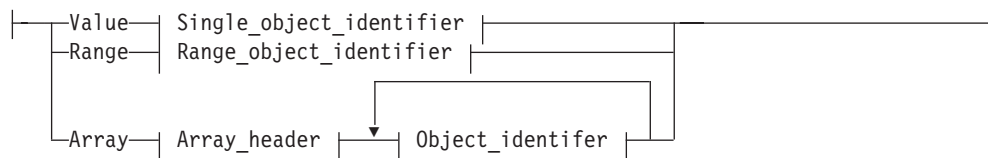

Single_object_identifier:

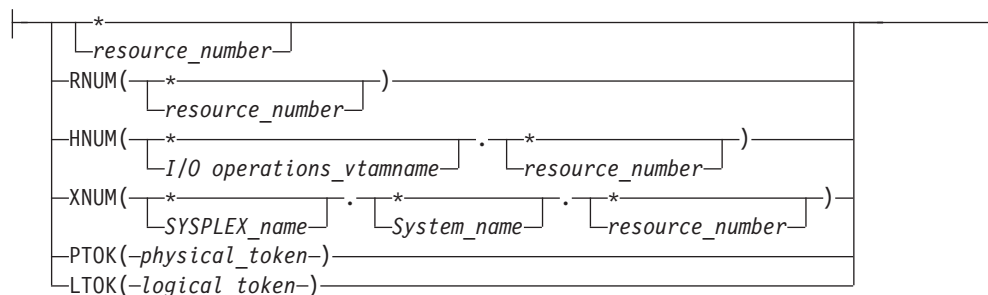

Range_object_identifier:

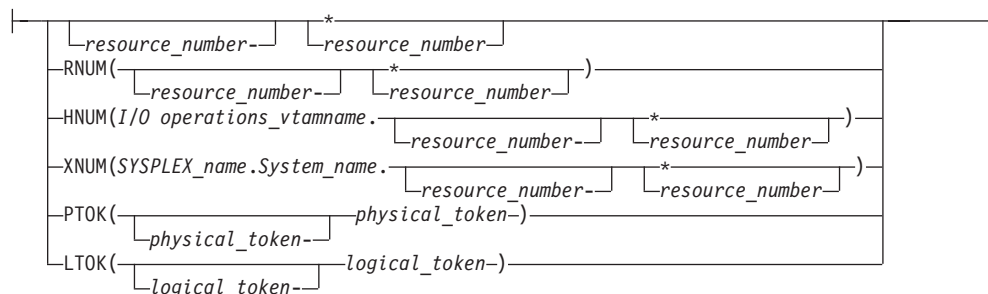

Scope:

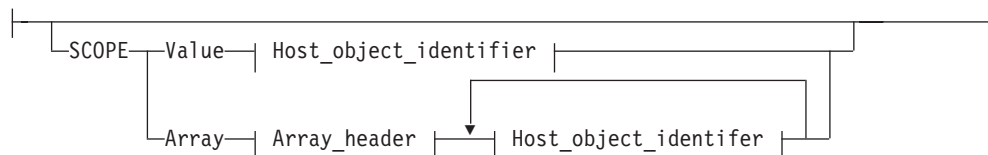

Host_object_identifier:

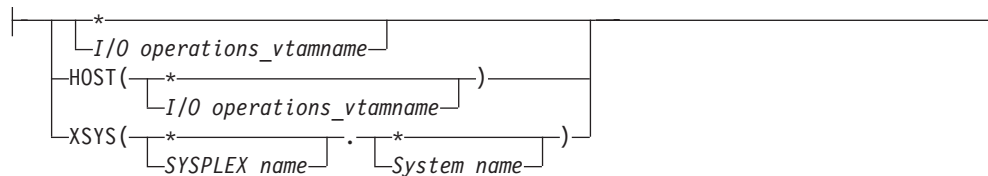

Process_options:

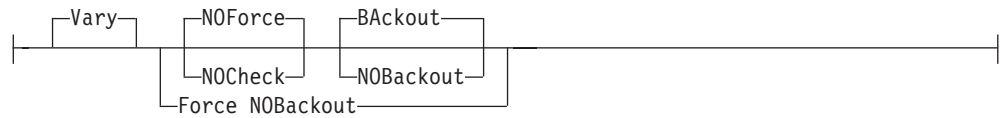
**Remove/Restore_command_options:****Output_options:****Parameters**

A host identifier type can be one of the following keywords:

Vary

This is the default option and it indicates that appropriate processing must be done at the host to support the REMOVE and RESTORE DEVICE commands.

Note: This does not mean that the paths to this device are varied.

NOVary

This option is not valid for the REMOVE and RESTORE DEVICE commands.

Force

This option says to execute the command in the best manner possible. For example, if one of the specified hosts does not respond, the command is still performed on all other hosts.

NOForce

This is the default option and indicates that if there is any failure, the command should not continue and a return and reason describing the failure will be returned.

NOCheck

The NOCheck option overrides the detection of two conditions that would cause the failure of the command under the default NOForce option:

1. Detection of systems in the scope of the command on which I/O operations is not operating.
2. Detection of downlevel ESCON Managers operating on systems in the scope of the command.

If either of these conditions is detected, a return code of 4 is returned.

BACKout

This is the default option and indicates that if any failure is reported by any of

REMOVE and RESTORE DEV

the participating systems, any successful REMOVE and RESTORE DEVICE actions for all the participating host systems will be backed out.

NOBackout

This option indicates that if any error condition is detected during the REMOVE and RESTORE DEVICE processing, I/O operations will not attempt to change any REMOVE and RESTORE DEVICE actions that have been performed.

CONDitional

This is the default option for both the REMOVE and RESTORE DEVICE commands. It indicates that no special Vary offline or Vary online action should be performed.

UNCONDitional

For the REMOVE DEVICE command, this option puts the specified devices immediately into pending offline status, even if the devices are currently active, allocated, or reserved.

For the RESTORE DEVICE command, this option brings the specified devices online, even if there are no paths to the devices, or if the devices are pending offline and boxed. This option is ignored if it is specified for a tape or a direct access device.

SHaRe

For the REMOVE DEVICE command, this option provides no function.

For the RESTORE DEVICE command, this option permits any device that supports multisystem assign to be shared among other processors. If the device does not support multisystem assign, this option is ignored.

REset

For the REMOVE DEVICE command, this option provides no function.

For the RESTORE DEVICE command, this option allows the device to be varied online even if it is currently in use by control unit initiated reconfiguration.

AutoSwitch

The AutoSwitch option is valid only for a tape device such as an IBM 3480 or 3490 (or equivalent). You use Restore Dev AutoSwitch to set the option on and Remove Dev AutoSwitch to set the option off.

Setting AutoSwitch on allows a tape device to be switched serially from one system to another in a sysplex environment without the need for operator intervention.

Note: A coupling facility is required for sysplex tape sharing to be available.

OUTputALL

This is the default and it allows all results from REMOVE and RESTORE DEVICE actions that have been performed (regardless of return code) to be returned to the API invoker.

OUTputERRor

This option allows only error results (that is, REMOVE and RESTORE DEVICE actions with a return code ≥ 4 , plus other errors that occurred during the processing of the command) to be returned to the API invoker.

OUTputNone

This option allows only the return and reason code (no text information) to be

REMOVE and RESTORE DEV

returned to the API invoker. If the return code from the command is ≥ 4 , a detailed message (IHVC00I, IHVC001I, or IHVC002I) is also returned.

Notes:

1. When ARRAY is the *Object_format_type*, the *Object_Identifier_Types* can be mixed and every *Object_Identifier_Type* must be an I/O resource type. For example, an HNUM and an XNUM entry can be in the same array.
2. The Array_header contains the number of elements in the array.
3. PTOK is valid with RANGE but you should be fully aware of PTOK structure. For example, RANGE PTOK could be used to specify all of the serial numbers of a certain type of device. However, certain PTOK values may cause unpredictable results with RANGE
4. When ARRAY is the *SCOPE_format_type*, the *Host_Object_Identifier_Types* can be mixed (HOST and XSYS).

Output

The format of the output from the REMOVE and RESTORE DEV command is as follows:

Offsets					
Dec	Hex	Type	Len	Name (Dim)	Description
0	(0)	STRUCTURE	80	VDCB_HDR	VDCB header
Control block identification and format					
0	(0)	CHARACTER	4	VDCH_ID	Eyecatcher, initialize to VDCB
4	(4)	UNSIGNED	2	VDCH_HLEN	VDCB Header length (bytes)
6	(6)	UNSIGNED	2	VDCH_RLEN	VDCB Row length (bytes)
8	(8)	UNSIGNED	4	VDCH_NR	Number of VDCB rows
12	(C)	UNSIGNED	4	VDCH_NHR	Number of host summary rows
16	(10)	UNSIGNED	1	VDCH_FMTID	Format of VDCB header, rows
17	(11)	CHARACTER	3	*	Reserved
20	(14)	CHARACTER	4	*	Reserved
Information on the command and options					
24	(18)	BITSTRING	2	VDCH_CMD	Vary Device command flags
		1... ..		VDCH_VOFF	1=VaryOFF Device
		.1.. ..		VDCH_VON	1=VaryON Device
		..1.		VDCH_VBKOUT	1=Vary Backout initiated
24	(18)	BITSTRING	1	*	Reserved
26	(1A)	BITSTRING	2	VDCH_OPTIONS	Vary Device options flags
		1... ..		VDCH_FORCE	1=Force specified
		.1.. ..		VDCH_NOFORCE	1=NOForce specified
		..1.		VDCH_BKOUT	1=BAckout specified
		...1		VDCH_NOBKOUT	1=NOBackout specified
	 1...		VDCH_NOCHECK	1=Nocheck specified
	1..		VDCH_COND	1=CONDitional specified
	1.		VDCH_UNCOND	1=UNConditonal specified
	1		VDCH_SHARE	1=SHare specified
		1... ..		VDCH_RESET	1=REset specified
		.1.. ..		VDCH_AUTOSW	1=AutoSwitch specified
		..11 1111		*	Reserved
28	(1C)	CHARACTER	4	*	Reserved
Invoker's system and user IDs					

REMOVE and RESTORE DEV

Offsets

Dec	Hex	Type	Len	Name (Dim)	Description
32	(20)	CHARACTER	16	VDCH_USER	System ID, User ID of invoker
32	(20)	CHARACTER	8	VDCH_SYSID	System ID
40	(28)	CHARACTER	8	VDCH_USRID	User ID
Information on primary responding host					
48	(30)	CHARACTER	8	VDCH_APPL	I/O operations VTAM application name
56	(38)	CHARACTER	16	VDCH_SYSPLEX	Sysplex and system names
56	(38)	CHARACTER	8	VDCH_SPLX	Sysplex name
64	(40)	CHARACTER	8	VDCH_SYST	System name
72	(48)	CHARACTER	4	VDCH_ESCMREL	SA OS/390 release
76	(4C)	CHARACTER	4	*	Reserved

Offsets

Dec	Hex	Type	Len	Name (Dim)	Description
0	(0)	STRUCTURE	296	VDCB_ROW	VDCB row
Row Format Code					
0	(0)	UNSIGNED	2	VDCR_FORMAT	Row format code
2	(2)	CHARACTER	2	*	Reserved
4	(4)	CHARACTER	4	*	Reserved
Information on responding host					
8	(8)	CHARACTER	8	VDCR_APPL	ESCM VTAM Application Name
16	(10)	CHARACTER	16	VDCR_SYSPLEX	Sysplex and system names
16	(10)	CHARACTER	8	VDCR_SPLX	Sysplex name
24	(18)	CHARACTER	8	VDCR_SYST	System name
Device Identification					
32	(20)	BITSTRING	2	VDCR_FLAGS	Vary Device flags
		1...		VDCR_RNUMV	1=RNUM is valid
		.1..		*	Reserved
		..1.		*	Reserved
		...1 1111		*	Reserved
		1...		VDCR_COUPL	1=Device is a coupling facility
		.1..		VDCR_NOVARY	1=Don't vary device for row
		..1.		VDCR_NOTFND	1=Device not found for host
		...1		VDCR_BKOUT	1=Backout attempted, message present
	 1111		*	Reserved
34	(22)	UNSIGNED	2	VDCR_DEVNUM	Device number
36	(24)	BITSTRING	4	VDCR_SCPSTS	Operating system state
40	(28)	CHARACTER	32	VDCR_PTKN	Physical token
72	(48)	CHARACTER	32	VDCR_LTKN	Logical token
Vary results					
104	(68)	CHARACTER	96	VDCR_VRESULTS	
104	(68)	BITSTRING	2	VDCR_VFLAGS	Vary Flags
		1...		VDCR_VMVS_MSG	1=Vary message is MVS
		.1..		VDCR_VDBCS	1=Vary message is DBCS
104	(68)	BITSTRING	1	*	Reserved
106	(6A)	CHARACTER	2	*	Reserved
108	(6C)	UNSIGNED	4	VDCR_VESCMRC	I/O operations severity code (used for backout, message screen)

Following set by L/P from MVS VARYDEV macro output and are valid only when VDCR_NOVARY flag is '0'B.

112	(70)	UNSIGNED	4	VDCR_VMVSRC	Return code from VARYDEV macro
-----	------	----------	---	-------------	--------------------------------

Offsets					
Dec	Hex	Type	Len	Name (Dim)	Description
116	(74)	UNSIGNED	4	VDCR_VMVSRSN	Reason code from VARYDEV macro
120	(78)	CHARACTER	80	VDCR_VMVSMSG	Msg from VARYDEV macro or I/O operations based on macro RC/RSN
Backout results					
200	(C8)	CHARACTER	96	VDCR_BRESULTS	
200	(C8)	BITSTRING	2	VDCR_BFLAGS	Backout flags
		1... ..		VDCR_BMVS_MSG	1=backout message is MVS
		.1... ..		VDCR_BDBCS	1=backout message is DBCS
200	(C8)	BITSTRING	1	*	Reserved
202	(CA)	CHARACTER	2	*	Reserved
204	(CC)	UNSIGNED	4	VDCR_BESCMRC	ESCM Severity code
Following set by L/P from MVS VARYDEV macro output and are valid only when ESCM backout occurs (VDCH_BKOUT=1) and there are no comm errors reported in DVHS_BXSUM.					
208	(D0)	UNSIGNED	4	VDCR_BMVSRC	Return code from VARYDEV macro
212	(D4)	UNSIGNED	4	VDCR_VMVSRSN	Reason code from VARYDEV macro
216	(D8)	CHARACTER	80	VDCR_VMVSMSG	Message from VARYDEV macro or I/O operations based on macro RC/RSN

WRITEFILE

Purpose

Use the WRITEFILE command at the I/O operations API to store a saved switch configuration at the switch specified in the command.

To use the WRITEFILE command, the switch must be allocated, or attached, to the issuing I/O operations.

Syntax

►►—WRITEFILE—*filename*—*filedescriptor*—*datablock*—►►

Parameters

filename

Specify the file name in 1 through 8 valid EBCDIC codes. Valid codes are uppercase alphabetical characters (A–Z), digital characters (0–9), and 2 special characters: the underscore (_) and the hyphen (-). However, the following file names are not valid: AUX, COM n (where $n=1–4$), CON, LPT n (where $n=1–3$), NUL, or PRN.

filedescriptor

Specify the file descriptor in exactly 24 characters in the range X'40' through X'FE'.

datablock

Specify a 20480-byte data block in the format listed under the Query Switch command. The data block allows an 80-byte record for 256 ports. Specify the ports in ascending hexadecimal order.

WRITEFILE

Usage

- A maximum number of saved switch configurations can be stored at a switch. At an IBM Director, you can store up to 15 saved configurations. In addition, you can load and restore the IPL file, which is supplied with each Director and is activated automatically when the unit is powered on.
- You can only write the IPL file if the Active=Save Mode at the switch is disabled. If the mode is disabled, any changes being made to the active configuration at the switch are not saved. The mode setting is displayed on the screen of the switch console. The status is also returned in the QFILAS field in the output returned with the Q F * command.
- You must specify the switch device number in the data block., (Unlike the WRITESWCH command, the switch device number in the Writefile command must be the same in each record.)
- If you do not want to write an entire block, you can edit an existing one. For example, you can use the Query File command to get a file, edit it, and then use the WRITEFILE command to store it.

Output

Each 80-byte record of the WRITEFILE data block has the following format:

Offsets					
Dec	Hex	Type	Len	Name (Dim)	Description
0	(0)	STRUCTURE	80	IHV\$WTFL	Writefile record
0	(0)	BITSTRING	1	WTFLFLAG1	flag byte 1
		1... ..		WTFLLAST	last bit - end of list indicator (0 = more records in list) (1 = last record in list)
		.1.. ..	*		reserved
		..11 ..		WTFLFORM	Format id bits 00 = format 0 (original format)
	 1111	*		reserved
1	(1)	BITSTRING	1	*	reserved
2	(2)	UNSIGNED	2	WTFLSWIT	switch device number
4	(4)	CHARACTER	48	WTFLLAIB	switch port information block
4	(4)	CHARACTER	2	*	reserved
6	(6)	UNSIGNED	1	LAIBADDR	port address
7	(7)	CHARACTER	1	*	reserved
8	(8)	BITSTRING	4	LAIBDESC	port descriptor bits
		1... ..		LAIBUNMP	port implemented bit (0 = implemented port) (1 = unimplemented port)
		.1.. ..		LAIBFBIT	port blocked bit (0 = port is not blocked) (1 = port is blocked)
		..1.		LAIBIC	port prohibit connection (0 = no prohibits for this port) (1 = prohibits defined)
		...1		LAIBSBIT	port connection bit (0 = port is not connected) (1 = port is connected)
8	(8)	BITSTRING	3	*	reserved
12	(C)	CHARACTER	2	*	reserved
14	(E)	UNSIGNED	1	LAIBSADR	static connection address
15	(F)	CHARACTER	5	*	reserved
20	(14)	BITSTRING	32	LAIBICM	link ICM
52	(34)	CHARACTER	24	WTFLNAME	port logical name
76	(4C)	CHARACTER	4	*	reserved
80	(50)	CHARACTER		WTFLEND	END OF WTFL

WRITEPORT

Purpose

Use the Writeport command at the I/O operations API to define or to change the connectivity attributes for a single port on a specified switch.

Syntax

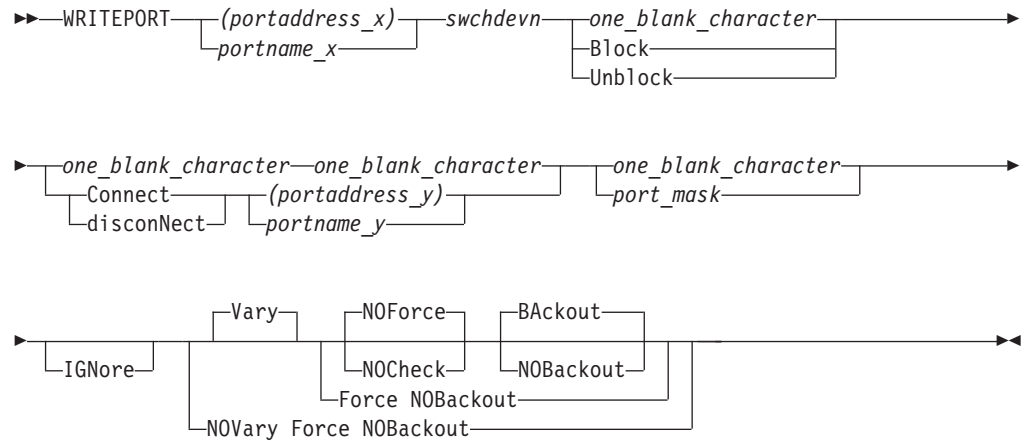

Parameters

(portaddress_x) | portname_x

Specifies the target port by its port address (enclosed in parentheses) or by its port name.

swchdevn | *

Specifies the target switch device number. The switch must be allocated to, or attached to, the issuing I/O operations.

one_blank_character | Block | Unblock

Specifies one of the following: the blocking attribute should be unchanged (X'40'); the port should be blocked; the port should be unblocked.

one_blank_character | Connect | disconNect

Specifies one of the following: the dynamic connection attribute should be unchanged (X'40'); the port should be statically connected to the port specified in the next operand; the port should be disconnected from that port.

(portaddress_y) | portname_y

Specifies the other port in the static connection by its port address or port name.

one_blank_character | port_mask

A blank character specifies that the allow and prohibit attributes of port_x should be unchanged. The 256-character (32-byte) mask specifies an A (Allow) or a P (Prohibit) as the attribute for each port in the range X'00–FF'. The character representing port_x must and all unimplemented ports must be P, while the character representing the control unit port (CUP) must be A

IGNore

You must specify this option when an Inter-Switch-Link port (E_Port) is involved. Otherwise the command is rejected with return code 8 and reason

WRITEPORT

code X'49'. The reason is I/O operations can no longer guarantee "safe-switching" when an E_Port is involved.

"Safe-switching" sets the paths and devices online or offline when the path from a chpid to a device either becomes valid or is no longer valid because of a port manipulation.

Vary

This is the default option and it indicates that appropriate processing must be done at the host to support the REMOVE and RESTORE CHP commands.

NOVary

This option is not valid for the WRITEPORT command.

Force

This option says to do the command in the best manner possible. For example, if one of the specified hosts does not respond, the command is still performed on all other hosts.

NOForce

This is the default option and indicates that if there is any failure, the command should not continue and a return call and reason describing the failure will be returned.

NOCheck

The NOCheck option overrides the detection of two conditions that would cause the failure of the command under the default NOForce option:

1. Detection of systems in the scope of the command on which I/O operations is not operating.
2. Detection of downlevel I/O operations's operating on systems in the scope of the command.

If either of these conditions is detected, a return code of 4 is returned.

BACKout

This is the default option and indicates that if any failure is reported by any of the participating systems, any successful WRITEPORT actions for all the participating host systems will be backed out.

NOBackout

This option indicates that if any error condition is detected during the WRITEPORT processing, I/O operations will not attempt to change any WRITEPORT actions that have been performed.

Usage

Using the Writeport command is a tool that helps you simplify the installation, set up, and recovery of a switch's configuration. Note, however, that the WRITESWCH command lets you manipulate attributes of all the ports on a switch.

The number and placement of implemented ports depends on the model of the switch. You can display the addressable ports with the commands described under "QUERY SWITCH" on page 193.

Also, see *Planning for the 9032 Enterprise Systems Connection Director* or *Planning for the 9033 Enterprise Systems Connection Director* for CUP information pertinent to the ESCON Directors.

Examples

Here is a segment of an MVS REXX EXEC that contains the command WRITEPORT (C3) 0500 B C (C1)

```
IHVRC = 0                /* Return code; it must be      */
/* called IHVRC.          */
/*                        */
IHVREAS = 0             /* Reason code; it must be     */
/* called IHVREAS.       */
/*                        */
IHVRESP = ' '          /* Response area; it must be   */
/* called IHVRESP.      */
/*                        */
cmd = 'WRITEPORT'      /* Command name (required)     */
opr1 = '(C3)'          /* Port address/port name (required) */
opr2 = '0500'         /* Switch device number (required) */
opr3 = 'BLOCK'        /* Block/Unblock/blank (required) */
opr4 = 'CONNECT'     /* Connect/disconnect/blank (required) */
opr5 = '(C1)'        /* Port/Port name/blank (required) */
opr6 = ' '            /* 256 characters or 1 blank (required) */
/*                        */
opt1 = 'NOFORCE'      /* Force/NOForce (options)     */
opt2 = 'VARY'         /* Vary/NOVary (options)       */
opt3 = 'BACKOUT'     /* BAckout/NOBackout (options) */
/*                        */
ADDRESS LINK 'IHVAPI' cmd opr1 opr2 opr3 opr4 opr5 opr6 opt1 opt2 opt3
/*****/
```

The following example is one way to construct the 256-character allow or prohibit string. Port C3 is allowed to communicate to every other implemented port. The variables M1, M2, M3, and M4 are used to represent 64 characters each. The numbers in the comment lines are the ports.

```
/*CCCCCCCCCCCCCCCCDDDDDDDDDDDDDDDEEEEEEEEEEEEEEEEEFFFFFFFFFFF*/
/*0123456789ABCDEF0123456789ABCDEF0123456789ABCDEF0123456789ABCDEF*/
/*00000000000000001111111111111111222222222222222333333333333333*/
/*0123456789ABCDEF0123456789ABCDEF0123456789ABCDEF0123456789ABCDEF*/
M1= 'PPPPPPPPPPPPPPPPPPPPPPPPPPPPPPPPPPPPPPPPPPPPPPPPPPPPPPPPPPPP'

/*44444444444444445555555555555555666666666666666777777777777777*/
/*0123456789ABCDEF0123456789ABCDEF0123456789ABCDEF0123456789ABCDEF*/
M2= 'PPPPPPPPPPPPPPPPPPPPPPPPPPPPPPPPPPPPPPPPPPPPPPPPPPPPPPPPPPPP'

/*88888888888888889999999999999999AAAAAAAAAAAAAAAABBBBBBBBBBBBBB*/
/*0123456789ABCDEF0123456789ABCDEF0123456789ABCDEF0123456789ABCDEF*/
M3= 'PPPPPPPPPPPPPPPPPPPPPPPPPPPPPPPPPPPPPPPPPPPPPPPPPPPPPPPPPPPP'

/*CCCCCCCCCCCCCCCCDDDDDDDDDDDDDDDEEEEEEEEEEEEEEEEEFFFFFFFFFFF*/
/*0123456789ABCDEF0123456789ABCDEF0123456789ABCDEF0123456789ABCDEF*/
M4= 'AAPAAAAAAAAAAAAAAAAAAAAAAAAAAAAAAAAAAAAAAAAAAAAAAAAAAAAAAAAAPPAP'
```

This statement concatenates the four variables into the 256-character operand used in the command:

```
opr6 = M1 || M2 || M3 || M4
```

The attributes of the remaining ports must be determined according to the configuration requirements of the user's computer complex.

Example of Modifying Allow or Prohibit Attributes: This section shows examples of how to use the WRITEPORT command to modify an Enterprise System Connection Director so that:

- Port C2 is prohibited from dynamically connecting with ports C4 and C6.
- Port C6 is prohibited from dynamically connecting with port C8.

the connectivity attributes for every implemented port on the specified switch. Therefore, construct the allow or prohibit string with special care.

It is advisable to use the active attribute string as a starting point. Sending the Query Switch command is a convenient way for an application program to obtain the active attribute string.

WRITESWCH

Purpose

Use the WRITESWCH command at the API to make changes (update) up to 512 addressable ports on any number of switches that are allocated to, or attached to, the issuing I/O operations. This command is available only at the API because it requires input in hexadecimal format.

Syntax

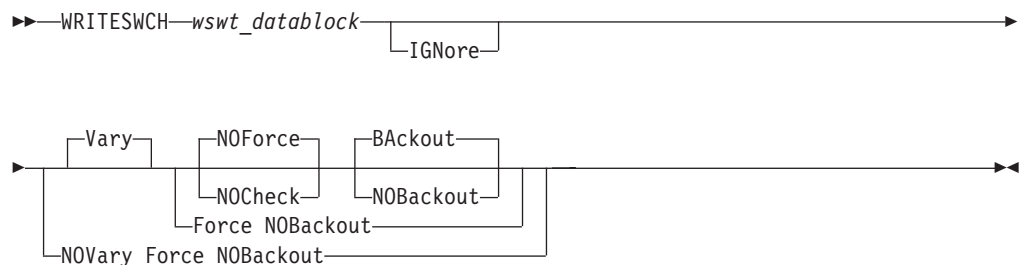

Parameters

IGNore

You must specify this option when an Inter-Switch-Link port (E_Port) is involved. Otherwise the command is rejected with return code 8 and reason code X'49'. The reason is I/O operations can no longer guarantee "safe-switching" when an E_Port is involved.

"Safe-switching" sets the paths and devices online or offline when the path from a chipid to a device either becomes valid or is no longer valid because of a port manipulation.

Vary

This is the default option and it indicates that appropriate processing must be done at the host to support the WRITESWCH command.

NOVary

This option is not valid for the WRITESWCH command.

Force

This option says to do the command in the best manner possible. For example, if one of the specified hosts does not respond, the command is still performed on all other hosts.

NOForce

This is the default option and indicates that if there is any failure, the command should not continue and a return and reason describing the failure will be returned.

WRITESWCH

NOCheck

The NOCheck option overrides the detection of two conditions that would cause the failure of the command under the default NOForce option:

1. Detection of systems in the scope of the command on which I/O operations is not operating.
2. Detection of downlevel I/O operations's operating on systems in the scope of the command.

If either of these conditions are detected, a return code of 4 is returned.

Backout

This is the default option and indicates that if any failure is reported by any of the participating systems, any successful WRITESWCH actions for all the participating host systems will be backed out.

NOBackout

This option indicates that if any error condition is detected during the WRITESWCH processing, I/O operations will not attempt to change any WRITESWCH actions that have been performed.

Output

WSWT datablock

Enter the following data block.

Offsets					
Dec	Hex	Type	Len	Name (Dim)	Description
0	(0)	STRUCTURE	80	WSWT	
0	(0)	BITSTRING	1	WSWTFLAG1	Flag byte 1
		1... ..		WSWTLAST	Last bit - end of variable length list indicator (0=more records in list) (1=last record in list)
		.1.. ..		WSWTMDPT	Midport bit - if bit is set indicates that this port is a midport on a defined chain.
		..11 ..		WSWTFORM	Format (00=original format)
	 1..		WSWTMBSR	Modify block state request (0=no change to block state) (1=change block state)
	1..		WSWTMCSR	Modify connect state request (0=no change to connect state) (1=change connect state)
	1.		WSWTLNVB	Logical name valid bit (0=ignore logical name info) (1=write logical name)
	1		WSWTCIVB	Chain information valid bit (0=ignore chain information) (1=set up chain)
1	(1)	BITSTRING	1	WSWTFLAG2	Flag byte 2
		1... ..		WSWTMMR	Modify mask request (0=no change to current PDCM) (1=change current PDCM)
		.1.. ..		WSWTAMR	And mask request (0=no change to current PDCM) (1=AND given PDCM with the current PDCM)
		..1.		WSWTOMR	Or mask request (0=no change to current PDCM) (1=OR given PDCM with the current PDCM)
		...1 1111		*	Reserved
2	(2)	UNSIGNED	2	WSWTSWIT	Switch device number

Offsets					
Dec	Hex	Type	Len	Name (Dim)	Description
4	(4)	CHARACTER	48	WSWTLAIB	Switch port information block
4	(4)	CHARACTER	1	*	Reserved
5	(5)	UNSIGNED	1	LAIBNUMB	Port number
6	(6)	UNSIGNED	1	LAIBADDR	Port address
7	(7)	CHARACTER	1	*	Reserved
8	(8)	BITSTRING	4	LAIBDESC	Port descriptor bits
		1...		LAIBUNMP	Port unimplemented bit (0=port is implemented) (1=port is not implemented)
		.1..		LAIBFBIT	Port blocked bit (0=port not blocked) (1=port is blocked)
		..1.		*	Reserved
		...1		LAIBSBIT	Port connection bit (0=port not connected) (1=port is connected)
	 1111		*	Reserved
9	(9)	BITSTRING	3	*	Reserved
12	(C)	CHARACTER	2	*	Reserved
14	(E)	UNSIGNED	1	LAIBSADR	Static connection port address
15	(F)	CHARACTER	5	*	Reserved
20	(14)	CHARACTER	32	LAIBICM	Port prohibit dynamic connection mask (PDCM)
52	(34)	CHARACTER	24	WSWTNAME	Port logical name
76	(4C)	UNSIGNED	2	WSWTCSWIT	Switch device number for the chained switch
78	(4E)	UNSIGNED	1	WSWTCPORT	Chained port address
79	(4F)	BITSTRING	1	*	Reserved
80	(50)	CHARACTER		WSWTEND	End of WSWT

How to Set Up the Datablock

By using the described datablock, an API user can change the connectivity attributes of a port. The changes that are requested are controlled by Request bits in the beginning of the block that must be used in order to say what type of action is requested. If no request bits are set then the given block is skipped and treated as a no-op.

Listed below are the commands that can be processed with 1 WSWT block. The bits that must be set are also listed as well as the data required to make the change.

As stated earlier, you can make more than one change on a port block by setting the appropriate combination of bits. For example, you can effectively enter a Block and a Connect command at the same time by making sure that all the bits that are relevant for both commands are set on the same block.

Block

WSWTMBSR

Must be set to 1 to indicate that the block state should be changed.

LAIBFBIT

Must be set to 1 to indicate that the port should be blocked.

LAIBADDR

Contains the port address.

WRITESWCH

WSWTSWIT

Contains the switch that the port address is on.

WSWTFORM

Must be set to 00.

Unblock

WSWTMBSR

Must be set to 1 to indicate that the block state should be changed.

LAIBFBIT

Must be set to 0 to indicate that the port should be unblocked.

LAIBADDR

Contains the port address.

WSWTSWIT

Contains the switch that the port address is on.

WSWTFORM

Must be set to 00.

Connect

WSWTMCSR

Must be set to 1 to indicate that the connection state should be changed.

LAIBSBIT

Must be set to 1 to indicate that the port should be connected.

LAIBADDR

Contains the port address.

LAIBSADR

Contains the port address that LAIBADDR should be connected to.

WSWTSWIT

Contains the switch that the port addresses are on.

WSWTFORM

Must be set to 00.

Disconnect

WSWTMCSR

Must be set to 1 to indicate that the connection state should be changed.

LAIBSBIT

Must be set to 0 to indicate that the port should be disconnected.

LAIBADDR

Contains the port address.

LAIBSADR

Contains the port address that LAIBADDR should be disconnected from.

WSWTSWIT

Contains the switch that the port addresses are on.

WSWTFORM

Must be set to 00.

Chain

WSWTCIVB

Must be set to 1 to indicate that the chain information is valid and you want to change it.

WSWTMDPT

Must be set to 1 to indicate that this port is the midport on the chain.

WSWTMCSR

Must be set to 1 to indicate that the connection state should be changed.

LAIBSBIT

Must be set to 1 to indicate that the port should be chained by setting a connection between LAIBADDR and LAIBSADR.

LAIBADDR

Contains the port address.

LAIBSADR

Contains the port address that LAIBADDR should be connected to.

WSWTSWIT

Contains the switch that the port addresses are on.

WSWTCPORT

Contains the chained port address that LAIBADDR should be chained to.

WSWTCSWIT

Contains the switch that the chained port address is on.

WSWTFORM

Must be set to 00.

Unchain**WSWTCIVB**

Must be set to 1 to indicate that the chain information is valid and you want to change it.

WSWTMDPT

Must be set to 1 to indicate that this port is the midport on the chain.

WSWTMCSR

Must be set to 1 to indicate that the connection state should be changed.

LAIBSBIT

Must be set to 0 to indicate that the port should be unchained by disconnecting LAIBADDR and LAIBSADR.

LAIBADDR

Contains the port address.

LAIBSADR

Contains the port address that LAIBADDR should be disconnected from.

WSWTSWIT

Contains the switch that the port addresses are on.

WRITESWCH

WSWTCPORT

Contains the chained port address that LAIBADDR should be unchained from.

WSWTCSWIT

Contains the switch that the chained port address is on.

WSWTFORM

Must be set to 00.

Write

WSWTLNVB

Must be set to 1 to indicate that the logical name field is valid.

LAIBADDR

Contains the port address.

WSWTNAME

Contains the logical name that should be assigned to the port address given in LAIBADDR.

WSWTSWIT

Contains the switch that the port addresses are on.

WSWTFORM

Must be set to 00.

Modify PDCM

WSWTMMR

Must be set to 1 to indicate that the PDCM should be modified.

LAIBADDR

Contains the port address.

LAIBICM

Contains the new PDCM for the given port.

WSWTSWIT

Contains the switch that the port addresses are on.

WSWTFORM

Must be set to 00.

And PDCM

WSWTAMR

Must be set to 1 to indicate that the given PDCM should be AND'ed with the current PDCM.

LAIBADDR

Contains the port address.

LAIBICM

Contains the PDCM to be AND'ed for the given port.

WSWTSWIT

Contains the switch that the port addresses are on.

WSWTFORM

Must be set to 00.

Or PDCM**WSWTOMR**

Must be set to 1 to indicate that the given PDCM should be OR'ed with the current PDCM.

LAIBADDR

Contains the port address.

LAIBICM

Contains the PDCM to be OR'ed for the given port.

WSWTSWIT

Contains the switch that the port addresses are on.

WSWTFORM

Must be set to 00.

Usage

- The WSWT datablock that you enter is a series of WSWT structures that I/O operations processes sequentially. Be sure to take this into account. For example, assume ports *FB* and *EA* are statically connected, and you want ports *CO* and *EA* to be statically connected instead.

Note: If the WSWT datablock contains an "AND PDCM" or an "OR PDCM" bit setting, there may only be 1 "AND PDCM" / "OR PDCM" and no "MODIFY PDCM", in the datablock.

1. In the data block, disconnect *FB* and *EA* first.
2. Then, connect *CO*, and *EA*.

If you reverse the order, the command will fail because *EA* is already statically connected.

- If you specify Vary, I/O operations varies the relevant paths in all the WSWT structures offline first. If these operations are all successful or if you specified Force, the program then sends all the WSWT structures to the affected switch(es). If these operations are successful, I/O operations then varies the appropriate paths online.
- The Writeswch command is used implicitly when you activate a switch configuration in matrix format by using either the I/O operations ISPF dialog or the workstation feature.

WRITESWCH

Part 5. Status Display Facility Definitions

Chapter 5. SDF Initialization Parameters	221	AOFTREE	233
DCOLOR	221	PANEL	236
DPFKnn	222	STATUSFIELD	237
DPFKDESC1	223	STATUSTEXT	240
DPFKDESC2	224	TEXTFIELD	241
EMPTYCOLOR	224	TEXTTEXT	243
ERRCOLOR	225	PFKnn.	244
INITSCRN	226	ENDPANEL	245
MAXOPS	226	Example SDF Definition	245
PFKnn.	227	SDF Tree Structure Definitions.	245
PRIORITY	228	SDF Panel Definitions	247
PRITBSZ	230	SDF Initialization Parameters in AOFINIT	251
PROPDOWN	230	SDF Status Detail Definitions	252
PROPUP	231	Chapter 7. SDF Commands	253
SCREENSZ	231	SDFTREE.	253
TEMPERR	231	SDFPANEL	254
Chapter 6. SDF Definition Statements	233	SCREEN	255

This part describes the definitions for the status display facility (SDF). Refer to *System Automation for OS/390 User's Guide* for information on how to set up the display panels and on how to use SDF.

Enter the *SDF initialization* parameters in the DSIPARM member of AOFINIT. It is recommended that you use the supplied display defaults.

Chapter 5. SDF Initialization Parameters

The SDF initialization parameters are:

DCOLOR

Default status descriptor color

DPFK_{nn}

PF key settings for detail status panel

DPFKDESC1

PF key descriptions for detail status panel

DPFKDESC2

PF key descriptions for detail status panel

EMPTYCOLOR

Default color for status component without a status descriptor

ERRCOLOR

Default color for status component without a tree structure entry

INITSCRN

Initial screen

MAXOPS

Maximum operator logon limit

PFK_{nn}

Default PF key settings

PRIORITY

Priority and color definitions

PRITBSZ

Priority and color table size

PROPDOWN

Propagate status downward in SDF tree structure

PROPUP

Propagate status upward in SDF tree structure

SCREENSZ

Screen size

TEMPERR

Temporary error limit value

DCOLOR

Purpose

The DCOLOR parameter defines the color used for a status descriptor that is outside any of the defined priority and color ranges. This parameter is optional. If not coded, the program default color is White.

Syntax

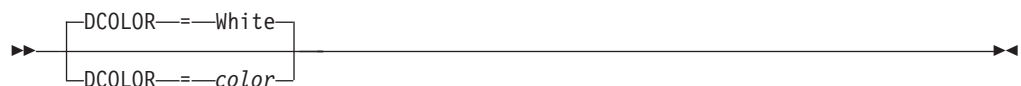

Parameters

color

The color used for the status descriptor. This value can be one of the following:

DCOLOR

R	Red
P	Pink
Y	Yellow
T	Turquoise
G	Green
B	Blue
W	White

The default is White.

Restrictions and Limitations

In member AOFINIT, if the number of PRIORITY parameters (see page 228) exceeds the default PRITBLSZ parameter value of 7 (see page 230), the DCOLOR parameter must follow the PRITBLSZ parameter.

Usage

The recommended value for DCOLOR is White. This value is supplied in SA OS/390 SAOFNPRM member AOFINIT. This value does not conflict with existing status and color definitions.

Examples

```
DCOLOR = WHITE
```

DPFKnn

Purpose

The DPFKnn parameter defines all PF keys unique to a detailed status panel.

Syntax

```
▶▶—DPFKnn—=—command—▶▶
```

Parameters

nn PF key number. Values can range from 1 to 24. You can modify all PF key definitions.

command

The command executed when the defined PF key is pressed.

Restrictions and Limitations

This parameter must be specified on one line. Continuation lines are not allowed. The total length of the parameter and parameter value specification cannot exceed 72 characters.

PF keys defined by DPFK*nn* statements are only active when the detail panel is displayed and override the default settings defined with the PFKnn parameter.

Usage

Table 13 shows variables that you can use as part of the command specified on the DPFKnn parameter.

Note: Using these variables (that is, translating variables into values) is valid on a detail status or status panel when the cursor is on a status field.

Table 13. Variables for the DPFKnn Command

Variable	Translated To
&COMP or &RESOURCE	The component name
&ROOT or &SYSTEM	Root or system
&SYSDATE	System date
&SYSTIME	System time
&IN or &INFO	Detail entry information displayed on the status panel
&DATE	The date the detail entry was added
&TIME	The time the detail entry was added
&SENDERID	The reporter submitting the detail entry
&SNODE or &SENDERNODE	The node of the reporter submitting the detail entry
&DA or &DATA or &DSPDETL	The actual message text
&RV or &REFVALUE	The reference value of the detail entry
&PR or &PRIORITY	The priority of the detail entry
&CO or &COLOR	The color of the detail entry
&HI or &HIGHLITE	The highlight level of the detail entry
&RESAPPL or &COMPAPPL	The component name and the alternate component name if used to queue the status
&QCOMP	The component name to which the status was queued by SDF
&DCOMP	The displayed component name

Examples

```
DPFK9 = SCREEN VTAMSTAT
```

DPFKDESC1

Purpose

The DPFKDESC1 parameter defines the first part of the PF key description appearing at the bottom of the detail screen. This text is concatenated with the text defined with the DPFKDESC2 parameter.

Syntax

```
▶▶—DPFKDESC1—==—text—◀◀
```

Parameters

text

The text of the detail PF key description. The length of text allowed for this parameter depends on the total parameter length limit (72 characters) and the total text length limit defined by DPFKDESC1 and DPFKDESC2 (80 characters). For example, when defining a detail PF key description that is 79 characters long, you can define the first 60 characters of text on DPFKDESC1 and the remainder of the text on DPFKDESC2.

DPFKDESC1

Restrictions and Limitations

- This parameter must be specified on one line. Continuation lines are not allowed. The total length of the parameter and parameter value specification cannot exceed 72 characters.
- The total length of the PF key description defined by DPFKDESC1 and DPFKDESC2 cannot exceed 80 characters.

Examples

```
DPFKDESC1=PF3=RET      6=ROLL 7=UP 8=DN 9=AST 10=DEL
```

DPFKDESC2

Purpose

The DPFKDESC2 parameter defines the second part of the PF key description appearing at the bottom of the detail screen. This text is concatenated with the text defined with the DPFKDESC1 parameter.

Syntax

```
▶▶—DPFKDESC2—==—text—————▶▶
```

Parameters

text

The text of the continued PF key description, begun in a previous DPFKDESC1 statement. The length of the text depends on the length specified on the previous DPFKDESC1 statement, because the total description text defined by DPFKDESC1 and DPFKDESC2 cannot exceed 80 characters.

Restrictions and Limitations

- This parameter must be specified on one line. Continuation lines are not allowed. The total length of the parameter and parameter value specification cannot exceed 72 characters.
- The total length of the PF key description defined by DPFKDESC1 and DPFKDESC2 cannot exceed 80 characters.

Examples

```
DPFKDESC2=11=BOT 12=TOP
```

EMPTYCOLOR

Purpose

The EMPTYCOLOR parameter defines the color displayed for a status component that has no status descriptor associated with it. This parameter is optional. If not coded, the default color is Blue.

Syntax



Parameters

color

The color used for the status descriptor. This value can be one of the following:

R	Red
P	Pink
Y	Yellow
T	Turquoise
G	Green
B	Blue
W	White

The default is Blue.

Usage

The recommended value for EMPTYCOLOR is Blue. This value is supplied in SA OS/390 SAOFNPRM member AOFINIT. This value does not conflict with existing status and color definitions. This parameter can be overridden in the AOF TREE member.

Examples

```
EMPTYCOLOR = BLUE
```

ERRCOLOR

Purpose

The ERRCOLOR parameter defines the color displayed for a status component that does not have a corresponding entry in the SDF tree structure.

This parameter is optional. If not coded, the default color is White.

Syntax



Parameters

color

The color used for the status component. This value can be one of the following:

R	Red
P	Pink
Y	Yellow
T	Turquoise

ERRCOLOR

G	Green
B	Blue
W	White

The default is White.

Examples

```
ERRCOLOR = YELLOW
```

INITSCRN

Purpose

The INITSCRN parameter defines the initial panel displayed by SDF.

Syntax

```
▶▶—INITSCRN—=panel_name————▶▶
```

Parameters

panel_name

Any valid alphanumeric name with maximum length of eight.

Usage

If you change the name of the initial panel defined in the AOFPNLS member of the NetView DSIPARM data set, you must also change the panel name in the INITSCRN parameter.

Examples

```
INITSCRN = SYSTEMA1
```

MAXOPS

Purpose

The MAXOPS parameter defines the maximum number of logged-on operators that can use the SDF. This parameter is optional. If not coded, a program default of 30 is used.

Syntax

```
▶▶—MAXOPS—=30————▶▶  
▶▶—MAXOPS—=number————▶▶
```

Parameters

number

The number of maximum operators. Values can range from 1 to 9999999. The default is 30.

Usage

If the number of operators trying to use the SDF is more than the number defined in MAXOPS, additional operators are denied access to the SDF, because the dynamic update facility keeps an internal count of logged-on operators.

Examples

MAXOPS = 35

PFKnn

Purpose

The PFKnn parameter defines the default PF key settings for SDF panels.

Syntax

▶▶—PFKnn—=—*command*—▶▶

Parameters

nn Values can range from 1 to 24.

command

The command issued when the defined PF key is pressed.

Restrictions and Limitations

This parameter must be specified on one line. Continuation lines are not allowed. The total length of the parameter and parameter value specification cannot exceed 72 characters.

Usage

Table 14 shows the variables that can be used as part of the command specified on the PFKnn parameter.

Note: Use of these variables (that is, their appropriate translation from variables to values) is valid on a detail status panel or on a status panel when the cursor is on a status field.

Table 14. Variables for the PFKnn Command

Variable	Translated To
&COMP or &RESOURCE	The status component
&ROOT or &SYSTEM	Root or system
&SYSDATE	System date
&SYSTIME	System time
&IN or &INFO	Detail entry information displayed on the status panel
&DATE	The date the detail entry was added
&TIME	The time the detail entry was added
&SENDERID	The reporter submitting the detail entry
&SNODE or &SENDERNODE	The node of the reporter submitting the detail entry
&DA or &DATA or &DSPDETL	The actual message text
&RV or &REFVALUE	The reference value of the detail entry
&PR or &PRIORITY	The priority of the detail entry
&CO or &COLOR	The color of the detail entry

PFKnn

Table 14. Variables for the PFKnn Command (continued)

Variable	Translated To
&HI or &HIGHLIGHT	The highlight level of the detail entry

Examples

MVS D A,TSO is issued when PF4 is pressed with the cursor placed on the TSO entry on the status screen: PFK4 =MVS D A,&INFO

PRIORITY

Purpose

The PRIORITY parameter defines the relationship between colors and priority ranges. This parameter is optional. If not coded, program defaults are used.

Syntax

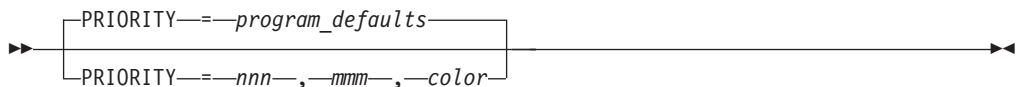

Parameters

nnn

The lower limit of the priority range. This value can be any valid number between 001 and 99999999.

mmm

The upper limit of the priority range. This value can be any valid number between 001 and 99999999 and equal to or greater than the value specified in *nnn*.

color

The color used for a particular priority range. This value can be one of the following:

R	Red
P	Pink
Y	Yellow
T	Turquoise
G	Green
B	Blue
W	White

program_defaults

These are:

Priority Range	Color
001 to 199	RED
200 to 299	PINK
300 to 399	YELLOW
400 to 499	TURQUOISE
500 to 599	GREEN
600 to 699	BLUE

Restrictions and Limitations

- This parameter must be specified on one line. Continuation lines are not allowed. The total length of the parameter and parameter value specification cannot exceed 72 characters.
- In the AOFINIT member, if the number of PRIORITY parameters defining priority and color ranges (see page 228) exceeds the default PRITBLSZ parameter value of 7 (see page 230), the DCOLOR parameter must follow the PRITBLSZ parameter.
- Default values for priorities and colors are used if and only if no PRIORITY parameters are defined. If you choose to customize any priority and color definitions, you must specify all priority and color definitions in AOFINIT, rather than customizing the one priority and color definition and using the defaults for the remaining definitions.

Usage

It is recommended that you use the priority and color values supplied with SA OS/390 DSIPARM member AOFINIT.

Examples

```
Priority = 001,199,RED  
Priority = 200,299,PINK  
Priority = 300,399,YELLOW  
Priority = 400,499,TURQUOISE  
Priority = 500,599,GREEN  
Priority = 600,699,BLUE
```

PRITBLSZ

Purpose

The PRITBLSZ parameter defines the number of priority and color ranges defined by the PRIORITY entries. This parameter is optional. The default is 7.

Syntax



Parameters

nn The number of priority and color ranges. This value can be any number greater than or equal to 7. The default is 7.

Restrictions and Limitations

In the AOFINIT member, if the number of PRIORITY parameters defining priority and color ranges (see page 228) exceeds the default PRITBLSZ parameter value of 7 (see page 230), the DCOLOR parameter must follow the PRITBLSZ parameter.

Usage

The recommended value for PRITBLSZ is 7. This value is supplied with SA OS/390 DSIPARM member AOFINIT.

Examples

PRITBLSZ = 7

PROPDOWN

Purpose

The PROPDOWN parameter defines whether status information should be sent down the status tree as a system default or not. This parameter is optional. The default is NO.

Syntax

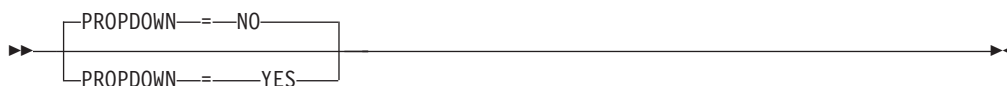

Parameters

None.

Usage

The recommended value for PROPDOWN is NO. This parameter can be overridden with individual requests to add a status descriptor to a status component.

PROPUP

Purpose

The PROPUP parameter defines whether status information should be sent up the status tree as a system default. This parameter is optional. The default is YES.

Syntax



Parameters

None.

Usage

The recommended value for PROPUP is YES. This parameter can be overridden with individual requests to add a status descriptor to a status component.

SCREENSZ

Purpose

The SCREENSZ parameter defines the screen buffer size. This parameter is optional. The default is 3000.

Syntax



Parameters

number

Buffer size value. Values can range from 3000 to 9999. The default is 3000.

Examples

SCREENSZ = 4000

TEMPERR

Purpose

The TEMPERR parameter defines the maximum number of temporary input/output errors when trying to display a SDF panel. This parameter is optional. The default is 3.

TEMPERR

Syntax



Parameters

number

Values can range from 3 to 99. The default is 3.

Usage

The recommended value for TEMPERR is 3. This value is supplied with SA OS/390 DSIPARM member AOFINIT.

Examples

TEMPERR = 3

Chapter 6. SDF Definition Statements

The status display facility (SDF) provides a display of automated systems and resources using assigned status colors. An operator monitors the status of automated systems and resources by viewing the SDF main panel.

Typically, an application shown in green on an SDF status panel indicates the application is up, while red indicates the application is stopped or in a problem state. Operators can use the SDF to monitor the system and decide which actions to take when problems occur.

Refer to *System Automation for OS/390 Defining Automation Policy* for information on how to define the SDF in the customization dialogs. You only need to change these entries if you use values other than the SA OS/390-provided defaults.

AOFTREE

Purpose

AOFTREE is a NetView DSIPARM member containing tree structure definitions, or referencing other tree structure definition members by using %INCLUDE statements. The tree structure definitions specify the propagation hierarchy used for status color changes.

Syntax

Each tree structure definition entry must be in the following format:

```
▶▶—level_number—status_component—┬──────────────────────────────────────────▶▶  
└──,—empty_chain_color──┘
```

Parameters

level_number

The level number assigned to each component in the tree structure. This value can be any valid number between 1 and 9999. A tree structure must start with the root as level number 1.

If a level number is less than that of the preceding status component, the level number used must be defined in the tree structure as a superior node to that status component. For example, the following tree structure definition is *incorrect*:

```
1 SY1  
3 APPLIX  
2 GATEWAY
```

Multiple roots can be defined in the same member, using 1 as the level number.

status_component

The status component associated with the *level_number*. This value can be any application or subsystem for which status information is to be displayed. SA OS/390 uses the subsystem entry name as defined in the automation

AOFTREE

control file. The status component entry for the root must match the SDFROOT value specified on the SA OS/390 Environment Setup panel in the customization dialogs defining current automation policy.

empty_chain_color

The color in which a status component is displayed on the SDF status panel if no status descriptor is associated with a status component. This value can be one of the following:

R	Red
P	Pink
Y	Yellow
T	Turquoise
G	Green
B	Blue
W	White

This entry is optional. If not coded, the value specified for the SDF initialization parameter EMPTYCOLOR in member AOFINIT is used for this value. Refer to "EMPTYCOLOR" on page 224 for more details.

Usage

When creating tree structure definitions, consider the following:

- Level numbers define the order of dependence. For an example, in Figure 17 on page 235, AOFAPPL is defined to depend on AOFSSI because AOFAPPL relies on AOFSSI for its message traffic. With propagation, any AOFSSI status change is reflected on both AOFAPPL and SY1 status components.
- Duplicate status components in the same tree structure should not be used.
- Not all status components defined in a tree structure require a corresponding panel entry. That is, you can define entries in a tree structure that do not have a corresponding panel display. However, every panel should have a corresponding entry in the tree structure.
- To avoid addressing conflicts, each root name must be unique. SDF addresses each status component defined in the tree structure as `root_component.status_component`

Examples

This example defines two separate tree structures, SY1 and SY2, representing two different MVS systems. SY1 is the focal point and SY2 is the target system.

Figure 17 on page 235 and Figure 18 on page 235 show the tree structures that must be defined in the tree structure definition member for SY1.

Note: /* denotes a comment field.

```
/* TREE STRUCTURE FOR SYSTEM SY1
1 SY1
2 APPLICATION
3 AOFAPPL
4 AOFSSI
3 JES2
4 SPOOL
3 VTAM
3 RMF
```

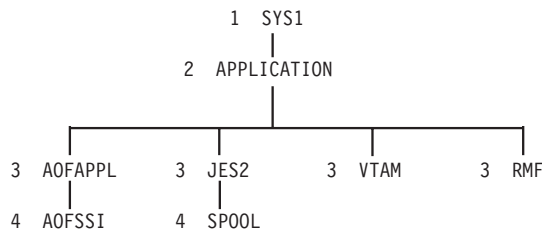

Figure 17. Example Tree Structure Definitions: System SY1. The diagram following the tree structure code for SY1 shows how the order of dependence relates to level number. The diagram is not actually in AOFTREE.

```

/* TREE STRUCTURE FOR SYSTEM SY2 ON SY1
1 SY2
2 APPLICATION
3 AOFAPPL
4 AOFSSI
3 JES2
4 SPOOL
3 VTAM
3 RMF
3 TSO
  
```

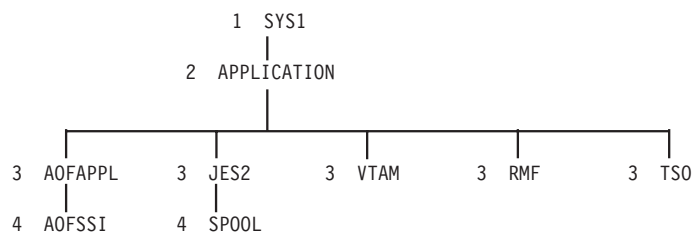

Figure 18. Example Tree Structure Definitions: System SY2. The diagram following the tree structure code for SY1 and SY2 shows how the order of dependence relates to level number. The diagram is not actually in AOFTREE.

These tree structures are referenced in the AOFTREE member on SY1 by the following %INCLUDE statements:

```

%INCLUDE(SY1TREE)
%INCLUDE(SY2TREE)
  
```

The AOFTREE member in system SY2 contains only a %INCLUDE statement referencing the tree structure for SY2.

Both tree structures start with level number 1. While the tree structures have unique root names, they can have similar status component names, such as JES2, VTAM, and RMF™. The corresponding settings for the root component in the automation policy for SY1 are:

```

COMMANDS  HELP
-----
AOFPIES0          SA OS/390 - Environment Setup
Command ==>>>

Entry Type : System          PolicyDB Name : DATABASE_NAME
Entry Name : SY1            Enterprise Name : YOUR_ENTERPRISE

Enter the following information:

System          ==> MVSESA    MVSESA
Primary JES     ==>          Primary JES2/JES3 subsystem name
System Monitor Time ==>      Time between SYSTEM monitoring
cycles (hh:mm or NONE)
Gateway Monitor Time ==>    Time between GATEWAY monitoring
cycles (hh:mm or NONE)
Monitor Option  ==>          Default routine used to monitor
application status
Message Table   ==>          Netview message automation table member
MVS SYSNAME     ==> SY1      The machines real system name
SDF Root Name   ==> SY1      Root of this systems SDF tree
Exit name(s)    ==>
Environment setup user exit names
(leave blank for no setup exit)
    
```

The root component name SY2 is not defined in the automation policy for SY1. Instead, it is similarly defined in the automation policy for SY2. Assuming SA OS/390 notification message forwarding is established between SY2 and SY1, the SDF for SY2 uses its unique root component name as a prefix for all status components when status information is forwarded to SY1, as shown:
 SY2.JES2 for JES2

PANEL

Purpose

The PANEL statement identifies the start of a new panel and its general attributes.

Syntax

Parameters are positional.

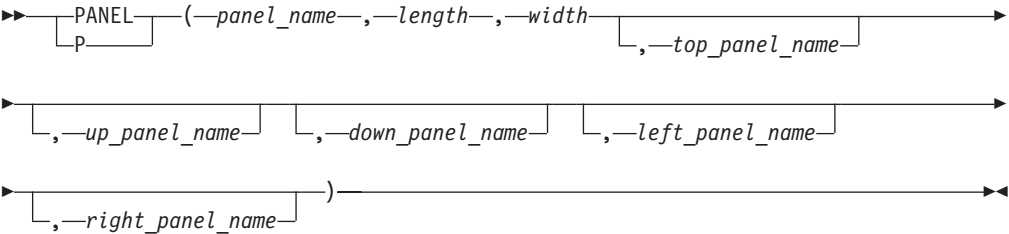

Parameters

- panel_name*
The name of the panel. This value can be any panel name up to 8 characters long.
- length*
The number of lines or rows in the panel. This value must be numeric. The only supported value is 24.

width

The number of columns in the panel. This value must be numeric. The only supported value is 80.

top_panel_name

The panel displayed when the TOP PF key is pressed or the TOP command is issued.

up_panel_name

The panel displayed when the UP PF key is pressed or the UP command is issued.

down_panel_name

The panel displayed when the DOWN PF key is pressed or the DOWN command is issued.

left_panel_name

The panel displayed when the left panel PF Key is pressed or the LEFT command is issued.

right_panel_name

The panel displayed when the right panel PF key is pressed or the RIGHT command is issued.

Usage

- The default initial panel name supplied with SA OS/390 is SYSTEM. If you change this name, also change the INITSCRN parameter value in the AOFINIT member (see "INITSCRN" on page 226 for details).
- If there is more data than can be displayed on a single screen, you can define continuation panels using the following parameters:
 - left_panel_name*
 - right_panel_name*
 - down_panel_name*
- To continue a PANEL statement on another line after a delimiting comma, leave the remaining columns up to and including column 72 blank. The next positional parameter must begin in column 1 of the following line.

Examples

This example defines SY1SYS as the panel name. The length is 24 lines and the width is 80 characters. The panel named SYSTEM is displayed when the TOP and UP commands are used. No entries are defined for the DOWN, LEFT, or RIGHT commands.

```
PANEL(SY1SYS,24,80,SYSTEM,SYSTEM)
```

STATUSFIELD

Purpose

The STATUSFIELD statement defines the location of the status component on a panel and the panels that display when the UP and DOWN commands are used.

A STATUSFIELD statement is always accompanied by a STATUSTEXT statement (see "STATUSTEXT" on page 240) in a panel definition.

STATUSFIELD

Syntax

Parameters are positional.

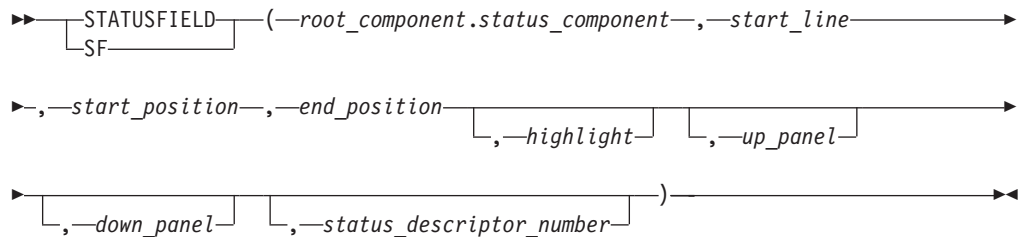

Parameters

root_component

The root component name as defined in the root node of the tree structure. The root component (as opposed to the status component alone) must always be coded, because different systems can have status components with the same name, such as VTAM or JES2, in their tree structures. Because the root component is always unique, each status component in a tree structure can be uniquely identified using the root component as a prefix.

status_component

The status component name as defined in the AOFTREE member. Maximum length is 8 characters.

start_line

The line number on which the status component should be displayed. This value should be numeric and in the range specified in the *length* parameter in the PANEL definition statement (see "PANEL" on page 236).

start_position

The actual column number within the specified *start_line* on which the status component is to be placed. There must be a minimum of two spaces between the ending position of one field and the beginning position of the next field to allow for attribute type. For example, if the end-position of a STATUSFIELD is in column 10, the start-position of the next STATUSFIELD must be column 13.

end_position

The column number in which the status component definition ends. This value is governed by the length of text defined in the STATUSTEXT definition. For example, if JES2 is to be defined, then the length of the STATUSTEXT is four and the end position is the start position plus three. Refer to "STATUSTEXT" on page 240 for more details.

highlight

The type of highlighting used on the panel. This value can be one of the following:

N	Normal
B	Blink
R	Reverse
U	Underscore

The recommended value for highlighting is Normal. This value lets individual status descriptors added to the panel override any predefined highlighting with their own highlighting.

up_panel

The panel displayed when the UP PF key is pressed.

down_panel

The panel displayed when the DOWN PF key is pressed.

status_descriptor_number

The status descriptor number of the panel. This number specifies the status descriptor displayed in each field. This value must be numeric. The default is 0.

A status descriptor number of 0 causes the text as defined in the STATUSTEXT statement for this field (see STATUSTEXT *text* parameter on page 240) to be displayed with the color and highlighting associated with the first status descriptor chained to the status component. A status descriptor of 1 essentially does the same, except that the status text is replaced by information contained in the first status descriptor chained to the status component. A status descriptor of 2 or higher has the same effect as a value of 1, except that the numbered status descriptor is used rather than the first.

Status descriptors are chained with the status component in ascending order of priority.

The status descriptor number may be prefixed with a letter denoting the type of information to be displayed. If no prefix is supplied, the MVS job name is displayed if the resource is a subsystem or WTOR. Valid prefixes are as follows:

C	Displays the name of the status component
D	Displays the date the record was created
M	Displays the associated message text
P	Displays the priority of the record
Q	Displays the reference value for the record
R	Displays the name of the root component
S	Displays the reporting operator ID
T	Displays the time the record was created
U	Displays the number of duplicate records
V	Displays the job name or other information about the request
X	Displays the reporting domain ID

Restrictions and Limitations

A *start_line* and *start_position* parameter value combination of 1,1 is not allowed.

SDF panels containing STATUSFIELD entries referring to other than the first status descriptor may not be updated dynamically if the panel is not made resident either using the SDFPANEL ...,ADD command, or during SDF initialization. Automatic updates on dynamically loaded panels may be obtained by coding a dummy panel containing STATUSFIELD entries referring to the status component with a status descriptor number greater than 1.

At least one undefined (blank) position must be provided immediately preceding a STATUSFIELD. If *start_position* is specified as 1, then the last position on the preceding line must not be defined.

Usage

- When designing a panel for any status component, make the end position greater than or equal to the start position. Otherwise, an error condition will occur during SDF initialization.

STATUSFIELD

- To continue a STATUSFIELD statement on another line after a delimiting comma, leave the remaining columns up to and including column 72 blank. The next positional parameter must begin in column 1 of the following line. An example of a continued STATUSFIELD statement is:

```
STATUSFIELD(SY.VTAM,  
04,10,13,NORMAL)
```

- For better performance, make sure that every status component referred to in the panel is defined in the corresponding AOFTREE member.

Examples

Example 1

In this example, the status component VTAM on SY1 starts on line 4 in column 10, ends in column 13, and has normal highlighting. No entries are defined for the UP or DOWN commands.

```
STATUSFIELD(SY1.VTAM,04,10,13,NORMAL)  
:  
:
```

Example 2

In this example, the status component SYSTEM starts on line 2 in column 04, ends in column 06, and has normal highlighting. No entries are defined for the UP panel. Panel SY1SYS is displayed when the DOWN command is issued.

```
SF(SY1.SYSTEM,02,04,06,N,,SY1SYS)  
:  
:
```

Example 3

In this example, three STATUSFIELD entries are defined for the same status component, SY1.GATEWAY. The highest-priority status descriptor is displayed in the first entry, the next highest-priority status descriptor is displayed in the second entry, and so on.

```
SF(SY1.GATEWAY,02,04,06,NORMAL,,1)  
SF(SY1.GATEWAY,03,04,06,NORMAL,,2)  
SF(SY1.GATEWAY,04,04,06,NORMAL,,3)  
:  
:
```

STATUSTEXT

Purpose

The STATUSTEXT statement defines the text data displayed in the STATUSFIELD statement (see “STATUSFIELD” on page 237). This text data is typically the status component name.

Syntax

```
▶▶—STATUSTEXT—text—▶▶  
└──ST──┘
```

Parameters

text

The default data displayed for the status component defined in the

STATUSFIELD statement. This text can be replaced by text from a status descriptor chained to the status component if the *status_descriptor_number* parameter value on the corresponding STATUSFIELD statement is non-zero. The recommended value is the status component name. For example, for status component SY1.VTAM, specify VTAM for the *text* value. The length of text determines the end position coded in the STATUSFIELD statement.

Restrictions and Limitations

- Each STATUSFIELD statement must have a STATUSTEXT statement associated with it in a panel definition.
- The total length of the STATUSTEXT text cannot exceed the status field length defined by the combination of STATUSFIELD *start_position* and *end_position* parameter values.

Usage

To continue a STATUSTEXT statement, insert a delimiting comma and leave the remaining columns up to and including column 72 blank. Resume the text definition in column 1 of the following line.

Examples

Example 1

The following statement defines status text 1234567890 for a status field:
 STATUSTEXT(12345,
 67890)

Example 2

This example defines that IMS on SY2 displays as ACCOUNTS on the status display panel. Any status descriptors added for SY2.IMS are displayed using the ACCOUNTS entry.

Note: The end position in the STATUSFIELD statement reflects the length of ACCOUNTS.

```
STATUSFIELD(SY2.IMS,06,10,17,NORMAL)
STATUSTEXT(ACCOUNTS)
```

TEXTFIELD

Purpose

The TEXTFIELD statement defines the location and attributes of fields that remain constant on the panels, such as panel headings, field names, and PF key designations.

Each TEXTFIELD statement must have a TEXTTEXT statement associated with it (see "TEXTTEXT" on page 243) in a panel definition.

Syntax

Parameters are positional.

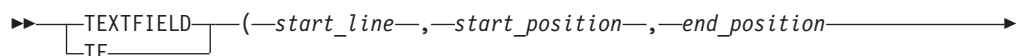

TEXTFIELD



Parameters

start_line

The line number on which the text field is displayed. This value should be numeric and in the range specified in the *length* parameter in the PANEL definition statement (see "PANEL" on page 236).

start_position

The column number in which the text field is placed.

end_position

The column number in which the data specified in entry TEXTTEXT ends. Refer to "TEXTTEXT" on page 243 for more details.

color

The color in which text specified in the corresponding TEXTTEXT statement is displayed. This value can be one of the following:

R	Red
P	Pink
Y	Yellow
T	Turquoise
G	Green
B	Blue
W	White

highlight

Determines how the text specified in the corresponding TEXTTEXT statement is displayed. This value can be one of the following:

N	Normal
B	Blink
R	Reverse
U	Underscore

Restrictions and Limitations

- A *start_line* and *start_position* parameter value combination of 1,1 is not allowed.
- If your text definition for an area of a panel requires more than 72 characters, continue the definition in additional TEXTFIELD and TEXTTEXT statement pairs. See the examples in "TEXTTEXT" on page 243 for an example of continuing definitions in additional TEXTFIELD and TEXTTEXT pairs.
- At least two undefined (blank) positions must be provided immediately preceding a TEXTFIELD if it follows a STATUSFIELD. If *start_position* is specified as 1, then the last two positions on the preceding line must not be defined.
- At least one undefined (blank) position must be provided immediately preceding a TEXTFIELD if it follows another TEXTFIELD. If *start_position* is specified as 1, then the last position on the preceding line must not be defined.

Usage

- When designing a panel, for any TEXTFIELD, make the *end_position* of the TEXTFIELD greater than or equal to the *start_position*. Otherwise, an error condition will occur during SDF initialization.

- To continue a TEXTFIELD statement on another line after a delimiting comma, leave the remaining columns up to and including column 72 blank. The next positional parameter must begin in column 1 of the following line. An example continued TEXTTEXT statement is:

```
TEXTFIELD(01,
25,57,WHITE,NORMAL)
```

Examples

This example defines the TEXTFIELD as being on line 1, starting in column 25, ending in column 57. The text is displayed in white, and uses normal highlighting.

```
TEXTFIELD(01,25,57,WHITE,NORMAL)
```

TEXTTEXT

Purpose

The TEXTTEXT statement defines the data displayed in the corresponding TEXTFIELD entry (see “TEXTFIELD” on page 241).

Each TEXTFIELD statement must have a TEXTTEXT statement associated with it in a panel definition.

Syntax

```
▶▶—TEXTTEXT—(—text—)————▶▶
   └──┬──┘
      TT
```

Parameters

text

The data displayed for the TEXTFIELD statement. The length of the data determines the end position coded in the TEXTFIELD entry.

Restrictions and Limitations

The total length of the TEXTTEXT text cannot exceed the text field length defined by the combination of TEXTFIELD *start_position* and *end_position* parameter values.

Usage

To continue a TEXTTEXT statement, insert a delimiting comma and leave the remaining columns up to and including column 72 blank. Resume the text definition in column 1 of the following line. See the TEXTTEXT examples for an example continued statement.

Examples

Example 1

In this example, “Data center systems” is displayed on the status display panel in white.

```
TEXTFIELD(01,25,57,WHITE,NORMAL)
TEXTTEXT(DATA CENTER SYSTEMS)
```

Example 2

TEXTTEXT

In this example, all PF key settings are displayed on line 24 of the status display panel.

```
TF(24,01,79,TURQUOISE,NORMAL)
TEXTTEXT(PF1=HELP 2=DETAIL 3=END 6=ROLL 7=UP 8=DN ,
10=LF 11=RT 12=TOP)
```

PFKnn

Purpose

The PFKnn entry defines all PF keys unique to a panel.

The definitions defined by PFKnn are only active when the status panel is displayed. They override the default settings defined with the initialization PFKnn statement in member AOFINIT (see “PFKnn” on page 227).

Syntax

►► PFKnn (command , —variable) ◀◀

Parameters

nn The PF key number. This value can range from 1 through 24.

command

The command called when the defined PF key is pressed. If you need to use commas in the command, enclose the entire command string in apostrophes.

variable

Variables can be used as part of the command specified in the PFKnn statement. Table 15 shows variables that can be used.

Note: Use of these variables (that is, their appropriate translation from variables to values) is valid on a detail status panel or on a status panel when the cursor is on a status field.

Table 15. Variables for PF Keys

Variables for Text Fields

&COMP or &RESOURCE

&ROOT or &SYSTEM

&SYSDATE

&SYSTIME

&IN or &INFO

&DATE

&TIME

&SENDERID

&SNODE or &SENDERNODE

&DA or &DATA or &DSPDETL

&RV or &REFVALUE

&PR or &PRIORITY

&CO or &COLOR

&HI or &HIGHLITE

Translated To

The component name

Root or system

System date

System time

Detail entry information displayed on the status panel

The date the detail entry was added

The time the detail entry was added

The reporter submitting the detail entry

The node of the reporter submitting the detail entry

The actual message text

The reference value of the detail entry

The priority of the detail entry

The color of the detail entry

The highlight level of the detail entry

Table 15. Variables for PF Keys (continued)

Variables for Text Fields	Translated To
&RESAPPL or &COMPAPPL	The component name and the alternate component name if used to queue the status
&QCOMP	The component name to which the status was queued by SDF
&DCOMP	The displayed component name

Examples

This example results in issuing MVS D A, TSO when PF4 is pressed and the cursor is on the TSO entry: PFK4('MVS D A, &INFO')

ENDPANEL

Purpose

The ENDPANEL statement identifies the end of a panel.

Syntax

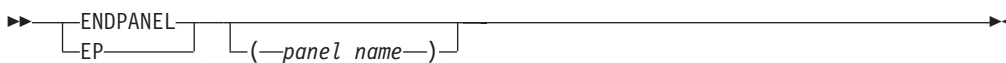

Parameters

panel_name

The name of the panel. This parameter is optional. If specified, this parameter value must match the name specified on the previous PANEL statement.

Restrictions and Limitations

None.

Example SDF Definition

This section shows an example of defining SDF. In this example, two separate systems (SY1 and SY2) are defined to SDF, so that SDF can monitor both systems. The example shows the entries required to define and customize SDF, including:

- SDF tree structure definitions
- SDF panel definitions
- SDF initialization parameters in AOFINIT
- SDF Status Details definitions

Note: This example assumes that SA OS/390 focal point services are already implemented so that status can be forwarded from one system to another using notification messages.

SDF Tree Structure Definitions

Two tree structure definitions are required to set up the SDF hierarchy for systems SY1 and SY2. Figure 19 on page 246 shows the tree structure definition for SY1. This tree structure is defined in a NetView DSIPARM data set member named SY1TREE.

SDF Definitions

```

1 SY1
2 SYSTEM
3 JES
3 RMF
3 VTAM
3 TSO
3 AOFAPPL
4 AOFSSI
3 APPLIC
4 SUBSYS
2 ACTION, GREEN
3 WTOR, GREEN
2 GATEWAY

```

Figure 19. SDF Example: Tree Structure Definition for SY1

Figure 20 shows the hierarchy of monitored resources defined by the SY1 tree structure.

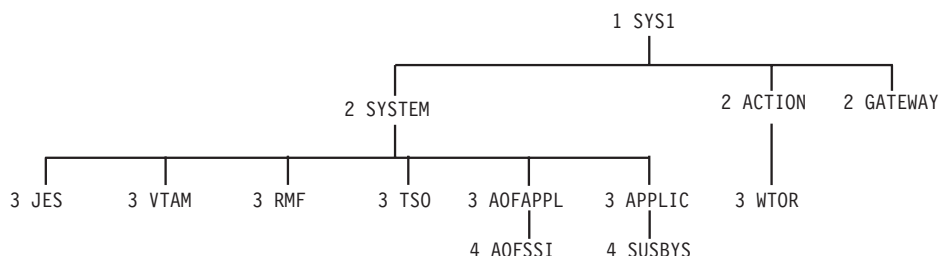

Figure 20. SDF Example: Hierarchy Defined by SY1 Tree Structure. The diagram shows how the order of dependence relates to level number. The diagram is not actually in AOFTREE.

This structure contains specific entries for the major system components, JES, RMF, VTAM, and TSO, as well as NetView (AOFAPPL) and the NetView SSI (AOFSSI). Note that the hierarchy differs from that defined in the SA OS/390 automation control file. This is because the operator's view of these subsystems differs from the logical sequence in which they are managed by SA OS/390 for startup and shutdown purposes.

The SYSTEM, APPLIC, and ACTION entries are logical, and may be used to view the status of all entries below them in priority order.

The SUBSYS, WTOR, and GATEWAY entries are also logical, and may be used to display the status of SUBSYSTEM, WTOR, and GATEWAY resource types. The status of any subsystem not appearing elsewhere in the tree will be queued under the SUBSYS entry. Similarly, WTORs and gateway status will be queued under WTOR and GATEWAY respectively.

A similar tree structure must be provided for SY2. As both systems are running the same set of base software, the tree structures are identical, except for the root (level 1) name, which will be SY2 rather than SY1. This tree structure is defined in the SY2TREE NetView DSIPARM member.

As SY1 is the focal point system in this example, both members must be defined in the NetView DSIPARM data set on that system. The tree structures are referenced by %INCLUDE statements in the base SDF tree definition member, AOFTREE, as follows:

```

%INCLUDE(SY1TREE)
%INCLUDE(SY2TREE)

```

As our example does not require SY2 to function as a backup focal point system, the AOFREE member on SY2 requires only the %INCLUDE statement for SY2TREE.

SDF Panel Definitions

Following are panel definitions for:

- The root component or system panel, named SYSTEM
- The status component panel for system SY1, named SY1

Each panel definition is followed by the screen it defines.

SA OS/390 provides samples similar to those described, as well as a sample GATEWAY panel definition for use on SY1.

On system SY1, these panel definitions are referenced by %INCLUDE statements in the main SDF panel definition member, AOFPNLS, as follows:

The GATEWAY, SY1, and SY2 panels must be resident as they contain generic field definitions.

```
%INCLUDE(SYSTEM)
%INCLUDE(GATEWAY)
%INCLUDE(SY1)
%INCLUDE(SY2)
```

Root Component Panel Definition

First, the root panel, named SYSTEM, is defined. Figure 21 shows the panel definition statements that define the SYSTEM panel. This panel is the default initial SDF panel as assigned in the SDF initialization parameter member, AOFINIT. Three panels are accessed by pressing the DOWN PF key (PF8), GATEWAY, SY1, and SY2. All status components are prefixed with the root component and are listed in the corresponding tree structure. Each STATUSFIELD (SF) statement is followed by the corresponding STATUSTEXT (ST) statement. Similarly, each TEXTFIELD (TF) statement is followed by the corresponding TEXTTEXT (TT) statement.

```
/* DEFINE SYSTEM STATUS PANEL
P(SYSTEM,24,80)
TF(01,02,10,WHITE,NORMAL)
TT(SYSTEM)
TF(01,25,57,WHITE,NORMAL)
TT(DATA CENTER SYSTEMS)
SF(SY1.SYSTEM,04,04,11,N,,SY1)
ST(SY1)
SF(SY2.SYSTEM,06,04,11,N,,SY2)
ST(SY2)
SF(SY1.GATEWAY,02,70,77,N,,GATEWAY)
ST GATEWAY
TF(24,01,48,T,NORMAL)
TT(1=HELP 2=DETAIL 3=RET          6=ROLL      8=DN)
TF(24,51,79,T,NORMAL)
TT(          10=LF 11=RT 12=TOP)
EP
```

Figure 21. SDF Example: System Panel Definition Statements

This panel shows the layout defined by the statements in Figure 21:

SDF Definitions

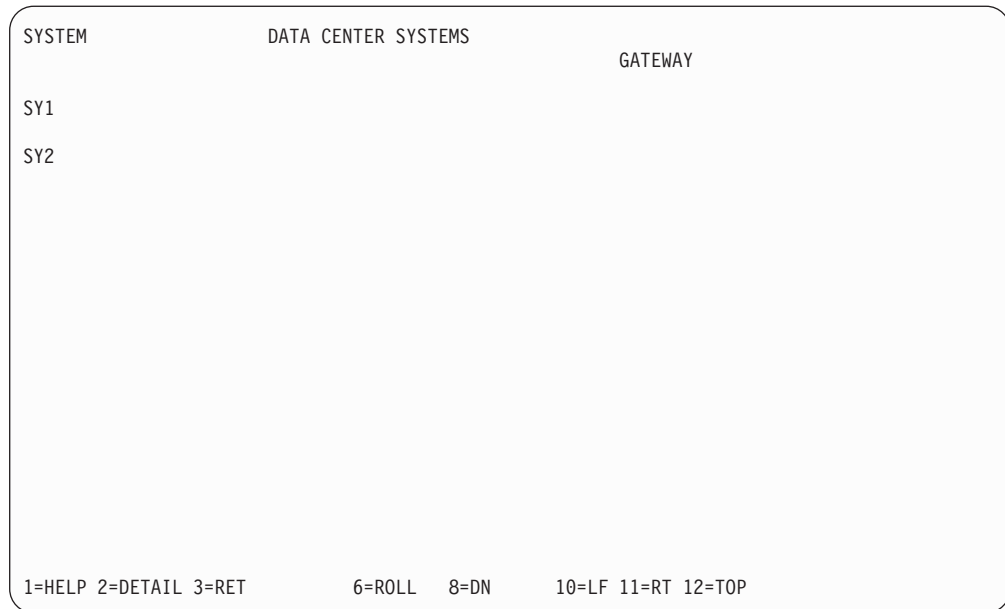

Status Component Panel Definition

Next, the panels for the status components, SY1, and SY2 are defined. These panels may be accessed by pressing the DOWN PF key (PF8) on the root component panel, after placing the cursor under the desired system name. They may also be accessed directly by entering SDF SY1 or SDF SY2 from the NetView NCCF command line, or entering SCREEN SY1 from within SDF.

As these panels contain dynamic status elements, it is necessary for them to be made resident. This is done by referencing them in %INCLUDE statements in the main SDF panel definition member.

Figure 22 on page 249 shows a sample panel definition for panel SY1.

```

/* Panel definition statements for SY1 panel
P(SY1,24,80,SYSTEM,SYSTEM)
TF(01,02,10,WHITE,NORMAL)
TT(SY1)
TF(01,27,47,WHITE,NORMAL)
TT(SY1 SYSTEM STATUS)
SF(SY1.JES,04,16,24,N)
ST(JES)
SF(SY1.RMF,06,16,24,N)
ST(RMF)
SF(SY1.VTAM,08,16,24,N)
ST(VTAM)
SF(SY1.TSO,10,16,24,N)
ST(TSO)
SF(SY1.AOFAPPL,12,16,24,N)
ST(NetView)
SF(SY1.AOFSSI,14,18,28,N)
ST(NetView SSI)
SF(SY1.WTOR,4,45,50,N)
ST(WTORs:)
SF(SY1.WTOR,4,53,56,N,,c1)
SF(SY1.WTOR,4,59,67,N,,1)
SF(SY1.WTOR,5,53,56,N,,c2)
SF(SY1.WTOR,5,59,67,N,,2)
SF(SY1.WTOR,6,53,56,N,,c3)
SF(SY1.WTOR,6,59,67,N,,3)
SF(SY1.WTOR,7,53,56,N,,c4)
SF(SY1.WTOR,7,59,67,N,,4)
SF(SY1.APPLIC,9,45,57,N)
ST(Applications:)
SF(SYS1.APPLIC,9,59,67,N,,1)
SF(SYS1.APPLIC,10,59,67,N,,2)
SF(SYS1.APPLIC,11,59,67,N,,3)
SF(SYS1.APPLIC,12,59,67,N,,4)
SF(SYS1.APPLIC,13,59,67,N,,5)
SF(SYS1.APPLIC,14,59,67,N,,6)
PFK4('SDFDEL &ROOT.&RESAPPL,RV=&RV,DATE=&DATE,TIME=&TIME')
TF(24,01,79,T,NORMAL)
TT('1=HELP 2=DETAIL 3=RET          6=ROLL 7=UP      '
'          10=LF 11=RT 12=TOP')
EP(SY1)

```

Figure 22. SDF Example: Status Component Panel Definition Statements for SY1SYS

A similar panel reflecting the status of components on SY2 can be created by changing all occurrences of SY1 to SY2 in the above example.

Figure 23 on page 250 shows the layout defined by the statements in Figure 22.

Note: Three of the four available WTOR dynamic fields have been filled with the WTOR number and the name of the job that issued them. WTORs will appear whether or not their source is defined to SA OS/390.

SDF Definitions

SY1	SY1	SYSTEM	STATUS
JES		WTORs: 14	MSGPROC
18	NETVIEW		
RMF		22	MYJOB
VTAM			
Applications: MSGPROC			
TSO			WTR00E
IMS			
NetView			CICS
ETC1			
NetView SSI			ETC2

1=HELP 2=DETAIL 3=RET 4=DELETE 6=ROLL 7=UP 10=LF 11=RT 12=TOP

Figure 23. Sample SY1 SDF Panel

The fields defined for JES, RMF, VTAM, TSO, NetView and the NetView SSI are static in that only the color of the predefined status text will change when the highest priority status descriptor queued for the underlying status component changes. The fields defining WTORs: and Applications: are also static, but do not refer to a specific subsystem. These fields will also assume the color of the highest priority status descriptor queued. The WTORs: field is green when no replies are outstanding due to the SDF tree definition for the underlying status component, SY1.WTOR. The remaining static fields will appear turquoise, or the EMPTYCOLOR defined in the AOFINIT NetView DSIPARM member.

The status fields following WTORs: and Applications: are dynamic in that both their content and color depend on the status descriptor they represent. The ability to select both the type of data and the status descriptor number (See "STATUSFIELD" on page 237) from which the data is obtained, allows generic status fields to be defined. This takes advantage of an SDF feature which allows the status descriptor to be queued under an alternate component should the primary status component not be defined in the SDF tree structure. For subsystems, the status component name is the subsystem name, and the alternate component is SUBSYS. WTORs are queued using the reply ID as the status component name, and WTOR as the alternate component name.

The use of generic field definitions have several advantages, and may reduce considerably the amount of maintenance required, particularly in large , multi-system environments. Using this method, the status components are displayed in priority order, so the most critical status subsystem is presented first. Also, if more subsystems are defined to SA OS/390 than are defined on the panel, you will be notified of only the most critical situations. It is also possible to continue the list of statuses presented on additional panels if required.

You should note that using this method, subsystems do not always appear in the same position on the panel, which may make it difficult to find a specific subsystem. Also, some transient conditions can cause a subsystem to appear twice on the display. This can be eliminated by changing the SDF Status Detail definition to CLEAR=Y for the transient status definitions.

SDF Initialization Parameters in AOFINIT

For this example, the default AOFINIT entries supplied with SA OS/390 are used. For more information on setting SDF initialization parameters refer to Chapter 5, "SDF Initialization Parameters", on page 221.

```

SCREENSZ = 3000
INITSCRN=SYSTEM
MAXOPS=10
PROPUP=YES
PROPDOWN=NO
TEMPERR=3
/* STATUS PANEL PF KEYS AND DESCRIPTION */
PFK1=AOCHELP SDF
PFK2=DETAIL
PFK3=RETURN
PFK4=
PFK5=
PFK6=ROLL
PFK7=UP
PFK8=DOWN
PFK9=
PFK10=LEFT
PFK11=RIGHT
PFK12=TOP
PFK13=AOCHELP SDF
PFK14=DETAIL
PFK15=RETURN
PFK16=
PFK17=
PFK18=ROLL
PFK19=UP
PFK20=DOWN
PFK21=ASSIST &ROOT,&COMPAPPL,&RV,&SID,&SNODE,&DA
PFK22=LEFT
PFK23=RIGHT
PFK24=TOP
/* DETAIL PANEL PF KEYS AND DESCRIPTION */
DPFK1=AOCHELP SDF
DPFK2=
DPFK3=RETURN
DPFK4=
DPFK5=
DPFK6=ROLL
DPFK7=UP
DPFK8=DOWN
DPFK9=ASSIST &ROOT,&COMPAPPL,&RV,&SID,&SNODE,&DA
DPFK10=SDFDEL &ROOT,&COMPAPPL,RV=&RV,DATE=&DATE,TIME=&TIME
DPFK11=BOT
DPFK12=TOP
DPFK13=AOCHELP SDF
DPFK14=
DPFK15=RETURN
DPFK16=
DPFK17=
DPFK18=ROLL
DPFK19=UP
DPFK20=DOWN
DPFK21=ASSIST &ROOT,&COMPAPPL,&RV,&SID,&SNODE,&DA
DPFK22=SDFDEL &ROOT.&COMPAPPL,RV=&RV,DATE=&DATE,TIME=&TIME
DPFK23=BOT
DPFK24=TOP
DPFKDESC1=1=HELP      3=RETURN      6=ROLL 7=UP 8=DOWN 9=ASSIST
DPFKDESC2=10=DELETE 11=BOTTOM 12=TOP
/* PRIORITY/COLOR RELATIONSHIPS (DEFAULT VALUES)
PRITBLSZ=7
PRIORITY=1,199,RED

```

SDF Definitions

PRIORITY=200,299,PINK
 PRIORITY=300,399,YELLOW
 PRIORITY=400,499,TURQUOISE
 PRIORITY=500,599,GREEN
 PRIORITY=600,699,BLUE
 DCOLOR=WHITE
 EMPTYCOLOR=BLUE

Note: /* denotes a comment field, where /* must be followed by a blank.

SDF Status Detail Definitions

In Figure 24 the default SDF Status Details definitions supplied with SA OS/390 are used. For further information on how to set SDF Status Detail fields, refer to *System Automation for OS/390 User's Guide*. These entries are stored in NetView DSIPARM data set member AOFSDF, and are automatically included in the master automation control file.

Note: Do not rename the AOFSDF member %INCLUDE AOFSDF.

COMMANDS	HELP					

AOFGSCR	SA OS/390 - Status Display Facility Details	Row 1 to 15 of 56				
Command ==>>		SCROLL==>> PAGE				
Entry Type :	Status Details	PolicyDB Name :	DATABASE_NAME			
Entry Name :	AOFSDF	Enterprise Name :	YOUR_ENTERPRISE			
Status	Priority	Highlight	Color	Clear	Srv Req(noadd)	
RWTOR				(Y,RV)	NOADD	
SPLGONE				(Y,RV)	NOADD	
COMMLOST	110	REVERSE	RED	Y		
BROKEN	120	REVERSE	RED	(Y,RV*)		
BREAKING	130	BLINK	RED	(Y,RV*)		
INACTIVE	140	UNDERSCORE	RED	(Y,RV*)		
IWTOR	150		RED	Y		
SPLFULL	150		RED	(Y,RV)		
STOPPED	150	NORMAL	RED	(Y,RV*)		
HALFDOWN	220	NORMAL	PINK	(Y,RV*)		
STARTED2	230	BLINK	PINK	(Y,RV*)		
STUCK	240	UNDERSCORE	PINK	(Y,RV*)		
ZOMBIE	250	REVERSE	PINK	(Y,RV*)		
ABENDING	320	REVERSE	WHITE	(Y,RV*)		
HALTED	330	UNDERSCORE	WHITE	(Y,RV*)		
ASSIST	340	BLINK	WHITE		Y	
ASSISTDL	350			(Y,RV*)	Y NOADD	
SPLSHORT	350		YELLOW	(Y,RV)		
UWTOR	350		YELLOW	Y		
STOPPING	420	REVERSE	YELLOW	(Y,RV*)		
AUTOTERM	430	NORMAL	YELLOW	(Y,RV*)		
ENDING	440	UNDERSCORE	YELLOW	(Y,RV*)		
RUNNING	520	BLINK	TURQUOISE	(Y,RV*)		
ACTIVE	530	REVERSE	TURQUOISE	(Y,RV*)		
STARTED	540	UNDERSCORE	TURQUOISE	(Y,RV*)		
EXTSTART	550	BLINK	TURQUOISE	(Y,RV*)		
NWTOR	550		GREEN	Y		
RESTART	550	NORMAL	TURQUOISE	(Y,RV*)		
SPLOK	550		GREEN	Y		
UP	640	NORMAL	GREEN	(Y,RV*)		
ENDED	650	UNDERSCORE	GREEN	(Y,RV*)		
DOWN	730	UNDERSCORE	BLUE	(Y,RV*)		
AUTODOWN	740	NORMAL	BLUE	(Y,RV*)		
CTLDOWN	750	BLINK	BLUE	(Y,RV*)		
MOVED	760	REVERSE	BLUE	(Y,RV*)		
FALLBACK	770	NORMAL	BLUE	(Y,RV*)		

Figure 24. Default Values for SDF Displays

Chapter 7. SDF Commands

SDFTREE

Purpose

SDFTREE dynamically loads an SDF tree structure definition member from the NetView DSIPARM data set or deletes a tree member from system memory.

SDFTREE can be issued from a console.

Syntax

To load or delete a tree structure definition member use the following syntax:

```
▶▶ SDFTREE [tree_member,ADD | root_component_name,DELETE] ▶▶
```

Parameters

tree_member

The name of the member containing the tree structure to load.

root_component_name

The name of the root component, which is the name used for level 1 in the tree structure you want to delete. While you add a tree structure definition members by specifying a tree member name, you delete tree structure definition members by specifying a root component name.

ADD

Specifies that you want to add the specified tree structure definition member.

DELETE

Specifies that you want to delete a tree structure definition member.

Restrictions and Limitations

Tree structure definition members dynamically loaded by the SDFTREE command are not reloaded when SDF is restarted. When SDF is restarted, only members AOFTREE and any members referenced by %INCLUDE statements in AOFTREE are reloaded. You must either add the tree definitions to AOFTREE (using %INCLUDE statements) before SDF is restarted, or manually reload them using the SDFTREE command after SDF is restarted.

Usage

- When a new tree structure is loaded to replace an existing tree structure, the status descriptors of any status component with identical names in both trees are copied to the new tree.
- When an error is detected while this command is processing, no action is taken to change the existing tree structure.

SDFTREE

Examples

SDFTREE NEWTREE,ADD loads member NEWTREE into system memory. This loading allows operators to access the tree structure defined in NEWTREE.

SDFPANEL

Purpose

SDFPANEL dynamically loads a panel member from the NetView DSIPARM data set or deletes a panel member.

SDFPANEL can be issued from a console.

Syntax

To add or delete a panel member use the following syntax:

```
▶▶ SDFPANEL panel_member,ADD panel_name,DELETE▶▶
```

Parameters

panel_member

The name of the member containing the panel to load.

panel_name

The name of the panel to delete. While you add panels by specifying the panel member name, you delete panels by specifying the actual panel name.

ADD

Specifies that you want to add the specified panel member.

DELETE

Specifies that you want to delete the specified panel.

Restrictions and Limitations

Panel definition members dynamically loaded by the SDFPANEL command are not reloaded when SDF is restarted. Only member AOFPNLS and any members referenced by %INCLUDE statements in AOFPNLS are reloaded. You must either add the panel definitions to AOFPNLS (using %INCLUDE statements) before SDF is restarted, or manually reload them using the SDFPANEL command after SDF is restarted.

Usage

When an error is detected while this command is processing, no action is taken to change the existing panel definitions. For example, if one of several panels defined or referenced by %INCLUDE statements in a panel definition member contains an error, none of the panels are placed into active use.

Examples

SDFPANEL NEWPANEL,ADD loads member NEWPANEL into memory. This loading allows operators to access the panel defined in NEWPANEL.

SCREEN

Purpose

The SCREEN command displays a specific SDF panel.

SCREEN can be issued only within SDF.

Syntax

►►—SCREEN—*panel_name*—◄◄

Parameters

panel_name

The name of the panel to be displayed. *panel_name* is the name of the panel as it appears in the upper left hand corner of the screen.

Restrictions and Limitations

None.

Usage

- If the specified panel is not in memory when the SCREEN command is issued, the NetView DSIPARM data set is searched for a member name matching the specified panel name. If one is found, that member is loaded for the operator from which the request was made, and the panel defined in the member is displayed.
- If an error is detected in a panel you attempt to load using the SCREEN command, the panel is not displayed.
- If you plan to use the SCREEN command frequently in your SDF implementation, you might want to define a PF key that issues the SCREEN command.

Examples

SCREEN SY1 displays the panel named SY1.

Dynamically Loading Panels and Tree Structures

You can dynamically load panels and tree structures without restarting SDF. With this dynamic loading, you can load a small number of panels during initialization, and add or delete panel subsets when required during SDF operation. This can significantly reduce the number of panels kept resident at any one time.

When you are dynamically loading panels or tree structures, there must be a member in the NetView DSIPARM data set with the same name as the panel name or the root component in the tree structure. If not, a “not found” error message is generated.

Note: Only panels loaded with the SDFPANEL command are available to all logged-on SA OS/390 operators. All others are loaded only for the operator calling them.

Dynamically Loading Panels

SCREEN

You can load panels dynamically in the following ways:

- With the SDFPANEL command, as described in “SDFPANEL” on page 254.
- With the SCREEN command, as described in “SCREEN” on page 255.
- When any of the following PANEL statement parameters call a panel not defined in AOFPNLS, and a member with the same name as that panel is found in the NetView DSIPARM data set:
 - *top_panel_name*
 - *up_panel_name*
 - *down_panel_name*
 - *left_panel_name*
 - *right_panel_name*

See “PANEL” on page 236 for the PANEL statement description.

Note: Performance hint: Dynamically loading panels reduces storage requirements. However, using the SCREEN command or PANEL statements that refer to the panels not defined in AOFPNLS can result in increased processor usage. For better performance, ensure the panels are included in the AOFPNLS member either directly or by an %INCLUDE.

Dynamically Loading Tree Structures

You can load SDF tree structures dynamically with the SDFTREE command, as described in “SDFTREE” on page 253.

When you load a new tree structure to replace an existing one, any status descriptors with identical names in both tree structures are copied to the new tree structure.

Dynamic Loading Example

Suppose you change the tree structure for root component SY1 and the panel named SY1SYS. The tree structure and panel definitions are maintained in separate members (instead of being directly coded in AOFTREE or AOFPNLS). Use the following commands to load the new definitions:

```
SDFTREE SY1,ADD  
SDFPANEL SY1SYS,ADD
```

For more information, see “SDFTREE” on page 253 and “SDFPANEL” on page 254.

Dynamic Loading Commands

Use the following commands to dynamically load SDF tree structures and panels, and to confirm that a panel was loaded:

SDFTREE

Load Tree Structure Definition Member

SDFPANEL

Load Panel Definition Member

SCREEN

Display a SDF Panel

When an error is detected while any of these dynamic loading commands is processing, no action is taken to change the existing tree structure or panel definitions. For example, if one of several panels defined or referenced by

%INCLUDE statements in a panel definition member contains an error, none of the panels are placed into active use. Similarly, if an error is detected in a panel you attempt to load using the SCREEN command, the panel is not displayed.

Verifying Dynamic Loading of Panels

Use the SCREEN command to verify that a panel was correctly loaded. See “SCREEN” on page 255 for the SCREEN command description.

You might want to create a test version of a panel you are modifying and display it using the SCREEN command to verify that your changes are correct. To do this:

1. Copy the existing panel definition member into another panel definition member.
2. Modify the panel definition statements in the new panel definition member. Use a different name for the panel on the PANEL statement.
3. Use the SCREEN command to verify that the changes to the panel are correct.
4. If you see anything in the displayed panel that should change, correct the panel definition statements.
5. Rename the panel to the name used for the production version of the panel. To do this, change the name specified on the PANEL statement.
6. Use the SDFPANEL command to load the new panel and put it into production. This SDFPANEL command causes the new panel to overwrite the old panel.

SCREEN

Appendix. Invoking I/O Operations By a REXX EXEC

Rules for Calls by a REXX EXEC

Separate the parameters as follows:

- If the REXX EXEC uses the address link invocation to call the API, the parameters must be separated by blanks as shown:
`address link 'IHVAPI' parm1 ... parmn`
- If the REXX EXEC uses the REXX call to call the API, the parameters must be separated by commas as shown:
`call 'IHVAPI' parm1,parm2,parm3,...`

Specify the following variables:

ihvrc To receive the return code

ihvreas
To receive a reason code

ihvresp
As the response area to receive the command output if there is any

When specifying the variables listed above, note the following:

- The return code is in printable *decimal* format, while the reason code is in printable *hexadecimal* format. See *SA OS/390 Messages and Codes* for a list of reason codes.
- A return code and reason code are not provided if more parameters were specified in the input parameter list than are allowed for a REXX EXEC. A REXX error message is sent instead.
- If **ihvrc** and **ihvreas** are not specified, I/O operations can still process the command. However, the EXEC might not be able to check whether the command was processed successfully because no return code or reason code can be checked.
- If **ihvresp** is not specified, I/O operations can process the command but cannot return data to the REXX EXEC.

Literal Values

If the REXX EXEC calls I/O operations using literal values, the literal value for each parameter should be enclosed in single quotes (') to avoid ambiguity during processing.

Optional Variables

Optionally, a REXX EXEC caller can:

- Set a variable equal to the name of the command being specified
- Set a variable for each operand and option associated with the command being specified.

Two Examples of REXX EXEC Calls

An Example of a Call to Connect Two Ports

In the following example, the caller enters the CONNECT command to connect port *C0* statically—or dedicate it—to port *E0* on switch *100*.

```
/* Connect EXEC */
ihvrc = 0                               /* Return code must be called */
                                         /*                               */
ihvreas = 0                             /* Reason code must be called */
                                         /* ihvreas. Name must be in EXEC. */
                                         /*                               */
ihvresp = ' '                           /* Response area must be called */
                                         /* ihvresp. Name must be in EXEC. */
                                         /*                               */
parm1 = 'CONNECT'                       /* Command name */
parm2 = '(C0)'                          /* First port address (operand) */
parm3 = '(E0)'                          /* Second port address (operand) */
parm4 = '0100'                          /* Switch device number (operand) */
parm5 = 'NOFORCE'                       /* These are the default options */
parm5 = 'VARY'                          /* that do not have to be */
parm7 = 'BACKOUT'                       /* specified in the EXEC. */
```

If the caller uses the address link invocation:

```
address link 'IHVAPI' parm1 parm2 parm3 parm4 parm5 parm6 parm7
say "RETURN CODE = " ihvrc
say "REASON CODE = " ihvreas
say "RESPONSE AREA = " ihvresp
/* Assume screen is 80 characters - */
/* Will appear to be printing 80-character records */

EXIT
```

If the caller uses the REXX call:

```
call 'IHVAPI' parm1,parm2,parm3,parm4,parm5,parm6,parm7
say "RETURN CODE = " ihvrc
say "REASON CODE = " ihvreas
say "RESPONSE AREA = " ihvresp
/* Assume screen is 80 characters - */
/* Will appear to be printing 80-character records */

EXIT
```

A Generalized Example of a REXX EXEC Call

When processed, the following REXX EXEC can be used to enter any I/O operations command. The 80-character output is assumed to be in message format, so QUERY output will not be readable.

```
/*                               */
/* Initialization */
/*                               */
linelength = 80                  /* length of 1 response line */
/*                               */
/* Get the command as specified by the user */
/*                               */
Parse Upper Arg IHVX1 IHVX2 IHVXPARMS
/*                               */
/* Correct basic syntax errors for the user */
/*                               */
/* - Capitalize command keywords (must be caps for IHV) */
/* - Strip out extraneous blanks (must have only 1 for IHV) */
/*                               */
IHVXCMD = Space(IHVX1 IHVX2 IHVXPARMS,1)
Drop IHVX1 IHVX2 IHVXPARMS
/*
```

```

/* Tell the user what we are about to do          */
/*                                                */
Say 'Issuing the IHV command:' IHVXCMD          */
/*                                                */
/* Issue the command                             */
/*                                                */
Address LINK 'IHVAPI' IHVXCMD                   */
If IHVRC > 4                                     */
Then                                           /* Command failed */
Do;
    Say 'Return code:' IHVRC 'Reason code:' IHVREAS
End;
/*                                                */
/* Show the user the response from the command   */
/*                                                */
Do lineindex = 1 to Length(IHVRESP) by lineindex;
    Say Substr(IHVRESP,lineindex,lineindex);
End;
/*                                                */
/* Return to the caller                          */
/*                                                */
Exit IHVRC;

```

Calling a Program That Uses the CALL Macro

General Information

I/O operations allows a program that uses the CALL macro to invoke either IHVAPI2 or IHVAPI.

The Parameter Lists

The caller must pass a variable-length parameter list, where:

- Each item in the list is an address of a parameter in the calling program. (The language in which the program is written must allow the program to alter the parameters for return code, reason code, and response area.)
- The high-order bit of the last parameter address must be set to 1 to indicate the end of the list.
- Register 0 must be set to 0 (zero) so that I/O operations knows the invocation is from an assembled user program, and not an interpreted REXX EXEC.
- Register 1 must contain the address of the parameter list.

The Caller Should Check Register 15 Upon Return From the Call

If not enough parameters were passed on the CALL, I/O operations returns a reason code of X'D0xx0001' in register 15. This code specifies that either an empty or an incorrect parameter list has been sent.

- If IHVAPI2 was invoked, at least 5 parameters are needed: the command name and the last four variables listed in 262.
- If IHVAPI was invoked, at least 4 parameters are needed: the command name and the variables listed in 262.

If more than 25 parameters were passed on the CALL, I/O operations returns a reason code of X'D0xx0007' in register 15. This code specifies that the list contained too many parameters.

For a comparison between IHVAPI2 and IHVAPI, refer to “Calling the I/O Operations API” on page 133.

Calling a Program that Uses IHVAPI2

Pass the Following Parameters in the Parameter List:

- One 38-character variable (padded on the right with blanks) equal to the name of the I/O operations command being specified.
- As many 38-character variables (each padded on the right with blanks) as needed for the operands in the command with the following exceptions:
 - For a range, specify a 71-character variable.
 - For an array, data block, or table, specify a variable long enough to contain it.
- As many 38-character variables (each padded on the right with blanks) as needed for the options associated with the command.
- As the fourth-from-last and the third-from-last variables, specify information related to the response area. Because these two parameters are interdependent, they are listed in the table following this list.
- As the second-from-last (or next-to-last) variable, specify a 4-byte field in hexadecimal format for the return code.
- As the last variable, specify a 4-byte field in hexadecimal format for the reason code.

4th-From-Last Parameter	3rd-From-Last Parameter	When the Response Area Is To Be Managed By:
0 (zero)	any value	I/O operations with a new output buffer
Response area address	0 (zero)	I/O operations with a re-used output buffer
Response area address	Response area length	Caller

Notes:

1. Initialize the response area.
2. If I/O operations manages the response area, the caller must not modify any of the fields in the prefix area, which is described in "A Prefix Area Can Precede the Response Area". If a field is modified, the results are unpredictable.
3. On return from the call, I/O operations puts the length of the response area that it used in the third-from-last parameter. It returns a length of 0 (zero) if no response data is returned. Therefore, the caller should save the input value of this parameter before invoking I/O operations.
4. If the caller manages the response area, the caller should update the third-from-last parameter for each invocation.

To Invoke IHVAPI2, Specify the Following:

CALL IHVAPI2,addrPARM1, ... addrPARMn

A Prefix Area Can Precede the Response Area

If I/O operations manages the response area, it returns a prefix area as well. Use the following information when you need to release these areas.

- x Is the address of the response area, which is contained in the fourth-from-last parameter.
- x-4 Is the 4-byte address of the prefix area, which immediately precedes the response area.
- x-12 Bytes is the 1-byte 'subpool number '0'.
- x-16 Bytes is the 4-byte length of the prefix area plus the contiguous response area.

For further information, refer to "General Information about the Response Area" on page 134 and to the following example.

An Example of a Caller Invoking IHVAPI2

```

ESCMSAMP CSECT
*****
* Issue multisystem QUERY INTERFACE Switch to get switch port
* information. R1 points to a 4 character switch device number.
*****
MVC SWITCH_DEVICE(4),0(R1)  Get Switch device number
MVC HNUM+14(4),0(R1)       Set number in query command
SR  R0,R0                  Required by I/O Operations
CALL IHVAPI2,(QUERY,INTERFACE,SWITCH,HNUM,VALUE,          X
             ASTERISK,SCOPE,VALUE,ASTERISK,              X
             QIS@,QISLENGTH,RC,REASON),VL
CLC RC,=F'0'              0 means all hosts responded ok
BNE FREE                  If not, then free storage
*****
* Map the QUERY INTERFACE Switch row data.
*****
QISOK  L    R10,QIS@                Point to I/O Operations output area
USING QISINFO,R10              Map query interface info
LH    R9,HDRSIZE                  Get the QIS header size
AR    R9,R10                      Point to the first port row
USING PORTROW,R9               Map port interface row
:
*****
* A port that needs blocking is found, so block it.
*****
UNPK  PORTNUMBER+1(3),PORTNUM(2)  Convert 1 byte hex port
TR    PORTNUMBER+1(2),TRANTAB-C'0' number to EBCDIC
MVI   PORTNUMBER+3,C')'          Restore trailing ")"
MVC   BLKLENGTH,=F'0'           Let manage the buffer
SR    R0,R0                      Required by I/O Operations
CALL  IHVAPI2,(BLOCK,PORTNUMBER,SWITCH_DEVICE,          X
             BLOCK@,BLKLENGTH,RC,REASON),VL
CLC   RC,=F'4'                  Block worked?
BNE   NOBLOCK                   No, then process error
:
*****
* Now done with ESCM obtained storage, so release it.
*****
DROP  R10
FREE  L    R10,QIS@                Get Query output buffer
C     R10,=F'0'                  I/O Operations Query buffer exists?
BE    CONTINUE                  No, continue
S     R10,=F'16'                 Address I/O Operations Query buffer
USING ESCMPREFIX,R10
L     R2,BUFLLENGTH              Get buffer length
L     R3,BUFSUBPOOL              Get buffer subpool
STORAGE RELEASE,LENGTH=(R2),ADDR=BUF@,SP=(R3)
L     R10,BLOCK@                 Get Block output buffer
C     R10,=F'0'                  I/O Operations Block buffer exists?
BE    CONTINUE                  No, continue
S     R10,=F'16'                 Address I/O Operations Query buffer
L     R2,BUFLLENGTH              Get buffer length
L     R3,BUFSUBPOOL              Get buffer subpool
STORAGE RELEASE,LENGTH=(R2),ADDR=BUF@,SP=(R3)
:
*****
* I/O Operations API parameters
*****
QIS@      DC    A(0)
QISLENGTH DC    F'0'
BLOCK@    DC    A(0)

```

```

BLKLENGTH    DC    F'0'
RC           DC    F'0'
REASON       DC    F'0'
QUERY        DC    CL38'QUERY'
INTERFACE     DC    CL38'INTERFACE'
SWITCH       DC    CL38'SWITCH'
VALUE        DC    CL38'VALUE'
ASTERISK     DC    CL38'*'
SCOPE        DC    CL38'SCOPE'
BLOCK        DC    CL38'BLOCK'
HNUM         DC    CL38'HNUM(THIS-SYS.XXXX)'
PORTNUMBER   DC    C'(',CL2' ',C')',CL34' '
SWITCH_DEVICE DC    CL38' '
*
TRANTAB      DC    CL16'0123456789ABCDEF'
*
QISINFO      DSECT                                QUERY INTERFACE Switch output
DS          CL4
HDRSIZE      DS    H                                Size of this header
ROWSIZE      DS    H                                Size of each row
DS          CL44
NUMROWS      DS    F                                Number of rows
*
PORTROW      DSECT
PORTNUM      DS    XL1                              Port number
DS          CL155
ROWCODE      DS    F                                Query row code (see below)
PORTROW      EQU    0                                Port row with no error
SUMMROW      EQU    X'5100FFFF'                    Summary row
*
ESCOMPREFIX  DSECT                                I/O Operations supplied buffer info
BUFLNGTH    DS    F                                Buffer length
BUFSUBPOOL  DS    FL1                              Subpool number
DS          F
BUF@        DS    A                                Buffer address
:

```

Calling a Program That Uses IHVAPI

Pass the Following Parameters in the Parameter List:

- A 24-character variable (padded on the right with blanks) equal to the name of the I/O operations command being specified.
- A 24-character variable (padded on the right with blanks) for each operand in the command—with the exception of an operand that contains an array, data block, or table. In these cases, specify a variable that is long enough to contain the item. (Note, however, that I/O operations only uses 64KB of the response area on an IHVAPI call.)
- A 24-character variable (padded on the right with blanks) for each option in the command.
- As the third-from-last variable, specify the address of the response area. (Initialize the response area.)

When a caller invokes IHVAPI, I/O operations can return up to 64KB of data in the response area. If the command output exceeds this amount, I/O Operations fills the response area and notifies the caller that an overflow condition has occurred. Assume, however, that an area of 24KB is sufficient for most commands. Exceptions can be such commands as the DISPLAY DEVICE, DISPLAY RESULTS, DISPLAY VARY, QUERIES, REMOVE DEV, and RESTORE DEV commands.

- As the second-from-last variable, specify a 4-byte field in hexadecimal format for the return code.

- As the last variable, specify a 4-byte field in hexadecimal format for the reason code.

To Call IHVAPI, Specify the Following:

```
CALL IHVAPI,(CMD,PARM1,...,PARMn,IHVRESP,IHVRC,IHVREAS),VL
```

Glossary

This glossary includes terms and definitions from:

- The *IBM Dictionary of Computing* New York: McGraw-Hill, 1994.
- The *American National Standard Dictionary for Information Systems*, ANSI X3.172-1990, copyright 1990 by the American National Standards Institute (ANSI). Copies can be purchased from the American National Standards Institute, 1430 Broadway, New York, New York 10018. Definitions are identified by the symbol (A) after the definition.
- The *Information Technology Vocabulary* developed by Subcommittee 1, Joint Technical Committee 1, of the International Organization for Standardization and the International Electrotechnical Commission (ISO/IEC JTC1/SC1). Definitions of published parts of this vocabulary are identified by the symbol (I) after the definition; definitions taken from draft international standards, committee drafts, and working papers being developed by ISO/IEC JTC1/SC1 are identified by the symbol (T) after the definition, indicating that final agreement has not yet been reached among the participating National Bodies of SC1.

The following cross-references are used in this glossary:

Contrast with. This refers to a term that has an opposed or substantively different meaning.

Deprecated term for. This indicates that the term should not be used. It refers to a preferred term, which is defined in its proper place in the glossary.

See. This refers the reader to multiple-word terms in which this term appears.

See also. This refers the reader to terms that have a related, but not synonymous, meaning.

Synonym for. This indicates that the term has the same meaning as a preferred term, which is defined in the glossary.

Synonymous with. This is a backward reference from a defined term to all other terms that have the same meaning.

A

ACF. Automation control file.

ACF/NCP. Advanced Communications Function for the Network Control Program. See *Advanced Communications Function* and *Network Control Program*.

ACF/VTAM. Advanced Communications Function for the Virtual Telecommunications Access Method. Synonym for *VTAM*. See *Advanced Communications Function* and *Virtual Telecommunications Access Method*.

ACO. Automated console operations.

active monitoring. In System Automation for OS/390, the acquiring of resource status information by soliciting such information at regular, user-defined intervals. See also *passive monitoring*.

adapter. Hardware card that enables a device, such as a workstation, to communicate with another device, such as a monitor, a printer, or some other I/O device.

Address Space Workflow. In RMF, a measure of how a job uses system resources and the speed at which the job moves through the system. A low workflow indicates that a job has few of the resources it needs and is contending with other jobs for system resources. A high workflow indicates that a job has all the resources it needs to execute.

adjacent hosts. Systems connected in a peer relationship using adjacent NetView sessions for purposes of monitoring and control.

adjacent NetView. In System Automation for OS/390, the system defined as the communication path between two System Automation for OS/390 systems that do not have a direct link. An adjacent NetView is used for message forwarding and as a communication link between two System Automation for OS/390 systems. For example, the adjacent NetView is used when sending responses from a focal point to a remote system.

Advanced Communications Function (ACF). A group of IBM licensed programs (principally VTAM, TCAM, NCP, and SSP) that use the concepts of Systems Network Architecture (SNA), including distribution of function and resource sharing.

advanced program-to-program communication (APPC). A set of inter-program communication services that support cooperative transaction processing in a Systems Network Architecture (SNA) network. APPC is the implementation, on a given system, of SNA's logical unit type 6.2.

alert. (1) In SNA, a record sent to a system problem management focal point or to a collection point to communicate the existence of an alert condition. (2) In

NetView, a high-priority event that warrants immediate attention. A database record is generated for certain event types that are defined by user-constructed filters.

alert condition. A problem or impending problem for which some or all of the process of problem determination, diagnosis, and resolution is expected to require action at a control point.

alert focal—point system. See entry for NPDA focal-point system under *focal—point system*.

alert threshold. An application or volume service value that determines the level at which System Automation for OS/390 changes the associated icon in the graphic interface to the alert color. System Automation for OS/390 may also issue an alert. See *warning threshold*.

APF. Authorized program facility.

API. Application programming interface.

APPC. Advanced program-to-program communications.

application. An OS/390 subsystem or job monitored by System Automation for OS/390.

Application entry. A construct, created with the customization dialogs, used to represent and contain policy for an application.

application group. A named set of applications. An application group is part of a System Automation for OS/390 enterprise definition and is used for monitoring purposes.

ApplicationGroup entry. A construct, created with the customization dialogs, used to represent and contain policy for an application group.

application program. (1) A program written for or by a user that applies to the user's work, such as a program that does inventory or payroll. (2) A program used to connect and communicate with stations in a network, enabling users to perform application-oriented activities.

ARM. Automatic restart management.

ASCB. Address space control block.

ASCB status. An application status derived by System Automation for OS/390 running a routine (the ASCB checker) which searches the OS/390 address space control blocks (ASCBs) for address spaces with a particular job name. The job name used by the ASCB checker is the job name defined in the customization dialog for the application.

ASCII (American National Standard Code for Information Interchange). The standard code, using a coded character set consisting of 7-bit coded characters

(8-bits including parity check), for information interchange among data processing systems, data communication systems, and associated equipment. The ASCII set consists of control characters and graphic characters. (A)

ASF. Automation status file.

assist mode facility. A System Automation for OS/390 facility that uses SDF and enables interaction with automation before System Automation for OS/390 takes an automation action. SDF prompts the operator with a suggested action, then provides options for using that action, modifying and using the action, or canceling the action. Also called assist mode, it is enabled using the customization dialogs, or dynamically.

authorized program facility (APF). A facility that permits identification of programs that are authorized to use restricted functions.

automated function. System Automation for OS/390 automated functions are automation operators, NetView autotasks that are assigned to perform specific automation functions. However, System Automation for OS/390 defines its own synonyms, or *automated function names*, for the NetView autotasks, and these function names are referred to in the sample policy databases provided by System Automation for OS/390. For example, the automation operator AUTBASE corresponds to the System Automation for OS/390 automated function BASEOPER.

automated console operations (ACO). The concept (versus a product) of using computers to perform a large subset of tasks ordinarily performed by operators, or assisting operators in performing these tasks.

automatic restart management. An OS/390 recovery function that improves the availability of specified subsystems and applications by automatically restarting them under certain circumstances. Automatic restart management is a function of the Cross-System Coupling Facility (XCF) component of OS/390.

automatic restart management element name. In MVS 5.2 or later, OS/390 automatic restart management requires the specification of a unique sixteen character name for each address space which registers with it. All automatic restart management policy is defined in terms of the element name, including System Automation for OS/390's interface with it.

automation. The automatic initiation of actions in response to detected conditions or events. System Automation for OS/390 provides automation for OS/390 applications, OS/390 components, and remote systems that run OS/390. System Automation for OS/390 also provides tools that can be used to develop additional automation.

automation control file (ACF). In System Automation for OS/390, a file that contains system-level automation policy information. There is one master automation control file for each NetView system on which System Automation for OS/390 is installed. Additional policy information and all resource status information is contained in the *OIB* (operational information base). The System Automation for OS/390 customization dialogs must be used to build the automation control files. They must not be edited manually.

automation flags. In System Automation for OS/390, the automation policy settings that determine the operator functions that are automated for a resource and the times during which automation is active. When System Automation for OS/390 is running, automation is controlled by automation flag policy settings and override settings (if any) entered by the operator. Automation flags are set using the customization dialogs.

Automation NetView. In System Automation for OS/390 the NetView that performs routine operator tasks with command procedures or uses other ways of automating system and network management, issuing automatic responses to messages and management services units.

automation operator. Automation operators are NetView autotasks that are assigned to perform specific automation functions. See also *automated functions*.

automation policy. The policy information governing automation for individual systems. This includes automation for applications, OS/390 subsystems, OS/390 data sets, and OS/390 components.

automation policy settings. The automation policy information contained in the automation control file. This information is entered using the customization dialogs. You can display or modify these settings using the customization dialogs.

automation procedure. A sequence of commands, packaged as a NetView command list or a command processor written in a high-level language. An automation procedure performs automation functions and runs under NetView.

automation status file. In System Automation for OS/390, a file containing status information for each automated subsystem, component or data set. This information is used by System Automation for OS/390 automation when taking action or when determining what action to take. In Release 2 and above of AOC/MVS, status information is also maintained in the operational information base.

automation table. See *NetView automation table*.

autotask. A NetView automation task that receives messages and processes automation procedures. There are no logged-on users associated with autotasks. Each

autotask is an operating system task and runs concurrently with other NetView tasks. An autotask could be set up to handle JES2 messages that schedule automation procedures, and an automation statement could route such messages to the autotasks. Similar to *operator station task*. System Automation for OS/390 message monitor tasks and target control tasks are autotasks. Also called *automation operator*.

available. In VTAM programs, pertaining to a logical unit that is active, connected, enabled, and not at its session limit.

B

basic mode. A central processor mode that does not use logical partitioning. Contrast with *logically partitioned (LPAR) mode*.

BCP Internal Interface. Processor function of CMOS-390, zSeries processor families. It allows the communication between basic control programs such as z/OS and the processor support element in order to exchange information or to perform processor control functions. Programs using this function can perform hardware operations such as ACTIVATE or SYSTEM RESET.

beaconing. The repeated transmission of a frame or messages (beacon) by a console or workstation upon detection of a line break or outage.

BookManager. An IBM product that lets users view softcopy documents on their workstations.

C

central processor (CP). The part of the computer that contains the sequencing and processing facilities for instruction execution, initial program load (IPL), and other machine operations.

central processor complex (CPC). A physical collection of hardware that consists of central storage, one or more central processors, timers, and channels.

central site. In a distributed data processing network, the central site is usually defined as the focal point for alerts, application design, and remote system management tasks such as problem management.

CFR/CFS and ISC/ISR. I/O operations can display and return data about integrated system channels (ISC) connected to a coupling facility and coupling facility receiver (CFR) channels and coupling facility sender (CFS) channels.

channel. A path along which signals can be sent; for example, data channel, output channel. See also *link*.

channel path identifier. A system-unique value assigned to each channel path.

CHPID. In System Automation for OS/390, channel path ID; the address of a channel.

CHPID port. A label that describes the system name, logical partitions, and channel paths.

channel-attached. (1) Attached directly by I/O channels to a host processor (for example, a channel-attached device). (2) Attached to a controlling unit by cables, rather than by telecommunication lines. Contrast with *link-attached*. Synonymous with *local*.

CI. Console integration.

CICS/VS. Customer Information Control System for Virtual Storage.

CLIST. Command list.

clone. A set of definitions for application instances which are derived from a basic application definition by substituting a number of different system-specific values into the basic definition.

clone ID. A generic means of handling system-specific values such as the MVS SYSCClone or the VTAM subarea number. Clone IDs can be substituted into application definitions and commands to customize a basic application definition for the system that it is to be instantiated on.

CNC. A channel path that transfers data between a host system image and an ESCON control unit. It can be point-to-point or switchable.

command. A request for the performance of an operation or the execution of a particular program.

command facility. The component of NetView that is a base for command processors that can monitor, control, automate, and improve the operation of a network. The successor to NCCF.

command list (CLIST). (1) A list of commands and statements, written in the NetView command list language or the REXX language, designed to perform a specific function for the user. In its simplest form, a command list is a list of commands. More complex command lists incorporate variable substitution and conditional logic, making the command list more like a conventional program. Command lists are typically interpreted rather than being compiled. (2) In System Automation for OS/390, REXX command lists that can be used for automation procedures.

command procedure. In NetView, either a command list or a command processor.

command processor. A module designed to perform a specific function. Command processors, which can be written in assembler or a high-level language (HLL), are issued as commands.

common commands. The System Automation for OS/390 subset of the CPC operations management commands.

common routine. One of several System Automation for OS/390 programs that perform frequently used automation functions. Common routines can be used to create new automation procedures.

Common User Access (CUA) architecture. Guidelines for the dialog between a human and a workstation or terminal.

communication controller. A type of communication control unit whose operations are controlled by one or more programs stored and executed in the unit or by a program executed in a processor to which the controller is connected. It manages the details of line control and the routing of data through a network.

communication line. Deprecated term for *telecommunication line*.

communication path. A set of communication facilities that System Automation for OS/390 uses to connect a focal-point system to a target system.

configuration dialogs. A user interface for entering the information that defines the System Automation for OS/390 configuration. In System Automation for OS/390 the configuration dialogs are an ISPF application.

connectivity view. In System Automation for OS/390, a display that uses graphic images for I/O devices and lines to show how they are connected.

console automation. The process of having NetView facilities provide the console input usually handled by the operator.

console integration (CI). A hardware facility which if supported by an operating system, allows operating system messages to be transferred through an internal hardware interface for display on a system console. Conversely, it allows operating system commands entered at a system console to be transferred through an internal hardware interface to the operating system for processing.

consoles. Workstations and 3270-type devices that manage your enterprise.

Control units. Hardware units that control I/O operations for one or more devices. You can view information about control units through I/O operations, and can start or stop data going to them by blocking and unblocking ports.

controller. A unit that controls I/O operations for one or more devices.

couple data set. A data set that is created through the XCF couple data set format utility and, depending on its designated type, is shared by some or all of the OS/390 systems in a sysplex. See also *sysplex couple data set* and *XCF couple data set*.

coupling facility. The hardware element that provides high-speed caching, list processing, and locking functions in a sysplex.

CP. Central processor.

CPC. Central processor complex.

CPC operations management commands. A set of commands and responses for controlling the operation of System/390 CPCs.

CPC subset. All or part of a CPC. It contains the minimum *resource* to support a single control program.

CPCB. Command processor control block; an I/O operations internal control block that contains information about the command being processed.

CPU. Central processing unit. Deprecated term for *processor*.

cross-system coupling facility (XCF). XCF is a component of OS/390 that provides functions to support cooperation between authorized programs running within a sysplex.

CTC. The channel-to-channel (CTC) channel can communicate with a CTC on another host for intersystem communication.

Customer Information Control System (CICS). A general-purpose transactional program that controls online communication between terminal users and a database for a large number of end users on a real-time basis.

customization dialogs. The customization dialogs are an ISPF application. They are used to customize the enterprise policy, like, for example, the enterprise resources and the relationships between resources, or the automation policy for systems in the enterprise. How to use these dialogs is described in *System Automation for OS/390 Customizing and Programming*.

CVC. A channel operating in converted (CVC) mode transfers data in blocks and a CBY channel path transfers data in bytes. Converted CVC or CBY channel paths can communicate with a parallel control unit. This resembles a point-to-point parallel path and dedicated connection, regardless whether it passes through a switch.

D

DASD. Direct access storage device.

data services task (DST). The NetView subtask that gathers, records, and manages data in a VSAM file or a network device that contains network management information.

data set. The major unit of data storage and retrieval, consisting of a collection of data in one of several prescribed arrangements and described by control information to which the system has access.

data set members. Members of partitioned data sets that are individually named elements of a larger file that can be retrieved by name.

DBCS. Double-byte character set.

DCCF. Disabled console communication facility.

DCF. Document composition facility.

DELAY Report. An RMF report that shows the activity of each job in the system and the hardware and software resources that are delaying each job.

Devices. You can see information about all devices (such as printers, tape or disk drives, displays, or communications controllers) attached to a particular switch, and control paths and jobs to devices.

DEV Report. An RMF report that presents information about the activity of I/O devices that are delaying jobs.

dialog. Interactive 3270 panels.

direct access storage device (DASD). A device in which the access time is effectively independent of the location of the data; for example, a disk.

disabled console communication facility (DCCF). An OS/390 component that provides limited-function console communication during system recovery situations.

display. (1) To present information for viewing, usually on the screen of a workstation or on a hard-copy device. (2) Deprecated term for *panel*.

distribution manager. The component of the NetView program that enables the host system to use, send, and delete files and programs in a network of computers.

domain. (1) An access method and its application programs, communication controllers, connecting lines, modems, and attached workstations. (2) In SNA, a system services control point (SSCP) and the physical units (PUs), logical units (LUs), links, link stations, and associated resources that the SSCP can control by means of activation requests and deactivation requests.

double-byte character set (DBCS). A character set, such as Kanji, in which each character is represented by a 2-byte code.

DP enterprise. Data processing enterprise.

DSIPARM. This file is a collection of members of NetView's DSIPARM data set. It determines how automation is applied to resources.

DST. Data Services Task.

E

EBCDIC. Extended binary-coded decimal interchange code. A coded character set consisting of 8-bit coded characters.

ECB. Event control block. A control block used to represent the status of an event.

EMCS. Extended multiple console support.

enterprise. An organization, such as a business or a school, that uses data processing.

enterprise monitoring. Enterprise monitoring is used by System Automation for OS/390 to update the *NetView Graphic Monitor Facility (NGMF)* resource status information which is stored in the *Resource Object Data Manager (RODM)*. Resource status information is acquired by enterprise monitoring of the *Resource Measurement Facility (RMF) Monitor III* service information at user-defined intervals. System Automation for OS/390 stores this information in its operational information base, where it is used to update the information presented to the operator in graphic displays.

entries. Resources, such as processors, entered on panels.

environment. Data processing enterprise.

error threshold. An automation policy setting that specifies when System Automation for OS/390 should stop trying to restart or recover an application, subsystem or component, or offload a data set.

ESA. Enterprise Systems Architecture.

eServer. Processor family group designator used by the System Automation for OS/390 customization dialogs to define a target hardware as member of the zSeries or 390-CMOS processor families.

event. (1) In NetView, a record indicating irregularities of operation in physical elements of a network. (2) An occurrence of significance to a task; for example, the completion of an asynchronous operation, such as an input/output operation. (3) Events are part of a trigger condition, in a way that if all events of a trigger condition have occurred, a *STARTUP* or *SHUTDOWN* of an application is performed.

exception condition. An occurrence on a system that is a deviation from normal operation. System

Automation for OS/390 monitoring highlights exception conditions and allows an System Automation for OS/390 enterprise to be managed by exception.

extended recovery facility (XRF). A facility that minimizes the effect of failures in OS/390, VTAM, the host processor, or high availability applications during sessions between high availability applications and designated terminals. This facility provides an alternate subsystem to take over sessions from the failing subsystem.

F

fallback system. See *secondary system*.

field. A collection of bytes within a record that are logically related and are processed as a unit.

file manager commands. A set of System Automation for OS/390 commands that read data from or write data to the automation control file or the operational information base. These commands are useful in the development of automation that uses System Automation for OS/390 facilities.

focal point. In NetView, the focal-point domain is the central host domain. It is the central control point for any management services element containing control of the network management data.

focus host. A processor with the role in the context of a unified system image

focal-point system. (1) A system that can administer, manage, or control one or more target systems. There are a number of different focal-point systems associated with IBM automation products. (2) **System Automation for OS/390 automation focal-point system.** The System Automation for OS/390 automation focal-point system is an System Automation for OS/390 NetView system that collects status information from other System Automation for OS/390 NetViews within your enterprise. It is supported by System Automation for OS/390, which uses NetView NNT/OST sessions to forward information to it. (3) **System Automation for OS/390 customization focal-point system.** The System Automation for OS/390 customization focal point is the system on which System Automation for OS/390 is installed. The System Automation for OS/390 policy databases exist on this system and are built into automation control file fragments, RODM load function files, and processor control file on this system (if this is being done using System Automation for OS/390). (4) **NGMF focal—point system.** The NGMF focal-point system is a NetView system with an attached workstation server and LAN which gathers information about the state of the network. This focal-point system uses RODM to store the data it collects in the GMFHS data model. The information stored in RODM can be accessed from any LAN-connected workstation with NetView Graphic Monitor Facility installed. (5) **NPDA**

focal-point system. This is a NetView system which collects all the NPDA alerts that are generated within your enterprise. It is supported by NetView. If you have System Automation for OS/390 installed the NPDA focal-point system must be the same as your NGMF focal-point system. The NPDA focal-point system is also known as the *alert focal-point system*. (6) **Status focal-point system.** In NetView, the system to which STATMON, VTAM and NLDM send status information on network resources. If you have a GMFHS focal point, it must be on the same system as the Status focal point. (7) **System Automation for OS/390 focal-point system.** This is a NetView system that has System Automation for OS/390 host code installed, and network connections to a number of System Automation for OS/390 workstations. The System Automation for OS/390 focal-point system receives messages from the systems and operator consoles of the machines it controls. It provides full systems and operations console function for its target systems. It can be used to IPL these systems. Note that some restrictions apply to the Hardware Management Console for an S/390 microprocessor cluster. (8) **Hardware Management Console.** Although not listed as a focal point, the Hardware Management Console acts as a focal point for the console functions of an S/390 microprocessor cluster. Unlike all the other focal points in this definition, the Hardware Management Console runs on a LAN-connected workstation,

frame. For a System/390 microprocessor cluster, a frame contains one or two central processor complexes (CPCs), support elements, and AC power distribution.

full-screen mode. In NetView, a form of panel presentation that makes it possible to display the contents of an entire workstation screen at once. Full-screen mode can be used for fill-in-the-blanks prompting. Contrast with *line mode*.

G

gateway session. An NetView-NetView Task session with another system in which the System Automation for OS/390 outbound gateway operator logs onto the other NetView session without human operator intervention. Each end of a gateway session has both an inbound and outbound gateway operator.

generic alert. Encoded alert information that uses code points (defined by IBM and possibly customized by users or application programs) stored at an alert receiver, such as NetView.

generic routines. In System Automation for OS/390, a set of self-contained automation routines that can be called from the NetView automation table, or from user-written automation procedures.

graphic workstation. The graphic workstation is the primary way to dynamically monitor System

Automation for OS/390 systems. From the windows, you see messages, monitor status, view trends, and react to changes before they cause problems for end users. You can use multiple windows to monitor multiple views of the system.

group. A collection of target systems defined through configuration dialogs. An installation might set up a group to refer to a physical site or an organizational or application entity.

Group entry. A construct, created with the customization dialogs, used to represent and contain policy for a group.

H

Hardware Management Console. A console used by the operator to monitor and control a System/390 microprocessor cluster.

Hardware Management Console Application (HWMCA). A direct-manipulation object-oriented graphical user interface that provides single point of control and single system image for hardware elements. HWMCA provides customer grouping support, aggregated and real-time system status using colors, consolidated hardware messages support, consolidated operating system messages support, consolidated service support, and hardware commands targeted at a single system, multiple systems, or a customer group of systems.

heartbeat. In System Automation for OS/390, a function which monitors the validity of the status forwarding path between remote systems and the NGMF focal point, and monitors the availability of remote OS/390 systems, to ensure that status information displayed on the System Automation for OS/390 workstation is current.

help panel. An online panel that tells you how to use a command or another aspect of a product.

hierarchy. In the NetView program, the resource types, display types, and data types that make up the organization, or levels, in a network.

high-level language (HLL). A programming language that does not reflect the structure of any particular computer or operating system. For the NetView program, the high-level languages are PL/I and C.

HLL. High-level language.

host system. In a coupled system or distributed system environment, the system on which the facilities for centralized automation run. System Automation for OS/390 publications refer to target systems or focal-point systems instead of hosts.

host (primary processor). The processor at which you enter a command (also known as the *issuing processor*).

HWMCA. Hardware Management Console Application. Application for the graphic hardware management console that monitors and controls a central processor complex. It is attached to a target processor (a system 390 microprocessor cluster) as a dedicated system console. This microprocessor uses OCF to process commands.

images. A grouping of processors and I/O devices that you define. You can define a single-image mode which allows a multiprocessor system to function as one central processor image.

IMS/VS. Information Management System/Virtual Storage.

inbound. In System Automation for OS/390, messages sent to the focal-point system from the PC or target system.

inbound gateway operator. The automation operator that receives incoming messages, commands, and responses from the outbound gateway operator at the sending system. The inbound gateway operator handles communications with other systems using a gateway session.

Information Management System/Virtual Storage (IMS/VS). A database/data communication (DB/DC) system that can manage complex databases and networks. Synonymous with IMS.

INGEIO PROC. The I/O operations default procedure name; part of the SYS1.PROCLIB.

initial program load (IPL). (1) The initialization procedure that causes an operating system to commence operation. (2) The process by which a configuration image is loaded into storage at the beginning of a workday or after a system malfunction. (3) The process of loading system programs and preparing a system to run jobs.

initialize automation. System Automation for OS/390-provided automation that issues the correct OS/390 start command for each subsystem when System Automation for OS/390 is initialized. The automation ensures that subsystems are started in the order specified in the automation control file and that prerequisite applications are functional.

input/output support processor (IOSP). The hardware unit that provides I/O support functions for the primary support processor and maintenance support functions for the processor controller.

Interactive System Productivity Facility (ISPF). An IBM licensed program that serves as a full-screen editor and dialog manager. Used for writing application programs, it provides a means of generating standard screen panels and interactive dialogs between the application programmer and the terminal user.

interested operator list. The list of operators who are to receive messages from a specific target system.

internal token. A *logical token* (LTOK); name by which the I/O resource or object is known; stored in IODF.

IOCDs. I/O configuration data set. The data set that describes the I/O configuration.

I/O Ops. See *I/O operations*.

I/O resource exception monitoring. I/O resource exception monitoring is a significant System Automation for OS/390 enhancement to the functions of enterprise monitoring. I/O resource exception monitoring dynamically notifies operations personnel when I/O resources fail or become inaccessible. System Automation for OS/390 reports I/O resource exceptions through the enterprise monitoring mechanisms, including NGMF-based graphic displays. If a change in the operational status of an I/O resource is detected by one System Automation for OS/390 system, the visual presentation and associated textual data of that resource is automatically updated for all System Automation for OS/390 focal—point systems. I/O resource exception monitoring does not require definition of the I/O resources to System Automation for OS/390. System Automation for OS/390 dynamically discovers those resources.

IOSP. Input/Output Support Processor.

I/O operations. The part of System Automation for OS/390 that provides you with a single point of logical control for managing connectivity in your active I/O configurations. I/O operations takes an active role in detecting unusual conditions and lets you view and change paths between a processor and an I/O device, using dynamic switching (the ESCON director).

I/O resource number. Combination of channel path identifier (CHPID), device number, etc. See internal token.

IPL. Initial program load.

ISA. Industry Standard Architecture.

ISPF. Interactive System Productivity Facility.

ISPF console. From this 3270-type console you are logged onto ISPF to use the runtime panels for I/O operations and System Automation for OS/390 customization panels.

issuing host. See *primary host*; the base program at which you enter a command for processing.

J

JCL. Job control language.

JES. Job entry subsystem.

job. (1) A set of data that completely defines a unit of work for a computer. A job usually includes all necessary computer programs, linkages, files, and instructions to the operating system. (2) An address space.

job control language (JCL). A problem-oriented language designed to express statements in a job that are used to identify the job or describe its requirements to an operating system.

job entry subsystem (JES). A facility for spooling, job queuing, and managing I/O. In System Automation for OS/390 publications, JES refers to JES2 or JES3, unless distinguished as being either one or the other.

K

Kanji. An ideographic character set used in Japanese. See also *double-byte character set*.

L

LAN. Local area network.

line mode. A form of screen presentation in which the information is presented a line at a time in the message area of the terminal screen. Contrast with *full-screen mode*.

link. (1) In SNA, the combination of the link connection and the link stations joining network nodes; for example, a System/370 channel and its associated protocols, a serial-by-bit connection under the control of synchronous data link control (SDLC). (2) In System Automation for OS/390, link connection is the physical medium of transmission.

link-attached. Describes devices that are physically connected by a telecommunication line. Contrast with *channel-attached*.

Linux for zSeries and S/390. UNIX-like open source operating system conceived by Linus Torvalds and developed across the internet.

local. Pertaining to a device accessed directly without use of a telecommunication line. Synonymous with *channel-attached*.

local area network (LAN). (1) A network in which a set of devices is connected for communication. They

can be connected to a larger network. See also *token ring*. (2) A network in which communications are limited to a moderately sized geographic area such as a single office building, warehouse, or campus, and which do not generally extend across public rights-of-way.

logical partition (LP). A subset of the processor hardware that is defined to support an operating system. See also *logically partitioned (LPAR) mode*.

logical switch number (LSN). Assigned with the switch parameter of the CHPID macro of the IOCP.

logical token (LTOK). Resource number of an object in the IODF.

logical unit (LU). In SNA, a port through which an end user accesses the SNA network and the functions provided by system services control points (SSCPs). An LU can support at least two sessions — one with an SSCP and one with another LU — and may be capable of supporting many sessions with other LUs. See also *physical unit (PU)* and *system services control point (SSCP)*.

logical unit (LU) 6.2. A type of logical unit that supports general communications between programs in a distributed processing environment. LU 6.2 is characterized by (a) a peer relationship between session partners, (b) efficient use of a session for multiple transactions, (c) comprehensive end-to-end error processing, and (d) a generic application program interface (API) consisting of structured verbs that are mapped into a product implementation. Synonym for advanced program-to-program communications (APPC).

logically partitioned (LPAR) mode. A central processor mode that enables an operator to allocate system processor hardware resources among several logical partitions. Contrast with *basic mode*.

LOGR. The sysplex logger.

LP. Logical partition.

LPAR. Logically partitioned (mode).

LU. Logical unit.

LU-LU session. In SNA, a session between two logical units (LUs) in an SNA network. It provides communication between two end users, or between an end user and an LU services component.

LU 6.2. Logical unit 6.2.

LU 6.2 session. A session initiated by VTAM on behalf of an LU 6.2 application program, or a session initiated by a remote LU in which the application program specifies that VTAM is to control the session by using the APPCCMD macro.

M

MCS. Multiple console support.

member. A specific function (one or more modules/routines) of a multisystem application that is defined to XCF and assigned to a group by the multisystem application. A member resides on one system in the sysplex and can use XCF services to communicate (send and receive data) with other members of the same group.

message class. A number that System Automation for OS/390 associates with a message to control routing of the message. During automated operations, the classes associated with each message issued by System Automation for OS/390 are compared to the classes assigned to each notification operator. Any operator with a class matching one of the message's classes receives the message.

message forwarding. The System Automation for OS/390 process of sending messages generated at a System Automation for OS/390 target system to the System Automation for OS/390 focal—point system.

message group. Several messages that are displayed together as a unit.

message monitor task. A task that starts and is associated with a number of communications tasks. Message monitor tasks receive inbound messages from a communications task, determine the originating target system, and route the messages to the appropriate target control tasks.

message processing facility (MPF). An OS/390 table that screens all messages sent to the OS/390 console. The MPF compares these messages with a customer-defined list of messages on which to automate, suppress from the OS/390 console display, or both, and marks messages to automate or suppress. Messages are then broadcast on the subsystem interface (SSI).

message suppression. The ability to restrict the amount of message traffic displayed on the OS/390 console.

microprocessor. A processor implemented on one or a small number of chips.

migration. Installation of a new version or release of a program to replace an earlier version or release.

MP. Multiprocessor.

MPF. Message processing facility.

Multiple Virtual Storage (MVS). An IBM licensed program. MVS, which is the predecessor of OS/390, is an operating system that controls the running of programs on a System/390 or System/370 processor.

MVS includes an appropriate level of the Data Facility Product (DFP) and Multiple Virtual Storage/Enterprise Systems Architecture System Product Version 5 (MVS/ESA SP5).

multiprocessor (MP). A CPC that can be physically partitioned to form two operating processor complexes.

multisystem application. An application program that has various functions distributed across OS/390 images in a multisystem environment.

multisystem environment. An environment in which two or more OS/390 images reside in one or more processors, and programs on one image can communicate with programs on the other images.

MVS. Multiple Virtual Storage, predecessor of OS/390.

MVS image. A single occurrence of the MVS/ESA operating system that has the ability to process work.

MVS/JES2. Multiple Virtual Storage/Job Entry System 2. An OS/390 subsystem that receives jobs into the system, converts them to internal format, selects them for execution, processes their output, and purges them from the system. In an installation with more than one processor, each JES2 processor independently controls its job input, scheduling, and output processing.

MVS/ESA. Multiple Virtual Storage/Enterprise Systems Architecture.

MVS/ESA SP. Multiple Virtual Storage/Enterprise Systems Architecture System Product.

MVS/ESA SP4. Multiple Virtual Storage/ Enterprise Systems Architecture System Product Version 4.

MVS/XA. Multiple Virtual Storage for Extended Architecture.

N

NAU. (1) Network accessible unit. (2) Network addressable unit.

NCCF. Network Communications Control Facility.

NCP. (1) Network Control Program (IBM licensed program). Its full name is Advanced Communications Function for the Network Control Program. Synonymous with *ACF/NCP*. (2) Network control program (general term).

NetView. An IBM licensed program used to monitor a network, manage it, and diagnose network problems. NetView consists of a command facility that includes a presentation service, command processors, automation based on command lists, and a transaction processing structure on which the session monitor, hardware

monitor, and terminal access facility (TAF) network management applications are built.

network accessible unit (NAU). A logical unit (LU), physical unit (PU), control point (CP), or system services control point (SSCP). It is the origin or the destination of information transmitted by the path control network. Synonymous with *network addressable unit*.

network addressable unit (NAU). Synonym for *network accessible unit*.

NetView automation procedures. A sequence of commands, packaged as a NetView command list or a command processor written in a high-level language. An automation procedure performs automation functions and runs under the NetView program.

NetView automation table. A table against which the NetView program compares incoming messages. A match with an entry triggers the specified response. System Automation for OS/390 entries in the NetView automation table trigger a System Automation for OS/390 response to target system conditions.

NetView Command list language. An interpretive language unique to NetView that is used to write command lists.

NetView (NCCF) console. A 3270-type console for NetView commands and runtime panels for system operations and processor operations.

NetView Graphic Monitor Facility (NGMF). A function of the NetView program that provides a graphic, topological presentation of a network that is controlled by the NetView program. It provides the operator different views of a network, multiple levels of graphical detail, and dynamic resource status of the network. This function consists of a series of graphic windows that allows you to manage the network interactively.

NetView hardware monitor. The component of NetView that helps identify network problems, such as hardware, software, and microcode, from a central control point using interactive display techniques. Formerly called *network problem determination application*.

NetView log. The log in which NetView records events pertaining to NetView and System Automation for OS/390 activities.

NetView message table. See *NetView automation table*.

NetView-NetView task (NNT). The task under which a cross-domain NetView operator session runs. Each NetView program must have a NetView-NetView task to establish one NNT session. See *operator station task*.

NetView paths via logical unit (LU 6.2). A type of network-accessible port (VTAM connection) that

enables end users to gain access to SNA network resources and communicate with each other. LU 6.2 permits communication between processor operations and the workstation.

NetView—NetView Task session. A session between two NetView programs that runs under a NetView-NetView Task. In System Automation for OS/390, Netview-NetView Task sessions are used for communication between focal point and remote systems.

network. (1) An interconnected group of nodes. (2) In data processing, a user application network. See *SNA network*.

Network Communications Control Facility (NCCF). The operations control facility for the network. NCCF consists of a presentation service, command processors, automation based on command lists, and a transaction processing structure on which the network management applications NLDM and NPDA are built. NCCF is a precursor to the NetView command facility.

Network Control Program (NCP). An IBM licensed program that provides communication controller support for single-domain, multiple-domain, and interconnected network capability. Its full name is Advanced Communications Function for the Network Control Program.

Networking NetView. In System Automation for OS/390 the NetView that performs network management functions, such as managing the configuration of a network. In System Automation for OS/390 it is common to also route alerts to the Networking NetView.

Network Problem Determination Application (NPDA). An NCCF application that helps you identify network problems, such as hardware, software, and microcode, from a central control point using interactive display methods. The alert manager for the network. The precursor of the NetView hardware monitor.

NGMF. NetView Graphic Monitor Facility.

NGMF focal—point system. See *focal—point system*.

NIP. Nucleus initialization program.

NNT. NetView-NetView task.

notification message. A System Automation for OS/390 message sent to a human notification operator to provide information about significant automation actions. Notification messages are defined using the customization dialogs.

notification operator. A NetView console operator who is authorized to receive System Automation for

OS/390 notification messages. Authorization is made through the customization dialogs.

NPDA. Network Problem Determination Application.

NPDA focal—point system. See *focal—point system*.

NTRI. NCP/token-ring interconnection.

nucleus initialization program (NIP). The program that initializes the resident control program; it allows the operator to request last-minute changes to certain options specified during system generation.

O

objective value. An average Workflow or Using value that System Automation for OS/390 can calculate for applications from past service data. System Automation for OS/390 uses the objective value to calculate warning and alert thresholds when none are explicitly defined.

OCA. In System Automation for OS/390, operator console A, the active operator console for a target system. Contrast with *OCB*.

OCB. In System Automation for OS/390, operator console B, the backup operator console for a target system. Contrast with *OCA*.

OCF. Operations command facility.

OCF-based processor. A central processor complex that uses an operations command facility for interacting with human operators or external programs to perform operations management functions on the CPC. Contrast with *screen-oriented processor*.

OIB. Operational Information Base, a depository of RODM, System Automation for OS/390 policy, and System Automation for OS/390 data model. Each System Automation for OS/390 OS/390 system with has its own OIB. The OIB on the focal—point system maintains the status information.

Policy is defined in the System Automation for OS/390 customization panels, stored and then loaded by a RODM load function file into OIB. Subsequent changes to customization are temporary until RODM again loads them into the OIB.

OPC/A. Operations Planning and Control/Advanced.

OPC/ESA. Operations Planning and Control/Enterprise Systems Architecture.

operating system (OS). Software that controls the execution of programs and that may provide services such as resource allocation, scheduling, input/output control, and data management. Although operating systems are predominantly software, partial hardware implementations are possible. (T)

operations. The real-time control of a hardware device or software function.

operational data base. See *OIB*.

operational information base. See *OIB*.

operations command facility (OCF). A facility of the central processor complex that accepts and processes operations management commands.

Operations Planning and Control/Advanced (OPC/A). A set of IBM licensed programs that automate, plan, and control batch workload. OPC/A analyzes system and workload status and submits jobs accordingly.

Operations Planning and Control/ESA (OPC/ESA). A set of IBM licensed programs that automate, plan, and control batch workload. OPC/ESA analyzes system and workload status and submits jobs accordingly. The successor to OPC/A.

operator. (1) A person who keeps a system running. (2) A person or program responsible for managing activities controlled by a given piece of software such as OS/390, the NetView program, or IMS. (3) A person who operates a device. (4) In a language statement, the lexical entity that indicates the action to be performed on operands.

operator console. (1) A functional unit containing devices that are used for communications between a computer operator and a computer. (T) (2) A display console used for communication between the operator and the system, used primarily to specify information concerning application programs and I/O operations and to monitor system operation. (3) In SA OS/390, a console that displays output from and sends input to the operating system (z/OS, LINUX, VM, VSE). Also called *operating system console*. In the System Automation for OS/390 operator commands and configuration dialogs, OC is used to designate a target system operator console.

operator station task (OST). The NetView task that establishes and maintains the online session with the network operator. There is one operator station task for each network operator who logs on to the NetView program.

operator view. A set of group, system, and resource definitions that are associated together for monitoring purposes. An operator view appears as a graphic display in the graphic interface showing the status of the defined groups, systems, and resources.

OperatorView entry. A construct, created with the customization dialogs, used to represent and contain policy for an operator view.

OS. Operating system.

OS/390 component. A part of OS/390 that performs a specific OS/390 function. In System Automation for OS/390, component refers to entities that are managed by System Automation for OS/390 automation.

OS/390 subsystem. Software products that augment the OS/390 operating system. JES and TSO/E are examples of OS/390 subsystems. System Automation for OS/390 includes automation for some OS/390 subsystems.

OS/390 system. An OS/390 image together with its associated hardware, which collectively are often referred to simply as a system, or OS/390 system.

OSA. I/O operations can display the open system adapter (OSA) channel logical definition, physical attachment, and status. You can configure an OSA channel on or off.

OST. Operator station task.

outbound. In System Automation for OS/390, messages or commands from the focal-point system to the target system.

outbound gateway operator. The automation operator that establishes connections to other systems. The outbound gateway operator handles communications with other systems through a gateway session. The automation operator sends messages, commands, and responses to the inbound gateway operator at the receiving system.

P

page. (1) The portion of a panel that is shown on a display surface at one time. (2) To transfer instructions, data, or both between real storage and external page or auxiliary storage.

panel. (1) A formatted display of information that appears on a terminal screen. Panels are full-screen 3270-type displays with a monospaced font, limited color and graphics. (2) By using System Automation for OS/390 panels you can see status, type commands on a command line using a keyboard, configure your system, and passthru to other consoles. See also *help panel*. (3) In computer graphics, a display image that defines the locations and characteristics of display fields on a display surface. Contrast with *screen*.

parallel channels. Parallel channels operate in either byte (BY) or block (BL) mode. You can change connectivity to a parallel channel operating in block mode.

parameter. (1) A variable that is given a constant value for a specified application and that may denote the application. (2) An item in a menu for which the user specifies a value or for which the system provides a value when the menu is interpreted. (3) Data passed to

a program or procedure by a user or another program, namely as an operand in a language statement, as an item in a menu, or as a shared data structure.

partition. (1) A fixed-size division of storage. (2) In VSE, a division of the virtual address area that is available for program processing. (3) On an IBM Personal Computer fixed disk, one of four possible storage areas of variable size; one can be accessed by DOS, and each of the others may be assigned to another operating system.

partitionable CPC. A CPC that can be divided into 2 independent CPCs. See also *physical partition*, *single-image mode*, *MP*, *side*.

partitioned data set (PDS). A data set in direct access storage that is divided into partitions, called *members*, each of which can contain a program, part of a program, or data.

passive monitoring. In System Automation for OS/390, the receiving of unsolicited messages from OS/390 systems and their resources. These messages can prompt updates to resource status displays. See also *active monitoring*.

PDS. Partitioned data set.

physical partition. Part of a CPC that operates as a CPC in its own right, with its own copy of the operating system.

physical unit (PU). In SNA, the component that manages and monitors the resources (such as attached links and adjacent link stations) of a node, as requested by a system services control point (SSCP) through an SSCP-PU session. An SSCP activates a session with the physical unit to indirectly manage, through the PU, resources of the node such as attached links.

physically partitioned (PP) configuration. A mode of operation that allows a multiprocessor (MP) system to function as two or more independent CPCs having separate power, water, and maintenance boundaries. Contrast with *single-image (SI) configuration*.

POI. Program operator interface.

policy. The automation and monitoring specifications for an SA OS/390 enterprise. See *System Automation for OS/390 Defining Automation Policy*.

policy database. The database where the automation policy is recorded; also known as the OIB.

POR. Power-on reset.

port. (1) System hardware to which the I/O devices are attached. (2) On an ESCON switch, a port is an addressable connection. The switch routes data through the ports to the channel or control unit. Each port has a name that can be entered into a switch matrix, and you

can use commands to change the switch configuration. (3) An access point (for example, a logical unit) for data entry or exit. (4) A functional unit of a node through which data can enter or leave a data network. (5) In data communication, that part of a data processor that is dedicated to a single data channel for the purpose of receiving data from or transmitting data to one or more external, remote devices. (6) power-on reset (POR) (7) A function that re-initializes all the hardware in a CPC and loads the internal code that enables the CPC to load and run an operating system.

PP. Physically partitioned (configuration).

PPT. Primary POI task.

primary host. The base program at which you enter a command for processing.

primary POI task (PPT). The NetView subtask that processes all unsolicited messages received from the VTAM program operator interface (POI) and delivers them to the controlling operator or to the command processor. The PPT also processes the initial command specified to execute when NetView is initialized and timer request commands scheduled to execute under the PPT.

primary system. A system is a primary system for an application if the application is normally meant to be running there. System Automation for OS/390 starts the application on all the primary systems defined for it.

problem determination. The process of determining the source of a problem; for example, a program component, machine failure, telecommunication facilities, user or contractor-installed programs or equipment, environment failure such as a power loss, or user error.

processor operations. The part of System Automation for OS/390 that monitors and controls processor (hardware) operations. Processor operations provides a connection from a focal—point system to a target system. Through NetView on the focal —point system, processor operations automates operator and system consoles for monitoring and recovering target systems.

processor operations control file. Named by your system programmer, this file contains configuration and customization information. The programmer records the name of this control file in the processor operations file generation panel ISQDPG01.

Processor Resource/Systems Manager (PR/SM). The feature that allows the processor to use several operating system images simultaneously and provides logical partitioning capability. See also *LPAR*.

ProcOps. See *processor operations*.

program to program interface (PPI). A NetView function that allows user programs to send or receive data buffers from other user programs and to send alerts to the NetView hardware monitor from system and application programs.

protocol. In SNA, the meanings of, and the sequencing rules for, requests and responses used for managing the network, transferring data, and synchronizing the states of network components.

PR/SM. Processor Resource/Systems Manager.

PU. Physical unit.

R

remote system. A system that receives resource status information from a System Automation for OS/390 focal—point system. A System Automation for OS/390 remote system is defined as part of the same System Automation for OS/390 enterprise as the System Automation for OS/390 focal—point system to which it is related.

requester. A requester is a workstation software, which enables users to log on to a domain, that is, to the server(s) belonging to this domain, and use the resources in this domain. After the log on to a domain, users can access the shared resources and use the processing capability of the server(s). Because the bigger part of shared resources is on the server(s), users can reduce hardware investment.

resource. (1) Any facility of the computing system or operating system required by a job or task, and including main storage, input/output devices, the processing unit, data sets, and control or processing programs. (2) In NetView, any hardware or software that provides function to the network. (3) In System Automation for OS/390, any OS/390 application, OS/390 component, job, device, or target system capable of being monitored or automated through System Automation for OS/390.

Resource Access Control Facility (RACF). A program that can provide data security for all your resources. RACF protects data from accidental or deliberate unauthorized disclosure, modification, or destruction.

resource group. A physically partitionable portion of a processor. Also known as a *side*.

Resource Monitoring Facility (RMF) Monitor III. A program that measures and reports on the availability and activity of system hardware and software resources, such as processors, devices, storage, and address spaces. RMF can issue online reports about system performance problems as they occur.

Resource Object Data Manager (RODM). A data cache manager designed to support process control and

automation applications. RODM provides an in-memory data cache for maintaining real-time data in an address space that is accessible by multiple applications. RODM also allows an application to query an object and receive a rapid response and act on it.

resource token. A unique internal identifier of an ESCON resource or resource number of the object in the IODF.

restart automation. System Automation for OS/390-provided automation that monitors subsystems to ensure that they are running. If a subsystem fails, System Automation for OS/390 attempts to restart it according to the policy in the automation control file.

Restructured Extended Executor (REXX). An interpretive language used to write command lists.

return code. A code returned from a program used to influence the issuing of subsequent instructions.

REXX. Restructured Extended Executor.

REXX procedure. A command list written with the Restructured Extended Executor (REXX) which is an interpretive language.

RMF. Resource Measurement Facility.

RODM. Resource Object Data Manager.

S

SAF. Security Authorization Facility.

system. In System Automation for OS/390, the term system refers to a focal-point system (OS/390) or a target system.

System Automation for OS/390 automation focal—point system. See *focal—point system*.

System Automation for OS/390 customization dialogs. An ISPF application through which the System Automation for OS/390 policy administrator defines policy for individual OS/390 systems and builds automation control data and RODM load function files.

System Automation for OS/390 customization focal—point system. See *focal—point system*.

System Automation for OS/390 data model. The set of objects, classes and entity relationships necessary to support the function of System Automation for OS/390 and the NetView automation platform.

System Automation for OS/390 enterprise. The group of systems and resources defined in the customization dialogs under one enterprise name. A System

Automation for OS/390 enterprise consists of connected OS/390 systems running System Automation for OS/390.

System Automation for OS/390 focal—point system. See *focal—point system*.

System Automation for OS/390 policy. The description of the systems and resources that make up an System Automation for OS/390 enterprise, together with their monitoring and automation definitions.

System Automation for OS/390 policy administrator. The member of the operations staff who is responsible for defining System Automation for OS/390 policy.

System Automation for OS/390 satellite. If you are running two NetViews on an OS/390 system to split the automation and networking functions of NetView, it is common to route alerts to the Networking NetView. For System Automation for OS/390 to process alerts properly on the Networking NetView, you must install a subset of System Automation for OS/390 code, called an *System Automation for OS/390 satellite* on the Networking NetView.

screen. Deprecated term for display panel.

screen-based processor. See *screen-oriented processor*.

SDF. Status Display Facility.

SDLC. Synchronous data link control.

SDSF. System Display and Search Facility.

secondary system. A system is a secondary system for an application if it is defined to automation on that system, but the application is not normally meant to be running there. Secondary systems are systems to which an application can be moved in the event that one or more of its primary systems are unavailable. System Automation for OS/390 does not start the application on its secondary systems.

server. A server is a workstation, that shares resources, which include directories, printers, serial devices, and computing powers.

service period. Service periods allow the users to schedule the availability of applications. A service period is a set of time intervals (service windows), during which an application should be active.

service threshold. A System Automation for OS/390 policy setting that determines when to notify the operator of deteriorating service for a resource. See also *alert thresholdwarning threshold*.

session. In SNA, a logical connection between two network addressable units (NAUs) that can be activated, tailored to provide various protocols, and deactivated, as requested. Each session is uniquely identified in a transmission header by a pair of

network addresses identifying the origin and destination NAUs of any transmissions exchanged during the session.

session monitor. The component of the NetView program that collects and correlates session-related data and provides online access to this information. The successor to NLDM.

shutdown automation. System Automation for OS/390-provided automation that manages the shutdown process for subsystems by issuing shutdown commands and responding to prompts for additional information.

SMP/E. System Modification Program Extended.

SNA. Systems Network Architecture.

SNA network. In SNA, the part of a user-application network that conforms to the formats and protocols of systems network architecture. It enables reliable transfer of data among end users and provides protocols for controlling the resources of various network configurations. The SNA network consists of network addressable units (NAUs), boundary function components, and the path control network.

SNMP. Simple Network Management Protocol (a TCP/IP protocol). A protocol that allows network management by elements, such as gateways, routers, and hosts. This protocol provides a means of communication between network elements regarding network resources.

solicited message. A System Automation for OS/390 message that directly responds to a command. Contrast with *unsolicited message*.

SSCP. System services control point.

SSI. Subsystem interface.

start automation. System Automation for OS/390-provided automation that manages and completes the startup process for subsystems. During this process, System Automation for OS/390 replies to prompts for additional information, ensures that the startup process completes within specified time limits, notifies the operator of problems, if necessary, and brings subsystems to an UP (or ready) state.

startup. The point in time at which a subsystem or application is started.

status. The measure of the condition or availability of the resource.

status focal—point system. See *focal—point system*.

status display facility (SDF). The system operations part of System Automation for OS/390 that displays status of resources such as applications, gateways, and write-to-operator messages (WTORs) on dynamic

color-coded panels. SDF shows spool usage problems and resource data from multiple systems.

steady state automation. The routine monitoring, both for presence and performance, of subsystems, applications, volumes and systems. Steady state automation may respond to messages, performance exceptions and discrepancies between its model of the system and reality.

structure. A construct used by OS/390 to map and manage storage on a coupling facility. See *cache structure*, *list structure*, and *lock structure*.

subgroup. A named set of systems. A subgroup is part of a System Automation for OS/390 enterprise definition and is used for monitoring purposes.

SubGroup entry. A construct, created with the customization dialogs, used to represent and contain policy for a subgroup.

subsystem. (1) A secondary or subordinate system, usually capable of operating independent of, or asynchronously with, a controlling system. (2) In System Automation for OS/390, an OS/390 application or subsystem defined to System Automation for OS/390.

subsystem interface. The OS/390 interface over which all messages sent to the OS/390 console are broadcast.

support element. A hardware unit that provides communications, monitoring, and diagnostic functions to a central processor complex (CPC).

support processor. Another name given to a processor controller on smaller System/370 processors; see *service processor*.

switches. ESCON directors are electronic units with ports that dynamically switch to route data to I/O devices. The switches are controlled by I/O operations commands that you enter on a workstation.

switch identifier. The switch device number (swchdevn), the logical switch number (LSN) and the switch name

symbolic destination name (SDN). Used locally at the workstation to relate to the VTAM application name.

SYSINFO Report. An RMF report that presents an overview of the system, its workload, and the total number of jobs using resources or delayed for resources.

SysOps. See *system operations*.

sysplex. A set of OS/390 systems communicating and cooperating with each other through certain multisystem hardware components (coupling devices and timers) and software services (couple data sets).

In a sysplex, OS/390 provides the coupling services that handle the messages, data, and status for the parts of a multisystem application that has its workload spread across two or more of the connected processors, sysplex timers, coupling facilities, and couple data sets (which contains policy and states for automation).

A parallel sysplex is a sysplex which includes a coupling facility.

sysplex application group. A sysplex application group is a grouping of applications that can run on any system in a sysplex.

sysplex couple data set. A couple data set that contains sysplex-wide data about systems, groups, and members that use XCF services. All OS/390 systems in a sysplex must have connectivity to the sysplex couple data set. See also *couple data set*.

Sysplex Timer. An IBM unit that synchronizes the time-of-day (TOD) clocks in multiple processors or processor sides. External Time Reference (ETR) is the OS/390 generic name for the IBM Sysplex Timer (9037).

system. In System Automation for OS/390, system means a focal-point system (OS/390) or a target system.

System Automation for OS/390. The full name for SA OS/390.

system console. (1) A console, usually having a keyboard and a display screen, that is used by an operator to control and communicate with a system. (2) A logical device used for the operation and control of hardware functions (for example, IPL, alter/display, and reconfiguration). The system console can be assigned to any of the physical displays attached to a processor controller or support processor. (3) In System Automation for OS/390, the hardware system console for processor controllers or service processors of processors connected using System Automation for OS/390. In the System Automation for OS/390 operator commands and configuration dialogs, SC is used to designate the system console for a target hardware processor.

System Display and Search Facility (SDSF). An IBM licensed program that provides information about jobs, queues, and printers running under JES2 on a series of panels. Under System Automation for OS/390 you can select SDSF from a pull-down menu to see the resources' status, view the OS/390 system log, see WTOR messages, and see active jobs on the system.

System entry. A construct, created with the customization dialogs, used to represent and contain policy for a system.

System Modification Program/Extended (SMP/E). An IBM licensed program that facilitates the process of installing and servicing an OS/390 system.

system operations. The part of System Automation for OS/390 that monitors and controls system operations applications and subsystems such as NetView, SDSF, JES, RMF, TSO, RODM, ACF/VTAM, CICS, IMS, and OPC.

system services control point (SSCP). In SNA, the focal point within an SNA network for managing the configuration, coordinating network operator and problem determination requests, and providing directory support and other session services for end users of the network. Multiple SSCPs, cooperating as peers, can divide the network into domains of control, with each SSCP having a hierarchical control relationship to the physical units and logical units within its domain.

Systems Network Architecture (SNA). The description of the logical structure, formats, protocols, and operational sequences for transmitting information units through, and controlling the configuration and operation of, networks.

SystemView. An IBM structure applied to systems management applications to produce a unified and consistent set of applications to the systems management end user.

System/390 microprocessor cluster. A configuration that consists of central processor complexes (CPCs) and may have one or more integrated coupling facilities.

T

TAF. Terminal access facility.

target. A processor or system monitored and controlled by a focal—point system.

target control task. In System Automation for OS/390, target control tasks process commands and send data to target systems and workstations through communications tasks. A target control task (a NetView autotask) is assigned to a target system when the target system is initialized.

target hardware. In System Automation for OS/390, the physical hardware on which a target system runs. It can be a single-image or physically partitioned processor. Contrast with *target system*.

target system. (1) In a distributed system environment, a system that is monitored and controlled by the focal-point system. Multiple target systems can be controlled by a single focal-point system. (2) In System Automation for OS/390, a computer system attached to the focal-point system for monitoring and control. The definition of a target system includes how remote sessions are established, what hardware is used, and what operating system is used.

task. (1) A basic unit of work to be accomplished by a computer. (2) In the NetView environment, an operator station task (logged-on operator), automation operator (autotask), application task, or user task. A NetView task performs work in the NetView environment. All System Automation for OS/390 tasks are NetView tasks. See also *communications task*, *message monitor task*, and *target control task*.

telecommunication line. Any physical medium, such as a wire or microwave beam, that is used to transmit data.

terminal access facility (TAF). (1) A NetView function that allows you to log onto multiple applications either on your system or other systems. You can define TAF sessions in the System Automation for OS/390 customization panels so you don't have to set them up each time you want to use them. (2) In NetView, a facility that allows a network operator to control a number of subsystems. In a full-screen or operator control session, operators can control any combination of subsystems simultaneously.

terminal emulation. The capability of a microcomputer or personal computer to operate as if it were a particular type of terminal linked to a processing unit to access data.

threshold. A value that determines the point at which System Automation for OS/390 automation performs a predefined action. See *alert threshold*, *warning threshold*, and *error threshold*.

Time Sharing Option (TSO). An optional configuration of the operating system that provides conversational time sharing from remote stations. It is an interactive service on OS/390, MVS/ESA, and MVS/XA.

Time-Sharing Option/Extended (TSO/E). An option of OS/390 that provides conversational time-sharing from remote terminals. TSO/E allows a wide variety of users to perform many different kinds of tasks. It can handle short-running applications that use fewer sources as well as long-running applications that require large amounts of resources.

timers. A NetView command that issues a command or command processor (list of commands) at a specified time or time interval.

TME 10. Tivoli Management Environment.

TOD. Time of day.

token ring. A network with a ring topology that passes tokens from one attaching device to another; for example, the IBM Token-Ring Network product.

TP. Transaction program.

transaction program. In the VTAM program, a program that performs services related to the processing of a transaction. One or more transaction programs may operate within a VTAM application program that is using the VTAM application program interface (API). In that situation, the transaction program would request services from the applications program using protocols defined by that application program. The application program, in turn, could request services from the VTAM program by issuing the APPCCMD macro instruction.

transitional automation. the actions involved in starting and stopping subsystems and applications which have been defined to System Automation for OS/390. This can include issuing commands and responding to messages.

translating host. Role played by a host that turns a resource number into a token during a unification process.

trigger. Triggers, in combination with events and service periods, are used to control the starting and stopping of applications in a single system or a parallel sysplex.

TSO. Time Sharing Option.

TSO console. From this 3270-type console you are logged onto TSO or ISPF to use the runtime panels for I/O operations and System Automation for OS/390 customization panels.

TSO/E. TSO Extensions.

U

UCB. The unit control block; an MVS/ESA data area that represents a device and which is used for allocating devices and controlling I/O operations.

unsolicited message. A System Automation for OS/390 message that is not a direct response to a command. Contrast with *solicited message*.

user task. An application of the NetView program defined in a NetView TASK definition statement.

Using. An RMF Monitor III definition. Jobs getting service from hardware resources (processors or devices) are **using** these resources. The use of a resource by an address space can vary from 0% to 100% where 0% indicates no use during a Range period, and 100% indicates that the address space was found using the resource in every sample during that period. See also *Workflow*.

V

view. In the NetView Graphic Monitor Facility, a graphical picture of a network or part of a network. A

view consists of nodes connected by links and may also include text and background lines. A view can be displayed, edited, and monitored for status information about network resources.

Virtual Machine/System Product (VM/SP). An IBM licensed program. It is an operating system that manages the resources of a real processor to provide virtual machines to end users. As a time-sharing system control program, it consists of the virtual machine control program (CP), the conversational monitor system (CMS), the group control system (GCS), and the interactive problem control system (IPCS).

Virtual Storage Extended (VSE). An IBM licensed program whose full name is Virtual Storage Extended/Advanced Function. It is an operating system that controls the execution of programs.

Virtual Telecommunications Access Method (VTAM). An IBM licensed program that controls communication and the flow of data in an SNA network. It provides single-domain, multiple-domain, and interconnected network capability. Its full name is Advanced Communications Function for the Virtual Telecommunications Access Method. Synonymous with *ACF/VTAM*.

VM/ESA. Virtual Machine/Enterprise Systems Architecture.

VM/SP. Virtual Machine/System Product.

VM/SP HPO. Virtual Machine/System Product High Performance Option.

volume. A direct access storage device (DASD) volume or a tape volume that serves a system in a System Automation for OS/390 enterprise.

volume entry. A construct, created with the customization dialogs, used to represent and contain policy for a volume.

volume group. A named set of volumes. A volume group is part of a system definition and is used for monitoring purposes.

volume group entry. An construct, created with the customization dialogs, used to represent and contain policy for a volume group.

Volume Workflow. The System Automation for OS/390 Volume Workflow variable is derived from the RMF Resource Workflow definition, and is used to measure the performance of volumes. System Automation for OS/390 calculates Volume Workflow using:

$$\text{Volume Workflow \%} = \frac{\text{accumulated Using}}{\text{accumulated Using} + \text{accumulated Delay}} * 100$$

The definition of **Using** is the percentage of time when a job has had a request accepted by a channel for the volume, but the request is not yet complete.

The definition of **Delay** is the delay that waiting jobs experience because of contention for the volume. See also *Address Space Workflow*.

VSE. Virtual Storage Extended.

VTAM. Virtual Telecommunications Access Method.

W

warning threshold. An application or volume service value that determines the level at which System Automation for OS/390 changes the associated icon in the graphic interface to the warning color. See *alert threshold*.

workflow. See *Address Space Workflow* and *Volume Workflow*.

write-to-operator (WTO). A request to send a message to an operator at the OS/390 operator console. This request is made by an application and is handled by the WTO processor, which is part of the OS/390 supervisor program.

write-to-operator-with-reply (WTOR). A request to send a message to an operator at the OS/390 operator console which requires a response from the operator. This request is made by an application and is handled by the WTO processor, which is part of the OS/390 supervisor program.

WTO. Write-to-Operator.

WTOR. Write-to-Operator-with-Reply.

WWV. The US National Institute of Standards and Technology (NIST) radio station that provides standard time information. A second station, known as WWVB, provides standard time information at a different frequency.

X

XCF. Cross-system coupling facility.

XCF couple data set. The name for the sysplex couple data set prior to MVS/ESA System Product Version 5 Release 1. See also *sysplex couple data set*.

XCF group. A set of related members that a multisystem application defines to XCF. A member is a specific function, or instance, of the application. A member resides on one system and can communicate with other members of the same group across the sysplex.

XRF. Extended recovery facility.

Numerics

390-CMOS. Processor family group designator used in the System Automation for OS/390 processor operations documentation and in the online help to identify any of the following S/390 CMOS processor machine types: 9672, 9674, 2003, 3000, or 7060. System Automation for OS/390 processor operations uses the OCF facility of these processors to perform operations management functions. See *OCF-based processor*.

Index

Special characters

&COMPAPPL; variable 223
&DCOMP variable 223
&QCOMP variable 223
&RESAPPL variable 223

Numerics

256-character allow or prohibit
string 207, 209

A

ACF file manager command 7
ACFCMD common routine 13
ACFFQRY file manager command 21
ACFREP common routine 28
active message handler 107
ACTIVMSG generic routine 107
address space management
 INGRCLUP command 98
allow or prohibit attributes 209
 defining 207, 211
AOCFILT generic routine 109
AOCGETCN common routine 35
AOCMSG common routine 36
AOCQRES common routine 41
AOCQRY common routine 42
AOCQRY TGLOBALs 47
AOCUPDT common routine 56
AOFADMON common routine 60
AOFAJMON common routine 61
AOFAPMON common routine 62
AOFATMON common routine 62
AOFCPMSG common routine 63
AOFCPSPM common routine 65
AOFEXCMD common routine 66
AOFPCILD.0 TGLOBAL 69
AOFPCILD.n TGLOBAL 69
AOFSHUTMOD global variable 103, 104
AOFTREE 233
AOFTREE common routine 67
AOFUXMON common routine 71
API
 assembler language CALLS 264
 description 133
 with REXX 259
ASCB chaining 127
ASF file manager command 72
ASFUSER file manager command 77
ASSIST TGLOBAL 51
automation control file
 issuing commands from 13
automation control file WARM start 8
automation manager commands
 INGPOST 89
 INGRTCMD 98
AUTOTYPE TGLOBAL 51

C

cascaded switch
 FICON 135
CDEMATCH common routine 80
CHKSUBS common routine 85
CHKTHRES common routine 86
CMDCNTHI TGLOBAL 16
code matching 80
commands
 ACF 7
 ACFCMD 13
 ACFFQRY 21
 ACFREP 28
 AOCGETCN 35
 AOCMSG 36
 AOCQRES 41
 AOCQRY 42
 AOCUPDT 56
 AOFADMON 60
 AOFAJMON 61
 AOFAPMON 62
 AOFATMON 62
 AOFCPMSG 63
 AOFCPSPM 65
 AOFEXCMD 66
 AOFTREE 67
 AOFUXMON 71
 ASF 72
 ASFUSER 77
 CDEMATCH 80
 CHKSUBS 85
 CHKTHRES 86
 DELETE FILE 141
 INGPOST 89
 INGPW 94
 INGRCLUP 98
 INGRTCMD 98
 INGSTOBS 99
 INGUSS 101
 ISQMTSYS 103
 MDFYSHUT 103
 QUERY ENTITY CHP 141
 QUERY ENTITY CNTLUNIT 146
 QUERY ENTITY DEV 149
 QUERY ENTITY HOST 152
 QUERY ENTITY SWITCH 157
 QUERY FILE 160
 QUERY INTERFACE
 CNTLUNIT 162
 QUERY INTERFACE SWITCH 168
 QUERY RELATION CHP 176
 QUERY RELATION CNTLUNIT 178
 QUERY RELATION DEV 180
 QUERY RELATION HOST 188
 QUERY RELATION SWITCH 190
 QUERY SWITCH 193
 REMOVE CHP 196
 REMOVE DEV 199
 RESTORE CHP 196
 RESTORE DEV 199
 WRITEFILE 205

commands (*continued*)

 WRITEPORT 207
 WRITESWCH 211
common routines
 ACF 7
 ACFCMD 13
 ACFFQRY 21
 ACFREP 28
 AOCGETCN 35
 AOCMSG 36
 AOCQRES 41
 AOCQRY 42
 AOCUPDT 56
 AOFADMON 60
 AOFAJMON 61
 AOFAPMON 62
 AOFATMON 62
 AOFCPMSG 63
 AOFCPSPM 65
 AOFEXCMD 66
 AOFTREE 67
 AOFUXMON 71
 ASF 72
 ASFUSER 77
 CDEMATCH 80
 CHKSUBS 85
 CHKTHRES 86
 INGPOST 89
 INGPW 94
 INGSTOBS 99
 ISQMTSYS 103
 MDFYSHUT 103
communication mask 207, 209
connectivity
 defining 207
connectivity, defining 209
CPCB (command processor control
 block) 271

D

DCOLOR parameter 221
default status descriptor color 221
define
 color for SDF 224
 I/O errors for SDF 231
 maximum number of SDF
 operators 226
 SDF color/priority range 230
 SDF color/priority relationship 228
 SDF initial panel 226
 SDF PF keys 222, 223, 224, 227
 SDF screen buffer size 231
 status colors 225
DELETE FILE command 141
descriptor codes 37
documents, licensed xiv
DPFKDESC1 parameter 223
DPFKDESC2 parameter 224
DPFKnn parameter 222

DSIPARM
description 272

E

EHKACTION TGLOBAL 81
EHKCMD TGLOBAL 16
EHKXITNME TGLOBAL 51
EHKXITRSN TGLOBAL 51
EHKRPY TGLOBAL 28, 31
EHKRPYHI TGLOBAL 31
EHKVARn TGLOBALs 16, 31
EMPTYCOLOR parameter 224
ENDPANEL statement 245
ERRCOLOR 225

F

FICON casceaded switches 135
FICON switches 134
file manager commands
ACF 7
ACFFQRY 21
ASF 72
ASFUSER 77
INGPW 94
filtering messages 109
FWDMSG generic routine 111

G

generic routines
ACTIVMSG 107
AOCFILT 109
description 107
FWDMSG 111
HALTMSG 112
ISSUECMD 114
ISSUERE 118
OUTREP 123
TERMMMSG 126
graphic workstation description 273

H

HALTMSG generic routine 112
HWMCA
description 274

I

I/O operations
programming commands 133
I/O operations commands
DELETE FILE 141
QUERY ENTITY CHP 141
QUERY ENTITY CNTLUNIT 146
QUERY ENTITY DEV 149
QUERY ENTITY HOST 152
QUERY ENTITY SWITCH 157
QUERY FILE 160
QUERY INTERFACE
CNTLUNIT 162
QUERY INTERFACE SWITCH 168
QUERY RELATION CHP 176

I/O operations commands (*continued*)
QUERY RELATION CNTLUNIT 178
QUERY RELATION DEV 180
QUERY RELATION HOST 188
QUERY RELATION SWITCH 190
QUERY SWITCH 193
REMOVE CHP 196
REMOVE DEV 199
RESTORE CHP 196
RESTORE DEV 199
WRITEFILE 205
WRITEPORT 207
WRITESWCH 211
INGEIO 274
INGPOST common routine 89
INGPW command 94
INGRCLUP command 98
INGRTCMD command 98
INGSTOBS common routine 99
INGUSS command 101
initialization parameters
DCOLOR 221
DPFKDESC1 223
DPFKDESC2 224
DPFKnn 222
EMPTYCOLOR 224
ERRCOLOR 225
INITSCRN 226
MAXOPS 226
PFKnn 227
PRIORITY 228
PRITBLSZ 230
PROPDOWN 230
PROPUP 231
SCREENSZ 231
TEMPERR 231
INITSCRN parameter 226
ISQMTSYS common routine 103
ISSUECMD generic routine 114
ISSUERE generic routine 118

L

languages supported by the API
Assembler language 264
REXX 259
MVS REXX example 260
licensed documents xiv
load
QUERY FILE command 160
load SDF tree structure 253
LookAt message retrieval tool xiv

M

mask 207, 209
MAXOPS parameter 226
MDFYSHUT common routine 103
message forwarding and notification 111
message generation and notification 36
message retrieval tool, LookAt xiv
minor resources 43, 47
modifying the current shutdown 103
monitoring routine
INGSTOBS 99
ISQMTSYS 103

MVS descriptor codes 37
MVS REXX example 260

N

NetView
DSIPARM member 233
NGMF focal—point system 272

O

operating environment requirements 133
OUTREP generic routine 123

P

PANEL statement 236
panels
AOCQRY 55
Code Processing 82, 84, 124, 125
Disable Automation 12
DISPACF 53, 117, 130
DISPFLGS 52, 55
DISPINFO 65
Flag Automation 12
Flag Automation Specification 122
Message Processing 17, 19, 20, 32, 34,
82, 84, 121
Policy Selection 121
Reply Processing 122
Thresholds Definition 88
parameter list
for I/O operations API 261
password protection feature 94
PF key
defining for SDF 227
PFKnn parameter 227
PIB, see port information block 193
port information block (PIB) 193
PRIORITY parameter 228
PRITBLSZ parameter 230
PROPDOWN parameter 230
PROPUP parameter 231

Q

QUERY ENTITY CHP command 141
QUERY ENTITY CNTLUNIT
command 146
QUERY ENTITY DEV command 149
QUERY ENTITY HOST command 152
QUERY ENTITY SWITCH
command 157
QUERY FILE command 160
QUERY INTERFACE CNTLUNIT
command 162
QUERY INTERFACE SWITCH
command 168
QUERY RELATION CHP command 176
QUERY RELATION CNTLUNIT
command 178
QUERY RELATION DEV command 180
QUERY RELATION HOST
command 188

QUERY RELATION SWITCH
command 190
QUERY SWITCH command 193

R

REMOVE CHP command 196
REMOVE DEV command
RESTORE DEV command 199
resources
minor 47
RESTORE CHP command 196
REXX coding instructions 259
REXX EXEC
MVS example 260

S

SAF environment policy definition 96
sample SDF, definition 245
save switch configuration
WRITEFILE command 205
saved switch configuration
load file at IPL 160
scheduling a command 66
SCREEN command 255
SCREENSZ parameter 231
SDF
automation control file entry 221
initialization parameters 221
sample definition 245
tree structure hierarchy 233
SDF definition statements
AOFTRREE 233
ENDPANEL 245
PANEL 236
PFKnn 244
SCREEN 255
SDFPANEL 254
SDFTREE 253
STATUSFIELD 237
STATUSTEXT 240
TEXTFIELD 241
TEXTTEXT 243
status descriptor color 221
status tree 230, 231
STATUSFIELD statement 237
STATUSTEXT statement 240
store
WRITEFILE command 205
structure definitions
AOFTRREE 233
ENDPANEL 245
PANEL 236
PFKnn 244
SCREEN 255
SDFPANEL 254
SDFTREE 253
STATUSFIELD 237
STATUSTEXT 240
TEXTFIELD 241
TEXTTEXT 243
SUBPAAAUTO TGLOBAL 49
SUBPAAISTRT TGLOBAL 49
SUBPAAARCVRY TGLOBAL 49
SUBPAAARSTRT TGLOBAL 49

SUBPAASTART TGLOBAL 49
SUBPAAATRMN8 TGLOBAL 49
SUBPAAFAUTO TGLOBAL 49
SUBPAAFISTRT TGLOBAL 49
SUBPAFRVCVRY TGLOBAL 49
SUBPAFRSTRT TGLOBAL 49
SUBPAFSTART TGLOBAL 49
SUBPAFTRMN8 TGLOBAL 49
SUBPAPPL TGLOBAL 49
SUBPASID TGLOBAL 49
SUBPCMDPFX TGLOBAL 49
SUBPDESC TGLOBAL 49
SUBPEXTSTART TGLOBAL 49
SUBPEXTSTOP TGLOBAL 49
SUBPFILE TGLOBAL 49
SUBPIPLOPT TGLOBAL 49
SUBPJOB TGLOBAL 49
SUBPJOBTYPE TGLOBAL 49
SUBPMDATE TGLOBAL 50
SUBPMTIME TGLOBAL 50
SUBPOPER TGLOBAL 50
SUBPPARENT TGLOBAL 50
SUBPPATH TGLOBAL 50
SUBPPORT TGLOBAL 50
SUBPPROC TGLOBAL 50
SUBPPROCESS 50
SUBPPRCYCOPT TGLOBAL 50
SUBPRSTOPT TGLOBAL 50
SUBPSCHEDSS TGLOBAL 50
SUBPSDATE TGLOBAL 50
SUBPSESS TGLOBAL 50
SUBPSHUTDLY TGLOBAL 50
SUBPSHUTOPT TGLOBAL 50
SUBPSPARM TGLOBAL 50
SUBPSTAT TGLOBAL 50
SUBPSTIME TGLOBAL 50
SUBPSTRTDLY TGLOBAL 50
SUBPSUBTYPE TGLOBAL 50
SUBPTERMDLY TGLOBAL 50
SUBPTRANTY TGLOBAL 50
SUBPTYPE TGLOBAL 50
SUBPUSER TGLOBAL 50
SUBPUSSJOB TGLOBAL 50
SUBPxxxx TGLOBALs 47
SUBSAAAUTO TGLOBAL 48
SUBSAAISTRT TGLOBAL 48
SUBSAAARCVRY TGLOBAL 48
SUBSAAARSTRT TGLOBAL 48
SUBSAAASTART TGLOBAL 48
SUBSAAATRMN8 TGLOBAL 48
SUBSAFAUTO TGLOBAL 48
SUBSAFISTRT TGLOBAL 48
SUBSAFRVCVRY TGLOBAL 48
SUBSAFRSTRT TGLOBAL 48
SUBSAFSTART TGLOBAL 48
SUBSAFTRMN8 TGLOBAL 48
SUBSAPPL TGLOBAL 48
SUBSASID TGLOBAL 48
SUBSCMDPFX TGLOBAL 48
SUBSDESC TGLOBAL 48
SUBSEXTSTART TGLOBAL 48
SUBSEXTSTOP TGLOBAL 48
SUBSFILE TGLOBAL 48
SUBSIPLOPT TGLOBAL 48
SUBSJOB TGLOBAL 48
SUBSJOBTYPE TGLOBAL 48
SUBSMDATE TGLOBAL 48

SUBSMTIME TGLOBAL 48
SUBSOPER TGLOBAL 48
SUBSPARENT TGLOBAL 48
SUBSPATH TGLOBAL 48
SUBSPORT TGLOBAL 48
SUBSPROC TGLOBAL 48
SUBSPROCESS TGLOBAL 48
SUBSRCYOPT TGLOBAL 48
SUBSRSTOPT TGLOBAL 48
SUBSSCHEDSS TGLOBAL 49
SUBSSDATE TGLOBAL 49
SUBSSESS TGLOBAL 49
SUBSSHUTDLY TGLOBAL 49
SUBSSHUTOPT TGLOBAL 49
SUBSSPARM TGLOBAL 49
SUBSSTAT TGLOBAL 49
SUBSSTIME TGLOBAL 49
SUBSSTRTDLY TGLOBAL 49
SUBSSUBTYPE TGLOBAL 49
SUBSTERMDLY TGLOBAL 49
SUBSTRANTY TGLOBAL 49
SUBSTYPE TGLOBAL 49
SUBSUSER TGLOBAL 49
SUBSUSJOB TGLOBAL 49
SUBSWLMNAME TGLOBAL 49, 50
SUBSxxxx TGLOBALs 47
switch
FICON 134
FICON cascaded 135
syntax diagrams
how to read 3
system hierarchy tree 67
system operations
common routines for programming 7
generic routines for
programming 107
system operations commands
INGPOST 89
INGRCLUP 98
INGRTCMD 98
INGUSS 101

T

TEMPERR parameter 231
TERMMMSG generic routine 126
TEXTFIELD statement 241
TEXTTEXT statement 243

U

UCB (unit control block) 284
user-written programs
calling the API 133

W

WRITEFILE command 205
WRITEPORT command 207
256-character allow or prohibit
string 209
example 210
WRITESWCH command 211

Readers' Comments — We'd Like to Hear from You

System Automation for OS/390
Programmer's Reference
Version 2 Release 2

Publication No. SC33-7043-07

Overall, how satisfied are you with the information in this book?

	Very Satisfied	Satisfied	Neutral	Dissatisfied	Very Dissatisfied
Overall satisfaction	<input type="checkbox"/>	<input type="checkbox"/>	<input type="checkbox"/>	<input type="checkbox"/>	<input type="checkbox"/>

How satisfied are you that the information in this book is:

	Very Satisfied	Satisfied	Neutral	Dissatisfied	Very Dissatisfied
Accurate	<input type="checkbox"/>	<input type="checkbox"/>	<input type="checkbox"/>	<input type="checkbox"/>	<input type="checkbox"/>
Complete	<input type="checkbox"/>	<input type="checkbox"/>	<input type="checkbox"/>	<input type="checkbox"/>	<input type="checkbox"/>
Easy to find	<input type="checkbox"/>	<input type="checkbox"/>	<input type="checkbox"/>	<input type="checkbox"/>	<input type="checkbox"/>
Easy to understand	<input type="checkbox"/>	<input type="checkbox"/>	<input type="checkbox"/>	<input type="checkbox"/>	<input type="checkbox"/>
Well organized	<input type="checkbox"/>	<input type="checkbox"/>	<input type="checkbox"/>	<input type="checkbox"/>	<input type="checkbox"/>
Applicable to your tasks	<input type="checkbox"/>	<input type="checkbox"/>	<input type="checkbox"/>	<input type="checkbox"/>	<input type="checkbox"/>

Please tell us how we can improve this book:

Thank you for your responses. May we contact you? Yes No

When you send comments to IBM, you grant IBM a nonexclusive right to use or distribute your comments in any way it believes appropriate without incurring any obligation to you.

Name

Address

Company or Organization

Phone No.



Fold and Tape

Please do not staple

Fold and Tape



NO POSTAGE
NECESSARY
IF MAILED IN THE
UNITED STATES

BUSINESS REPLY MAIL

FIRST-CLASS MAIL PERMIT NO. 40 ARMONK, NEW YORK

POSTAGE WILL BE PAID BY ADDRESSEE

IBM Deutschland Entwicklung GmbH
Department 3248
Schoenaicher Strasse 220
D-71032 Boeblingen
Federal Republic of Germany



Fold and Tape

Please do not staple

Fold and Tape



Program Number: 5645-006

Printed in U.S.A.

SC33-7043-07



Spine information:



System Automation for OS/390 Programmer's Reference

Version 2 Release 2

SC33-7043-07