

System Automation for z/OS



Programmer's Reference

Version 2 Release 3

System Automation for z/OS



Programmer's Reference

Version 2 Release 3

Note!

Before using this information and the product it supports, be sure to read the general information under "Notices" on page ix.

Fourteenth Edition (November 2004)

This edition applies to System Automation for z/OS Version 2 Release 3 (5645-006), an IBM licensed program, and to all subsequent releases and modifications until otherwise indicated in new editions or technical newsletters.

Order publications through your IBM representative or the IBM branch office serving your locality. Publications are not stocked at the address given below.

A form for readers' comments appears at the back of this publication. If the form has been removed, address your comments to:

IBM Deutschland Entwicklung GmbH
Department 3248
Schoenaicher Strasse 220
D-71032 Boeblingen
Federal Republic of Germany

FAX: (Germany): 07031+16-3456

FAX: (Other countries): (+49)+7031-16-3456

Internet e-mail: s390id@de.ibm.com

When you send information to IBM, you grant IBM a nonexclusive right to use or distribute the information in any way it believes appropriate without incurring any obligation to you.

© Copyright International Business Machines Corporation 1996, 2004. All rights reserved.

US Government Users Restricted Rights – Use, duplication or disclosure restricted by GSA ADP Schedule Contract with IBM Corp.

Contents

Figures v

Tables vii

Notices ix

Programming Interface Information ix

Trademarks ix

About This Book. xi

Who Should Use This Book xi

Where to Find More Information xi

Part 1. Introduction 1

Chapter 1. Introduction 3

Overview of Commands 3

Format of Syntax Diagrams 3

Part 2. SA z/OS System Operations

Routines 5

Chapter 2. Common Routines 7

Using System Operations Common Routines for
Programming 7

ACF 7

ACFCMD 12

ACFFQRY 21

ACFREP 26

AOCGETCN 34

AOCMSG 35

AOCQRES. 40

AOCQRY 41

AOCUPDT 55

AOFEXCMD 59

AOFTREE 60

ASF 64

ASFUSER 68

CDEMATCH 71

CHKSUBS 77

CHKTHRES 77

INGPOST 80

INGPW 84

INGRCLUP 88

INGRTCMD 89

INGUSS 89

MDFYSHUT 92

Chapter 3. Monitoring Routines 95

Using System Operations Monitoring Routines for
Programming. 95

AOFADMON. 95

AOFAPMON 96

AOFATMON 96

AOFCPSM. 97

AOFUXMON. 97

INGPJMON 98

ISQMTSYS 100

Chapter 4. Generic Routines 101

Using SA z/OS Generic Routines for Programming 101

ACTIVMSG 101

AOFCPSMSG. 104

AOCFILT. 107

FWDMSG 109

HALTMSG 110

ISSUECMD 113

ISSUEREP 117

OUTREP 123

TERMMMSG 126

Chapter 5. Utilities 133

Additional Parameters for System Operations

Commands 133

INGDATA 137

INGMON 138

INGSTOBS 139

INGTIMER 141

INGVARS 143

INGVTAM 145

Part 3. SA z/OS I/O Operations

Commands. 149

Chapter 6. I/O Operations Commands

(API) 151

Using I/O Operations Commands for
Programming 151

Safe Switching 152

FICON Switches 153

FICON Cascaded Switches 153

Common Elements 154

DELETE FILE 167

QUERY ENTITY CHP 168

QUERY ENTITY CNTLUNIT 173

QUERY ENTITY DEV 176

QUERY ENTITY HOST 179

QUERY ENTITY SWITCH 183

QUERY FILE 186

QUERY INTERFACE CNTLUNIT. 187

QUERY INTERFACE SWITCH 193

QUERY RELATION CHP 201

QUERY RELATION CNTLUNIT 202

QUERY RELATION DEV 202

QUERY RELATION HOST 203

QUERY RELATION SWITCH 204

QUERY SWITCH 205

REMOVE and RESTORE CHP. 208

REMOVE DEV and RESTORE DEV	211
WRITEFILE	217
WRITEPORT	219
WRITESWCH	224

Chapter 7. Invoking I/O Operations with a REXX EXEC	231
Rules for Calls by a REXX EXEC	231

**Part 4. Status Display Facility
Definitions 239**

Chapter 8. SDF Initialization Parameters	241
DCOLOR.	241
DPFKnn	242
DPFKDESC1	243
DPFKDESC2	244
EMPTYCOLOR.	244
ERRCOLOR.	245
INITSCRN	246
MAXOPS.	246
PFKnn.	247
PRIORITY	248
PRITBSZ	250

PROPDOWN	250
PROPUP	251
SCREENSZ	251
TEMPERR	251

Chapter 9. SDF Definition Statements	253
AOFTREE	253
PANEL	255
STATUSFIELD	257
STATUSTEXT	260
TEXTFIELD	261
TEXTTEXT	262
PFKnn.	263
ENDPANEL.	264
Example SDF Definition.	265

Chapter 10. SDF Commands	273
SDFTREE.	273
SDFPANEL	274
SCREEN	275

Glossary	279
---------------------------	------------

Index	299
------------------------	------------

Figures

1. DISPACF Command Response Panel	16	18. Resource Selection Panel 2 -- Sysplex-wide	136
2. DISPFLGS Sample Panel	51	19. INGVARs Command Line-mode Output	145
3. DISPACF Sample Panel	52	20. INGVTAM REQ=LIST Output	147
4. Subsystem Dependent Tree	61	21. QUERY SWITCH Command - Sample Output	208
5. Message Processing Sample Panel	73	22. Example Tree Structure Definitions: System SY1	255
6. Code Processing Sample Panel	73	23. Example Tree Structure Definitions: System SY2	255
7. Message Processing Sample Panel	75	24. SDF Example: Tree Structure Definition for SY1	265
8. Code Processing Sample Panel	76	25. SDF Example: Hierarchy Defined by SY1 Tree Structure	265
9. INGPW Example.	87	26. SDF Example: System Panel Definition Statements	267
10. INGPW Shared SAF Database Example	88	27. SDF Example: Status Component Panel Definition Statements for SY1SYS	268
11. DISPINFO Sample Panel Showing Captured Messages	107	28. Sample SY1 SDF Panel	269
12. DISPACF Sample Panel	116	29. Default Values for SDF Displays	271
13. SA z/OS Policy Selection Panel	121		
14. Code Processing Panel for an Application Resource	124		
15. Code Processing Panel for the MVSESA Resource	125		
16. DISPACF Command Dialog Panel	130		
17. Resource Selection Panel 1 -- Non-sysplex-wide	135		

Tables

1. System Automation for z/OS Library	xi	15. QUERY ENTITY CNTLUNIT Output	174
2. Related Products Books	xii	16. QUERY ENTITY DEV Output	177
3. Overview of Commands	3	17. QUERY ENTITY HOST Output	180
4. Output from ACFFQRY	22	18. QUERY ENTITY SWITCH Output	183
5. AOCQRY Subsystem TGLOBALs	47	19. QUERY FILE Output of a Particular Configuration	187
6. AOCQRY Parent TGLOBALs.	48	20. QUERY INTERFACE CNTLUNIT Output	188
7. AOCQRY Automation Flag TGLOBALs	50	21. QUERY INTERFACE SWITCH Output	194
8. Code Match Actions for OUTREP.	124	22. QUERY SWITCH Output	205
9. TERMMSG Status Transitions	126	23. REMOVE DEV and RESTORE DEV Output	215
10. Exits and associated resources	141	24. WRITEFILE Input Format	219
11. Standard SA z/OS Array Format	156	25. WRITESWCH Input	225
12. Header for all Query Entity/Interface Output Formats	161	26. Variables for the DPFKnn Command	243
13. Output Format of all Query Relation Commands	162	27. Variables for the PFKnn Command	247
14. QUERY ENTITY CHP Output	168	28. Variables for PF Keys	264

Notices

References in this publication to IBM products, programs, or services do not imply that IBM intends to make these available in all countries in which IBM operates. Any reference to an IBM product, program, or service is not intended to state or imply that only IBM product, program, or service may be used. Subject to IBM's valid intellectual property or other legally protectable rights, any functionally equivalent product, program, or service may be used instead of the IBM product, program, or service. The evaluation and verification of operation in conjunction with other products, except those expressly designated by IBM, are the responsibility of the user.

IBM may have patents or pending patent applications covering subject matter in this document. The furnishing of this document does not give you any license to these patents. You can send license inquiries, in writing, to:

IBM Director of Licensing
IBM Corporation
North Castle Drive
Armonk, NY 10504-1785
USA

Licensees of this program who wish to have information about it for the purpose of enabling: (i) the exchange of information between independently created programs and other programs (including this one) and (ii) the mutual use of the information which has been exchanged, should contact:

IBM Deutschland Entwicklung GmbH
Department 3248
Schoenaicher Strasse 220
D-71032 Boeblingen
Federal Republic of Germany

Such information may be available, subject to appropriate terms and conditions, including in some cases, payment of a fee.

Any pointers in this publication to non-IBM web sites are provided for convenience only, and do not in any manner serve as an endorsement of these web sites. IBM accepts no responsibility for the content or use of non-IBM web sites specifically mentioned in this publication or accessed through an IBM web site that is mentioned in this publication.

Programming Interface Information

This book documents programming interfaces that allow the customer to write programs to obtain the services of System Automation for z/OS.

Trademarks

The following terms, used in this book, are trademarks of the IBM Corporation in the United States or other countries:

CICS	DB2	ESCON
FICON	IBM	IMS
MVS	MVS/ESA	NetView

OS/390
VTAM

RACF
z/OS

RMF

The following terms are trademarks of other companies:

- UNIX is a registered trademark of The Open Group in the United States and other countries.

About This Book

This book describes the programming interfaces of System Automation for z/OS[®] (SA z/OS). It provides detailed reference material you need to operate, maintain and program for SA z/OS.

The sample material in this book is based on SA z/OS running on NetView[®] V1R4.

Throughout this publication references to MVS[™] refer either to MVS/ESA[™], or to the MVS element of z/OS.

Who Should Use This Book

This information is primarily for system programmers and automation programmers, but may also be useful for others, for example, help desk personnel and customer engineers.

Where to Find More Information

The System Automation for z/OS Library

The following table shows the information units in the System Automation for z/OS library:

Table 1. System Automation for z/OS Library

Title	Order Number
<i>System Automation for z/OS Planning and Installation</i>	SC33-7038
<i>System Automation for z/OS Customizing and Programming</i>	SC33-7035
<i>System Automation for z/OS Defining Automation Policy</i>	SC33-7039
<i>System Automation for z/OS User's Guide</i>	SC33-7040
<i>System Automation for z/OS Messages and Codes</i>	SC33-7041
<i>System Automation for z/OS Operator's Commands</i>	SC33-7042
<i>System Automation for z/OS Programmer's Reference</i>	SC33-7043
<i>System Automation for z/OS CICS Automation Programmer's Reference and Operator's Guide</i>	SC33-7044
<i>System Automation for z/OS IMS Automation Programmer's Reference and Operator's Guide</i>	SC33-7045
<i>System Automation for z/OS OPC Automation Programmer's Reference and Operator's Guide</i>	SC23-7046
<i>System Automation for z/OS Licensed Program Specifications</i>	SC33-7037

The System Automation for z/OS books are also available on CD-ROM as part of the following collection kit:

IBM[®] Online Library z/OS Software Products Collection (SK3T-4270)

SA z/OS Home Page

For the latest news on SA z/OS, visit the SA z/OS home page at <http://www.ibm.com/servers/eserver/zseries/software/sa>

Related Product Information

The following table shows the books in the related product libraries that you may find useful for support of the SA z/OS base program.

Table 2. Related Products Books

Title	Order Number
<i>ISPF User's Guide</i>	SC34-4484
<i>ISPF Dialog Management Guide and Reference</i>	SC34-4266
<i>MVS/ESA MVS Configuration Program Guide and Reference</i>	GC28-1817
<i>MVS/ESA Planning: Dynamic I/O Configuration</i>	GC28-1674
<i>MVS/ESA Support for the Enterprise Systems Connection</i>	GC28-1140
<i>MVS/ESA Planning: APPC Management</i>	GC28-1110
<i>MVS/ESA Application Development Macro Reference</i>	GC28-1822
<i>OS/390[®]: MVS System Commands</i>	GC28-1781
<i>MVS/ESA SPL Application Development Macro Reference</i>	GC28-1857
<i>OS/390 Hardware Configuration Definition: User's Guide</i>	SC28-1848
<i>OS/390 Information Roadmap</i>	GC28-1727
<i>OS/390 Information Transformation</i>	GC28-1985
<i>OS/390 Introduction and Release Guide</i>	GC28-1725
<i>OS/390 JES Commands Summary</i>	GX22-0041
<i>OS/390 Licensed Program Specifications</i>	GC28-1728
<i>OS/390 Printing Softcopy Books</i>	S544-5354
<i>OS/390 Starting Up a Sysplex</i>	GC28-1779
<i>OS/390 Up and Running!</i>	GC28-1726
<i>Planning for the 9032 Model 3 and 9033 Enterprise Systems Connection Director</i>	SA26-6100
<i>Resource Access Control Facility (RACF[®]) Command Language Reference</i>	SC28-0733
<i>S/390[®] MVS Sysplex Overview -- An Introduction to Data Sharing and Parallelism</i>	GC23-1208
<i>S/390 MVS Sysplex Systems Management</i>	GC23-1209
<i>S/390 Sysplex Hardware and Software Migration</i>	GC23-1210
<i>S/390 MVS Sysplex Application Migration</i>	GC23-1211
<i>S/390 Managing Your Processors</i>	GC38-0452
<i>Tivoli/Enterprise Console User's Guide Volume I</i>	GC31-8334
<i>Tivoli/Enterprise Console User's Guide Volume II</i>	GC31-8335
<i>Tivoli/Enterprise Console Event Integration Facility Guide</i>	GC31-8337
<i>Tivoli[®] NetView for OS/390 Administration Reference</i>	SC31-8222
<i>Tivoli NetView for OS/390 Application Programming Guide</i>	SC31-8223

Table 2. Related Products Books (continued)

Title	Order Number
<i>Tivoli NetView for OS/390 APPN Topology and Accounting Agent</i>	SC31-8224
<i>Tivoli NetView for OS/390 Automation Guide</i>	SC31-8225
<i>Tivoli NetView for OS/390 AON Customization Guide</i>	SC31-8662
<i>Tivoli NetView for OS/390 AON User's Guide</i>	GC31-8661
<i>Tivoli NetView for OS/390 Bridge Implementation</i>	SC31-8238
<i>Tivoli NetView for OS/390 Command Reference Vol. 1</i>	SC31-8227
<i>Tivoli NetView for OS/390 Command Reference Vol. 2</i>	SC31-8735
<i>Tivoli NetView for OS/390 Customization Guide</i>	SC31-8228
<i>Tivoli NetView for OS/390 Customization: Using Assembler</i>	SC31-8229
<i>Tivoli NetView for OS/390 Customization: Using Pipes</i>	SC31-8248
<i>Tivoli NetView for OS/390 Customization: Using PL/I and C</i>	SC31-8230
<i>Tivoli NetView for OS/390 Customization: Using REXX and CLIST Language</i>	SC31-8231
<i>Tivoli NetView for OS/390 Data Mode Reference</i>	SC31-8232
<i>Tivoli NetView for OS/390 Installation: Getting Started</i>	SC31-8767
<i>Tivoli NetView for OS/390 Installation: Migration Guide</i>	SC31-8768
<i>Tivoli NetView for OS/390 Installation: Configuring Graphical Components</i>	SC31-8770
<i>Tivoli NetView for OS/390 Installation: Configuring Additional Components</i>	SC31-8769
<i>Tivoli NetView for OS/390 Messages and Codes</i>	SC31-8237
<i>Tivoli NetView for OS/390 MultiSystem Manager User's Guide</i>	SC31-8607
<i>Tivoli NetView for OS/390 NetView Management Console User's Guide</i>	GC31-8665
<i>Tivoli NetView for OS/390 User's Guide</i>	SC31-8241
<i>Tivoli NetView for OS/390 RODM and GMFHS Programming Guide</i>	SC31-8233
<i>Tivoli NetView for OS/390 Security Reference</i>	SC31-8606
<i>Tivoli NetView for OS/390 SNA Topology Manager and APPN Accounting Manager Implementation Guide</i>	SC31-8239
<i>Tivoli Management Platform Reference Guide</i>	GC31-8324
<i>TSO/E REXX/MVS User's Guide</i>	SC28-1882
<i>TSO/E REXX/MVS Reference</i>	SC28-1883
<i>VM/XA SP™ GCS Command and Macro Reference</i>	SC23-0433
<i>VSE/SP Unattended Node Support</i>	SC33-6412
<i>VTAM® Messages and Codes</i>	SC31-6493
<i>VTAM Network Implementation Guide</i>	SC31-6404
<i>VTAM Network Implementation Guide</i>	SC31-6434

Using LookAt to look up message explanations

LookAt is an online facility that lets you look up explanations for most messages you encounter, as well as for some system abends and codes. Using LookAt to find information is faster than a conventional search because in most cases LookAt goes directly to the message explanation.

You can access LookAt from the Internet at:

<http://www.ibm.com/eserver/zseries/zos/bkserv/lookat/> or from anywhere in z/OS or z/OS.e where you can access a TSO/E command line (for example, TSO/E prompt, ISPF, z/OS UNIX System Services running OMVS).

The LookAt Web site also features a mobile edition of LookAt for devices such as Pocket PCs, Palm OS, or Linux-based handhelds. So, if you have a handheld device with wireless access and an Internet browser, you can now access LookAt message information from almost anywhere.

To use LookAt as a TSO/E command, you must have LookAt installed on your host system. You can obtain the LookAt code for TSO/E from a disk on your z/OS *Collection* (SK3T-4269) or from the LookAt Web site's **Download** link.

Accessing z/OS licensed documents on the Internet

z/OS licensed documentation is available on the Internet in PDF format at the IBM Resource Link™ Web site at:

<http://www.ibm.com/servers/resourceLink>

Licensed documents are available only to customers with a z/OS license. Access to these documents requires an IBM Resource Link user ID and password, and a key code. With your z/OS order you received a Memo to Licensees, (GI10-0671), that includes this key code.¹

To obtain your IBM Resource Link user ID and password, log on to:

<http://www.ibm.com/servers/resourceLink>

To register for access to the z/OS licensed documents:

1. Sign in to Resource Link using your Resource Link user ID and password.
2. Select **User Profiles** located on the left-hand navigation bar.

Note: You cannot access the z/OS licensed documents unless you have registered for access to them and received an e-mail confirmation informing you that your request has been processed.

Printed licensed documents are not available from IBM.

You can use the PDF format on either **z/OS Licensed Product Library CD-ROM** or IBM Resource Link to print licensed documents.

1. z/OS.e™ customers received a Memo to Licensees, (GI10-0684) that includes this key code.

Part 1. Introduction

Chapter 1. Introduction	3	Format of Syntax Diagrams	3
Overview of Commands	3		

This part describes System Automation for z/OS commands in general -- how to enter them, the format, and the various types of commands.

Chapter 1. Introduction

Overview of Commands

Table 3 gives a brief overview of the System Automation for z/OS commands. This overview lists the various types of commands, their functions and where they can be entered.

Table 3. Overview of Commands

Type of command	Function	Where entered	Notes
System operations commands			
	Control and maintain resources in the enterprise from a single point of control	NetView console, or NMC	
I/O operations commands			
	Control input/output devices	TSO/ISPF, API, operator console	
Processor operations commands			
	Common commands for automation	API, NetView console, or NMC	Precede with ISQCCMD command
	Control hardware processors	NetView console or NMC	

Format of Syntax Diagrams

The description of each command and routine includes the format of the command in a syntax diagram. The diagram shows the operands for the commands. Use blanks to separate the operands, unless otherwise stated or diagrammed.

To construct a command from the diagram, follow the diagram from left to right, choosing the path that suits your needs. Following is a sample syntax diagram that explains how to use it to construct a command. This command is for illustration only. Do not attempt to enter it.

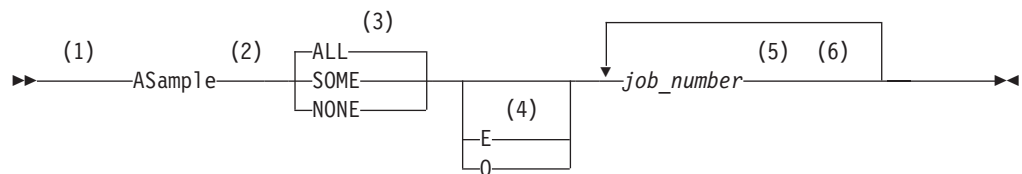

Notes:

- 1 Start here. ►► indicates the start of the diagram.
- 2 Type ASAMPLE, or abbreviate to AS. The uppercase characters are the abbreviation. Operands on the main line are required.

- 3 Choose one of the options. The default is always above the main line. In this case, ALL is the default. If the option includes punctuation marks, include them too: =(), .
- 4 Choose E, Q, or neither. Operands below the main line are optional.
- 5 Repeat *job_number* any number of times. Variables are shown in italics. Replace them with a real name or value.
- 6 End here. →◀ indicates the end of the command.

If a command continues to the next line, you see → and ▶-.
|and| indicates a fragment for a specific condition or option.

Examples:

```
====> asample none q DAF00821 DAF00832 ELD00824  
====> as some DLR01445
```

Part 2. SA z/OS System Operations Routines

Chapter 2. Common Routines	7	AOFAPMON	96
Using System Operations Common Routines for Programming	7	AOFATMON	96
ACF	7	AOFCPSM	97
ACFCMD	12	AOFUXMON	97
ACFFQRY	21	INGPJMON	98
ACFREP	26	ISQMTSYS	100
AOCGETCN	34	Chapter 4. Generic Routines	101
AOCMSG	35	Using SA z/OS Generic Routines for Programming	101
AOCQRES	40	ACTIVMSG	101
AOCQRY	41	AOFCPSMG	104
AOCUPDT	55	AOCFILT	107
AOFEXCMD	59	FWDMSG	109
AOFTREE	60	HALTMSG	110
ASF	64	ISSUECMD	113
ASFUSER	68	ISSUEREP	117
CDEMATCH	71	OUTREP	123
CHKSUBS	77	TERMMSG	126
CHKTHRES	77	Chapter 5. Utilities	133
INGPOST	80	Additional Parameters for System Operations	
INGPW	84	Commands	133
INGRCLUP	88	INGDATA	137
INGRTCMD	89	INGMON	138
INGUSS	89	INGSTOBS	139
MDFYSHUT	92	INGTIMER	141
Chapter 3. Monitoring Routines	95	INGVARS	143
Using System Operations Monitoring Routines for Programming	95	INGVTAM	145
AOFADMON	95		

This part describes System Automation for z/OS common commands -- specifics of how to enter them and their format.

Refer to *System Automation for z/OS User's Guide* for general information about SA z/OS commands.

Chapter 2. Common Routines

Using System Operations Common Routines for Programming

SA z/OS provides common and generic routines for use in automation procedures. Common and generic routines are convenient routines that provide your automation procedures with a simple, standard way of interfacing with the automation control file, the automation status file, and the NetView log file. It is strongly recommended that you use these routines wherever possible in your own code.

Using common and generic routines in automation procedures provides you with the following advantages:

- Reduced development time -- less code has to be written
- Portable code -- automation policy information that is unique to an enterprise can be kept in the automation control file rather than distributed among many automation procedures. The automation procedures implement a number of different rules for handling a situation and the automation control file is used to select which rules are applicable to the current situation.
- A consistent, documented interface

Refer to Chapter 4, "Generic Routines," on page 101 for further information on how to use generic routines.

ACF

Purpose

The ACF command loads, displays, and modifies automation control file entries.

For modification and display actions to work, the automation control file must be loaded into storage. Once loaded, the displays and modifications affect an in-storage version of the automation control file, allowing you to make *temporary* changes. To make permanent changes, change the automation policy using the customization dialogs, generate the automation control file member, then reload the new version using INGAMS.

Alternatively, temporary changes to the automation control file can be made semi-permanent by saving the automation environment to a warm start cache with the ACF SAVE command. This enables your changes to be restored on a subsequent warm start. It is recommended that you change the associated policy using the customization dialogs to ensure that the policy is applied upon a cold start.

See also the related command, "ACFFQRY" on page 21.

Recommendations

- Changes to automation policy using the SA z/OS command dialogs, or the ACF command are temporary. They modify the current in-storage version of the automation control file directly. They do not modify the automation control file stored on disk. The ACF SAVE command can be used to save any changes to a warm start cache for subsequent restoration using the ACF WARM command, or warm start. To change an automation policy setting permanently, make sure you also change the automation control file (using the customization dialogs) stored on disk.
- If the customization dialogs are used to rebuild the policy on disk, then the changed data on disk will replace the data in storage at ACF REFRESH. It will also replace the data on CACHE if you specify the SAVE option.
- Use scope-checking to limit operator use of ACF to loading, saving and display operations.

Syntax

The following syntax diagrams show how to use the ACF command to perform the different functions ACF supports. Do not combine syntax from the separate diagrams in the same ACF call.

To display information in the automation control file use the following syntax:

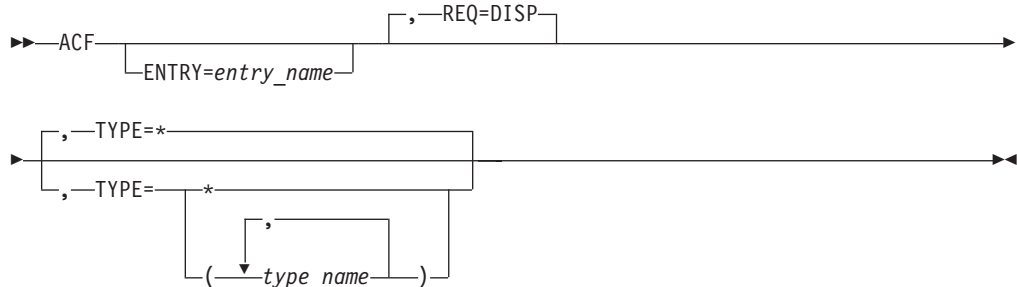

To delete information in the automation control file use the following syntax:

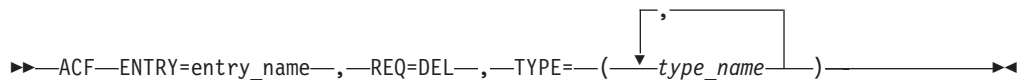

To replace or add information in the automation control file use the following syntax:

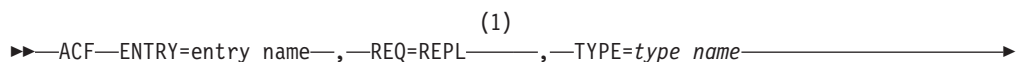

**Notes:**

- 1 Use this syntax when the ACF data are passed to the ACF command via the NetView default safe.

Note: The ACF command is free-form: commas are optional; more than one space can separate keywords; keywords can be specified in any sequence; any parameters specified must follow the keyword to which they apply.

Parameters**REQ=**

The type of request for automation control file information the ACF command performs. This value can be one of the following:

Value Description

DISP	Displays information in the automation control file. This value is the default if this parameter is not coded.
DEL	Deletes information in the automation control file. This value must be coded when using ACF to delete automation control file information.
REPL	Replaces or adds information in the automation control file. This value must be coded when using ACF to replace automation control file information. REPL adds the entry specified on the ENTRY parameter if the entry does not already exist in the automation control file.

REQ=REPL will update data in place. That is, only data that is to be replaced needs to be specified in the command. All other existing data will be retained.

ENTRY=

The entry field of the automation control file. This value can be up to 32 characters long, without imbedded blanks, commas, or quotes.

If information in the automation control file is displayed (REQ=DISP), and no value is specified in the entry field, ENTRY=* is used.

TYPE=

The type field in the automation control file. The following values can be specified:

- * Specifying * returns all type fields associated with a given entry_name, for example, all SUBSYSTEM or NTFYOP entries. * is the default value when REQ=DISP (display). REQ=DISP supports the use of * as a wildcard character when specifying type names, with the following restrictions:
 - The wildcard character, '*', must be the last character in the type name. If an asterisk appears in any other position in a type name then it will be treated as a literal. If an asterisk appears in any other position in a type name with an asterisk as the last character then no wildcard processing occurs and *both* asterisks are treated as literals.
 - You must specify the ENTRY= operand without a wildcard.

- If no matches are found, a final search is performed with a type name of DEFAULTS.

For other ACF request types (delete and replace), you must specify an actual type name.

type_name

The name of the type field. REQ=REPL requests allow you to enter only one *type_name*.

When ENTRY=SUBSYSTEM, *type_name* can be up to 11 bytes long. In all other cases, *type_name* can be up to 32 characters long, without imbedded blanks, commas, or quotes.

(type_name,type_name,...)

Multiple types may be specified for DISP and DEL requests. Type names should be enclosed in parentheses and separated by commas. For REQ=DISP, only the first type name found is displayed. For REQ=DEL requests, all the type names will be deleted.

parms=value

The data associated with the specified ENTRY and TYPE fields. This field is valid only with the REQ=REPL option. Specify this field as the parameter value, an equal (=) sign, and the value, without any spaces in between; for example, AUTO=NO.

The value can be any character data. It can have imbedded quotes, commas, and blanks, provided that single quotes or parentheses frame the value.

SA z/OS defines several ENTRY, TYPE, and parms=value fields. A parms=value example is the JOB=jobname parameter in the SUBSYSTEM automation control file entry.

Note: REQ=REPL will update data in place. That is, only modified data is updated. All data will be retained.

Restrictions and Limitations

The ACF command should be used with care to change or delete automation policy settings. Temporary changes can be saved to a warm start cache. Changes saved to a warm start cache are restored upon a warm start or an ACF WARM command.

ACF is used as an API to the automation control file. It could also be used as an operator command, for example, ACF STATUS, to get information about the automation control file. For further information about ACF as an operator's command refer to *System Automation for z/OS Operator's Commands*.

The number of entries in the automation control file is limited only by the amount of storage in the SA z/OS address space or region. If you have a very large configuration, you may have to increase the REGION size in the SA z/OS procedure.

The size of the pre-allocated Save/Restore database is the only limiting factor in saving an automation environment. Ensure that secondary extents are defined. See *NetView Administration Guide* for more information on defining Save/Restore databases.

Not all data can be changed using ACF REQ=REPL, for example, service periods, events, triggers, dependencies and groups cannot be changed. ACF REQ=DEL and

ACF REQ=REPL cannot be used to add or delete a subsystem. Use the customization dialogs to define these items.

Changes to 'System Defaults' and 'Application Defaults' are not propagated to the instances that have inherited this data.

Usage

- When you use ACF REQ=DISP to request a certain ENTRY value with one or more specific TYPE values, ACF searches for those types in the order specified in the command. When the first match is found, the information is returned to the requester as a multiline message. If there are no matches, it performs a final search with a type_name of DEFAULTS for that ENTRY value. If there is still no match, a message is returned to the requester. If the type_name DEFAULTS is found, that information is returned to the requester.
- When ACF is used to display an automation control file entry, if a specific TYPE is found, it is treated as a complete entry. Only that specific entry is displayed.

Messages

The following lists messages that are issued during the operation of ACF.

For the delete and replace function:

```
AOF001I REQUEST REPL SUCCESSFUL FOR JES2-$HASP098
```

Note: In a display where the type_name is * (asterisk), multiple sets of AOF112I and AOF113I messages may be displayed. When the type is omitted or specified as *, the DESIRED TYPE is not displayed on the AOF112I message.

For the display function:

```
AOF041I UNABLE TO FIND type_name entry_name

AOF111I AUTOMATION CONFIGURATION DISPLAY - ENTRY= entry_name
AOF112I ACTIVE TYPE= act_type, DESIRED TYPE= desired_type ...
AOF113I DATA IS data=value
AOF002I END OF MULTILINE MESSAGE
```

For example, the following may occur:

```
AOF111I AUTOMATION CONFIGURATION DISPLAY - ENTRY= NTFYOP
AOF112I ACTIVE TYPE= NETOP1
AOF113I DATA IS OPER='OPER 1'
AOF113I DATA IS CLASS=(10,40)
AOF112I ACTIVE TYPE= NETOP2
AOF113I DATA IS CLASS=(10)
AOF002I END OF MULTILINE MESSAGE
```

Note: Use of the replace parameter (REPL) adds an entry if none exists, resulting in a successful message.

Generic error messages that can occur:

```
AOF013I SPECIFIED OPERAND operand INVALID FOR PARAMETER parameter.
AOF025I SYNTAX ERROR
```

Examples

The ACF command to display the Start automation flag for the JES2 subsystem is:

```
ACF REQ=DISP,ENTRY=START,TYPE=CICST
```

ACF

The response is:

```
AOF111I AUTOMATION CONFIGURATION DISPLAY - ENTRY= START
AOF112I ACTIVE TYPE= CICST      , DESIRED TYPE= CICST
AOF113I DATA IS AUTO=Y
AOF113I DATA IS NOAUTO=(TUESDAY,10:00,12:00)
AOF002I END OF MULTILINE MESSAGE
```

In this example, a Start automation flag exists for the CICST subsystem. The operator or automation procedure processes the command to display the entry, and the associated response is returned as a multiline message.

Use the following automation procedure to update ACF data for an entry. It allows you to modify the automation agent configuration data without affecting other automation agents or the automation manager.

```
/* ***** **
** Function:                               **
**   - Read ACF Fragment                    **
**   - Modify ACF entries                   **
** ***** */
'PIPE (NAME ACFREPL)',
'QSAM (DSN) -dataset-', /* read ACF fragment */
'! NLOC 1.1 /*/',      /* skip comments */
'! COLLECT',          /* collect to multiline */
'! NETV ACF REQ=REPL', /* call ACF command */
'! CONS'              /* issue msgs to console */
```

ACFCMD

Purpose

The ACFCMD routine allows an automation procedure to issue commands defined in the automation policy. It searches the automation control file for the specified entries, performs variable substitution for predefined variables, then issues the commands.

ACFCMD can also issue commands that are built dynamically by the calling automation procedure and passed to ACFCMD through a special TGLOBAL named EHKCMD.

In general you should consider using ISSUECMD from the automation table, rather than calling ACFCMD directly. ISSUECMD has the following advantages:

- It will check the automation flags for you, to ensure that automation is allowed.
- It is already available.
- It will check that the job which issued the message is known to SA z/OS.

Syntax

To issue commands that are directly defined in the automation control file use the following syntax:

1. Syntax for directly defined commands

→ ACFCMD—MSGTYP=—(—*type*—) —,—ENTRY=—*entry*—

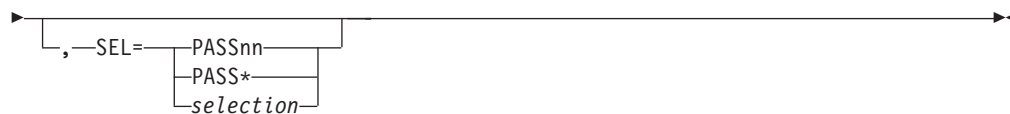

To issue commands built dynamically by the calling automation procedure use the following syntax:

2. Syntax

▶▶ ACFCMD—FUNC=—ISSUE—▶▶

Parameters

MSGTYP=*type*

This is the value entered in the *type* field in the automation control file entry for the command. MSGTYP is typically coded with the message ID or with a generic name, such as SPOOLSHORT or SPOOLFULL. The type fields are searched in the order specified until an entry or type match occurs.

When using this parameter the MSGTYPE IS version of AOF570I is issued and captured. You can adjust the severity of this message by adding the message type as the CODE3 entry of a CAPMSGs message policy (refer to “AOFCPMSG” on page 104 for information on CDEMATCH entries for captured messages).

This parameter is mutually exclusive with the FUNC=ISSUE parameter.

ENTRY=*entry*

This is the value entered in the entry field in the automation control file. To understand the entry fields in an automation control file and how they relate to automation policy settings, refer to *System Automation for z/OS Customizing and Programming* and to *System Automation for z/OS Defining Automation Policy*. The default is the application name if the commands are issued for applications.

This parameter is mutually exclusive with the FUNC=ISSUE parameter.

SEL=

This parameter provides the criteria for the first field in the command entry. This field gives detailed criteria to select a command or commands from the automation control file. Based on the MSGTYP, ENTRY and SEL fields, any specific command can be retrieved from a group of commands associated with a message entry. This parameter is mutually exclusive with the FUNC=ISSUE parameter.

The commands associated with the specific pass selection value defined in the automation policy are issued, along with all commands defined without a selection value. For selection values beginning with PASS, additionally those commands with the pass selection value of PASS* are issued.

IF no SEL parameter is coded, all commands are selected without respect to any pass selection value in the first field of the command entry.

PASS*nn*

PASS*nn* values can range from 1 through 99 and must be coded without leading zeros, such as PASS1, PASS2, and PASS3.

When SEL=PASS nn is specified, commands associated with the PASS nn selection value defined in the automation policy are issued, along with all commands defined with a selection value of PASS* or with no selection value.

PASS*

When SEL=PASS* is specified, commands associated with the PASS* selection value defined in the automation policy are issued, along with all commands defined with a selection value beginning with the prefix PASS or with no selection value.

selection

When SEL=*selection* is specified, the commands associated with the specific selection value defined in the automation policy are issued, along with all commands defined without a selection value.

FUNC=ISSUE

The command to be issued has been passed in the special TGLOBAL EHKCMD. ACFCMD issues and logs the command in the TGLOBAL EHKCMD.

When using this parameter the FUNC=ISSUE version of AOF570I is issued and captured. You can adjust the severity of this message by adding the message type as the CODE3 entry of a CAPMSGs message policy (refer to "AOF570I" on page 104 for information on CDEMATCH entries for captured messages).

This parameter is mutually exclusive with the MSGTYP, ENTRY, and SEL parameters.

Restrictions and Limitations

This routine can be called only by another automation procedure or by a command processor. The common routine AOCQRY must be invoked first to set the TGLOBALs SUBSAPPL and SUBSTYPE.

The ACF COLD command and the ACF WARM command temporarily disable automation. ACFCMD will not work while the automation control file is being reloaded. This is necessary to ensure that the SA z/OS environment, as defined by the reloaded automation control file, is established correctly. Full automation resumes when the AOF540I - INITIALIZATION RELATED PROCESSING HAS BEEN COMPLETED message has been received.

Return Codes

Return codes are:

- 0 At least one command was found and issued.
- 1 No commands meeting the selection criteria were found.
- 2 The issued command returned a non-zero return code and return code checking was enabled through the customization dialogs.
- 4 Invalid parameters were used in the call.
- 5 Timeout or other error occurred.
- 6 SA z/OS initialization incomplete, unable to process command request.

Usage

- ACFCMD can issue multiple commands during a single instance of processing. Automation control file entries can be entered using one ENTRY and MSGTYP combination, with multiple detail entries having duplicate selection fields.

During processing all duplicate selection fields are located and their associated commands are issued, provided selection fields match the selection criteria.

- When FUNC=ISSUE is used this routine can issue only one command during a single instance of processing.
- SA z/OS variable CMDCNTHI is returned to the calling automation procedure as a TGLOBAL value. ACFCMD retrieves all command entries for a given ENTRY/MSGTYP and searches for the highest PASS $_{nn}$ number. The highest PASS $_{nn}$ number is returned in CMDCNTHI. You can use this number to determine whether all available commands are issued and an appropriate error message should be issued to the operator. If PASS $_{nn}$ is not coded, CMDCNTHI is zero.
- Nine variables are available to change the command entered in the automation control file. Variables &EHKVAR1 through &EHKVAR9 must be defined as TGLOBALS in the calling automation procedure and must be initialized with the data to change the commands. These variables are passed to ACFCMD. Whenever ACFCMD finds a detail command entry in the automation control file it scans the command entry looking for &EHKVAR n . If an &EHKVAR n variable is found, the value stored in the automation procedure variable replaces the &EHKVAR n in the command entry. Multiple &EHKVAR n variables can be coded in a single command entry. Delimiters are unnecessary, and the variables can be coded between any other text.

TGLOBALS

Name	Description
EHKCMD	Must contain the command that is to be issued when FUNC=ISSUE is coded.
CMDCNTHI	The number of the highest PASS $_{nn}$ field found.
EHKVAR1 through EHKVAR9	Variable data to change the command entry; dependent on coding in the automation procedure.

If the AOCQRY common routine has been invoked, it sets the following TGLOBALS if the appropriate information is applicable. These variables can be used to alter a command entered in the automation control file:

- SUBPAPPL
- SUBPCMDPFX
- SUBPDESC
- SUBPJOB
- SUBPSHUTDLY
- SUBSAPPL
- SUBSASID
- SUBSCMDPFX
- SUBSDESC
- SUBSFILE
- SUBSJOB
- SUBSPATH
- SUBSPID
- SUBSPORT
- SUBSPROC

- SUBSSCHEDSS
- SUBSSHUTDLY
- SUBSSPARM
- SUBSSUBTYPE
- SUBSUSER
- SUBSUSSJOB

These TGLOBALs are translated when found.

Examples

Example 1

This example shows the relationship between ACFCMD and the automation control file. The message to automate, \$HASP607, is produced by the JES2 subsystem and indicates that JES2 is not dormant. The automation procedure responds to this by calling ACFCMD to issue a command to stop the JES2 initiators, (MVS \$PI).

The command is defined in the automation policy through the customization dialog panels.

If you type DISPACF JES2 \$HASP607 a panel similar to Figure 1 is displayed.

```

AOFK3D0X          SA z/OS - Command Response          Line 1    of 4
Domain ID   = IPSNO   ----- DISPACF -----          Date = 06/05/00
Operator ID = NETOP1                                     Time = 15:17:01

Command = ACF ENTRY=JES2,TYPE=$HASP607,REQ=DISP
SYSTEM = KEY3      AUTOMATION CONFIGURATION DISPLAY - ENTRY= JES2
-----
AUTOMATION CONFIGURATION DISPLAY - ENTRY= JES2
TYPE IS $HASP607
CMD          = (.,'MVS $PI')
END OF MULTI-LINE MESSAGE GROUP

Command ==>
PF1=Help      PF2=End      PF3=Return      PF6=Roll
               PF9=Refresh  PF12=Retrieve

```

Figure 1. DISPACF Command Response Panel

The automation procedure to issue this command is:

```

/* REXX CLIST to automate $HASP607                                */
/* Check whether automation allowed and set TGLOBALs              */
'AOCQRY ...'
:
'ACFCMD MSGTYP=$HASP607,ENTRY=JES2'
Select
  When rc = 0 Then Nop      /* Command issued OK                                */
  When rc = 1 Then Do      /* No commands issued; warn if required            */
:
End

```



```

    Otherwise Do          /* Error; perform warning action      */
    :
    End
End
Exit

```

ACFCMD uses the parameters passed to it to find the corresponding values in the automation policy. Because no SEL parameter is coded, no selection restriction is made with respect to the first field of the command entry.

Upon return to the automation procedure, the rc special variable is checked to ensure a command was found in the automation control file. The automation procedure takes appropriate action if a command is not found or a processing error occurs in the ACFCMD routine.

Example 2

This example uses the same scenario as Example 1, but shows how you can use defaults to minimize coding. The message to automate, \$HASP607, is produced by the JES2 subsystem and indicates that JES2 is not dormant. The automation procedure responds by calling ACFCMD to issue a command to stop the JES2 initiators (\$PI).

The command is defined in the automation policy as in Example 1.

The automation procedure to issue this command is:

```

/* REXX CLIST to automate $HASP607                                */
/* Check whether automation allowed and set TGLOBALs             */
'AOCQRY ...'
:
'ACFCMD MSGTYP='Msgid()
Select
  When rc = 0 Then Nop      /* Command issued OK          */
  When rc = 1 Then Do      /* No commands issued; warn if required */
  :
  End
  Otherwise Do            /* Error; perform warning action */
  :
  End
End
Exit

```

This example differs from Example 1 in the following ways:

- ACFCMD uses a NetView REXX function for the MSGTYP field, assumes defaults for the ENTRY and SEL fields and uses task globals set up by AOCQRY for the ENTRY default.
- The ENTRY field defaults to JES2 because the job name on the message was the job name for the JES2 subsystem, so the SUBSAPPL task global (which is the default entry type) currently contains JES2. Common routine AOCQRY must be called before ACFCMD for the ENTRY default to work correctly.
- The MSGTYP field uses the NetView REXX function Msgid(), which contains the message identifier for the message that called the automation procedure. This message identifier is supplied only to an automation procedure called from the NetView automation table. This value can be used when calling ACFCMD.

ACFCMD

Note: If your code issues a WAIT command before it issues the ACFCMD you must store the msgid() value in a temporary global as the NetView MSGREAD command overwrites the data from the message that invoked the procedure.

Assuming that AOCQRY is invoked to check the Shutdown flag, both of the above examples are equivalent to invoking from the NetView automation table for \$HASP607:

```
ISSUECMD AUTOTYP=TERMINATE
```

Example 3

This example shows the use of *PASS_n* logic in an automation procedure. The message to automate, \$HASP607, is produced by the JES2 subsystem and indicates that JES2 is not dormant. The automation procedure responds the first time by stopping the JES2 initiators (\$PI command), and the second time by abending JES2 (\$P JES2,ABEND).

The commands are defined in the automation policy through the customization dialogs. The data is stored in the automation control file in the following way:

```
AOFK3D0X          SA z/OS - Command Response          Line 1    of 5
Domain ID   = IPSNO  ----- DISPACF -----          Date = 06/06/00
Operator ID = NETOP1                                     Time = 13:09:05

Command = ACF ENTRY=JES2,TYPE=$HASP607,REQ=DISP
SYSTEM = KEY3      AUTOMATION CONFIGURATION DISPLAY - ENTRY= JES2
-----
AUTOMATION CONFIGURATION DISPLAY - ENTRY= JES2
TYPE IS $HASP607
CMD          = (PASS1,,'MVS $PI')
CMD          = (PASS2,,'MVS $P JES2,ABEND')
END OF MULTI-LINE MESSAGE GROUP

Command ==>
PF1=Help      PF2=End      PF3=Return      PF6=Roll
              PF9=Refresh  PF12=Retrieve
```

The automation procedure to issue the commands is:

```
/* REXX CLIST to automate $HASP607 */
/* Check whether automation allowed and set TGLOBALs */
'AOCQRY ...'
:
/* Increase the counter unique to this automation procedure */
'GLOBALV GETC HASP607_CNT'
If hasp607_cnt = " Then hasp607_cnt = 1
Else hasp607_cnt = hasp607_cnt + 1
'GLOBALV PUTC HASP607_CNT'
/* Issue the ACF command for the pass number as determined */
'ACFCMD MSGTYP='Msgid()',SEL=PASS'hasp607_cnt
Select
  When rc = 0 Then Nop      /* Command issued OK */
  When rc = 1 Then Do      /* No commands issued; warn if required */
:
End
```

```

Otherwise Do          /* Error; perform warning action      */
:
End
End
Exit

```

This example differs from the previous examples in the following ways:

- The automation procedure uses a unique CGLOBAL variable, in this case HASP607_CNT, to maintain a PASS counter. The automation procedure adds 1 to this counter each time it is processed, then appends the counter to the SEL=PASS field. During processing, the counter is translated, and PASS1 or PASS2 is processed. Note that a null test is required to set the counter to 1 if it has not been set before. If the counter exceeds 2 then the ACFCMD will set a return code of 1 since there is no matching entry in the automation control file.

Note: This example assumes you are using one JES subsystem. If you are using multiple JES subsystems, you must use a different counter variable for each.

- Another automation procedure that resets the counter is necessary to complete the logic flow. For this example, the automation procedure runs when the final JES2 message or a startup message is received. Note that the counter is cleared rather than set to zero. This saves an entry in the NetView global dictionary unless the message \$HASP607 has occurred.

The automation procedure to reset the counter is:

```

/* REXX CLIST to reset the counter                                */
hasp607_cnt = ''
'GLOBALV PUTC HASP607_CNT'
Exit

```

Notes:

1. To ensure serialization of access to the NetView global dictionary and the correct ordering of the commands issued, the NetView automation table entry should route the command to a specific operator if the message may occur more than once in quick succession.
2. If AOCQRY is checking the Shutdown flag this example could be coded as:
ISSUECMD AUTOTYP=TERMINATE,PASSES=YES

The pass count will be reset when the application final termination message is processed.

Example 4

This example shows the use of EHKVAR n variables. It also shows the use of duplicate selection fields because two entries are coded, each with PASS1. The message to automate is given in response to the JES2 \$DU command, which displays all JES2 devices. The message ID produced by JES2 is \$HASP628. The example assumes the full text of the message is passed to the automation procedure. The automation procedure checks the resource type, and if the resource is a line, stops the line using the \$P LINE nn command, then stops current activity with a restart command, \$E LINE nn .

The commands are defined in the automation policy through the customization dialog panels. The data is stored in the automation control file in the following way:

```

AOFK3D0X          SA z/OS - Command Response          Line 1 of 5
Domain ID = IPSNO ----- DISPACF -----          Date = 06/06/00
Operator ID = NETOP1                                Time = 13:00:51

Command = ACF ENTRY=JES2,TYPE=$HASP628,REQ=DISP
SYSTEM = KEY3      AUTOMATION CONFIGURATION DISPLAY - ENTRY= JES2
-----
AUTOMATION CONFIGURATION DISPLAY - ENTRY= JES2
TYPE IS $HASP628
CMD              = (PASS1,, 'MVS $P &EHKVAR1')
CMD              = (PASS1,, 'MVS $E &EHKVAR1')
END OF MULTI-LINE MESSAGE GROUP

Command ==>
PF1=Help      PF2=End      PF3=Return      PF6=Ro11
              PF9=Refresh  PF12=Retrieve

```

The automation procedure to issue the commands is:

```

/* REXX CLIST to automate $HASP628                                */
/* Check whether automation allowed and set TGLOBALs             */
'AOCQRY ...'                                                     */
:
/* Assign EHKVAR1 to parameter 2 (resource name on $HASP628 msg)
then determine whether the first characters are LINE, if not, exit */
ehkvar1 = Msgvar(2)
If Left(ehkvar1,4) <> 'LINE' Then Exit
'GLOBALV PUTT EHKVAR1'
'ACFCMD MSGTYP='Msgid()',SEL=PASS1'
Select
  When rc = 0 Then Nop      /* Command issued OK                */
  When rc = 1 Then Do      /* No commands issued; warn if required */
:
  End
  Otherwise Do              /* Error; perform warning action      */
:
  End
End
Exit

```

Following are the processing steps the automation procedure performs:

1. The EHKVAR1 variable is assigned the value in the second parameter sent to the automation procedure, which for the \$HASP628 message is the resource type
2. The automation procedure verifies that the resource type is a LINE, then sets the variable into a TGLOBAL variable and calls ACFCMD
3. Assuming the second parameter is LINE21, two commands are issued from this automation procedure:

```

$P LINE21
$E LINE21.

```

ACFFQRY

Purpose

The ACFFQRY command provides a fast, pipeable means of accessing the SA z/OS automation control file from your automation procedures.

See also the related command “ACF” on page 7.

Syntax

The following syntax diagram shows how to use the ACFFQRY command to query the automation control file.

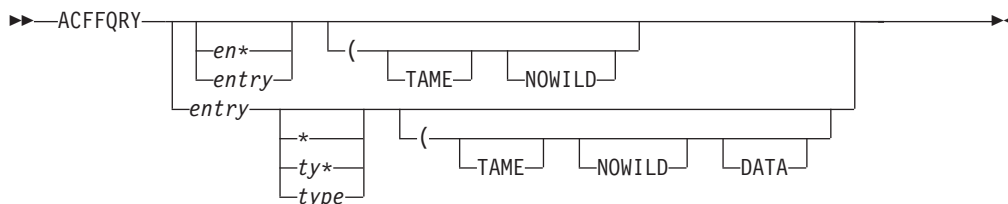

Parameters

entry

This is the *entry* value to be used to search the automation control file. The entry value may take the following forms:

* The entry value is the wildcard character, unless TAME is specified.

*en** The entry value ends with the wildcard character, unless TAME is specified.

entry A specific entry value is entered. You must enter a specific entry value if you want to specify a type value.

type

This is the *type* value to be used to search the automation control file. A type value can be specified *only* when a specific entry value is entered. The type value may take the following forms:

* The type value is the wildcard character, unless TAME or NOWILD is specified.

*ty** The type value ends with the wildcard character, unless TAME or NOWILD is specified.

type A specific type value is entered.

TAME

Wildcards in the entry and type name in the automation control file database are to be matched against the entry and type specified on the search. TAME allows for wildcards IN THE DATABASE you are searching. For example, with a constant query string, such as AAA 123 you can match on multiple entries in the automation control file, such as AAA 12*.

This means that if user entries and types have been set up in the automation control file with an asterisk for the last character they are taming candidates. This may be particularly useful for situations where generic rather than specific data is maintained and used in automation procedures.

ACFFQRY

NOWILD

The asterisk (*) character in the query string is to be treated as a literal.

DATA

The keyword=value data related to the entry/type pair is to be returned.

Restrictions and Limitations

A type value can be specified only if a specific entry value is specified.

Usage

It is most efficient if it is called within a PIPE, but may also be called within a TRAP/WAIT/MSGREAD.

TGLOCALS

None.

Messages

Output from ACFFQRY takes the form of a correlated multiline message, with one or two list items and data elements on each line of the message. There are no surrounding message IDs or details.

The first line of the multiline message is always the literal ACFFQRY:, followed by the return code from ACFFQRY. If output is present it begins on line two. This means that output returned in a stem must be processed from element two.

If keyword=data is returned, the entry and type will precede it. Your routines can differentiate entry/type output from data output by the presence of an equals (=) sign. For example:

```
If Pos('=' ,data.n) = 0 the Do
/* data line is an ENTRY TYPE */
End
Else Do
/* data line is an KEYWORD=VALUE */
End
```

- If both entry and type parameters are omitted, a list of all the entries is returned.
- If an entry is specified and the type is omitted, a list of the entry and all the types for that entry is returned.
- If both entry and type are specified, all the data for that entry/type combination is returned.
- If the parameters indicate an area where there is no data, a null list is returned.

Table 4 shows the result for various parameter combinations. An “-” means that an option is irrelevant to the output produced. An asterisk in the DATA column indicates that the keyword=value data is returned.

Table 4. Output from ACFFQRY

Entry	Type	TAME	NOWILD	DATA	Result
		-	-		List of all entries
en* or *		No	No		List of entries starting with “en”.
en* or *		Yes	No		List of all entries starting with en or taming en*.
entry		Yes	-	-	List of entries taming entry

Table 4. Output from ACFFQRY (continued)

Entry	Type	TAME	NOWILD	DATA	Result
entry		No	-	-	List of types for entry
entry	ty*	No	No	*	List of types for entry starting with ty
entry	ty*	Yes	No	*	List of types for entry starting with ty or taming ty*
entry	ty*	No	Yes	*	All data for entry entry and type ty*
entry	ty*	Yes	Yes	*	List of all types for entry taming ty*
entry	type	No	-	-	All data for entry entry and type type
entry	type	Yes	-	*	List of all types for entry taming type

Return Codes

These return codes appear on the first line of the returned data, after the literal ACFFQRY:.

- 0 Data returned.
- 1 There is no data for the specified parameters or SA z/OS is not fully initialized.
- 2 Too many parameters before the opening parentheses. You can specify at most an entry and a type, each of which is a single word.
- 3 Entry/Type combination not allowed. If you have specified an entry including an *, you may not specify a type.
- 5 The SA z/OS global variables containing internal automation control file information have been corrupted.
- 6 You have specified an invalid option.
- 7 You have specified an option more than once.

Examples

Example 1

An ACFFQRY specifying a full ENTRY value only
ACFFQRY SUBSYSTEM

returns all TYPE matches for that ENTRY.

```
ACFFQRY:0
SUBSYSTEM SYSVSSI
SUBSYSTEM SYSVIEW
SUBSYSTEM VLF
SUBSYSTEM LLA
SUBSYSTEM JES
SUBSYSTEM VTAM
SUBSYSTEM TSO
SUBSYSTEM RMF
```

Example 2

An ACFFQRY specifying a full ENTRY value and a full TYPE value
ACFFQRY SUBSYSTEM TSO

ACFFQRY

returns all KWD=DATA associated with the ENTRY/TYPE pair.

```
ACFFQRY:0
SUBSYSTEM TSO
JOB=TSO
DESC='Time Sharing Option'
SHUTDLY=00:01:30
```

Example 3

An ACFFQRY specifying a full ENTRY and a wild TYPE

```
ACFFQRY SUBSYSTEM V*
```

returns a list of all matching TYPES.

```
ACFFQRY:0
SUBSYSTEM VLF
SUBSYSTEM VTAM
```

Example 4

This example is the same as example 3, except that the DATA option is specified.

```
ACFFQRY SUBSYSTEM V* (DATA
```

The KWD=DATA values for all matches are returned.

```
ACFFQRY:0
SUBSYSTEM VLF
DESC='Virt Lib DEF'
SCHEDSUB=MSTR
JOBTYP= MVS
IPLOPTIONS=START
RECYCLEOPT=START
RESTARTOPT=ALWAYS
PARMS=' ,SUB=MSTR,NN=00'
SHUTDLY=00:03:00
STRTDLY=00:02:00
TERMDLY=00:00:15
JOB=VLF
SUBSYSTEM VTAM
DESC='VTAM V4.1'
PARMS=' ,,,(LIST=FP) '
SHUTDLY=00:01:00
JOB=VTMN24E
```

Example 5

This example shows the use of the TAME option.

```
ACFFQRY CONTROLLER QLN37A07 (TAME
```

All ENTRY/TYPES that include a wildcard that matches the search string are returned.

```
ACFFQRY:0
CONTROLLER QLN*
CONTROLLER QLN37*
CONTROLLER Q*
```

Example 6

This example is the same as example 5 except that the DATA option is specified.

```
ACFFQRY CONTROLLER QLN37A07 (TAME DATA
```

All KWD=DATA values for the ENTRY/TYPE list are returned.

```
ACFFQRY:0
CONTROLLER QLN*
LOCATION=NEW_YORK
TYPE=LOCAL
OWNER='FRED SMITH'
CONTROLLER QLN37*
LOCATION='Episode 1, Level 3, Oil Refinery'
TYPE=LOCAL
START='MVS VARY 04AE,ONLINE'
OWNER='JIM SMITH'
CONTROLLER Q*
LOCATION=USA
TYPE=GLOBAL
OWNER='BILL SMITH'
```

Example 7

This example shows the result of the NOWILD option.

```
ACFFQRY CONTROLLER QLN37* (NOWILD
```

The asterisk (*) is treated as a literal in the search pattern.

```
ACFFQRY:0
CONTROLLER QLN37*
LOCATION='Episode 1, Level 3, Oil Refinery'
TYPE=LOCAL
START='MVS VARY 04AE,ONLINE'
OWNER='JIM SMITH'
```

Example 8

The following example shows how to find the job name for a subsystem from a REXX routine, using the NetView PIPE facility.

```
Get_Jobname:
Arg subsystem .
'PIPE NETVIEW ACFFQRY SUBSYSTEM' subsystem '| STEM ALL_DATA.',
'| SEPARATE | LOCATE 1.4 /JOB=/ | TAKE 1 | STEM JOBNAME.'
If all_data.0 < 1 Then
  Call Terminal_Error 'PIPE 1 Failed'
If all_data.1 <> 'ACFFQRY:0' Then
  Return '
If jobname.0 = 0 Then
  Return subsystem
Parse var jobname.1 'JOB=' jobname .
Return jobname
```

Example 9

This example takes the name of a failing device and finds the appropriate person to notify. It makes use of the TAME option. The data being searched is:

```
DEVFAIL DEV1230,
CONTACT=MIK
DEVFAIL DEV12*,
CONTACT=JB
DEVFAIL DEV34*,
CONTACT=JAQUES
DEVFAIL DEV*,
CONTACT=MIK
CONTACT MIK,
page=00230936473
```

ACFFQRY

```
CONTACT JB,  
page=00234628164  
CONTACT JAQUES,  
page=00237564815
```

The code fragment below takes the number of a failing device and returns the paging number for the person to be notified. Note the use of subroutines, which make it easy to write similar queries and could replace the previous example.

```
Get_Page_Num:  
Procedure  
Arg device_number .  
match = Get_Best_Match('DEVFAIL',device_number)  
If match = ' ' Then  
    Return ' '  
contact = Get_Key('CONTACT=', 'DEVFAIL', match)  
If contact = ' ' Then  
    Return ' '  
Return Get_Key('page=', 'CONTACT', contact)  
  
Get_Best_Match:  
Procedure  
Arg entry ., type .  
'PIPE NETVIEW ACFFQRY' entry type '( TAME | STEM DATA.'  
If data.0 < 1 Then  
    Call Terminal_Error 'Get_Best_Match PIPE Failed'  
If data.0 <> 'ACFFQRY:0' Then  
    Return ' '  
match = ' ' /* Longest match = best match */  
match_len = 0  
Do i = 2 to data.0  
    If words(data.i) = 2 Then Do  
        data_val = word(data.i,2)  
        If Length(data_val) > match_len The Do  
            match = data_val  
            match_len = Length(match)  
        End  
    End  
End  
Return match  
  
Get_Key:  
Procedure  
Arg key ., entry ., type .  
'PIPE NETVIEW ACFFQRY' entry type '(NOWILD | STEM ALL_DATA.'  
' | SEPARATE | LOCATE 1.' || length(key) '/' || key || '/' ,  
' | TAKE 1 | STEM DATA.'  
If all_data.0 < 1 Then  
    Call Terminal_Error 'Get_Key PIPE Failed'  
If all_data.1 <> 'ACFFQRY:0' Then  
    Return ' '  
parse var data.1 .=' data_val  
Return data_val
```

ACFREP

Purpose

The ACFREP routine allows an automation procedure to issue replies defined in the automation policy. It searches the automation control file for the specified entries, performs variable substitution for predefined variables, then issues the reply.

ACFREP can also issue replies that are built dynamically by the calling automation procedure and passed to ACFREP through a special TGLOBAL named EHKRPY.

ACFREP issues replies to the resource identified by the TGLOBALs SUBSAPPL and SUBSTYPE, which are set by the common routine AOCQRY.

Syntax

To issue replies directly defined in the automation control file use the following syntax:

1. Syntax for directly defined replies

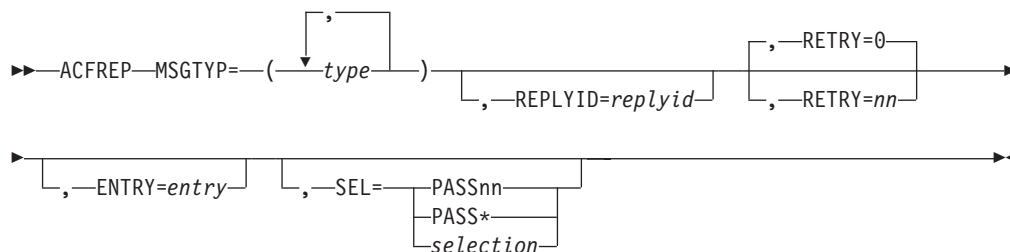

To issue replies built dynamically by the calling automation procedure use the following syntax:

2. Syntax

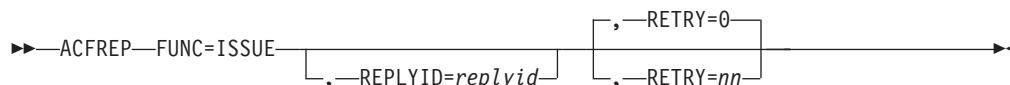

Parameters

MSGTYP

This is the value entered in the *type* field in the automation control file entry for the reply. The default is the message ID. MSGTYP is typically coded with the message ID or with a generic name, such as SPOOLSHORT or SPOOLFULL. The type fields are searched in the order specified until an entry or type match occurs. You can enter reply information to be called by ACFREP using the MESSAGES policy item of the application policy object. Refer to *System Automation for z/OS Defining Automation Policy* for further information.

When using this parameter the MSGTYPE IS version of AOF570I is issued and captured. You can adjust the severity of this message by adding the message type as the CODE3 entry of a CAPMSGs message policy (refer to "AOF570I" on page 104 for information on CDEMATCH entries for captured messages).

This parameter is mutually exclusive with the FUNC=ISSUE parameter.

REPLYID

The MVS reply identifier associated with this reply.

This parameter is optional. If it is not specified, the outstanding reply value is retrieved and used, regardless of the specified MSGTYP value.

RETRY

nn specifies the retry count if an outstanding reply is not available. Every two seconds, ACFREP attempts to retrieve an outstanding reply until the retry count is exhausted. When an outstanding reply ID is retrieved, the reply is issued. If no RETRY value is coded, ACFREP defaults to RETRY=0.

ENTRY

The criteria for the entry field during the reply search. This value relates to the entry field in the automation control file. To understand the entry fields in an automation control file and how they relate to automation policy settings, refer to *System Automation for z/OS Customizing and Programming* and to *System Automation for z/OS Defining Automation Policy*. The default is the application name if the replies are issued for an application.

You can enter reply information using the MESSAGES policy item of the application policy object. Refer to *System Automation for z/OS Defining Automation Policy* for further information.

SEL

This parameter provides the criteria for the first field in the reply entry. This field gives detailed criteria to select a reply or replies from the automation control file. Based on the MSGTYP, ENTRY and SEL fields, any specific reply can be retrieved from a group of replies associated with a message entry. This parameter is mutually exclusive with the FUNC=ISSUE parameter.

The replies associated with the specified pass selection value defined in the automation policy are issued, along with all replies defined without a selection value. For selection values beginning with PASS, those replies to the pass selection value of PASS* are additionally issued.

If no SEL parameter is coded all replies are selected without respect to any pass selection value in the first field of the reply entry.

PASSnn

PASSnn values can range from 1 through 99 and must be coded without leading zeros, such as PASS1, PASS2, and PASS3.

When SEL=PASSnn is specified, replies associated with the PASSnn selection value defined in the automation policy are issued, along with all replies defined with the selection value of PASS* or with no selection value.

PASS*

When SEL=PASS* is specified, replies associated with the PASS* selection value defined in the automation policy are issued, along with all replies defined without a selection value and all replies defined with a selection value beginning with the prefix PASS.

selection

When SEL=*selection* is specified, the replies associated with the specific selection value defined in the automation policy are issued, along with all replies defined without a selection value.

FUNC=ISSUE

The reply to be issued has been passed through the special TGLOBAL EHKRPY. ACFREP performs normal reply and log functions for the reply in the TGLOBAL EHKRPY.

When using this parameter the FUNC=ISSUE version of AOF570I is issued and captured. You can adjust the severity of this message by adding the message

type as the CODE3 entry of a CAPMSGs message policy (refer to "AOFCPMSG" on page 104 for information on CDEMATCH entries for captured messages).

This parameter is mutually exclusive with MSGTYP, ENTRY, and SEL parameters.

Restrictions and Limitations

This routine can be called only by another automation procedure or by a command processor. The common routine AOCQRY must be invoked first to set the TGLOBALs SUBSAPPL and SUBSTYPE.

ACFREP may only be run on the same autotask where the WTORS that ACFREP is to reply to would be processed by OUTREP if the WTOR reply number is passed to ACFREP as an input parameter. This is the case because the ACFREP command blocks the task while it is waiting for OUTREP to run. However, OUTREP cannot run because the task is busy. The OUTREP processing normally occurs on the task identified in the %AOFOPWTORS% automation table synonym, but the automation table may route the processing to a different autotask.

Return Codes

Return codes are:

- 0 A reply was found and issued.
- 1 No reply meeting the selection criteria was found.
- 2 No outstanding reply ID was found in the automation status file.
- 3 ACFREP successfully responded to only part of the defined replies.
- 4 Incorrect parameters were used in the call.
- 5 Timeout or other error occurred.
- 6 SA z/OS initialization incomplete, unable to process command request.

Usage

- Consider using ISSUEREP from the NetView automation table rather than using ACFREP directly.
- Multiple replies may exist for a given ENTRY, MSGTYP, or SEL field. For the second and subsequent replies, ACFREP always retrieves the outstanding reply number of a subsystem before issuing the reply. If an outstanding reply number does not exist when the reply should be issued, ACFREP attempts a retry if so defined. Retries may be defined either through the RETRY keyword of ACFREP or through the retry value specified in the policy entry. The retry value specified in your policy takes precedence over the RETRY keyword if both are specified. There is a 2-second delay between retry attempts.
- SA z/OS variable EHKRPYHI is returned to the calling automation procedure as a TGLOBAL value. ACFREP retrieves all reply entries for a given ENTRY or MSGTYP value and searches for the highest PASS nn number. The highest PASS nn number is returned in variable EHKRPYHI. You can use this number to determine whether all available commands are issued and an appropriate error message should be issued to the operator. If PASS nn is not coded, EHKRPYHI is zero.
- Nine variables are available to change the reply entered in the automation control file. Variables EHKVAR1 through EHKVAR9 must be defined as TGLOBALs in the calling automation procedure and must be initialized with the data to change the replies. These variables are passed to the ACFREP routine. Whenever ACFREP finds a detail reply entry in the automation control file, it scans the reply entry looking for &EHKVAR n . If an EHKVAR n variable is found,

the value stored in the variable replaces the &EHKVAR*n* in the reply entry. You can code multiple &EHKVAR;*n* variables in a single reply entry. Delimiters are unnecessary, and you can code the variables between any other text.

- If your automation procedure issues a TRAP command, you must save the message variables upon entry, because this information is lost whenever a TRAP command is issued.

TGLOBALS

Name	Description
------	-------------

EHKRPY	
---------------	--

	The reply to be issued when FUNC=ISSUE is coded.
--	--

EHKRPYHI	
-----------------	--

	The number of the highest PASS <i>nn</i> field found.
--	---

EHKVAR1 through EHKVAR9	
--------------------------------	--

	Variable data to change the reply entry; dependent on coding in the automation procedure.
--	---

If the AOCQRY common routine has been invoked, it sets the following TGLOBALs if the appropriate information is available. These variables can be used to alter a reply entered in the automation control file:

- SUBPJOB
- SUBSAPPL
- SUBSCMDPFX
- SUBSDESC
- SUBSJOB
- SUBSPROC
- SUBSSCHEDSS
- SUBSSHUTDLY
- SUBSSPARM

These TGLOBALs are translated when found.

Examples

Example 1

This example shows the relationship between ACFREP and automation policy. The message to automate, \$HASP426, is produced by the JES2 subsystem, requesting the JES2 startup specifications. The automation procedure responds to this by calling ACFREP to issue a reply of WARM,NOREQ from the automation control file.

The data is stored in the automation control file in the following way:

```

AOFK3D0X          SA z/OS - Command Response      Line 1   of 4
Domain ID   = IPSNO  ----- DISPACF -----      Date = 06/06/00
Operator ID = NETOP1                                     Time = 13:30:53

```

```

Command = ACF ENTRY=JES2,TYPE=$HASP426,REQ=DISP
SYSTEM = KEY3      AUTOMATION CONFIGURATION DISPLAY - ENTRY= JES2
-----

```

```

AUTOMATION CONFIGURATION DISPLAY - ENTRY= JES2

```

```

TYPE IS $HASP426
REPLY      = (,,'WARM,NOREQ')
END OF MULTI-LINE MESSAGE GROUP

```

```

Command ==>
PF1=Help      PF2=End      PF3=Return    PF6=Roll
               PF9=Refresh  PF12=Retrieve

```

The automation procedure to issue this reply is:

```

/* REXX CLIST to automate the reply to $HASP426          */
/* Check whether automation allowed and set TGLOBALs     */
'AOCQRY ...'
:
'ACFREP MSGTYP=$HASP426,REPLYID='Replyid()',ENTRY=JES2'
Select
  When rc = 0 Then Nop      /* Reply issued OK          */
  When rc = 1 Then Do      /* No reply issued; warn if required */
:
  End
  Otherwise Do             /* Error; perform warning action */
:
  End
End
Exit

```

ACFREP uses the parameters passed to the routine to find corresponding entries in the automation control file. Because no SEL parameter is coded, no selection restriction is made concerning the first field of the command entry.

Note that the function Replyid() is used for the REPLYID parameter. This function is a standard NetView REXX function which will only return a value to an automation procedure called from the NetView automation table, and only if a reply is required. You can use this value when calling ACFREP.

Upon return to the automation procedure, the rc special variable is checked to ensure that a reply was found in the automation control file. The automation procedure takes appropriate action if a reply is not found or a processing error occurs in ACFREP.

Note: Assuming that AOCQRY was checking the Start automation flag, this route could be replaced by coding:

```
ISSUEREP AUTOTYPE=START
```

Example 2

ACFREP

This example uses the same scenario as Example 1, but shows how you can use the defaults to minimize coding. The message to automate, \$HASP426, is produced by the JES2 subsystem and requests the JES2 startup specifications. The automation procedure responds to this by calling ACFREP to issue a reply of WARM,NOREQ from the automation control file.

The reply is defined in the automation policy in the same way as Example 1.

The automation procedure to issue the reply is:

```
/* REXX CLIST to automate the reply to $HASP426          */
/* Check whether automation allowed and set TGLOBALs    */
'AOCQRY ...'
:
'ACFREP MSGTYP='Msgid()',REPLYID='Replyid()'
Select
  When rc = 0 Then Nop      /* Reply issued OK          */
  When rc = 1 Then Do      /* No reply issued; warn if required */
:
  End
  Otherwise Do             /* Error; perform warning action */
:
  End
End
Exit
```

This example differs from Example 1 in the following ways:

- ACFREP uses a NetView REXX function for the MSGTYP field and assumes the defaults for the ENTRY and SEL fields.

The ENTRY field defaults to the value of SUBSAPPL. AOCQRY will set this value to the name of the application with which AOCQRY was invoked. In this case the value is JES2.

- The MSGTYP field uses the NetView REXX function `Msgid()`, which contains the message identifier for the message that called the automation procedure. This message identifier is supplied only to an automation procedure called from the NetView automation table. Use this value when calling ACFREP. Note that calling WAIT will replace the value of `Msgid()`.

Note: Assuming AOCQRY was checking the Start flag, this example could be replaced with:

```
ISSUEREP AUTOTYP=START
```

Example 3

This example shows the use of `PASS n` logic in an automation procedure. The message to automate, \$HASP098, is produced by the JES2 subsystem and requests the JES2 shutdown options. The automation procedure responds to this, the first Reply time, by calling ACFREP to issue a REPLY of DUMP from the automation control file, and the second time by issuing a reply of PURG.

Reply information is defined in the automation policy through the customization dialogs. The data is stored in the automation control file in the following way:

```

AOFK3D0X          SA z/OS - Command Response      Line 1   of 5
Domain ID   = IPSNO  ----- DISPACF -----      Date = 06/06/00
Operator ID = AFRANCK                                     Time = 13:36:31

```

```

Command = ACF ENTRY=JES2,TYPE=$HASP098,REQ=DISP
SYSTEM = KEY3      AUTOMATION CONFIGURATION DISPLAY - ENTRY= JES2
-----

```

```

AUTOMATION CONFIGURATION DISPLAY - ENTRY= JES2

```

```

TYPE IS $HASP098
REPLY          = (PASS1,, 'DUMP')
REPLY          = (PASS2,, 'PURG')
END OF MULTI-LINE MESSAGE GROUP

```

```

Command ==>

```

```

PF1=Help

```

```

PF2=End

```

```

PF3=Return

```

```

PF9=Refresh

```

```

PF6=Roll

```

```

PF12=Retrieve

```

The automation procedure to issue these replies is:

```

/* REXX CLIST to automate $HASP098                                */
/* Check whether automation allowed and set TGLOBALs             */
'AOCQRY ...'                                                     */
:
/* Increase the counter unique to this automation procedure      */
'GLOBALV GETC HASP098_CNT'                                       */
If hasp098_cnt = " Then hasp098_cnt = 1
Else hasp098_cnt = hasp098_cnt + 1
'GLOBALV PUTC HASP098_CNT'
/* Issue the ACF reply for the pass number as determined        */
'ACFREP MSGTYP='Msgid()',REPLYID='Replyid()',SEL=PASS'hasp098_cnt */
Select
  When rc = 0 Then Nop      /* Reply issued OK                */
  When rc = 1 Then Do      /* No reply issued; warn if required */
:
  End
  Otherwise Do             /* Error; perform warning action    */
:
  End
End
Exit

```

This example differs from the previous examples in the following ways:

- The automation procedure uses a unique CGLOBAL variable, in this case HASP098_CNT, to maintain a PASS counter. The automation procedure adds 1 to this counter each time it is processed, then appends the counter to the SEL=PASS field. During processing, the counter is translated, and PASS1 or PASS2 is run. Note that a null test is required to set the counter to 1 if it has not been set before. If the counter exceeds 2 then the ACFREP will set a return code of 1 since there is no matching entry in the automation control file.
- Another automation procedure that resets the counter is necessary to complete the logic flow. In this example, this automation procedure is processed when the final JES2 message or a startup message is received.

The automation procedure to reset the counter is:

```

/* REXX CLIST to reset the counter                               */
hasp098_cnt = ''
'GLOBALV PUTC HASP098_CNT'
Exit

```

Note: To ensure serialization of access to the NetView global dictionary and the correct ordering of the replies issued, the NetView automation table entry should route the command to a specific operator if the message may occur more than once in quick succession.

AOCGETCN

Purpose

The AOCGETCN command obtains an extended MCS console with a unique name for an operator or autotask issuing the command. If an MVS console is already associated with that task, it is released.

The default console name is the character A, followed by the last 5 characters of the task name concatenated with the last two characters of the system name.

Syntax

►►—AOCGETCN—*parameters*—►►

Parameters

Optionally, you may supply one or more parameters, which are valid for NetView's GETCONID, for example, ALERTPCT, MIGRATE, QLIMIT, QRESUME, or STORAGE.

If you specify more than one parameter, you can either separate them by blank or by comma, for example:

```
AOCGETCN MIGRATE=YES,STORAGE=1000
```

For further information and a list of valid GETCONID parameters and their descriptions, refer to the NetView documentation.

Restrictions and Limitations

The previous console will be released even if AOCGETCN fails to obtain the new console.

The GETCONID parameters `CONSOLE=xxxxxxx` and `AUTH=yyyyyy` are not supported. If you enter them, they will be ignored.

Usage

Console names within a sysplex must be unique. The task name is used if the console name is not specified. To avoid possible naming conflicts due to common task names AOCGETCN should be used to obtain a console with a unique name. The characters which are used in determining the unique console name can be tailored by updating the common global variable AOFCNMASK. Refer to *System Automation for z/OS Customizing and Programming* for further information.

Examples

Task OPER1, on system FOC1, has obtained the default extended console name of OPER1. The command AOCGETCN is issued. The console AOPER1C1 will now be associated with OPER1.

AOCMSG

Purpose

AOCMSG displays and logs messages. AOCMSG merges variable data specified as parameter values in the AOCMSG call with fixed message text to produce an SA z/OS message. You can display the resulting message on a NetView console and log it in the NetView log.

The message format depends on the message ID and variable data placed in the message.

If you specify one or more message classes in the message, AOCMSG also performs message class matching and sends the message as a notification message to one or more notification operators defined to receive those classes of notification messages.

AOCMSG uses the NetView message handling facilities, specifically NetView macros DSIMDS and DSIMBS. When you want to define user messages you must code a message definition module named AOFMaaa where aaa is the message prefix. Refer to *NetView Customization: Using Assembler* for the coding. Examples 1 and 2 in this section require a message definition module of AOFMABC.

The parsing within AOFMSG has been rewritten with an SA z/OS parsing routine used instead of DSIPRS. This allows SA z/OS to be more flexible in the handling of parameters. The parsing rules are:

- The only delimiter recognized in parsing the command is the comma.
- Tokens surrounded by single quotes will be stored without the quotes.
- A token containing two consecutive single quotes will be stored with only one of the quotes.
- Leading and trailing spaces are removed except that spaces inside quotes are not removed.
- Instead of rejecting a command with mismatched quotes an attempt is made to break the command into tokens.

The rules are illustrated by the following examples:

COMMAND	TOKENS
A,BCDEF, G	(A) (BCDEF) (G)
'A B C' , ' EF GH'	(A B C) (EF GH)
ABC,,DEF	(ABC) () (DEF)
'ABC,DEF,GHI	(ABC,DEF,GHI)
'ABC''DEF'	(ABC'DEF')
'ABC,DEF	('ABC) (DEF)
ABC'DEF	(ABC'DEF)
ABC'DEF'	(ABC'DEF')
'ABC'DEF	(ABC) (DEF)
'ABC'DEF'	(ABC) (DEF')
'ABC''DEF	(ABC) ('DEF)
ABC''	(ABC')

Note: AOCMSG has the facility to use MVS descriptor codes to control the message flow at the master console. Refer to *System Automation for z/OS Messages and Codes* for a table of message types and descriptor codes used by AOCMSG.

Syntax

Parameters are positional.

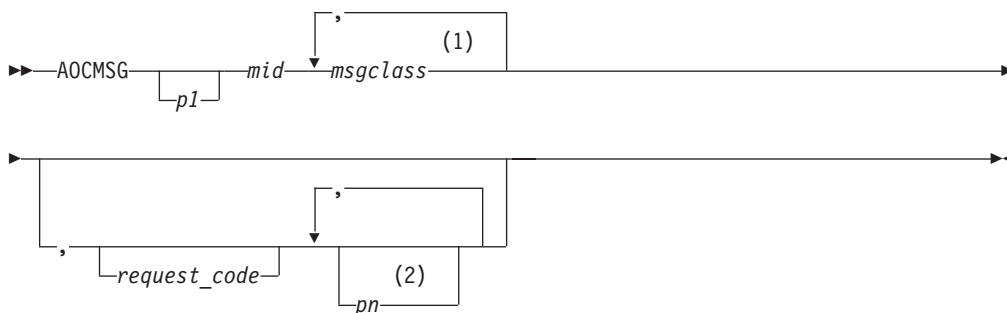

Notes:

- 1 Up to 10 optional message classes can be specified with the mid parameter. If used, message classes should be separated from the mid value and each other by at least **one** blank.
- 2 Parameters 2 to 9 may be specified here. Parameters are positional, so non-specified parameters must be represented by a comma.

Parameters

p1...p9

These are parameter values that are substituted into the message text (located in a NetView DSIMSG member) in place of NetView message variables &1 through &9, respectively. These parameter values are all optional. However, because parameters are positional, if you do not specify *p1*, you must code a comma for that parameter position, for example:

```
aocmsg ,abc123,,date(),time()
```

mid

The message ID to be issued. This parameter is required. The message ID must be a valid message installed in the NetView message library, that is, in data set members identified in DSIMSG. The message ID can be specified in the following ways:

- A 3-digit number, for which a prefix of AOF is assumed.
This message ID value relates to a message in DSIMSG member DSIAOF*nn*. For example, a message ID value of 203 is for SA z/OS message AOF203I, which is in DSIMSG member DSIAOF20.
- A 6-digit ID consisting of a 3-character prefix followed by a 3-digit message ID number. The first character of the prefix must be alphabetic.
This message ID value relates to a message in DSIMSG member DSI*xxxnn*, where *xxx* is the prefix value and *nn* is the first two digits of the message ID number. For example, a message ID value of ABC123 is for message ABC123I, which is in DSIMSG member DSIABC12.

- A 7-character ID consisting of a 4-character prefix followed by a 3-digit message ID number. The first character of the prefix must be alphabetic. The primary use for this type of message ID format is when coding a message ID for a message that has a 4-digit prefix.

When this type of message ID value is specified, AOCMSG drops the third of the four prefix characters to create the string used for searching DSIMSG members and retrieving the desired message. The actual message issued uses all four prefix characters.

For example, a message ID value of ABCD123 is used to retrieve message ABCD123I, which is in DSIMSG member DSIABD12 (note that the C is dropped in the DSIABD12 member name).

The message ID value can be up to 7 characters long.

Up to 10 optional dynamic message classes can be specified through the mid field. If specified, optional message classes will be merged with the message classes defined in the message member (if there are any) up to a maximum of 10 message classes. If the total number of message classes exceeds 10, then those specified on the AOCMSG call will take precedence over those specified in the message member.

The rules for dynamic message classes are the same as for those defined in the message member.

Message classes specified on the AOCMSG call will be taken into consideration for the following request_codes:

blank
LOG
MIM

When NOMID is used, any message classes specified on the AOCMSG call will be ignored. However, any message classes defined in the message member will continue to appear in the resulting message text.

request_code

This parameter specifies the type of message processing request the AOCMSG common routine performs. The value for this parameter can be one of the following:

Value Description

blank If you leave this parameter position blank, or enter any text other than the values listed below, AOCMSG will generate the message for display. This is the default.

LOG AOCMSG generates the message and logs the message in the NetView log instead of displaying it on the issuer's console.

MIM (Message in Message)

AOCMSG generates the message and strips the message ID value (*mid*) from the generated message, leaving only the message text. The first word in the message is treated as a valid message ID value (*mid*), and processing continues as if that word were the original *mid*. That is, AOCMSG performs message class matching and notification. See the AOCMSG examples for an example of how this parameter value affects the issued message.

NOMID (No Message ID)

AOCMSG generates the message and strips the message ID value (*mid*)

from the generated message, leaving only the message text. AOCMSG does not perform message class matching and notification. See the AOCMSG examples for an example of how this parameter value affects the issued message.

Note: With the exception of the NOMID *request_code* value, forwarding of notification messages to notification operators occurs regardless of the value specified for this parameter.

Restrictions and Limitations

Each variable parameter value besides the message ID value (mid) can be up to 80 characters long, but the total maximum message length is 213 characters.

An operator can call this routine from an automation procedure or command processor, or issue it directly from a display station.

Return Codes

Return codes are:

- 0 AOCMSG processed normally.
- >0 and <60 An error occurred while processing the NetView DSIPSS macro. The return code is actually from DSIPSS.
- 60 An error occurred while processing the NetView DSIGET macro to request storage. No storage space is available.
- >60 An error occurred while processing the NetView DSIPRS macro.

Note: If you receive return codes other than 0 and 60, refer to *NetView Customization: Using Assembler* for information on resolving the NetView macro problems.

Error messages returned by AOCMSG are:

AOF262E MESSAGE ID mid INVALID, MUST BE "NNN", "ABCNNN", OR "ABCDNNN".

AOF263I MESSAGE ID NUMERIC "nnn" IS NOT NUMERIC.

AOF264I TOO FEW PARAMETERS ON AOCMSG COMMAND, 2 IS MINIMUM.

abc000I USER MESSAGE mid ISSUED BUT DOES NOT EXIST IN MESSAGE TABLE
DSIabcnn - CALL IGNORED.

Note: In message *abc000I*, the *abc* represents the product identifier portion of the message ID.

Usage

- Parameter values passed to AOCMSG depend on the format of the message entry as coded in the DSIMSG member *DSIxxxxnn*.
- AOCMSG uses NetView message handling facilities, DSIMDS and DSIMBS in particular. Refer to *NetView Customization* for details on using DSIMDS for creating your own messages.
- AOCMSG implements the SA z/OS notification message function to allow you to forward messages to notification operators. This aspect of AOCMSG processing can be useful if you develop new messages and want notification operators to receive them.

The notification message function is implemented by assigning message classes to your messages. Message classes are assigned within the text of the messages in the DSIMSG member (DSI $xxxxm$). In the text for the message, specify the class or classes (up to five) after the message ID number and before the message text. For example, the following entry for a message assigns message classes 10 and 40 to the message. The message will be issued as a notification message to any notification operators defined to receive class 10 or 40 messages.

```
123I 10 40 THE EAGLE HAS &1
```

Examples

Example 1

Entries for messages in DSIMSG member DSIABC12 are as follows:

```
*****
120I ...
121I ...
122I &1 &2 ON THE &3
123I 10 40 THE EAGLE HAS &1
124I ...
*****
```

An automation procedure contains the following AOCMSG calls referencing messages ABC122 and ABC123.

```
<other automation procedure code>
:
AOCMSG HELP,ABC122,,IS,WAY
AOCMSG LANDED,ABC123
:
<other automation procedure code>
```

When AOCMSG is called as specified in the automation procedure, DSIMSG member DSIABC12 is searched for messages ABC122I and ABC123I. Variable substitution for the variables in the message entries occurs, resulting in the following messages being generated:

```
ABC122I HELP IS ON THE WAY
ABC123I THE EAGLE HAS LANDED
```

Note: Because the DSIMSG member entry for ABC122I does not specify message class information, only the issuer of the automation procedure receives the message, not any notification operators. Because the DSIMSG member entry for message ABC123I specifies message classes 10 and 40, notification operators defined to receive message classes 10 and 40 also receive message ABC123I.

Example 2

Use of the AOCMSG *request_code* parameter value NOMID has the following effect on the messages generated.

The same entries in DSIMSG member DSIABC12 are used.

The AOCMSG calls using the NOMID *request_code* parameter value are as follows:

AOCMSG

```
<other automation procedure code>
:
AOCMSG HELP,ABC122,NOMID,IS,WAY
AOCMSG LANDED,ABC123,NOMID
:
<other automation procedure code>
```

These calls and the DSIABC12 entries result in the following messages:

```
HELP IS ON THE WAY
10 40 THE EAGLE HAS LANDED
```

Note: Note that in message ABC123I, the message classes 10 and 40 have not been processed as message classes and appear in the message text. No notification operators receive either message. This is an error for message ABC123. The message is not implemented to use the NOMID parameter value effectively.

Use of the AOCMSG *request_code* parameter value MIM has the following effect on the messages generated.

The same entries in DSIMSG member DSIABC12 are used.

The AOCMSG calls using the MIM request_code are as follows:

```
<other automation procedure code>
:
AOCMSG HELP,ABC122,MIM,IS,WAY
AOCMSG 'HELP 40',ABC122,MIM,IS,WAY
AOCMSG LANDED,ABC123,MIM
:
<other automation procedure code>
```

These calls and the DSIABC12 entries result in the following three messages:

HELP IS ON THE WAY

The text HELP is considered to be the new message ID. Because no message classes are in the AOCMSG call, no notification operators receive the message.

HELP IS ON THE WAY

In this case, the value 40 is processed as a message class. This processing causes notification operators defined to receive class 40 messages to also receive this message.

10 THE EAGLE HAS LANDED

The value 40 is processed as a message class, as in previous AOCMSG examples. In contrast, the value 10 is processed as the message ID, not a message class. Message ABC123 is not implemented to effectively use the MIM parameter value.

AOCQRES

Purpose

The AOCQRES routine examines and returns information about where a resource resides in a sysplex. Optionally, AOCQRES also tries to obtain status information on resources.

Syntax

```

  >> AOCQRES subsystem_name [(-STATUS)]
  
```

Parameters

subsystem_name

Specifies the name of the subsystem.

- * This causes the command to return information about all subsystems within the sysplex.

STATUS

If you specify STATUS, another column will be added to the output. This column contains the current automation status of each subsystem.

Return Codes

The following return codes can occur:

- 0 The AOCQRES command completed successfully.
- 1 An error occurred while processing the AOCQRES command. See the accompanying message for the cause of the error.
- 2 The specified subsystem is either unknown or currently not registered.

Usage

The command is to be used within a NetView PIPE statement.

Examples

When you issue the command:

```
PIPE NETV AOCQRES TSO (STATUS | SEP | STEM ABC.
```

within a REXX procedure and the system where this command is issued is in a sysplex with four systems, the stem variable ABC. will be assigned something similar to the following:

```

ABC.0 = 4
ABC.1 = TSO      TSO      KEY3      UP
ABC.2 = TSO      TSO      KEY4      AUTODOWN
ABC.3 = TSO      TSO      KEY5      STARTED
ABC.4 = TSO      TSO      KEY6      RESTART
  
```

The first token of the data is the subsystem name, the second token is the subsystem's job name, the third token is the system name and the last token is the subsystem's status.

AOCQRY

Purpose

The AOCQRY routine verifies that automation is allowed for a specific resource. AOCQRY does the following:

- Searches the automation policy to verify that the resource is defined to SA z/OS.

AOCQRY

- Checks that the automation flags for that resource allow automation
- Initializes certain control variables for use by the calling automation procedure
- Drives automation flag exits
- Initializes AOCQRY TGLOBAL variables with application information

A call to AOCQRY is intended to be a standard component of most automation procedures. AOCQRY should be called whenever resource automation is required to verify whether automation should continue.

AOCQRY only works for applications that have been defined to automation using the application policy object of the customization dialogs.

Syntax

Parameters are positional.

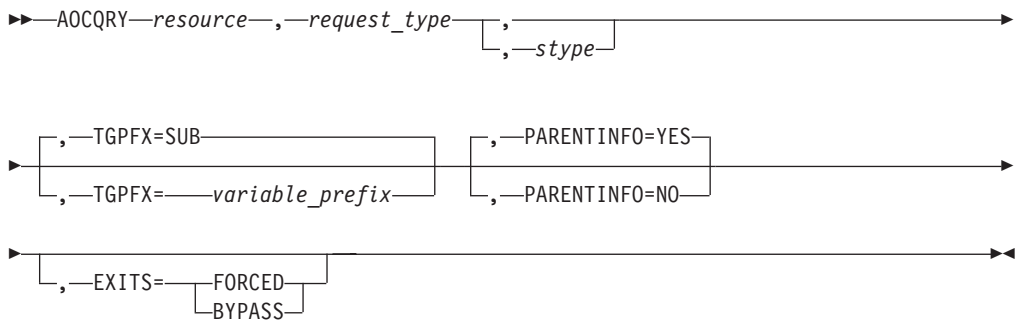

Parameters

For describing the AOCQRY command, minor resources are categorized as follows:

- Subsystem minor resources, for example, CICS®.TRAN.APPL1
- MVS component minor resources, for example, MVSESA.SMF
- SUBSYSTEM default minor resources, for example, SUBSYSTEM.APPL
- Defaults minor resources, for example, DEFAULTS.APPL

resource

The resource name for which automation should be checked. This value can be a job name, subsystem name or a minor resource name. If *resource* is none of these and *stype* is coded, the resource is assumed to be an MVS component minor resource. For example, AOCQRY SMF RECOVERY MVSESA is equivalent to AOCQRY MVSESA.SMF RECOVERY MVSESA. When checking a minor resource, the application job name can be substituted for the application name. This parameter is required.

request_type

The type of automation checks and information retrieval functions AOCQRY performs. Request type is required and must be one of the following:

Value	Description
-------	-------------

AUTOMATION	Only the Automation flag is checked to determine whether automation is allowed. Data retrieval from the automation control file and
-------------------	---

automation status file occurs as described under the CFGINFO and STATUS options. If the third parameter, *stype*, is coded, data retrieval does not occur.

INITSTART

The Automation flag and the Initstart flag are checked in determining whether automation is allowed. Data retrieval from the automation control file and automation status file occur as described under the CFGINFO and STATUS options. If the *stype* parameter is coded data retrieval does not occur.

START

The Automation flag and the Start flag are checked in determining whether automation is allowed. Data retrieval from the automation control file and automation status file occur as described under the CFGINFO and STATUS options. If the *stype* parameter is coded data retrieval does not occur.

RECOVERY

The Automation flag and the Recovery flag are checked in determining whether automation is allowed. Data retrieval from the automation control file and automation status file occur as described under the CFGINFO and STATUS options. If the *stype* parameter is coded data retrieval does not occur.

TERMINATE

The Automation flag and the Shutdown flag are checked in determining whether automation is allowed. Data retrieval from the automation control file and automation status file occur as described under the CFGINFO and STATUS options. If the *stype* parameter is coded data retrieval does not occur.

RESTART

The Automation flag and the Restart flag are checked in determining whether automation is allowed. Data retrieval from the automation control file and automation status file occur as described under the CFGINFO and STATUS options. If the *stype* parameter is coded data retrieval does not occur.

CFGINFO

Selected information for an application is retrieved from the automation control file and returned to the calling automation procedure through predefined TGLOBALs. Information is retrieved for both the application and the application parent. This parameter is mutually exclusive with the *stype* parameter. Supported TGLOBALs are documented in "TGLOBALs" on page 46.

CFGONLY or CFG-ONLY

Selected information for an application is retrieved from the automation control file and returned to the calling automation procedure through predefined TGLOBALs. Information is retrieved only for the application. Parent TGLOBAL information is not affected by this option. If the resource is a minor resource, information retrieval will be performed for the application. This parameter is mutually exclusive with the *stype* parameter. Supported TGLOBALs are documented in "TGLOBALs" on page 46.

STATUS

Selected information for an application is retrieved from the automation control file, as previously noted under the CFGINFO

option, and from the automation status file. This information is returned to the calling automation procedure through predefined TGGLOBALS. Information is retrieved for both the application and the application parent. If the resource is an application minor resource, information retrieval will be performed for the application. This parameter is mutually exclusive with the *stype* parameter. Supported TGGLOBALS are documented in “TGGLOBALS” on page 46.

STATUS-ONLY

The only data returned for an application is the status from the automation status file. It is returned to the calling automation procedure through the predefined TGGLOBAL, SUBSSTAT which is described in the section on “TGGLOBALS” on page 46. No other TGGLOBALS are set. Retrieval is only done for the application. Parent information is not affected by this option. If the resource is an application minor resource, information retrieval will be performed for the application. This parameter is mutually exclusive with the *stype* parameter.

stype

The named resource is not defined as an application in the automation control file or as an application minor resource. This parameter is mutually exclusive with the *request_type* values CFGINFO, CFG-ONLY, CFGONLY, STATUS or STATUS-ONLY. For any other *request_type*, functions performed for the CFGINFO and STATUS options are bypassed if variable *stype* is coded. Checking automation flags occurs as normally performed for the specified *request_type*.

This value is usually coded for minor resources, in which case the value is explicitly coded as the variable AOFSYSTEM. AOFSYSTEM is a CGLOBAL containing MVSESA. This value is specified using the AUTOMATION SETUP policy item of the system policy object in the customization dialogs.

TGPFX=*variable_prefix*

Specifies the variable prefix used to create the TGGLOBAL variable names used with AOCQRY.

The value of *variable_prefix* must be 3 characters long and defaults to SUB.

If you are calling AOCQRY from a routine which is driven from the automation control file you must specify TGPFX=*something_other_than_sub* or you will corrupt the task globals used by the routine that is driving your routine. This can lead to unpredictable behavior.

PARENTINFO

Specifies whether parent TGGLOBAL information is retrieved.

The following values can be specified:

YES

Parent TGGLOBAL information is retrieved. If the dependency has a sequence number, then PARENTINFO defaults to YES. Otherwise, PARENTINFO=NO applies.

Note: If the subsystem has multiple dependencies with sequence numbering, then information is obtained for the resource with sequence number one only. If information is required for all the supporting resources, then AOCQRY must be issued for each of them. A list of the supporting resources can be obtained from the SUBSPARENT TGGLOBAL.

NO

Parent TGLOBAL information is not obtained.

EXITS

This parameter determines how automation flag exits are invoked. The following values can be specified:

FORCED

When FORCED is specified, automation flag exits are invoked regardless of the automation flag setting.

BYPASS

When BYPASS is specified, regular processing will continue for the automation flag setting.

Restrictions and Limitations

This routine can only be called by another automation procedure or a command processor.

Return Codes

Return codes are:

- 0 Function completed successfully. If checking an automation flag, automation is allowed.
- 1 Global Automation flag is off.
- 2 The specific automation flag is turned off.
- 3 A valid application entry was not found in the automation control file. Not used if *stype* parameter is coded.
- 4 Incorrect parameters were used in the call.
- 5 Timeout or other error occurred.
- 6 SA z/OS initialization incomplete, unable to process command request.

Note: If AOCQRY processes with a return code of > 3, confirm the TGLOBALs returned to the calling automation procedure. TGLOBAL values may not be set as expected when return codes > 3 occur.

Usage

- AOCQRY accesses the automation control file and automation status file. It uses the application definition information and automation flag settings to determine whether automation should continue.
- Return codes 1 and 2, which specify that automation is turned off, are set when Automation flags are set to NO or are disabled for a certain time.
- Return code 3 (application not defined to automation) indicates that messages for the application should not be automated.
- The AOCQRY routine searches the automation flags in a predefined sequence to decide whether automation should continue. The first Automation flag entry defined in the automation policy governs whether automation is allowed. The search order is:
 1. The flags associated with the SUBSAPPL TGLOBAL value.
Typically, this value is the application or resource name.
 2. The flags associated with the SUBSTYPE TGLOBAL value.
Typically, this value is the SUBSYSTEM or the AOFSYSTEM CGLOBAL value.
 3. The flags associated with DEFAULT.

Refer to “TGLOBALS” for descriptions of the contents of the TGLOBAL fields in different situations.

- If the *request_type* is coded as Initstart, Start, Recovery, Terminate or Restart, a two-level search is performed. The predefined sequence previously described is searched twice, once for the Automation flag, and again for the specific automation flag. If the Automation flag turns off automation, the second search is not performed and the AOCQRY processing terminates.
- Minor Resource flags are resolved as follows:

Begin the search with the lowest qualifier of the minor resource. Do until the flag is resolved:

 1. If the effective automation flag is not resolved, check the Automation flag else proceed to 2.

If the Automation flag is not set proceed to 2.

If the Automation flag is off or a user exit is coded that evaluates to off, the effective automation flag is off. If *request_type=automation* returns 2 (specific off) and terminate search, else return 1 (global automation off) and terminate search.

If the Automation flag is on, the effective automation flag is on. If *request_type=automation* return 0 (on) and terminate search. If the effective specific flag has been resolved, return “0” (on) and terminate search, else proceed to 2.
 2. If *request_type=automation* proceed to 3.

If the effective specific flag has not been resolved, check the specific flag else proceed to 3.

If the specific flag is not set proceed to 3.

If the specific flag is off or a user exit is coded that evaluates to off then the effective specific flag is off. Return “2” (specific off) and terminate search.

If the specific flag is on, then the effective specific flag is on. If the effective automation flag has been resolved (must be on), return “0” (on) and terminate search, else proceed to 3.
 3. Start the search at the next highest qualifier.

If this search fails to resolve the flag then the predefined sequence described previously is performed.

Note: Subsystem flags will always have a value, either defined explicitly in automation policy, or inherited from defaults.

TGLOBALS

There are three main groups of AOCQRY TGLOBALS:

- Application information TGLOBALS (SUBSxxxx)
- Parent information TGLOBALS (SUBPxxxx)
- Automation flag TGLOBALS

When *stype* is not coded in the AOCQRY call, the following apply:

- All TGLOBALS are modified unless parent information is not requested or parent information is not valid.
- Any application data fields not specified in the automation policy are null values, except:
 - SUBxSHUTDLY, which defaults to 00:02:00 (2 minutes)
 - SUBxSTRTCMD, which defaults to NO
 - SUBxRSTOPT, which defaults to ABENDONLY

(The *x* value is either S or P, depending on whether the TGLOBAL is for the application or parent.)

- If an application entry is not found, the TGLOBALS are not altered from previous settings.

When *stype* is coded in the AOCQRY call and *stype* does not have a value of SUBSYSTEM, then only SUBSAPPL, SUBSTYPE and AUTOTYPE are modified. All other TGLOBALS retain their previous value.

Table 5 lists AOCQRY application TGLOBALS (SUBSxxxxx TGLOBALS).

Table 5. AOCQRY Subsystem TGLOBALS

TGLOBAL	Description								
SUBSAAAUTO	The application Automation assist mode setting (DISPLAY, LOG, or NONE).								
SUBSAAISTRT	The application Initstart assist mode setting (DISPLAY, LOG, or NONE).								
SUBSAAARCVRY	The application Recovery assist mode setting (DISPLAY, LOG, or NONE).								
SUBSAAARSTRT	The application Restart assist mode setting (DISPLAY, LOG, or NONE).								
SUBSAAASTART	The application Start assist mode setting (DISPLAY, LOG, or NONE).								
SUBSAAATRMN8	The application Shutdown (Terminate) assist mode setting (DISPLAY, LOG, or NONE).								
SUBSAFAUTO	The application Automation flag setting. This TGLOBAL value may be: <table border="0"> <thead> <tr> <th>Value</th> <th>Description</th> </tr> </thead> <tbody> <tr> <td>Y</td> <td>Yes, automation on</td> </tr> <tr> <td>N</td> <td>No, automation off</td> </tr> <tr> <td>E</td> <td>Exit, an automation flag exit is used for this flag.</td> </tr> </tbody> </table>	Value	Description	Y	Yes, automation on	N	No, automation off	E	Exit, an automation flag exit is used for this flag.
Value	Description								
Y	Yes, automation on								
N	No, automation off								
E	Exit, an automation flag exit is used for this flag.								
	These values apply to other automation flag setting TGLOBALS.								
SUBSAFISTRT	The application Initstart automation flag setting (Y, N, or E).								
SUBSAFRVCVRY	The application Recovery automation flag setting (Y, N, or E).								
SUBSAFRSTRT	The application Restart automation flag setting (Y, N, or E).								
SUBSAFSTART	The application Start automation flag setting (Y, N, or E).								
SUBSAFTRMN8	The application Shutdown (Terminate) automation flag setting (Y, N, or E).								
SUBSAPPL	The application name from the automation control file. If <i>stype</i> was coded, this TGLOBAL contains the resource name.								
SUBSASID	The address space ID of the application. This is only available when SA z/OS process monitoring is used for this resource.								
SUBSFILE	Contains the information which file this resource represents.								
SUBSCMDPFX	The application command prefix from the automation control file.								
SUBSDESC	The application description from the automation control file.								
SUBSEXTSTART	Contains the 'External Start' information.								
SUBSEXTSTOP	Contains the 'External Stop' information.								
SUBSINFOLINK	The application INFOLINK from the automation control file.								
SUBSIPOPT	The application IPL option from the automation control file.								
SUBSJOB	The application job name from the automation control file.								
SUBSJOBTYPE	The subsystem jobtype from the automation control file (MVS/NONMVS/TRANSIENT).								
SUBSMDATE	The date the last monitor cycle checked the subsystem.								
SUBSMTIME	The time the last monitor cycle checked the subsystem.								
SUBSOPER	The work operator assigned to the subsystem.								
SUBSPARENT	A list of the application parent names from the automation control file. The parent names are separated by blanks. This is only provided if dependencies with a sequence number were specified in the dialog.								
SUBSPATH	Contains the information which z/OS UNIX process this resource represents.								
SUBSPID	The ID for the USS process.								
SUBSPORT	Contains the information which TCP port this resource represents.								
SUBSPROC	Contains the subsystem's PROCNAME.								
SUBSPROCESS	Contains the current process (START, STOP, or null).								
SUBSRCYOPT	The application recycle option from the automation control file.								

AOCQRY

Table 5. AOCQRY Subsystem TGLOBALs (continued)

TGLOBAL	Description
SUBSRSTOPT	The application restart information from the automation control file.
SUBSSCHEDSS	The application scheduling subsystem from the automation control file. If not specified, it defaults to the primary scheduling subsystem.
SUBSSDATE	The date the status of the subsystem was last updated.
SUBSSESS	The subsystem name from the automation control file.
SUBSSHUTDLY	The application shutdown delay value from the automation control file.
SUBSSHUTOPT	The application shutdown option from the automation control file. This will be null if SHUTOPT=NO, or will be a list of parents if SHUTOPT=PARENT or SHUTOPT=(parent list).
SUBSSPARM	The application parameter data from the automation control file.
SUBSSTAT	The application status from the automation status file.
SUBSSTIME	The time the status of the subsystem was last updated.
SUBSSTOPTYPE	
SUBSSTRTCYC	The application start cycles from the automation control file.
SUBSSTRTDLY	The application start delay from the automation control file.
SUBSSTRTTYPE	
SUBSSUBTYPE	The subsystem type (JES2, JES3, DB2®, CICS, or IMS™).
SUBSTERMDLY	The application termination delay from the automation control file.
SUBSTRANTY	Used by transient subsystems to indicate whether or not they can be rerun.
SUBSTYPE	This TGLOBAL indicates the resource for which the automation flag checking is performed. For an application, the value for this TGLOBAL is SUBSYSTEM. For resources other than applications, the value for this TGLOBAL is the value coded for <i>stype</i> on the AOCQRY call. If an application entry was not found, the TGLOBAL value is NONE.
SUBSUSER	Contains the information which z/OS UNIX user ID this resource belongs to.
SUBSUSSJOB	The real job name of the application. This is only available when SA z/OS process monitoring is used for this resource.
SUBSWLMNAME	A list of the workload manager names from the automation control file.

Table 6 lists AOCQRY parent TGLOBALs (SUBPxxxxx TGLOBALs).

Table 6. AOCQRY Parent TGLOBALs

TGLOBAL	Description
SUBPAAAUTO	The parent Automate assist mode setting (DISPLAY, LOG, or NONE).
SUBPAAISTRT	The parent Initialize assist mode setting (DISPLAY, LOG, or NONE).
SUBPAARCVRY	The parent Recover assist mode setting (DISPLAY, LOG, or NONE).
SUBPAARSTRT	The parent Restart assist mode setting (DISPLAY, LOG, or NONE).
SUBPAASTART	The parent Start assist mode setting (DISPLAY, LOG, or NONE).
SUBPAAATRMN8	The parent Shutdown (terminate) assist mode setting (DISPLAY, LOG, or NONE).
SUBPAFAUTO	The parent Automation flag setting (Y, N, or E).
SUBPAFISTRT	The parent Initstart automation flag setting (Y, N, or E).
SUBPAFRCVRY	The parent Recovery automation flag setting (Y, N, or E).
SUBPAFRSTRT	The parent Restart automation flag setting (Y, N, or E).
SUBPAFSTART	The parent Start automation flag setting (Y, N, or E).
SUBPAFTRMN8	The parent Shutdown (Terminate) automation flag setting (Y, N, or E).
SUBPAPPL	The parent application name.
SUBPASID	The parent address space ID. This is only available when SA z/OS process monitoring is used for this resource.
SUBPCMDPFX	The parent command prefix from the automation control file.
SUBPDESC	The parent description
SUBPEXTSTART	Contains the 'External Start' information.
SUBPEXTSTOP	Contains the 'External Stop' information.
SUBPFILE	Contains the information which file the parent represents.
SUBPINFOLINK	The parent INFOLINK from the automation control file.

Table 6. AOCQRY Parent TGLOBALs (continued)

TGLOBAL	Description
SUBPIPLOPT	The parent IPL option from the automation control file.
SUBPJOB	The parent job name.
SUBPJOBTYPE	The parent subsystem jobtype from the automation control file (MVS/NONMVS/TRANSIENT).
SUBPMDATE	The date the last monitor cycle checked the parent subsystem.
SUBPMTIME	The time the last monitor cycle checked the parent subsystem.
SUBPOPER	The work operator assigned to the parent.
SUBPPARENT	A list of the parent names from the automation control file. The parent names are separated by blanks. This is only provided if dependencies with a sequence number were specified in the dialog.
SUBPPATH	Contains the information which z/OS UNIX process the parent represents.
SUBPPID	The ID for the USS process of the parent.
SUBPPORT	Contains the information which TCP port the parent represents.
SUBPRCYCOPT	The parent subsystem recycle option from the automation control file.
SUBPPROC	Contains the subsystem's PROCNAME.
SUBPPROCESS	Contains the current process (START, STOP, or null).
SUBPRSTOPT	The parent restart information
SUBPSCHEDSS	The scheduling subsystem for the parent, from the automation control file. If not specified, it defaults to the primary scheduling parent.
SUBPSDATE	The date the status of the parent system was last updated.
SUBPSESS	The parent subsystem name from the automation control file.
SUBPSHUTDLY	The parent shutdown delay value
SUBPSHUTOPT	The application shutdown option from the automation control file. This will be null if SHUTOPT=NO, or will be a list of parents if SHUTOPT=PARENT or SHUTOPT=(parent list).
SUBPSPARM	The parent parameter data
SUBPSTAT	The parent status
SUBPSTIME	The time the status of the parent system was last updated.
SUBPSTOPTYE	
SUBPSTRTCYC	The parent start cycles from the automation control file.
SUBPSTRTDLY	The parent start delay from the automation control file.
SUBPSTRITYPE	
SUBPSUBTYPE	The subsystem type of the parent subsystem.
SUBPTERMMDLY	The parent termination delay from the automation control file.
SUBPTRANTY	If the parent subsystem is a transient, this indicates whether or not it can be rerun.
SUBPTYPE	This TGLOBAL indicates the resource for which the automation flag checking is performed. For an application, the value for this TGLOBAL is SUBSYSTEM. For resources other than applications, the value for this TGLOBAL is the value coded for <i>stype</i> on the AOCQRY call. If an application entry was not found, the TGLOBAL value is NONE.
SUBPUSER	Contains the information which z/OS UNIX user ID the parent belongs to.
SUBPUSSJOB	The real parent job name. This is only available when SA z/OS process monitoring is used for this resource.
SUBPWLMNAME	A list of the workload manager names from the automation control file.

Note: The SUBP variables are only available if dependencies with a sequence number were specified in the customization dialog.

Table 7 on page 50 lists AOCQRY automation flag TGLOBALs.

AOCQRY

Table 7. AOCQRY Automation Flag TGLOBALs

TGLOBAL	Description						
AUTOTYPE	The AUTOTYPE TGLOBAL contains the value of the automation mode that is turned off. Depending on certain conditions, AUTOTYPE has the following values: <table border="1"><thead><tr><th>Value</th><th>Condition</th></tr></thead><tbody><tr><td>Null</td><td>Automation is allowed.</td></tr><tr><td>Null</td><td><i>request_type</i> does not check automation flags.</td></tr></tbody></table>	Value	Condition	Null	Automation is allowed.	Null	<i>request_type</i> does not check automation flags.
Value	Condition						
Null	Automation is allowed.						
Null	<i>request_type</i> does not check automation flags.						
GLOBAL	The Automation (global) automation flag is off.						
INITSTART	Initstart automation flag is off.						
RECOVERY	Recovery automation flag is off.						
RESTART	Restart automation flag is off.						
START	Start automation flag is off.						
TERMINATE	Shutdown automation flag is off.						
ASSIST	The Assist Mode setting for the automation flag.						
EHKEXITRSN	The return code from the exit if a nonzero return code.						
EHKEXITNME	The name of the exit supplying the nonzero return code.						

```

AOFK3D0X          SA z/OS - Command Response          Line 1 of 13
Domain ID = IPSNO  ----- DISPACF -----           Date = 07/19/00
Operator ID = ROLI                                     Time = 17:43:05

Command = ACF ENTRY=SUBSYSTEM,TYPE=CICST,REQ=DISP
SYSTEM = KEY3     AUTOMATION CONFIGURATION DISPLAY - ENTRY= SUBSYSTEM
-----
AUTOMATION CONFIGURATION DISPLAY - ENTRY= SUBSYSTEM
TYPE IS CICST
JOBTYPE          = MVS
RESTARTOPT       = ALWAYS
TERMDLY          = 00:00:12
EXTSTART         = NEVER
IPLOPTIONS       = NOSTART
JOB              = CICST
PARENT           = (VTAM)
SDESC            = 'TEST-CICS'
SHUTDLY          = 00:02:00
STRTDLY          = 00:03:00
END OF MULTI-LINE MESSAGE GROUP

Command ==>
PF1=Help      PF2=End      PF3=Return      PF6=Ro11
                PF9=Refresh PF12=Retrieve

```

Figure 3. DISPACF Sample Panel

The automation procedure to call AOCQRY is:

```

/* REXX CLIST to check if termination automation is allowed for VTAM */
'AOCQRY CICST,TERMINATE'
Select
  When rc = 0 Then Do /* Automation on; perform actions req'd. */
    :
  End
  When rc = 1 | rc = 2 Then Do /* Automation off; If applicable log a
    message indicating unable to take
    action for message. */
    :
  End
  When rc = 3 Then Exit /* Subsystem not automated */
  Otherwise Do /* Error; log error message */
    :
  End
End
Exit

```

The subsystem CICST has a HasParent relationship to VTAM. AOCQRY accesses both subsystem definitions to fill in the AOCQRY TGLOBALs. All the SUBSxxxx TGLOBALs are filled in with the CICST subsystem information, and the SUBPxxxx TGLOBALs are filled in with the VTAM information. The automation status file is accessed for the CICST and VTAM subsystems to fill in the SUBxSTAT field.

Following are processing steps the example automation procedure performs:

1. The automation procedure calls AOCQRY, supplying the subsystem name and TERMINATE as the *request_type*. AOCQRY gets the appropriate subsystem information, and then searches for the automation flags.
2. Upon return from AOCQRY, the automation procedure determines what the return code was, then takes the appropriate action.

Example 2

This example uses the same scenario as in Example 1, but shows how to improve the coding technique. The message to automate is produced by the CICST subsystem during shutdown. The particular message identifier is not important for this example. The automation procedure verifies automation is allowed by calling AOCQRY.

The automation procedure to call AOCQRY is:

```
/* REXX CLIST to check if termination automation is allowed for a job
- generic check dependant on Jobname */
'AOCQRY 'Jobname()',TERMINATE'
Select
  When rc = 0 Then Do /* Automation on; perform actions req'd. */
  :
  End
  When rc = 1 | rc = 2 Then Do /* Automation off; If applicable log a
  message indicating unable to take
  action for message. */
  :
  End
  When rc = 3 Then Exit /* Subsystem not automated */
  Otherwise Do /* Error; log error message */
  :
  End
End
Exit
```

This example differs from Example 1 in the following way:

AOCQRY uses NetView REXX function Jobname() for the *resource* field. This function returns the name of the job issuing the message. Using a function, the automation procedure can be written to support a specific message for any job that can issue that message. This allows portability of the automation procedure to different systems without requiring changes to the automation procedure. The job name is supplied only to an automation procedure called from the NetView automation table. If your automation procedure issues WAIT commands, you must issue the Jobname() function upon entry, because the value returned resets whenever the WAIT command is issued.

Example 3

This example differs from Examples 1 and 2 by automating an MVS component. The message to automate is produced by MVS indicating that an SMF dump data set is full. The particular message identifier is not important for this example. The automation procedure verifies that automation is allowed by calling AOCQRY.

Automation policy information for this example is the same as for Examples 1 and 2.

The automation procedure to call AOCQRY is:

```
/* REXX CLIST to check if recovery automation is allowed for SMF */
'GLOBALV GETC AOFSYSTEM'
'AOCQRY SMFDUMP,RECOVERY,'aofsystem'
Select
  When rc = 0 Then Do /* Automation on; perform actions req'd. */
  :
  End
  When rc = 1 | rc = 2 Then Do /* Automation off; If applicable log a
  message indicating unable to take
  action for message. */
  :
  End
  :
End
```

AOCQRY

```

End
Otherwise Do          /* Error; log error message          */
:
End
End
Exit

```

This example differs from the previous examples in the following ways:

- When automating an MVS component, use a generic component as the *resource* name when calling AOCQRY. Using the message identifier is possible but not recommended, because several messages may relate to a single MVS component to be automated.
- The third parameter, *stype*, is coded. Coding *stype* tells AOCQRY to skip the process of finding subsystem entries. The example uses SA z/OS variable AOFSYSTEM as the *stype* parameter. The value of the variable is MVSESA.
- Return code 3 is not valid, because the application entries in the automation control file are not checked.

All other coding notes in Examples 1 and 2 pertain to calling AOCQRY for an MVS component.

Example 4

This example shows the type of information retrieved by AOCQRY for minor resources given the flag settings of Example 1 on the SA z/OS DISPFLGS panel:

Actual Resource	Effective											
	A	I	S	R	D	RS	A	I	S	R	D	RS
DEFAULTS	Y	-	-	-	-	-	Y	Y	Y	Y	Y	Y
MVSESA	-	-	-	-	-	-	Y	Y	Y	Y	Y	Y
DUMP	N	-	-	-	-	-	N	N	N	N	N	N
LOGREC	Y	-	-	-	-	-	Y	Y	Y	Y	Y	Y
SMFDUMP	-	-	-	N	-	-	Y	Y	Y	N	Y	Y
SUBSYSTEM	Y	-	-	-	-	-	Y	Y	Y	Y	Y	Y
TSO	Y	-	-	-	-	-	Y	Y	Y	Y	Y	Y
TRAN1	N	-	-	Y	-	-	N	N	N	N	N	N
ABC	Y	N	-	-	-	-	Y	N	Y	Y	Y	Y

These AOCQRY commands yield the following return codes and information:

AOCQRY Command	RC	Information Retrieved (see Key)
AOCQRY PIMS.DFS554A.TRANS1 AUTOMATION	2	ACF/ASF for PIMS,AF
AOCQRY PIMS.DFS554A.TRANS2 RECOVERY	0	ACF/ASF for PIMS,AF
AOCQRY PIMS.DFS554A.TRANS3 RECOVERY	1	ACF/ASF for PIMS,AF
AOCQRY PIMS CFGINFO	0	ACF for PIMS
AOCQRY IMS123 STATUS where IMS123 is the job name of PIMS	0	ACF/ASF for PIMS
AOCQRY SMFDUMP RECOVERY MVSESA	2	SUBSAPPL/TYPE,AF
AOCQRY MVSESA.SMFDUMP RECOVERY MVSESA	1	SUBSAPPL/TYPE,AF
AOCQRY MVSESA.SMFDUMP RECOVERY	3	

Key:

ACF Automation control file TGLOBALs
ASF Automation status file TGLOBALs
AF Automation flag TGLOBALs

AOCUPDT

Purpose

AOCUPDT performs several status update functions, including:

- Updating subsystem status.
- Identifying any messages associated with the subsystem status change and processing options performed for these messages:
 - Whether a message is issued and logged in the NetView log
 - Which message is issued
 - Whether the message is sent as a notification message to notification operators on a local system (distinct from forwarding to a focal-point system)
 - Whether the message is forwarded to a focal-point system

AOCUPDT calls common routine AOCMSG to handle processing of log and notification messages.

- Updating SDF status displays with the resource status change.
- Updating the automation manager OBSERVED status.

Syntax

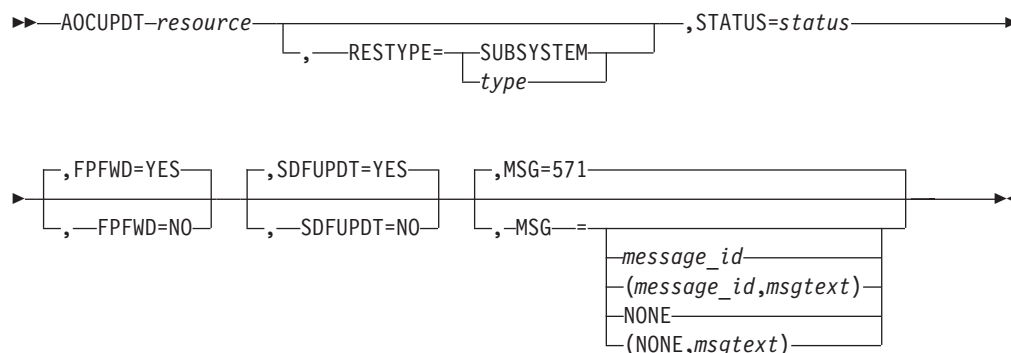

Parameters

resource

The name of the resource for which status or information updates specified by other AOCUPDT parameters are performed. This value is required and must be specified first on an AOCUPDT call. You can use the following formats for *resource*. Use the *inresource* variable to specify a resource on which the resource is dependent; that is, the parent resource.

Format	Example
<i>system_name.resource/inresource</i>	PROD.TSO/VTAM
<i>resource/inresource</i>	TSO/VTAM
<i>system_name.resource</i>	PROD.TSO
<i>resource</i>	TSO

The *system_name* variable defaults to AOFSSYSNAME. The *inresource* variable defaults to the RESTYPE value. The specification or default to a value of SUBSYSTEM for *inresource* will result in a value of SUBSYS being used.

RESTYPE

Identifies the type of resource for the *resource* parameter. You can specify a resource type of your own choice, with the exception of SYSTEM which is reserved for internal use only. The default is SUBSYSTEM.

type

A resource type of your own choice

SUBSYSTEM

A resource type of SUBSYSTEM

STATUS

Specifies the new resource status value.

When you use this parameter to change status, some other AOCUPDT parameters perform default actions, unless otherwise coded. These parameters include:

MSG

FPFWD

SDFUPDT

If you specify STATUS to change status, but do not specify any of the parameters listed above (thereby using parameter defaults), the following occurs:

- SA z/OS issues message AOF571I, *resource_name* SUBSYSTEM STATUS FOR JOB *jobname* IS *status—text* and also logs the message in the NetView log.
- Message AOF571I is forwarded to a focal point system, if one exists in your configuration.
- The specified status change is reflected in SDF status panels.

To change the values or actions performed by the MSG, FPFWD, and SDFUPDT parameters, or to preclude their use, you must specify those parameters and desired values.

If a status value which has a length greater than eight characters is used, the status value is truncated to a length of eight characters.

FPFWD

Determines whether the specified status is sent from a local system (the system on which AOCUPDT is issued) to a focal-point system.

YES

The status is sent. This is the default.

NO

The status is not sent.

Note: For status forwarding to a focal-point system to occur, you must already have configured an automation network and defined the automation network to SA z/OS. Refer to *System Automation for z/OS User's Guide* for details.

SDFUPDT

Determines whether the specified status change is also reflected in SDF status displays.

YES

The status change is reflected in SDF status displays. This is the default if STATUS is specified.

NO

The status change is not reflected in SDF status displays. This is the default if STATUS is not specified.

MSG

This parameter identifies the message associated with the status change specified on the STATUS parameter. This message is issued to note when the status change occurs. This parameter is applicable only if the STATUS parameter is also specified.

The default is 571, the message ID for SA z/OS status change message AOF571I, *resource_name* SUBSYSTEM STATUS FOR JOB *jobname* IS *status*—*text*.

This parameter value can be specified using the following formats:

message_id

Identifies the numeric part of a message ID. For example, 571 specifies SA z/OS message AOF571I.

(*message_id*)

The complete message ID, including message prefix and message number, enclosed in parentheses, for example, (AOF123).

(*message_id,msgtext*)

The complete message ID, including message prefix and message number, plus message text to be substituted for message variables in the message text. This entire specification is enclosed in parentheses, for example, (123,AA,BB,CC). Quotation marks are not allowed in the message text.

The AOCMSG common routine substitutes the message text values into message variables &1 through &9 in the fixed message text located in the NetView message library. See “AOCMSG” on page 35 for details on how that common routine works. Some message variables are preset to certain values depending on the message ID and message text specified on the AOCUPDT call. Following are details on how the message variables are preset.

- Variable &1 is always set to AOFRUPDT, which is the name of the automation procedure in which the AOCUPDT command processor resides.
- If the message text is omitted, the following message variables are preset:

Var	Setting
&1	AOFRUPDT
&2	Time
&3	<i>system_name.resource</i>
&4	Resource type
&5	Subsystem name
&6	Subsystem job name
&7	Status

- If the message text is provided and the *message_id* number is 571, the following message variables are preset:

Var	Setting
&1	AOFRUPDT
&2	Time
&3	<i>system_name.resource</i>
&4	Resource type
&5	Subsystem name
&6	Subsystem job name

&7 Status

Variables &8 and &9 can be assigned values from the *msgtext* portion of this parameter.

- If the message text is provided and the *message_id* number is not 571, the following message variables are preset:

Var	Setting
&1	AOFRUPDT
&2	Time
&3	<i>system_name.resource</i>
&4	Resource type

Variables &5 through &9 can be assigned values from the *msgtext* portion of this parameter.

NONE

The operator is not notified that the update has taken place. The text string "RESOURCE *resource_name* STATUS UPDATED TO *status_value*" is written to SDF.

(NONE,*msgtext*)

The operator is not notified that the update has taken place. The text string "*msgtext*" is written to SDF.

Restrictions and Limitations

AOCUPDT has the following restrictions and limitations:

- Use AOCUPDT instead of ASF to perform dynamic status updates to SA z/OS status files.
- AOCUPDT should only be issued from an automation procedure.
- Parentheses appearing within message text must be properly paired and balanced.
- Using AOCUPDT to change a resource status *only* changes the status. It does not initiate any associated status change processing that occurs if the status change is processed through a generic routine such as ACTIVMSG or TERMMSG. Also, the automation status remains unchanged. For example, if the resource is involved in a STARTUP, and the resource's status is changed to UP via AOCUPDT, then this process will not be affected because the automation status will not be changed to IDLE.

Return Codes

Return codes are:

- | | |
|----|---|
| 0 | AOCUPDT processed normally. |
| 4 | All requested actions were performed. However, the system detected that some of the data to be changed was the same as the modified data specified on the AOCUPDT call. |
| 8 | Incorrect keyword specifications were detected and ignored. All other keywords processed normally. |
| 12 | No function keyword was specified on the AOCUPDT call. A resource was identified, but no action to perform on the resource was specified. |
| 16 | The specified <i>resource</i> was not found, when the specified resource type (RESTYPE value) is SUBSYSTEM and the system name is the system on which AOCUPDT is running. |
| 20 | The <i>resource</i> name length was longer than allowed. When the specified RESTYPE value is SUBSYSTEM, the resource name cannot be longer than 11 characters. |
| 99 | A timeout or another error occurred. |

Usage

- Use this command instead of ASF to update SA z/OS status information.
- When you use AOCUPDT to change resource status, the status change message is sent to notification operators defined to receive the message. Notification of a status change occurs whether automation flags for the resource are enabled or disabled (set to Yes or No). To suppress sending a message when a status change occurs, specify MSG=NONE along with the STATUS parameter.

Examples

Example 1

This example shows how to use AOCUPDT to change the status of the TSO subsystem to UP.

```
AOCUPDT TSO,STATUS=UP
```

Note: This will not cause any TSO UP commands to be issued.

Example 2

This example shows how to use AOCUPDT to:

- Change the status of subsystem IMSPROD to DOWN
- Issue a customer-defined message, ABC123
- Ensure that the status change is *not* reflected in SDF

```
AOCUPDT IMSPROD,STATUS=DOWN,MSG=ABC123,SDFUPDT=NO
```

Note: You should not change the status in this way if IMSPRODU is running.

AOFEXCMD

Purpose

AOFEXCMD is used to execute a command on a specified autotask. If the autotask is not active, AOFEXCMD will try to execute the command on a backup autotask. This process is repeated until the command is successfully scheduled for execution, or the list of available backup autotasks is exhausted.

AOFEXCMD will attempt to execute the command on the following autotasks:

1. The primary autotask for *AUTOFUNC*
2. The secondary autotask for *AUTOFUNC*
3. The primary autotask for *SYSOPER*
4. The secondary autotask for *SYSOPER*
5. The primary autotask for *BASEOPER*
6. The primary autotask for *AUTO1*

If it cannot execute on any of these autotasks, an AOF572I message is issued.

SA z/OS automation will attempt to restart any inactive autotasks called by AOFEXCMD.

Syntax

```
▶▶—AOFEXCMD—autofunc—,—command—▶▶
```

Parameters

autofunc

The automated function under which the autotask name is defined. Automated functions are established in the customization dialogs, and are assigned at SA z/OS initialization.

If the automated function name is not supplied the procedure will attempt to issue the command on one of the backup automated functions (sysoper, baseoper or auto1.)

Note: If the automated function name is not supplied, a comma must be used as a placeholder for parsing so that the command is identifiable as the second operand.

command

The command which is to be scheduled to run on the autotask associated with the automated function.

Restrictions and Limitations

Do not define an operator ending with the character string #\$.

Issuing operators must be scope authorized to issue the command using EXCMD.

Messages

The following message is issued by AOFEXCMD when it has failed to execute on any of the available autotasks. This may occur if AOFEXCMD is issued before SA z/OS initialization is complete.

```
AOF572I CGLOBALS NOT INITIALIZED FOR AUTOMATED FUNCTION autofunc -
UNABLE TO ROUTE COMMAND command, operand_1, operand_2, operand_3
```

Examples

The following command schedules a message to be sent from autotask AUTNET1 to operator OPER1. In this example, AUTNET1 is defined under the automated function NETOPER.

```
AOFEXCMD NETOPER,MSG OPER1 Logoff in 5 mins
```

AOFTREE

Purpose

The AOFTREE routine is used to extract information about an application and its dependent applications. The information returned for each application in the parent child hierarchy is:

- Name
- Job name
- Type of the resource (can be application group or subsystem)
- Position in the tree

The relationship of an application to its dependent applications can be illustrated using a tree structure as in Figure 4 on page 61.

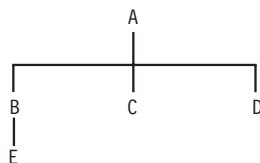
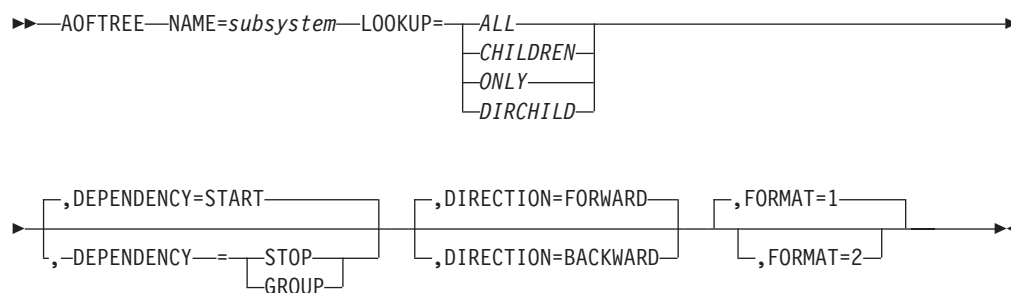

Figure 4. Subsystem Dependent Tree.

Where:

- A, B, C, D, and E are all applications.
- A is the root of the tree. All applications below A are its dependants.
- B, C, and D are direct children of A, that is, dependent on A.
- B, C, D, and E are all dependants of A.
- A is the parent of B, C, and D. B is the parent of E.
- A is on level 1, B, C, and D are on level 2, and E is on level 3.
- E, C, and D have a position in the tree referred to as 'LOWEST'. A and B have a position in the tree referred to as 'UPPER'.

Syntax



Parameters

NAME=

subsystem

The name of the application for which you wish to extract dependent applications.

LOOKUP=

The scope of the tree to be returned. The following values can be specified for lookup:

ALL

Returns details on the application and all its children.

CHILDREN

Returns details on all the children of the application.

ONLY

Returns details on the application only.

DIRCHILD

Returns details on the application and its direct children.

DEPENDENCY

Specifies the type of dependency (as defined in the policy database) for which the parent-child data should be returned. The following options are available:

AOFTREE

START

Returns all resources that are a “parent” of the specified resource or that the resource has a start dependency on. This is the default.

STOP

Returns all resources that are a “child” of the specified resource or that the resource has a stop dependency on.

GROUP

Returns all members that the specified resource consists of.

DIRECTION

Specifies the direction for returning the tree data. The following options are available:

FORWARD

Means progressing from the top level of the tree towards the bottom. This is the default.

BACKWARD

Means progressing from the bottom of the tree towards the top.

FORMAT

Specifies the output format in which the information is returned. The following options are available:

- 1 The data is returned in NetView task globals (AOFPCCHILD.n). This is the default.
- 2 The data is returned in a multiline message.

Restrictions and Limitations

This command can only be issued for a local system.

Return Codes

Return codes are:

- | | |
|---|---|
| 0 | The command successfully executed. The results are in the TGLOBAL array AOFPCCHILD. |
| 1 | An invalid application name was used. |
| 4 | Invalid parameters were used. |
| 5 | Timeout or another error occurred. |

Usage

When control is returned to the calling automation procedure, if the return code is not zero the AOFPCCHILD array is set to null.

Note: The AOFPCCHILD array is NOT sorted in hierarchical order.

If you use the AOFTREE command within a PIPE and no parameters are passed, the contents of the default safe is taken and treated as input parameters. The output format is set to 2 (FORMAT=2).

TGLOBALs

Name	Description
------	-------------

AOFPCCHILD.0	
--------------	--

	The number of elements in the array.
--	--------------------------------------

AOFPCHILD.n

The nth element in the AOFPCHILD array. This element contains the following details for a subsystem, separated by blanks:

- Name
- Job name
- Position in the tree

Examples

The following results are obtained when calling AOFTREE with the following parameters, and the relationships between A, B, C, D, and E are as described in Figure 4 on page 61.

AOFTREE NAME=A,LOOKUP=ALL

```
AOFPCHILD.0      = 5
AOFPCHILD.1      = E Ejobname 0 LOWEST
AOFPCHILD.2      = B Bjobname 0 UPPER
AOFPCHILD.3      = C Cjobname 0 LOWEST
AOFPCHILD.4      = D Djobname 0 LOWEST
AOFPCHILD.5      = A Ajobname 0 UPPER
```

AOFTREE NAME=A,LOOKUP=ONLY

```
AOFPCHILD.0      = 1
AOFPCHILD.1      = A Ajobname 0 LOWEST
```

AOFTREE NAME=A,LOOKUP=DIRCHILD

```
AOFPCHILD.0      = 4
AOFPCHILD.1      = A Ajobname 0 UPPER
AOFPCHILD.2      = B Bjobname 0 UPPER
AOFPCHILD.3      = C Cjobname 0 LOWEST
AOFPCHILD.4      = D Djobname 0 LOWEST
```

AOFTREE NAME=B,LOOKUP=ALL

```
AOFPCHILD.0      = 2
AOFPCHILD.1      = E Ejobname 0 LOWEST
AOFPCHILD.2      = B Bjobname 0 UPPER
```

If you issue:

```
'PIPE NETVIEW AOFTREE NAME=TSPARENT,LOOKUP=ALL,FORMAT=2,DEPENDENCY=START',
'| STEM treedata.'
```

the contents of the treedata stem will look similar to the following:

```
TSPARENT/APL/AOC9  TSPARENT APL UPPER
STD005AA00/APL/AOC9 T005AA00 APL LOWEST
STD004AA00/APL/AOC9 T004AA00 APL LOWEST
STD003AA00/APL/AOC9 T003AA00 APL LOWEST
STD002AA00/APL/AOC9 T002AA00 APL LOWEST
STD002AA01/APL/AOC9 T002AA01 APL UPPER
STD001AA00/APL/AOC9 T001AA00 APL LOWEST
```

If you issue:

```
'PIPE NETV AOFTREE NAME=STD000AN10,LOOKUP=ALL,FORMAT=2,DEPENDENCY=START',
'|STEM treedata.'
```

the contents of the treedata stem will look similar to the following:

To delete a single automation status file entry use the following syntax:

```
▶▶—ASF—REQ=DEL—,ID=resource—▶▶
```

To replace an automation status file entry use the following syntax:

```
▶▶—ASF—REQ=REPL—ID,resource—▶▶
    [,—DATE=error_date—,—TIME=error_time]
▶▶
    [,—JOBNAME=jobname] [,—JOBNO=job_number] [,—JOBTYPE=jobtype]
▶▶
    [,—MONITOR=monitored_time] [,—NOTIFY=N
    [—Y—]]
▶▶
    [,—OPID=operator_ID—,—STATUS=status] [,—REPLYID=replyid]
▶▶
    [,—THRSHLD=CRIT
    [—FREQ]
    [—INFR]] [,—TYPE=resource_type]
▶▶▶▶
```

Parameters

REQ

The type of request for automation status file information the ASF command performs. This value may be one of the following:

Value Description

- | | |
|-------------|---|
| DISP | Displays information in the automation status file. This value is the default if the REQ parameter is not coded. |
| DEL | Deletes information in the automation status file. This value must be coded when using ASF to delete automation status file information. If you use REQ=DEL, any other parameters specified besides ID are ignored. |
| REPL | Replaces or adds information in the automation status file. This value must be coded when using ASF to replace automation status file information. REPL adds a record to the automation status file if that entry does not already exist in the automation status file. |

ID The resource ID that is the key to the automation status file record. This ID is the application name for application records. This value can be from 1 through 16 characters long.

FROM

The resource ID that is the starting key when displaying multiple automation status file records. This resource is the application name for application records. This value can be from 1 through 16 characters long.

TO

The resource ID that is the ending key when displaying multiple automation status file records. If not specified, the value defaults to the FROM parameter value. This resource is the application name for application records. This value can be from 1 through 16 characters long.

DATE

The date of this error time stamp being recorded, in *mm/dd/yy* format. Use this value for threshold purposes. The DATE and TIME parameters are mutually inclusive. If you specify DATE, also specify TIME.

JOBNAME

The job name to which the status update applies. This value can be from 1 through 8 characters long.

JOBNO

The MVS-supplied job number for the currently active task. routines do not use this parameter.

JOBTYPE

The type of job, whether TSO user, STC, or JOB. Retain this value for job number checking.

MONITOR

The time a monitor or status change command is issued, in *hh:mm* format (00:00 through 23:59).

NOTIFY

Specifies whether a notification message is sent to the operator for a specified condition.

N A notification message is not sent.

Y A notification message is sent.

OPID

The NetView operator ID that requested or is performing the status update. If not supplied, the ASF command uses the current operator ID. This parameter is applicable only when you use the STATUS parameter. *operator_id* can be from 1 through 8 characters long.

REPLYid

The outstanding reply identifier for a subsystem. Use this value for retaining reply identifiers for applications that maintain an outstanding reply, such as NetView message DSI802I.

Note: When dealing with applications that have multiple replies this field will contain the number of the last reply issued. This is not necessarily the message that SA z/OS will reply to if AOCREP is invoked.

STATUS

The resource status. This value can be from 1 through 8 characters long, and can be any valid status value. Refer to *System Automation for z/OS Customizing and Programming* for more information on resource statuses and their use.

When REQ=REPL, and the entry to be added or replaced does not exist, this parameter defaults to a value of DOWN.

THRSHLD

The threshold that is exceeded. Use this value to allow the operator to monitor thresholds. Threshold can be one of the following:

CRIT

FREQ

INFR

TIME

The time of this error time stamp being recorded, in HH:MM format. Use this

value for threshold purposes. The DATE and TIME parameters are mutually inclusive. If you specify DATE, also specify TIME.

TYPE

The resource type for display and summary purposes. This value is SUBSYSTEM for all application records. Other values can be defined, if desired. This value can be from 1 through 10 characters long.

Restrictions and Limitations

ASF functions both as an operator command and as an API to the automation status file. Limit its use as an operator command by scope-checking.

An ASF command to replace or update automation status file entries is limited to 240 characters.

The ASF command is not pipeable.

Usage

- If an automation procedure performs a replace or update function, only those fields that need replacing must be specified. No change occurs to other automation status file fields.
- To modify automation status file fields reserved for your data, use the ASFUSER command. See "ASFUSER" on page 68 for details.

Messages

The following messages are issued during successful operation of the ASF command.

For delete and replace requests:

```
AOF001I REQUEST "request" WAS SUCCESSFUL FOR "resource"
```

For display requests, the following messages are issued. These messages use JES2 as an example status record for which status information is displayed. Message variables are filled in with JES2 information.

```
AOF150I STATISTICS DISPLAY REQUESTED FOR JES
AOF151I id= JES          , TYPE= SUBSYSTEM  , STATUS= UP
AOF152I LAST UPDATE BY OPERATOR AUTJES
AOF163I LAST THRESHOLD EXCEEDED -
AOF164I REPLYid= 0000 , JOB TYPE= tttt , NUMBER= nnnn, NAME= nnnnnnnn
AOF155I OPERATOR NOTIFIED: Y
AOF156I LAST STATUS CHANGE DATE= 05/16/97 , TIME= 13:41, OPER=AUTJES
AOF157I LAST MONITORED DATE= 05/16/97 , TIME= 13:41
AOF160I  ERROR COUNT   DATE      TIME
AOF161I           01   05/16/97   13:35
AOF161I           02   05/16/97   13:40
AOF002I END OF MULTILINE MESSAGE
```

Note: For display requests, if error time stamp information does not exist, messages AOF160I and AOF161I may be replaced with message AOF159I, NO ERROR DATA AVAILABLE.

The following messages are issued if the entry was not found.

For display requests:

```
AOF041I UNABLE TO FIND RECORD identifier
```

ASF

Note: An ASF replace request adds an entry if one does not exist, so a successful message would result. For an ASF delete request, if ASF cannot find the identifier, it also issues a successful message.

Any messages beginning with AOF0 other than those previously documented should be considered an error situation. For a description of all AOF0 messages and their associated actions refer to *System Automation for z/OS Messages and Codes*.

Examples

This example shows a command to display the status record for JES2.

The ASF command to display the status record is:

```
ASF REQ=DISP,id=JES
```

The response is:

```
AOF150I STATISTICS DISPLAY REQUESTED FOR JES
AOF151I id= JES          , TYPE= SUBSYSTEM   , STATUS= UP
AOF152I LAST UPDATE BY OPERATOR AUTJES
AOF163I LAST THRESHOLD EXCEEDED -
AOF164I REPLYid= 03 , JOB TYPE= **** , NUMBER= nnnn, NAME= nnnnnnnn
AOF155I OPERATOR NOTIFIED: Y
AOF156I LAST STATUS CHANGE DATE= 07/12/97 , TIME= 09:17, OPER=AUTJES
AOF157I LAST MONITORED DATE= 07/12/97 , TIME= 09:17
AOF160I  ERROR COUNT    DATE      TIME
AOF161I          01     07/06/97   14:21
AOF002I END OF MULTILINE MESSAGE
```

In this example, the operator or automation procedures processes the command to display the entry, and the associated response is sent back as a multiline message.

ASFUSER

Purpose

The ASFUSER command is a file manager command that updates the ten user fields in the automation status file. The ASFUSER command has different formats depending on whether it is used to:

- Display multiple records
- Display, delete, or replace (update) a single record

Syntax

To display multiple records use the following syntax:

```
▶▶ ASFUSER [REQ=DISP,] FROM=resource [,-TO=resource] ▶▶
```

To display a single record use the following syntax:

```
▶▶ ASFUSER [REQ=DISP,] ID=resource ▶▶
```

To delete a single record use the following syntax:

▶▶—ASFUSER—REQ=DEL—ID=*resource*—▶▶

To replace (update) a record use the following syntax:

▶▶—ASFUSER—REQ=REPL—,ID=*resource*—▶▶

,
(1)
USER*n*—=*data*

Notes:

1 *n* may be a number from 1 to 10

Parameters

REQ

The type of request for automation status file record information the ASFUSER command performs. This value may be one of the following:

Value Description

DISP Displays a record in the automation status file. This value is the default if the REQ parameter is not coded.

DEL Deletes a record in the automation status file.

REPL Replaces or adds a record in the automation status file.

If this parameter is specified, other parameters that describe the data to be displayed, deleted, or updated must be specified.

FROM

The resource ID that is the starting key when displaying multiple automation status file records. This value can be from 1 through 16 characters long.

TO

The resource ID that is the ending key when displaying multiple records. If not specified, the value defaults to the same key as the FROM parameter. This value can be from 1 through 16 characters long.

ID The resource ID that is the key to the automation status file record. This ID is the application name for application records. This ID can be from 1 through 16 characters long.

USER1=*data*...USER10=*data*

These parameters specify data stored in each of the 10 fields in the automation status file reserved for your information. All these parameters are optional. The specified data can be 1 through 20 characters long. These parameters are only used with ASFUSER replace requests (REQ=REPL).

Restrictions and Limitations

An ASFUSER command to replace or update automation status file entries is limited to 240 characters.

The ASFUSER command is not pipeable.

Usage

If your automation procedure performs a replace or update function, only those fields that need replacing must be specified. No change occurs to other automation status file fields.

Messages

- The following messages are issued during successful operation of the ASFUSER command.

- For delete and replace requests:

```
AOF001I REQUEST "request" WAS SUCCESSFUL FOR "resource"
```

- For display requests, the following messages are issued. These messages use status record MYRECORD as an example. Message variables are filled in with values for MYRECORD.

```
AOF150I STATISTICS DISPLAY REQUESTED FOR MYRECORD
AOF151I id=MYRECORD
AOF158I USER1=value
:
:
AOF158I USER10=value
AOF002I END OF MULTILINE MESSAGE
```

- The following message is issued if the entry was not found for an ASFUSER display request.

```
AOF041I UNABLE TO FIND RECORD identifier
```

Note: An ASFUSER replace request adds an entry if one does not exist, so a successful message would result. For an ASFUSER delete request, if ASFUSER cannot find the identifier, it also issues a successful message.

Examples

Example 1

This example shows a command to create an automation status file record for a resource with a resource ID of DASD.

The ASFUSER command to create the record is:

```
ASFUSER REQ=REPL,id=DASD,USER1=3350,USER2=3380
```

The response to the ASFUSER command is:

```
AOF001I REQUEST "REPLACE" WAS SUCCESSFUL FOR "DASD  "
```

Example 2

This example shows a command to display an automation status file record for DASD.

The ASFUSER command to display the record is:

```
ASFUSER id=DASD
```

The response to the ASFUSER command is:

```
AOF150I STATISTICS DISPLAY REQUESTED FOR DASD
AOF151I id=DASD
AOF158I USER1=3350
AOF158I USER2=3380
AOF002I END OF MULTILINE MESSAGE
```

Example 3

This example shows a command to update the DASD automation status file record to add a new DASD device type.

The ASFUSER command to display the record is:

```
ASFUSER REQ=REPL, id=DASD, USER3=3990
```

The response to the ASFUSER command is:

```
AOF001I REQUEST "REPLACE" WAS SUCCESSFUL FOR "DASD  "
```

Note: Other values in record DASD remain as they were before the ASFUSER command was issued.

CDEMATCH**Purpose**

The CDEMATCH routine performs a function similar to a table search. It uses code values specified in the automation policy to create a table. You define the table match criteria and a control keyword or result field. Results from the search are returned to the automation procedure and are typically used to alter the automation procedure logic flow or an automation procedure command or reply. A typical use is to extract feedback and return codes from the message you are automating, and then perform a search in the automation control file using those codes. The result of that search alters the action the automation procedure takes.

Syntax

```

▶▶ CDEMATCH MSGTYP=type [ , -CODE1=code ] [ , -CODE2=code ]
▶ [ , -CODE3=code ] [ , -ENTRY=entry ]

```

Parameters**MSGTYP=*type***

The criteria for the type field during the code search; it also relates to the type field in the automation control file. MSGTYP is typically coded with the message ID or with a generic name, such as SPOOLSHORT or SPOOLFULL.

CODE1=*code* CODE2=*code* CODE3=*code*

The criteria used during the search. At least one code must be supplied and all three can be supplied, if desired. The codes can be specified in any order. The code is normally derived from the message detail. CODE1 relates directly to field 1 of the automation control file CODE format, CODE2 relates directly to field 2, and CODE3 to field 3.

ENTRY=*entry*

The criteria for the entry field during the command search. This value also relates to the entry field in the automation control file. Values for the CDEMATCH TGLOBALs named SUBSTYPE and SUBSAPPL determine the default for this parameter. See CDEMATCH TGLOBALs for more information. If the SUBSTYPE TGLOBAL value is SUBSYSTEM, the SUBSAPPL TGLOBAL

CDEMATCH

value is the default ENTRY value. Otherwise, the SUBSTYPE TGGLOBAL value is the default ENTRY value. The AOCQRY routine must be called before CDEMATCH for the defaults to work.

Restrictions and Limitations

This routine can be called only by another automation procedure or a command processor.

Return Codes

Return codes are:

- 0 A match was found. The result is in TGGLOBAL field EHKACTION.
- 1 No match was found.
- 4 Incorrect parameters were used in the call.
- 5 Timeout or other error occurred.
- 6 SA z/OS initialization incomplete, unable to process command request.

Usage

- When control is returned to the calling automation procedure, TGGLOBAL EHKACTION contains the data from the Value Returned field in the Code Processing panel of the customization dialogs. If no match occurs, EHKACTION contains nulls.
- Code matching specifications in the automation policy are order-dependent. The first match found is used.
- The format of code matching specifications in the automation policy allows the use of generic specifications, such as an asterisk (*) to indicate all remaining characters are ignored. When performing a search using CDEMATCH, pass the full text of the code. CDEMATCH truncates and compares as necessary.
- Code parameters (CODE1, CODE2, or CODE3) not specified when calling CDEMATCH are considered as matching whatever exists in the automation policy.
- Refer to *System Automation for z/OS Customizing and Programming* for more information about the code matching feature.

TGGLOBALS

Name	Description
------	-------------

EHKACTION	
------------------	--

	The data specified in the Value Returned field in the Code Processing panel of the customization dialogs. In the automation control file generated from this customization dialog field, this field follows the code matching data (Code 1, Code 2, and Code 3 fields).
--	---

	When the return code for CDEMATCH is greater than zero, the EHKACTION value is null.
--	--

Examples

Example 1

This example shows the relationship between CDEMATCH and the automation control file. The message to automate, \$HASP095, is produced by the JES2 subsystem and indicates that a catastrophic-level problem has occurred. This example assumes the full message text is passed to the automation procedure. The

automation procedure breaks the message apart, then calls CDEMATCH to determine whether the error codes are in the automation control file.

The code matching information is specified in the automation policy as follows.

Select the MESSAGES policy item for the JES2 Application object. On the *Message Processing* panel for the JES2 subsystem:

```

ACTIONS  HELP
-----
AOFMSGX          Message Processing          Row 1 to 4 of 26
Command ==> _____ SCROLL==> PAGE

Entry Type : Application          PolicyDB Name : DATABASE_NAME
Entry Name  : JES2                Enterprise Name : YOUR_ENTERPRISE

Define message IDs and their automation actions.
CMD = Command  REP = Reply  CODE = CODE  USER = User Data
AUTO = AT Actions          OVR = AT Override

Action  Message ID          Cmd Rep Code User Auto Ovr
-----  -----
CODE    $HASP095                2
Codes for JES2 Catastrophic Msg
$HASP098                2
$HASP099                1
$HASP426                1

```

Figure 5. Message Processing Sample Panel

The *Code Processing* panel for message \$HASP095 is displayed:

```

COMMANDS  HELP
-----
AOFMSGK          Code Processing          Row 1 to 10 of 22
Command ==> _____ SCROLL==> PAGE

Entry Name : JES2                Message ID : $HASP095

Enter the value to be passed to the calling CLIST when this resource
issues the selected message and the following codes are contained in
the message.

Code 1          Code 2          Code 3          Value Returned
-----          -----          -----          -----
ERROR*          $K03                IPLREQ
ERROR*          $K08                IPLREQ
ERROR*          $K15                IPLREQ
ABEND*          SA22                OPERCANCEL

```

Figure 6. Code Processing Sample Panel

The automation procedure is as follows:

```

/* REXX CLIST to respond to $HASP095          */
/* Check whether automation allowed and set TGLOBALs          */
'AOCQRY ...'
:
/* Check for a match using the detail entries from the input message
** msg - $HASP095 JES2 CATASTROPHIC type CODE = cde RC=rcde

```

CDEMATCH

```

**          (1)   (2)   (3)           (4) (5)   (6)   (7)           */
'CDEMATCH MSGTYP=$HASP095, CODE1='Msgvar(4)', CODE2='Msgvar(6)||',
', ENTRY=JES2'
Select
  When rc = 0 Then Do      /* Match found - check the action field */
    'GLOBALV GETT EHKACTION'
    Select
      When ehkaction = 'IPLREQ' Then Do /* Warn operators */
        :
      End
      When ehkaction = 'OPERCANCEL' Then Do /* Update log */
        :
      End
      Otherwise Nop
    End
  End
  When rc = 1 Then Do      /* No match found; warn if required */
    :
  End
  Otherwise Do             /* Error; perform warning action */
    :
  End
End
Exit

```

The CDEMATCH parameters, automation policy values, and values in message \$HASP095 relate as follows:

CDEMATCH Parameter	Automation Policy Value	\$HASP095 Message Value
MSGTYP=\$HASP095	Message ID value (\$HASP095)	\$HASP095 (first message variable)
ENTRY=JES2	Subsystem name (JES2)	JES2 (second message variable)
'CODE1='Msgvar(4)	Code 1 values (ERROR* and ABEND*)	<i>type</i> (fourth message variable)
'CODE2='Msgvar(6)	Code 2 values (\$K03, \$K08, \$K15, and SA22)	<i>cde</i> (sixth message variable)

CODE3 is not used in this example, and is allowed to default. In the automation policy, the Code 3 field is left blank.

The automation procedure processing depends on actions taken in response to whether message \$HASP095 contains codes matching those in the automation policy. In the example, if \$HASP095 does not contain any of the automation policy-specified codes, RETCODE equals 1 and the message is ignored. If \$HASP095 contains error codes \$K03, \$K08, or \$K15, the operator is warned that an IPL is required to restart JES2. If \$HASP095 contains abend code SA22, a record is logged indicating that the operator terminated JES2.

Example 2

This example uses the same message as in Example 1, but shows a different technique for breaking the message apart and coding the automation control file. The message to automate, \$HASP095, is produced by the JES2 subsystem and indicates a catastrophic-level problem has occurred. This example assumes the full message text is passed to the automation procedure. The automation procedure breaks the message apart, then calls CDEMATCH to determine whether the error codes are in the automation policy.

The code matching information is specified in the automation policy as follows.

Select the MESSAGES policy item for the JES2 Application object. On the *Message Processing* panel for the JES2 subsystem:

```

ACTIONS  HELP
-----
AOFMSGX          Message Processing          Row 1 to 4 of 26
Command ==>          SCROLL==> PAGE

Entry Type : Application          PolicyDB Name : DATABASE_NAME
Entry Name  : JES2                Enterprise Name : YOUR_ENTERPRISE

Define message IDs and their automation actions.
CMD = Command  REP = Reply  CODE = CODE  USER = User Data
AUTO = AT Actions          OVR = AT Override

Action  Message ID          Cmd Rep Code User Auto Ovr
-----  -----
CODE    $HASP095          3
        JES2 Catastrophic ABEND|ERROR
        $HASP098          2
        Enter termination option
        $HASP099          1
        All available functions completed
        $HASP426          1
        Specify initialization options

```

Figure 7. Message Processing Sample Panel

```

COMMANDS  ACTIONS  HELP
-----
Message Processing          Row 1 to 11 of 25
Command ==>          SCROLL==> PAGE

Entry Type : Application          PolicyDB Name : DATABASE_NAME
Entry Name  : JES2_CLASS          Enterprise Name : YOUR_ENTERPRISE

Subsystem   : JES2_CLASS

Enter messages issued by this resource that will result in automated actions.
Actions: CMD = Command  REP = Reply  CODE = CODE  USER = User defined values

Action  Message ID          Cmd Rep Code User
-----  -----
        $HASP095          3
        JES2 Catastrophic ABEND|ERROR
        $HASP098          2
        Enter termination option
        $HASP099          1
        All available functions completed
        $HASP426          1
        Specify initialization options
        WTORs          1
        Classification of WTORs

F1=HELP    F2=SPLIT    F3=END      F4=RETURN   F5=RFIND   F6=RCHANGE
F7=UP      F8=DOWN     F9=SWAP    F10=LEFT   F11=RIGHT  F12=RETRIEVE

```

The *Code Processing* panel for message \$HASP095 is displayed:

\$P JES2,ABEND,FORCE, respectively. If codes match, the automation procedure logs a record indicating the operator shut down JES2.

- The ENTRY parameter is not coded and defaults to JES2. This default occurs only if AOCQRY was previously called and TGLOBAL SUBSTYPE is properly filled in. Refer to “AOCQRY” on page 41 for more information.
- The example uses a different method to parse, or break apart, the message. It uses the REXX Parse instruction to parse the message without relying on a field number (position) in the message. The message is obtained by assigning the REXX function Arg(1) to a variable PARMSTR which is then parsed using tokens in the message text. This example also uses the REXX Strip function to strip extraneous blanks that may remain in a parsed variable if the Parse instruction is used as shown. You can also break apart the message in the NetView automation table, and send only necessary fields to this automation procedure.

CHKSUBS

Purpose

This command exists for compatibility reasons. The processing is done by the automation manager automatically as a result of the status updates. The return code is always 0.

CHKTHRES

Purpose

The CHKTHRES routine checks the number of errors recorded in the automation status file against a preset error threshold. It also supports recording the error date and time in the automation status file.

CHKTHRES searches the automation control file for the applicable threshold for a specific resource. It then obtains the error status information from the automation status file and determines, based on the thresholds, whether any of the three definable thresholds are exceeded. If a threshold is exceeded, an error message is issued and an appropriate return code is generated.

Syntax

Parameters are positional.



Parameters

resource

The name of the resource for which thresholds should be checked. This resource name can be an application name, a generic MVS component name, or any name you define up to 16 characters long. Examples of MVS component names are SMF and LOGREC. This parameter is required.

resource_type

The type of the resource. Normally, SUBSYSTEM is used for applications and

CHKTHRES

MVSESA for MVS components. This value can be any name you define up to 10 characters long. This parameter is required.

NEW

An error is added to the error status information; then thresholds are checked.

CHECK

Specifies whether a new error should be added to the error status information.

Thresholds are checked based on the existing error information.

COMMAND

This parameter determines the messages that CHKTHRES issues when the infrequent, frequent, and critical error thresholds are exceeded and the resource type is either SUBSYSTEM or MVSESA.

If the automation procedure in which you use CHKTHRES issues commands when an error threshold is exceeded, specify this parameter.

Restrictions and Limitations

This routine can be called only by another automation procedure or by a command processor.

Return Codes

Return codes are:

- | | |
|---|--|
| 0 | No threshold is exceeded |
| 1 | Infrequent threshold is reached |
| 2 | Frequent threshold is reached |
| 3 | Critical threshold is reached |
| 4 | Incorrect parameters were used in the call |
| 5 | Timeout or other error occurred |

Usage

- CHKTHRES accesses the automation policy to check the threshold definitions, and the automation status file to check the current status of the resource.
- CHKTHRES is used primarily to track error conditions that can be repetitive. By tracking the errors, operators can be notified of the repetitive error situation before it causes problems. SA z/OS tracks a minimal number of situations, such as application abends, SPOOL shortages, and problems causing full LOGREC conditions. It does not track specific error messages. When coding new automation procedures, restrict using this routine to these types of situations.
- Up to 10 errors can be stored in each record in the automation status file. These errors are stored in order of date and time of error. No details about the error are stored.
- To ensure the integrity of the SA z/OS abend threshold counter, do not add error status information using an application name. There is only one automation status file record for each application name, and this record is used to maintain the abend threshold counter.
- Each resource name in the automation status file must be unique. Select your resource names with care. Proper definition of the resource name gives meaning to the type of error and the job causing the error, particularly because the automation status file stores only the date and time of the error.
- CHKTHRES searches for the threshold in a predefined sequence to find the appropriate threshold.

When an error threshold is exceeded, one of the AOF58*n* messages is issued:

Message	Error Threshold
AOF587I	Critical
AOF588I	Frequent
AOF589I	Infrequent

Note: The issuing of commands is not a function of the CHKTHRES routine.

When an error threshold is exceeded, and COMMAND is not specified, one of the AOF57n messages is issued:

Message	Error Threshold
AOF577I	Critical
AOF578I	Frequent
AOF579I	Infrequent

If you are checking thresholds for resources that are not a subsystem, the following messages are issued:

Message	Error Threshold
AOF501I	Critical
AOF502I	Frequent
AOF503I	Infrequent

For a description of these messages, refer to *System Automation for z/OS Messages and Codes*.

Examples

This example shows the relationship between a CHKTHRES call in an automation procedure and thresholds defined in the automation policy. The example involves thresholds set for the TSO subsystem. The automation procedure checks the thresholds by calling CHKTHRES.

The thresholds are defined in the automation policy on the SA z/OS Thresholds Definition panel for the TSO subsystem, as follows:

```

COMMANDS  HELP
-----
AOFPIZTH          SA z/OS - Thresholds Definition          SCROLL==> PAGE
Command ==>>>

Entry Type : Application          PolicyDB Name  : DATABASE_NAME
Entry Name  : TSO                 Enterprise Name: YOUR_ENTERPRISE

Resource:    TSO
Description: TSO Application

Specify the number of times an event must occur to define a particular level.

----- Levels -----
Critical      Frequent      Infrequent
Resource      Number      Interval      Number      Interval
(hh:mm)      (hh:mm)      (hh:mm)
TSO           08         2:00         04         4:00         04         08:00
    
```

The automation procedure to call CHKTHRES is:

```

/* REXX CLIST to check thresholds when a TSO error occurs      */
/* Check whether automation allowed and set TGLOBALs           */
'AOCQRY ...'
:
'CHKTHRES TSO,SUBSYSTEM,NEW'
    
```

CHKTHRES

```
Select
  When rc = 0 Then Do
/*   perform actions required if no thresholds are exceeded   */
  :
  End
  When rc = 1 Then Do
/*   perform actions required if infrequent thresholds are exceeded */
  :
  End
  When rc = 2 Then Do
/*   perform actions required if frequent thresholds are exceeded   */
  :
  End
  When rc = 3 Then Do
/*   perform actions required if critical thresholds are exceeded.  */
  :
  End
  Otherwise Do
/*   otherwise, an error occurred, RC=4/5, log error message   */
  :
  End
End
Exit
```

In this example, the threshold settings for TSO in the automation policy define:

- A critical threshold as 8 errors occurring in 2 hours
- A frequent threshold as 4 errors in 4 hours
- An infrequent threshold as 4 errors in 8 hours

The example automation procedure performs the following processing steps:

1. The automation procedure calls CHKTHRES using a *resource_name* value of TSO, a *resource_type* value of SUBSYSTEM, and the NEW keyword.
2. The error information is added to the automation status file, and the thresholds are checked.
3. Upon return to the automation procedure, the rc special variable is checked. If the value indicates a critical threshold is exceeded, the automation procedure should stop recovery to be consistent with the message issued by CHKTHRES.

INGPOST

Purpose

The INGPOST command posts status notifications to SA z/OS's NMC-based user interface.

Syntax

```
►►—INGPOST—RESOURCE=resource_name—MINOR=minor_type/minor_name—►
EVENT=event_text—►
```

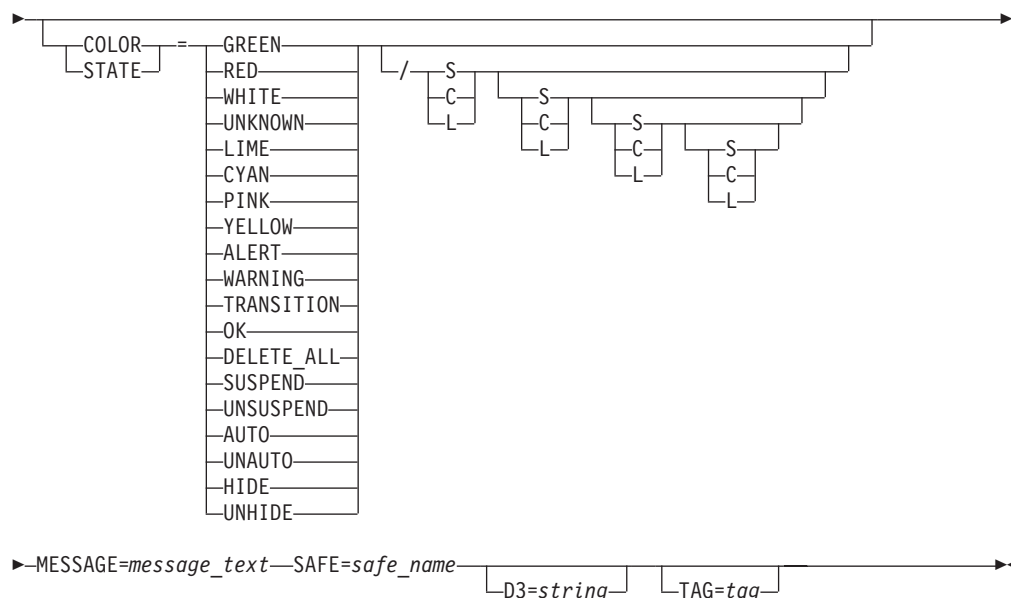
Parameters

RESOURCE

Specifies the name of the major resource that the notification is associated with.

resource_name

Is a standard SA OS/390 V2R1 resource name. The format is either *name/type* or *name/type[/system]*.

You should specify either a RESOURCE= parameter or (some of) the SCOPE=, MAJRESTYPE=, and MAJRESNAME= parameters. If you do not, the resource name will be defaulted.

The default resource name depends on the situation when the program is called. If a job name is available, and can be mapped to a subsystem, then the default resource name is *subsys_name/APL/cursys*. If the job name cannot be mapped to a system, then the default resource name is *job name/JOB/cursys*. If no job name is available, then the default resource name is *cursys/SYS/cursys*. This should always be used with a minor resource name.

Note that there are a number of special resources that act as anchors for dynamic objects created by INGPOST, as follows:

SYSPLEX

Is used for operations that affect the whole sysplex. It is equivalent to only specifying SCOPE=SYSPLEX.

WTOR

Is used with WTORs that are posted to NMC.

TAPE Is used with tape mount requests that are posted to NMC.

NET/netid

Is used for events related to a network. It is equivalent to specifying SCOPE=NETWORK.

domain/NET/netid

Is used for events related to a specific domain within a network. It is equivalent to specifying SCOPE=NETDOM.

LOCATION

Specifies that the location for the originating system given within the INGTOPOF file should be used. It is equivalent to specifying SCOPE=LOCATION.

MINOR

Specifies the minor resource name associated with the notification

minor_name

This is, more or less, a free-form field for specifying the minor resource name. The value must be valid as part of a RODM object name and may have requirements placed upon it by your BLDVIEWS implementation.

If not specified, the minor resource name defaults to null.

EVENT

Specifies a short 'status' value which is appended to the resource's DisplayResourceName.

event_text

Is a single word which will be folded to upper case and appended to the DisplayResourceName for the corresponding RODM object. It should be informative and short.

If not specified the event text will be null and only the resource name and the minor resource name will be present in the DisplayResourceName.

COLOR

Specifies the new DisplayStatus to be posted for the object within RODM.

GREEN or 129 or OK

Sets the object's DisplayStatus to Satisfactory

LIME or 144

Sets the object's DisplayStatus to Medium Satisfactory

CYAN or 145

Sets the object's DisplayStatus to Low Satisfactory

WHITE or 131 or TRANSITION

Sets the object's display status to Intermediate

YELLOW or 161 or WARNING

Sets the object's DisplayStatus to Low Unsatisfactory

PINK or 160

Sets the object's DisplayStatus to Medium Unsatisfactory

RED or 130 or ALERT

Sets the object's DisplayStatus to Unsatisfactory

UNKNOWN or 132

Sets the object's DisplayStatus to Unknown

Note that the syntax diagram does not show the numeric values for the statuses. However, they are accepted and processed correctly.

There are some special values which trigger different processing.

DELETE_ALL

Should be used with a major resource and deletes all minor resource objects associated with that major resource.

SUSPEND and UNSUSPEND

Changes the setting of the 'suspended from aggregation' part of the object.

AUTO and UNAUTO

Changes the setting of the 'automation in progress' part of the object.

HIDE and UNHIDE

Changes the setting of the 'excluded from exception views' part of the object.

The second part of the value is a set of up to 4 SCL flags. The first set applies to the 'operator marked' part, the second to the 'automation in progress' part, the third to the 'suspended from aggregation' part and the fourth to the 'exclude from exception views' part. The following are valid flags:

- S** Sets the bit
- C** Clears the bit
- L** Leaves the bit unchanged

These flags reduce the number of updates needed to perform a status change. Typically, when a resource changes from, for example, Awaiting Automation to Automation In Progress, you need to:

1. Change its color and status
2. Clear its 'operator marked' bit
3. Set its 'automation in process' bit

With these bits, the update can be done with one single call, posting the status as 144/CS. Without these flags this would require three separate calls. When the resource status changes from Automation In Progress to Satisfactory or Degraded, one would post statuses of GREEN/LC or WHITE/LC.

MESSAGE

Specifies a message to be shipped with the status update. It ends up in the DisplayResourceOtherData field.

message_text

This is the text of the message.

The maximum text length is 140 characters.

If not specified, and if a message is available from the safe, then that message will be used.

SAFE

This specifies the name of the safe that holds the message from which the default message text is to be taken.

safe_name

This is the name of the safe.

If not specified the default safe (called *) will be used.

If the safe is empty, then the default message text is null.

INGPOST

D3

When specified this populates the Data3 field on NMC with the given string.

string

This is the string that populates the Data3 field.

TAG

This can be specified when posting a minor resource against a major resource.

tag

This is the tag that is attached to the object in RODM (as an index). The same tag value can subsequently be used to restrict the scope of a STATUS=DELETE_ALL call for the major resource, so that it will only delete all attached minor resources with the same major resource.

INGPW

Purpose

INGPW initializes the SA z/OS password protection feature. The INGPW command processor maintains a VSAM file containing passwords for gateway operator IDs, called the SA z/OS password data set. These passwords are used when establishing gateway sessions. The records in the SA z/OS password data set are keyed using a combination of the user ID and domain ID. Each record has three fields:

- The *current-password* field
- The *new-password* field
- The *date-password-last-changed* field

Passwords are stored in encrypted format and are changed every 30 days.

Syntax

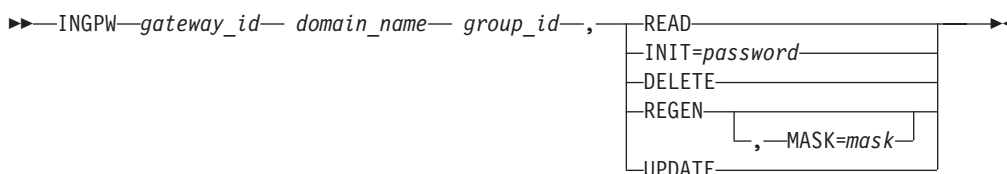

Parameters

gateway_id

The name of the gateway autotask.

domain_name

The domain for which password maintenance services are required.

Note: In a shared System Authorization Facility (SAF) data set environment, if the originating system logs on to two or more destination systems, the domain name specified for this parameter is the originating system, and must match the OWNER value specified in the Gateway Definitions customization dialog panel for the originating system.

group_id

This parameter is required only for environments where multiple shared SAF databases are in use. The *group_id* can be any 2 characters to identify each shared SAF database.

This parameter is required in situations where:

- The originating system logs on to two or more destination systems which reside within the same shared SAF database, and
- The originating system logs on to 2 or more shared SAF databases as described above.

You must code a blank between the *gateway_id* and *domain_name* and *group_id* values, as shown in the INGPW syntax diagram.

READ

Specifies that the desired password is retrieved from the data set. Every 30 days, INGPW generates a new password. This password generation causes SA z/OS to change the actual RACF password at the next gateway operator logon.

INIT

Used to create an entry in the SA z/OS password data set for the specified *gateway_id* and *domain_name* values, and to specify an initial password value for the entry.

The *password* value must be between 4 and 8 characters long.

Using INGPW with the *INIT=password* parameter is required as part of installing the SA z/OS password protection feature. Refer to *System Automation for z/OS Planning and Installation* for details.

DELETE

Specifies that the record with the matching gateway ID and domain name is deleted.

REGEN

Causes a new password to be generated (satisfying the requirements of the mask if it is specified). The current and new passwords are shown by message AOF661I in response to INGPW REGEN and any subsequent INGPW READ until a INGPW UPDATE is done.

MASK

Describes the format to be used when generating new passwords for gateway autotasks. The password generation mask consists of 4 to 8 pairs of characters, each pair defining the attributes of a single password character. The first character of each pair determines how the second character is to be used.

- ! A password character of the value indicated by the following mask character is required.
- % A password character of the type indicated by the following mask character is required.
- ? A password character of the type indicated by the following mask character is optional.

The password mask is processed from left to right, and will generate a string of characters having a length minimally equal to the number indicated as being required. requires passwords of at least 4 characters.

The password character type codes indicate the set of characters to be used when generating a new password. The valid type codes are as follows:

Char	Description	Values
\$	National only	@,#,\$
A	Alphabetic only	A-Z
B	Alphabetic/national	A-Z, @, #, \$
C	Consonant (alphabetic, no vowels)	
E	Even numerics	0, 2, 4, 6, 8
N	Numeric only	0-9
O	Odd numerics	1, 3, 5, 7, 9
V	Vowels only	A, E, I, O, U
W	Alphanumeric (no vowels)	
X	Alphanumeric	A-Z, 0-9
Y	Alphabetic/national	A-Z, 0-9, @, #, \$
Z	Alphanumeric/National (no vowels)	

For example, a password mask of !N!N!T%\$%C?N%N%E would cause SA z/OS to generate passwords beginning with 'NNT' followed by a national character, a consonant, and a two or three digit even number.

UPDATE

Will make the new password generated by REGEN become the current password.

Restrictions and Limitations

Use a blank instead of a comma to separate the *gateway_id*, *domain_name* and *group_id* values.

The *password* value must be 4-8 characters long.

For security reasons, it is strongly recommended that you use NetView command-class checking on INGPW.

-
-
-

Usage

Refer to *System Automation for z/OS Planning and Installation* and *System Automation for z/OS User's Guide* for more details on the SA z/OS password protection feature and on how to use the INGPW command.

Examples

Example 1

This example involves three systems, AOF01, AOF02, and AOF03. The systems are connected as shown in Figure 9 on page 87.

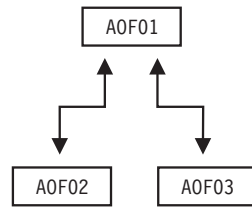

Figure 9. INGPW Example.

These systems do not share a SAF data set; each system maintains its own SAF data set. The following INGPW commands are issued on each system to initialize password values for gateway operator IDs outbound from each system and inbound on the other systems in the SA z/OS password data set for each system.

From system AOF01, the following INGPW commands are issued:

```
INGPW GATAOF01 A0F02,INIT=AAAAAAA
INGPW GATAOF01 A0F03,INIT=BBBBBBBB
```

From system AOF02, the following INGPW command is issued:

```
INGPW GATAOF02 A0F01,INIT=CCCCCC
```

From system AOF03, the following INGPW command is issued:

```
INGPW GATAOF03 A0F01,INIT=DDDDDD
```

If these systems shared a SAF data set, the only difference in INGPW commands issued is the following:

From system AOF01:

```
INGPW GATAOF01 A0F01,INIT=EEEEEEEE
```

Example 2

This example deletes the record for GATCHI01 to log on to domain ATL01 from the SA z/OS password data set.

```
INGPW GATCHI01 ATL01,DELETE
```

Example 3

This example involves five systems with multiple shared SAF databases. AOF02 and AOF03 share the same SAF data set, and AOF04 and AOF05 share another SAF data set. The systems are connected as shown in Figure 10 on page 88.

INGPW

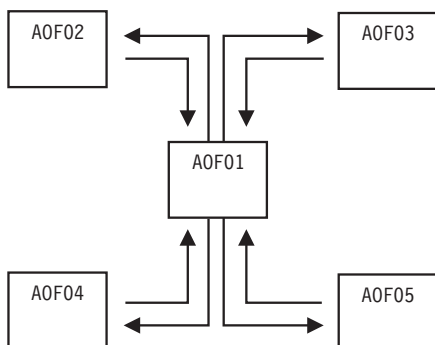

Figure 10. INGPW Shared SAF Database Example.

The following INGPW commands are issued on each system to initialize password values for gateway operator IDs, outbound from each system and inbound on the other systems in the SA z/OS password data set for each system.

From system AOF01, the following INGPW commands are issued:

```
INGPW GATAOF01 AOF01 R1,INIT=AAAAAAA INGPW GATAOF01 AOF01 R2,INIT=BBBBBBBB
```

From system AOF02, the following INGPW command is issued:

```
INGPW GATAOF02 AOF01,INIT=CCCCCCC
```

From system AOF03, the following INGPW command is issued:

```
INGPW GATAOF03 AOF01,INIT=DDDDDDD
```

From system AOF04, the following INGPW command is issued:

```
INGPW GATAOF04 AOF01,INIT=EEEEEEE
```

From system AOF05, the following INGPW command is issued:

```
INGPW GATAOF05 AOF01,INIT=FFFFFFF
```

The SAF group identifiers R1 and R2 used in the INGPW command for AOF01 are necessary to identify each shared SAF database. The names chosen for the SAF group identifiers are user defined, however they must match the values specified on the SA z/OS SAF Environment Definition panel of the customization dialogs.

INGRCLUP

Purpose

The INGRCLUP common routine is used to cancel address spaces that may be left over by a resource that did not properly shut down. Multiple address spaces with the same name can be canceled.

Syntax

```
▶▶—INGRCLUP—jobname—————▶▶
```

Parameters

jobname

The job name of the address space(s) that must be canceled.

Restrictions and Limitations

The specified parameter cannot be the job name of an SA z/OS managed resource.

Primarily INGRCLUP is meant to be called from within the automation policy (that is, PRESTART or POSTSTART commands). If you want to call the INGRCLUP common routine from within an automation procedure you have to call AOCQRY before any INGRCLUP call.

Return Codes

Return codes are:

- 0 Processing was successful.
- 4 Parameters are invalid.

INGRTCMD

Purpose

The INGRTCMD command can be used as a second level NMC command exit for issuing commands from NMC. It takes an object ID and a command string and substitutes object parameters into the command string before routing it to the appropriate system for execution.

Syntax

```
▶▶—INGRTCMD—object_id—cmd_string—▶▶
```

Parameters

object_id

Is the RODM object ID that the command should be issued against. It is used to determine the substitution parameters as well as the target sysplex for the command. The command is sent to the system within the target sysplex which the currently received heartbeats and status change notifications originate from.

cmd_string

Is the command to be issued. It may include substitution tokens.

INGUSS

Purpose

The INGUSS command allows an automation procedure to send commands to z/OS UNIX System Services.

Syntax

```
▶▶—INGUSS—JOBNAME=INGCUNIX—UNIX_command—▶▶  

JOBNAME=jobname
```

Parameters

JOBNAME=*jobname*

This is the MVS job name used for the newly created address space which runs the specified command. If you do not specify a job name, INGCUNIX is the default.

UNIX_command

This is the z/OS UNIX command that is issued under the user ID of the resource this command belongs to. It is not possible to issue commands for other user IDs. It can be any z/OS UNIX command or the name of a shell script (both fully qualified). The resource that issues this command must have an application type USS.

Restrictions and Limitations

The INGUSS command can be called only by another automation procedure or by a command processor. The common routine AOCQRY must be invoked first to set the necessary TGLOBALs.

Note: The INGUSS command can only be used if the primary JES is available. Therefore, z/OS UNIX resources using INGUSS need a HASPARENT dependency to JES. Most of all z/OS UNIX applications have this dependency. If you want to issue prestart commands, an additional PREPAVAILABLE dependency is necessary. This is because SA z/OS does not create an address space without JES.

Usage

The following variables can be used to obtain data of the resource, if INGUSS is issued from the automation policy:

&SUBSPATH

The path statement of the resource. The resource must be a process.

&SUBSFILE

The filename of the resource. The resource must be a file.

&SUBSPID

The ID for the USS process. See also %PID% below. &SUBSPID is the process id returned from the host service BPX1SPN while %PID% is the process ID returned from the USS call getpsent().

IBM recommends the use of &SUBSPID in preference to %PID% as problems can arise retrieving the pid in an environment where there are multiple uid 0 users active.

&SUBSPORT

The port number of the resource. The resource must be a port.

&SUBSUSSJOB

The job name assigned to a process. The resource must be a process.

&SUBSAPPL

The application name.

&SUBSASID

The address space ID of the address space the process runs in. The resource must be a process.

The information for &SUBSUSSJOB and &SUBSASID is refreshed with each monitoring cycle. If a process forks and gets a new job name (normally a digit is

appended at the end of the original job name), SA z/OS will detect the new job name after the next scheduled monitoring. This works only if SA z/OS internal process monitoring is used.

When the resource becomes inactive, the values of &SUBSUSSJOB and &SUBSASID are cleared.

In addition, for process resources %PID% can be used to get the PID of a process. The command `INGUSS /bin/kill %PID%` results in determining the PID of the process defined by the path of the resource and replacing %PID% by the real value of the process ID.

When issuing a command, SA z/OS switches to the users home directory and sets the following environment variables for the user the resource belongs to:

- HOME
- USER
- SHELL

The login shell uses these environment variables to detect which UNIX[®] profiles to execute. If the started program should get the whole environment of the user as if this user was logged on, you must use a login shell as start command.

Recommendation:

When using INGUSS to start applications, IBM recommends to use the `JOBNAME` parameter in order to get a unique job name. For example,

```
INGUSS JOBNAME=&SUBSJOB UNIX_start_command
```

Otherwise, all applications started by SA z/OS without this parameter will have the same job name `INGCUNIX` (if the application itself does not change the job name).

If the job name is not unique, specify job type `MVS`.

Examples

To start the `inetd` through a login shell, issue the following command:

```
INGUSS JOBNAME=INETD /bin/sh -L -c '/usr/sbin/inetd /etc/inetd.conf'
```

JOBNAME=INETD

this is optional, it assigns the MVS job name 'INETD' to the started process

/bin/sh

the shell

-L option for login shell

-c option to the shell to execute the following command:

'/usr/sbin/inetd /etc/inetd.conf'

this is the command that is executed by the login shell

MDFYSHUT

Purpose

MDFYSHUT sets the AOFSHUTMOD task global variable to whatever value is contained in the MDFYSHUT parameter string. The AOFSHUTMOD value is then used by the shutdown program.

MDFYSHUT also provides support for a SUSPEND function.

Syntax

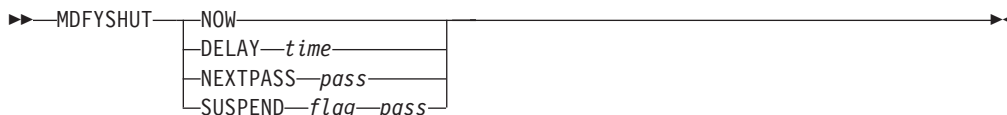

Parameters

NOW

The next shutdown pass will occur as soon as possible.

DELAY

The next shutdown pass will occur after *time* instead of the shut delay defined for the subsystem. Note that there is no validation of the time. If you set an invalid value the shutdown may abend.

NEXTPASS

The next shutdown pass that will be processed (after the subsystem shut delay) will be *pass*, not the current pass plus one.

SUSPEND

Determines how the shutdown is suspended, where:

flag

Is the name of a common global variable that is used to determine how the shutdown is suspended. If the flag is set off, the shutdown will be stopped and the flag will be checked again on the next pass. If the flag is set on the shutdown will continue, that is, it is no longer suspended.

pass

Is the number of the pass that the MDFYSHUT SUSPEND command is coded on. It must be included so that MDFYSHUT can return to this pass and recheck the flag.

Restrictions and Limitations

MDFYSHUT can be used on any pass of the shutdown.

The routine containing MDFYSHUT must run on the default task, that is, leave the task field blank.

The routine containing MDFYSHUT cannot be rescheduled with a CMD LOW.

TGLOBALS

AOFSHUTMOD is a task global variable which is set by the MDFYSHUT command during the shutdown process. Its value affects the subsequent flow of

the shutdown process. Possible values are any parameter string for the MDFYSHUT command except for suspend.

MDFYSHUT

Chapter 3. Monitoring Routines

SA z/OS offers several routines that can be used to monitor various aspects of your enterprise.

Using System Operations Monitoring Routines for Programming

SA z/OS provides common and generic routines for use in automation procedures. Common and generic routines are convenient routines that provide your automation procedures with a simple, standard way of interfacing with the automation control file, the automation status file, and the NetView log file. It is strongly recommended that you use these routines wherever possible in your own code.

Using common and generic routines in automation procedures provides you with the following advantages:

- Reduced development time -- less code has to be written
- Portable code -- automation policy information that is unique to an enterprise can be kept in the automation control file rather than distributed among many automation procedures. The automation procedures implement a number of different rules for handling a situation and the automation control file is used to select which rules are applicable to the current situation.
- A consistent, documented interface

Refer to Chapter 4, "Generic Routines," on page 101 for further information on how to use generic routines, and Part 2, "SA z/OS System Operations Routines," on page 5 for further information on how to use common routines in automation procedures.

AOFADMON

Purpose

The AOFADMON routine is used to determine the status of a job within the operating system using the MVS D A method. For performance reasons it is recommended that you use INGPJMON instead of AOFADMON.

Syntax

▶▶—AOFADMON—*jobname*—▶▶

Parameters

jobname

The job name by which the operating system knows the associated application.

Restrictions and Limitations

AOFADMON should only be used as a programming facility because its only output is a return code.

AOFADMON

Return Codes

Return codes are:

0	Job is active
4	Job is starting
8	Job is inactive
12	Parameter error

AOFAPMON

Purpose

The AOFAPMON routine is used to determine the status of a PPI receiver. It calls DISPPI and checks if a specific PPI receiver is active.

Syntax

▶▶—AOFAPMON—*ppiname*————▶▶

Parameters

ppiname

The name of the PPI receiver this routine searches for. When the PPI receiver is active, the system issues return code 0. Otherwise return code 8 is issued.

Restrictions and Limitations

AOFAPMON should only be used as a programming facility because its only output is a return code.

Return Codes

The following return codes are issued:

0	Resource is active
8	Resource is inactive

AOFATMON

Purpose

The AOFATMON routine is used to determine the status of a task operating within the NetView environment. When the application is defined using the SA z/OS customization dialogs, the application *jobname* must be defined to be the NetView task name.

Syntax

▶▶—AOFATMON—*taskname*————▶▶

Parameters

taskname

The name of the NetView task whose status is to be obtained. This name is the same as the application job name.

Restrictions and Limitations

AOFATMON should only be used as a programming facility because its only output is a return code.

Return Codes

Return codes are:

0	The task is active
4	The task is starting
8	The task is inactive
12	Parameter error

AOFCPSM

Purpose

The AOFCPSM routine is a dedicated routine used to determine the status of processor operations using the ISQCHK service.

Syntax

▶▶—AOFCPSM—*jobname*—————▶▶

Parameters

jobname

The job name by which SA z/OS knows the processor operations application.

Restrictions and Limitations

AOFCPSM should only be used as a programming facility because its only output is a return code.

Return Codes

Return codes are:

0	Task is active
4	<i>Not used</i>
8	Task is inactive
12	<i>Not used</i>

This routine uses the ISQCHK service to determine the status of processor operations. ISQCHK returns RC=0 if processor operations is operational, and RC=32 if it is not. These return codes are remapped to RC=0 (active) and RC=8 (inactive).

AOFUXMON

Purpose

The AOFUXMON routine is used to determine the status of a resource with application type USS. This resource can either be an z/OS UNIX process, a file in

AOFUXMON

the z/OS UNIX filesystem (HFS), or a TCP port. Depending on the kind of resource (process, file, or port) AOFUXMON decides which internal monitoring method to use.

Syntax

▶▶ AOFUXMON—*jobname*————▶▶

Parameters

jobname

The job name that automation knows the associated application as. This can be obtained from the SUBSJOB task global variable returned by AOCQRY.

Restrictions and Limitations

AOFUXMON should only be used as a programming facility because its only output is a return code.

AOFUXMON uses active rather than passive monitoring for PORTs. Active monitoring will cause a connection to be established to an active port. If this is not desirable then a customer supplied monitoring routine should be used instead of AOFUXMON for PORT monitoring.

Return Codes

The following return codes are issued:

- | | |
|----|---|
| 0 | The resource is active. |
| 4 | The resource is starting. |
| 8 | The resource is inactive. Also returned if JES is inactive. and SA z/OS is restarting after an IPL. |
| 12 | JES is inactive and SA z/OS has fully initialized after an IPL. |
| 16 | One of the following parameter errors occurred:
The <i>jobname</i> parameter was not specified.
The <i>jobname</i> parameter does not represent a USS type resource.
The <i>jobname</i> parameter does not represent a USS PATH, PORT or FILE. |
| 20 | A return code other than 0, 4 or 8 was returned from the USS INGCCMD routine. Check for related messages or turn on debug for AOFUXMON (this also turns on debug for INGCCMD). |
| 24 | OMVS is not ACTIVE. |

INGPJMON

Purpose

The INGPJMON routine is used to determine the status of a job within the operating system using the ASCB method. This is *not* the SA z/OS status of the job, which should be determined using AOCQRY.

INGPJMON replaces AOFAJMON but provides the following additional functions:

- It optionally returns the jobname and address space ID that match passed criteria
- It allows you to search for all address spaces that match the specified jobname
- It supports optional address-space search criteria

This new monitoring routine is the foundation for supporting duplicate jobnames since standard address space monitoring now takes the address space ID associated with the job into account. This allows you to distinguish between multiple occurrences of the same job in the system.

Note: Although this new routine replaces AOFAJMON, it has an AOFAJMON alias. Therefore, you do not have to change your own Policy DB.

Syntax

```

▶▶—INGPJMON—jobname—┬──┬──┬──┬──▶
                        [ ,asid ] [ ,stem ] [ ,options ]

```

Parameters

jobname

This is the name of the job to be searched for. An asterisk (*) must be specified as a placeholder if no job name exists.

asid

This is the address space ID (in hex) associated with the job. If omitted, the INGPJMON routine returns the first address space that matches the job name.

stem

This is the name of a NetView Task global stem name that will contain the job name and ASID of the address space that has been found. The parameter is optional. If a Task global name is specified, the following data are returned separated by a comma:

1. Job name.
2. Address space ID. If more than one ASID are returned, they are separated by a blank.

options

These are additional options, as follows:

***ALL**

Causes the monitoring routine to return all ASIDs that match the specified job name.

***TRACE**

Causes the monitoring routine to trace its processing by means of the component trace.

If a Task global name is specified, the following data are returned separated by a comma:

```
WEBSERVER,0028 0033 0045 ... xxxx xxxx
```

Restrictions and Limitations

None.

ISQMTSYS

Purpose

The ISQMTSYS routine monitors processor operations target system resources. It is used to verify the availability of a target system according to a timer defined by the user.

Syntax

▶▶—ISQMTSYS—*jobname*————▶▶

Parameters

jobname

The job name by which SA z/OS knows the processor operations target system.

Restrictions and Limitations

None.

Return Codes

The return codes are:

- 0 The target system is active
- 4 The target system is starting
- 8 The target system is inactive
- 12 The resource could not be found

Chapter 4. Generic Routines

Generic routines are routines that are complete in their own right. They can be called from the NetView automation table, from timers, or from other automation procedures.

This chapter explains how to use the generic routines that perform a single, specialized function.

The routines described here may be used while automating any SA z/OS application. In the context of SA z/OS, an *application* is defined as:

- An MVS subsystem
- An MVS job
- A non-MVS resource; that is, a resource that cannot be monitored using ASCB checks, or that does not respond to the usual MVS startup and shutdown commands
- Your own applications

Occasionally, you may see the term *subsystem* used to refer to applications in general.

Using SA z/OS Generic Routines for Programming

Using common and generic routines in automation procedures provides you with the following advantages:

- Reduced development time, because less code has to be written.
- Portable code, because automation policy information unique to an enterprise can be kept in the automation control file rather than distributed among many automation procedures. The automation procedures implement a number of different rules for handling a situation and the automation control file is used to select which rules are applicable to the current situation.
- A consistent, documented interface.
- Normally, these routines are invoked directly from the NetView automation table but they can also be called from automation procedures.

Refer to Part 2, “SA z/OS System Operations Routines,” on page 5 for further information on how to use common routines in automation procedures.

ACTIVMSG

Purpose

You can use the ACTIVMSG generic routine to respond to ACTIVE and UP messages from your application by changing the SA z/OS status of the application. ACTIVMSG can also call ISSUEREPLY to issue a reply if the message is a WTOR. Typically, ACTIVMSG is called from the NetView automation table.

If ACTIVMSG is called from the NetView automation table, no parameters are required. If it is called from an automation procedure (CLIST), the JOBNAME parameter must be supplied, and the REPLY, PASSES, and CODE1, CODE2, and CODE3 parameters are ignored.

Syntax

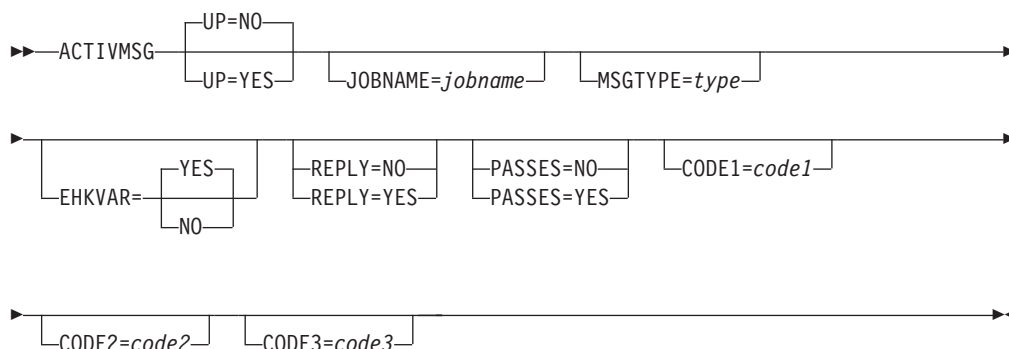

Parameters

UP

This parameter is used to distinguish between ACTIVE messages and UP messages. ACTIVE messages indicate that the job associated with an application is working but is not yet available for use. UP messages indicate that the job associated with an application is available for use.

NO

NO should be used if you are responding to an application ACTIVE message. The application is placed in ACTIVE status if it is not there already. UP=NO is the default.

YES

YES should be used if you are responding to an application UP message. The application is placed in UP status if it is not there already. If the application is a transient job then it is placed in RUNNING status.

JOBNAME

The name of the job that the message is for. If not specified, the job name is taken from the message's job name field. You must supply a value for the job name if you are calling ACTIVMSG from a CLIST.

For ISQ900 messages the job name is identical to the processor operations target system name.

MSGTYPE

This parameter is used to search for command entries to *subsystem/msgtype*-pairs in the automation control file, where *subsystem* is the subsystem name derived from the job name.

When a match occurs, the commands that are associated with the entries are issued. This is in addition to the entries that are associated with the ENTRY-TYPE pair *subsystem/ACTIVE* if UP=YES and *subsystem/UP* if UP=NO.

If parameter MSGTYPE is not specified, the message identifier of the message for which ACTIVMSG is called is taken as default.

For ISQ900 messages the MSGTYPE parameter becomes mandatory.

EHKVAR

This parameter determines whether the tokens of the parsed message text are to be stored in task global variables EHKVAR1 to EHKVAR9.

YES

The tokens of the triggering message are to be assigned to the task global variables EHKVAR*n*.

NO

No values are to be assigned to the task global variables EHKVAR*n*.

REPLY

This parameter determines whether ISSUEREP is called to reply to the message. If no REPLY value is coded and ACVTIVMSG is called for a WTOR, ACTIVMSG defaults to REPLY=YES, otherwise it defaults to REPLY=NO.

YES

If the message being handled by ACTIVMSG is a WTOR, the ISSUEREP generic routine is called to provide the reply.

NO

ISSUEREP is not called.

PASSES

This parameter is passed to ISSUEREP if it is called to reply to the message. If no PASSES value is coded, ACTIVMSG passes PASSES=NO to ISSUEREP.

YES

PASSES=YES is passed to the ISSUEREP generic routine, if it is called.

NO

PASSES=NO is passed to the ISSUEREP generic routine, if it is called.

CODE1=code1 CODE2=code2 CODE3=code3

These parameters are passed to the ISSUEREP generic routine, if it is called.

Restrictions and Limitations

- An ACTIVMSG for an application that is already in UP status has no effect.
- An ACTIVMSG UP=NO for an application that is already in ACTIVE status has no effect.
- ISSUEREP is called to reply to a WTOR only if the Start automation flag for the application is on.
- If this command is called on a task other than the AOFWRKxx auto operator that is responsible for the subsystem, ACTIVMSG will schedule itself to that AOFWRKxx auto operator. This means that when the calling procedure gets control again, the status of the subsystem may not have changed yet.

Usage

It is recommended that you use ACTIVMSG for all IEF403I (job started) messages.

If ACTIVMSG is called for a WTOR and ISSUEREP is not called, OUTREP is called to track the WTOR.

If you are invoking ACTIVMSG for a generic message you should use AOCFILT to screen the message before invoking ACTIVMSG. See "AOCFILT" on page 107 for more information.

If you are calling ACTIVMSG from an automation procedure, and this calling procedure is not running on the AOFWRKxx automation operator that is responsible for the affected subsystem, the ACTIVMSG routine will be routed to that operator. The ACTIVMSG routine will run asynchronously to the calling

ACTIVMSG

procedure. This means that when the calling procedure regains control, the status of the affected subsystem may not yet have changed.

TGLOBALS

EHKVAR1 through EHKVAR9

When defining the commands or replies in the automation control file to be issued by generic routine ACTIVMSG, the variables &EHKVAR1 through &EHKVAR9 can be used to be substituted by the tokens of the parsed message, which has driven ACTIVMSG. &EHKVAR1 will be substituted by the first token of the message text after the message ID, &EHKVAR2 with the second token and so forth.

Examples

The following example shows how to issue ACTIVMSG from the NetView automation table:

```
IF MSGID='IEF403I' & TOKEN(2)=SVJOB & DOMAINID = %AOFDOM%
THEN
EXEC(CMD('AOCFILT ' SVJOB 'ACTIVMSG JOBNAME=' SVJOB)
ROUTE(%AOFOPGSSOPER% ));
```

AOFCPMSG

Purpose

The AOFCPMSG generic routine lets you:

- Capture messages and save them in CGLOBALS for subsequent display by DISPINFO
- Add the message to SDF for display in the Messages panels
- Add the message to NMC as a minor resource of the major resource that issued the message

To use the AOFCPMSG routine, add it to your NetView automation table.

Syntax

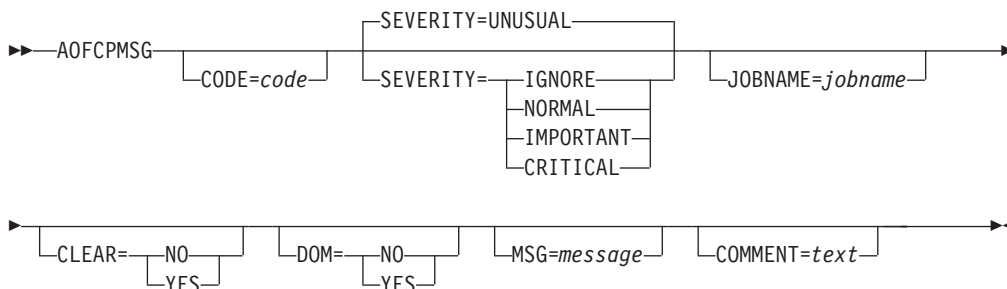

Parameters

CODE

code

This is the optional CODE value used by CDEMATCH to specify the severity of the message.

SEVERITY

This parameter allows you to directly specify a severity and bypass the code matching process. To change the severity classification of a message you need to change the automation table.

The severity of a message can also be specified in a CDEMATCH against the subsystem. If no match is found against the subsystem, a match is attempted against the system issuing the message. The message ID for the code match is CAPMSGS. CODE1 is set to the message ID of the message being captured. CODE2 is set to the subsystem name of the subsystem that issued the message. CODE3 is set to the value specified in the CODE3= parameter. The value returned is one of the following severity codes:

IMPORTANT

The message is captured and its color is set to PINK.

IGNORE

The message is not captured.

NORMAL

The message is captured and its color is set to GREEN.

UNUSUAL

The message is captured and its color is set to YELLOW.

CRITICAL

The message is captured and its color is set to RED.

JOBNAME

The JOBNAME is optional and specifies the job name of the subsystem that issued or is assigned to the message. This parameter overrides the value as determined from the jobname() function against the message.

CLEAR**YES|NO**

Specifies whether or not the existing messages that are recorded for the subsystem should be erased and SDF and NMC resources should be removed for the subsystem. This may be specified without a message being issued. The default is NO.

DOM**YES|NO**

Specify YES to cause AOFCPMSG to delete a previously captured message instance that matches the current message ID (that is, the message ID passed to AOFCPMSG from the AT unless overridden by the MSG parameter).

If a match is found then the first instance of this message ID is removed from SDF and NMC and the severity of the deleted message is downgraded to normal in the globals. If the current message has a severity higher than normal, a DOM record is also recorded in the globals. See the MSG parameter for details on how to override the message ID passed from the AT.

MSG***message* (message ID or message ID followed by text)**

Specify a message to override the message that is passed from the AT. This may be an entire message including a message ID followed by message text or just a message ID. This parameter can be also be used in

AOFCPMSG

| conjunction with the DOM parameter to DOM any previously captured
| message. When used in conjunction with the DOM parameter only a
| message ID is needed.

| The *message* must be delimited with single quotes, double quotes, or
| parentheses if it contains blanks or special characters.

COMMENT

| *text*

| If specified, this text will be appended to the message for SDF and placed
| in the DATA3 field for NMC.

| The comment text must be delimited with single quotes, double quotes, or
| parentheses if it contains blanks or special characters.

Restrictions and Limitations

To use the AOFCPMSG command system operations must be initialized. AOFCPMSG should only be executed as an automation table command. Excessive use of AOFCPMSG will reduce NetView storage because messages are stored in common global variables. It is recommended to restrict the use of AOFCPMSG to exception condition messages.

Usage

Add the AOFCPMSG routine to your NetView automation table.

Examples

```

AOFKINFO          SA z/OS - Command Dialogs          Line 115 of 192
Domain ID   = IPSFM   ----- DISPINFO -----      Date = 06/28/02
Operator ID = KAT                                           Time = 09:20:53

Subsystem ==>  CICS1H      System ==>  KEY1      System name, domain ID
                                                or sysplex name

Captured Messages for CICS1H -

2002-06-28 09:19:25 :
  AOF571I 09:19:24 : CICS1H SUBSYSTEM STATUS FOR JOB CICS1H IS
                STARTED - STARTUP FOR CICS1H/APL/KEY1 IN PROGRESS
  AOF570I 09:19 : ISSUED "MVS S
                CICS21TX,JOBNAME=CICS1H,SUFF=K1H,PARM='SYSIN,START=AUTO'
                " FOR SUBSYSTEM CICS1H - MSGTYPE IS STARTUP
2002-06-28 09:19:32 :
  IEF403I CICS1H - STARTED - TIME=09.19.25
  AOF571I 09:19:32 : CICS1H SUBSYSTEM STATUS FOR JOB CICS1H IS
                ACTIVE - ACTIVE MESSAGE RECEIVED
2002-06-28 09:19:38 :
  DFHSI1502I IPSAMCIH CICS STARTUP IS WARM.
2002-06-28 09:19:42 :
  AOF571I 09:19:42 : CICS1H SUBSYSTEM STATUS FOR JOB CICS1H IS UP
                - UP MESSAGE RECEIVED
2002-06-28 09:19:43 :
  AOF570I 09:19 : ISSUED "MSG LOG,PERFORM UP PROCESSING" FOR
                SUBSYSTEM CICS1H - MSGTYPE IS UP
2002-06-28 09:19:48 :
  AOF570I 09:19 : ISSUED "MSG LOG,PERFORM PPI UP PROC" FOR
                SUBSYSTEM CICS1H - MSGTYPE IS PPIACTIVE

Policy Definitions for CICS1H -

ABENDED :
  CMD=(,,'MSG LOG,PERFORM DOWN PROCESSING')

ACORESTART :
  CMD=(,,'CICRSYC')

Command ==>>
PF1=Help   PF2=End     PF3=Return   PF4=INGINFO   PF6=Roll
PF7=Back   PF8=Forward  PF9=Refresh  PF10=CICS Info PF12=Retrieve

```

Figure 11. DISPINFO Sample Panel Showing Captured Messages

AOCFILT

Purpose

This generic routine is used to screen messages which invoke other generic routines. While it adds to the overhead of a useful invocation of a generic routine, it greatly reduces CPU used to detect an unnecessary invocation.

Syntax

```

▶▶ AOCFILT jobname command ◀◀
          |
          *

```

Parameters

jobname

This is the name of the job that the message refers to. If an * is specified then the default job name for the message, retrieved with the NetView Jobname() function, is checked.

command

This command is issued (in a PIPE) if the *jobname* parameter is the name of a job known to SA z/OS. If the job name is not the name of a job of a SA z/OS-controlled application, the command is not issued.

Restrictions and Limitations

- The command should be invoked only when there is a message in the default safe. Normally this will be from the automation table.
- You must obtain the job name before you invoke AOCFILT.

Return Codes

AOCFILT returns a return code of 0.

Usage

The command should be coded in the automation table where you are using a generic message (such as IEF403I) to invoke one of the SA z/OS generic routines (such as ACTIVMSG).

AOCFILT routes the passed command to the autooperator responsible for that particular subsystem.

AOCFILT is not as efficient as explicitly screening for the message in the automation table, but may be more efficient than negative screening. AOCFILT also makes the automation statement more portable, in that you will not have to update it if you define a new application to SA z/OS.

Examples

In the example below, the automation table is used to block out all IEF403I messages concerning jobs starting with the letters BAT, and AOCFILT is used to screen the other IEF403I messages.

```
IF MSGID = 'IEF' . & DOMAINID = %AOFDOM% THEN BEGIN;
...
  IF MSGID = 'IEF403I' THEN BEGIN;

      IF TOKEN(2) = 'BAT' . THEN Y DISPLA(N) NETLOG(Y);

      IF TOKEN(2) = SVJOB THEN
      EXEC(CMD('AOCFILT ' SVJOB ' ACTIVMSG JOBNAME=' SVJOB)
      ROUTE(ONE %AOFOPGSSOPER%));
      END;
      ...
      ALWAYS;
      END;
```

Related Commands

- ACTIVMSG (page 101)
- HALTMSG (page 110)
- ISSUECMD (page113)
- ISSUERE (page 117)
- TERMMSG (page 126)

FWDMSG

Purpose

FWDMSG can be invoked from the NetView automation table to forward messages from a remote system to a focal point system. By defining entries in the remote NetView automation table that invoke FWDMSG you can:

- Trap messages in which you are interested
- Assign specific message classes to those messages
- Forward the messages to the focal point system

Messages are received by focal point notification operators who are defined to receive messages of the assigned classes.

Syntax

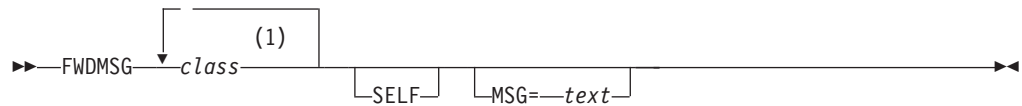

Notes:

- 1 Up to 10 classes may be specified. Classes should be separated by blanks.

Parameters

class

The message notification classes to be assigned to the message. You should specify at least one message class. If no class is specified, the message is sent to GATOPER's authorized receiver. You can specify up to ten blank-delimited message classes. There are no default message classes defined.

SA z/OS notification classes are described in *System Automation for z/OS Messages and Codes*. You can define your own message classes using the Environment Definition panels of the customization dialogs.

Note: The classes you assign here must match those defined using the Operator Notification panels of the customization dialogs.

SELF

If FWDMSG is invoked on a system that does not have a defined focal point, send the message to the appropriate notification operators on the issuing system. If FWDMSG is invoked on a system that does have a defined focal point, SELF is ignored.

MSG

The message text used for this message. If not coded, the messages in the message buffer are used. This parameter is valid for single-line messages only.

Restrictions and Limitations

- Do not use the MSG parameter for multiline messages.
- When FWDMSG is called from the NetView automation table, the message to be processed is in the message buffer. When FWDMSG is called from a command

FWDMSG

processor or other automation routine, the message text from the MSG= parameter is treated as the entire message to be forwarded, including the message ID.

- If invoked with a pipe, all messages in the pipe will be forwarded to the focal point as separate messages.

Return Codes

Return codes are:

- 0 Automation procedure processed correctly.
- 1 Processing error was encountered.

When the MSG parameter is used for a multiline message, the following message is issued:

```
AOF013: SPECIFIED OPERAND MSG= INVALID FOR msgid MLWTO
```

Examples

Example 1

The following example sends individual messages for each line in the multiline response:

```
IF MSGID='IST075I' & DOMAINID = %AOFDOM%  
THEN EXEC(CMD('FWDMSG A1')ROUTE(ONE *));
```

Example 2

The following example sends all RACF messages to ensure notification of security violations:

```
IF MSGID='ICH' . & DOMAINID = %AOFDOM%  
THEN EXEC(CMD('FWDMSG A2')ROUTE(ONE *));
```

HALTMSG

Purpose

The HALTMSG generic routine changes the status of an application to HALTED status if its Recovery automation flag is on.

HALTMSG can be issued from the NetView automation table, in which case no parameters are required, or from an automation procedure (CLIST), in which case the JOBNAME parameter must be supplied and the REPLY parameter is ignored.

Syntax

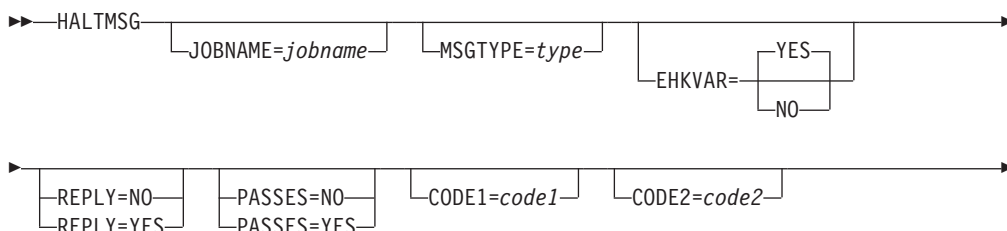

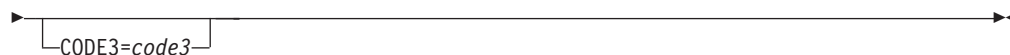

Parameters

JOBNAME

The name of the job that the message is for. If not specified, the job name is taken from the message's job name field. You must supply a value for the job name if you are calling HALTMSG from a CLIST.

For ISQ900 messages the job name is identical to the processor operations target system name.

MSGTYPE

This parameter is used to search for command entries to *subsystem/msgtype*-pairs in the automation control file, where *subsystem* is the subsystem name derived from the job name.

When a match occurs, the commands that are associated with the entries are issued. This is in addition to the command entries that are associated with the ENTRY-TYPE pair *subsystem/HALTED*.

If parameter MSGTYPE is not specified, the message identifier of the message for which HALTMSG is called is taken as the default.

For ISQ900 messages the MSGTYPE parameter becomes mandatory.

EHKVAR

This parameter determines whether the tokens of the parsed message text are to be stored in task global variables EHKVAR1 to EHKVAR9.

YES

The tokens of the triggering message are to be assigned to the task global variables EHKVAR n .

NO

No values are to be assigned to the task global variables EHKVAR n .

REPLY

This parameter determines whether ISSUEREP is called to reply to the message. If no REPLY value is coded and HALTMSG is called for a WTOR, HALTMSG defaults to REPLY=YES, otherwise it defaults to REPLY=NO.

YES

If the message that is being handled by HALTMSG is a WTOR, the ISSUEREP generic routine is called to provide the reply.

NO

ISSUEREP is not called.

PASSES

This parameter is passed to ISSUEREP if it is called to reply to the message. If no PASSES value is coded, ISSUEREP is called without the PASSES parameter.

YES

PASSES=YES is passed to the ISSUEREP generic routine, if it is called.

NO

PASSES=NO is passed to the ISSUEREP generic routine, if it is called.

CODE1=*code1* CODE2=*code2* CODE3=*code3*

These parameters are passed to the ISSUEREP generic routine, if it is called.

Restrictions and Limitations

- HALTMSG will not affect an application that is being shut down.
- HALTMSG will not affect an application that is not in UPstatus.
- The application status is updated and the relevant commands are issued each time HALTMSG is run.
- ISSUEREP is called for the message only if the Recovery automation flag is on.
- If this command is called on a task other than the AOFWRKxx auto operator that is responsible for the subsystem, HALTMSG will schedule itself to that AOFWRKxx auto operator. This means that when the calling procedure regains control, the status of the subsystem may not have changed yet.
- Only messages for applications with known address space IDs are processed by HALTMSG.

The address space ID is not checked if HALTMSG is called from an automation procedure (CLIST), or if HALTMSG has been triggered by message BPXF024I.

Usage

Applications can be put into HALTED status when something occurs that leaves them running with reduced function. Use HALTMSG to put an application into HALTED status, and ACTIVMSG (or the SETSTATE command dialog) to change the status.

If HALTMSG is called for a WTOR and ISSUEREP is not called, OUTREP is called to process the WTOR.

If you are calling HALTMSG from an automation procedure, and this calling procedure is not running on the AOFWRKxx automation operator that is responsible for the affected subsystem, the HALTMSG routine will be routed to that operator. The HALTMSG routine will run asynchronously to the calling procedure. This means that when the calling procedure regains control, the status of the affected subsystem may not yet have changed.

TGLOCALS

EHKVAR1 through EHKVAR9

When defining the commands or replies in the automation control file to be issued by generic routine HALTMSG, the variables &EHKVAR1 through &EHKVAR9 can be used to be substituted by the tokens of the parsed message, which has driven HALTMSG. &EHKVAR1 will be substituted by the first token of the message text after the message ID, &EHKVAR2 with the second token and so forth.

Examples

The following example shows how to issue HALTMSG from the NetView automation table:

```
* IKT008I TCAS NOT ACCEPTING LOGONS
IF MSGID = 'IKT008I' & DOMAINID = %AOFDOM% THEN
  EXEC( CMD('HALTMSG')
  ROUTE(ONE %AOFOPGSSOPER%)
  DISPLAY(Y) NETLOG(Y);
```



ISSUECMD

Purpose

ISSUECMD issues commands defined in the automation control file. You can use ISSUECMD to trigger your own commands from messages defined in the MESSAGES section of the Application Automation Definition policy item for an application.

ISSUECMD can be called from the NetView automation table or from an automation procedure (CLIST). If you call ISSUECMD from the NetView automation table you don't have to pass any parameters. If you call ISSUECMD from an automation procedure, you must supply the ENTRY and MSGTYPE parameters.

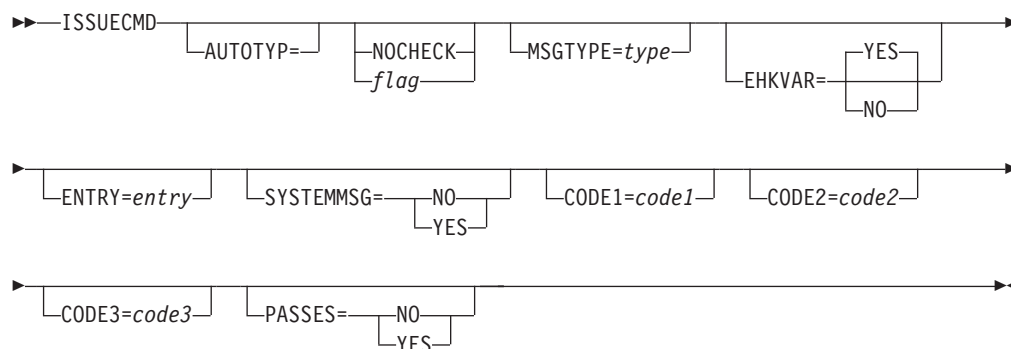
Syntax



Parameters

AUTOTYP

The automation flag that is to be checked. If the flag is turned off the commands are not issued. The default is RECOVERY if AUTOTYP is not specified.

NOCHECK

If NOCHECK is specified, the RECOVERY flag is checked and the commands are issued regardless of its setting.

If NOCHECK is specified and SYSTEMMSG=YES, Automation and Recovery are the only valid flags.

flag

flag must be one of the following:

AUTOMATION
 INITSTART
 RECOVERY
 RESTART
 START
 TERMINATE

If SYSTEMMSG=YES is specified, NOCHECK, AUTOMATION and RECOVERY are the only valid flags.

If no AUTOTYP value is coded and SYSTEMMSG=YES, then ISSUECMD defaults to AUTOTYP=RECOVERY.

If no AUTOTYP value is coded and SYSTEMMSG=NO, then the default value is determined according to the following steps:

1. If startup of the application is in progress, then AUTOTYP=START.
2. If shutdown of the application is in progress, then AUTOTYP=TERMINATE.
3. If neither a startup nor a shutdown is in progress, a value for AUTOTYP is taken that corresponds to the actual status of the application:

AUTOTYP	Actual Status
START	ACTIVE, ENDING, EXTSTART, RESTART, RUNNING, STARTED, STARTED2
TERMINATE	ABENDING, AUTOTERM, BREAKING, HALFDOWN, STOPPING, STUCK, ZOMBIE
RECOVERY	AUTODOWN, BROKEN, CTLDOWN, DOWN, ENDED, FALLBACK, HALTED, INACTIVE, MOVED, STOPPED, UP

4. If no actual status information is available, RECOVERY is taken as the default value for AUTOTYP.

MSGTYPE

This is the value entered in the *type* field in the automation control file entry for the command. It defaults to the ID of the message that initiated ISSUECMD, if ISSUECMD is called from the NetView automation table. If ISSUECMD is called directly from a CLIST you must supply this parameter.

For ISQ900 messages the MSGTYPE= parameter becomes mandatory.

EHKVAR

This parameter determines whether the tokens of the parsed message text are to be stored in task global variables EHKVAR1 to EHKVAR9.

YES

The tokens of the triggering message are to be assigned to the task global variables EHKVAR n .

NO

No values are to be assigned to the task global variables EHKVAR n .

ENTRY

This is the *entry* value to be used to search the automation control file for the commands to issue.

- If ISSUECMD is called from the NetView automation table:
 - *entry* defaults to the application name, as determined from the job name, for application messages
 - *entry* defaults to the system type (MVSESA) for system messages
- If ISSUECMD is called directly from a CLIST you must supply this parameter.

SYSTEMMSG

Indicates whether the message is a system message or an application message.

YES

The message has come from a system rather than from an application. SYSTEMMSG defaults to YES if the command is called from the NetView automation table, and the job name cannot be obtained from the message details.

NO

The message has come from an application.

CODE_n

When specified, the passed codes are used for a search in code entries to entry/type of automation policy MESSAGES/USERDATA. The response to the matching entry is used as option to select the commands to issue from the automation control file. If no match occurs for the specified codes, option ALWAYS is used to select the commands to issue. The CODE-parameters are mutually exclusive to the PASSES=YES parameter.

PASSES

Specifies whether or not passes are used to issue the commands.

YES

Passes are used to issue the commands. The pass count is incremented only if the flag is turned on. The pass count is keyed by type. For normal messages the count is reset when the application is shut down. For system messages, the pass count is reset when NetView is recycled.

NO

Passes are not used to issue the commands.

If PASSES is not coded, it defaults to YES if AUTOTYP has a value other than START or TERMINATE, and the selected command entries of the automation control file use pass selection options. Otherwise, the default value to PASSES is set to NO.

Restrictions and Limitations

- ISSUECMD works best if it is called from the NetView automation table. From a CLIST it is recommended to call AOCQRY and ACFCMD directly rather than call ISSUECMD.
- When using the default of AUTOTYP=NOCHECK, the entry defaults to the job name rather than the application name.
- ISSUECMD will only work when SA z/OS is fully initialized.
- If SYSTEMMSG=YES is specified, ISSUECMD must be driven by a message without an associated job name.
- SYSTEMMSG=YES is only valid in combination with AUTOTYP values NOCHECK, RECOVERY, or AUTOMATION.

Usage

This routine can be coded into the NetView automation table to issue commands in response to a message. It can also be used on a timer to get automation flag control of timer-issued commands.

The message that caused the ISSUECMD call is stored in the SAFE named AOFMSAFE. All commands that are triggered through ISSUECMD have access to this SAFE.

If PASSES and SYSTEMMSG are not specified and AUTOTYPE=START is flagged, then the current start type will be taken as a selection for the command.

If AUTOTYP=TERMINATE is not specified and AUTOTYP=TERMINATE is flagged, the current stoptype will be taken as the selection for the command.

TGLOBALs

EHKVAR1 through EHKVAR9

When defining the commands in the automation control file to be issued by generic routine ACTIVMSG, the variables &EHKVAR1 through &EHKVAR9 can be used to be substituted by the tokens of the parsed message, which has driven ACTIVMSG. &EHKVAR1 will be substituted by the first token of the message text after the message ID, &EHKVAR2 with the second token and so forth.

In the case when ISSUECMD is driven by an ISQ900I message, containing a WTOR, &EHKVAR1 can be used for the reply ID, when defining a reply to this WTOR in the automation control file. The tokens of the ISQ900I message text are not provided in the task global variables EHKVAR*n*.

Examples

This example shows an automation procedure that calls the ISSUECMD generic routine for handling the HSM subsystem message, ARC0027I.

The automation policy looks as follows:

```

AOFK3D0X          SA z/OS - Command Response          Line 1 of 4
Domain ID  = IPSNO  ----- DISPACF -----          Date = 07/19/00
Operator ID = ROLI                                     Time = 18:20:45

Command = ACF ENTRY=HSM,TYPE=ARC0027I,REQ=DISP
SYSTEM = KEY3      AUTOMATION CONFIGURATION DISPLAY - ENTRY= HSM
-----
AUTOMATION CONFIGURATION DISPLAY - ENTRY= HSM
TYPE IS ARC0027I
CMD          = (,,'MVS S HSMPL0GB')
END OF MULTI-LINE MESSAGE GROUP

Command ==>
PF1=Help      PF2=End          PF3=Return          PF6=Roll
               PF9=Refresh     PF12=Retrieve

```

Figure 12. DISPACF Sample Panel

The NetView automation table entry to call ISSUECMD is:

```

IF MSGID = 'ARC0027I' & DOMAINID = %AOFDOM%
THEN EXEC(CMD('ISSUECMD AUTOTYP=START') ROUTE(ONE *));

```

The automation flag to check is Start, which is specified on ISSUECMD using AUTOTYP=START. ISSUECMD validates that automation is allowed by checking the HSM Start flag before issuing the command. If automation is allowed and message ARC0027I is received for job DFHSM, a command is issued that saves the HSM data set. If message ARC0027I is received for any job other than DFHSM, the message is not automated.

If you specify a clist named MYCLIST instead of an MVS command for the message ARC0027I in the message policy of the customization dialog, this clist can

access the original message that triggered ISSUECMD via the named safe AOFMSAFE. This way you are able to access the message attributes and all lines of a multiline message. The code to access this safe should look similar to the following:

```
/* MYCLIST */
...
/* Get the message from the SAFE called AOFMSAFE */
"PIPE (STAGESEP | NAME GETMSG)" ,
  "SAFE AOFMSAFE" ,
  "| STEM orig_msg."
...
Exit
```

ISSUEREP

Purpose

ISSUEREP issues replies defined in the automation control file. You can use ISSUEREP to issue your own replies using the MESSAGES section of the Application Automation Definition policy item for an application.

ISSUEREP can be called from the NetView automation table or from an automation procedure (CLIST). If you call ISSUEREP from an automation procedure you must supply the JOBNAME and MSGTYP parameters.

Syntax

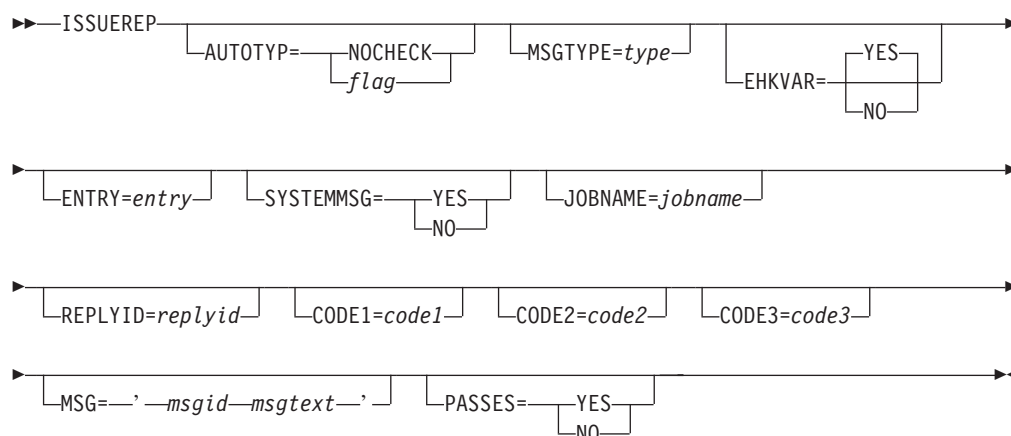

Parameters

AUTOTYP

The automation flag that is to be checked. If the flag is turned off, no replies are issued. The default is RECOVERY if AUTOTYP is not specified.

NOCHECK

If NOCHECK is specified, the RECOVERY flag is still checked, but the replies are issued regardless of its setting.

ISSUEREP

flag

The *flag* must be one of:

- AUTOMATION
- INITSTART
- RECOVERY
- RESTART
- START
- TERMINATE

If SYSTEMMSG=YES is specified, NOCHECK, AUTOMATION and RECOVERY are the only valid flags.

If no AUTOTYP value is coded and SYSTEMMSG=YES, then ISSUEREP defaults to AUTOTYP=RECOVERY.

If no AUTOTYP value is coded and SYSTEMMSG=NO, then the default value is determined according to the following steps:

1. If startup of the application is in progress then AUTOTYP=START
2. If shutdown of the application is in progress then AUTOTYP=TERMINATE
3. If neither a startup nor a shutdown is in progress, a value for AUTOTYP is taken that corresponds to the actual status of the application:

AUTOTYP	Actual Status
START	ACTIVE, ENDING, EXTSTART, RESTART, RUNNING, STARTED, STARTED2
TERMINATE	ABENDING, AUTOTERM, BREAKING, HALFDOWN, STOPPING, STUCK, ZOMBIE
RECOVERY	AUTODOWN, BROKEN, CTLDOWN, DOWN, ENDED, FALLBACK, HALTED, INACTIVE, MOVED, STOPPED, UP

4. If no actual status information exists, the default value for AUTOTYP is set to RECOVERY.

MSGTYPE

This is the value entered in the *type* field in the automation control file entry for the command. It defaults to the ID of the message that initiated ISSUEREP, if ISSUEREP is called from the NetView automation table. If ISSUEREP is called directly from a CLIST you must supply this parameter.

EHKVAR

This parameter determines whether the tokens of the parsed message text are to be stored in task global variables EHKVAR1 to EHKVAR9.

YES

The tokens of the triggering message are to be assigned to the task global variables EHKVAR n .

NO

No values are to be assigned to the task global variables EHKVAR n .

ENTRY

This is the *entry* value to be used to search the automation control file for the replies to issue.

- If ISSUEREP is called from the NetView automation table:
 - *entry* defaults to the application name, as determined from the job name, for application messages

- *entry* defaults to the system type (MVSESA) for system messages
- If ISSUEREP is called directly from a CLIST you must supply this parameter.

SYSTEMMSG

Indicates whether the message is a system message or an application message.

YES

The message has come from a system rather than from an application. SYSTEMMSG defaults to YES if the command is called from the NetView automation table, and the job name cannot be obtained from the message details.

NO

The message has come from an application.

PASSES

Specifies whether or not passes are used to issue the replies.

YES

Passes are used to issue the replies. The pass count is incremented only if the flag is turned on. The pass count is keyed by type, and for normal messages, the count is reset when the application is shut down. For system messages, the pass count is reset when NetView is recycled.

NO

Passes are not used to issue the replies.

If PASSES is not coded, it defaults to YES, if AUTOTYP has a value other than START or TERMINATE and the selected reply entries of the automation control file use pass selection options. Otherwise, the default value to PASSES is set to NO.

JOBNAME

This is used to pass the name of the job when ISSUEREP is called from a CLIST that is not initiated by the NetView automation table.

MSG

This is used to pass the message text when ISSUEREP is called from a CLIST that is not initiated by the NetView automation table.

REPLYID

This parameter is used to pass the replyid when ISSUEREP is called from a CLIST that is not initiated by the NetView automation table.

By default, the *replyid* is taken from the associated message if ISSUEREP is called by a WTOR. Otherwise ACFREP is called without the REPLYID parameter.

CODE_n

When specified, a search of ENTRY-TYPE occurs with the codes, and whatever is found for the action is used to reply to the WTOR.

These are used to specify codes which are used in a code match. These codes cannot be used with PASSES=YES (they override it).

Restrictions and Limitations

ISSUEREP may only be run on the same task where the WTORS that ISSUEREP is to reply to would be processed by OUTREP if the ISSUEREP is to reply to the message that it is invoked for. This is because the ISSUEREP command blocks the task while it is waiting for OUTREP to run. However, OUTREP cannot run because

ISSUEREP

the task is busy. The OUTREP processing normally occurs on the task identified in the %AOFOPWTORS% automation table synonym, but the automation table may route the processing to a different task.

If you code an ISSUEREP call for a WTOR, you should not code an additional OUTREP call for the same WTOR. If ISSUEREP cannot find a value to reply to the WTOR with, it automatically involves OUTREP to record the WTOR. This also happens if ISSUEREP is called and finds that the automation for the message is turned off.

ISSUECMD will only work when SA z/OS is fully initialized.

Usage

ISSUEREP works best if it is called from the NetView automation table. From a CLIST it is recommended to call ACFREP directly rather than to call ISSUEREP.

If a reply is not found by either ACFREP or by CDEMATCH, the WTOR is passed to OUTREP which adds it to the system SDF display.

If PASSES, SYSTEMMSG and CODEX are not specified and AUTOTYPE=START is flagged, then the current start type will be taken as a selection for the command.

If AUTOTYP=TERMINATE is not specified and AUTOTYP=TERMINATE is flagged, the current stoptype will be taken as a selection for the command.

TGLOBALS

EHKVAR1 through EHKVAR9

When defining the replies in the automation control file to be issued by generic routine ACTIVMSG, the variables &EHKVAR1 through &EHKVAR9 can be used to be substituted by the tokens of the parsed message, which has driven ACTIVMSG. &EHKVAR1 will be substituted by the first token of the message text after the message ID, &EHKVAR2 with the second token and so forth.

Examples

This example shows how an automation procedure calls the ISSUEREP generic routine for the GTF REPLY message, AHL125A.

The automation policy settings significant in this example are as follows:

Select the MESSAGES policy item from the SA z/OS Policy Selection panel for the GTF subsystem.

```

ACTIONS  HELP
-----
AOFGEPOL          SA z/OS Policy Selection          Row 1 to 17 of 17
Command ==>>>          SCROLL==>>> PAGE

Entry Type : Application          PolicyDB Name : DATABASE_NAME
Entry Name : GTF                  Enterprise Name : YOUR_ENTERPRISE

Action      Policy Name      Policy Description
-----
LINK TO CLASS      DESCRIPTION      Enter description
APPLICATION INFO   LINK TO CLASS    Link instance to class
INFO BRIDGE       APPLICATION INFO Enter and display Application information
AUTOMATION INFO   INFO BRIDGE      Enter INFO Bridge resource name
AUTOMATION INFO   AUTOMATION INFO Define Application automation information
AUTOMATION INFO   AUTOMATION INFO Define Application automation flags
s  MESSAGES        MESSAGES        Define Application messages
SHUTDOWN          SHUTDOWN        Define shutdown procedures
THRESHOLDS       THRESHOLDS      Define error thresholds
RESTART           RESTART         Define commands executed at restart
MINOR RESOURCES   MINOR RESOURCES Define Application sub-component flags
SYSTEM ASSOCIATION SYSTEM ASSOCIATION Define primary and secondary associations
TRIGGER           TRIGGER         Select Application trigger
-----
WHERE USED        WHERE USED       List ApplicationGroups linked to this entry
COPY              COPY            Copy data from an existing entry

F1=HELP      F2=SPLIT      F3=END      F4=RETURN      F5=RFIND      F6=RCHANGE
F7=UP        F8=DOWN       F9=SWAP     F10=LEFT       F11=RIGHT     F12=RETRIEVE

```

Figure 13. SA z/OS Policy Selection Panel

The SA z/OS Message Processing panel for the GTF subsystem is displayed, on which you enter the Message ID that is to trigger the reply. You enter REP in the action column to specify that a reply is to be called in response to message AHL125A.

On the SA z/OS Message Processing panel for the GTF subsystem:

```

COMMANDS  ACTIONS  HELP
-----
AOFPISSM          SA z/OS - Message Processing          ROW 1 TO 17 OF 21
Command ==>>>          SCROLL==>>> PAGE

Entry Type : Application          PolicyDB Name : DATABASE_NAME
Entry Name : GTF                  Enterprise Name : YOUR_ENTERPRISE

Resource: GTF

Enter messages issued by this resource that will result in automated actions.
Actions: CMD = Command  REP = Reply  CODE = CODE

Action      Message id      Description          Cmd Reply Code
-----
REP         AHL125A        Reply for AHL125A

```

When you press the ENTER key, the SA z/OS Reply Processing panel for GTF message AHL125A is displayed, on which you can enter the reply text to be issued:

ISSUEREP

```
COMMANDS  HELP
-----
AOFPISSR          SA z/OS - Reply Processing          ROW 1 TO 17 OF 20
Command ==>>>          SCROLL==>>> PAGE

Entry Type : Application          PolicyDB Name : DATABASE_NAME
Entry Name : GTF                  Enterprise Name : YOUR_ENTERPRISE

Resource:  GTF
Message ID: AHL125A

Enter the replies to be issued when this resource issues the selected message.

Pass or   Retry Reply Text
Selection Count
          U
```

The Automation Flags policy item for the GTF subsystem should be set up to allow automation of the message. By entering Y (YES) in the field for the Automation flag and the Start flag, you ensure that automation is allowed when an AHL125A message is issued.

```
COMMANDS  ACTIONS  HELP
-----
AOFGFAS1          SA z/OS - Flag Automation Specification
Command ==>>>

Entry Type : Application          PolicyDB Name : DATABASE_NAME
Entry Name : GTF                  Enterprise Name : YOUR_ENTERPRISE

Resource:  GTF
Enter level of automation desired.

Automation Flags:  Y = Yes      N = No      E = Exits
Assist Flags:     D = Display  L = Log      N = None

Actions   Flag      Auto      Assist
Automation . Y
Recovery . .
Start. . . . NONE
ShutDown . . NONE
Initstart. . NONE
Restart. . . NONE
Enter or Display times to disable automation . . NO      Yes  No
```

The NetView automation table entry to call ISSUEREP is:

```
IF MSGID = 'AHL125A' & DOMAINID = %AOFDOM%
THEN EXEC(CMD('ISSUEREP AUTOTYP=START') ROUTE(ONE %AOFOPWTORS%));
```

The GTF job name is GTFPROD. The job name is entered on the SA z/OS Define New Entry panel for the application when it is created, and cannot be changed.

The automation flag to check is Start, which is specified on ISSUEREP using AUTOTYP=START. ISSUEREP validates that automation is allowed by checking the GTF Automation flag before issuing the reply. If automation is allowed and message AHL125A is received for job GTFPROD, ISSUEREP replies with U. If message AHL125A is received for a job other than GTFPROD, the message is not automated.

OUTREP

Purpose

The OUTREP routine captures and saves MVS reply identifiers for applications issuing outstanding replies. Some applications issue an outstanding reply when they start, and that reply is used for critical operator communication or shutdown commands. This routine captures those reply IDs and message text and saves them in case the automation code needs them for recovery or shutdown.

Syntax

```

▶▶—OUTREP—┐
              └──message──┘
  
```

Parameters

message

The message text for the outstanding reply. If not specified it will be picked up from the default safe.

Restrictions and Limitations

This routine can be called only from the NetView automation table.

If you code an ISSUEREP call for a WTOR, you should not code an additional OUTREP call for the same WTOR. If ISSUEREP cannot find a value to reply to the WTOR with, it automatically involves OUTREP to record the WTOR. This also happens if ISSUEREP is called and finds that the automation for the message is turned off.

Usage

This routine attempts to determine the application name from the job name associated with the message. It then calls CDEMATCH with:

```

CODE1=msgid
CODE2=jobname
  
```

to determine what is to be done with the outstanding WTOR.

If an application is found, CDEMATCH searches the Automation Control File for CODE entries that are associated with ENTRY-TYPE pairs of application-WTORS where application is the application name as determined from the job name.

If an application cannot be found, or there is no match from the first search, then CDEMATCH searches CODE entries that are associated with ENTRY-TYPE keys of MVSESA-WTORS.

When the details of the WTOR are stored internally, they are associated with the application name if one can be found, or the value of AOFSYSTEM (MVSESA) if one cannot be found.

If a successful match occurs, CDEMATCH returns an action consisting of two words instructing OUTREP what to do with the WTOR. WTORS are assigned a status on the basis of the first word of the action returned and a priority on the

OUTREP

basis of the second word. SA z/OS replies to all WTORS with a priority of PRIMARY before replying to WTORS with a priority of SECONDARY.

The following table shows the valid actions and their corresponding WTOR statuses:

Table 8. Code Match Actions for OUTREP

WORD1	WORD2	STATUS	COLOR	DESCRIPTION
no action	PRI	UWTOR	Yellow	Either an unusual WTOR is found, or there was no match on either search.
IMPORT	PRI	IWTOR	Red	A serious primary WTOR
IMPORT	SEC	IWTOR	Red	A serious secondary WTOR
IMPORTANT	PRI	IWTOR	Red	A serious primary WTOR
IMPORTANT	SEC	IWTOR	Red	A serious secondary WTOR
NORMAL	PRI	NWTOR	Green	A normal primary WTOR
NORMAL	SEC	NWTOR	Green	A normal secondary WTOR
UNUSUAL	PRI	UWTOR	Yellow	An unusual (intermediate) primary WTOR
UNUSUAL	SEC	UWTOR	Yellow	An unusual (intermediate) secondary WTOR

The codes on which CDEMATCH is to search are entered against a message ID of WTORS in the Code Processing panels of the customization dialogs. Figure 14 shows an example of code entries for an application resource (AOFAPPL). Figure 15 on page 125 shows an example of code entries for the MVSESA resource.

```

COMMANDS  HELP
-----
AOFPISSSE          SA z/OS - Code Processing          ROW 1 TO 8 OF 20
Command ==>>>                                         SCROLL==>>> PAGE

Entry Type : Application          PolicyDB Name  : DATABASE_NAME
Entry Name  : Example            Enterprise Name : YOUR_ENTERPRISE

Resource:   AOFAPPL
Message ID: WTORS

Enter the value to be passed to the calling CLIST when this resource
issues the selected message and the following codes are contained in
the message.

Code 1          Code 2          Code 3          Value Returned
DSI802A        *                *                NORMAL PRI
  
```

Figure 14. Code Processing Panel for an Application Resource

```

COMMANDS  HELP
-----
AOFPISSSE          SA z/OS - Code Processing          ROW 1 TO 8 OF 20
Command ==>>>          SCROLL==>> PAGE

Entry Type : MVS Component          PolicyDB Name : DATABASE_NAME
Entry Name : Example                Enterprise Name : YOUR_ENTERPRISE

Resource:  MVSESA
Message ID: WTORS

Enter the value to be passed to the calling CLIST when this resource
issues the selected message and the following codes are contained in
the message.

Code 1          Code 2          Code 3          Value Returned
-----
DSI803A        *                *                NORMAL PRI
DFH*          PRODCS*          *                IMPORTANT PRI
DFH*          TESTCST1         *                IMPORT PRI
DFH*          TESTCSX1         *                NORMAL PRI
DFH*          TESTCSX2         *                IMPORT PRI
DFH*          TESTCSX3         *                NORMAL PRI
DFH*          DEVTCS*          *                NORMAL PRI
TEST01        WTORTWO          *                NORMAL
TEST02        WTORTWO          *                NORMAL SEC

```

Figure 15. Code Processing Panel for the MVSESA Resource

These code entries result in the following behavior:

- If job AOFAPPL issues message DSI802A it is assigned a status of NWTOR and is displayed as NORMAL (green) in SDF.
- If message DSI803A is issued it is assigned a status of NWTOR and is displayed as NORMAL(green) in SDF.
- All WTORS for all production CICS regions with a job name prefix of PRODCS are assigned a status of IWTOR.
- All WTORS for test CICS regions with job names of TESTCST1 or TESTCSX2 are assigned a status of IWTOR. All WTORS for TESTCSX1 and TESTCSX3 are assigned a status of NWTOR.
- All WTORS for all development CICS regions with a job name prefix of DEVTCS are assigned a status of NWTOR.
- Job WTORTWO issues two WTORS, TEST01 and TEST02. TEST02 is an UP message and TEST01 is a shutdown message. Both messages are assigned a priority of NWTOR. TEST01 is assigned a priority of PRI and TEST02 is assigned a priority of SEC to ensure that TEST01 is answered preferentially if ACFREP is called for the application.
- All other WTORS are considered unusual. They are assigned a status of UWTOR and are displayed in yellow in SDF.

Refer to *System Automation for z/OS Customizing and Programming* for more information on WTOR statuses and code processing.

TGLOBALs

None.

Examples

The following is an example of calling the OUTREP routine directly from the NetView automation table:

OUTREP

```
IF MSGID='DSI802A' & DOMAINID = %AOFDOM%
THEN
EXEC(CMD('OUTREP') ROUTE(ONE %AOFOPWTORS%));
```

In this example, OUTREP is called for the NetView outstanding reply message, DSI802A. %AOFDOM% is a synonym defined to be the current domain. %AOFOPWTORS% is a cascade for processing WTORs. Both are defined in AOFMSGSY.

TERMMMSG

Purpose

You can use the TERMMMSG generic routine to change the SA z/OS status of an application for which you have received a termination message. TERMMMSG can also call ISSUEREPLY to issue a reply if the termination message is a WTOR. Typically, TERMMMSG is called from the NetView automation table.

The status into which the application is placed by TERMMMSG depends on a number of conditions, including the values of the FINAL, ABEND, and BREAK parameters. The values of the FINAL, ABEND and BREAK parameters may in turn depend on the values of the CODE parameters. The following table shows the statuses which TERMMMSG may place an application in.

Table 9. TERMMMSG Status Transitions

Status	Description	Final	Abend	Break
STOPPING	Application terminated externally	N	N	N
ENDING	For transient applications	N	N	N
ABENDING	Application abend	N	Y	N
BREAKING	Non-recoverable abend	N	N	Y
STOPPED	Application shutdown externally	Y	N	N
ENDED	Transient application shutdown	Y	N	N
BROKEN	Non-recoverable abend	Y	N	Y
RESTART	Restart after abend	Y	Y	N
AUTOTERM	No change during shutdown	N	N	N
AUTODOWN or RESTART	System is being shutdown. The status will depend on the shutdown parameters.	Y	?	?
ZOMBIE	Occurs if there are problems with the address space cleanup.	Y	?	?

For information on how the CODE parameters can affect the values of F A and B see the description of the CODE parameter below.

TERMMMSG can be called from the NetView automation table, in which case no parameters are required, or from an automation procedure (CLIST), in which case the JOBNAME parameter must be supplied, and REPLY, PASSES, and CODE1, CODE2, and CODE3 parameters are ignored.

TERMMSG

126 for details. If it is monitorable, the application is not placed into a down status until an application monitor check confirms that it has left the machine. If it is not monitorable, the application is placed into a down status after its termination delay time.

NO

This is not the final termination message.

ABEND

Indicates whether or not the application is suffering a recoverable abend. If no ABEND value is coded, TERMMSG defaults to ABEND=NO.

YES

The application is suffering a recoverable abend. The application will be placed into the appropriate status, depending on the value of FINAL parameter. See Table 9 on page 126 for details.

When the final termination message for an abending application (FINAL=YES) is received, the error threshold is checked and the application is restarted if it has not exceeded its critical error threshold.

NO

The application is not suffering a recoverable abend.

BREAK

Indicates whether or not the application is suffering a non-recoverable abend. The application will be placed into the appropriate status, depending on the value of the FINAL parameter. If no BREAK value is coded, TERMMSG defaults to BREAK=NO.

YES

The application is suffering a non-recoverable abend and should be placed into BREAKING status. When its final termination message is received (FINAL=YES) it is placed into BROKEN status, from which SA z/OS will not restart it without human intervention through the SETSTATE command dialog.

NO

The application is not suffering a non-recoverable abend.

REPLY

This parameter determines whether ISSUEREP is called to reply to the message. If no REPLY value is coded and TERMMSG is called for a WTOR, TERMMSG defaults to REPLY=YES, otherwise it defaults to REPLY=NO.

YES

If the message triggering TERMMSG is a WTOR, ISSUEREP is called to reply to it.

NO

ISSUEREP is not called.

PASSES

This parameter is passed to ISSUEREP if it is called to reply to the message. If no PASSES value is coded, TERMMSG passes PASSES=NO to ISSUEREP.

YES

PASSES=YES is passed to ISSUEREP.

NO

PASSES=NO is passed to ISSUEREP.

CODE1 CODE2 CODE3

These codes are used to search the automation control file for an action that modifies the other parameters. At first the ACF is searched for 'subsystem msgid' entries. If these cannot be found, the ACF is searched for 'MVSESA msgid' entries. The meaning of the codes depends on the NetView automation table entry that invoked TERMMMSG. Valid actions are as follows:

Action	Final ?	Abend ?	Break ?
STOPPING	-	-	-
STOPPED	Yes	-	-
ABENDING	-	Yes	-
ABENDED	Yes	Yes	-
BREAKING	-	-	Yes
BROKEN	Yes	-	Yes

The codes are passed to ISSUEREP if it is called.

Restrictions and Limitations

- If a normal termination message (ABEND=NO,BREAK=NO) is received for an application that is not being shut down by SA z/OS (and is already in the AUTOTERM status), it is placed into STOPPING status. When its final termination message has been processed, its Restart option is checked. If this is ALWAYS it is placed into RESTART status, if not it will be placed into STOPPED status.

This behavior can be changed using the AOFRESTARTALWAYS advanced automation option.

- Once an application has entered a serious error condition (a status of AUTOTERM, STOPPING, ABENDING, or BREAKING), termination messages indicating less important error conditions are ignored.
- Commands for a status are only issued the first time the status is entered.
- If this command is called on a task other than the AOFWRKxx auto operator that is responsible for the subsystem, TERMMMSG will schedule itself to that AOFWRKxx auto operator. This means that when the calling procedure regains control, the status of the subsystem may not yet have changed.
- Only termination messages for applications with known address space IDs are processed by TERMMMSG.

The address space ID is not checked if TERMMMSG is called from an automation procedure (CLIST), or if HALTMSG has been triggered by message BPXF024I.

The address space ID is also ignored if the job name parameter that was specified differs from the job name associated with the triggering message.

Usage

If you are invoking TERMMMSG for a generic message you should use AOCFILT to screen the message before invoking TERMMMSG. See "AOCFILT" on page 107 for more information.

TERMMMSG traps should be used for most applications. This ensures early detection of any problems. A single entry for IEF404I can be used to process the final termination message for all applications.

TERMMSG

```
IF MSGID = 'IEF404I' & TOKEN(2) = SVJOB & DOMAINID = %AOFDOM%
THEN
DISPLAY(N) NETLOG(Y) SYSLOG(Y)
EXEC( CMD('TERMMSG FINAL=YES,JOBNAME=' SVJOB) ROUTE(ONE %AOFOPGSSOPER%));
```

Using the code entries can obviate the need to code multiple table entries or issue multiple commands from an entry.

```
IF MSGID = 'IEF450I' & TOKEN(2) = SVJOB & DOMAINID = %AOFDOM%
& TEXT = 'IEF450I' . 'ABEND=' SCODE UCODE
THEN
DISPLAY(N) NETLOG(Y) SYSLOG(Y)
EXEC CMD('TERMMSG JOBNAME=' SVJOB
',CODE1=' SVJOB ',CODE2=' SCODE ',CODE3=' UCODE)
ROUTE(ONE %AOFOPGSSOPER%);
```

If you specify `dispacf mvsesa ief450I`, a panel similar to the one following is displayed:

```
AOFK3D0X          SA z/OS - Command Response          Line 1   of 19
Domain ID   = IPSFN   ----- DISPACF -----          Date = 01/07/98
Operator ID = ROLI                                     Time = 14:56:33

Command = ACF ENTRY=MVSESA,TYPE=IEF450I,REQ=DISP
SYSTEM = KEY5          AUTOMATION CONFIGURATION DISPLAY - ENTRY= MVSESA
-----
AUTOMATION CONFIGURATION DISPLAY - ENTRY= MVSESA
TYPE IS IEF450I
CODE          = (*,S913,*, "BREAKING")
CODE          = (*,S306,*, "BREAKING")
CODE          = (AIMS,*,*, "BREAKING")
CODE          = (PIMS,*,*, "BREAKING")
CODE          = (IIMS,*,*, "ABENDING")
CODE          = (TIMS,*,*, "ABENDING")
CODE          = (AIMS*,*,U0002, "BREAKING")
CODE          = (PIMS*,*,U0002, "BREAKING")
CODE          = (IIMS*,*,U0002, "BREAKING")
CODE          = (TIMS*,*,U0002, "BREAKING")
CODE          = (*,S122,*, "STOPPED")
CODE          = (*,S222,*, "STOPPED")
CODE          = (*,S422,*, "STOPPED")
CODE          = (*,S522,*, "STOPPED")
CODE          = (TPX*,*,U0100, "BREAKING")
CODE          = (*,*,*, "ABENDING")
END OF MULTI-LINE MESSAGE GROUP

Command ==>
PF1=Help      PF2=End      PF3=Return    PF6=Ro11
PF9=Refresh   PF12=Retrieve
```

Figure 16. DISPACF Command Dialog Panel

If you are calling TERMMSG from an automation procedure, and this calling procedure is not running on the AOFWRKxx automation operator that is responsible for the affected subsystem, the TERMMSG routine will be routed to that operator. The TERMMSG routine will run asynchronously to the calling procedure. This means that when the calling procedure regains control, the status of the affected subsystem may not yet have changed.

TGLOALS

EHKVAR1 through EHKVAR9

When defining the commands or replies in the automation control file to be issued by generic routine TERMMSG, the variables &EHKVAR1 through

&EHKVAR9 can be used to be substituted by the tokens of the parsed message, which has driven TERMMSG. &EHKVAR1 will be substituted by the first token of the message text after the message ID, &EHKVAR2 with the second token and so forth.

TERMMSG

Chapter 5. Utilities

SA z/OS provides commands that you can use as system utilities. These commands are:

- INGDATA
- INGMON
- INGSTOBS
- INGTIMER
- INGVARS
- INGV TAM

Additional Parameters for System Operations Commands

The following parameters are available for a number of system operations commands:

TARGET

The TARGET parameter lets you specify the system where the command is to be processed. You can direct the command to:

- A particular system in the sysplex, or enterprise
- A subset of systems in the sysplex, or enterprise
- A sysplex
- All systems currently active in the local sysplex

The syntax is as follows:

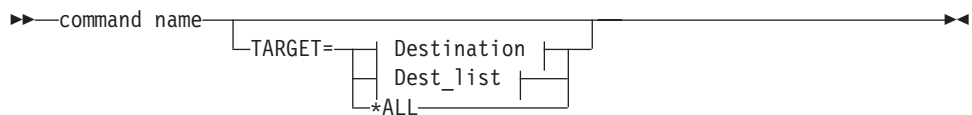

Destination:



Dest_list:



Where:

system_name
Specifies the name of the z/OS system

domain_ID
Specifies the NetView domain identifier

sysplex_name
Specifies the name of the sysplex

Additional Parameters for System Operations Commands

***ALL** SA z/OS specifies that the command should be routed to all SA z/OS systems that are currently active in the local sysplex.

Note, that not all of the commands that support the TARGET parameter also support the *ALL value. Refer to the respective syntax diagrams for information about whether *ALL is supported.

The search sequence is as follows:

1. System name within the local sysplex
2. Domain ID within the local sysplex
3. Local sysplex name

If it is a human operator, the search continues in the following sequence:

- Domain ID within the enterprise
- System name within the enterprise
- Sysplex name within the enterprise

If no value is specified, and the command does not refer to a defined resource, it is processed on the local system.

Note: The following only applies to commands that do **not** operate sysplex-wide.

If you do not specify the TARGET parameter, and the SA z/OS command refers to a defined resource, SA z/OS processing is as follows:

- If the resource is only defined on one active system, the command is routed to that specific system.
- When processing the command in line mode, SA z/OS checks whether or not the resource is defined on the local system. If it is, the command is processed locally. Otherwise, an error message is issued.
- If the resource is defined on more than one active system, and the command is not running on an autotask, SA z/OS displays the following selection panel where you can select the resource, or resources where the command is to be routed to:

If you enter `dispacf mvsesa` a panel similar to Figure 17 on page 135 is displayed.

Additional Parameters for System Operations Commands

```
AOFKSEL1          SA z/OS - Command Dialogs          Line 1 of 4
Domain ID = IPUFA  ----- DISPACF -----          Date = 06/27/00
Operator ID = NETOP1                               Time = 17:43:12

Multiple instances found for MVSESA in sysplex(es) AOCPLX
Select one or more items to be processed, then press ENTER.

      Sel  System  Domain
      ---  -
      -    AOCA   IPUFA
      -    AOCB   IPUFB
      -    AOCC   IPUFC
      -    AOCD   IPUFD
      -

Command ==>
PF1=Help      PF2=End      PF3=Return
PF6=Roll                                PF12=Retrieve
```

Figure 17. Resource Selection Panel 1 -- Non-sysplex-wide

If the target is within the local sysplex, the communication method is via XCF facilities. Otherwise, the NetView RMTCMD command is used. Sysplex-wide commands are processed locally.

Note: The following only applies to sysplex-wide commands.

If a target is specified and the resource is not defined on the specified system, SA z/OS issues an error message.

If you enter `ingvote stdt000*` a panel similar to Figure 18 on page 136 is displayed.

Additional Parameters for System Operations Commands

```

AOFKSEL4          SA z/OS - Command Dialogs          Line 1 of 32
Domain ID = IPUFA  ----- INGVOTE -----          Date = 06/27/00
Operator ID = NETOP1                               Time = 17:50:39

Multiple instances found for STDT000*
Select one item to be processed, then press ENTER.

Sel  Name          Type System  Description
-----
-   STDT000AN00    APL  AOCA    Parent for all STD* appl 05/16/00 06:25
-   STDT000AN00    APL  AOCC    Parent for all STD* appl 05/16/00 06:25
-   STDT000AN00    APL  AOCC    Parent for all STD* appl 05/16/00 06:25
-   STDT000AN00    APL  AOCC    Parent for all STD* appl 05/16/00 06:25
-   STDT000AN1A    APL  AOCA    Child of AN10 (child tree --- AN1B)
-   STDT000AN1A    APL  AOCC    Child of AN10 (child tree --- AN1B)
-   STDT000AN1A    APL  AOCC    Child of AN10 (child tree --- AN1B)
-   STDT000AN1A    APL  AOCC    Child of AN10 (child tree --- AN1B)
-   STDT000AN1B    APL  AOCA
-   STDT000AN1B    APL  AOCC
-   STDT000AN1B    APL  AOCC

Command ==>
PF1=Help      PF2=End      PF3=Return
PF6=Roll      PF8=Forward   PF12=Retrieve
  
```

Figure 18. Resource Selection Panel 2 -- Sysplex-wide

OUTMODE

This parameter lets you specify the output mode of a command. The syntax is as follows:

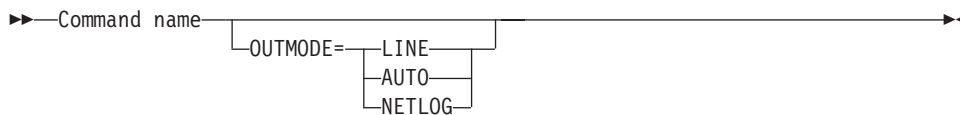

LINE

If you specify LINE, the output is displayed in line mode, independent of the task type. Further characteristics are:

- No color attributes are set for data that is shown in line mode.
- The sequence of the fields may be different in line mode than in full-screen.
- Not all fields from the full-screen display may be shown in line mode.
- Line mode output is shown in a multiline message.
- Line mode output is not processed by the message automation table and is not written to the netlog. To obtain output from a command such as DISPSTAT in the netlog, use a PIPE command, for example:

```
PIPE NETV DISPSTAT OUTMODE=LINE | LOGTO NETLOG
```
- Line mode output cannot be processed by a TRAP and WAIT.
- System operations commands can be issued within a NetView PIPE by using the OUTMODE=LINE parameter, unless noted otherwise in the command description.
- System operations commands supporting the OUTMODE=LINE option can be used in user-written clists. Note however, that the format of the output may change for follow-on Releases.
- If you work with OUTMODE=LINE no prompt panel is displayed.

Additional Parameters for System Operations Commands

- If no value is specified, the decision whether to display the command output by means of a full-screen panel or in line mode is based on the NetView task type the command is running on.

AUTO

Specifies that, when the task that the clist runs on is unattended, the output of the command is written to the NetView netlog. Otherwise the output is written to the console.

NETLOG

Specifies that the output of the command is written to the NetView netlog

OUTDSN

This parameter lets you specify the name of the data set that is to contain the output of the command. You can specify a sequential data set or a member of a partitioned data set. The minimum record length is 80 bytes, except for the DISPSTAT and INGLIST commands where the minimum record length is 256 bytes. The data set must already exist. The OUTDSN parameter forces OUTMODE=LINE.

INGDATA

Purpose

The INGDATA command returns detailed information that the automation manager maintains for the specified resources. The data is returned as a multiline message, one line for each resource.

The format is as follows:

Byte	Length	Description
1	11	Name of resource
14	3	Resource type, for example, APG or APL
19	8	Name of system hosting resource
29	11	Observed status
41	12	Desired status
54	10	Automation status
65	4	Automation flag
70	4	Hold flag
75	48	Description
125	10	Start type
137	8	Stop type
147	8	Service period name
157	8	Trigger name
167	12	Compound status
181	10	Startability status
193	8	Resource nature (group type)
203	8	Category (application type)
213	10	Subtype (application subtype)
224	10	Health status

Parameters

monitor

This is the name of the monitor resource. It can be specified in automation manager notation (for example, SAPMON/MTR/AOC8) or in agent notation.

STATUS

This is the new state that the monitor has determined. The state represents either the health status of the objects that the monitor is watching, or the state that the monitor is in. The latter can be one of the following:

INACTIVE	The monitor is not running.
FAILED	The monitor has failed. Recovery may be in progress. No acceptable health status was provided.
BROKEN	Both the monitor and recovery failed. This is a permanent condition. The monitor will not be re-invoked.

The health status of the object, or objects, that the monitor is watching are as follows, from the least to the most serious:

UNKNOWN	The health status is not yet available.
NORMAL	The monitor has obtained good results from the object, or objects, that it is watching.
WARNING	The monitor detected a certain degree of degradation in the operation of the monitored object.
MINOR	The same as WARNING, but more severe.
CRITICAL	The same as MINOR, but more severe.
FATAL	The same as CRITICAL, but more severe.

MSG

This defines the message that is associated with the new health status.

<i>message</i>	The message must be enclosed in parentheses, or single or double quotation marks. If not present, text will be constructed from whatever is in the default safe.
NONE	No message is associated with the status.

Return Codes

- 0 Okay.
- 1 An error occurred.

Usage

Examples

INGSTOBS

Purpose

The INGSTOBS routine lets you subscribe as a status observer for one or more resources. Whenever a status change occurs, the automation manager sends you a notification. The following five statuses are applicable:

INGSTOBS

Observed	Is the current status of the resource monitored by the automation manager.
Desired	Is the status the resource should be in. The automation manager attempts to put the resource into this state. This is also called the 'goal' of the resource.
Automation	Is the current status of the resource within the automation process of SA z/OS.
Compound	Is the summary of all statuses and a few other indicators.
Startability	Indicates whether the resource is ready to be started when a start command is issued.

To register as a status observer, specify the name of a REXX exit. SA z/OS invokes this exit for each status change. The following parameters are passed to the exit:

- The name of the resource, for example, TSO/APL/SYS1
- The observed status
- The automation status
- The desired status
- The compound status
- The startability status
- The health status

The parameters are separated by a comma.

Format

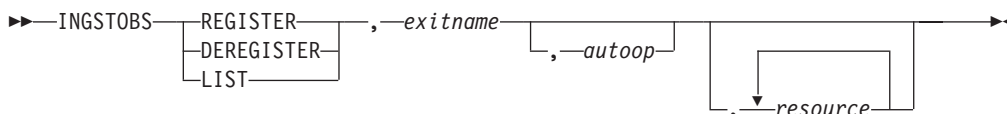

Parameters

REGISTER

Performs the subscription by linking the specified exit to each resource specified.

Each subsequent status change of the resource triggers the exit to be invoked.

DEREGISTER

Breaks the link between the exit and the resource. The exit is no longer invoked if a status change of the resource occurs.

LIST

Displays the resources that are subscribed and linked to the specified exit.

exitname

Specifies the name of the REXX exit to be invoked when a status change of the resource occurred.

autoop

Is the automated function from which the autotask name is defined. The exit is scheduled to run on the autotask associated with the automated function. If omitted, the exit runs on the SA z/OS task responsible for communicating with the automation manager. It is recommended to use a different task.

resource

Specifies the name of the resource or family of resources, via wildcard, for example, TSO/APL/*. The resource names must be separated by a blank. Alternatively, the list of resources can be passed to the common routine with a NetView default Pipe Safe.

The parameters must be separated by a comma.

Restrictions

The INGSTOBS command can only be issued for a local system.

Examples

To register TEST2 as a status observer exit for all resources starting with CICS, specify:

```
INGSTOBS REGISTER,TEST2,MSG2OPER,CICS*/APL/AOC8
```

When the exit is invoked it runs on the autotask associated with the MSG2OPER automated function:

To display the resources that are associated with the status observer exit TEST2, specify:

```
INGSTOBS LIST,TEST2
```

Table 10. Exits and associated resources

Resource	Exits
CICS1LST/APL/AOC8	TEST2/MSG2OPER
CICS1P21/APL/AOC8	TEST2/MSG2OPER
CICS1P22/APL/AOC8	TEST2/MSG2OPER
CICSD11/APL/AOC8	TEST2/MSG2OPER
CICSD12/APL/AOC8	TEST2/MSG2OPER
CICSD13/APL/AOC8	

INGTIMER

Purpose

The INGTIMER command links NetView timer commands to subsystems. This means that the timer is only active when the subsystem is active. When the subsystem terminates, the timer commands are automatically purged. To deactivate the timers at SHUTINIT time, the INGTIMER subsystem PURGE command can be specified as a SHUTINIT command.

Format

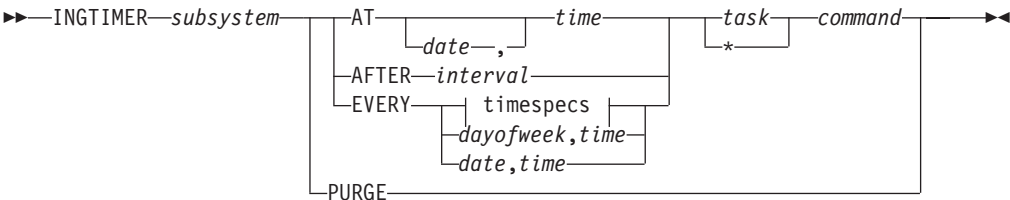

timespecs:

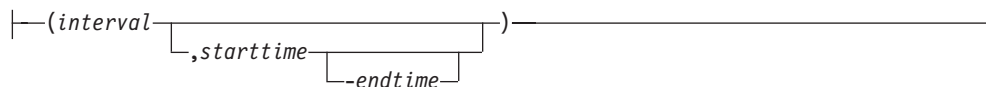

Parameters

subsystem

Specifies the name of the subsystem.

AT

Specifies the start time of the command.

AFTER

Specifies the time interval that must elapse after the subsystem became active. When this time interval has elapsed, the command is run. For example, if the subsystem becomes active at 12:00 am and you specify 2 hours, the command runs at 2:00 pm.

EVERY

Specifies the times when the command is to be repeated between the start time and end time.

PURGE

Specifies that all timers associated with the subsystem are purged.

date

Specifies the date, in mm/dd/yy format, on which the command should run. The date can begin with one or more Xs.

time

Specifies the time at which the command is to run. The format is hh[:mm[:ss]]. Instead of entering digits, one or more Xs can be specified at the beginning. If the time begins with an X or multiple Xs instead of a number, the command is set to begin at the next increment of time.

interval

Specifies the time interval that is to elapse before the command is run. The format is hh[:mm[:ss]]. Minutes and seconds are optional values.

starttime

Specifies the start time of the command, which is when it is to be run for the first time. The format is hh[:mm[:ss]]. Minutes and seconds are optional values. The specified time can be earlier than the current time. The command is then run at the next regular interval after the current time, with intervals calculated based on the start time. If the time begins with an X or multiple Xs instead of a number, the command is set to begin at the next time increment.

endtime

Specifies the time when the interval is to end. The format is hh[:mm[:ss]]. Minutes and seconds are optional values. Applies only when the interval is shorter than 24 hours.

dayofweek

Specifies the day of the week when the timer command should run. Specify MON through SUN, WEEKDAY, WEEKEND, or ALL.

date

Is the date, in mm/dd/yy format, on which the command should run. The date can begin with one or more Xs.

task

Specifies the operator from whose user ID the command is to be executed. It can also be an automated function. The default is the work operator associated with the subsystem. The timer itself runs on the PPT task.

- * Is a placeholder which indicates that the default is used. The default is the work operator associated with the subsystem.

command

Specifies which command is to be issued when the timer expires.

All timers are converted to the NetView CHRON command format. Thus, daylight-saving-time switching is supported. The timer runs on the PPT task.

Note: Storing the timer in the NetView save/restore database is pointless because the timer is only active while the subsystem is in an UP state.

Restrictions

None.

Usage

To link a timer to a subsystem, the user has to register the NetView timer command as follows:

- At subsystem post-start time. This associates the timer command with the subsystem and activates the timer.
- Whenever NetView is restarted. This activates the timer command again.

The timers are only in effect when the subsystem for which they are defined is active. This is useful for applications that can be moved within the sysplex.

Examples

To issue a command that should run every 30 minutes between 10:00 am and 2:00 pm, specify the following:

```
INGTIMER TSO EVERY (00:30,10:00-14:00) * F MVS &SUBSJOB,GETLSEQ
```

To issue a command that should run 10 minutes after a certain subsystem became available, specify the following:

```
INGTIMER &SUBSAPPL AFTER 00:10 * BROADCAST Subsystem is now active
```

To issue a command that should run each Friday at 5:00 pm, specify the following:

```
INGTIMER &SUBSSYS EVERY FRI,17:00 PPT MVS D T
```

INGVARS

Purpose

The INGVARS command is the interface for you to either get or set a shared variable. The shared variable can be associated with an application resource, a system or the sysplex itself.

Format

INGVARS

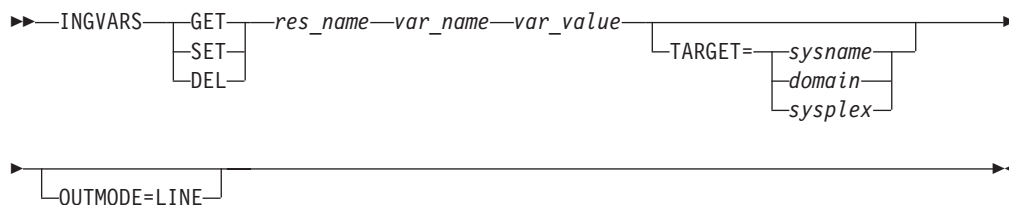

Parameters

GET

Obtains the shared variables.

SET

Sets the shared variable. Passing a null string resets the variable.

DEL

Deletes the variable.

res_name

The name of the resource in automation manager format, for example, TSO/APL/AOC8. A wildcard can be specified.

var_name

The name of the variable. Maximum length is 32 bytes. Can be a wildcard, for example, abc*, *abc or *abc*. The variable name cannot contain a comma.

var_value

The value of the variable. Only applicable for the SET function. The value can contain embedded blanks or a keyword/value pair. The value is stored in character format.

TARGET

For information on the TARGET parameter, refer to "Additional Parameters for System Operations Commands" on page 133.

OUTMODE

For information on the OUTMODE parameter, refer to "Additional Parameters for System Operations Commands" on page 133.

Assigning shared variables to resources provides an automatic cleanup of the shared variables. If the resource that the shared variable is associated with is removed (for example, due to an INGAMS refresh), the shared variables are automatically removed as well.

The automation manager provides the following "anchor points" for a shared variable:

Application resource

TSO/APL/sysname - this can also be a group resource, for example, CICS/APG

System

Resource sysname/SYS/sysname

Sysplex

Resource SYSPLEX/GRP

Restrictions

None.

Usage

Since the automation manager has knowledge of all resources in the sysplex and the automation manager object structures are maintained in a persistent manner, it provides an excellent base for shared variable support.

The automation manager is thus used to manage shared variables. These variables are persistent across automation manager sessions and takeovers. The shared variables are stored in the takeover file (VSAM) or, when exploiting MQ, in the MQ State queue. Only when doing a warm or cold start are the shared variables wiped out.

Examples

Line-mode Output

Figure 19 shows the result of the GET function. The first column is the resource name, the second column is the variable name and the third column is the value of the shared variable.

```
>> ingvars get child* wal* outmode=line
CHILD11/APL/AOC8      WALTER      BOEBLINGEN
CHILD31/APL/AOC8      WALTER      SCHUEPPEN
CHILD31/APL/AOC8      WAL         OFFENBURGERSTR
*** End of Display ***
```

Figure 19. INGVARS Command Line-mode Output

INGVTAM

Purpose

The INGVAM command lets you:

- Register an application with VTAM application node recovery.
- Issue recovery commands for all applications registered with VTAM application node recovery when VTAM has restarted.
- List applications that are registered for application node recovery.
- List major nodes that are in use by applications.

Format

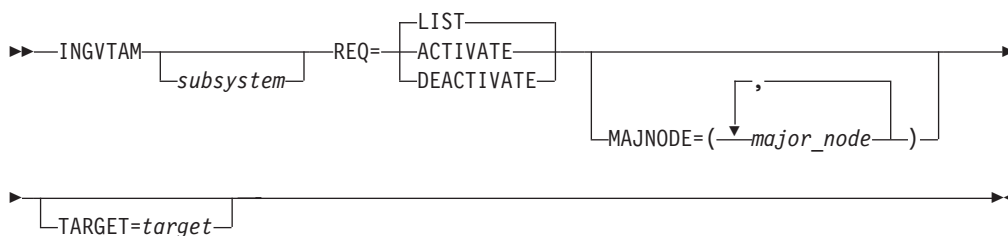

Parameters

subsystem

The subsystem parameter specifies the name of the subsystem that is registering with SA z/OS VTAM application recovery. This parameter is

required with REQ=ACTIVATE to register a subsystem. If it is omitted with REQ=ACTIVATE, all subsystems currently registered will have the VTAMUP message command policy driven to allow them to take actions when VTAM is restored to active service. This parameter is required with REQ=DEACTIVATE.

REQ

Specifies the request. It can be one of the following:

LIST If no subsystem is specified, it lists all subsystems registered for VTAM application node recovery. If a subsystem is specified, it lists all the major nodes registered for that subsystem.

ACTIVATE

If the subsystem parameter is specified, it registers the list of major nodes as specified in the MAJNODE= parameter and issues VTAM ACTIVATE commands for them. If the subsystem parameter is not specified, REQ=ACTIVATE issues the commands in the messages policy VTAMUP for every subsystem that is registered for application node recovery.

DEACTIVATE

A subsystem must be specified for this request. This request issues VTAM INACT commands for the major nodes that were previously registered. INACT commands are not issued for any major node that contains model resources or is in use by another registered application.

TARGET

For information on the TARGET parameter, refer to “Additional Parameters for System Operations Commands” on page 133.

Return Codes

- 8 Error.
- 4 Warning (Vary command failed).
- 0 Normal End.

Restrictions

To use the INGV TAM command system operations must be initialized.

Note: If the SA z/OS NetView is not the networking NetView, the INGV TAM command and application node recovery only work partially. INGV TAM cannot issue NODEUP message policy commands when a registered major minor node is reactivated and VTAM issues the IST093I message. All other functions of the INGV TAM command and application node recovery work with separate SA z/OS and networking NetViews.

Usage

It is recommended that you issue the REQ=ACTIVATE and REQ=DEACTIVATE commands on the same system as the subsystems concerned. It is recommended that you place REQ=ACTIVATE in the application’s PRE-START and A CORESTART policies. However, REQ=DEACTIVATE should be placed in the applications SHUTFINAL policy. For the VTAM subsystem, the INGV TAM REQ=ACTIVATE command should be defined to the UP message policy as a command.

Examples

If you enter `INGVTAM subsystem REQ=LIST` the output looks similar to Figure 20.

Figure 20. INGVTAM REQ=LIST Output

```
List of subsystems registered with VTAM
Subsystem      Subsystem      Subsystem
EYUCMS1A
*** End of Display ***
```

To register a subsystem for application node recovery, specify, for example:

```
INGVTAM &SUBSAPPL REQ=ACTIVATE MAJNODE=(IPSMBC)
```

To deregister a subsystem for application node recovery, specify, for example:

```
INGVTAM &SUBSAPPL REQ=DEACTIVATE
```

Part 3. SA z/OS I/O Operations Commands

Chapter 6. I/O Operations Commands (API)	151	QUERY RELATION CNTLUNIT	202
Using I/O Operations Commands for Programming	151	QUERY RELATION DEV	202
Calling the I/O Operations API	151	QUERY RELATION HOST	203
Safe Switching	152	QUERY RELATION SWITCH	204
FICON Switches	153	QUERY SWITCH	205
FICON Cascaded Switches	153	REMOVE and RESTORE CHP.	208
Common Elements	154	REMOVE DEV and RESTORE DEV	211
Common Syntax Elements	154	WRITEFILE	217
Common Parameters	155	WRITEPORT	219
Common Query Commands Syntax	159	WRITESWCH	224
Common Output Header	161		
Common Output Format	162	Chapter 7. Invoking I/O Operations with a REXX EXEC.	231
DELETE FILE	167	Rules for Calls by a REXX EXEC	231
QUERY ENTITY CHP	168	Literal Values	231
QUERY ENTITY CNTLUNIT	173	Optional Variables.	231
QUERY ENTITY DEV	176	Two Examples of REXX EXEC Calls	232
QUERY ENTITY HOST	179	Generalized Example of a REXX EXEC Call	232
QUERY ENTITY SWITCH	183	Calling a Program that Uses the CALL Macro	233
QUERY FILE	186	Calling a Program that Uses IHVAPI2	234
QUERY INTERFACE CNTLUNIT.	187	Calling a Program that Uses IHVAPI	236
QUERY INTERFACE SWITCH	193		
QUERY RELATION CHP	201		

This part describes SA z/OS I/O operations commands that are available through the API only.

For general information about the SA z/OS commands, refer to *System Automation for z/OS User's Guide*.

All commands described in *System Automation for z/OS Defining Automation Policy* are also available through the API.

Chapter 6. I/O Operations Commands (API)

Using I/O Operations Commands for Programming

In addition to the I/O operations commands described in *System Automation for z/OS Operator's Commands*, the following commands are available to programmed API calls:

- DELeTe File
- Query Entity Chp
- Query Entity CntlUnit
- Query Entity Dev
- Query Entity Host
- Query Entity Switch
- Query File
- Query Interface CntlUnit
- Query Interface Switch
- Query Relation Chp
- Query Relation CntlUnit
- Query Relation Dev
- Query Relation Host
- Query Relation Switch
- Query Switch
- Remove and Restore Chp
- Remove and Restore Dev
- WRITEFILE
- WRITEPORT
- WRITESWCH

Calling the I/O Operations API

I/O operations application program interfaces support:

- Invocations from an EXEC written in the REXX programming language.
- Invocations from a user program written in a language that adheres to the Assembler Language CALL macro interface conventions used by MVS/ESA. This type of caller is referred to as a program that uses the CALL macro. For information on the CALL macro, refer to *MVS/ESA Application Development Macro Reference*. These callers can invoke IHVAPI; however IHVAPI2 is recommended.
- All variables, except arrays, data blocks, tables and tokens, must be in uppercase.
- Programs that use the CALL macro to invoke IHVAPI2 (preferred for the following reasons):
 - IHVAPI2 lets the caller choose between managing the command response area or letting I/O operations do so. IHVAPI requires the user to manage the response area.
 - IHVAPI2 can return data in a response area that exceeds 64KB; IHVAPI cannot.
 - IHVAPI2 accepts all the variables needed by the I/O operations commands, including multisystem commands. IHVAPI accepts only 24-character variables as input parameters except those that specify an array, data block, or table. For those operands, it accepts a variable long enough to contain the array or table.

- Tokens
- The MVS REXX Call invocation in addition to the Address Link invocation.
- TSO/E (optional). For further information about how to invoke I/O operations by a REXX EXEC call, refer to Chapter 7, “Invoking I/O Operations with a REXX EXEC,” on page 231.

General Information About the Response Area

For most commands, I/O operations returns data to the caller in a response area.

The Data In the Response Area: When data is returned in the response area, it is either a single record or a concatenation of records in character or hexadecimal format, or both, which overlays any previous data.

For most commands, I/O operations returns at least one message in the response area. However, there are exceptions. For example, the multisystem commands can return no data, one or more messages, or a data block. Also, failed commands do not always return data in the response area.

When I/O operations returns a message, the first 3 characters are IHV, which identify I/O operations. Although the messages resulting from most commands are concatenated, up to four blank 80-character records can intervene between two successive I/O operations messages.

The Length of the Response Area: The amount of data that can be returned by a multisystem command can be very large, so the following approximate maximum lengths are provided.

For DISPLAY DEVICE, DISPLAY RESULTS, and DISPLAY VARY commands, assume that 65,528 bytes (64KB) suffice.

For REMOVE DEV, RESTORE DEV, and the QUERY commands, calculate $100 + (1 + x) * y * z$, where:

- x One of the following:
 - The number of objects in a QUERY ENTITY, REMOVE DEV, or RESTORE DEV command
 - The number of interfaces in a QUERY INTERFACE command
 - The number of paths in a QUERY RELATION command (in this context, number is the number from one host’s perspective).
- y Number of hosts scoped in the command
- z Size of the output row (the following sizes are approximations):
 - z 250 for a REMOVE DEV or RESTORE DEV command
 - z 300 for a QUERY ENTITY or QUERY INTERFACE command
 - z 500 for a QUERY RELATION command

For all other commands, assume that 25,600 bytes (24KB) suffice.

For invocations by a REXX EXEC, the final size should be doubled because I/O operations uses the IRXEXCOM facility to access ihvrc, ihvreas, and ihvresp, and it uses the STORE function of IRXEXCOM to set them.

Safe Switching

I/O operations varies paths online or offline when, because of port manipulation, the path from a channel to a device either becomes valid or is no longer valid.

The term *safe-switching* means that *all* vary path offline requests due to an I/O operations connectivity command are backed out if *one* of these requests fails and BACKOUT was specified at command invocation. All requests means those requests on all systems that have access to the switch (or switches) that are affected by the command.

For FICON® switches, safe-switching also includes the entire vary process for connectivity commands that affect Inter-Switch-Link ports (E-ports). Because I/O operations does not know the topology between the entry switch and the destination switch of a path, paths that go through an ISL link will not be varied when an E-port is the target of a connectivity command.

The following conditions result in the failure of a request:

- A vary path offline request fails when the request would disable the last path to a device that is currently in use.
- If no VTAM connection could be established between two systems that have access to a switch and run I/O operations, then I/O operations on the local system (that is, where the command is entered) assumes that the command fails on the remote system.

To avoid this, exclude this system from consensus processing using the command RESET HOST *vtamname* PURGE.

- For other reasons refer to the section "Making Connectivity Changes" in Appendix A, "Definitions for I/O Operations Commands" in *System Automation for z/OS Operator's Commands*.

FICON Switches

FICON switches allow imbedded space characters on port names. Consequently, I/O operations will no longer issue message IHVD106I when detecting imbedded blanks in port names of FICON switches.

However, I/O operations does not support imbedded blanks on port names, either in the ISPF dialogs or in the console command interface. The reason is that generic names and port names must not contain imbedded blanks when used in I/O operations console commands.

FICON Cascaded Switches

I/O operations supports cascaded switches with some restrictions:

1. For CTC connections on cascaded switches, I/O operations can neither display CTC control unit data nor manage CTC devices. The reason for this is that when I/O operations attempts to determine the attached NDs of such a device, it can get stuck behind a never-ending channel program on the device.
2. The Block command is not supported on Inter-Switch-Link ports (E_Ports). When an E_Port is affected by the command, it is rejected with return code 8 and reason code X'49'. In addition, the message IHVC913I is issued, showing the first or only port that is affected by the command.
3. All other I/O operations commands affecting E_Ports (Allow, Prohibit, Unblock, WRITEPORT and WRITESWCH) must specify the command option IGNore when an E_Port is involved. Otherwise the command is rejected with return code 8 and reason code X'49'. In addition, the message IHVC913I is issued, showing the first or only port that is affected by the command.

The IGNore option makes the issuer of the command aware that *safe-switching* can no longer be guaranteed.

4. If an attached Node Descriptor of a device cannot be determined because the path or channel is offline, the Display Device command does not show any control unit data for the particular channel path id.
5. A dynamic configuration change that results in the allocation or deallocation of a cascaded switch is currently *not* supported.

Note: It is recommended that all switches are defined to the Hardware Configuration Definition (HCD) including their device numbers. This allows I/O operations to show the LSN also for cascaded switches.

Common Elements

Many of the commands described in this chapter share several elements (such as syntax, parameters, output headers, etc) that are described in this section. To help make the command descriptions that follow a little clearer, the descriptions of these common parameters will not be repeated. Instead, you will be referred to the relevant part of this section.

The common elements are:

- various syntax elements, see “Common Syntax Elements”
- various parameters, see “Common Parameters” on page 155
- the syntax for Query Entity/Interface/Relation commands, see “Common Query Commands Syntax” on page 159
- output header for all Query Entity/Interface output structures, see “Common Output Header” on page 161
- output for all Query Relation commands, see “Common Output Format” on page 162

Common Syntax Elements

The following syntax elements are common to several commands:

- Object Format
- Single_object_identifier
- Range_object_identifier
- Scope
- Host_object_identifier

In the syntax diagrams for the commands in this chapter these syntax elements are shown only as syntax fragments.

Object Format:

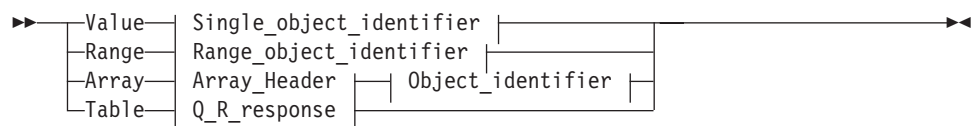

Single_object_identifier:

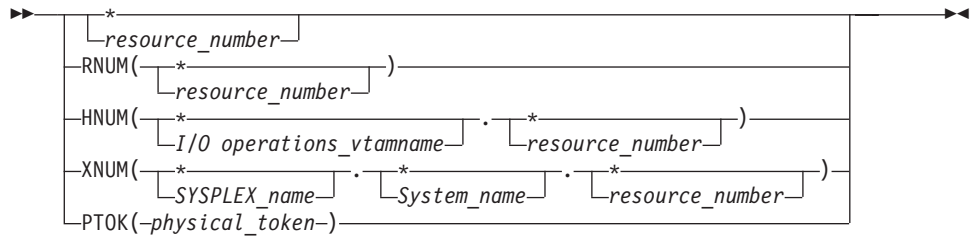

Range_object_identifier:

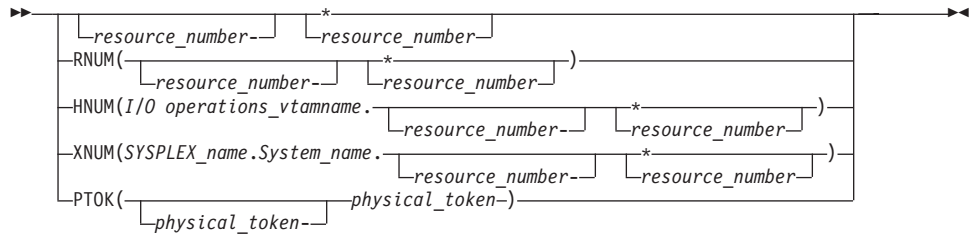

Scope:

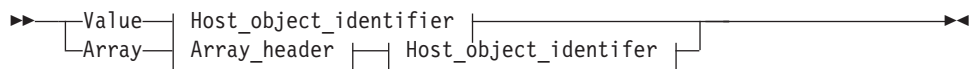

Host_object_identifier:

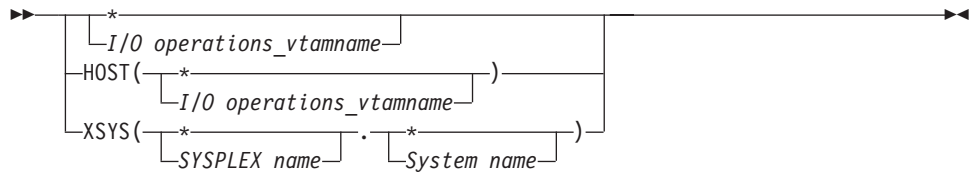

Common Parameters

These common parameters are:

- Object Identifier (see "Object Identifiers" on page 156):
 - Value
 - Range
 - Array
 - Table
- I/O resource identifiers (see "I/O Resource Identifiers" on page 156):
 - RNUM
 - HNUM
 - XNUM
 - PTOK
 - L TOK
- Host identifiers (see "Host Identifiers" on page 158):
 - HOST
 - XSYS
 - SCOPE

Object Identifiers

Value *value* | *

Specify V or VALUE. Then, specify either a single *element* or * for all *elements* known to the issuing I/O operations. (If * is specified, output array elements are sorted by searched element.)

Note: An element can either be a CHIPID, CONTROL UNIT or a DEVICE NUMBER.

Range *lower-upper* | *lower*-*

Specify R or RANGE. Specify the lower limit, followed by a hyphen, followed either by the upper limit of the range or an asterisk '*' to specify the highest number. Output array elements are sorted by number.

Array

Specify A or ARRAY. The output of array elements is returned in the input order. Specify the input array in the following format:

Notes:

1. Up to 32767 (decimal) CHIPIDs can be entered for CHP, but for CNTLUNIT and DEV the overall size is restricted to 32000 control unit numbers or device numbers respectively.
2. SA z/OS continues to support the ESCON[®] Manager Release 2 format for input arrays. For information about this format, see *Using the Enterprise Systems Connection Manager*.

Table 11. Standard SA z/OS Array Format

Offset					
Dec	Hex	Type	Len	Name(Dim)	Description
0	(0)	UNSIGNED	4	NUM_ROWS	Number of elements
		1... ..		FMT	Array format
					1 = SA z/OS formatted array
4	(4)	UNSIGNED	1	FMT_ID	Format identifier. Only 0 is valid for SA z/OS arrays
5	(5)	CHARACTER	3	*	Reserved
Array elements					
8	(8)	CHARACTER	38	OBJ_ID(*)	Object identifier

Table

Specify T or TABLE. Requires CODE=1 and the RESPONDER host application name must match the scope host name to be operated on. The table format is identical to the output format of a QUERY RELATION command.

I/O Resource Identifiers: An I/O resource identifier type can be one of the following:

RNUM

RNUM is an identifier value that is a resource number. All I/O resource object types have a resource number. Each object type specifies it differently, such as:

CHP Channel path identifier

CU Control unit number

DEV Device number

SWITCH

Switch device number

The value for RNUM must be from 1 to 4 hexadecimal characters or an asterisk (*).

Examples:

```
*
40
40-*
40-4F
RNUM(*)
RNUM(100)
RNUM(100-*)
RNUM(100-10F)
```

HNUM

HNUM is an identifier value that is qualified by an I/O operations host name. It is a specific host's resource number. HNUM must be 1 to 8 alphanumeric characters for the host name (or be an asterisk), followed by a period (.), followed by 1 or 2 hexadecimal characters for the resource number (or be an asterisk).

Examples:

```
HNUM(*.*)
HNUM(*.40)
HNUM(H1.*)
HNUM(H1.40)
HNUM(H1.40-*)
HNUM(H1.40-4F)
```

XNUM

XNUM is an identifier value that is qualified by a sysplex name and a system name. It is a specific sysplex system's resource number. XNUM must be 1 to 8 alphanumeric characters for the sysplex name (or be an asterisk), followed by a period (.), followed by 1 to 8 alphanumeric characters for the system name (or be an asterisk), followed by a period (.), followed by 1 or 2 hexadecimal characters for the resource number (or be an asterisk).

Examples:

```
XNUM(*.*.*)
XNUM(*.S1.40)
XNUM(X1.*.40)
XNUM(X1.S1.*)
XNUM(X1.S1.40)
XNUM(X1.S1.40-*)
XNUM(X1.S1.40-4F)
```

PTOK

PTOK is an identifier value that is a physical token. PTOK is a 32-character field. Refer to *System Automation for z/OS Operator's Commands* for further information about physical tokens.

Examples:

```
PTOK(.... 009032002IBM0200000000000100)
PTOK(.... 009032002IBM0200000000000100-....009032002IBM02000009999999900)
```

LTOK

LTOK is an identifier value that is a logical token. LTOK is a 32-character field. Refer to *System Automation for z/OS Operator's Commands* for further information about logical tokens.

Examples:

```
LTOK(0123456789ABCDEF0123456789ABCDEF)
LTOK(0123456789ABCDEF0123456789ABCDEF-0123456789ABCDEF0123456789ABCDEF)
```

Host Identifiers: A host identifier type can be one of the following:

HOST

HOST is an identifier value that is an I/O operations's VTAM application name. HOST must be from 1 to 8 alphanumeric characters for the host name (or be an asterisk).

Examples:

```
HOST(*)
HOST(H1)
HOST(H1-*)
HOST(H1-H9)
```

XSYS

XSYS is an identifier value that is a sysplex name, or a system name, or both. The rules are:

- If both a sysplex name and system name are specified, then only that system in the sysplex is considered for the command
- If a specific sysplex name is specified, then only the systems in that sysplex are considered for the command
- If a specific system name is specified, then only the systems with that name are considered for the command

XSYS must be from 1 to 8 alphanumeric characters for the sysplex name (or be an asterisk), followed by a period (.), followed by 1 to 8 alphanumeric characters for the system name (or be an asterisk).

Examples:

```
XSYS(*.*)
XSYS(*.S1)
XSYS(X1.*)
XSYS(X1.S1)
XSYS(*.S1-*)
XSYS(*.S1-S9)
XSYS(X1.S1-*)
XSYS(X1.S1-S9)
```

SCOPE

SCOPE specifies the set of I/O operations hosts that respond to a multisystem command.

NOPATHTEST

No checking is done on the command to verify that the path from the CHPID to the device exists.

Note: For QUERY RELATION HOST, the NOPATHTEST option is only valid on the QUERY RELATION HOST to Device command.

PATHTEST

If you specify Pathtest on the command, then checking is done to verify that the device is physically there with relation to each CHPID.

Note: For QUERY RELATION HOST, the PATHTEST option is only valid on the QUERY RELATION HOST to Device command.

Notes:

1. When ARRAY is the *Object_format_type*, the *Object_Identifier_Types* can be mixed and every *Object_Identifier_Type* must match the class of the specified *Object_Type* (all must be I/O_resources or all must be Hosts). For example, Q E HOST can accept only HOST and XSYS entries in the array.
2. The Array_header contains the number of elements in the array.

3. PTOK is valid with RANGE but you should be fully aware of PTOK structure. For example, RANGE PTOK could be used to specify all of the serial numbers of a certain type of device. However, certain PTOK values may cause unpredictable results with RANGE.
4. When ARRAY is the *SCOPE_format_type*, the *Host_Object_Identifier_Types* can be mixed (HOST and XSYS).
5. Output from a QUERY ENTITY command consists of a header, which is identical for each entity with the exception of the “Eye-Catcher” (offset 0), followed by the substructures, which are unique to each type of entity.
6. If not otherwise stated at the particular command descriptions no input port information is returned by a QUERY RELATION command when the command specifies a switch that is the destination switch of a cascaded switch pair.

Common Query Commands Syntax

The following syntax is common for all Query Entity/Interface/Relation commands.

(Host_)Entity_Object:

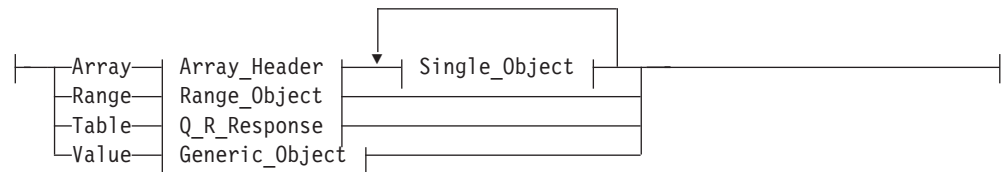

Interface_Object:

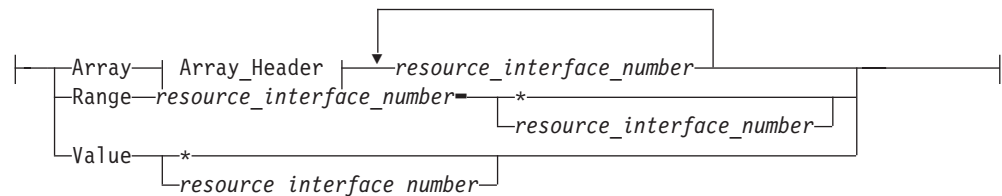

(Host_)Relation_Object:

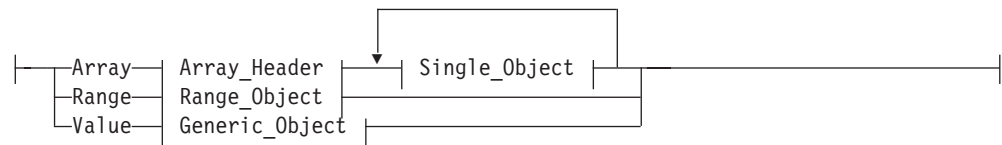

Single_Object (when object type is I/O resource):

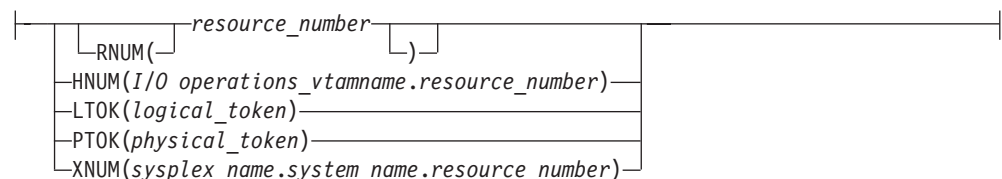

Single_Object (when object type is HOST):

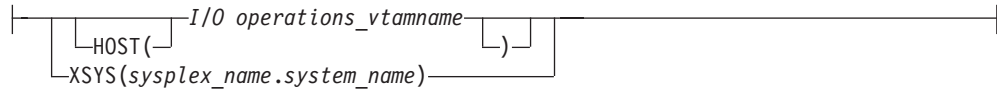

Generic_Object (when object type is I/O resource):

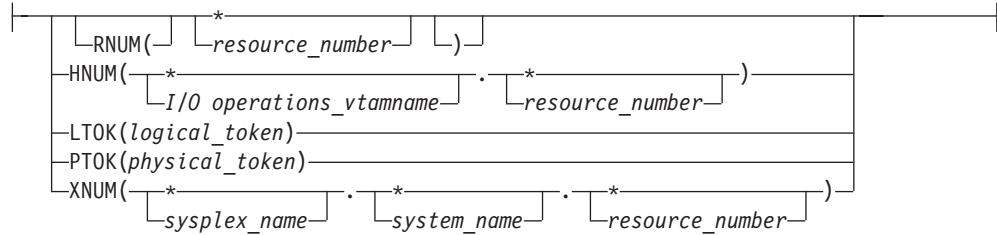

Generic_Object (when object type is HOST):

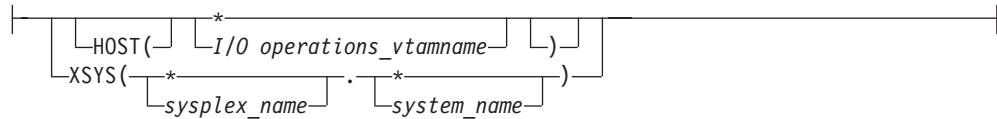

Range_Object (when object type is I/O resource):

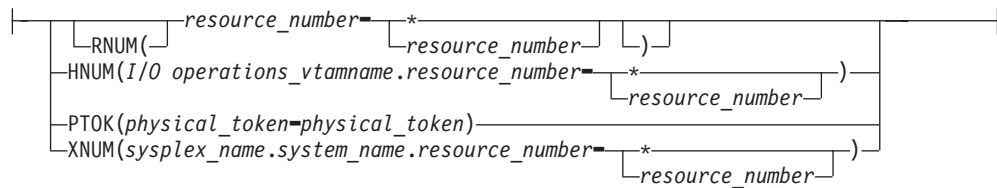

Range_Object (when object type is HOST):

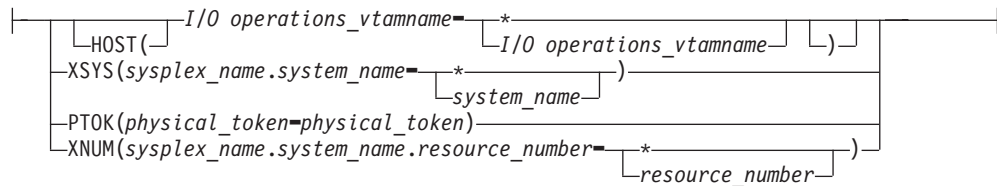

Scope:

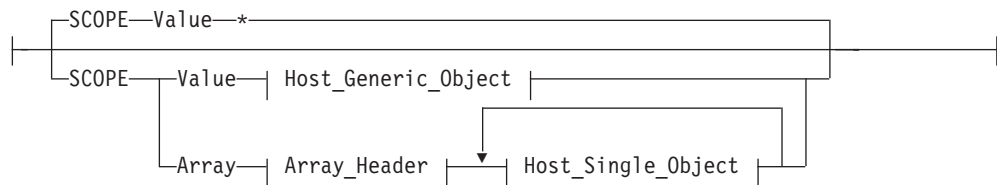

Options:



Common Output Header

Table 12 shows the common output header that is produced for all QUERY ENTITY/INTERFACE output structures.

Table 12. Header for all Query Entity/Interface Output Formats

Offset					
Dec	Hex	Type	Len	Name(Dim)	Description
0	(0)	STRUCTURE	80	HDR	
0	(0)	CHARACTER	4	EYE_CATCHER	Identifies the control block
					QEC Query Entity Chp
					QED Query Entity Device
					QEH Query Entity Host
					QES Query Entity Switch
					QEU Query Entity Cntlunit
					QIS Query Interface Switch
					QIU Query Interface Cntlunit
4	(4)	UNSIGNED	2	HDR_SIZE	Size of this header
6	(6)	UNSIGNED	2	ROW_SIZE	Size of array element
8	(8)	CHARACTER	8	ESCM_HOST	Responding host VTAM application name
16	(10)	CHARACTER	4	ESCM_REL	SA z/OS version and release
20	(14)	CHARACTER	32	HOST_PID	Host physical identifier
20	(14)	BITSTRING	1	*	
		111.		VALIDITY	0 = valid 1 = not current 2 = not valid
		...1 1111		*	Reserved
21	(15)	CHARACTER	3	*	Reserved
24	(18)	CHARACTER	6	TYPE_NUM	Processor type, e.g. 002064
30	(1E)	CHARACTER	3	MODEL_NUM	Processor model, e.g. 108
33	(21)	CHARACTER	3	MFR	Manufacturer, e.g. IBM
36	(24)	CHARACTER	2	PLANT	Where manufactured
38	(26)	CHARACTER	12	SEQUENCE_NUM	Serial number
50	(32)	BITSTRING	2	STATUS	Status of PID
		1...		AMBIGUOUS	Ambiguous state detected on PID
		.1..		REFLECTED	PID is derived from attached ND
		..11 1111 >>		*	Reserved
52	(34)	UNSIGNED	4	NUM_ROWS	Dimension of array following this header
56	(38)	UNSIGNED	1	FORMAT_ID	Identifies format of data
57	(39)	BITSTRING	1	*	

Table 12. Header for all Query Entity/Interface Output Formats (continued)

Offset					
Dec	Hex	Type	Len	Name(Dim)	Description
		1... ..		MORE_DATA	0 = all data that satisfies query is returned here. 1 = more data satisfies query (but won't fit now). Ask again with RANGE parameter type.
		.111 1111		*	Reserved
58	(3A)	CHARACTER	8	PLEX_NAME	Sysplex name (blank if none)
66	(42)	CHARACTER	8	SYST_NAME	System name
74	(4A)	CHARACTER	2	*	Reserved
76	(4C)	UNSIGNED	4	NUM_HOSTS	Number of hosts responding

Common Output Format

Table 13 shows the output that is common to all Query Relation commands.

Table 13. Output Format of all Query Relation Commands

Offset					
Dec	Hex	Type	Len	Name(Dim)	Description
0	(0)	STRUCTURE	*	QRO	
0	(0)	CHARACTER	48	HDR	Header data
0	(0)	CHARACTER	4	EYE_CATCHER	Identifies control block ('QRO')
4	(4)	UNSIGNED	2	HDR_SIZE	Length of (this) QRO.HDR
6	(6)	UNSIGNED	2	ROW_SIZE	Length of 1 ROW
8	(8)	CHARACTER	8	ESCM_HOST	Responding host VTAM application name
16	(10)	CHARACTER	4	ESCM_REL	SA z/OS version and release
20	(14)	UNSIGNED	4	NUM_ROWS	ROW dimension
24	(18)	UNSIGNED	1	FORMAT_ID	Identifies format of table
25	(19)	BITSTRING	1	*	
		1... ..		MORE_DATA	0 = Entire Query response in QRO 1 = Query response too large to fit in QRO (ask again, use RANGE)
		.1.. ..		PATHTEST	1 = PATHTEST requested
		..11 1111		*	Reserved
26	(1A)	CHARACTER	8	PLEX_NAME	Sysplex name (blank if none)
34	(22)	CHARACTER	8	SYST_NAME	System name
42	(2A)	CHARACTER	2	*	Reserved
44	(2C)	UNSIGNED	4	NUM_HOSTS	Number of hosts responding
Path descriptions					
48	(30)	CHARACTER	372	ROW(*)	Indexed by HDR.NUM_ROWS
48	(30)	CHARACTER	8	HOST_APPL	Host VTAM application name
56	(38)	UNSIGNED	1	CHPID	Channel path identifier (00-FFx)
57	(39)	UNSIGNED	1	PORTIN	When data is flowing from the host, the input port on the switch (if a switch is in the path)

Table 13. Output Format of all Query Relation Commands (continued)

Offset					
Dec	Hex	Type	Len	Name(Dim)	Description
58	(3A)	UNSIGNED	2	SW_DEVN	Switch device number (if a switch is in the path).
60	(3C)	UNSIGNED	1	LSN	Logical switch number (that goes with SW_DEVN) when a switch is in the path.
61	(3D)	UNSIGNED	1	PORTOUT	When data is flowing from the host, the output port on the switch (if a switch is in the path)
62	(3E)	UNSIGNED	2	CU_NUMBER	Control unit number
64	(40)	UNSIGNED	2	DEV_NUMBER	Device number
The following bits describe the validity of the data in the corresponding row					
66	(42)	BITSTRING	2	STATBITS	Indicate row data validity
		1... ..		VALID_DATA	1 = This row contains a valid path 0 = This row does not contain a valid path -- either the entity2 is not found in the database at all or there is no relation between the entity1 and entity2 specified
		.1.. ..		INCOMPLETE	0 = Queried data is in database (ie. not a proxy request) 1 = Queried data not known (ie. secondary host databases are not known)
The following bits describe switch data validity					
		..1.		VALID_SW	1 = SW_DEVN is valid (switch either is or was operational)
		...1		VALID_LSN	1 = LSN is valid (path is switched)
	 1...		VALID_PORTIN	1 = PORTIN value is verified
	1..		VALID_PORTOUT	1 = PORTOUT value is verified
The following bits indicate which path elements are detected to be involved in an ambiguous state.					
	1.		AMBIG_PORTIN	1 = CHCH, CHCU detected on PORTIN
	1		AMBIG_PORTOUT	1 = CHCU detected on PORTOUT
The following bits indicate whether ports (paths) are involved with chained or cascaded switches.					
67	(43)	1... ..		CHAIN_PORTIN	1 = PORTIN is part of CHAIN
		.1..		CHAIN_PORTOUT	1 = PORTOUT is part of CHAIN
		..1.		VALID_DEVNUM	1 = DEV_NUMBER contains data and the DEV_NUMBER is defined in the configuration

Table 13. Output Format of all Query Relation Commands (continued)

Offset							
Dec	Hex	Type	Len	Name(Dim)	Description		
		...1		PATHTEST	1 = PATHTEST data is available		
	 1...		VALID_CUNUM	1 = CU_NUMBER contains data and the CU_NUMBER is defined in the configuration		
	1..		CU_ISA_CF	1 = CU in this row is a coupling facility so PTOK mapping is for ND (when 0, PTOK mapping is for NED)		
	1.		VALID_CHP	1 = CHPID contains a value that is defined in the configuration		
	1		CASCADED_SW	1 = If PORTOUT is valid it represents the output port on the destination switch		
The following indicates whether the current row is to be processed when this table is used as input (to a Query Entity command).							
68	(44)	UNSIGNED	1	CODE	For Query Entity command. This space is used to tell IHV whether to operate on the given row. 0 = Ignore this row 1 = Operate on is row 2-255 = Reserved (row ignored if specified)		
69	(45)	CHARACTER	1	*	Workarea for internals		
The following bits describe data validity of the destination (cascaded) switch							
70	(46)	BITSTRING	1	STATBITS2	Indicate data validity		
		1...		VALID_DEST_LSN	1 = LSN of destination switch is valid		
		.1..		VALID_DEST_SW	1 = Device number of destination switch is valid		
		..11 1111		*	Reserved		
71	(47)	CHARACTER	1	*	Reserved (round to word)		
72	(48)	CHARACTER	8	SYSPLEX	Sysplex name (blank if none)		
80	(50)	CHARACTER	8	SYSTEM	System name		
88	(58)	CHARACTER	24	RESPONDER	Responder id		
88	(58)	CHARACTER	8	APPLNAMER	Responder host applname		
96	(60)	CHARACTER	8	SYSPLEXR	Responder host sysplex name		
104	(68)	CHARACTER	8	SYSTEMR	Responder host system name		
112	(70)	UNSIGNED	4	RCODE	Return/reason code for row		
A PATH_AVAIL is returned ONLY when chp/switdevn, chp/cunum or chp/devnum are in the row. In other words, the following commands will return PATH_AVAIL data (when the row contains valid and complete data)..Query Relation Host or Chp to Switch (where SWDEVN is set) Query Relation Host or Chp to CntlUnit or Dev and Query Relation Dev or CU or Switch to Host or Chp							
116	(74)	BITSTRING	4	PATH_AVAIL	Last known state of this path from CHSC "Store Sch Path Info" instruction		
116	(74)	BITSTRING	1	CHSC_LEVEL	Level (ie. scope) of info:		

Table 13. Output Format of all Query Relation Commands (continued)

Offset					
Dec	Hex	Type	Len	Name(Dim)	Description
		'10'x =			error affects entire chp
		'20'x =			error affects destination link
		'30'x =			error affects logical path
		'40'x =			error affects I/O on logical path
117	(75)	BITSTRING	2	CHSC_CODE	Status code and modifier:
117	(75)	BITSTRING	1	STATCODE	Status code
118	(76)	BITSTRING	1	MODCODE	Modifier code
		'0000'x =			no data available (ESCM value)
		'00FF'x =			Available, operational last time used
		'1010'x =			Chpid type does not match hardware type
		'1020'x =			Serial CTC feature not installed
		'1030'x =			ESCON chp connected to ESCON chp (defn err)
		'1040'x =			SCTC connected to ESCON CU
		'1050'x =			Non-CVC connected to converter
		'1060'x =			CVC channel without converter
		'1070'x =			CNC/multiple CU connection with no ESCD
		'1080'x =			No CU link address defined
		'1090'x =			Duplicate link address with port and CU
		'10A0'x =			Msg facility channel connected to another msg facility channel
		'10C0'x =			Buffer sizes incompatible between msg facility channel and msg-processor intersystem channel
		'10xx'x =			Path in definition error, no further info
		'2010'x =			Chpid not configured online
		'2020'x =			Chpid is in check stop state
		'2030'x =			Chpid is in permanent error
		'20xx'x =			Chpid is unavailable
		'30FF'x =			Wrap block is installed
		'40FF'x =			Chpid is in terminal state
		'5010'x =			Loss of signal or sync
		'5020'x =			Not-op sequence recognized
		'5030'x =			Sequence timeout
		'5040'x =			Illegal sequence received
		'50xx'x =			Link failure detected
		'60FF'x =			In offline reception state
		'7010'x =			Port reject -- address invalid
		'7011'x =			Undefined destination error
		'7012'x =			Destination port malfunction
		'7013'x =			Port intervention required
		'70xx'x =			Port reject (when no other applies)
		'8001'x =			Link reject -- transmit error
		'8005'x =			Link reject -- dest. address invalid or error
		'8007'x =			Reserved field error
		'8008'x =			Unrecognized link control function
		'8009'x =			Protocol error
		'800A'x =			ALA error
		'800B'x =			Unrecognized device level
		'80xx'x =			Link level reject encountered
		'9010'x =			Connection error
		'9020'x =			Channel detected transmission error
		'9030'x =			Protocol error
		'9040'x =			Destination address invalid
		'9050'x =			Device level error
		'90xx'x =			Channel link level error

Table 13. Output Format of all Query Relation Commands (continued)

Offset					
Dec	Hex	Type	Len	Name(Dim)	Description
		'A001'x =		Pacing parameters error	
		'A002'x =		Logical path resource unavailable	
		'A004'x =		CU image does not exist	
		'A005'x =		Logical path precluded at CU	
		'A0xx'x =		Logical path unavailable	
		'B010'x =		CU-device initialization in progress	
		'B020'x =		Link busy last encountered	
		'B030'x =		Port busy last encountered	
		'B040'x =		Chpid busy last encountered	
		'B0xx'x =		Path initialization in progress	
		'C010'x =		Select-in or address exception	
		'C0xx'x =		SCH path ok but device not operational	
		'FFFF'x =		Unknown state or no further info available	
SCPSTATE is returned ONLY when a complete path from chpid to device (or switch device) is in the row.					
120	(78)	BITSTRING	1	SCPSTATE	State of path from SCP
		1...		ONLINE	1 = Path is online to SCP
		.1..		OFFLINE	1 = Path is offline to SCP
		..11 1111		*	Reserved
Destination switch information					
121	(79)	UNSIGNED	1	DEST_SWCH_LSN	LSN of destination switch
122	(7A)	UNSIGNED	2	DEST_SWCH_DEVN	Device number of destination switch
A LPE_STATUS.ESCON is returned whenever there is a chpid in the row. LPE_STATUS.LPE is ONLY returned when the row contains a valid chpid along with valid switch devnum, cunum or device number.					
124	(7C)	BITSTRING	1	LPE_STATUS	Logical path established indicators
		1...		ESCON	1 = This path supports LPEs AND LPE info is valid
		.1..		LPE	0 = No path established. 1 = An logical path is established (CHSC info). LPE_STATUS.ESCON bit validates this field.
		..11 1111		*	Reserved
A PTMSG is returned ONLY when PATHTEST is specified in the command. If PATHTEST is not specified, binary zeros are returned in this field.					
125	(7D)	CHARACTER	71	PTMSG	MVS or ESCM message due to issuing I/O down this path. Valid only when PATHTEST specfd.
TOKS are returned for every command where the associated (RNUM) item is set. Additionally, CU & DEV physical tokens are refreshed for each row when PATHTEST is specified.					
Note: Logical tokens consisting of 32 bytes of binary zeros denotes that the LTOK is not valid/available.					
196	(C4)	CHARACTER	224	TOKS	Logical/Physical tokens
Chpid tokens..					
196	(C4)	CHARACTER	32	CHP_PTOK	Actually determined ND Chpids do not have logical tokens

Table 13. Output Format of all Query Relation Commands (continued)

Offset						
Dec	Hex	Type	Len	Name(Dim)		Description
Switch tokens..						
For Query Relation Switch-Switch commands, the tokens returned here are for the entity2 (chained) switch.						
228	(E4)	CHARACTER	32	SWIT_PTOK		Switch NED if switch is OPEN, or PID if switch is not open (or defined?).
260	(104)	CHARACTER	32	SWIT_LTOK		Only valid if this switch is defined as a device to this host -- then inherited from CU for this switch.
Control Unit tokens..						
292	(124)	CHARACTER	32	CU_PTOK		NED (or ND if CU_ISA_CF)
324	(144)	CHARACTER	32	CU_LTOK		From HCD
Device tokens..						
356	(164)	CHARACTER	32	DEV_PTOK		NED
388	(184)	CHARACTER	32	DEV_LTOK		From HCD
420	(1A4)	CHARACTER	0	*		Reserved (to round)

DELETE FILE

Purpose

Use the DELETE FILE command at the I/O operations API to delete a saved switch configuration that is stored at the switch specified in the command. The switch must be allocated to the issuing I/O operations.

Syntax

►►—DELeTe File—*filename*—*swchdevn*—◄◄

Parameters

filename

Specify the file name in 1 through 8 valid EBCDIC codes. Valid codes are uppercase alphabetical characters (A-Z), digital characters (0-9), and 2 special character: the underscore (_) and the hyphen (-). However, do not specify the following file names: AUX, COM n (where $n=1-4$), CON, IPL, LPT n (where $n=1-3$), NUL, or PRN.

swchdevn

Specify the switch device number in up to 4 hexadecimal digits. The switch must be allocated, or attached, to the issuing I/O operations. You can issue the DISPLAY SWITCH command to obtain a list of these switches.

Usage

You cannot delete the switch IPL file, which is supplied with each IBM Director and is activated automatically when the unit is powered on.

QUERY ENTITY CHP

Purpose

Use the QUERY ENTITY CHP command at the API to obtain data about the channel path (Chp) that you specify.

Query Parameters

►►—Query Entity Chp—| Entity_Object |—| Scope |—————►►

Output

The format of the output from QUERY ENTITY CHP is as follows:

Table 14. QUERY ENTITY CHP Output

Offset		Dec	Hex	Type	Len	Name(Dim)	Description
0	(0)			STRUCTURE	*	QEC	
The header for all Query Entity/Interface output structures is not listed here. Its size is 80 bytes. For details see "Common Output Header" on page 161.							
80	(50)			CHARACTER	184	CHPS(*)	Individual chp data
80	(50)			UNSIGNED	1	CHPID	Channel path ID
81	(51)			BITSTRING	1	STATBITS	
				1... ..		VALID_DATA	1 = This chpid is defined on host
				.111 1111		*	Reserved
82	(52)			CHARACTER	32	CHP_PTOK	Physical Token
82	(52)			CHARACTER	32	ND_DET	Determined ND "who am I"
114	(72)			CHARACTER	32	ND_ATT	Attached ND "who are you"
146	(92)			UNSIGNED	1	TYPE	
				'00'x = UNDEF		Unknown	
				'01'x = BLOCK		Parallel block multiplex	
				'02'x = BYTE		Parallel byte multiplex	
				'03'x = CNC_P		ESCON point to point	
				'04'x = CNC_?		ESCON switched or point to point	
				'05'x = CNC_S		ESCON switched point to point	
				'06'x = CVC		ESCON path to a block converter	
				'07'x = NTV		Native interface	
				'08'x = CTC_P		CTC point to point	
				'09'x = CTC_S		CTC switched point to point	
				'0A'x = CTC_?		CTC switched or point to point	
				'0B'x = CFS		Coupling facility sender	
				'0C'x = CFR		Coupling facility receiver	
				'0F'x = CBY		ESCON path to a byte converter	
				'10'x = OSE		OSA express	
				'11'x = OSD		OSA direct express	
				'12'x = OSA		Open systems adapter	

Table 14. QUERY ENTITY CHP Output (continued)

Offset					
Dec	Hex	Type	Len	Name(Dim)	Description
		'13'x = ISD		Internal system device	
		'16'x = CBS		Cluster bus sender	
		'17'x = CBR		Cluster bus receiver	
		'18'x = ICS		Internal coupling sender	
		'19'x = ICR		Internal coupling receiver	
		'1A'x = FC		FICON point to point	
		'1B'x = FC_S		FICON switched	
		'1C'x = FCV		FICON to escon bridge	
		'1D'x = FC_?		FICON incomplete	
		'1E'x = DSD		Direct system device	
		'1F'x = EIO		Emulated I/O	
		'21'x = CBP		Integrated cluster bus peer	
		'22'x = CFP		Coupling facility peer	
		'23'x = ICP		Internal coupling peer	
		'24'x = IQD		Internal queued direct comm	
		'25'x = FCP		FCP channel	
				Other values are reserved	
147	(93)	CHARACTER	1	TRAITS	Chp characteristics
		1...		ONLINE	1 = Chpid is operational on this host
		.1..		DCM_MANAGED	1 = Chpid is DCM managed on this host
		..11		*	Reserved
	 1111		PROTOCOL	Interface protocol used.. 0 = Unspecified 1 = LED 2 = Laser 3 = Laser-1 (shortwave) 4 = Laser-2 (shortwave) 5 = Laser-3 (longwave) other values are reserved
Entity Attribute Mask					
148	(94)	BITSTRING	4	EAM	
		1111		LOG_CLASS	Logical entity classification.. 0 = Unspecified 1 = Host 2 = Chpid 3 = Switch 4 = Control unit 5 = Device 7 = Ambiguous (CHCU, etc) other values are reserved

QUERY ENTITY CHP

Table 14. QUERY ENTITY CHP Output (continued)

Offset							
Dec	Hex	Type		Len	Name(Dim)	Description	
		1111		PHYS_CLASS	Physical entity classification..	
						0 = Unspecified	
						1 = Host	
						2 = Chpid	
						3 = Switch	
						4 = Control unit	
						5 = Device	
						6 = ESCON mod2 converter	
						7 = Ambiguous (link is static (no ND_ATT) and IODEF is ambiguous)	
						8 = CF internal path (only set for CUs)	
						other values are reserved	
149	(95)	BITSTRING		2	STATE	State of the entity	
		1...		LOGICAL	1 = Entity is logical	
		.1..		P_CURR	1 = Entity is physically current	
		..1.		P_HIST	1 = Entity is physical history	
		...1		LOG_OTHER	1 = Logical by another interface	
		1...		P_OTHER_CURR	1 = Physical by another interface	
	1..		P_OTHER_HIST	1 = Physical history by other interface	
	1.		P_INDIRECT	1 = The EAM validity was derived from the attached (ND) interfaces from the control unit	
						0 = The EAM validity was obtained from the CU itself (can only be true for opened switches)	
	1		P_AMB	1 = Physical ambiguous configured on some interface	
150	(96)	1...		LOG_AMB	1 = Logical ambiguous configured on some interface	
		.1..		CLASS_AMB	1 = Logical and physical classes are not compatible	
		..11	1111 >>		*	Reserved	
End of Entity Attribute Mask							
Attached Entity Attribute Mask							
152	(98)	BITSTRING		4	AEAM		

Table 14. QUERY ENTITY CHP Output (continued)

Offset							
Dec	Hex	Type		Len	Name(Dim)	Description	
		1111		LOG_CLASS	Logical entity classification..	
						0 = Unspecified	
						1 = Host	
						2 = Chpid	
						3 = Switch	
						4 = Control unit	
						5 = Device	
						7 = Ambiguous (CHCU, etc)	
						other values are reserved	
		1111		PHYS_CLASS	Physical entity classification..	
						0 = Unspecified	
						1 = Host	
						2 = Chpid	
						3 = Switch	
						4 = Control unit	
						5 = Device	
						6 = ESCON mod2 converter	
						7 = Ambiguous (link is static (no ND_ATT) and IODEF is ambiguous)	
						8 = CF internal path (only set for CUs)	
						other values are reserved	
153	(99)	BITSTRING		2	STATE	State of the entity	
		1...		LOGICAL	1 = Entity is logical	
		.1..		P_CURR	1 = Entity is physically current	
		..1.		P_HIST	1 = Entity is physical history	
		...1		LOG_OTHER	1 = Logical by another interface	
		1...		P_OTHER_CURR	1 = Physical by another interface	
	1..		P_OTHER_HIST	1 = Physical history by other interface	
	1.		P_INDIRECT	1 = The attached ND for the entity being queried is history but we got the chpid's validity from the chpid's det ND (which is always valid) so the AEAM is marked P_CURR for the (attached) chpid	
						0 = The attached ND and AEAM have the same validity	
	1		P_AMB	1 = Physical ambiguous configured on some interface	

QUERY ENTITY CHP

Table 14. QUERY ENTITY CHP Output (continued)

Offset							
Dec	Hex	Type	Len	Name(Dim)	Description		
154	(9A)	1... ..		LOG_AMB	1 = Logical ambiguous configured on some interface		
		.1.. ..		CLASS_AMB	1 = Logical and physical classes are not compatible		
		..11 1111 >>		*	Reserved		
End of extrapolated entity descriptions							
156	(9C)	CHARACTER	36	OTHERS			
156	(9C)	CHARACTER	32	ND	Extrapolation ND. This field is only valid when AEAM.P_OTHER or AEAM.P_OTHER_HIST are set (on). This ND can be expected to contain a value when either..		
					<ul style="list-style-type: none"> the PID and ND validities differ (and the validity of this thing better be the same as the PID if there is a PID) there is more than 1 physical (only) path to an attached entity and the path that is being queried is not the most valid path. This ND should contain the identity of the more (most) valid (physical) path. 		
156	(9C)	BITSTRING	1	*			
		111.		NDVALID	Indicates validity of this ND		
		...1 1111		*	Reserved		
157	(9D)	CHARACTER	31	*	Rest of ND		
188	(BC)	UNSIGNED	2	LOG	Extrapolated logical ID This is the lowest logically defined config number assigned to the entity. This field is only valid when AEAM.LOG_OTHER is set (on).		
190	(BE)	CHARACTER	2	*	Reserved		
192	(C0)	CHARACTER	24	RESPONDER	Responding host id		
192	(C0)	CHARACTER	8	APPLNAMER	Application name		
200	(C8)	CHARACTER	8	SYSPLXR	Sysplex name		
208	(D0)	CHARACTER	8	SYSTEMR	System name		
216	(D8)	UNSIGNED	4	RCODE	Row return/reason code		
220	(DC)	CHARACTER	5	CHPIDTYP	Channel type as string		
225	(E1)	UNSIGNED	1	CSSID	Channel subsystem ID		
226	(E2)	CHARACTER	38	CHPIDINFO	Resource Information		
226	(E2)	CHARACTER	32	IODF_DESC	HCD User description		
258	(102)	BITSTRING	1	*			

Table 14. QUERY ENTITY CHP Output (continued)

Offset							
Dec	Hex	Type	Len	Name(Dim)	Description		
		111.		CONFIG_STATE	Configure state of channel		
					0 = Reserved		
					1 = Online		
					2 = Offline/standby		
					6 = Offline/reserved		
		...1 1111	*	*	Reserved (round to byte)		
259	(103)	CHARACTER	1	*	Reserved (round to even)		
260	(104)	BITSTRING	4	ERROR_STATE	Availability information		
					Last known state of this path from CHSC Store SCH Path Information		
					(ERROR_STATE=0 -> no data avail)		
260	(104)	BITSTRING	1	CHSC_LEVEL	Level (ie. scope) of information		
		'00'x =			No information available (I/O operations')		
		'10'x =			Error affects entire chp		
		'20'x =			Error affects destination link		
		'30'x =			Error affects logical path		
		'40'x =			Error affects I/O on the logical path		
261	(105)	BITSTRING	2	CHSC_CODE	Status code with modifier		
261	(105)	BITSTRING	1	STATCODE	Status code		
262	(106)	BITSTRING	1	MODCODE	Status modifier value		
		'0000'x =			No data available (I/O operations value)		
		'00FF'x =			Available, operational last time used		
		'1010'x =			Chpid type does not match hardware type		
		'1020'x =			Serial CTC feature not installed		
		'1030'x =			ESCON chp connected to ESCON chp (definition err)		
		'1040'x =			SCTC connected to ESCON CU		
		'1050'x =			Non-CVC connected to converter		
		'1060'x =			CVC channel without converter		
		'1070'x =			CNC/multiple CU connection with no ESCD		
		'1080'x =			No CU link address defined		
		'1090'x =			Duplicate link address with port and CU		
		'10xx'x =			Path in definition error, no further information		

QUERY ENTITY CNTLUNIT

Purpose

Use the QUERY ENTITY CNTLUNIT command at the API to obtain data about the specified control unit (CU).

Query Parameters

►►—Query Entity CntlUnit—| Entity_Object |—| Scope |—————►►

QUERY ENTITY CNTLUNIT

Output

The format of the output from QUERY ENTITY CNTLUNIT is as follows:

Table 15. QUERY ENTITY CNTLUNIT Output

Offset					
Dec	Hex	Type	Len	Name(Dim)	Description
0	(0)	STRUCTURE	*	QEU	
The header for all Query Entity/Interface output structures is not listed here. Its size is 80 bytes. For details see "Common Output Header" on page 161.					
80	(50)	CHARACTER	200	CUS(*)	Control unit descriptions
80	(50)	UNSIGNED	2	CU_NUMBER	Control unit number
82	(52)	CHARACTER	1	STATBITS	
		1... ..		VALID_DATA	1 = This control unit is defined in the IOCDs
		.1.. ..		CU_IS_SWITCH	1 = This control unit is a control unit
		..1.		CU_IS_CF	1 = CU is a coupling facility
		...1 1111		*	Reserved
83	(53)	UNSIGNED	1	CUADD	(IOCP) logical address
Physical (neighbor "who am I") Data					
84	(54)	CHARACTER	32	PID	CU's DERIVED physical identity (same format as in HDR)
116	(74)	CHARACTER	32	CU_PTOK	Physical Token...remaps the NED (when the CU_IS_CF bit is off) or is an ND (when the CU_IS_CF bit is on (= '1'b)). See macro IXLMG for definition of the ND when the CU is a coupling facility.
116	(74)	CHARACTER	32	NED	Node Element Descriptor -- CU's physical ID read from the control unit when this CU is not a coupling facility
		11.. ..		NED_VALID	Validity bits for PTOK=NED 0 = Unused (not valid) 1 = Reserved 2 = Reserved 3 = Valid NED
116	(74)	CHARACTER	32	ND	Node Descriptor = CF PTOK
		111.		ND_VALID	Validity bits for PTOK=ND 0 = Valid, current 1 = Valid, not current 2 = Not valid
148	(94)	CHARACTER	4	*	Reserved
Entity Attribute Mask					
152	(98)	BITSTRING	4	EAM	

Table 15. QUERY ENTITY CNTLUNIT Output (continued)

Offset							
Dec	Hex	Type		Len	Name(Dim)	Description	
		1111		LOG_CLASS	Logical entity classification.. 0 = Unspecified 1 = Host 2 = Chpid 3 = Switch 4 = Control unit 5 = Device 7 = Ambiguous (CHCU, etc) other values are reserved	
		 1111		PHYS_CLASS	Physical entity classification.. 0 = Unspecified 1 = Host 2 = Chpid 3 = Switch 4 = Control unit 5 = Device 6 = ESCON mod2 converter 7 = Ambiguous (link is static (no ND_ATT) and IODEF is ambiguous) 8 = CF internal path (only set for CUs) other values are reserved	
153	(99)	BITSTRING		2	STATE	State of the entity	
		1...		LOGICAL	1 = Entity is logical	
		.1..		P_CURR	1 = Entity is physically current	
		..1.		P_HIST	1 = Entity is physical history	
		...1		LOG_OTHER	1 = Logical by another interface	
	 1...			P_OTHER_CURR	1 = Physical by another interface	
	1..			P_OTHER_HIST	1 = Physical history by other interface	
	1.			P_INDIRECT	1 = The EAM validity was derived from the attached (ND) interfaces from the control unit 0 = The EAM validity was obtained from the CU itself (can only be true for opened switches)	
		1		P_AMB	1 = Physical ambiguous configured on some interface	

QUERY ENTITY CNTLUNIT

Table 15. QUERY ENTITY CNTLUNIT Output (continued)

Offset							
Dec	Hex	Type	Len	Name(Dim)	Description		
154	(9A)	1... ..		LOG_AMB	1 = Logical ambiguous configured on some interface		
		.1.. ..		CLASS_AMB	1 = Logical and physical classes are not compatible		
		..11 1111 >>		*	Reserved		
End of Entity Attribute Mask							
156	(9C)	CHARACTER	48	IODFDATA	Information from HCD		
156	(9C)	UNSIGNED	4	GROUP	Group class (encoded field)		
					1 = DASD		
					2 = Tape		
					3 = Cluster controller		
					4 = Communications controller		
					5 = MICR/OCR		
					6 = Graphics		
					7 = Unit record device		
					8 = Card reader/punch		
					9 = Display		
					10 = Term printer		
					255 = Other		
160	(A0)	CHARACTER	8	UNIT	Control Unit Type		
168	(A8)	CHARACTER	4	MODEL	Control Unit Model		
172	(AC)	CHARACTER	32	DESCRIPTION	HCD user description of this object		
204	(CC)	BITSTRING	1	SCPSTATE	For Coupling Facility only		
		1... ..		CONNECTED	1 = MVS allows operations		
		.1.. ..		MANAGED	1 = MVS policy exists		
		..1.		AVAILABLE	1 = Physical path exists		
		...1		UNAVAILABLE	1 = No physical path		
	 1111		*	Reserved		
205	(CD)	CHARACTER	3	*	Reserved		
208	(D0)	CHARACTER	8	CFNAME	Coupling Facility name		
216	(D8)	CHARACTER	32	CU_LTOK	Logical Token (is binary zeros when not available)		
248	(F8)	CHARACTER	24	RESPONDER	Responding host id		
248	(F8)	CHARACTER	8	APPLNAMER	Application name		
256	(100)	CHARACTER	8	SYSPLXR	Sysplex name		
264	(108)	CHARACTER	8	SYSTEMR	System name		
272	(110)	UNSIGNED	4	RCODE	Row return/reason code		
276	(114)	CHARACTER	8	*	Reserved		

QUERY ENTITY DEV

Purpose

Use the QUERY ENTITY DEV command at the API to obtain data about the specified device.

Query Parameters



Output

The format of the output from QUERY ENTITY DEV is as follows:

Table 16. QUERY ENTITY DEV Output

Offset							
Dec	Hex	Type	Len	Name(Dim)	Description		
0	(0)	STRUCTURE	*	QED			
The header for all Query Entity/Interface output structures is not listed here. Its size is 80 bytes. For details see "Common Output Header" on page 161.							
80	(50)	CHARACTER	184	DEVS(*)	Individual device data		
80	(50)	UNSIGNED	2	DEV_NUMBER	Device number		
82	(52)	CHARACTER	1	STATBITS			
		1... ..		VALID_DATA	1 = This device is defined		
		.1.. ..		DEV_IS_SWITCH	1 = This device is a switch		
		..1.		DEV_IS_CF	1 = This device is a coupling facility		
		...1		SELF_DESCR	1 = This device supports self-description		
	 1111		*	Reserved		
Entity Attribute Mask							
83	(53)	BITSTRING	4	EAM	Logical entity classification..		
		1111		LOG_CLASS	0 = Unspecified		
					1 = Host		
					2 = Chpid		
					3 = Switch		
					4 = Control unit		
					5 = Device		
					7 = Ambiguous (CHCU, etc)		
					other values are reserved		
	 1111		PHYS_CLASS	Physical entity classification..		
					0 = Unspecified		
					1 = Host		
					2 = Chpid		
					3 = Switch		
					4 = Control unit		
					5 = Device		
					6 = ESCON mod2 converter		
					7 = Ambiguous (link is static (no ND_ATT) and IODEF is ambiguous)		
					8 = CF internal path (only set for CUs)		
					other values are reserved		
84	(54)	BITSTRING	2	STATE	State of the entity		
		1... ..		LOGICAL	1 = Entity is logical		

QUERY ENTITY DEV

Table 16. QUERY ENTITY DEV Output (continued)

Offset							
Dec	Hex	Type		Len	Name(Dim)	Description	
		.1..		P_CURR	1 = Entity is physically current	
		..1.		P_HIST	1 = Entity is physical history	
		...1		LOG_OTHER	1 = Logical by another interface	
		1...		P_OTHER_CURR	1 = Physical by another interface	
	1..		P_OTHER_HIST	1 = Physical history by other interface	
	1.		P_INDIRECT	1 = The EAM validity was derived from the attached (ND) interfaces from the control unit	
	1		P_AMB	1 = Physical ambiguous configured on some interface	
85	(55)	1...		LOG_AMB	1 = Logical ambiguous configured on some interface	
		.1..		CLASS_AMB	1 = Logical and physical classes are not compatible	
		..11	1111 >>	*		Reserved	
End of Entity Attribute Mask							
87	(57)	CHARACTER		20	*	Reserved	
107	(6B)	CHARACTER		24	RESPONDER	Responding host id	
107	(6B)	CHARACTER		8	APPLNAMER	Application name	
115	(73)	CHARACTER		8	SYSPLXR	Sysplex name	
123	(7B)	CHARACTER		8	SYSTEMR	System name	
131	(83)	CHARACTER		1	*	Reserved	
132	(84)	UNSIGNED		4	RCODE	Row return/reason code	
136	(88)	CHARACTER		32	DEV_PTOK	Physical Token	
136	(88)	CHARACTER		32	NED	Node Element Descriptor	
168	(A8)	CHARACTER		6	VOLSER	Volume serial ID (DASD only, device NED indicates device type)	
174	(AE)	CHARACTER		2	*	Reserved	
176	(B0)	BITSTRING		4	SCPSTATE	Operating system state	
		1...		BOXED	1 = Boxed	
		.1..		NOTREADY	1 = Not ready	
		..1.		BUSY	1 = Busy	
		...1		RESERVED	1 = Reserved	
		1...		ALLOCATED	1 = Allocated	
	1..		ONLINE	1 = Online	
	1.		UNLOAD	1 = Unload pending	
	1		MOUNT	1 = Mount pending	
177	(B1)	1...		RESPENDING	1 = Reserve pending	

Table 16. QUERY ENTITY DEV Output (continued)

Offset		Dec	Hex	Type	Len	Name(Dim)	Description
				.1..		PENDING	1 = Pending offline
				..1.		OFFALLOC	1 = Offline -- allocated to SCP
				...1		OFFESCM	1 = Offline due to I/O operations
			 1..		OFFCUIR	1 = Offline due to CUIR
			1..		OFFTAPE	1 = Offline due to tape
			1.		OFFHIERCH	1 = Offline due to hierarchy reason
			1		OFFOPER	1 = Offline due to operator
178	(B2)			1..		OFFLINE	1 = Offline
				.1..		INUSE	1 = Device is in use (message device only)
				..1.		OPERATIONAL	1 = Device is operational (message device only)
				...1		NOTOP	1 = Device is not operational (message device only)
			 1..		AUTOSW	1 = Device is set autoswitch
			111 >>		*	Reserved
180	(B4)			CHARACTER	48	IODFDATA	HCD information
180	(B4)			UNSIGNED	4	GROUP	Generic type encode: 1 = DASD 2 = Tape 3 = Cluster controller 4 = Communications controller 5 = MICR/OCR 6 = Graphics 7 = Unit record device 8 = Card reader/punch 9 = Display 10 = Term printer 255 = Other
184	(B8)			CHARACTER	8	UNIT	Unit
192	(C0)			CHARACTER	4	MODEL	Model
196	(C4)			CHARACTER	32	DESCRIPTION	HCD user description data
228	(E4)			CHARACTER	32	DEV_LTOK	Logical Token (is binary zeros when not available)
260	(104)			CHARACTER	4	*	Reserved

QUERY ENTITY HOST

Purpose

Use the QUERY ENTITY HOST command at the API to obtain data about one or more SA z/OS base programs (hosts) that are known to the issuing SA z/OS (primary host).

Query Parameters



Output

Output from a QUERY ENTITY command consists of a header, which is identical for each entity with the exception of the “Eye-Catcher” (offset 0), followed by the substructures, which are unique to each type of entity.

The format of the output from QUERY ENTITY HOST is as follows:

Table 17. QUERY ENTITY HOST Output

Offset		Dec	Hex	Type	Len	Name(Dim)	Description
0			(0)	STRUCTURE	*	QEH	
The header for all Query Entity/Interface output structures is not listed here. Its size is 80 bytes. For details see “Common Output Header” on page 161.							
80		(50)		CHARACTER	208	HOSTS(*)	Individual host data
80		(50)		CHARACTER	8	APPL_NAME	VTAM application name
88		(58)		CHARACTER	1	STATBITS	
			1... ..			VALID_DATA	1 = This host is known
			.1.. ..			HOST_OFF	1 = This host is reset off
			..1.			IN_SESSION	For PRIMARY HOST only 1 = I/O operations/VTAM communication ok 0 = No I/O operations/VTAM communication
			...1			BACKING_OUT	For SECONDARY HOST only 1 = Appl-to-appl session ok 0 = No session setup 1 = Backout in progress 0 = No backout processing
		 1111			*	Reserved
89		(59)		CHARACTER	4	VER_REL	SA z/OS version and release on this host
93		(5D)		CHARACTER	32	PID	This host PID (same format as in HDR)
Entity Attribute Mask							
125		(7D)		BITSTRING	4	EAM	

Table 17. QUERY ENTITY HOST Output (continued)

Offset							
Dec	Hex	Type		Len	Name(Dim)	Description	
		1111		LOG_CLASS	Logical entity classification.. 0 = Unspecified 1 = Host 2 = Chpid 3 = Switch 4 = Control unit 5 = Device 7 = Ambiguous (CHCU, etc) other values are reserved	
		 1111		PHYS_CLASS	Physical entity classification.. 0 = Unspecified 1 = Host 2 = Chpid 3 = Switch 4 = Control unit 5 = Device 6 = ESCON mod2 converter 7 = Ambiguous (link is static (no ND_ATT) and IODEF is ambiguous) 8 = CF internal path (only set for CUs) other values are reserved	
126	(7E)	BITSTRING		2	STATE	State of the entity	
		1...		LOGICAL	1 = Entity is logical	
		.1..		P_CURR	1 = Entity is physically current	
		..1.		P_HIST	1 = Entity is physical history	
		...1		LOG_OTHER	1 = Logical by another interface	
	 1...			P_OTHER_CURR	1 = Physical by another interface	
	1..			P_OTHER_HIST	1 = Physical history by other interface	
	1.			P_INDIRECT	1 = The EAM validity was derived from the attached (ND) interfaces from the control unit 0 = The EAM validity was obtained from the CU itself (can only be true for opened switches)	
		1		P_AMB	1 = Physical ambiguous configured on some interface	

QUERY ENTITY HOST

Table 17. QUERY ENTITY HOST Output (continued)

Offset							
Dec	Hex	Type	Len	Name(Dim)	Description		
127	(7F)	1... ..		LOG_AMB	1 = Logical ambiguous configured on some interface		
		.1.. ..		CLASS_AMB	1 = Logical and physical classes are not compatible		
		..11 1111 >>		*	Reserved		
End of Entity Attribute Mask							
129	(81)	CHARACTER	8	SYSPLEX	Sysplex name (blank if none)		
137	(89)	CHARACTER	8	SYSTEM	System name		
145	(91)	CHARACTER	24	RESPONDER	Responding host id		
145	(91)	CHARACTER	8	APPLNAMER	Application name		
153	(99)	CHARACTER	8	SYSPLEXR	Sysplex name		
161	(A1)	CHARACTER	8	SYSTEMR	System name		
169	(A9)	CHARACTER	3	*	Reserved		
172	(AC)	UNSIGNED	4	RCODE	Row return/reason code		
176	(B0)	CHARACTER	64	HCD_DATA	HCD data		
176	(B0)	CHARACTER	44	IODF_DSN	HCD IODF dataset name		
220	(DC)	UNSIGNED	4	IODFACT	Hardware and software (CSS/IODF) synch status. Possible values: 1 = HW and SW of the active IODF are in sync 2 = HW and SW are out of sync 3 = No valid HW token exists		
224	(E0)	CHARACTER	16	IODFNAME	World-wide unique name of the active configuration		
240	(F0)	CHARACTER	16	LOCKOWNER	Process lock owner This field is only valid when this host is the same as the responding host. For other hosts, this field will be blank.		
240	(F0)	CHARACTER	8	SYSTEML	Application name of user holding process lock		
248	(F8)	CHARACTER	8	USER	Userid of lock owner		
256	(100)	BITSTRING	1	R3_FNS	Additional functions installed beyond Release 3		
		1... ..		SPE1	1 = Byte Pacer. OSA, Downlevel MVS, no switch dependency are supported.		
		.111 1111		*	Reserved		
257	(101)	CHARACTER	3	OSLEVEL	Operating system		
257	(101)	CHARACTER	1	NAME	M = MVS V = VM		
258	(102)	CHARACTER	1	VERSION	Decimal 0-9		
259	(103)	CHARACTER	1	RELEASE	Decimal 0-9		

Table 17. QUERY ENTITY HOST Output (continued)

Offset					
Dec	Hex	Type	Len	Name(Dim)	Description
260	(104)	CHARACTER	8	CPUID	Processor id (results of STIDP, will be blank when not set)
268	(10C)	UNSIGNED	2	CPUADD	Processor address (results of STADP, will be blank when not set)
270	(10E)	CHARACTER	18	*	Reserved

QUERY ENTITY SWITCH

Purpose

Use the QUERY ENTITY SWITCH command at the API to obtain data about the specified switch.

Query Parameters

►►—Query Entity Switch—| Entity_Object |—| Scope |—————►►

Output

The format of the output from QUERY ENTITY SWITCH is as follows:

Table 18. QUERY ENTITY SWITCH Output

Offset					
Dec	Hex	Type	Len	Name(Dim)	Description
0	(0)	STRUCTURE	*	QES	
The header for all Query Entity/Interface output structures is not listed here. Its size is 80 bytes. For details see “Common Output Header” on page 161.					
80	(50)	CHARACTER	192	SWITCHES(*)	Individual switch data
80	(50)	UNSIGNED	2	SW_DEVN	Switch device number
82	(52)	CHARACTER	1	STATBITS	
		1... ..		VALID_DATA	1 = This switch is in database
		.1.. ..		VALID_SWDEVN	1 = Switch device number valid
		..1.		*	Reserved
		...1		OPEN	1 = Switch is opened (by I/O operations)
	 1...		INVALID_LSN	1 = LSN is invalid
	111		*	Reserved
83	(53)	UNSIGNED	1	LSN	Logical switch number
84	(54)	CHARACTER	32	SW_PTOK	Physical Token
84	(54)	CHARACTER	32	NED	Node Element Descriptor
116	(74)	CHARACTER	32	PID	Unique (physical) ID (same format as in HDR)
148	(94)	UNSIGNED	1	NPINST	Number of installed ports
149	(95)	UNSIGNED	1	NPIM	Number of implemented ports (ports ABLE to be installed)

QUERY ENTITY SWITCH

Table 18. QUERY ENTITY SWITCH Output (continued)

Offset							
Dec	Hex	Type	Len	Name(Dim)	Description		
150	(96)	UNSIGNED	1	OP_STATUS	Operational status		
					0 = Unspecified		
					1 = Not open		
					2 = In contention		
					3 = H/W error		
					4 = System error		
					5 = I/O error		
					6 = Operational		
					7 = Reserved		
					8 = Read only (HCP set)		
					Other values are reserved		
151	(97)	UNSIGNED	1	A_CUP	CUP port address		
152	(98)	UNSIGNED	4	STATUS_CODE	Error code (if any)		
Entity Attribute Mask							
156	(9C)	BITSTRING	4	EAM			
		1111		LOG_CLASS	Logical entity classification..		
					0 = Unspecified		
					1 = Host		
					2 = Chpid		
					3 = Switch		
					4 = Control unit		
					5 = Device		
					7 = Ambiguous (CHCU, etc)		
					other values are reserved		
	 1111		PHYS_CLASS	Physical entity classification..		
					0 = Unspecified		
					1 = Host		
					2 = Chpid		
					3 = Switch		
					4 = Control unit		
					5 = Device		
					6 = ESCON mod2 converter		
					7 = Ambiguous (link is static (no ND_ATT) and IODEF is ambiguous)		
					8 = CF internal path (only set for CUs)		
					other values are reserved		
157	(9D)	BITSTRING	2	STATE	State of the entity		
		1...		LOGICAL	1 = Entity is logical		
		.1..		P_CURR	1 = Entity is physically current		
		..1.		P_HIST	1 = Entity is physical history		
		...1		LOG_OTHER	1 = Logical by another interface		
	 1...		P_OTHER_CURR	1 = Physical by another interface		
	1..		P_OTHER_HIST	1 = Physical history by other interface		

Table 18. QUERY ENTITY SWITCH Output (continued)

Offset		Type		Len	Name(Dim)	Description
Dec	Hex1.		P_INDIRECT	1 = The EAM validity was derived from the attached (ND) interfaces from the control unit 0 = The EAM validity was obtained from the CU itself (can only be true for opened switches)
	1		P_AMB	1 = Physical ambiguous configured on some interface
158	(9E)	1...		LOG_AMB	1 = Logical ambiguous configured on some interface
		.1..		CLASS_AMB	1 = Logical and physical classes are not compatible
		..11	1111	>>	*	Reserved
End of Entity Attribute Mask						
160	(A0)	CHARACTER		32	IODFDESC	HCD's user description of this object
192	(C0)	CHARACTER		7	ECLEVEL	Hardware EC level
199	(C7)	UNSIGNED		1	LOWPORT	Lowest port address on this switch
200	(C8)	BITSTRING		4	SCPSTATE	Operating system state
		1...		BOXED	1 = Boxed
		.1..		NOTREADY	1 = Not ready
		..1.		BUSY	1 = Busy
		...1		RESERVED	1 = Reserved
		1...		ALLOCATED	1 = Allocated
	1..		ONLINE	1 = Online
	1.		UNLOAD	1 = Unload pending
	1		MOUNT	1 = Mount pending
201	(C9)	1...		RESPENDING	1 = Reserve pending
		.1..		PENDING	1 = Pending offline
		..1.		OFFALLOC	1 = Offline -- allocated to SCP
		...1		OFFFESCM	1 = Offline due to I/O operations
		1...		OFFCUIR	1 = Offline due to CUIR
	1..		OFFTAPE	1 = Offline due to tape
	1.		OFFHIERCH	1 = Offline due to hierarchy reason
	1		OFFOPER	1 = Offline due to operator
202	(CA)	1...		OFFLINE	1 = Offline
		.1..		INUSE	1 = Device is in use (message device only)
		..1.		OPERATIONAL	1 = Device is operational (message device only)

QUERY ENTITY SWITCH

Table 18. QUERY ENTITY SWITCH Output (continued)

Offset		Type		Len	Name(Dim)	Description
		...1		NOTOP	1 = Device is not operational (message device only)
		1...		AUTOSW	1 = Device is set autoswitch
	111 >>	*		Reserved
204	(CC)	CHARACTER		32	SW_LTOK	Logical Token (inherited from CU for this switch -- is binary zeros when not available)
236	(EC)	CHARACTER		24	RESPONDER	Responding host id
236	(EC)	CHARACTER		8	APPLNAMER	Application name
244	(F4)	CHARACTER		8	SYSPLXR	Sysplex name
252	(FC)	CHARACTER		8	SYSTEMR	System name
260	(104)	UNSIGNED		4	RCODE	Row return/reason code
264	(108)	CHARACTER		8	*	Reserved

QUERY FILE

Purpose

Use the QUERY FILE command at the API to retrieve either a single saved switch configuration or a list of all the configurations saved at a switch returned to the caller in the IHVRESP or other user-designated response area. The switch must be allocated, or attached, to the issuing I/O operations.

Syntax

```

▶▶ Query File [*filename] swchdevn ◀◀

```

Parameters

- * Specify * to get a list of the saved switch configurations that are stored at the specified switch.

filename

Specify a file name in 1 through 8 valid EBCDIC codes to obtain a single saved configuration. Valid codes are uppercase alphabetical characters (A-Z), digital characters (0-9), and 2 special characters: the underscore (_) and the hyphen (-). However, the following file names are not valid: AUX, COM n (where $n=1-4$), CON, LPT n (where $n=1-3$), NUL, or PRN.

swchdevn

Specify the switch device number in up to 4 hexadecimal digits. The switch must be allocated, or attached, to the issuing I/O operations. You can use the Display Switch command to obtain a list of these switches.

Usage

- A maximum number of saved configurations can be stored at a switch. At an IBM Director, you can store 15 saved switch configurations. In addition, the IPL

file can be loaded from, and restored at, the IBM Director. The IPL file is supplied with the unit and activated automatically when the Director is powered on.

- You can query the IPL file only if the Active=Save mode is disabled, which means when any changes being made to the active file are not being saved. (For the status of this mode, see the QFILAS field in the format of the output returned from Q F *)

Output

The format of the output from QUERY FILE *filename* is an array of 257 80-byte records. The data is returned in IHVRESP if the caller is a REXX EXEC and in a return area designated by the user if the caller is an assembler program.

- One 80-byte record is returned for each of the 256 ports that can be addressed. The format for these records is the same as given in “Output” on page 205.
- One 80-byte record is returned to identify the file in the following format:

Table 19. QUERY FILE Output of a Particular Configuration

Offset					
Dec	Hex	Type	Len	Name(Dim)	Description
0	(0)	CHARACTER	8	*	Reserved
8	(8)	CHARACTER	48	QFILBODY	Configuration file description (same format as below)
56	(38)	CHARACTER	24	*	Reserved

QUERY INTERFACE CNTLUNIT

Purpose

Use the QUERY INTERFACE CNTLUNIT command at the API to obtain data from the specified control unit regarding its interfaces.

Query Parameters

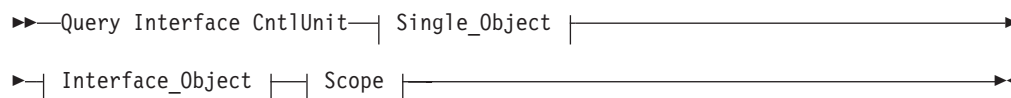

Parameters

The QUERY INTERFACE CONTROL UNIT command is designed to work only with ESCON control units because control unit interfaces are *physical* items and only ESCON control units support the architecture to return physical information. No IOCDS pathing information is used to obtain control unit interface responses unless a control specified is a coupling facility control unit. Only IOCDS pathing information is used to obtain the control unit interfaces.

The interface you specify in the command corresponds to the TAG (last 2 bytes, unsigned 2-byte value) field of the node descriptor (ND) associated with the control unit interface.

If the control unit you are querying is a dynamic switch, the interface you specify corresponds to the *port number* of the port that represents the interface.

QUERY INTERFACE CNTLUNIT

- For *object_identifier*, specify the control unit number whose interfaces you want to query.
- For *interface_identifier*, specify a single physical interface for the specified control unit.
- Specify * if you want to receive data about all the physical interfaces for the specified control unit. Output array elements are sorted by the DTAG field.
For *Interface_identifier* with Range:
- For *lower-upper*, specify an inclusive range of interfaces (or port numbers if the specified control unit is a switch control unit) on the specified control unit. Output array elements are sorted by the DTAG field.
- Specify *lower-** if you want to receive data about the interfaces from the specified interface to (and including the highest interface. Output array elements are sorted by the DTAG field.

Output

The format of the output from the QUERY INTERFACE CONTROL UNIT command is as follows:

Table 20. QUERY INTERFACE CNTLUNIT Output

Offset		Dec	Hex	Type	Len	Name(Dim)	Description
		0	(0)	STRUCTURE	*	QIU	
The header for all Query Entity/Interface output structures is not listed here. Its size is 80 bytes. For details see "Common Output Header" on page 161.							
		80	(50)	CHARACTER	312	INTERFACES(*)	CU interface descriptions
		80	(50)	BITSTRING	1		
				1...		VALID_DATA	1 = This element contains valid data
				.111 1111	*		Reserved
		81	(51)	CHARACTER	7	*	Reserved
		88	(58)	CHARACTER	32	ND_DET	Interface physical identity
		120	(78)	CHARACTER	32	ND_ATT	Interface neighbor physical identity
Attached Entity Attribute Mask							
		152	(98)	BITSTRING	4	AEAM	
				1111		LOG_CLASS	Logical entity classification..
							0 = Unspecified
							1 = Host
							2 = Chpid
							3 = Switch
							4 = Control unit
							5 = Device
							7 = Ambiguous (CHCU, etc)
							other values are reserved

Table 20. QUERY INTERFACE CNTLUNIT Output (continued)

Offset		Dec	Hex	Type	Len	Name(Dim)	Description
			 1111		PHYS_CLASS	Physical entity classification.. 0 = Unspecified 1 = Host 2 = Chpid 3 = Switch 4 = Control unit 5 = Device 6 = ESCON mod2 converter 7 = Ambiguous (link is static (no ND_ATT) and IODEF is ambiguous) 8 = CF internal path (only set for CUs) other values are reserved
153	(99)			BITSTRING	2	STATE	State of the entity
				1... ..		LOGICAL	1 = Entity is logical
				.1.. ..		P_CURR	1 = Entity is physically current
				..1.		P_HIST	1 = Entity is physical history
				...1		LOG_OTHER	1 = Logical by another interface
			 1...		P_OTHER_CURR	1 = Physical by another interface
			1..		P_OTHER_HIST	1 = Physical history by other interface
			1.		P_INDIRECT	1 = The attached ND for the entity being queried is history but we got the chpid's validity from the chpid's det ND (which is always valid) so the AEAM is marked P_CURR for the (attached) chpid 0 = The attached ND and AEAM have the same validity
			1		P_AMB	1 = Physical ambiguous configured on some interface
154	(9A)			1... ..		LOG_AMB	1 = Logical ambiguous configured on some interface
				.1.. ..		CLASS_AMB	1 = Logical and physical classes are not compatible
				..11 1111 >>	*		Reserved
End of Attached Entity Attribute Mask							
Extrapolated entity descriptions							
156	(9C)			CHARACTER	36	OTHERS	

QUERY INTERFACE CNTLUNIT

Table 20. QUERY INTERFACE CNTLUNIT Output (continued)

Offset					
Dec	Hex	Type	Len	Name(Dim)	Description
156	(9C)	CHARACTER	32	ND	Extrapolation ND. This field is only valid when AEAM.P_OTHER or AEAM.P_OTHER_HIST are set (on). This ND can be expected to contain a value when either.. <ul style="list-style-type: none"> the PID and ND validities differ (and the validity of this thing better be the same as the PID if there is a PID) There is more than 1 physical (only) path to an attached entity and the path that is being queried is not the most valid path -- this ND should contain the identity of the more (most) valid (physical) path.
		111.		NDVALID	Indicates validity of this ND
		...1 1111		*	Not explicitly referenced
157	(9D)	CHARACTER	31	*	Rest of ND
188	(BC)	UNSIGNED	2	LOG	Extrapolated logical ID This is the lowest logically defined config number assigned to the entity. This field is only valid when AEAM.LOG_OTHER is set (on).
190	(BE)	CHARACTER	2	*	Reserved
End of extrapolated entity descriptions					
192	(C0)	CHARACTER	24	RESPONDER	Responding host id
192	(C0)	CHARACTER	8	APPLNAMER	Application name
200	(C8)	CHARACTER	8	SYSPLEXR	Sysplex name
208	(D0)	CHARACTER	8	SYSTEMR	System name
216	(D8)	UNSIGNED	4	RCODE	Row return/reason code
Control unit description					
220	(DC)	CHARACTER	168	CU	
220	(DC)	UNSIGNED	2	CU_NUMBER	Control unit number
222	(DE)	CHARACTER	1	STATBITS	
		1...		*	1 = CU is defined in the IOCDS
		.1..		CU_IS_SWITCH	1 = CU is a switch control unit
		..1.		CU_IS_CF	1 = CU is a coupling facility
		...1 1111		*	Reserved
223	(DF)	UNSIGNED	1	CUADD	IOCP logical address
224	(E0)	CHARACTER	32	PID	CU's derived physical identity

Table 20. QUERY INTERFACE CNTLUNIT Output (continued)

Offset					
Dec	Hex	Type	Len	Name(Dim)	Description
256	(100)	CHARACTER	32	CU_PTOK	Physical Token remaps the NED (when the CU_IS_CF bit is off) or is an ND (when the CU_IS_CF bit is on (=1)). See macro IXLMG for definition of the ND when the CU is a coupling facility.
256	(100)	CHARACTER	32	NED	Node Element Descriptor CU's physical ID read from the control unit when this CU is not a coupling facility
		11..		NED_VALID	Validity bits for PTOK=NED 0 = Unused (not valid) 1 = Reserved 2 = Reserved 3 = Valid NED
256	(100)	CHARACTER	32	ND	Node Descriptor = CF PTOK
		111.		ND_VALID	Validity bits for PTOK=ND 0 = Valid, current 1 = Valid, not current 2 = Not valid
288	(120)	CHARACTER	4	*	Reserved
End of control unit description					
Entity Attribute Mask					
292	(124)	BITSTRING	4	EAM	
		1111		LOG_CLASS	Logical entity classification.. 0 = Unspecified 1 = Host 2 = Chpid 3 = Switch 4 = Control unit 5 = Device 7 = Ambiguous (CHCU, etc) other values are reserved

QUERY INTERFACE CNTLUNIT

Table 20. QUERY INTERFACE CNTLUNIT Output (continued)

Offset							
Dec	Hex	Type		Len	Name(Dim)	Description	
		1111		PHYS_CLASS	Physical entity classification..	
						0 = Unspecified	
						1 = Host	
						2 = Chpid	
						3 = Switch	
						4 = Control unit	
						5 = Device	
						6 = ESCON mod2 converter	
						7 = Ambiguous (link is static (no ND_ATT) and IODEF is ambiguous)	
						8 = CF internal path (only set for CUs)	
						other values are reserved	
293	(125)	BITSTRING		2	STATE	State of the entity	
		1... ..			LOGICAL	1 = Entity is logical	
		.1.. ..			P_CURR	1 = Entity is physically current	
		..1.			P_HIST	1 = Entity is physical history	
		...1			LOG_OTHER	1 = Logical by another interface	
	 1...			P_OTHER_CURR	1 = Physical by another interface	
	1..			P_OTHER_HIST	1 = Physical history by other interface	
	1.			P_INDIRECT	1 = The EAM validity was derived from the attached (ND) interfaces from the control unit	
						0 = The EAM validity was obtained from the CU itself (can only be true for opened switches)	
	1			P_AMB	1 = Physical ambiguous configured on some interface	
294	(126)	1... ..			LOG_AMB	1 = Logical ambiguous configured on some interface	
		.1.. ..			CLASS_AMB	1 = Logical and physical classes are not compatible	
		..11 1111 >>		*		Reserved	
End of Entity Attribute Mask							
296	(128)	CHARACTER		48	IODFDATA	Information from HCD	

Table 20. QUERY INTERFACE CNTLUNIT Output (continued)

Offset					
Dec	Hex	Type	Len	Name(Dim)	Description
296	(128)	UNSIGNED	4	GROUP	Group class (encoded field) 1 = DASD 2 = Tape 3 = Cluster controller 4 = Communications controller 5 = MICR/OCR 6 = Graphics 7 = Unit record device 8 = Card reader/punch 9 = Display 10 = Term printer 255 = Other
300	(12C)	CHARACTER	8	UNIT	Control Unit Type
308	(134)	CHARACTER	4	MODEL	Control Unit Model
312	(138)	CHARACTER	32	DESCRIPTION	HCD user description of this object
344	(158)	BITSTRING	1	SCPSTATE	For Coupling Facility only
		1... ..		CONNECTED	1 = MVS allows operations
		.1.. ..		MANAGED	1 = MVS policy exists
		..1. ..		AVAILABLE	1 = Physical path exists
		...1 ..		UNAVAILABLE	1 = No physical path
	 1111		*	Reserved
345	(159)	CHARACTER	3	*	Reserved
348	(15C)	CHARACTER	8	CFNAME	Coupling Facility name
356	(164)	CHARACTER	32	CU_LTOK	Logical token (is binary zeros when not available)
388	(184)	CHARACTER	4	*	Reserved

QUERY INTERFACE SWITCH

Purpose

Use the QUERY INTERFACE SWITCH command at the API to obtain data about the specified switch regarding its ports.

Query Parameters

►►—Query Interface Switch—| Single_Object |—| Interface_Object |—| Scope |—►►

Parameters

- For *object_identifier*, specify the switch device number that you want to receive data about.
- For *interface_identifier* or *, a single addressable port on the switch or * for all the addressable ports on the specified switch. Output array elements are sorted by port address. **Do not enclose the port address in parentheses for this command.**

For *Interface_identifier* with Range:

QUERY INTERFACE SWITCH

- For *lower-upper*, specify an inclusive range of port addresses on the specified switch. Output array elements are sorted by port address.
- Specify *lower-**, if you want to receive data on port addresses, starting with the specified address * to the highest implemented port address on the specified switch.
- When the CODE value in a row is set to 1, the PORTIN and PORTOUT columns of the table are queried.

Output

The format of the output from the QUERY INTERFACE SWITCH command is as follows:

Table 21. QUERY INTERFACE SWITCH Output

Offset		Dec	Hex	Type	Len	Name(Dim)	Description
		0	(0)	STRUCTURE	*	QIS	
The header for all Query Entity/Interface output structures is not listed here. Its size is 80 bytes. For details see "Common Output Header" on page 161.							
80		(50)		CHARACTER	360	PORTS(*)	Individual port data
80		(50)		UNSIGNED	1	PORT_NUMBER	Port Number
81		(51)		UNSIGNED	1	PORT_ADDRESS	Port Address (interface value)
82		(52)		BITSTRING	1		
			1... ..			VALID_DATA	1 = This PORTS element contains valid data
			.1.. ..			MID_PORT	1 = This port is midport in chain
			..1.			CHAINED	1 = This port is chained
			...1 1...			DCM_STATE	0x = This port is not DCM eligible 10 = Port is DCM eligible but not allowed for DCM activities 11 = Port is eligible and allowed for DCM activities
		111			*	Reserved
83		(53)		CHARACTER	37	PIB	Port Information Block
83		(53)		BITSTRING	4	PDB	Port descriptors
			1... ..			UNIMPLEMENTED	1 = Unimplemented port
			.1.. ..			BLOCKED	1 = Port is blocked
			..1.			SOME_PDCM_BIT_SET	1 = At least 1 prohibit
			...1			STATIC	1 = This port has static connection
		 1...			*	Reserved

QUERY INTERFACE SWITCH

Table 21. QUERY INTERFACE SWITCH Output (continued)

Offset							
Dec	Hex	Type		Len	Name(Dim)	Description	
	111		PORT_TECH	Indicates technology of port H/W 0 = Either port not installd or technology is unknown 1 = This is an internal port 3 = This port uses LED fiber 4 = This port uses LASER fiber technology Other values are reserved	
84	(54)	1... .1..		UNINSTALLED LINK_FAIL	1 = Port is not installed 1 = Link failure (hardware fence)	
		..1. ...1		SPARE OFFLINE	1 = This is a spare port 1 = Offline (hardware fence)	
		1...		MAINT_MODE	1 = In diagnostic (maint) mode	
	1..		CUP	1 = This port is a CUP	
	1.		SERVICE	1 = Service required	
	1		CFG_ERR	1 = Invalid (ND) attachment	
85	(55)	1... .1..		B_PORT PRT_NOTUSABLE	1 = This is a bridge port 1 = Port number not usable	
		..1. ...1 1...		B_PRT_DEGRADED *	1 = Bridge port degraded Reserved	
	111		B_PRT_OFFL	>0 = Bridge port held offline	
86	(56)	1... .111		ERR_THRESHOLD PORT_TT	1 = Error threshold exceed Transceiver technology valid if PORT_TECH=4: 0 = Unspecified 1 = GSM 2 = GLS 3 = GLX	
		1...		*	Reserved	
	111		PORT_PT	Protocol type: 0 = ESCON 1 = Reserved 2 = FICON Bridge 3 = FICON Fabric 4 = FICON E-Port 5 = FICON L-Port 6 = FICON G-Port	
87	(57)	UNSIGNED		1	OTHER_STATIC_PORT	Port that this port is connected to (on same switch)	

QUERY INTERFACE SWITCH

Table 21. QUERY INTERFACE SWITCH Output (continued)

Offset					
Dec	Hex	Type	Len	Name(Dim)	Description
88	(58)	BITSTRING	32	PDCM	Prohibit Dynamic Connectivity Mask 0 = Communication is allowed 1 = Communication is not allowed
120	(78)	CHARACTER	24	LNAME	Port logical name
144	(90)	UNSIGNED	1	IODEF	Port "type" 0 = Unspecified 1 = CH (channel) 2 = CU 3 = CHCU 4 = CHCH 5 = PC 6 = PCCU other values are reserved
145	(91)	CHARACTER	3	*	Reserved
148	(94)	CHARACTER	32	ND_DET	Determined ND -- "who am I"
180	(B4)	CHARACTER	32	ND_ATT	Attached ND -- "who are you"
End of switch description					
Attached Entity Attribute Mask					
212	(D4)	BITSTRING	4	AEAM	Logical entity classification.. 0 = Unspecified 1 = Host 2 = Chpid 3 = Switch 4 = Control unit 5 = Device 7 = Ambiguous (CHCU, etc) other values are reserved
		1111		LOG_CLASS	
	 1111		PHYS_CLASS	Physical entity classification.. 0 = Unspecified 1 = Host 2 = Chpid 3 = Switch 4 = Control unit 5 = Device 6 = ESCON mod2 converter 7 = Ambiguous (link is static (no ND_ATT) and IODEF is ambiguous) 8 = CF internal path (only set for CUs) other values are reserved
213	(D5)	BITSTRING	2	STATE	State of the entity
		1...		LOGICAL	1 = Entity is logical

QUERY INTERFACE SWITCH

Table 21. QUERY INTERFACE SWITCH Output (continued)

Offset				Len	Name(Dim)	Description
		.1..		P_CURR	1 = Entity is physically current
		..1.		P_HIST	1 = Entity is physical history
		...1		LOG_OTHER	1 = Logical by another interface
		1...		P_OTHER_CURR	1 = Physical by another interface
	1..		P_OTHER_HIST	1 = Physical history by other interface
	1.		P_INDIRECT	1 = The attached ND for the entity being queried is history but we got the chpid's validity from the chpid's det ND (which is always valid) so the AEAM is marked P_CURR for the (attached) chpid 0 = The attached ND and AEAM have the same validity
	1		P_AMB	1 = Physical ambiguous configured on some interface
214	(D6)	1...		LOG_AMB	1 = Logical ambiguous configured on some interface
		.1..		CLASS_AMB	1 = Logical and physical classes are not compatible
		..11	1111	>>	*	Reserved
End of Attached Entity Attribute Mask						
Extrapolated entity descriptions						
216	(D8)	CHARACTER		36	OTHERS	

QUERY INTERFACE SWITCH

Table 21. QUERY INTERFACE SWITCH Output (continued)

Offset					
Dec	Hex	Type	Len	Name(Dim)	Description
216	(D8)	CHARACTER	32	ND	Extrapolation ND. This field is only valid when AEAM.P_OTHER or AEAM.P_OTHER_HIST are set (on). This ND can be expected to contain a value when either.. <ul style="list-style-type: none"> the PID and ND validities differ (and the validity of this thing better be the same as the PID if there is a PID) There is more than 1 physical (only) path to an attached entity and the path that is being queried is not the most valid path -- this ND should contain the identity of the more (most) valid (physical) path.
		111.		NDVALID	Indicates validity of this ND
		...1 1111		*	Not explicitly referenced
217	(D9)	CHARACTER	31	*	Rest of ND
248	(F8)	UNSIGNED	2	LOG	Extrapolated logical ID This is the lowest logically defined config number assigned to the entity. This field is only valid when AEAM.LOG_OTHER is set (on).
250	(FA)	CHARACTER	2	*	Reserved
End of extrapolated entity descriptions					
252	(FC)	CHARACTER	24	RESPONDER	Responding host id
252	(FC)	CHARACTER	8	APPLNAMER	Application name
260	(104)	CHARACTER	8	SYSPLXR	Sysplex name
268	(10C)	CHARACTER	8	SYSTEMR	System name
276	(114)	UNSIGNED	4	RCODE	Row return/reason code
Switch description					
280	(118)	CHARACTER	156	SWITCH	Switch description (entity1)
280	(118)	UNSIGNED	2	SW_DEVN	Switch device number
282	(11A)	CHARACTER	1	STATBITS	
		1...		VALID_DATA	1 = This switch is in database
		.1..		VALID_SWDEVN	1 = Switch device number valid
		..1.		*	Reserved
		...1		OPEN	1 = Switch is opened (by I/O operations)
	 1...		INVALID_LSN	1 = LSN is invalid
	111		*	Reserved
283	(11B)	UNSIGNED	1	LSN	Logical switch number

QUERY INTERFACE SWITCH

Table 21. QUERY INTERFACE SWITCH Output (continued)

Offset					
Dec	Hex	Type	Len	Name(Dim)	Description
284	(11C)	CHARACTER	32	SW_P TOK	Physical Token
284	(11C)	CHARACTER	32	NED	Node Element Descriptor
316	(13C)	CHARACTER	32	PID	Unique (physical) ID (same format as in HDR)
348	(15C)	UNSIGNED	1	NPINST	Number of installed ports
349	(15D)	UNSIGNED	1	NPIM	Number of implemented ports (ports ABLE to be installed)
350	(15E)	UNSIGNED	1	OP_STATUS	Operational status 0 = Unspecified 1 = Not open 2 = In contention 3 = H/W error 4 = System error 5 = I/O error 6 = Operational 7 = Reserved 8 = Read only (HCP set) Other values are reserved
351	(15F)	UNSIGNED	1	A_CUP	CUP port address
352	(160)	UNSIGNED	4	STATUS_CODE	Error code (if any)
End of switch description					
Entity Attribute Mask					
356	(164)	BITSTRING	4	EAM	
		1111		LOG_CLASS	Logical entity classification.. 0 = Unspecified 1 = Host 2 = Chpid 3 = Switch 4 = Control unit 5 = Device 7 = Ambiguous (CHCU, etc) other values are reserved
	 1111		PHYS_CLASS	Physical entity classification.. 0 = Unspecified 1 = Host 2 = Chpid 3 = Switch 4 = Control unit 5 = Device 6 = ESCON mod2 converter 7 = Ambiguous (link is static (no ND_ATT) and IODEF is ambiguous) 8 = CF internal path (only set for CUs) other values are reserved
357	(165)	BITSTRING	2	STATE	State of the entity
		1...		LOGICAL	1 = Entity is logical

QUERY INTERFACE SWITCH

Table 21. QUERY INTERFACE SWITCH Output (continued)

Offset							
Dec	Hex	Type		Len	Name(Dim)	Description	
		.1..		P_CURR	1 = Entity is physically current	
		..1.		P_HIST	1 = Entity is physical history	
		...1		LOG_OTHER	1 = Logical by another interface	
		1...		P_OTHER_CURR	1 = Physical by another interface	
	1..		P_OTHER_HIST	1 = Physical history by other interface	
	1.		P_INDIRECT	1 = The EAM validity was derived from the attached (ND) interfaces from the control unit	
	1		P_AMB	1 = Physical ambiguous configured on some interface	
358	(166)	1...		LOG_AMB	1 = Logical ambiguous configured on some interface	
		.1..		CLASS_AMB	1 = Logical and physical classes are not compatible	
		..11	1111 >>	*		Reserved	
End of Entity Attribute Mask							
360	(168)	CHARACTER		32	IODFDESC	HCD's user description of this object	
392	(188)	CHARACTER		7	ECLEVEL	Hardware EC level	
399	(18F)	UNSIGNED		1	LOWPORT	Lowest port address on this switch	
400	(190)	BITSTRING		4	SCPSTATE	Operating system state	
		1...		BOXED	1 = Boxed	
		.1..		NOTREADY	1 = Not ready	
		..1.		BUSY	1 = Busy	
		...1		RESERVED	1 = Reserved	
		1...		ALLOCATED	1 = Allocated	
	1..		ONLINE	1 = Online	
	1.		UNLOAD	1 = Unload pending	
	1		MOUNT	1 = Mount pending	
401	(191)	1...		RESPENDING	1 = Reserve pending	
		.1..		PENDING	1 = Pending offline	
		..1.		OFFALLOC	1 = Offline -- allocated to SCP	
		...1		OFFFESCM	1 = Offline due to I/O operations	
		1...		OFFCUIR	1 = Offline due to CUIR	
	1..		OFFTAPE	1 = Offline due to tape	

Table 21. QUERY INTERFACE SWITCH Output (continued)

Offset		Type		Len	Name(Dim)	Description
Dec	Hex1.			
	1		OFFHIERCH	1 = Offline due to hierarchy reason
	1		OFFOPER	1 = Offline due to operator
402	(192)	1...		OFFLINE	1 = Offline
		.1..		INUSE	1 = Device is in use (message device only)
		..1.		OPERATIONAL	1 = Device is operational (message device only)
		...1		NOTOP	1 = Device is not operational (message device only)
		1...		AUTOSW	1 = Device is set autoswitch
	111 >>	*		Reserved
404	(194)	CHARACTER		32	SW_LTOK	Logical Token (inherited from CU for this switch -- is binary zeros when not available)
436	(1B4)	CHARACTER		4	*	Reserved

QUERY RELATION CHP

Purpose

Use the QUERY RELATION CHP command at the API to obtain data regarding the IOCDS relationship between the two specified entities (objects). Output is based on IOCDS definitions, but it can be influenced by configuration mismatches that have been detected by I/O operations.

Query Parameters

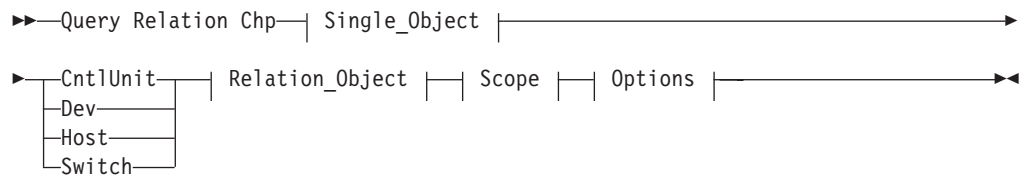

Parameters

- This command returns data about the logical relationships (in IOCDS) between the first entity, which is a single CHPID, and the second entity or entities.
- For a QUERY RELATION command, the first entity (host name) must be known to the issuing I/O operations (primary host). The command returns an indication whether the specified CHPID is defined in IOCDS to the issuing I/O operations.
- If you specify switches as the second entity, the command returns an indication whether the CHPID in the first entity has defined paths through the switches.

QUERY RELATION CNTLUNIT

Purpose

Use the QUERY RELATION CNTLUNIT command at the API to obtain data regarding the IOCDS relationship between the two specified entities (objects). Output is based on IOCDS definitions, but it can be influenced by configuration mismatches that have been detected by I/O operations.

Query Parameters

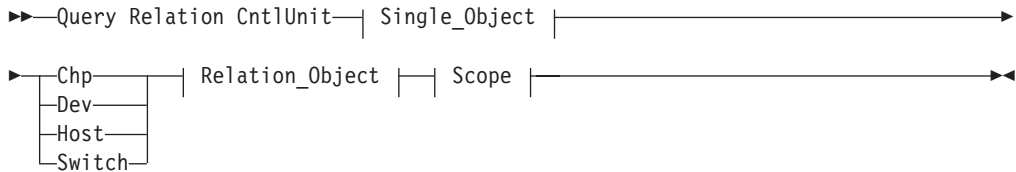

Parameters

- This command returns data about the relationships between the specified control unit and the second entity in the command.
- If the second entity is Host and the issuing I/O operations is included in the parameters, this command returns indications of what CHPIDs have (IOCDS) defined paths to the control unit specified in the first entity.
- If the second entity is Host and a voting I/O operations is included in the parameters, this command returns only an indication that the I/O operations (secondary host) known to the issuing I/O operations. No pathing data can be returned.
- If the second entity is Chp, the command returns indications of whether the specified CHPIDs have (IOCDS) defined paths to the specified control unit for the issuing I/O operations (primary host).
- If the second entity is Switch, the command returns indications of whether the control unit specified has (IOCDS) defined paths through the specified switch(es) for the issuing I/O operations.
- If the second entity is Dev, the command returns indications of whether the specified control unit has (IOCDS) defined paths through the specified devices for the issuing I/O operations.

QUERY RELATION DEV

Purpose

Use the QUERY RELATION DEV command at the API to obtain data regarding the IOCDS relationship between the two specified entities (objects). Output is based on IOCDS definitions, but it can be influenced by configuration mismatches that have been detected by I/O operations.

Query Parameters

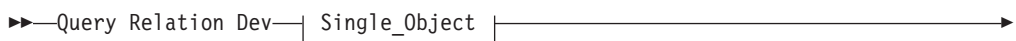

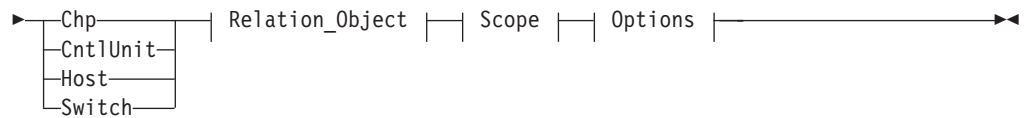

Parameters

- This command returns data about the relationships between the specified device and the second entity in the command.
- If the second entity is Host and the issuing I/O operations is specified, the command returns indications of whether the device has (IOCDS) defined paths to that host. If a voting I/O operations is specified, an indication is returned that the host is known, but pathing information is not available.
- If the second entity is Chp, the command returns indications of whether the specified device has (IOCDS) defined paths to the specified CHPID(s).
- If the second entity is Switch, the command returns indications of whether the control unit specified has (IOCDS) defined paths through the specified switch(es) for the issuing I/O operations.
- If the second entity is CntlUnit, the command returns indications of whether the specified control unit(s) have (IOCDS) defined paths through them to the specified device for the issuing I/O operations.

Notes:

1. When ARRAY is the *Object_format_type*, the *Object_Identifier_Types* can be mixed and every *Object_Identifier_Type* must match the class of the specified *Object_Type* (all must be I/O_resources or all must be Hosts). For example, Q E HOST can accept only HOST and XSYS entries in the array.
2. The Array_header contains the number of elements in the array.
3. PTOK is valid with RANGE but you should be fully aware of PTOK structure. For example, RANGE PTOK could be used to specify all of the serial numbers of a certain type of device. However, certain PTOK values may cause unpredictable results with RANGE.
4. When ARRAY is the *SCOPE_format_type*, the *Host_Object_Identifier_Types* can be mixed (HOST and XSYS).
5. If you need to translate a QUERY RELATION command to a new format due to an overflow condition reported by a return code and reason code, you may need to begin the new command with the *last* value that was returned or some pathing information could be lost.

QUERY RELATION HOST

Purpose

Use the QUERY RELATION HOST command at the API to obtain data regarding the IOCDS relationship between the two specified entities (objects). Output is based on IOCDS definitions, but it can be influenced by configuration mismatches that have been detected by I/O operations.

Query Parameters

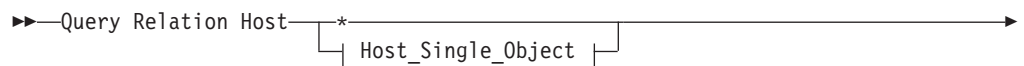

QUERY RELATION HOST

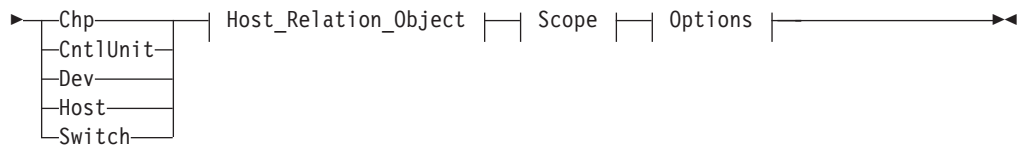

Parameters

- For a QUERY RELATION command, the first entity (host name) must be known to the issuing I/O operations (primary host).
- For Q R H S, you can specify any I/O operations that participates in vary path consensus processing initiated by the issuing I/O operations. However, data indicating CHPID attachments to the switches is returned only for the issuing I/O operations

Notes:

1. When ARRAY is the *Object_format_type*, the *Object_Identifier_Types* can be mixed and every *Object_Identifier_Type* must match the class of the specified *Object_Type* (all must be I/O_resources or all must be Hosts). For example, Q E HOST can accept only HOST and XSYS entries in the array.
2. The Array_header contains the number of elements in the array.
3. PTOK is valid with RANGE but you should be fully aware of PTOK structure. For example, RANGE PTOK could be used to specify all of the serial numbers of a certain type of device. However, certain PTOK values may cause unpredictable results with RANGE.
4. When ARRAY is the *SCOPE_format_type*, the *Host_Object_Identifier_Types* can be mixed (HOST and XSYS).

QUERY RELATION SWITCH

Purpose

Use the QUERY RELATION SWITCH command at the API to obtain data regarding the IOCDS relationship between the two specified entities (objects). Output is based on IOCDS definitions, but it can be influenced by configuration mismatches that have been detected by I/O operations.

Query Parameters

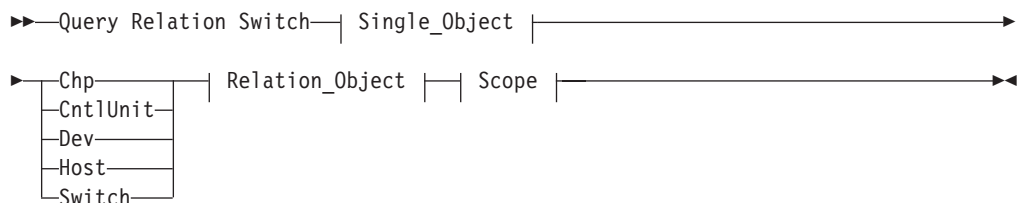

Parameters

- This command returns data about the relationships between the specified switch and the second entity in the command.
- If you specify the issuing I/O operations (host) as the second entity, 1 ROW is returned for each channel that I/O operations perceives as being connected to

the switch. (If the physical settings at the switch indicate differently from the IOCDs, I/O operations “perceives” the physical settings to be accurate.)

If the switch specifies the destination switch of a cascaded switch pair, the relationship will return one row for each CHP that defines a path to the CUP device of the switch with the following differing information:

- the output port information shows X'FE' indicating the CUP device of a cascaded switch
- If you specify a voting I/O operations (host) as the second entity, only 1 ROW is returned, indicating that the host is able to communicate with, and control, the switch. No CHPIDs are returned, and the incomplete bit is set for that host.
- If you specify CHP as the second entity, the command returns indications of what channel(s) are defined in IOCDs to be attached to the switch. To obtain data on what channels are defined to communicate with a switch, specify Q R CU C, specifying the control unit port, or the Q R D C, specifying the switch device number.
- If you specify Switch as the second entity, the command returns indications:
 - of what chains have been established with the first entity (ESCON only)
 - whether both switches build the entry and destination switch of any path defined (FICON only)
- If you specify CntlUnit or Dev as the second entity, the command returns indications whether the specified switch has IOCDs-defined paths through it to the specified control units or devices.

QUERY SWITCH

Purpose

Use the QUERY SWITCH command at the API to obtain an array of port information blocks (PIBs) and related data from the specified switch.

Syntax

►►—Query Switch—*swchdevn*—►►

Parameters

swchdevn

Specifies the switch to be queried. The switch must be allocated to, or attached to, the issuing I/O operations. Refer to *System Automation for z/OS Operator's Commands* for further information about switches.

Output

The data is presented as an array of 80-byte entries, as shown below. 256 entries are returned. (The first array is for port address 00.)

Table 22. QUERY SWITCH Output

Offset					
Dec	Hex	Type	Len	Name(Dim)	Description
0	(0)	STRUCTURE	80	QSWT	
0	(0)	BITSTRING	1	QSWTFLAG1	Flags byte 1

QUERY SWITCH

Table 22. QUERY SWITCH Output (continued)

Offset							
Dec	Hex	Type	Len	Name(Dim)	Description		
		1... ..		QSWTLAST	End of list indicator		
					0 = More records		
					1 = Last record in array		
		.1.. ..		QSWTMDPT	Midport		
					1 = This port is the midport of a defined chain		
		..11 ..		QSWTFORM	Format id		
					0 = Format 0 (original format)		
	 1111		*	Reserved		
1	(1)	BITSTRING	1	QSWTFLAG2	Flags byte 2		
		1111 11..		*	Reserved		
	11		QSWT_DCM_STATE	0x = Port not DCM eligible		
					10 = Port DCM eligible but not allowed for DCM activities		
					11 = Port DCM eligible and allowed for DCM activities		
2	(2)	UNSIGNED	2	QSWTSWIT	Switch device number		
4	(4)	CHARACTER	48	QSWTLAIB	Port information block		
4	(4)	CHARACTER	1	*	Reserved		
5	(5)	UNSIGNED	1	LAIBNUMB	Port number		
6	(6)	UNSIGNED	1	LAIBADDR	Port address		
7	(7)	CHARACTER	1	*	Reserved		
8	(8)	BITSTRING	4	LAIBDESC	Port descriptors		
		1... ..		LAIBUNMP	Port implementation		
					0 = Port is implemented		
					1 = Port is not implemented		
		.1.. ..		LAIBFBIT	Port fence information		
					0 = Port is not blocked		
					1 = Port is blocked		
		..1.		LAIBIC	Prohibit port connection		
					0 = No prohibits for this port		
					1 = Prohibits defined		
		...1		LAIBSBIT	Port connection		
					0 = Port is not connected		
					1 = Port is connected		
	 1...		*	Reserved		
	111		LAIBLED	Port hardware		
					0 = Unspecified		
					1 = Internal		
					2 = Electrical		
					3 = LED fiber optic		
					4 = Laser fiber optic		
9	(9)	1... ..		LAIBNBIT	1 = Not installed		
		.1.. ..		LAIBLFBIT	1 = Link failure		
		..1.		LAIBSP	1 = Swapped port		
		...1		LAIBOLBIT	1 = Offline		

Table 22. QUERY SWITCH Output (continued)

Offset							
Dec	Hex	Type	Len	Name(Dim)	Description		
	 1...		LAIBDMBIT	1 = Port in maintenance mode		
	1..		LAIBCUPBIT	1 = This port is a CUP		
	1.		LAIBSERVICE	1 = Service required		
	1		LAIBINVATT	1 = Port has an invalid attachment		
10	(A)	1...		LAIBBRGPRT	1 = This is a bridge port		
		.1..		LAIBPRTNNU	1 = Port number not usable		
		..1.		LAIBBPDEG	1 = Bridge port degraded		
		...1 1...		*	Reserved		
	111		LAIBBPOFF	>0 = Bridge port held offline		
11	(B)	1...		LAIBETE	1 = Error threshold exceeded		
		.111		LAIBTT	Transeiver technology		
					0 = Unspecified		
					1 = GSM		
					2 = GLS		
					3 = GLX		
	 1...		*	Reserved		
	111		LAIBPT	Protocol type:		
					0 = ESCON		
					1 = Reserved		
					2 = FICON Bridge		
					3 = FICON Fabric		
					4 = FICON E-Port		
					5 = FICON L-Port		
					6 = FICON G-Port		
12	(C)	CHARACTER	1	*	Reserved		
13	(D)	UNSIGNED	1	LAIBESVR	Number of ESCON server ports		
14	(E)	UNSIGNED	1	LAIBSADR	Static connection address		
15	(F)	CHARACTER	5	*	Reserved		
20	(14)	BITSTRING	32	LAIBICM	Port prohibit dynamic connection mask (PDCM)		
52	(34)	CHARACTER	24	QSWTNAME	Port logical name		
76	(4C)	UNSIGNED	2	QSWTCSWIT	Switch device number for chained device		
78	(4E)	UNSIGNED	1	QSWTCPORT	Chained port address		
79	(4F)	CHARACTER	1	*	Reserved		

Examples

Note: If a port is not implemented, only the switch number, port address, and unimplemented bit contain valid data; all other fields are set to binary zeros.

The following sample output shows that port address *F3* has been assigned port name *0500X0600*. It is statically connected to port address *E1* on switch device number *0500*. As one would expect from the port name, port address *F3* is chained to port address *D0* on switch device number *0600*.

Object_identifier_pair:

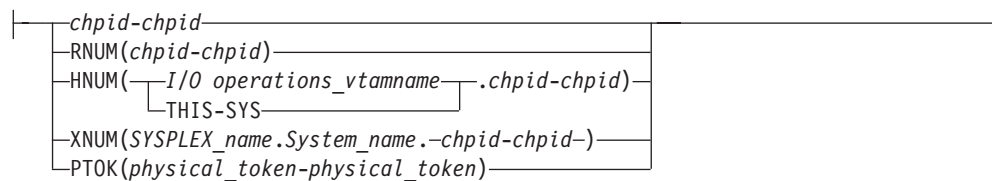

Scope:

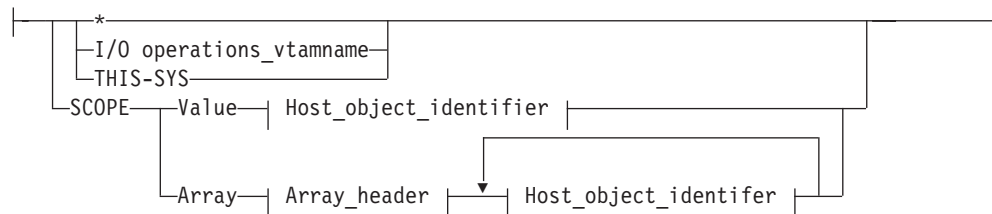

Host_object_identifier:

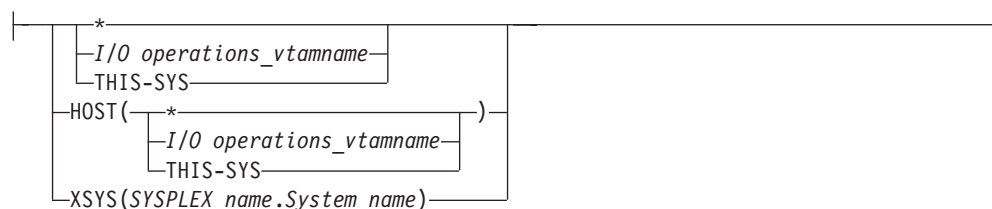

Process_options

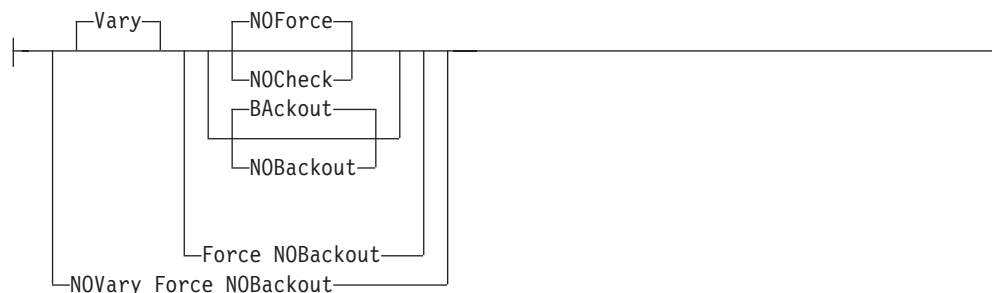

Output_options:



Parameters

A host identifier type can be one of the following keywords:

Vary

This is the default option and it indicates that appropriate processing must be done at the host to support the REMOVE and RESTORE CHP commands.

NOVary

This option is not valid for the REMOVE and RESTORE CHP commands.

Force

This option says to execute the command in the best manner possible. For example, if one of the specified hosts does not respond, the command is still performed on all other hosts.

NOForce

This is the default option and indicates that if there is any failure, the command should not continue and a return and reason describing the failure will be returned.

NOCheck

The NOCheck option overrides the detection of two conditions that would cause the failure of the command under the default NOForce option:

1. Detection of systems in the scope of the command on which I/O operations is not operating.
2. Detection of downlevel I/O operations's operating on systems in the scope of the command.

If either of these conditions are detected, a return code of 4 is returned.

Backout

This is the default option and indicates that if any failure is reported by any of the participating systems, any successful REMOVE and RESTORE CHP actions for all the participating host systems will be backed out.

NOBackout

This option indicates that if any error condition is detected during the REMOVE and RESTORE CHP processing, I/O operations will not attempt to change any REMOVE and RESTORE CHP actions that have been performed.

CONDitional

This is the default option for both the REMOVE and RESTORE CHP commands. It indicates that no special configure offline or configure online action should be performed.

UNCONDitional

For the REMOVE CHP command, this option puts the specified chpids immediately into pending offline status, even if the chpids are currently active, allocated, or reserved.

For the RESTORE CHP command, this option brings the specified chpids online, even if there are no paths to the chpids, or if the chpids are pending offline and boxed.

OUTputALL

This is the default and it allows all results from REMOVE and RESTORE CHPs performed (regardless of return code) to be returned to the API invoker.

OUTputERRor

This option allows only error results (REMOVE and RESTORE CHPs that had

a return code ≥ 4 , plus other errors that occurred during the processing of the command) to be returned to the API invoker.

OUTputNone

This option allows only the return and reason code (no text information) to be returned to the API invoker. If the return code from the command is ≥ 4 , a detailed message (IHVC00I, IHVC001I, or IHVC002I) is also returned.

Notes:

1. This form, with no keyword, is supported for compatibility with the previously existing syntax of this command.
2. ARRAY has no short form for this command (in other multisystem commands A is used as a short form). That is to avoid the need to look ahead in parsing "Remove Chp A..." to distinguish between removing the CHP with ID 'A' and removing an array of CHPs.
3. In this command, THIS-SYS is a means to refer to the primary host (the one to which the command is being input). It is accepted by the primary regardless of whether VTAM is operational or not.
4. When ARRAY is the *Object_format_type*, the *Object_Identifier_Types* may be mixed (for example, HOST and XSYS), and every *Object_Identifier_Type* must be an I/O resource type. For example, an HNUM and an XNUM entry can be in the same array.
5. The Array_header contains the number of elements in the array.
6. PTOK is valid with RANGE but you should be fully aware of PTOK structure. Certain PTOK values may cause unpredictable results with RANGE
7. When ARRAY is the *SCOPE_format_type*, the *Host_Object_Identifier_Types* may be mixed (for example, HOST and XSYS).

REMOVE DEV and RESTORE DEV

Purpose

Use the REMOVE DEV command at the I/O operations API to configure a device or devices offline to one or more hosts.

Use the RESTORE DEV command at the I/O operations API to configure a device or devices online to one or more hosts.

Syntax

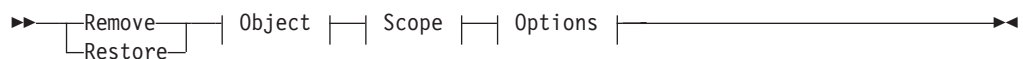

Object:



REMOVE DEV and RESTORE DEV

Object_format

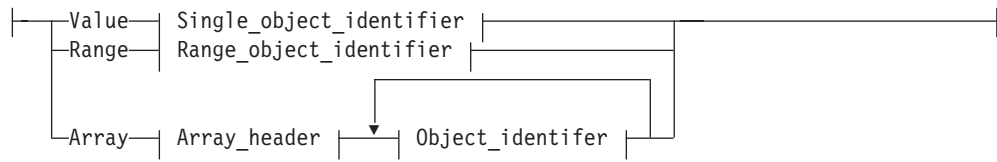

Single_object_identifier:

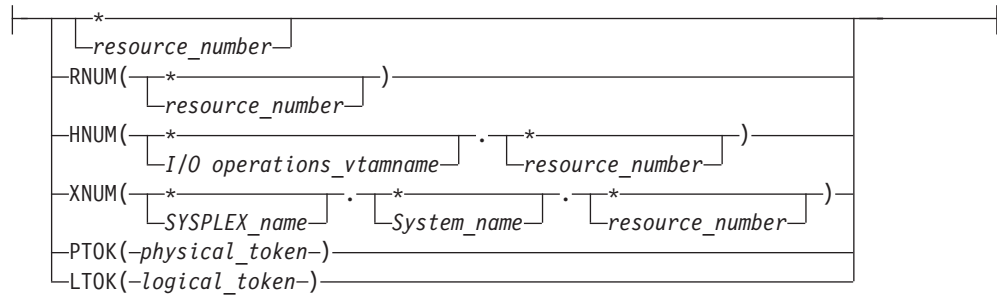

Range_object_identifier:

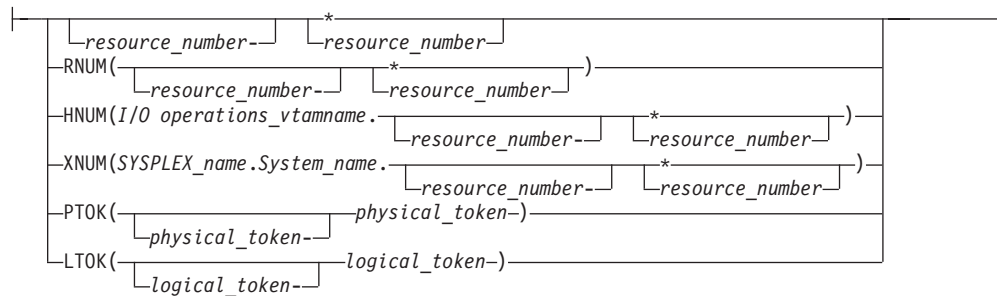

Scope:

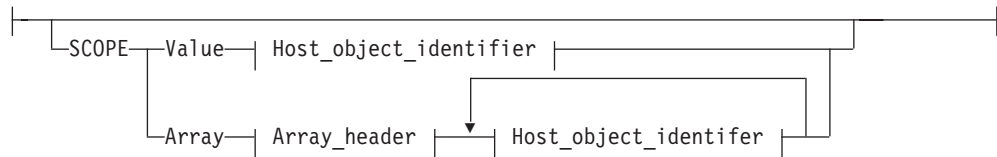

Host_object_identifier:

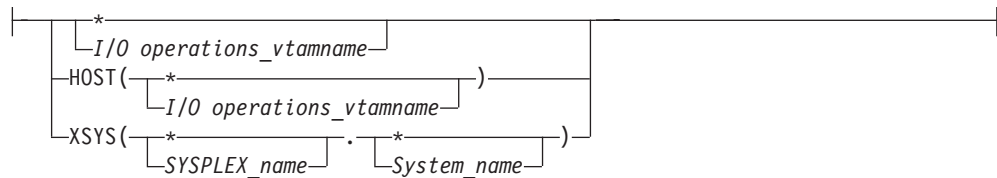

Process_options:

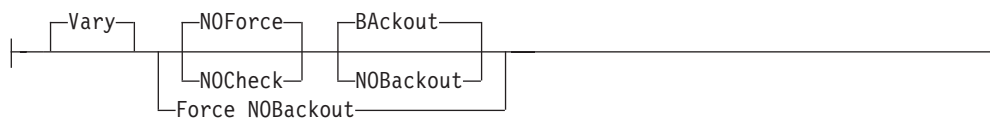
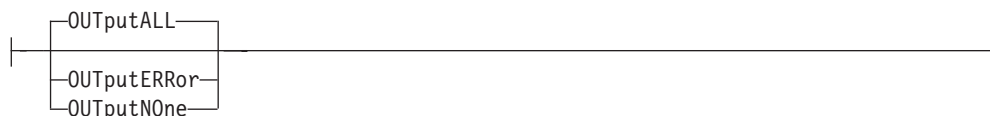
**Remove/Restore_command_options:****Output_options:****Parameters**

A host identifier type can be one of the following keywords:

Vary

This is the default option and it indicates that appropriate processing must be done at the host to support the REMOVE and RESTORE DEVICE commands.

Note: This does not mean that the paths to this device are varied.

NOVary

This option is not valid for the REMOVE and RESTORE DEVICE commands.

Force

This option says to execute the command in the best manner possible. For example, if one of the specified hosts does not respond, the command is still performed on all other hosts.

NOForce

This is the default option and indicates that if there is any failure, the command should not continue and a return and reason describing the failure will be returned.

NOCheck

The NOCheck option overrides the detection of two conditions that would cause the failure of the command under the default NOForce option:

1. Detection of systems in the scope of the command on which I/O operations is not operating.
2. Detection of downlevel ESCON Managers operating on systems in the scope of the command.

If either of these conditions is detected, a return code of 4 is returned.

BACKout

This is the default option and indicates that if any failure is reported by any of the participating systems, any successful REMOVE and RESTORE DEVICE actions for all the participating host systems will be backed out.

REMOVE DEV and RESTORE DEV

NOBackout

This option indicates that if any error condition is detected during the REMOVE and RESTORE DEVICE processing, I/O operations will not attempt to change any REMOVE and RESTORE DEVICE actions that have been performed.

CONDitional

This is the default option for both the REMOVE and RESTORE DEVICE commands. It indicates that no special Vary offline or Vary online action should be performed.

UNCONDitional

For the REMOVE DEVICE command, this option puts the specified devices immediately into pending offline status, even if the devices are currently active, allocated, or reserved.

For the RESTORE DEVICE command, this option brings the specified devices online, even if there are no paths to the devices, or if the devices are pending offline and boxed. This option is ignored if it is specified for a tape or a direct access device.

SHaRe

For the REMOVE DEVICE command, this option provides no function.

For the RESTORE DEVICE command, this option permits any device that supports multisystem assign to be shared among other processors. If the device does not support multisystem assign, this option is ignored.

REset

For the REMOVE DEVICE command, this option provides no function.

For the RESTORE DEVICE command, this option allows the device to be varied online even if it is currently in use by control unit initiated reconfiguration.

AutoSwitch

The AutoSwitch option is valid only for a tape device such as an IBM 3480 or 3490 (or equivalent). You use Restore Dev AutoSwitch to set the option on and Remove Dev AutoSwitch to set the option off.

Setting AutoSwitch on allows a tape device to be switched serially from one system to another in a sysplex environment without the need for operator intervention.

Note: A coupling facility is required for sysplex tape sharing to be available.

OUTputALL

This is the default and it allows all results from REMOVE and RESTORE DEVICE actions that have been performed (regardless of return code) to be returned to the API invoker.

OUTputERRor

This option allows only error results (that is, REMOVE and RESTORE DEVICE actions with a return code ≥ 4 , plus other errors that occurred during the processing of the command) to be returned to the API invoker.

OUTputNone

This option allows only the return and reason code (no text information) to be returned to the API invoker. If the return code from the command is ≥ 4 , a detailed message (IHVC00I, IHVC001I, or IHVC002I) is also returned.

Notes:

1. When ARRAY is the *Object_format_type*, the *Object_Identifier_Types* can be mixed and every *Object_Identifier_Type* must be an I/O resource type. For example, an HNUM and an XNUM entry can be in the same array.
2. The Array_header contains the number of elements in the array.
3. PTOK is valid with RANGE but you should be fully aware of PTOK structure. For example, RANGE PTOK could be used to specify all of the serial numbers of a certain type of device. However, certain PTOK values may cause unpredictable results with RANGE
4. When ARRAY is the *SCOPE_format_type*, the *Host_Object_Identifier_Types* can be mixed (HOST and XSYS).

Output

The format of the output from the REMOVE DEV and RESTORE DEV command is as follows:

Table 23. REMOVE DEV and RESTORE DEV Output

Offset					
Dec	Hex	Type	Len	Name(Dim)	Description
0	(0)	STRUCTURE	*	VDCB	
0	(0)	CHARACTER	80	VDCB_HDR	VDCB header
0	(0)	CHARACTER	4	VDCH_ID	Eyecatcher ('VDCB')
4	(4)	UNSIGNED	2	VDCH_HLEN	Header length
6	(6)	UNSIGNED	2	VDCH_RLEN	Row length
8	(8)	UNSIGNED	4	VDCH_NR	Number of rows
12	(C)	UNSIGNED	4	VDCH_NHR	Number of host summary rows
16	(10)	UNSIGNED	1	VDCH_FMTID	Format id
17	(11)	CHARACTER	7	*	Reserved
Information on the command and options					
24	(18)	BITSTRING	2	VDCH_CMD	Vary device command flags
		1...		VDCH_VOFF	1 = Vary OFF device
		.1..		VDCH_VON	1 = Vary ON device
		..1.		VDCH_VBKOUT	1 = Vary backout initiated
		...1 1111 >>		*	Reserved
26	(1A)	BITSTRING	2	VDCH_OPTIONS	Vary device options flags
		1...		VDCH_FORCE	1 = Force specified
		.1..		VDCH_NOFORCE	1 = NOForce specified
		..1.		VDCH_BKOUT	1 = BACkout specified
		...1		VDCH_NOBKOUT	1 = NOBackout specified
	 1...		VDCH_NOCHECK	1 = Nocheck specified
	1..		VDCH_COND	1 = CONDitional specified
	1.		VDCH_UNCOND	1 = UNConditonal specified
	1		VDCH_SHARE	1 = SHare specified
27	(1B)	1...		VDCH_RESET	1 = REset specified
		.1..		VDCH_AUTOSW	1 = AutoSwitch specified
		..11 1111		*	Reserved
28	(1C)	CHARACTER	4	*	Reserved
Invoker's system and user ID					
32	(20)	CHARACTER	16	VDCH_USER	
32	(20)	CHARACTER	8	VDCH_SYSID	System ID
40	(28)	CHARACTER	8	VDCH_USRID	User ID

REMOVE DEV and RESTORE DEV

Table 23. REMOVE DEV and RESTORE DEV Output (continued)

Offset					
Dec	Hex	Type	Len	Name(Dim)	Description
Information on primary responding host					
48	(30)	CHARACTER	8	VDCH_APPL	I/O operations VTAM application name
56	(38)	CHARACTER	16	VDCH_SYSPLEX	
56	(38)	CHARACTER	8	VDCH_SPLX	Sysplex name
64	(40)	CHARACTER	8	VDCH_SYST	System name
72	(48)	CHARACTER	4	VDCH_ESCMREL	SA z/OS release
76	(4C)	CHARACTER	4	*	Reserved
Vary device information					
80	(50)	STRUCTURE	296	VDCB_ROW(*)	
80	(50)	UNSIGNED	2	VDCR_FORMAT	Row format code
82	(52)	CHARACTER	6	*	Reserved
Responding host					
88	(58)	CHARACTER	8	VDCR_APPL	I/O operations VTAM application name
96	(60)	CHARACTER	16	VDCR_SYSPLEX	
96	(60)	CHARACTER	8	VDCR_SPLX	Sysplex name
104	(68)	CHARACTER	8	VDCR_SYST	System name
Device identification					
112	(70)	BITSTRING	2	VDCR_FLAGS	Vary device flags
		1...		VDCR_RNUMV	1=RNUM is valid
		.111 1111		*	Reserved
113	(71)	1...		VDCR_COUPL	1 = Device is a coupling facility
		.1..		VDCR_NOVARY	1 = Don't vary device for row
		..1.		VDCR_NOTFND	1 = Device not found for host
		...1		VDCR_BKOUT	1 = Backout attempted, msg present
	 1111		*	Reserved
114	(72)	UNSIGNED	2	VDCR_DEVNUM	Device number
116	(74)	BITSTRING	4	VDCR_SCPSTS	Operating system state
120	(78)	CHARACTER	32	VDCR_PTOKN	Physical token
152	(98)	CHARACTER	32	VDCR_LTOKN	Logical token
Vary results					
184	(B8)	CHARACTER	96	VDCR_VRESULTS	
184	(B8)	BITSTRING	2	VDCR_VFLAGS	Vary flags
		1...		VDCR_VMVS_MSG	1 = Vary message is MVS
		.1..		VDCR_VDBCS	1 = Vary message is DBCS
		..11 1111 >>		*	Reserved
186	(BA)	CHARACTER	2	*	Reserved
188	(BC)	UNSIGNED	4	VDCR_VESCMRC	I/O operations Severity code (used for backout, msg screen)
The following information is valid only when VDCR_NOVARY is not set					
192	(C0)	UNSIGNED	4	VDCR_VMVSRC	Return code from VARYDEV macro
196	(C4)	UNSIGNED	4	VDCR_VMVSRN	Reason Code from VARYDEV macro

Table 23. REMOVE DEV and RESTORE DEV Output (continued)

Offset					
Dec	Hex	Type	Len	Name(Dim)	Description
200	(C8)	CHARACTER	80	VDCR_VMVSMMSG	Msg from VARYDEV macro or I/O operations based on macro RC/RSN
Backout results					
280	(118)	CHARACTER	96	VDCR_BRESULTS	
280	(118)	BITSTRING	2	VDCR_BFLAGS	Backout flags
		1... ..		VDCR_BMVS_MSG	1 = Backout message is MVS
		.1.. ..		VDCR_BDBCS	1 = Backout message is DBCS
		..11 1111 >>	*	*	Reserved
282	(11A)	CHARACTER	2	*	Reserved
284	(11C)	UNSIGNED	4	VDCR_BESCMRC	I/O operations Severity code
The following information is valid only when I/O operations backout occurs (VDCH_BKOUT=1) and there are no communication errors reported					
288	(120)	UNSIGNED	4	VDCR_BMVSRM	Return code from VARYDEV macro
292	(124)	UNSIGNED	4	VDCR_BMVSRSN	Reason code from VARYDEV macro
296	(128)	CHARACTER	80	VDCR_BMVSMMSG	Msg from VARYDEV macro or I/O operations based on macro RC/RSN

WRITEFILE

Purpose

Use the WRITEFILE command at the I/O operations API to store a saved switch configuration at the switch specified in the command.

To use the WRITEFILE command, the switch must be allocated, or attached, to the issuing I/O operations.

Syntax

►►—WRITEFILE—*filename*—*filedescriptor*—*datablock*—►►

Parameters

filename

Specify the file name in 1 through 8 valid EBCDIC codes. Valid codes are uppercase alphabetical characters (A-Z), digital characters (0-9), and 2 special characters: the underscore (_) and the hyphen (-). However, the following file names are not valid: AUX, COM n (where $n=1-4$), CON, LPT n (where $n=1-3$), NUL, or PRN.

filedescriptor

Specify the file descriptor in exactly 24 characters in the range X'40' through X'FE'.

WRITEFILE

datablock

Specify a 20480-byte data block in the format listed under the Query Switch command. The data block allows an 80-byte record for 256 ports. Specify the ports in ascending hexadecimal order.

Usage

- A maximum number of saved switch configurations can be stored at a switch. At an IBM Director, you can store up to 15 saved configurations. In addition, you can load and restore the IPL file, which is supplied with each Director and is activated automatically when the unit is powered on.
- You can only write the IPL file if the Active=Save Mode at the switch is disabled. If the mode is disabled, any changes being made to the active configuration at the switch are not saved. The mode setting is displayed on the screen of the switch console. The status is also returned in the QFILAS field in the output returned with the Q F * command.
- You must specify the switch device number in the data block., (Unlike the WRITESWCH command, the switch device number in the Writefile command must be the same in each record.)
- If you do not want to write an entire block, you can edit an existing one. For example, you can use the Query File command to get a file, edit it, and then use the WRITEFILE command to store it.

Input

Each 80-byte record of the WRITEFILE data block has the following format:

Table 24. WRITEFILE Input Format

Offset					
Dec	Hex	Type	Len	Name(Dim)	Description
0	(0)	STRUCTURE	80	WTFL	Writefile record
0	(0)	BITSTRING	1	WTFLFLAG1	End of list indicator 0 = More records in list 1 = Last record in list
		1... ..		WTFLLAST	
		.1..	*		Reserved
		..11		WTFLFORM	Format id 00 = Format 0 (original format)
	 1111	*		Reserved
1	(1)	CHARACTER	1	*	Reserved
2	(2)	UNSIGNED	2	WTFLSWIT	Switch device number
4	(4)	CHARACTER	48	WTFLLAIB	Switch port information block
4	(4)	CHARACTER	2	*	Reserved
6	(6)	UNSIGNED	1	LAIBADDR	Port address
7	(7)	CHARACTER	1	*	Reserved
8	(8)	BITSTRING	4	LAIBDESC	Port descriptors
		1... ..		LAIBUNMP	Port implementation 0 = Implemented port 1 = Unimplemented port
		.1..		LAIBFBIT	Blocked port 0 = Port is not blocked 1 = Port is blocked
		..1.		LAIBIC	Prohibited port connection 0 = No prohibits for this port 1 = Prohibits defined
		...1		LAIBSBIT	Port connection 0 = Port is not connected 1 = Port is connected
	 1111 >>	*		Reserved
12	(C)	CHARACTER	2	*	Reserved
14	(E)	UNSIGNED	1	LAIBSADR	Static connection address
15	(F)	CHARACTER	5	*	Reserved
20	(14)	BITSTRING	32	LAIBICM	Link ICM
52	(34)	CHARACTER	24	WTFLNAME	Port logical name
76	(4C)	CHARACTER	4	*	Reserved

WRITEPORT

Purpose

Use the Writeport command at the I/O operations API to define or to change the connectivity attributes for a single port on a specified switch.

Syntax

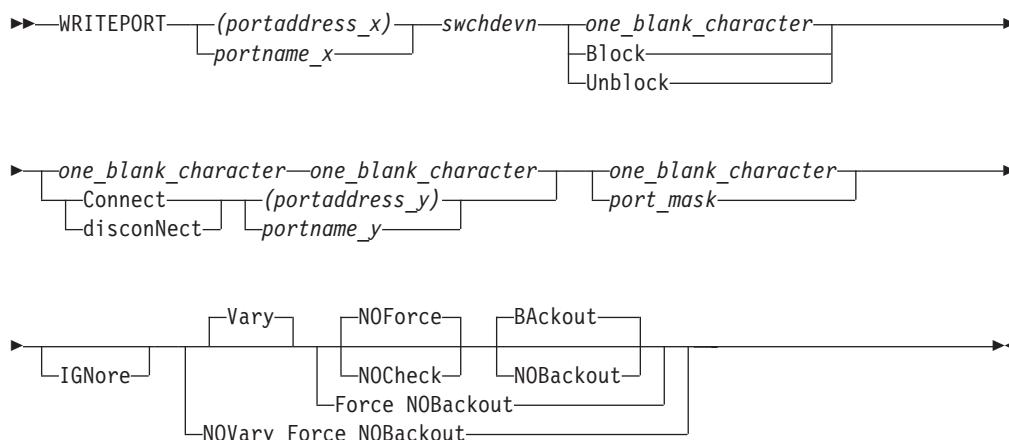

Parameters

(portaddress_x) | portname_x

Specifies the target port by its port address (enclosed in parentheses) or by its port name.

swchdevn | *

Specifies the target switch device number. The switch must be allocated to, or attached to, the issuing I/O operations.

one_blank_character | Block | Unblock

Specifies one of the following: the blocking attribute should be unchanged (X'40'); the port should be blocked; the port should be unblocked.

one_blank_character | Connect | disconNect

Specifies one of the following: the dynamic connection attribute should be unchanged (X'40'); the port should be statically connected to the port specified in the next operand; the port should be disconnected from that port.

(portaddress_y) | portname_y

Specifies the other port in the static connection by its port address or port name.

one_blank_character | port_mask

A blank character specifies that the allow and prohibit attributes of port_x should be unchanged. The 256-character (32-byte) mask specifies an A (Allow) or a P (Prohibit) as the attribute for each port in the range X'00–FF'. The character representing port_x must and all unimplemented ports must be P, while the character representing the control unit port (CUP) must be A

IGNore

You must specify this option when an Inter-Switch-Link port (E_Port) is involved. Otherwise the command is rejected with return code 8 and reason code X'49'. The reason is I/O operations can no longer guarantee "safe-switching" when an E_Port is involved.

Vary

This is the default option and it indicates that appropriate processing must be done at the host to support the REMOVE and RESTORE CHP commands.

NOVary

This option is not valid for the WRITEPORT command.

Force

This option says to do the command in the best manner possible. For example, if one of the specified hosts does not respond, the command is still performed on all other hosts.

NOForce

This is the default option and indicates that if there is any failure, the command should not continue and a return call and reason describing the failure will be returned.

NOCheck

The NOCheck option overrides the detection of two conditions that would cause the failure of the command under the default NOForce option:

1. Detection of systems in the scope of the command on which I/O operations is not operating.
2. Detection of downlevel I/O operations's operating on systems in the scope of the command.

If either of these conditions is detected, a return code of 4 is returned.

BAckout

This is the default option and indicates that if any failure is reported by any of the participating systems, any successful WRITEPORT actions for all the participating host systems will be backed out.

NOBackout

This option indicates that if any error condition is detected during the WRITEPORT processing, I/O operations will not attempt to change any WRITEPORT actions that have been performed.

Usage

Using the Writeport command is a tool that helps you simplify the installation, set up, and recovery of a switch's configuration. Note, however, that the WRITESWCH command lets you manipulate attributes of all the ports on a switch.

The number and placement of implemented ports depends on the model of the switch. You can display the addressable ports with the commands described under "QUERY SWITCH" on page 205.

Also, see *Planning for the 9032 Enterprise Systems Connection Director* or *Planning for the 9033 Enterprise Systems Connection Director* for CUP information pertinent to the ESCON Directors.

Examples

Here is a segment of an MVS REXX EXEC that contains the command WRITEPORT (C3) 0500 B C (C1)

```

IHVRC = 0                /* Return code; it must be          */
/* called IHVRC.          */
/*                          */
IHVREAS = 0              /* Reason code; it must be          */
/* called IHVREAS.        */
/*                          */
IHVRESP = ' '           /* Response area; it must be        */
/* called IHVRESP.        */
/*                          */
cmd = 'WRITEPORT'        /* Command name (required)          */
opr1 = '(C3)'            /* Port address/port name (required) */
opr2 = '0500'           /* Switch device number (required)   */
opr3 = 'BLOCK'          /* Block/Unblock/blank (required)    */

```

WRITEPORT

```
opr4 = 'CONNECT'          /* Connect/discoNnect/blank (required) */
opr5 = '(C1)'            /* Port/Port name/blank (required) */
opr6 = ' '               /* 256 characters or 1 blank (required) */
/*
opt1 = 'NOFORCE'        /* Force/NOForce      (options) */
opt2 = 'VARY'           /* Vary/NOVary        (options) */
opt3 = 'BACKOUT'        /* BAckout/NOBackout  (options) */
/*
ADDRESS LINK 'IHVAPI' cmd opr1 opr2 opr3 opr4 opr5 opr6 opt1 opt2 opt3
/*****
```

The following example is one way to construct the 256-character allow or prohibit string. Port C3 is allowed to communicate to every other implemented port. The variables M1, M2, M3, and M4 are used to represent 64 characters each. The numbers in the comment lines are the ports.

```
/*CCCCCCCCCCCCDDDDDDDDDDDDDEEEEEEEEEEEEEEEEEFFFFFFFFFFF*/
/*0123456789ABCDEF0123456789ABCDEF0123456789ABCDEF0123456789ABCDEF*/
/*00000000000000001111111111111111222222222222222333333333333333*/
/*0123456789ABCDEF0123456789ABCDEF0123456789ABCDEF0123456789ABCDEF*/
M1='PPPPPPPPPPPPPPPPPPPPPPPPPPPPPPPPPPPPPPPPPPPPPPPPPPPPPPPPPPPP'

/*44444444444444445555555555555555666666666666666777777777777777*/
/*0123456789ABCDEF0123456789ABCDEF0123456789ABCDEF0123456789ABCDEF*/
M2='PPPPPPPPPPPPPPPPPPPPPPPPPPPPPPPPPPPPPPPPPPPPPPPPPPPPPPPPPPPP'

/*88888888888888889999999999999999AAAAAAAAAAAAAAAABBBBBBBBBBBBBB*/
/*0123456789ABCDEF0123456789ABCDEF0123456789ABCDEF0123456789ABCDEF*/
M3='PPPPPPPPPPPPPPPPPPPPPPPPPPPPPPPPPPPPPPPPPPPPPPPPPPPPPPPPPPPP'

/*CCCCCCCCCCCCDDDDDDDDDDDDDEEEEEEEEEEEEEEEEEFFFFFFFFFFF*/
/*0123456789ABCDEF0123456789ABCDEF0123456789ABCDEF0123456789ABCDEF*/
M4='AAPAAAAAAAAAAAAAAAAAAAAAAAAAAAAAAAAAAAAAAAAAAAAAAAAAAAAAAAAAPPAP'
```

This statement concatenates the four variables into the 256-character operand used in the command:

```
opr6 = M1 || M2 || M3 || M4
```

The attributes of the remaining ports must be determined according to the configuration requirements of the user's computer complex.

Example of Modifying Allow or Prohibit Attributes: This section shows examples of how to use the WRITEPORT command to modify an Enterprise System Connection Director so that:

- Port C2 is prohibited from dynamically connecting with ports C4 and C6.
- Port C6 is prohibited from dynamically connecting with port C8.

To accomplish this, you must use two WRITEPORT commands: the first command must specify C2 in the first operand (Example 1); the second command must specify C6 in the first operand (Example 2).

```
/******
/* Example 1: Using WRITEPORT to Prohibit C2 from C4 and C6 */
/******
cmd = 'WRITEPORT'      /* Command (required) */
opr1 = '(C2)'          /* Port/Port name (required) */
opr2 = '0500'          /* Switch device number (required) */
opr3 = ' '             /* Block/Unblock/blank (required) */
opr4 = ' '             /* Connect/discoNnect/blank (required) */
opr5 = ' '             /* Port/Port name/blank (required) */
/* Allow/Prohibit string as follows: */

/* CCCCCCCCCCCCCDDDDDDDDDDDDDEEEEEEEEEEEEEEEEEFFFFFFFFFFF */
/* 0123456789ABCDEF0123456789ABCDEF0123456789ABCDEF0123456789ABCDEF */
```

WRITESWCH
Purpose

Use the WRITESWCH command at the API to make changes (update) up to 512 addressable ports on any number of switches that are allocated to, or attached to, the issuing I/O operations. This command is available only at the API because it requires input in hexadecimal format.

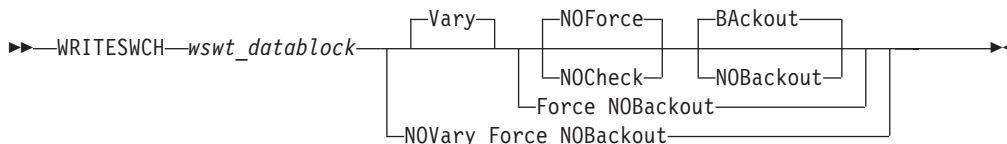
Syntax**Parameters****Vary**

This is the default option and it indicates that appropriate processing must be done at the host to support the WRITESWCH command.

NOVary

This option is not valid for the WRITESWCH command.

Force

This option says to do the command in the best manner possible. For example, if one of the specified hosts does not respond, the command is still performed on all other hosts.

NOForce

This is the default option and indicates that if there is any failure, the command should not continue and a return and reason describing the failure will be returned.

NOCheck

The NOCheck option overrides the detection of two conditions that would cause the failure of the command under the default NOForce option:

1. Detection of systems in the scope of the command on which I/O operations is not operating.
2. Detection of downlevel I/O operations's operating on systems in the scope of the command.

If either of these conditions are detected, a return code of 4 is returned.

BAckout

This is the default option and indicates that if any failure is reported by any of the participating systems, any successful WRITESWCH actions for all the participating host systems will be backed out.

NOBackout

This option indicates that if any error condition is detected during the WRITESWCH processing, I/O operations will not attempt to change any WRITESWCH actions that have been performed.

Input

The format of the *WSWT_datablock* is an array of 1 or more entries of the following structure:

Table 25. WRITESWCH Input

Offset					
Dec	Hex	Type	Len	Name(Dim)	Description
0	(0)	STRUCTURE	80	WSWT	
0	(0)	BITSTRING	1	WSWTFLAG1	Flags byte 1
		1... ..		WSWTLAST	End of list indicator
					0 = More records
					1 = Last record in array
		.1.. ..		WSWTMDPT	Midport
					1 = This port is the midport of a defined chain
		..11 ..		WSWTFORM	Format id
					0 = Format 0 (original format)
	 1..		WSWTMBSR	Modify block state request
					0 = No change to block state
	1..		WSWTMCSR	Modify connect state request
					0 = No change to connect state
	1.		WSWTLNVB	Logical name validity
					0 = Ignore logical name information
					1 = Write logical name to port address
	1		WSWTCIVB	Chain information validity
					0 = Ignore chain information
					1 = Set up chain
1	(1)	BITSTRING	1	WSWTFLAG2	Flags byte 2
		1... ..		WSWTMMR	Modify mask request
					0 = No change to current PDCM
		.1.. ..		WSWTAMR	AND mask request
					0 = No change to current PDCM
					1 = AND given mask with current PDCM
		..1.		WSWTOMR	OR mask request
					0 = No change to current PDCM
					1 = OR given mask with current PDCM
		...1 1111		*	Reserved
2	(2)	UNSIGNED	2	WSWTSWIT	Switch device number
4	(4)	CHARACTER	48	WSWTLAIB	Port information block
4	(4)	CHARACTER	1	*	Reserved

Table 25. WRITESWCH Input (continued)

Offset					
Dec	Hex	Type	Len	Name(Dim)	Description
5	(5)	UNSIGNED	1	LAIBNUMB	Port number
6	(6)	UNSIGNED	1	LAIBADDR	Port address
7	(7)	CHARACTER	1	*	Reserved
8	(8)	BITSTRING	4	LAIBDESC	Port descriptors
		1... ..		LAIBUNMP	Port implementation 0 = Port is implemented 1 = Port is not implemented
		.1.. ..		LAIBFBIT	Port fence information 0 = Port is not blocked 1 = Port is blocked
		..1.		*	Reserved
		...1		LAIBSBIT	Port connection 0 = Port is not connected 1 = Port is connected
	 1111 >>		*	Reserved
12	(C)	CHARACTER	2	*	Reserved
14	(E)	UNSIGNED	1	LAIBSADR	Static connection port address
15	(F)	CHARACTER	5	*	Reserved
20	(14)	BITSTRING	32	LAIBICM	Port prohibit dynamic connection mask (PDCM)
52	(34)	CHARACTER	24	WSWTNAME	Port logical name
76	(4C)	UNSIGNED	2	WSWTCSWIT	Switch device number for chained switch
78	(4E)	UNSIGNED	1	WSWTCPOR	Chained port address
79	(4F)	CHARACTER	1	*	Reserved

How to Set Up the Data Block

By using the described data block, an API user can change the connectivity attributes of a port. The changes that are requested are controlled by Request bits in the beginning of the block that must be used in order to say what type of action is requested. If no request bits are set then the given block is skipped and treated as a no-op.

Listed below are the commands that can be processed with 1 WSWT block. The bits that must be set are also listed as well as the data required to make the change.

As stated earlier, you can make more than one change on a port block by setting the appropriate combination of bits. For example, you can effectively enter a Block and a Connect command at the same time by making sure that all the bits that are relevant for both commands are set on the same block.

Block

WSWTMBSR

Must be set to 1 to indicate that the block state should be changed.

LAIBFBIT

Must be set to 1 to indicate that the port should be blocked.

LAIBADDR

Contains the port address.

WSWTSWIT

Contains the switch that the port address is on.

WSWTFORM

Must be set to 00.

Unblock**WSWTMBSR**

Must be set to 1 to indicate that the block state should be changed.

LAIBFBIT

Must be set to 0 to indicate that the port should be unblocked.

LAIBADDR

Contains the port address.

WSWTSWIT

Contains the switch that the port address is on.

WSWTFORM

Must be set to 00.

Connect**WSWTMCSR**

Must be set to 1 to indicate that the connection state should be changed.

LAIBSBIT

Must be set to 1 to indicate that the port should be connected.

LAIBADDR

Contains the port address.

LAIBSADR

Contains the port address that LAIBADDR should be connected to.

WSWTSWIT

Contains the switch that the port addresses are on.

WSWTFORM

Must be set to 00.

Disconnect**WSWTMCSR**

Must be set to 1 to indicate that the connection state should be changed.

LAIBSBIT

Must be set to 0 to indicate that the port should be disconnected.

LAIBADDR

Contains the port address.

LAIBSADR

Contains the port address that LAIBADDR should be disconnected from.

WSWTSWIT

Contains the switch that the port addresses are on.

WSWTFORM

Must be set to 00.

Chain

WSWTCIVB

Must be set to 1 to indicate that the chain information is valid and you want to change it.

WSWTMDPT

Must be set to 1 to indicate that this port is the midport on the chain.

WSWTMCSR

Must be set to 1 to indicate that the connection state should be changed.

LAIBSBIT

Must be set to 1 to indicate that the port should be chained by setting a connection between LAIBADDR and LAIBSADR.

LAIBADDR

Contains the port address.

LAIBSADR

Contains the port address that LAIBADDR should be connected to.

WSWTSWIT

Contains the switch that the port addresses are on.

WSWTCPORT

Contains the chained port address that LAIBADDR should be chained to.

WSWTCSWIT

Contains the switch that the chained port address is on.

WSWTFORM

Must be set to 00.

Unchain

WSWTCIVB

Must be set to 1 to indicate that the chain information is valid and you want to change it.

WSWTMDPT

Must be set to 1 to indicate that this port is the midport on the chain.

WSWTMCSR

Must be set to 1 to indicate that the connection state should be changed.

LAIBSBIT

Must be set to 0 to indicate that the port should be unchained by disconnecting LAIBADDR and LAIBSADR.

LAIBADDR

Contains the port address.

LAIBSADR

Contains the port address that LAIBADDR should be disconnected from.

WSWTSWIT

Contains the switch that the port addresses are on.

WSWTCPORT

Contains the chained port address that LAIBADDR should be unchained from.

WSWTCSWIT

Contains the switch that the chained port address is on.

WSWTFORM

Must be set to 00.

Write**WSWTLNVB**

Must be set to 1 to indicate that the logical name field is valid.

LAIBADDR

Contains the port address.

WSWTNAME

Contains the logical name that should be assigned to the port address given in LAIBADDR.

WSWTSWIT

Contains the switch that the port addresses are on.

WSWTFORM

Must be set to 00.

Modify PDCM**WSWTMMR**

Must be set to 1 to indicate that the PDCM should be modified.

LAIBADDR

Contains the port address.

LAIBICM

Contains the new PDCM for the given port.

WSWTSWIT

Contains the switch that the port addresses are on.

WSWTFORM

Must be set to 00.

And PDCM**WSWTAMR**

Must be set to 1 to indicate that the given PDCM should be AND'ed with the current PDCM.

LAIBADDR

Contains the port address.

LAIBICM

Contains the PDCM to be AND'ed for the given port.

WSWTSWIT

Contains the switch that the port addresses are on.

WSWTFORM

Must be set to 00.

WRITESWCH

Or PDCM

WSWTOMR

Must be set to 1 to indicate that the given PDCM should be OR'ed with the current PDCM.

LAIBADDR

Contains the port address.

LAIBICM

Contains the PDCM to be OR'ed for the given port.

WSWTSWIT

Contains the switch that the port addresses are on.

WSWTFORM

Must be set to 00.

Usage

- The WSWT data block that you enter is a series of 80-byte WSWT structures that I/O operations processes sequentially. Be sure to take this into account. For example, assume ports *FB* and *EA* are statically connected, and you want ports *CO* and *EA* to be statically connected instead.

Note: If the WSWT structure contains an "AND PDCM" or an "OR PDCM" bit setting, there may only be one "AND PDCM"/ "OR PDCM" and no "MODIFY PDCM", in the structure.

1. In the data block, disconnect *FB* and *EA* first.
2. Then, connect *CO*, and *EA*.

If you reverse the order, the command will fail because *EA* is already statically connected.

- If you specify Vary, I/O operations varies the relevant paths in all the WSWT structures offline first. If these operations are all successful or if you specified Force, the program then sends all the WSWT structures to the affected switch(es). If these operations are successful, I/O operations then varies the appropriate paths online.
- The Writeswch command is used implicitly when you activate a switch configuration in matrix format by using either the I/O operations ISPF dialog or the workstation feature.

Chapter 7. Invoking I/O Operations with a REXX EXEC

Rules for Calls by a REXX EXEC

Separate the parameters as follows:

- If the REXX EXEC uses the address link invocation to call the API, the parameters must be separated by blanks as shown:
`address link 'IHVAPI' parm1 ... parmn`
- If the REXX EXEC uses the REXX call to call the API, the parameters must be separated by commas as shown:
`call 'IHVAPI' parm1,parm2,parm3,...`

Specify the following variables:

ihvrc To receive the return code

ihvreas
To receive a reason code

ihvresp
As the response area to receive the command output if there is any

When specifying the variables listed above, note the following:

- The return code is in printable *decimal* format, while the reason code is in printable *hexadecimal* format. See *SA OS/390 Messages and Codes* for a list of reason codes.
- A return code and reason code are not provided if more parameters were specified in the input parameter list than are allowed for a REXX EXEC. A REXX error message is sent instead.
- If **ihvrc** and **ihvreas** are not specified, I/O operations can still process the command. However, the EXEC might not be able to check whether the command was processed successfully because no return code or reason code can be checked.
- If **ihvresp** is not specified, I/O operations can process the command but cannot return data to the REXX EXEC.

Literal Values

If the REXX EXEC calls I/O operations using literal values, the literal value for each parameter should be enclosed in single quotes (') to avoid ambiguity during processing.

Optional Variables

Optionally, a REXX EXEC caller can:

- Set a variable equal to the name of the command being specified
- Set a variable for each operand and option associated with the command being specified.

Two Examples of REXX EXEC Calls

Example of a Call to Connect Two Ports

In the following example, the caller enters the CONNECT command to connect port C0 statically -- or dedicate it -- to port E0 on switch 100.

```
/* Connect EXEC */
ihvrc = 0                                /* Return code must be called */
/*                                         */
ihvreas = 0                              /* Reason code must be called */
/* ihvreas. Name must be in EXEC. */
/*                                         */
ihvresp = ' '                            /* Response area must be called */
/* ihvresp. Name must be in EXEC. */
/*                                         */
parm1 = 'CONNECT'                        /* Command name */
parm2 = '(C0)'                           /* First port address (operand) */
parm3 = '(E0)'                           /* Second port address (operand) */
parm4 = '0100'                           /* Switch device number (operand) */
parm5 = 'NOFORCE'                        /* These are the default options */
parm5 = 'VARY'                           /* that do not have to be */
parm7 = 'BACKOUT'                        /* specified in the EXEC. */
```

If the Caller Uses the Address Link Invocation:

```
address link 'IHVAPI' parm1 parm2 parm3 parm4 parm5 parm6 parm7
say "RETURN CODE = " ihvrc
say "REASON CODE = " ihvreas
say "RESPONSE AREA = " ihvresp
/* Assume screen is 80 characters - */
/* Will appear to be printing 80-character records */

EXIT
```

If the Caller Uses the REXX Call:

```
call 'IHVAPI' parm1,parm2,parm3,parm4,parm5,parm6,parm7
say "RETURN CODE = " ihvrc
say "REASON CODE = " ihvreas
say "RESPONSE AREA = " ihvresp
/* Assume screen is 80 characters - */
/* Will appear to be printing 80-character records */

EXIT
```

Generalized Example of a REXX EXEC Call

When processed, the following REXX EXEC can be used to enter any I/O operations command. The 80-character output is assumed to be in message format, so QUERY output will not be readable.

```
/*                                         */
/* Initialization */
/*                                         */
linelength = 80                          /* length of 1 response line */
/*                                         */
/* Get the command as specified by the user */
/*                                         */
Parse Upper Arg IHVX1 IHVX2 IHVXPARMS
/*                                         */
/* Correct basic syntax errors for the user */
/*                                         */
/* - Capitalize command keywords (must be caps for IHV) */
/* - Strip out extraneous blanks (must have only 1 for IHV) */
/*                                         */
IHVXCMD = Space(IHVX1 IHVX2 IHVXPARMS,1)
Drop IHVX1 IHVX2 IHVXPARMS
/*                                         */
```



```

/* Tell the user what we are about to do          */
/*                                              */
Say 'Issuing the IHV command:' IHVXCMD          */
/*                                              */
/* Issue the command                            */
/*                                              */
Address LINK 'IHVAPI' IHVXCMD                  */
If IHVRC > 4
Then                                           /* Command failed */
Do;
    Say 'Return code:' IHVRC 'Reason code:' IHVREAS
End;
/*                                              */
/* Show the user the response from the command */
/*                                              */
Do lineindex = 1 to Length(IHVRESP) by lineLength;
    Say Substr(IHVRESP,lineindex,lineLength);
End;
/*                                              */
/* Return to the caller                          */
/*                                              */
Exit IHVRC;

```

Calling a Program that Uses the CALL Macro

General Information

I/O operations allows a program that uses the CALL macro to invoke either IHVAPI2 or IHVAPI.

The Parameter Lists

The caller must pass a variable-length parameter list, where:

- Each item in the list is an address of a parameter in the calling program. (The language in which the program is written must allow the program to alter the parameters for return code, reason code, and response area.)
- The high-order bit of the last parameter address must be set to 1 to indicate the end of the list.
- Register 0 must be set to 0 (zero) so that I/O operations knows the invocation is from an assembled user program, and not an interpreted REXX EXEC.
- Register 1 must contain the address of the parameter list.

The Caller Should Check Register 15 Upon Return From the Call

If not enough parameters were passed on the CALL, I/O operations returns a reason code of X'D0xx0001' in register 15. This code specifies that either an empty or an incorrect parameter list has been sent.

- If IHVAPI2 was invoked, at least 5 parameters are needed: the command name and the last four variables listed in 234.
- If IHVAPI was invoked, at least 4 parameters are needed: the command name and the variables listed in 234.

If more than 25 parameters were passed on the CALL, I/O operations returns a reason code of X'D0xx0007' in register 15. This code specifies that the list contained too many parameters.

For a comparison between IHVAPI2 and IHVAPI, refer to “Calling the I/O Operations API” on page 151.

Calling a Program that Uses IHVAPI2

Pass the Following Parameters in the Parameter List:

- One 38-character variable (padded on the right with blanks) equal to the name of the I/O operations command being specified.
- As many 38-character variables (each padded on the right with blanks) as needed for the operands in the command with the following exceptions:
 - For a range, specify a 71-character variable.
 - For an array, data block, or table, specify a variable long enough to contain it.
- As many 38-character variables (each padded on the right with blanks) as needed for the options associated with the command.
- As the fourth-from-last and the third-from-last variables, specify information related to the response area. Because these two parameters are interdependent, they are listed in the table following this list.
- As the second-from-last (or next-to-last) variable, specify a 4-byte field in hexadecimal format for the return code.
- As the last variable, specify a 4-byte field in hexadecimal format for the reason code.

4th-From-Last Parameter	3rd-From-Last Parameter	When the Response Area Is To Be Managed By:
0 (zero)	any value	I/O operations with a new output buffer
Response area address	0 (zero)	I/O operations with a re-used output buffer
Response area address	Response area length	Caller

Notes:

1. Initialize the response area.
2. If I/O operations manages the response area, the caller must not modify any of the fields in the prefix area, which is described in "A Prefix Area Can Precede the Response Area." If a field is modified, the results are unpredictable.
3. On return from the call, I/O operations puts the length of the response area that it used in the third-from-last parameter. It returns a length of 0 (zero) if no response data is returned. Therefore, the caller should save the input value of this parameter before invoking I/O operations.
4. If the caller manages the response area, the caller should update the third-from-last parameter for each invocation.

To Invoke IHVAPI2, Specify the Following:

```
CALL IHVAPI2,addrPARM1, ... addrPARMn
```

A Prefix Area Can Precede the Response Area

If I/O operations manages the response area, it returns a prefix area as well. Use the following information when you need to release these areas.

- x** Is the address of the response area, which is contained in the fourth-from-last parameter.
- x-4** Is the 4-byte address of the prefix area, which immediately precedes the response area.
- x-12** Bytes is the 1-byte 'subpool number '0'.

x-16 Bytes is the 4-byte length of the prefix area plus the contiguous response area.

For further information, refer to "General Information About the Response Area" on page 152 and to the following example.

Example of a Caller Invoking IHVAPI2

```

ESCMSAMP CSECT
*****
* Issue multisystem QUERY INTERFACE Switch to get switch port
* information. R1 points to a 4 character switch device number.
*****
MVC SWITCH_DEVICE(4),0(R1)  Get Switch device number
MVC HNUM+14(4),0(R1)        Set number in query command
SR  R0,R0                   Required by I/O Operations
CALL IHVAPI2,(QUERY,INTERFACE,SWITCH,HNUM,VALUE,          X
             ASTERISK,SCOPE,VALUE,ASTERISK,              X
             QIS@,QISLENGTH,RC,REASON),VL
CLC RC,=F'0'                0 means all hosts responded ok
BNE FREE                    If not, then free storage
*****
* Map the QUERY INTERFACE Switch row data.
*****
QISOK  L      R10,QIS@                Point to I/O Operations output area
USING QISINFO,R10              Map query interface info
LH     R9,HDRSIZE                Get the QIS header size
AR     R9,R10                    Point to the first port row
USING PORTROW,R9              Map port interface row
:
*****
* A port that needs blocking is found, so block it.
*****
UNPK  PORTNUMBER+1(3),PORTNUM(2)  Convert 1 byte hex port
TR    PORTNUMBER+1(2),TRANTAB-C'0' number to EBCDIC
MVI   PORTNUMBER+3,C')'          Restore trailing ")"
MVC   BLKLENGTH,=F'0'           Let manage the buffer
SR    R0,R0                      Required by I/O Operations
CALL  IHVAPI2,(BLOCK,PORTNUMBER,SWITCH_DEVICE,          X
             BLOCK@,BLKLENGTH,RC,REASON),VL
CLC   RC,=F'4'                  Block worked?
BNE   NOBLOCK                   No, then process error
:
*****
* Now done with ESCM obtained storage, so release it.
*****
DROP  R10
FREE  L      R10,QIS@                Get Query output buffer
C     R10,=F'0'                  I/O Operations Query buffer exists?
BE    CONTINUE                  No, continue
S     R10,=F'16'                 Address I/O Operations Query buffer
USING ESCMPREFIX,R10
L     R2,BUFLLENGTH              Get buffer length
L     R3,BUFSUBPOOL              Get buffer subpool
STORAGE RELEASE,LENGTH=(R2),ADDR=BUF@,SP=(R3)
L     R10,BLOCK@                 Get Block output buffer
C     R10,=F'0'                  I/O Operations Block buffer exists?
BE    CONTINUE                  No, continue
S     R10,=F'16'                 Address I/O Operations Query buffer
L     R2,BUFLLENGTH              Get buffer length
L     R3,BUFSUBPOOL              Get buffer subpool
STORAGE RELEASE,LENGTH=(R2),ADDR=BUF@,SP=(R3)
:
*****
* I/O Operations API parameters
*****

```

```

QIS@      DC      A(0)
QISLENGTH DC      F'0'
BLOCK@    DC      A(0)
BLKLENGTH DC      F'0'
RC        DC      F'0'
REASON    DC      F'0'
QUERY     DC      CL38'QUERY'
INTERFACE DC      CL38'INTERFACE'
SWITCH    DC      CL38'SWITCH'
VALUE     DC      CL38'VALUE'
ASTERISK  DC      CL38'*'
SCOPE     DC      CL38'SCOPE'
BLOCK     DC      CL38'BLOCK'
HNUM      DC      CL38'HNUM(THIS-SYS.XXXX)'
PORTNUMBER DC     C'(',CL2' ',C')',CL34' '
SWITCH_DEVICE DC   CL38' '
*
TRANTAB   DC      CL16'0123456789ABCDEF'
*
QISINFO   DSECT                                QUERY INTERFACE Switch output
DS      CL4
HDRSIZE   DS      H                            Size of this header
ROWSIZE   DS      H                            Size of each row
DS      CL44
NUMROWS   DS      F                            Number of rows
*
PORTROW   DSECT
PORTNUM   DS      XL1                          Port number
DS      CL155
ROWCODE   DS      F                            Query row code (see below)
PORTROW   EQU     0                            Port row with no error
SUMMROW   EQU     X'5100FFFF'                  Summary row
*
ESCOMPREFIX DSECT                                I/O Operations supplied buffer info
BUFLNGTH  DS      F                            Buffer length
BUFSUBPOOL DS     FL1                          Subpool number
DS      F
BUF@      DS      A                            Buffer address
:
```

Calling a Program that Uses IHVAPI

Pass the Following Parameters in the Parameter List:

- A 24-character variable (padded on the right with blanks) equal to the name of the I/O operations command being specified.
- A 24-character variable (padded on the right with blanks) for each operand in the command -- with the exception of an operand that contains an array, data block, or table. In these cases, specify a variable that is long enough to contain the item. (Note, however, that I/O operations only uses 64KB of the response area on an IHVAPI call.)
- A 24-character variable (padded on the right with blanks) for each option in the command.
- As the third-from-last variable, specify the address of the response area. (Initialize the response area.)

When a caller invokes IHVAPI, I/O operations can return up to 64KB of data in the response area. If the command output exceeds this amount, I/O Operations fills the response area and notifies the caller that an overflow condition has occurred. Assume, however, that an area of 24KB is sufficient for most commands. Exceptions can be such commands as the DISPLAY DEVICE, DISPLAY RESULTS, DISPLAY VARY, QUERIES, REMOVE DEV, and RESTORE DEV commands.

- As the second-from-last variable, specify a 4-byte field in hexadecimal format for the return code.
- As the last variable, specify a 4-byte field in hexadecimal format for the reason code.

To Call IHVAPI, Specify the Following:

```
CALL IHVAPI,(CMD,PARM1,...PARMn,IHVRESP,IHVRC,IHVREAS),VL
```

Part 4. Status Display Facility Definitions

Chapter 8. SDF Initialization Parameters	241	AOFTREE	253
DCOLOR	241	PANEL	255
DPFKnn	242	STATUSFIELD	257
DPFKDESC1	243	STATUSTEXT	260
DPFKDESC2	244	TEXTFIELD	261
EMPTYCOLOR	244	TEXTTEXT	262
ERRCOLOR	245	PFKnn.	263
INITSCRN	246	ENDPANEL	264
MAXOPS	246	Example SDF Definition	265
PFKnn.	247	SDF Tree Structure Definitions.	265
PRIORITY	248	SDF Panel Definitions	266
PRITBSZ	250	SDF Initialization Parameters in AOFINIT	270
PROPDOWN	250	SDF Status Detail Definitions	271
PROPUP	251	Chapter 10. SDF Commands	273
SCREENSZ	251	SDFTREE.	273
TEMPERR	251	SDFPANEL	274
Chapter 9. SDF Definition Statements	253	SCREEN	275

This part describes the definitions for the status display facility (SDF). Refer to *System Automation for z/OS User's Guide* for information on how to set up the display panels and on how to use SDF.

Enter the *SDF initialization* parameters in the DSIPARM member of AOFINIT. It is recommended that you use the supplied display defaults.

Chapter 8. SDF Initialization Parameters

The SDF initialization parameters are:

DCOLOR

Default status descriptor color

DPFK_{nn}

PF key settings for detail status panel

DPFKDESC1

PF key descriptions for detail status panel

DPFKDESC2

PF key descriptions for detail status panel

EMPTYCOLOR

Default color for status component without a status descriptor

ERRCOLOR

Default color for status component without a tree structure entry

INITSCRN

Initial screen

MAXOPS

Maximum operator logon limit

PFK_{nn}

Default PF key settings

PRIORITY

Priority and color definitions

PRITBSZ

Priority and color table size

PROPDOWN

Propagate status downward in SDF tree structure

PROPUP

Propagate status upward in SDF tree structure

SCREENSZ

Screen size

TEMPERR

Temporary error limit value

DCOLOR

Purpose

The DCOLOR parameter defines the color used for a status descriptor that is outside any of the defined priority and color ranges. This parameter is optional. If not coded, the program default color is White.

Syntax



Parameters

color

The color used for the status descriptor. This value can be one of the following:

DCOLOR

R	Red
P	Pink
Y	Yellow
T	Turquoise
G	Green
B	Blue
W	White

The default is White.

Restrictions and Limitations

In member AOFINIT, if the number of PRIORITY parameters (see page 248) exceeds the default PRITBLSZ parameter value of 7 (see page 250), the DCOLOR parameter must follow the PRITBLSZ parameter.

Usage

The recommended value for DCOLOR is White. This value is supplied in SA z/OS SAOFNPRM member AOFINIT. This value does not conflict with existing status and color definitions.

Examples

```
DCOLOR = WHITE
```

DPFKnn

Purpose

The DPFKnn parameter defines all PF keys unique to a detailed status panel.

Syntax

```
▶▶—DPFKnn—==—command—▶▶
```

Parameters

nn PF key number. Values can range from 1 to 24. You can modify all PF key definitions.

command

The command executed when the defined PF key is pressed.

Restrictions and Limitations

This parameter must be specified on one line. Continuation lines are not allowed. The total length of the parameter and parameter value specification cannot exceed 72 characters.

PF keys defined by DPFK*nn* statements are only active when the detail panel is displayed and override the default settings defined with the PFKnn parameter.

Usage

Table 26 on page 243 shows variables that you can use as part of the command specified on the DPFKnn parameter.

Note: Using these variables (that is, translating variables into values) is valid on a detail status or status panel when the cursor is on a status field.

Table 26. Variables for the DPFKnn Command

Variable	Translated To
&COMP or &RESOURCE	The component name
&ROOT or &SYSTEM	Root or system
&SYSDATE	System date
&SYSTIME	System time
&IN or &INFO	Detail entry information displayed on the status panel
&DATE	The date the detail entry was added
&TIME	The time the detail entry was added
&SENDERID	The reporter submitting the detail entry
&SNODE or &SENDERNODE	The node of the reporter submitting the detail entry
&DA or &DATA or &DSPDETL	The actual message text
&RV or &REFVALUE	The reference value of the detail entry
&PR or &PRIORITY	The priority of the detail entry
&CO or &COLOR	The color of the detail entry
&HI or &HIGHLITE	The highlight level of the detail entry
&RESAPPL or &COMPAPPL	The component name and the alternate component name if used to queue the status
&QCOMP	The component name to which the status was queued by SDF
&DCOMP	The displayed component name

Examples

DPFK9 = SCREEN VTAMSTAT

DPFKDESC1

Purpose

The DPFKDESC1 parameter defines the first part of the PF key description appearing at the bottom of the detail screen. This text is concatenated with the text defined with the DPFKDESC2 parameter.

Syntax

▶▶—DPFKDESC1—==—*text*—————▶▶

Parameters

text

The text of the detail PF key description. The length of text allowed for this parameter depends on the total parameter length limit (72 characters) and the total text length limit defined by DPFKDESC1 and DPFKDESC2 (80 characters). For example, when defining a detail PF key description that is 79 characters long, you can define the first 60 characters of text on DPFKDESC1 and the remainder of the text on DPFKDESC2.

DPFKDESC1

Restrictions and Limitations

- This parameter must be specified on one line. Continuation lines are not allowed. The total length of the parameter and parameter value specification cannot exceed 72 characters.
- The total length of the PF key description defined by DPFKDESC1 and DPFKDESC2 cannot exceed 80 characters.

Examples

```
DPFKDESC1=PF3=RET      6=ROLL 7=UP 8=DN 9=AST 10=DEL
```

DPFKDESC2

Purpose

The DPFKDESC2 parameter defines the second part of the PF key description appearing at the bottom of the detail screen. This text is concatenated with the text defined with the DPFKDESC1 parameter.

Syntax

```
▶▶—DPFKDESC2—==—text—————▶▶
```

Parameters

text

The text of the continued PF key description, begun in a previous DPFKDESC1 statement. The length of the text depends on the length specified on the previous DPFKDESC1 statement, because the total description text defined by DPFKDESC1 and DPFKDESC2 cannot exceed 80 characters.

Restrictions and Limitations

- This parameter must be specified on one line. Continuation lines are not allowed. The total length of the parameter and parameter value specification cannot exceed 72 characters.
- The total length of the PF key description defined by DPFKDESC1 and DPFKDESC2 cannot exceed 80 characters.

Examples

```
DPFKDESC2=11=BOT 12=TOP
```

EMPTYCOLOR

Purpose

The EMPTYCOLOR parameter defines the color displayed for a status component that has no status descriptor associated with it. This parameter is optional. If not coded, the default color is Blue.

Syntax



Parameters

color

The color used for the status descriptor. This value can be one of the following:

R	Red
P	Pink
Y	Yellow
T	Turquoise
G	Green
B	Blue
W	White

The default is Blue.

Usage

The recommended value for EMPTYCOLOR is Blue. This value is supplied in SA z/OS SAOFNPRM member AOFINIT. This value does not conflict with existing status and color definitions. This parameter can be overridden in the AOFTREE member.

Examples

```
EMPTYCOLOR = BLUE
```

ERRCOLOR

Purpose

The ERRCOLOR parameter defines the color displayed for a status component that does not have a corresponding entry in the SDF tree structure.

This parameter is optional. If not coded, the default color is White.

Syntax



Parameters

color

The color used for the status component. This value can be one of the following:

R	Red
P	Pink
Y	Yellow
T	Turquoise

ERRCOLOR

G Green
B Blue
W White

The default is White.

Examples

```
ERRCOLOR = YELLOW
```

INITSCRN

Purpose

The INITSCRN parameter defines the initial panel displayed by SDF.

Syntax

```
▶▶—INITSCRN—==—panel_name—▶▶
```

Parameters

panel_name

Any valid alphanumeric name with maximum length of eight.

Usage

If you change the name of the initial panel defined in the AOFPNLS member of the NetView DSIPARM data set, you must also change the panel name in the INITSCRN parameter.

Examples

```
INITSCRN = SYSTEMA1
```

MAXOPS

Purpose

The MAXOPS parameter defines the maximum number of logged-on operators that can use the SDF. This parameter is optional. If not coded, a program default of 30 is used.

Syntax

```
▶▶—MAXOPS—==—30—  
▶▶—MAXOPS—==—number—▶▶
```

Parameters

number

The number of maximum operators. Values can range from 1 to 9999999. The default is 30.

Usage

If the number of operators trying to use the SDF is more than the number defined in MAXOPS, additional operators are denied access to the SDF, because the dynamic update facility keeps an internal count of logged-on operators.

Examples

MAXOPS = 35

PFKnn

Purpose

The PFKnn parameter defines the default PF key settings for SDF panels.

Syntax

▶▶—PFKnn—=—*command*—▶▶

Parameters

nn Values can range from 1 to 24.

command

The command issued when the defined PF key is pressed.

Restrictions and Limitations

This parameter must be specified on one line. Continuation lines are not allowed. The total length of the parameter and parameter value specification cannot exceed 72 characters.

Usage

Table 27 shows the variables that can be used as part of the command specified on the PFKnn parameter.

Note: Use of these variables (that is, their appropriate translation from variables to values) is valid on a detail status panel or on a status panel when the cursor is on a status field.

Table 27. Variables for the PFKnn Command

Variable	Translated To
&COMP or &RESOURCE	The status component
&ROOT or &SYSTEM	Root or system
&SYSDATE	System date
&SYSTIME	System time
&IN or &INFO	Detail entry information displayed on the status panel
&DATE	The date the detail entry was added
&TIME	The time the detail entry was added
&SENDERID	The reporter submitting the detail entry
&SNODE or &SENDERNODE	The node of the reporter submitting the detail entry
&DA or &DATA or &DSPDETL	The actual message text
&RV or &REFVALUE	The reference value of the detail entry
&PR or &PRIORITY	The priority of the detail entry
&CO or &COLOR	The color of the detail entry

Table 27. Variables for the PFKnn Command (continued)

Variable	Translated To
&HI or &HIGHLIGHT	The highlight level of the detail entry

Examples

MVS D A,TSO is issued when PF4 is pressed with the cursor placed on the TSO entry on the status screen: PFK4 =MVS D A,&INFO

PRIORITY

Purpose

The PRIORITY parameter defines the relationship between colors and priority ranges. This parameter is optional. If not coded, program defaults are used.

Syntax

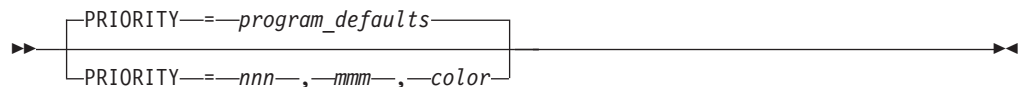

Parameters

nnn

The lower limit of the priority range. This value can be any valid number between 001 and 99999999.

mmm

The upper limit of the priority range. This value can be any valid number between 001 and 99999999 and equal to or greater than the value specified in *nnn*.

color

The color used for a particular priority range. This value can be one of the following:

- R** Red
- P** Pink
- Y** Yellow
- T** Turquoise
- G** Green
- B** Blue
- W** White

program_defaults

These are:

Priority Range	Color
001 to 199	RED
200 to 299	PINK
300 to 399	YELLOW
400 to 499	TURQUOISE
500 to 599	GREEN
600 to 699	BLUE

Restrictions and Limitations

- This parameter must be specified on one line. Continuation lines are not allowed. The total length of the parameter and parameter value specification cannot exceed 72 characters.
- In the AOFINIT member, if the number of PRIORITY parameters defining priority and color ranges (see page 248) exceeds the default PRITBLSZ parameter value of 7 (see page 250), the DCOLOR parameter must follow the PRITBLSZ parameter.
- Default values for priorities and colors are used if and only if no PRIORITY parameters are defined. If you choose to customize any priority and color definitions, you must specify all priority and color definitions in AOFINIT, rather than customizing the one priority and color definition and using the defaults for the remaining definitions.

Usage

It is recommended that you use the priority and color values supplied with SA z/OS DSIPARM member AOFINIT.

Examples

```
Priority = 001,199,RED  
Priority = 200,299,PINK  
Priority = 300,399,YELLOW  
Priority = 400,499,TURQUOISE  
Priority = 500,599,GREEN  
Priority = 600,699,BLUE
```

PRITBLSZ

Purpose

The PRITBLSZ parameter defines the number of priority and color ranges defined by the PRIORITY entries. This parameter is optional. The default is 7.

Syntax



Parameters

nn The number of priority and color ranges. This value can be any number greater than or equal to 7. The default is 7.

Restrictions and Limitations

In the AOFINIT member, if the number of PRIORITY parameters defining priority and color ranges (see page 248) exceeds the default PRITBLSZ parameter value of 7 (see page 250), the DCOLOR parameter must follow the PRITBLSZ parameter.

Usage

The recommended value for PRITBLSZ is 7. This value is supplied with SA z/OS DSIPARM member AOFINIT.

Examples

PRITBLSZ = 7

PROPDOWN

Purpose

The PROPDOWN parameter defines whether status information should be sent down the status tree as a system default or not. This parameter is optional. The default is NO.

Syntax

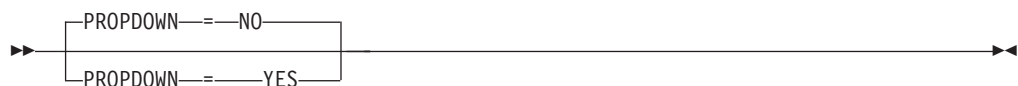

Parameters

None.

Usage

The recommended value for PROPDOWN is NO. This parameter can be overridden with individual requests to add a status descriptor to a status component.

PROPUP

Purpose

The PROPUP parameter defines whether status information should be sent up the status tree as a system default. This parameter is optional. The default is YES.

Syntax



Parameters

None.

Usage

The recommended value for PROPUP is YES. This parameter can be overridden with individual requests to add a status descriptor to a status component.

SCREENSZ

Purpose

The SCREENSZ parameter defines the screen buffer size. This parameter is optional. The default is 3000.

Syntax



Parameters

number

Buffer size value. Values can range from 3000 to 9999. The default is 3000.

Examples

SCREENSZ = 4000

TEMPERR

Purpose

The TEMPERR parameter defines the maximum number of temporary input/output errors when trying to display a SDF panel. This parameter is optional. The default is 3.

TEMPERR

Syntax



Parameters

number

Values can range from 3 to 99. The default is 3.

Usage

The recommended value for TEMPERR is 3. This value is supplied with SA z/OS DSIPARM member AOFINIT.

Examples

TEMPERR = 3

Chapter 9. SDF Definition Statements

The status display facility (SDF) provides a display of automated systems and resources using assigned status colors. An operator monitors the status of automated systems and resources by viewing the SDF main panel.

Typically, an application shown in green on an SDF status panel indicates the application is up, while red indicates the application is stopped or in a problem state. Operators can use the SDF to monitor the system and decide which actions to take when problems occur.

Refer to *System Automation for z/OS Defining Automation Policy* for information on how to define the SDF in the customization dialogs. You only need to change these entries if you use values other than the SA z/OS-provided defaults.

AOFTREE

Purpose

AOFTREE is a NetView DSIPARM member containing tree structure definitions, or referencing other tree structure definition members by using %INCLUDE statements. The tree structure definitions specify the propagation hierarchy used for status color changes.

Syntax

Each tree structure definition entry must be in the following format:

►►—*level_number*—*status_component*——*empty_chain_color*—►►

Parameters

level_number

The level number assigned to each component in the tree structure. This value can be any valid number between 1 and 9999. A tree structure must start with the root as level number 1.

If a level number is less than that of the preceding status component, the level number used must be defined in the tree structure as a superior node to that status component. For example, the following tree structure definition is

incorrect:

```
1 SY1
3 APPLIX
2 GATEWAY
```

Multiple roots can be defined in the same member, using 1 as the level number.

status_component

The status component associated with the *level_number*. This value can be any application or subsystem for which status information is to be displayed. Uses the subsystem entry name as defined in the automation control file. The status

component entry for the root must match the SDFROOT value specified on the SA z/OS Environment Setup panel in the customization dialogs defining current automation policy.

empty_chain_color

The color in which a status component is displayed on the SDF status panel if no status descriptor is associated with a status component. This value can be one of the following:

R	Red
P	Pink
Y	Yellow
T	Turquoise
G	Green
B	Blue
W	White

This entry is optional. If not coded, the value specified for the SDF initialization parameter EMPTYCOLOR in member AOFINIT is used for this value. Refer to “EMPTYCOLOR” on page 244 for more details.

Usage

When creating tree structure definitions, consider the following:

- Level numbers define the order of dependence. For an example, in Figure 22 on page 255, AOFAPPL is defined to depend on AOFSSI because AOFAPPL relies on AOFSSI for its message traffic. With propagation, any AOFSSI status change is reflected on both AOFAPPL and SY1 status components.
- Duplicate status components in the same tree structure should not be used.
- Not all status components defined in a tree structure require a corresponding panel entry. That is, you can define entries in a tree structure that do not have a corresponding panel display. However, every panel should have a corresponding entry in the tree structure.
- To avoid addressing conflicts, each root name must be unique. SDF addresses each status component defined in the tree structure as `root_component.status_component`

Examples

This example defines two separate tree structures, SY1 and SY2, representing two different MVS systems. SY1 is the focal point and SY2 is the target system.

Figure 22 on page 255 and Figure 23 on page 255 show the tree structures that must be defined in the tree structure definition member for SY1.

Note: /* denotes a comment field.

```
/* TREE STRUCTURE FOR SYSTEM SY1
1 SY1
2 APPLICATION
3 AOFAPPL
4 AOFSSI
3 JES2
4 SPOOL
3 VTAM
3 RMF
```

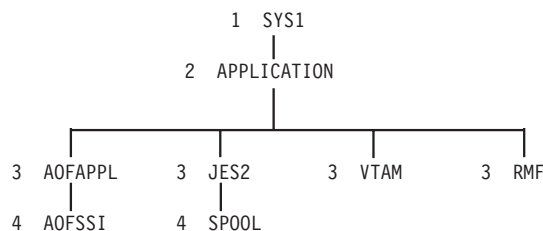

Figure 22. Example Tree Structure Definitions: System SY1. The diagram following the tree structure code for SY1 shows how the order of dependence relates to level number. The diagram is not actually in AOFTREE.

```

/* TREE STRUCTURE FOR SYSTEM SY2 ON SY1
1 SY2
2 APPLICATION
3 AOFAPPL
4 AOFSSI
3 JES2
4 SPOOL
3 VTAM
3 RMF
3 TSO
  
```

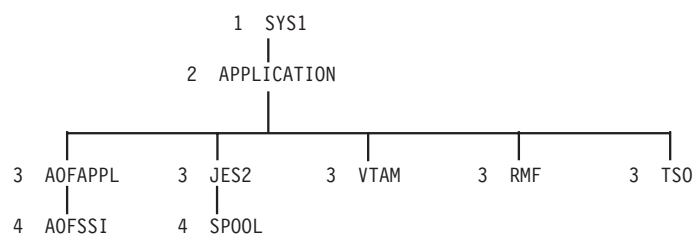

Figure 23. Example Tree Structure Definitions: System SY2. The diagram following the tree structure code for SY1 and SY2 shows how the order of dependence relates to level number. The diagram is not actually in AOFTREE.

These tree structures are referenced in the AOFTREE member on SY1 by the following %INCLUDE statements:

```

%INCLUDE(SY1TREE)
%INCLUDE(SY2TREE)
  
```

The AOFTREE member in system SY2 contains only a %INCLUDE statement referencing the tree structure for SY2.

Both tree structures start with level number 1. While the tree structures have unique root names, they can have similar status component names, such as JES2, VTAM, and RMF™. The corresponding settings for the root component can be defined in the system policy and automation setup definitions.

PANEL

Purpose

The PANEL statement identifies the start of a new panel and its general attributes.

Syntax

Parameters are positional.

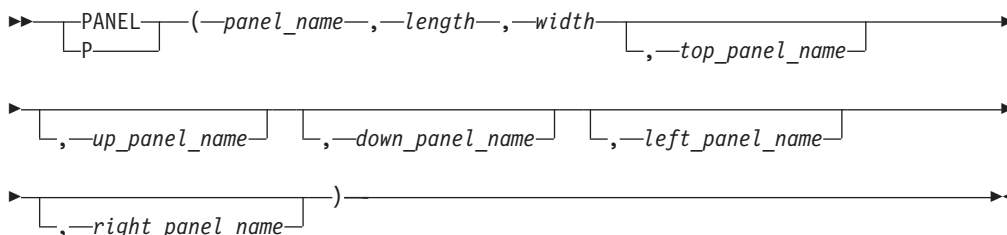

Parameters

panel_name

The name of the panel. This value can be any panel name up to 8 characters long.

length

The number of lines or rows in the panel. This value must be numeric. The only supported value is 24.

width

The number of columns in the panel. This value must be numeric. The only supported value is 80.

top_panel_name

The panel displayed when the TOP PF key is pressed or the TOP command is issued.

up_panel_name

The panel displayed when the UP PF key is pressed or the UP command is issued.

down_panel_name

The panel displayed when the DOWN PF key is pressed or the DOWN command is issued.

left_panel_name

The panel displayed when the left panel PF Key is pressed or the LEFT command is issued.

right_panel_name

The panel displayed when the right panel PF key is pressed or the RIGHT command is issued.

Usage

- The default initial panel name supplied with SA z/OS is SYSTEM. If you change this name, also change the INITSCRN parameter value in the AOFINIT member (see "INITSCRN" on page 246 for details).
- If there is more data than can be displayed on a single screen, you can define continuation panels using the following parameters:
 - left_panel_name*
 - right_panel_name*
 - down_panel_name*
- To continue a PANEL statement on another line after a delimiting comma, leave the remaining columns up to and including column 72 blank. The next positional parameter must begin in column 1 of the following line.

Examples

This example defines SY1SYS as the panel name. The length is 24 lines and the width is 80 characters. The panel named SYSTEM is displayed when the TOP and UP commands are used. No entries are defined for the DOWN, LEFT, or RIGHT commands.

```
PANEL(SY1SYS,24,80,SYSTEM,SYSTEM)
```

STATUSFIELD

Purpose

The STATUSFIELD statement defines the location of the status component on a panel and the panels that display when the UP and DOWN commands are used.

A STATUSFIELD statement is always accompanied by a STATUSTEXT statement (see “STATUSTEXT” on page 260) in a panel definition.

Syntax

Parameters are positional.

```

▶▶ STATUSFIELD (—root_component.status_component—,—start_line—)
   └──SF──┘
▶,—start_position—,—end_position—,—highlight—,—up_panel—
▶,—down_panel—,—status_descriptor_number—)

```

Parameters

root_component

The root component name as defined in the root node of the tree structure. The root component (as opposed to the status component alone) must always be coded, because different systems can have status components with the same name, such as VTAM or JES2, in their tree structures. Because the root component is always unique, each status component in a tree structure can be uniquely identified using the root component as a prefix.

status_component

The status component name as defined in the AOFTREE member. Maximum length is 8 characters.

start_line

The line number on which the status component should be displayed. This value should be numeric and in the range specified in the *length* parameter in the PANEL definition statement (see “PANEL” on page 255).

start_position

The actual column number within the specified *start_line* on which the status component is to be placed. There must be a minimum of two spaces between the ending position of one field and the beginning position of the next field to allow for attribute type. For example, if the end-position of a STATUSFIELD is in column 10, the start-position of the next STATUSFIELD must be column 13.

STATUSFIELD

end_position

The column number in which the status component definition ends. This value is governed by the length of text defined in the STATUSTEXT definition. For example, if JES2 is to be defined, then the length of the STATUSTEXT is four and the end position is the start position plus three. Refer to "STATUSTEXT" on page 260 for more details.

highlight

The type of highlighting used on the panel. This value can be one of the following:

N	Normal
B	Blink
R	Reverse
U	Underscore

The recommended value for highlighting is Normal. This value lets individual status descriptors added to the panel override any predefined highlighting with their own highlighting.

up_panel

The panel displayed when the UP PF key is pressed.

down_panel

The panel displayed when the DOWN PF key is pressed.

status_descriptor_number

The status descriptor number of the panel. This number specifies the status descriptor displayed in each field. This value must be numeric. The default is 0.

A status descriptor number of 0 causes the text as defined in the STATUSTEXT statement for this field (see STATUSTEXT *text* parameter on page 260) to be displayed with the color and highlighting associated with the first status descriptor chained to the status component. A status descriptor of 1 essentially does the same, except that the status text is replaced by information contained in the first status descriptor chained to the status component. A status descriptor of 2 or higher has the same effect as a value of 1, except that the numbered status descriptor is used rather than the first.

Status descriptors are chained with the status component in ascending order of priority.

The status descriptor number may be prefixed with a letter denoting the type of information to be displayed. If no prefix is supplied, the MVS job name is displayed if the resource is a subsystem or WTOR. Valid prefixes are as follows:

C	Displays the name of the status component
D	Displays the date the record was created
M	Displays the associated message text
P	Displays the priority of the record
Q	Displays the reference value for the record
R	Displays the name of the root component
S	Displays the reporting operator ID
T	Displays the time the record was created
U	Displays the number of duplicate records
V	Displays the job name or other information about the request
X	Displays the reporting domain ID

Restrictions and Limitations

A *start_line* and *start_position* parameter value combination of 1,1 is not allowed.

SDF panels containing STATUSFIELD entries referring to other than the first status descriptor may not be updated dynamically if the panel is not made resident either using the SDFPANEL ...,ADD command, or during SDF initialization. Automatic updates on dynamically loaded panels may be obtained by coding a dummy panel containing STATUSFIELD entries referring to the status component with a status descriptor number greater than 1.

At least one undefined (blank) position must be provided immediately preceding a STATUSFIELD. If *start_position* is specified as 1, then the last position on the preceding line must not be defined.

Usage

- When designing a panel for any status component, make the end position greater than or equal to the start position. Otherwise, an error condition will occur during SDF initialization.
- To continue a STATUSFIELD statement on another line after a delimiting comma, leave the remaining columns up to and including column 72 blank. The next positional parameter must begin in column 1 of the following line. An example of a continued STATUSFIELD statement is:

```
STATUSFIELD(SY.VTAM,
04,10,13,NORMAL)
```
- For better performance, make sure that every status component referred to in the panel is defined in the corresponding AOFTRREE member.

Examples

Example 1

In this example, the status component VTAM on SY1 starts on line 4 in column 10, ends in column 13, and has normal highlighting. No entries are defined for the UP or DOWN commands.

```
STATUSFIELD(SY1.VTAM,04,10,13,NORMAL)
:
:
```

Example 2

In this example, the status component SYSTEM starts on line 2 in column 04, ends in column 06, and has normal highlighting. No entries are defined for the UP panel. Panel SY1SYS is displayed when the DOWN command is issued.

```
SF(SY1.SYSTEM,02,04,06,N,,SY1SYS)
:
:
```

Example 3

In this example, three STATUSFIELD entries are defined for the same status component, SY1.GATEWAY. The highest-priority status descriptor is displayed in the first entry, the next highest-priority status descriptor is displayed in the second entry, and so on.

STATUSFIELD

```
SF(SY1.GATEWAY,02,04,06,NORMAL,,1)
SF(SY1.GATEWAY,03,04,06,NORMAL,,2)
SF(SY1.GATEWAY,04,04,06,NORMAL,,3)
:
:
```

STATUSTEXT

Purpose

The STATUSTEXT statement defines the text data displayed in the STATUSFIELD statement (see “STATUSFIELD” on page 257). This text data is typically the status component name.

Syntax

```
  >>-----STATUSTEXT-----text----->>>
      |-----|
      |-----ST-----|
```

Parameters

text

The default data displayed for the status component defined in the STATUSFIELD statement. This text can be replaced by text from a status descriptor chained to the status component if the *status_descriptor_number* parameter value on the corresponding STATUSFIELD statement is non-zero. The recommended value is the status component name. For example, for status component SY1.VTAM, specify VTAM for the *text* value. The length of text determines the end position coded in the STATUSFIELD statement.

Restrictions and Limitations

- Each STATUSFIELD statement must have a STATUSTEXT statement associated with it in a panel definition.
- The total length of the STATUSTEXT text cannot exceed the status field length defined by the combination of STATUSFIELD *start_position* and *end_position* parameter values.

Usage

To continue a STATUSTEXT statement, insert a delimiting comma and leave the remaining columns up to and including column 72 blank. Resume the text definition in column 1 of the following line.

Examples

Example 1

The following statement defines status text 1234567890 for a status field:

```
STATUSTEXT(12345,
67890)
```

Example 2

This example defines that IMS on SY2 displays as ACCOUNTS on the status display panel. Any status descriptors added for SY2.IMS are displayed using the ACCOUNTS entry.

Note: The end position in the STATUSFIELD statement reflects the length of ACCOUNTS.

```
STATUSFIELD(SY2. IMS, 06, 10, 17, NORMAL)
STATUSTEXT(ACCOUNTS)
```

TEXTFIELD

Purpose

The TEXTFIELD statement defines the location and attributes of fields that remain constant on the panels, such as panel headings, field names, and PF key designations.

Each TEXTFIELD statement must have a TEXTTEXT statement associated with it (see "TEXTTEXT" on page 262) in a panel definition.

Syntax

Parameters are positional.

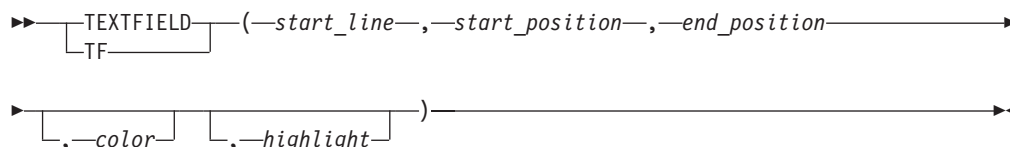

Parameters

start_line

The line number on which the text field is displayed. This value should be numeric and in the range specified in the *length* parameter in the PANEL definition statement (see "PANEL" on page 255).

start_position

The column number in which the text field is placed.

end_position

The column number in which the data specified in entry TEXTTEXT ends. Refer to "TEXTTEXT" on page 262 for more details.

color

The color in which text specified in the corresponding TEXTTEXT statement is displayed. This value can be one of the following:

R	Red
P	Pink
Y	Yellow
T	Turquoise
G	Green
B	Blue
W	White

highlight

Determines how the text specified in the corresponding TEXTTEXT statement is displayed. This value can be one of the following:

N	Normal
B	Blink
R	Reverse
U	Underscore

TEXTFIELD

Restrictions and Limitations

- A *start_line* and *start_position* parameter value combination of 1,1 is not allowed.
- If your text definition for an area of a panel requires more than 72 characters, continue the definition in additional TEXTFIELD and TEXTTEXT statement pairs. See the examples in "TEXTTEXT" for an example of continuing definitions in additional TEXTFIELD and TEXTTEXT pairs.
- At least two undefined (blank) positions must be provided immediately preceding a TEXTFIELD if it follows a STATUSFIELD. If *start_position* is specified as 1, then the last two positions on the preceding line must not be defined.
- At least one undefined (blank) position must be provided immediately preceding a TEXTFIELD if it follows another TEXTFIELD. If *start_position* is specified as 1, then the last position on the preceding line must not be defined.

Usage

- When designing a panel, for any TEXTFIELD, make the *end_position* of the TEXTFIELD greater than or equal to the *start_position*. Otherwise, an error condition will occur during SDF initialization.
- To continue a TEXTFIELD statement on another line after a delimiting comma, leave the remaining columns up to and including column 72 blank. The next positional parameter must begin in column 1 of the following line. An example continued TEXTTEXT statement is:

```
TEXTFIELD(01,  
25,57,WHITE,NORMAL)
```

Examples

This example defines the TEXTFIELD as being on line 1, starting in column 25, ending in column 57. The text is displayed in white, and uses normal highlighting.

```
TEXTFIELD(01,25,57,WHITE,NORMAL)
```

TEXTTEXT

Purpose

The TEXTTEXT statement defines the data displayed in the corresponding TEXTFIELD entry (see "TEXTFIELD" on page 261).

Each TEXTFIELD statement must have a TEXTTEXT statement associated with it in a panel definition.

Syntax

```
→—TEXTTEXT—(—text—)→  
  |_____|  
  TT
```

Parameters

text

The data displayed for the TEXTFIELD statement. The length of the data determines the end position coded in the TEXTFIELD entry.

Restrictions and Limitations

The total length of the TEXTTEXT text cannot exceed the text field length defined by the combination of TEXTFIELD *start_position* and *end_position* parameter values.

Usage

To continue a TEXTTEXT statement, insert a delimiting comma and leave the remaining columns up to and including column 72 blank. Resume the text definition in column 1 of the following line. See the TEXTTEXT examples for an example continued statement.

Examples

Example 1

In this example, “Data center systems” is displayed on the status display panel in white.

```
TEXTFIELD(01,25,57,WHITE,NORMAL)
TEXTTEXT(DATA CENTER SYSTEMS)
```

Example 2

In this example, all PF key settings are displayed on line 24 of the status display panel.

```
TF(24,01,79,TURQUOISE,NORMAL)
TEXTTEXT(PF1=HELP 2=DETAIL 3=END 6=ROLL 7=UP 8=DN ,
10=LF 11=RT 12=TOP)
```

PFKnn

Purpose

The PFKnn entry defines all PF keys unique to a panel.

The definitions defined by PFKnn are only active when the status panel is displayed. They override the default settings defined with the initialization PFKnn statement in member AOFINIT (see “PFKnn” on page 247).

Syntax

```
▶▶ PFKnn (command [ , -variable ] ) ▶▶
```

Parameters

nn The PF key number. This value can range from 1 through 24.

command

The command called when the defined PF key is pressed. If you need to use commas in the command, enclose the entire command string in apostrophes.

variable

Variables can be used as part of the command specified in the PFKnn statement. Table 28 on page 264 shows variables that can be used.

Example SDF Definition

This section shows an example of defining SDF. In this example, two separate systems (SY1 and SY2) are defined to SDF, so that SDF can monitor both systems. The example shows the entries required to define and customize SDF, including:

- SDF tree structure definitions
- SDF panel definitions
- SDF initialization parameters in AOFINIT
- SDF Status Details definitions

Note: This example assumes that SA z/OS focal point services are already implemented so that status can be forwarded from one system to another using notification messages.

SDF Tree Structure Definitions

Two tree structure definitions are required to set up the SDF hierarchy for systems SY1 and SY2. Figure 24 shows the tree structure definition for SY1. This tree structure is defined in a NetView DSIPARM data set member named SY1TREE.

```

1 SY1
2 SYSTEM
3 JES
3 RMF
3 VTAM
3 TSO
3 AOFAPPL
4 AOFSSI
3 APPLIC
4 SUBSYS
2 ACTION, GREEN
3 WTOR, GREEN
2 GATEWAY

```

Figure 24. SDF Example: Tree Structure Definition for SY1

Figure 25 shows the hierarchy of monitored resources defined by the SY1 tree structure.

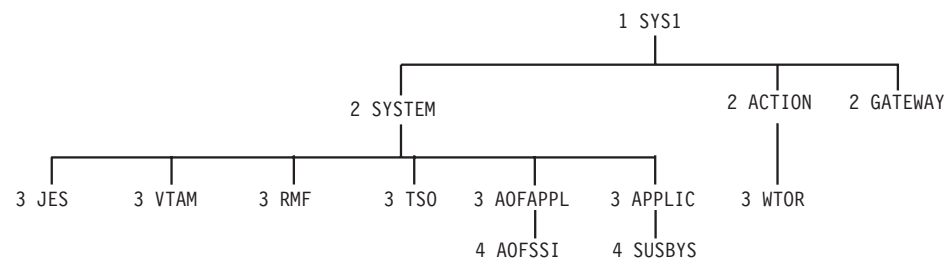

Figure 25. SDF Example: Hierarchy Defined by SY1 Tree Structure. The diagram shows how the order of dependence relates to level number. The diagram is not actually in AOF TREE.

This structure contains specific entries for the major system components, JES, RMF, VTAM, and TSO, as well as NetView (AOFAPPL) and the NetView SSI (AOFSSI). Note that the hierarchy differs from that defined in the SA z/OS automation control file. This is because the operator's view of these subsystems differs from the logical sequence in which they are managed by SA z/OS for startup and shutdown purposes.

SDF Definitions

The SYSTEM, APPLIC, and ACTION entries are logical, and may be used to view the status of all entries below them in priority order.

The SUBSYS, WTOR, and GATEWAY entries are also logical, and may be used to display the status of SUBSYSTEM, WTOR, and GATEWAY resource types. The status of any subsystem not appearing elsewhere in the tree will be queued under the SUBSYS entry. Similarly, WTORs and gateway status will be queued under WTOR and GATEWAY respectively.

A similar tree structure must be provided for SY2. As both systems are running the same set of base software, the tree structures are identical, except for the root (level 1) name, which will be SY2 rather than SY1. This tree structure is defined in the SY2TREE NetView DSIPARM member.

As SY1 is the focal point system in this example, both members must be defined in the NetView DSIPARM data set on that system. The tree structures are referenced by %INCLUDE statements in the base SDF tree definition member, AOFRTREE, as follows:

```
%INCLUDE(SY1TREE)
%INCLUDE(SY2TREE)
```

As our example does not require SY2 to function as a backup focal point system, the AOFRTREE member on SY2 requires only the %INCLUDE statement for SY2TREE.

SDF Panel Definitions

Following are panel definitions for:

- The root component or system panel, named SYSTEM
- The status component panel for system SY1, named SY1

Each panel definition is followed by the screen it defines.

SA z/OS provides samples similar to those described, as well as a sample GATEWAY panel definition for use on SY1.

On system SY1, these panel definitions are referenced by %INCLUDE statements in the main SDF panel definition member, AOFPNLS, as follows:

The GATEWAY, SY1, and SY2 panels must be resident as they contain generic field definitions.

```
%INCLUDE(SYSTEM)
%INCLUDE(GATEWAY)
%INCLUDE(SY1)
%INCLUDE(SY2)
```

Root Component Panel Definition

First, the root panel, named SYSTEM, is defined. Figure 26 on page 267 shows the panel definition statements that define the SYSTEM panel. This panel is the default initial SDF panel as assigned in the SDF initialization parameter member, AOFINIT. Three panels are accessed by pressing the DOWN PF key (PF8), GATEWAY, SY1, and SY2. All status components are prefixed with the root component and are listed in the corresponding tree structure. Each STATUSFIELD (SF) statement is followed by the corresponding STATUSTEXT (ST) statement. Similarly, each TEXTFIELD (TF) statement is followed by the corresponding TEXTTEXT (TT) statement.

```

/* DEFINE SYSTEM STATUS PANEL
P(SYSTEM,24,80)
TF(01,02,10,WHITE,NORMAL)
TT(SYSTEM)
TF(01,25,57,WHITE,NORMAL)
TT(DATA CENTER SYSTEMS)
SF(SY1.SYSTEM,04,04,11,N,,SY1)
ST(SY1)
SF(SY2.SYSTEM,06,04,11,N,,SY2)
ST(SY2)
SF(SY1.GATEWAY,02,70,77,N,,GATEWAY)
ST GATEWAY
TF(24,01,48,T,NORMAL)
TT(1=HELP 2=DETAIL 3=RET          6=ROLL    8=DN)
TF(24,51,79,T,NORMAL)
TT(          10=LF 11=RT 12=TOP)
EP

```

Figure 26. SDF Example: System Panel Definition Statements

This panel shows the layout defined by the statements in Figure 26:

SYSTEM	DATA CENTER SYSTEMS	GATEWAY
SY1		
SY2		

1=HELP 2=DETAIL 3=RET 6=ROLL 8=DN 10=LF 11=RT 12=TOP

Status Component Panel Definition

Next, the panels for the status components, SY1, and SY2 are defined. These panels may be accessed by pressing the DOWN PF key (PF8) on the root component panel, after placing the cursor under the desired system name. They may also be accessed directly by entering SDF SY1 or SDF SY2 from the NetView NCCF command line, or entering SCREEN SY1 from within SDF.

As these panels contain dynamic status elements, it is necessary for them to be made resident. This is done by referencing them in %INCLUDE statements in the main SDF panel definition member.

Figure 27 on page 268 shows a sample panel definition for panel SY1.

SDF Definitions

```
/* Panel definition statements for SY1 panel
P(SY1,24,80,SYSTEM,SYSTEM)
TF(01,02,10,WHITE,NORMAL)
TT(SY1)
TF(01,27,47,WHITE,NORMAL)
TT(SY1 SYSTEM STATUS)
SF(SY1.JES,04,16,24,N)
ST(JES)
SF(SY1.RMF,06,16,24,N)
ST(RMF)
SF(SY1.VTAM,08,16,24,N)
ST(VTAM)
SF(SY1.TSO,10,16,24,N)
ST(TSO)
SF(SY1.AOFAPPL,12,16,24,N)
ST(NetView)
SF(SY1.AOFSSI,14,18,28,N)
ST(NetView SSI)
SF(SY1.WTOR,4,45,50,N)
ST(WTORs:)
SF(SY1.WTOR,4,53,56,N,,c1)
SF(SY1.WTOR,4,59,67,N,,1)
SF(SY1.WTOR,5,53,56,N,,c2)
SF(SY1.WTOR,5,59,67,N,,2)
SF(SY1.WTOR,6,53,56,N,,c3)
SF(SY1.WTOR,6,59,67,N,,3)
SF(SY1.WTOR,7,53,56,N,,c4)
SF(SY1.WTOR,7,59,67,N,,4)
SF(SY1.APPLIC,9,45,57,N)
ST(Applications:)
SF(SYS1.APPLIC,9,59,67,N,,1)
SF(SYS1.APPLIC,10,59,67,N,,2)
SF(SYS1.APPLIC,11,59,67,N,,3)
SF(SYS1.APPLIC,12,59,67,N,,4)
SF(SYS1.APPLIC,13,59,67,N,,5)
SF(SYS1.APPLIC,14,59,67,N,,6)
PFK4('SDFDEL &ROOT.&RESAPPL,RV=&RV,DATE=&DATE,TIME=&TIME')
TF(24,01,79,T,NORMAL)
TT('1=HELP 2=DETAIL 3=RET          6=ROLL 7=UP      '
'          10=LF 11=RT 12=TOP')
EP(SY1)
```

Figure 27. SDF Example: Status Component Panel Definition Statements for SY1SYS

A similar panel reflecting the status of components on SY2 can be created by changing all occurrences of SY1 to SY2 in the above example.

Figure 28 on page 269 shows the layout defined by the statements in Figure 27.

Note: Three of the four available WTOR dynamic fields have been filled with the WTOR number and the name of the job that issued them. WTORs will appear whether or not their source is defined to SA z/OS.

SY1	SY1	SYSTEM	STATUS
JES		WTORs: 14	MSGPROC
18	NETVIEW		
RMF		22	MYJOB
VTAM			
Applications:	MSGPROC		
TSO			WTR00E
IMS			
NetView			CICS
ETC1			
NetView SSI			ETC2

1=HELP 2=DETAIL 3=RET 4=DELETE 6=ROLL 7=UP 10=LF 11=RT 12=TOP

Figure 28. Sample SY1 SDF Panel

The fields defined for JES, RMF, VTAM, TSO, NetView and the NetView SSI are static in that only the color of the predefined status text will change when the highest priority status descriptor queued for the underlying status component changes. The fields defining WTORs: and Applications: are also static, but do not refer to a specific subsystem. These fields will also assume the color of the highest priority status descriptor queued. The WTORs: field is green when no replies are outstanding due to the SDF tree definition for the underlying status component, SY1.WTOR. The remaining static fields will appear turquoise, or the EMPTYCOLOR defined in the AOFINIT NetView DSIPARM member.

The status fields following WTORs: and Applications: are dynamic in that both their content and color depend on the status descriptor they represent. The ability to select both the type of data and the status descriptor number (See "STATUSFIELD" on page 257) from which the data is obtained, allows generic status fields to be defined. This takes advantage of an SDF feature which allows the status descriptor to be queued under an alternate component should the primary status component not be defined in the SDF tree structure. For subsystems, the status component name is the subsystem name, and the alternate component is SUBSYS. WTORs are queued using the reply ID as the status component name, and WTOR as the alternate component name.

The use of generic field definitions have several advantages, and may reduce considerably the amount of maintenance required, particularly in large , multi-system environments. Using this method, the status components are displayed in priority order, so the most critical status subsystem is presented first. Also, if more subsystems are defined to SA z/OS than are defined on the panel, you will be notified of only the most critical situations. It is also possible to continue the list of statuses presented on additional panels if required.

You should note that using this method, subsystems do not always appear in the same position on the panel, which may make it difficult to find a specific subsystem. Also, some transient conditions can cause a subsystem to appear twice on the display. This can be eliminated by changing the SDF Status Detail definition to CLEAR=Y for the transient status definitions.

SDF Initialization Parameters in AOFINIT

For this example, the default AOFINIT entries supplied with SA z/OS are used. For more information on setting SDF initialization parameters refer to Chapter 8, "SDF Initialization Parameters," on page 241.

```

SCREENSZ = 3000
INITSCRN=SYSTEM
MAXOPS=10
PROPOP=YES
PROPDOWN=NO
TEMPERR=3
/* STATUS PANEL PF KEYS AND DESCRIPTION */
PFK1=AOCHELP SDF
PFK2=DETAIL
PFK3=RETURN
PFK4=
PFK5=
PFK6=ROLL
PFK7=UP
PFK8=DOWN
PFK9=
PFK10=LEFT
PFK11=RIGHT
PFK12=TOP
PFK13=AOCHELP SDF
PFK14=DETAIL
PFK15=RETURN
PFK16=
PFK17=
PFK18=ROLL
PFK19=UP
PFK20=DOWN
PFK21=ASSIST &ROOT,&COMPAPPL,&RV,&SID,&SNODE,&DA
PFK22=LEFT
PFK23=RIGHT
PFK24=TOP
/* DETAIL PANEL PF KEYS AND DESCRIPTION */
DPFK1=AOCHELP SDF
DPFK2=
DPFK3=RETURN
DPFK4=
DPFK5=
DPFK6=ROLL
DPFK7=UP
DPFK8=DOWN
DPFK9=ASSIST &ROOT,&COMPAPPL,&RV,&SID,&SNODE,&DA
DPFK10=SDFDEL &ROOT,&COMPAPPL,RV=&RV,DATE=&DATE,TIME=&TIME
DPFK11=BOT
DPFK12=TOP
DPFK13=AOCHELP SDF
DPFK14=
DPFK15=RETURN
DPFK16=
DPFK17=
DPFK18=ROLL
DPFK19=UP
DPFK20=DOWN
DPFK21=ASSIST &ROOT,&COMPAPPL,&RV,&SID,&SNODE,&DA
DPFK22=SDFDEL &ROOT.&COMPAPPL,RV=&RV,DATE=&DATE,TIME=&TIME
DPFK23=BOT
DPFK24=TOP
DPFKDESC1=1=HELP      3=RETURN      6=ROLL 7=UP 8=DOWN 9=ASSIST
DPFKDESC2=10=DELETE 11=BOTTOM 12=TOP
/* PRIORITY/COLOR RELATIONSHIPS (DEFAULT VALUES)
PRITBLSZ=7
PRIORITY=1,199,RED

```

PRIORITY=200,299,PINK
 PRIORITY=300,399,YELLOW
 PRIORITY=400,499,TURQUOISE
 PRIORITY=500,599,GREEN
 PRIORITY=600,699,BLUE
 DCOLOR=WHITE
 EMPTYCOLOR=BLUE

Note: /* denotes a comment field, where /* must be followed by a blank.

SDF Status Detail Definitions

In Figure 29 the default SDF Status Details definitions supplied with SA z/OS are used. For further information on how to set SDF Status Detail fields, refer to *System Automation for z/OS User's Guide*. These entries are stored in NetView DSIPARM data set member AOFSDF, and are automatically included in the master automation control file.

Note: Do not rename the AOFSDF member %INCLUDE AOFSDF.

COMMANDS	HELP

AOFGSCR	SA z/OS - Status Display Facility Details Row 1 to 15 of 56
Command ==>	SCROLL==> PAGE
Entry Type : Status Details	PolicyDB Name : DATABASE_NAME
Entry Name : AOFSDF	Enterprise Name : YOUR_ENTERPRISE
Status	Priority Highlight Color Clear Srv Req(noadd)
RWTOR	(Y,RV) NOADD
SPLGONE	(Y,RV) NOADD
COMMLIST	110 REVERSE RED Y
BROKEN	120 REVERSE RED (Y,RV*)
BREAKING	130 BLINK RED (Y,RV*)
INACTIVE	140 UNDERSCORE RED (Y,RV*)
IWTOR	150 RED Y
SPLFULL	150 RED (Y,RV)
STOPPED	150 NORMAL RED (Y,RV*)
HALFDOWN	220 NORMAL PINK (Y,RV*)
STARTED2	230 BLINK PINK (Y,RV*)
STUCK	240 UNDERSCORE PINK (Y,RV*)
ZOMBIE	250 REVERSE PINK (Y,RV*)
ABENDING	320 REVERSE WHITE (Y,RV*)
HALTED	330 UNDERSCORE WHITE (Y,RV*)
ASSIST	340 BLINK WHITE Y
ASSISTDL	350 (Y,RV*) Y NOADD
SPLSHORT	350 YELLOW (Y,RV)
UWTOR	350 YELLOW Y
STOPPING	420 REVERSE YELLOW (Y,RV*)
AUTOTERM	430 NORMAL YELLOW (Y,RV*)
ENDING	440 UNDERSCORE YELLOW (Y,RV*)
RUNNING	520 BLINK TURQUOISE (Y,RV*)
ACTIVE	530 REVERSE TURQUOISE (Y,RV*)
STARTED	540 UNDERSCORE TURQUOISE (Y,RV*)
EXTSTART	550 BLINK TURQUOISE (Y,RV*)
NWTOR	550 GREEN Y
RESTART	550 NORMAL TURQUOISE (Y,RV*)
SPLOK	550 GREEN Y
UP	640 NORMAL GREEN (Y,RV*)
ENDED	650 UNDERSCORE GREEN (Y,RV*)
DOWN	730 UNDERSCORE BLUE (Y,RV*)
AUTODOWN	740 NORMAL BLUE (Y,RV*)
CTLDOWN	750 BLINK BLUE (Y,RV*)
MOVED	760 REVERSE BLUE (Y,RV*)
FALLBACK	770 NORMAL BLUE (Y,RV*)

Figure 29. Default Values for SDF Displays

SDF Definitions

Chapter 10. SDF Commands

SDFTREE

Purpose

SDFTREE dynamically loads an SDF tree structure definition member from the NetView DSIPARM data set or deletes a tree member from system memory.

SDFTREE can be issued from a console.

Syntax

To load or delete a tree structure definition member use the following syntax:

```
▶▶ SDFTREE [tree_member,ADD | root_component_name,DELETE] ▶▶
```

Parameters

tree_member

The name of the member containing the tree structure to load.

root_component_name

The name of the root component, which is the name used for level 1 in the tree structure you want to delete. While you add a tree structure definition members by specifying a tree member name, you delete tree structure definition members by specifying a root component name.

ADD

Specifies that you want to add the specified tree structure definition member.

DELETE

Specifies that you want to delete a tree structure definition member.

Restrictions and Limitations

Tree structure definition members dynamically loaded by the SDFTREE command are not reloaded when SDF is restarted. When SDF is restarted, only members AOF TREE and any members referenced by %INCLUDE statements in AOF TREE are reloaded. You must either add the tree definitions to AOF TREE (using %INCLUDE statements) before SDF is restarted, or manually reload them using the SDFTREE command after SDF is restarted.

Usage

- When a new tree structure is loaded to replace an existing tree structure, the status descriptors of any status component with identical names in both trees are copied to the new tree.
- When an error is detected while this command is processing, no action is taken to change the existing tree structure.

Examples

SDFTREE NEWTREE,ADD loads member NEWTREE into system memory. This loading allows operators to access the tree structure defined in NEWTREE.

SDFPANEL

Purpose

SDFPANEL dynamically loads a panel member from the NetView DSIPARM data set or deletes a panel member.

SDFPANEL can be issued from a console.

Syntax

To add or delete a panel member use the following syntax:

```

▶▶ SDFPANEL panel_member,ADD panel_name,DELETE
  
```

Parameters

panel_member

The name of the member containing the panel to load.

panel_name

The name of the panel to delete. While you add panels by specifying the panel member name, you delete panels by specifying the actual panel name.

ADD

Specifies that you want to add the specified panel member.

DELETE

Specifies that you want to delete the specified panel.

Restrictions and Limitations

Panel definition members dynamically loaded by the SDFPANEL command are not reloaded when SDF is restarted. Only member AOFPNLS and any members referenced by %INCLUDE statements in AOFPNLS are reloaded. You must either add the panel definitions to AOFPNLS (using %INCLUDE statements) before SDF is restarted, or manually reload them using the SDFPANEL command after SDF is restarted.

Usage

When an error is detected while this command is processing, no action is taken to change the existing panel definitions. For example, if one of several panels defined or referenced by %INCLUDE statements in a panel definition member contains an error, none of the panels are placed into active use.

Examples

SDFPANEL NEWPANEL,ADD loads member NEWPANEL into memory. This loading allows operators to access the panel defined in NEWPANEL.

SCREEN

Purpose

The SCREEN command displays a specific SDF panel.

SCREEN can be issued only within SDF.

Syntax

►►—SCREEN—*panel_name*—◄◄

Parameters

panel_name

The name of the panel to be displayed. *panel_name* is the name of the panel as it appears in the upper left hand corner of the screen.

Restrictions and Limitations

None.

Usage

- If the specified panel is not in memory when the SCREEN command is issued, the NetView DSIPARM data set is searched for a member name matching the specified panel name. If one is found, that member is loaded for the operator from which the request was made, and the panel defined in the member is displayed.
- If an error is detected in a panel you attempt to load using the SCREEN command, the panel is not displayed.
- If you plan to use the SCREEN command frequently in your SDF implementation, you might want to define a PF key that issues the SCREEN command.

Examples

SCREEN SY1 displays the panel named SY1.

Dynamically Loading Panels and Tree Structures

You can dynamically load panels and tree structures without restarting SDF. With this dynamic loading, you can load a small number of panels during initialization, and add or delete panel subsets when required during SDF operation. This can significantly reduce the number of panels kept resident at any one time.

When you are dynamically loading panels or tree structures, there must be a member in the NetView DSIPARM data set with the same name as the panel name or the root component in the tree structure. If not, a “not found” error message is generated.

Note: Only panels loaded with the SDFPANEL command are available to all logged-on SA z/OS operators. All others are loaded only for the operator calling them.

Dynamically Loading Panels

SCREEN

You can load panels dynamically in the following ways:

- With the SDFPANEL command, as described in “SDFPANEL” on page 274.
- With the SCREEN command, as described in “SCREEN” on page 275.
- When any of the following PANEL statement parameters call a panel not defined in AOFPNLS, and a member with the same name as that panel is found in the NetView DSIPARM data set:
 - *top_panel_name*
 - *up_panel_name*
 - *down_panel_name*
 - *left_panel_name*
 - *right_panel_name*

See “PANEL” on page 255 for the PANEL statement description.

Note: Performance hint: Dynamically loading panels reduces storage requirements. However, using the SCREEN command or PANEL statements that refer to the panels not defined in AOFPNLS can result in increased processor usage. For better performance, ensure the panels are included in the AOFPNLS member either directly or by an %INCLUDE.

Dynamically Loading Tree Structures

You can load SDF tree structures dynamically with the SDFTREE command, as described in “SDFTREE” on page 273.

When you load a new tree structure to replace an existing one, any status descriptors with identical names in both tree structures are copied to the new tree structure.

Dynamic Loading Example

Suppose you change the tree structure for root component SY1 and the panel named SY1SYS. The tree structure and panel definitions are maintained in separate members (instead of being directly coded in AOFRTREE or AOFPNLS). Use the following commands to load the new definitions:

```
SDFTREE SY1,ADD  
SDFPANEL SY1SYS,ADD
```

For more information, see “SDFTREE” on page 273 and “SDFPANEL” on page 274.

Dynamic Loading Commands

Use the following commands to dynamically load SDF tree structures and panels, and to confirm that a panel was loaded:

SDFTREE

Load Tree Structure Definition Member

SDFPANEL

Load Panel Definition Member

SCREEN

Display a SDF Panel

When an error is detected while any of these dynamic loading commands is processing, no action is taken to change the existing tree structure or panel definitions. For example, if one of several panels defined or referenced by

%INCLUDE statements in a panel definition member contains an error, none of the panels are placed into active use. Similarly, if an error is detected in a panel you attempt to load using the SCREEN command, the panel is not displayed.

Verifying Dynamic Loading of Panels

Use the SCREEN command to verify that a panel was correctly loaded. See “SCREEN” on page 275 for the SCREEN command description.

You might want to create a test version of a panel you are modifying and display it using the SCREEN command to verify that your changes are correct. To do this:

1. Copy the existing panel definition member into another panel definition member.
2. Modify the panel definition statements in the new panel definition member. Use a different name for the panel on the PANEL statement.
3. Use the SCREEN command to verify that the changes to the panel are correct.
4. If you see anything in the displayed panel that should change, correct the panel definition statements.
5. Rename the panel to the name used for the production version of the panel. To do this, change the name specified on the PANEL statement.
6. Use the SDFPANEL command to load the new panel and put it into production. This SDFPANEL command causes the new panel to overwrite the old panel.

SCREEN

Glossary

This glossary includes terms and definitions from:

- The *IBM Dictionary of Computing* New York: McGraw-Hill, 1994.
- The *American National Standard Dictionary for Information Systems*, ANSI X3.172-1990, copyright 1990 by the American National Standards Institute (ANSI). Copies can be purchased from the American National Standards Institute, 1430 Broadway, New York, New York 10018. Definitions are identified by the symbol (A) after the definition.
- The *Information Technology Vocabulary* developed by Subcommittee 1, Joint Technical Committee 1, of the International Organization for Standardization and the International Electrotechnical Commission (ISO/IEC JTC1/SC1). Definitions of published parts of this vocabulary are identified by the symbol (I) after the definition; definitions taken from draft international standards, committee drafts, and working papers being developed by ISO/IEC JTC1/SC1 are identified by the symbol (T) after the definition, indicating that final agreement has not yet been reached among the participating National Bodies of SC1.

The following cross-references are used in this glossary:

Contrast with. This refers to a term that has an opposed or substantively different meaning.

Deprecated term for. This indicates that the term should not be used. It refers to a preferred term, which is defined in its proper place in the glossary.

See. This refers the reader to multiple-word terms in which this term appears.

See also. This refers the reader to terms that have a related, but not synonymous, meaning.

Synonym for. This indicates that the term has the same meaning as a preferred term, which is defined in the glossary.

Synonymous with. This is a backward reference from a defined term to all other terms that have the same meaning.

A

ACF. Automation control file.

ACF/NCP. Advanced Communications Function for the Network Control Program. See *Advanced Communications Function* and *Network Control Program*.

ACF/VTAM. Advanced Communications Function for the Virtual Telecommunications Access Method. Synonym for *VTAM*. See *Advanced Communications Function* and *Virtual Telecommunications Access Method*.

active monitoring. In SA z/OS, the acquiring of resource status information by soliciting such information at regular, user-defined intervals. See also *passive monitoring*.

adapter. Hardware card that enables a device, such as a workstation, to communicate with another device, such as a monitor, a printer, or some other I/O device.

Address Space Workflow. In RMF, a measure of how a job uses system resources and the speed at which the job moves through the system. A low workflow indicates that a job has few of the resources it needs and is contending with other jobs for system resources. A high workflow indicates that a job has all the resources it needs to execute.

adjacent hosts. Systems connected in a peer relationship using adjacent NetView sessions for purposes of monitoring and control.

adjacent NetView. In SA z/OS, the system defined as the communication path between two SA z/OS systems that do not have a direct link. An adjacent NetView is used for message forwarding and as a communication link between two SA z/OS systems. For example, the adjacent NetView is used when sending responses from a focal point to a remote system.

Advanced Communications Function (ACF). A group of IBM licensed programs (principally VTAM, TCAM, NCP, and SSP) that use the concepts of Systems Network Architecture (SNA), including distribution of function and resource sharing.

advanced program-to-program communication (APPC). A set of inter-program communication services that support cooperative transaction processing in a Systems Network Architecture (SNA) network. APPC is the implementation, on a given system, of SNA's logical unit type 6.2.

alert. (1) In SNA, a record sent to a system problem management focal point or to a collection point to communicate the existence of an alert condition. (2) In NetView, a high-priority event that warrants immediate

attention. A database record is generated for certain event types that are defined by user-constructed filters.

alert condition. A problem or impending problem for which some or all of the process of problem determination, diagnosis, and resolution is expected to require action at a control point.

alert focal-point system. See entry for NPDA focal-point system under *focal—point system*.

alert threshold. An application or volume service value that determines the level at which SA z/OS changes the associated icon in the graphic interface to the alert color. SA z/OS may also issue an alert. See *warning threshold*.

AMC. (1) Automation Manager Configuration (2) The Auto Msg Classes entry type

APF. Authorized program facility.

API. Application programming interface.

APPC. Advanced program-to-program communications.

application. An z/OS subsystem or job monitored by SA z/OS.

Application entry. A construct, created with the customization dialogs, used to represent and contain policy for an application.

application group. A named set of applications. An application group is part of an SA z/OS enterprise definition and is used for monitoring purposes.

ApplicationGroup entry. A construct, created with the customization dialogs, used to represent and contain policy for an application group.

application program. (1) A program written for or by a user that applies to the user's work, such as a program that does inventory or payroll. (2) A program used to connect and communicate with stations in a network, enabling users to perform application-oriented activities.

ARM. Automatic restart management.

ASCB. Address space control block.

ASCB status. An application status derived by SA z/OS running a routine (the ASCB checker) that searches the z/OS address space control blocks (ASCBs) for address spaces with a particular job name. The job name used by the ASCB checker is the job name defined in the customization dialog for the application.

ASCII (American National Standard Code for Information Interchange). The standard code, using a coded character set consisting of 7-bit coded characters

(8-bit including parity check), for information interchange among data processing systems, data communication systems, and associated equipment. The ASCII set consists of control characters and graphic characters. (A)

ASF. Automation status file.

assist mode facility. An SA z/OS facility that uses SDF and enables interaction with automation before SA z/OS takes an automation action. SDF prompts the operator with a suggested action, then provides options for using that action, modifying and using the action, or canceling the action. Also called assist mode, it is enabled using the customization dialogs, or dynamically.

authorized program facility (APF). A facility that permits identification of programs that are authorized to use restricted functions.

automated function. SA z/OS automated functions are automation operators, NetView autotasks that are assigned to perform specific automation functions. However, SA z/OS defines its own synonyms, or *automated function names*, for the NetView autotasks, and these function names are referred to in the sample policy databases provided by SA z/OS. For example, the automation operator AUTBASE corresponds to the SA z/OS automated function BASEOPER.

automated console operations (ACO). The concept (versus a product) of using computers to perform a large subset of tasks ordinarily performed by operators, or assisting operators in performing these tasks.

automatic restart management. A z/OS recovery function that improves the availability of specified subsystems and applications by automatically restarting them under certain circumstances. Automatic restart management is a function of the Cross-System Coupling Facility (XCF) component of z/OS.

automatic restart management element name. In MVS 5.2 or later, z/OS automatic restart management requires the specification of a unique sixteen character name for each address space that registers with it. All automatic restart management policy is defined in terms of the element name, including SA z/OS's interface with it.

automation. The automatic initiation of actions in response to detected conditions or events. SA z/OS provides automation for z/OS applications, z/OS components, and remote systems that run z/OS. SA z/OS also provides tools that can be used to develop additional automation.

automation agent. In SA z/OS, the automation function is split up between the automation manager and the automation agents. The observing, reacting and doing parts are located within the NetView address

space, and are known as the *automation agents*. The automation agents are responsible for:

- recovery processing
- message processing
- active monitoring; they propagate status changes to the automation manager

automation configuration file. The data set that consists of:

- the automation control file (ACF)
- the automation manager configuration file (AMC)
- the NetView automation table (AT)
- the MPFLSTSA member

automation control file (ACF). In SA z/OS, a file that contains system-level automation policy information. There is one master automation control file for each NetView system on which SA z/OS is installed. Additional policy information and all resource status information is contained in the policy database (PDB). The SA z/OS customization dialogs must be used to build the automation control files. They must not be edited manually.

automation flags. In SA z/OS, the automation policy settings that determine the operator functions that are automated for a resource and the times during which automation is active. When SA z/OS is running, automation is controlled by automation flag policy settings and override settings (if any) entered by the operator. Automation flags are set using the customization dialogs.

automation manager. In SA z/OS, the automation function is split up between the automation manager and the automation agents. The coordination, decision making and controlling functions are processed by each sysplex's *automation manager*.

The automation manager contains a model of all of the automated resources within the sysplex. The automation agents feed the automation manager with status information and perform the actions that the automation manager tells them to.

The automation manager provides *sysplex-wide* automation.

Automation Manager Configuration. The Automation Manager Configuration file (AMC) contains an image of the automated systems in a sysplex or of a standalone system.

Automation NetView. In SA z/OS the NetView that performs routine operator tasks with command procedures or uses other ways of automating system and network management, issuing automatic responses to messages and management services units.

automation operator. NetView automation operators are NetView autotasks that are assigned to perform specific automation functions. See also *automated*

function. NetView automation operators may receive messages and process automation procedures. There are no logged-on users associated with automation operators. Each automation operator is an operating system task and runs concurrently with other NetView tasks. An automation operator could be set up to handle JES2 messages that schedule automation procedures, and an automation statement could route such messages to the automation operator. Similar to *operator station task*. SA z/OS message monitor tasks and target control tasks are automation operators.

automation policy. The policy information governing automation for individual systems. This includes automation for applications, z/OS subsystems, z/OS data sets, and z/OS components.

automation policy settings. The automation policy information contained in the automation control file. This information is entered using the customization dialogs. You can display or modify these settings using the customization dialogs.

automation procedure. A sequence of commands, packaged as a NetView command list or a command processor written in a high-level language. An automation procedure performs automation functions and runs under NetView.

automation status file. In SA z/OS, a file containing status information for each automated subsystem, component or data set. This information is used by SA z/OS automation when taking action or when determining what action to take. In Release 2 and above of AOC/MVS, status information is also maintained in the operational information base.

automation table (AT). See *NetView automation table*.

autotask. A NetView automation task that receives messages and processes automation procedures. There are no logged-on users associated with autotasks. Each autotask is an operating system task and runs concurrently with other NetView tasks. An autotask could be set up to handle JES2 messages that schedule automation procedures, and an automation statement could route such messages to the autotasks. Similar to *operator station task*. SA z/OS message monitor tasks and target control tasks are autotasks. Also called *automation operator*.

available. In VTAM programs, pertaining to a logical unit that is active, connected, enabled, and not at its session limit.

B

basic mode. A central processor mode that does not use logical partitioning. Contrast with *logically partitioned (LPAR) mode*.

BCP Internal Interface. Processor function of CMOS-390, zSeries processor families. It allows the communication between basic control programs such as z/OS and the processor support element in order to exchange information or to perform processor control functions. Programs using this function can perform hardware operations such as ACTIVATE or SYSTEM RESET.

beaconing. The repeated transmission of a frame or messages (beacon) by a console or workstation upon detection of a line break or outage.

BookManager. An IBM product that lets users view softcopy documents on their workstations.

C

central processor (CP). The part of the computer that contains the sequencing and processing facilities for instruction execution, initial program load (IPL), and other machine operations.

central processor complex (CPC). A physical collection of hardware that consists of central storage, one or more central processors, timers, and channels.

central site. In a distributed data processing network, the central site is usually defined as the focal point for alerts, application design, and remote system management tasks such as problem management.

CFR/CFS and ISC/ISR. I/O operations can display and return data about integrated system channels (ISC) connected to a coupling facility and coupling facility receiver (CFR) channels and coupling facility sender (CFS) channels.

channel. A path along which signals can be sent; for example, data channel, output channel. See also *link*.

channel path identifier. A system-unique value assigned to each channel path.

CHPID. In SA z/OS, channel path ID; the address of a channel.

CHPID port. A label that describes the system name, logical partitions, and channel paths.

channel-attached. (1) Attached directly by I/O channels to a host processor (for example, a channel-attached device). (2) Attached to a controlling unit by cables, rather than by telecommunication lines. Contrast with *link-attached*. Synonymous with *local*.

CI. Console integration.

CICS/VS. Customer Information Control System for Virtual Storage.

CLIST. Command list.

clone. A set of definitions for application instances that are derived from a basic application definition by substituting a number of different system-specific values into the basic definition.

clone ID. A generic means of handling system-specific values such as the MVS SYSCONE or the VTAM subarea number. Clone IDs can be substituted into application definitions and commands to customize a basic application definition for the system that it is to be instantiated on.

CNC. A channel path that transfers data between a host system image and an ESCON control unit. It can be point-to-point or switchable.

command. A request for the performance of an operation or the execution of a particular program.

command facility. The component of NetView that is a base for command processors that can monitor, control, automate, and improve the operation of a network. The successor to NCCF.

command list (CLIST). (1) A list of commands and statements, written in the NetView command list language or the REXX language, designed to perform a specific function for the user. In its simplest form, a command list is a list of commands. More complex command lists incorporate variable substitution and conditional logic, making the command list more like a conventional program. Command lists are typically interpreted rather than being compiled. (2) In SA z/OS, REXX command lists that can be used for automation procedures.

command procedure. In NetView, either a command list or a command processor.

command processor. A module designed to perform a specific function. Command processors, which can be written in assembler or a high-level language (HLL), are issued as commands.

Command Tree/2. An OS/2-based program that helps you build commands on an OS/2 window, then routes the commands to the destination you specify (such as a 3270 session, a file, a command line, or an application program). It provides the capability for operators to build commands and route them to a specified destination.

common commands. The SA z/OS subset of the CPC operations management commands.

common routine. One of several SA z/OS programs that perform frequently used automation functions. Common routines can be used to create new automation procedures.

Common User Access (CUA) architecture. Guidelines for the dialog between a human and a workstation or terminal.

communication controller. A type of communication control unit whose operations are controlled by one or more programs stored and executed in the unit or by a program executed in a processor to which the controller is connected. It manages the details of line control and the routing of data through a network.

communication line. Deprecated term for *telecommunication line*.

connectivity view. In SA z/OS, a display that uses graphic images for I/O devices and lines to show how they are connected.

console automation. The process of having NetView facilities provide the console input usually handled by the operator.

console connection. In SA z/OS, the 3270 or ASCII (serial) connection between a PS/2 computer and a target system. Through this connection, the workstation appears (to the target system) to be a console.

console integration (CI). A hardware facility that if supported by an operating system, allows operating system messages to be transferred through an internal hardware interface for display on a system console. Conversely, it allows operating system commands entered at a system console to be transferred through an internal hardware interface to the operating system for processing.

consoles. Workstations and 3270-type devices that manage your enterprise.

Control units. Hardware units that control I/O operations for one or more devices. You can view information about control units through I/O operations, and can start or stop data going to them by blocking and unblocking ports.

controller. A unit that controls I/O operations for one or more devices.

couple data set. A data set that is created through the XCF couple data set format utility and, depending on its designated type, is shared by some or all of the z/OS systems in a sysplex. See also *sysplex couple data set* and *XCF couple data set*.

coupling facility. The hardware element that provides high-speed caching, list processing, and locking functions in a sysplex.

CP. Central processor.

CPC. Central processor complex.

CPC operations management commands. A set of commands and responses for controlling the operation of System/390 CPCs.

CPC subset. All or part of a CPC. It contains the minimum *resource* to support a single control program.

CPCB. Command processor control block; an I/O operations internal control block that contains information about the command being processed.

CPU. Central processing unit. Deprecated term for *processor*.

cross-system coupling facility (XCF). XCF is a component of z/OS that provides functions to support cooperation between authorized programs running within a sysplex.

CTC. The channel-to-channel (CTC) channel can communicate with a CTC on another host for intersystem communication.

Customer Information Control System (CICS). A general-purpose transactional program that controls online communication between terminal users and a database for a large number of end users on a real-time basis.

customization dialogs. The customization dialogs are an ISPF application. They are used to customize the enterprise policy, like, for example, the enterprise resources and the relationships between resources, or the automation policy for systems in the enterprise. How to use these dialogs is described in *System Automation for z/OS Customizing and Programming*.

CVC. A channel operating in converted (CVC) mode transfers data in blocks and a CBY channel path transfers data in bytes. Converted CVC or CBY channel paths can communicate with a parallel control unit. This resembles a point-to-point parallel path and dedicated connection, regardless whether it passes through a switch.

D

DASD. Direct access storage device.

data services task (DST). The NetView subtask that gathers, records, and manages data in a VSAM file or a network device that contains network management information.

data set. The major unit of data storage and retrieval, consisting of a collection of data in one of several prescribed arrangements and described by control information to which the system has access.

data set members. Members of partitioned data sets that are individually named elements of a larger file that can be retrieved by name.

DBCS. Double-byte character set.

DCCF. Disabled console communication facility.

DCF. Document composition facility.

DELAY Report. An RMF report that shows the activity of each job in the system and the hardware and software resources that are delaying each job.

Devices. You can see information about all devices (such as printers, tape or disk drives, displays, or communications controllers) attached to a particular switch, and control paths and jobs to devices.

DEVR Report. An RMF report that presents information about the activity of I/O devices that are delaying jobs.

dialog. Interactive 3270 panels.

direct access storage device (DASD). A device in which the access time is effectively independent of the location of the data; for example, a disk.

disabled console communication facility (DCCF). A z/OS component that provides limited-function console communication during system recovery situations.

display. (1) To present information for viewing, usually on the screen of a workstation or on a hardcopy device. (2) Deprecated term for *panel*.

disk operating system (DOS). (1) An operating system for computer systems that use disks and diskettes for auxiliary storage of programs and data. (2) Software for a personal computer that controls the processing of programs. For the IBM Personal Computer, the full name is Personal Computer Disk Operating System (PCDOS).

distribution manager. The component of the NetView program that enables the host system to use, send, and delete files and programs in a network of computers.

domain. (1) An access method and its application programs, communication controllers, connecting lines, modems, and attached workstations. (2) In SNA, a system services control point (SSCP) and the physical units (PUs), logical units (LUs), links, link stations, and associated resources that the SSCP can control by means of activation requests and deactivation requests.

double-byte character set (DBCS). A character set, such as Kanji, in which each character is represented by a 2-byte code.

DP enterprise. Data processing enterprise.

DSIPARM. This file is a collection of members of NetView's customization.

DST. Data Services Task.

E

EBCDIC. Extended binary-coded decimal interchange code. A coded character set consisting of 8-bit coded characters.

ECB. Event control block. A control block used to represent the status of an event.

EMCS. Extended multiple console support.

enterprise. An organization, such as a business or a school, that uses data processing.

enterprise monitoring. Enterprise monitoring is used by SA z/OS to update the *NetView Management Console (NMC)* resource status information that is stored in the *Resource Object Data Manager (RODM)*. Resource status information is acquired by enterprise monitoring of the *Resource Measurement Facility (RMF) Monitor III* service information at user-defined intervals. SA z/OS stores this information in its operational information base, where it is used to update the information presented to the operator in graphic displays.

entries. Resources, such as processors, entered on panels.

entry type. Resources, such as processors or applications, used for automation and monitoring.

environment. Data processing enterprise.

error threshold. An automation policy setting that specifies when SA z/OS should stop trying to restart or recover an application, subsystem or component, or offload a data set.

ESA. Enterprise Systems Architecture.

eServer. Processor family group designator used by the SA z/OS customization dialogs to define a target hardware as member of the zSeries or 390-CMOS processor families.

event. (1) In NetView, a record indicating irregularities of operation in physical elements of a network. (2) An occurrence of significance to a task; for example, the completion of an asynchronous operation, such as an input/output operation. (3) Events are part of a trigger condition, in a way that if all events of a trigger condition have occurred, a *STARTUP* or *SHUTDOWN* of an application is performed.

exception condition. An occurrence on a system that is a deviation from normal operation. SA z/OS monitoring highlights exception conditions and allows an SA z/OS enterprise to be managed by exception.

extended recovery facility (XRF). A facility that minimizes the effect of failures in z/OS, VTAM, the host processor, or high availability applications during sessions between high availability applications and designated terminals. This facility provides an alternate subsystem to take over sessions from the failing subsystem.

F

fallback system. See *secondary system*.

field. A collection of bytes within a record that are logically related and are processed as a unit.

file manager commands. A set of SA z/OS commands that read data from or write data to the automation control file or the operational information base. These commands are useful in the development of automation that uses SA z/OS facilities.

focal point. In NetView, the focal-point domain is the central host domain. It is the central control point for any management services element containing control of the network management data.

focus host. A processor with the role in the context of a unified system image

focal point system. (1) A system that can administer, manage, or control one or more target systems. There are a number of different focal point systems associated with IBM automation products. (2) **NMC focal point system.** The NMC focal point system is a NetView system with an attached workstation server and LAN that gathers information about the state of the network. This focal point system uses RODM to store the data it collects in the data model. The information stored in RODM can be accessed from any LAN-connected workstation with NetView Management Console installed. (3) **NPDA focal point system.** This is a NetView system that collects all the NPDA alerts that are generated within your enterprise. It is supported by NetView. If you have SA z/OS installed the NPDA focal point system must be the same as your NMC focal point system. The NPDA focal point system is also known as the *alert focal point system*. (4) **SA z/OS Processor Operations focal point system.** This is a NetView system that has SA z/OS host code installed. The SA z/OS Processor Operations focal point system receives messages from the systems and operator consoles of the machines that it controls. It provides full systems and operations console function for its target systems. It can be used to IPL these systems. Note that some restrictions apply to the Hardware Management Console for an S/390 microprocessor cluster. (5) **SA z/OS SDF focal point system.** The SA z/OS SDF focal point system is an SA z/OS NetView system that collects status information from other SA z/OS NetViews within your enterprise. (6) **Status focal point system.** In NetView, the system to which STATMON, VTAM and NLDM send status information on network resources. If you have a NMC focal point, it must be on the same system as the Status focal point. (7) **Hardware Management Console.** Although not listed as a focal point, the Hardware Management Console acts as a focal point for the console functions of an S/390 microprocessor cluster. Unlike all the other focal points in this definition, the

Hardware Management Console runs on a LAN-connected workstation,

frame. For a System/390 microprocessor cluster, a frame contains one or two central processor complexes (CPCs), support elements, and AC power distribution.

full-screen mode. In NetView, a form of panel presentation that makes it possible to display the contents of an entire workstation screen at once. Full-screen mode can be used for fill-in-the-blanks prompting. Contrast with *line mode*.

G

gateway session. An NetView-NetView Task session with another system in which the SA z/OS outbound gateway operator logs onto the other NetView session without human operator intervention. Each end of a gateway session has both an inbound and outbound gateway operator.

generic alert. Encoded alert information that uses code points (defined by IBM and possibly customized by users or application programs) stored at an alert receiver, such as NetView.

generic routines. In SA z/OS, a set of self-contained automation routines that can be called from the NetView automation table, or from user-written automation procedures.

group. A collection of target systems defined through configuration dialogs. An installation might set up a group to refer to a physical site or an organizational or application entity.

group entry. A construct, created with the customization dialogs, used to represent and contain policy for a group.

group entry type. A collection of target systems defined through the customization dialog. An installation might set up a group to refer to a physical site or an organizational entity. Groups can, for example, be of type STANDARD or SYSPLEX.

H

Hardware Management Console. A console used by the operator to monitor and control a System/390 microprocessor cluster.

Hardware Management Console Application (HWMCA). A direct-manipulation object-oriented graphical user interface that provides single point of control and single system image for hardware elements. HWMCA provides customer grouping support, aggregated and real-time system status using colors, consolidated hardware messages support, consolidated operating system messages support, consolidated

service support, and hardware commands targeted at a single system, multiple systems, or a customer group of systems.

heartbeat. In SA z/OS, a function that monitors the validity of the status forwarding path between remote systems and the NMC focal point, and monitors the availability of remote z/OS systems, to ensure that status information displayed on the SA z/OS workstation is current.

help panel. An online panel that tells you how to use a command or another aspect of a product.

hierarchy. In the NetView program, the resource types, display types, and data types that make up the organization, or levels, in a network.

high-level language (HLL). A programming language that does not reflect the structure of any particular computer or operating system. For the NetView program, the high-level languages are PL/I and C.

HLL. High-level language.

host system. In a coupled system or distributed system environment, the system on which the facilities for centralized automation run. SA z/OS publications refer to target systems or focal-point systems instead of hosts.

host (primary processor). The processor at which you enter a command (also known as the *issuing processor*).

HWMCA. Hardware Management Console Application. Application for the graphic hardware management console that monitors and controls a central processor complex. It is attached to a target processor (a system 390 microprocessor cluster) as a dedicated system console. This microprocessor uses OCF to process commands.

I

images. A grouping of processors and I/O devices that you define. You can define a single-image mode that allows a multiprocessor system to function as one central processor image.

IMS/VS. Information Management System/Virtual Storage.

inbound. In SA z/OS, messages sent to the focal-point system from the PC or target system.

inbound gateway operator. The automation operator that receives incoming messages, commands, and responses from the outbound gateway operator at the sending system. The inbound gateway operator handles communications with other systems using a gateway session.

Information Management System/Virtual Storage (IMS/VS). A database/data communication (DB/DC) system that can manage complex databases and networks. Synonymous with IMS.

INGEIO PROC. The I/O operations default procedure name; part of the SYS1.PROCLIB.

initial program load (IPL). (1) The initialization procedure that causes an operating system to commence operation. (2) The process by which a configuration image is loaded into storage at the beginning of a workday or after a system malfunction. (3) The process of loading system programs and preparing a system to run jobs.

initialize automation. SA z/OS-provided automation that issues the correct z/OS start command for each subsystem when SA z/OS is initialized. The automation ensures that subsystems are started in the order specified in the automation control file and that prerequisite applications are functional.

input/output support processor (IOSP). The hardware unit that provides I/O support functions for the primary support processor and maintenance support functions for the processor controller.

Interactive System Productivity Facility (ISPF). An IBM licensed program that serves as a full-screen editor and dialog manager. Used for writing application programs, it provides a means of generating standard screen panels and interactive dialogs between the application programmer and the terminal user.

interested operator list. The list of operators who are to receive messages from a specific target system.

internal token. A *logical token* (LTOK); name by which the I/O resource or object is known; stored in IODF.

IOCDs. I/O configuration data set. The data set that describes the I/O configuration.

I/O Ops. I/O operations.

IOSP. Input/Output Support Processor.

I/O operations. The part of SA z/OS that provides you with a single point of logical control for managing connectivity in your active I/O configurations. I/O operations takes an active role in detecting unusual conditions and lets you view and change paths between a processor and an I/O device, using dynamic switching (the ESCON director). Also known as I/O Ops.

I/O resource number. Combination of channel path identifier (CHPID), device number, etc. See internal token.

IPL. Initial program load.

ISA. Industry Standard Architecture.

ISPF. Interactive System Productivity Facility.

ISPF console. From this 3270-type console you are logged onto ISPF to use the runtime panels for I/O operations and SA z/OS customization panels.

issuing host. See *primary host*; the base program at which you enter a command for processing.

J

JCL. Job control language.

JES. Job entry subsystem.

job. (1) A set of data that completely defines a unit of work for a computer. A job usually includes all necessary computer programs, linkages, files, and instructions to the operating system. (2) An address space.

job control language (JCL). A problem-oriented language designed to express statements in a job that are used to identify the job or describe its requirements to an operating system.

job entry subsystem (JES). A facility for spooling, job queuing, and managing I/O. In SA z/OS publications, JES refers to JES2 or JES3, unless distinguished as being either one or the other.

K

Kanji. An ideographic character set used in Japanese. See also *double-byte character set*.

L

LAN. Local area network.

line mode. A form of screen presentation in which the information is presented a line at a time in the message area of the terminal screen. Contrast with *full-screen mode*.

link. (1) In SNA, the combination of the link connection and the link stations joining network nodes; for example, a System/370 channel and its associated protocols, a serial-by-bit connection under the control of synchronous data link control (SDLC). (2) In SA z/OS, link connection is the physical medium of transmission.

link-attached. Describes devices that are physically connected by a telecommunication line. Contrast with *channel-attached*.

Linux for zSeries and S/390. UNIX-like open source operating system conceived by Linus Torvalds and developed across the internet.

local. Pertaining to a device accessed directly without use of a telecommunication line. Synonymous with *channel-attached*.

local area network (LAN). (1) A network in which a set of devices is connected for communication. They can be connected to a larger network. See also *token ring*. (2) A network in which communications are limited to a moderately-sized geographic area such as a single office building, warehouse, or campus, and that do not generally extend across public rights-of-way.

logical partition (LP). A subset of the processor hardware that is defined to support an operating system. See also *logically partitioned (LPAR) mode*.

logical switch number (LSN). Assigned with the switch parameter of the CHPID macro of the IOCP.

logical token (LTOK). Resource number of an object in the IODF.

logical unit (LU). In SNA, a port through which an end user accesses the SNA network and the functions provided by system services control points (SSCPs). An LU can support at least two sessions — one with an SSCP and one with another LU — and may be capable of supporting many sessions with other LUs. See also *physical unit (PU)* and *system services control point (SSCP)*.

logical unit (LU) 6.2. A type of logical unit that supports general communications between programs in a distributed processing environment. LU 6.2 is characterized by (a) a peer relationship between session partners, (b) efficient use of a session for multiple transactions, (c) comprehensive end-to-end error processing, and (d) a generic application program interface (API) consisting of structured verbs that are mapped into a product implementation. Synonym for advanced program-to-program communications (APPC).

logically partitioned (LPAR) mode. A central processor mode that enables an operator to allocate system processor hardware resources among several logical partitions. Contrast with *basic mode*.

LOGR. The sysplex logger.

LP. Logical partition.

LPAR. Logically partitioned (mode).

LU. Logical unit.

LU-LU session. In SNA, a session between two logical units (LUs) in an SNA network. It provides communication between two end users, or between an end user and an LU services component.

LU 6.2. Logical unit 6.2.

LU 6.2 session. A session initiated by VTAM on behalf of an LU 6.2 application program, or a session initiated by a remote LU in which the application program specifies that VTAM is to control the session by using the APPCCMD macro.

M

MAT. Deprecated term for NetView Automation Table.

MCA. Micro Channel* architecture.

MCS. Multiple console support.

member. A specific function (one or more modules/routines) of a multisystem application that is defined to XCF and assigned to a group by the multisystem application. A member resides on one system in the sysplex and can use XCF services to communicate (send and receive data) with other members of the same group.

message automation table (MAT). Deprecated term for NetView Automation Table.

message class. A number that SA z/OS associates with a message to control routing of the message. During automated operations, the classes associated with each message issued by SA z/OS are compared to the classes assigned to each notification operator. Any operator with a class matching one of the message's classes receives the message.

message forwarding. The SA z/OS process of sending messages generated at an SA z/OS target system to the SA z/OS focal-point system.

message group. Several messages that are displayed together as a unit.

message monitor task. A task that starts and is associated with a number of communications tasks. Message monitor tasks receive inbound messages from a communications task, determine the originating target system, and route the messages to the appropriate target control tasks.

message processing facility (MPF). A z/OS table that screens all messages sent to the z/OS console. The MPF compares these messages with a customer-defined list of messages on which to automate, suppress from the z/OS console display, or both, and marks messages to automate or suppress. Messages are then broadcast on the subsystem interface (SSI).

message suppression. The ability to restrict the amount of message traffic displayed on the z/OS console.

Micro Channel architecture. The rules that define how subsystems and adapters use the Micro Channel bus in a computer. The architecture defines the services that each subsystem can or must provide.

microprocessor. A processor implemented on one or a small number of chips.

migration. Installation of a new version or release of a program to replace an earlier version or release.

MP. Multiprocessor.

MPF. Message processing facility.

MPFLSTSA. The MPFLST member that is built by SA z/OS.

Multiple Virtual Storage (MVS). An IBM licensed program. MVS, which is the predecessor of OS/390, is an operating system that controls the running of programs on a System/390 or System/370 processor. MVS includes an appropriate level of the Data Facility Product (DFP) and Multiple Virtual Storage/Enterprise Systems Architecture System Product Version 5 (MVS/ESA SP5).

multiprocessor (MP). A CPC that can be physically partitioned to form two operating processor complexes.

multisystem application. An application program that has various functions distributed across z/OS images in a multisystem environment.

multisystem environment. An environment in which two or more z/OS images reside in one or more processors, and programs on one image can communicate with programs on the other images.

MVS. Multiple Virtual Storage, predecessor of z/OS.

MVS image. A single occurrence of the MVS/ESA operating system that has the ability to process work.

MVS/JES2. Multiple Virtual Storage/Job Entry System 2. A z/OS subsystem that receives jobs into the system, converts them to internal format, selects them for execution, processes their output, and purges them from the system. In an installation with more than one processor, each JES2 processor independently controls its job input, scheduling, and output processing.

MVS/ESA. Multiple Virtual Storage/Enterprise Systems Architecture.

N

NAU. (1) Network accessible unit. (2) Network addressable unit.

NCCF. Network Communications Control Facility.

NCP. (1) Network Control Program (IBM licensed program). Its full name is Advanced Communications Function for the Network Control Program. Synonymous with *ACF/NCP*. (2) Network control program (general term).

NetView. An IBM licensed program used to monitor a network, manage it, and diagnose network problems. NetView consists of a command facility that includes a presentation service, command processors, automation based on command lists, and a transaction processing structure on which the session monitor, hardware monitor, and terminal access facility (TAF) network management applications are built.

network accessible unit (NAU). A logical unit (LU), physical unit (PU), control point (CP), or system services control point (SSCP). It is the origin or the destination of information transmitted by the path control network. Synonymous with *network addressable unit*.

network addressable unit (NAU). Synonym for *network accessible unit*.

NetView automation procedures. A sequence of commands, packaged as a NetView command list or a command processor written in a high-level language. An automation procedure performs automation functions and runs under the NetView program.

NetView automation table (AT). A table against which the NetView program compares incoming messages. A match with an entry triggers the specified response. SA z/OS entries in the NetView automation table trigger an SA z/OS response to target system conditions. Formerly known as the message automation table (MAT).

NetView Command list language. An interpretive language unique to NetView that is used to write command lists.

NetView (NCCF) console. A 3270-type console for NetView commands and runtime panels for system operations and processor operations.

NetView Graphic Monitor Facility (NGMF). Deprecated term for NetView Management Console.

NetView hardware monitor. The component of NetView that helps identify network problems, such as hardware, software, and microcode, from a central control point using interactive display techniques. Formerly called *network problem determination application*.

NetView log. The log in which NetView records events pertaining to NetView and SA z/OS activities.

NetView message table. See *NetView automation table*.

NetView Management Console (NMC). A function of the NetView program that provides a graphic, topological presentation of a network that is controlled by the NetView program. It provides the operator different views of a network, multiple levels of graphical detail, and dynamic resource status of the network. This function consists of a series of graphic

windows that allows you to manage the network interactively. Formerly known as the NetView Graphic Monitor Facility (NGMF).

NetView-NetView task (NNT). The task under which a cross-domain NetView operator session runs. Each NetView program must have a NetView-NetView task to establish one NNT session. See also *operator station task*.

NetView-NetView Task session. A session between two NetView programs that runs under a NetView-NetView Task. In SA z/OS, NetView-NetView Task sessions are used for communication between focal point and remote systems.

NetView paths via logical unit (LU 6.2). A type of network-accessible port (VTAM connection) that enables end users to gain access to SNA network resources and communicate with each other. LU 6.2 permits communication between processor operations and the workstation.

network. (1) An interconnected group of nodes. (2) In data processing, a user application network. See *SNA network*.

Network Communications Control Facility (NCCF). The operations control facility for the network. NCCF consists of a presentation service, command processors, automation based on command lists, and a transaction processing structure on which the network management applications NLDM and NPDA are built. NCCF is a precursor to the NetView command facility.

Network Control Program (NCP). An IBM licensed program that provides communication controller support for single-domain, multiple-domain, and interconnected network capability. Its full name is Advanced Communications Function for the Network Control Program.

Networking NetView. In SA z/OS the NetView that performs network management functions, such as managing the configuration of a network. In SA z/OS it is common to also route alerts to the Networking NetView.

Network Problem Determination Application (NPDA). An NCCF application that helps you identify network problems, such as hardware, software, and microcode, from a central control point using interactive display methods. The alert manager for the network. The precursor of the NetView hardware monitor.

NGMF. Deprecated term for NetView Management Console.

NGMF focal-point system. Deprecated term for NMC focal point system.

NIP. Nucleus initialization program.

NMC focal point system. See *focal point system*

NMC workstation. The NMC workstation is the primary way to dynamically monitor SA z/OS systems. From the windows, you see messages, monitor status, view trends, and react to changes before they cause problems for end users. You can use multiple windows to monitor multiple views of the system.

NNT. NetView-NetView task.

notification message. An SA z/OS message sent to a human notification operator to provide information about significant automation actions. Notification messages are defined using the customization dialogs.

notification operator. A NetView console operator who is authorized to receive SA z/OS notification messages. Authorization is made through the customization dialogs.

NPDA. Network Problem Determination Application.

NPDA focal-point system. See *focal-point system*.

NTRI. NCP/token-ring interconnection.

nucleus initialization program (NIP). The program that initializes the resident control program; it allows the operator to request last-minute changes to certain options specified during system generation.

O

objective value. An average Workflow or Using value that SA z/OS can calculate for applications from past service data. SA z/OS uses the objective value to calculate warning and alert thresholds when none are explicitly defined.

OCA. In SA z/OS, operator console A, the active operator console for a target system. Contrast with *OCB*.

OCB. In SA z/OS, operator console B, the backup operator console for a target system. Contrast with *OCA*.

OCF. Operations command facility.

OCF-based processor. A central processor complex that uses an operations command facility for interacting with human operators or external programs to perform operations management functions on the CPC.

OPC/A. Operations Planning and Control/Advanced.

OPC/ESA. Operations Planning and Control/Enterprise Systems Architecture.

operating system (OS). Software that controls the execution of programs and that may provide services such as resource allocation, scheduling, input/output

control, and data management. Although operating systems are predominantly software, partial hardware implementations are possible. (T)

operations. The real-time control of a hardware device or software function.

operations command facility (OCF). A facility of the central processor complex that accepts and processes operations management commands.

Operations Planning and Control/Advanced (OPC/A). A set of IBM licensed programs that automate, plan, and control batch workload. OPC/A analyzes system and workload status and submits jobs accordingly.

Operations Planning and Control/ESA (OPC/ESA). A set of IBM licensed programs that automate, plan, and control batch workload. OPC/ESA analyzes system and workload status and submits jobs accordingly. The successor to OPC/A.

operator. (1) A person who keeps a system running. (2) A person or program responsible for managing activities controlled by a given piece of software such as z/OS, the NetView program, or IMS. (3) A person who operates a device. (4) In a language statement, the lexical entity that indicates the action to be performed on operands.

operator console. (1) A functional unit containing devices that are used for communications between a computer operator and a computer. (T) (2) A display console used for communication between the operator and the system, used primarily to specify information concerning application programs and I/O operations and to monitor system operation. (3) In SA z/OS, a console that displays output from and sends input to the operating system (z/OS, LINUX, VM, VSE). Also called *operating system console*. In the SA z/OS operator commands and configuration dialogs, OC is used to designate a target system operator console.

operator station task (OST). The NetView task that establishes and maintains the online session with the network operator. There is one operator station task for each network operator who logs on to the NetView program.

operator view. A set of group, system, and resource definitions that are associated together for monitoring purposes. An operator view appears as a graphic display in the graphic interface showing the status of the defined groups, systems, and resources.

OperatorView entry. A construct, created with the customization dialogs, used to represent and contain policy for an operator view.

OS. Operating system.

z/OS component. A part of z/OS that performs a specific z/OS function. In SA z/OS, component refers to entities that are managed by SA z/OS automation.

z/OS subsystem. Software products that augment the z/OS operating system. JES and TSO/E are examples of z/OS subsystems. SA z/OS includes automation for some z/OS subsystems.

z/OS system. A z/OS image together with its associated hardware, which collectively are often referred to simply as a system, or z/OS system.

OSA. I/O operations can display the open system adapter (OSA) channel logical definition, physical attachment, and status. You can configure an OSA channel on or off.

OST. Operator station task.

outbound. In SA z/OS, messages or commands from the focal-point system to the target system.

outbound gateway operator. The automation operator that establishes connections to other systems. The outbound gateway operator handles communications with other systems through a gateway session. The automation operator sends messages, commands, and responses to the inbound gateway operator at the receiving system.

P

page. (1) The portion of a panel that is shown on a display surface at one time. (2) To transfer instructions, data, or both between real storage and external page or auxiliary storage.

panel. (1) A formatted display of information that appears on a terminal screen. Panels are full-screen 3270-type displays with a monospaced font, limited color and graphics. (2) By using SA z/OS panels you can see status, type commands on a command line using a keyboard, configure your system, and passthru to other consoles. See also *help panel*. (3) In computer graphics, a display image that defines the locations and characteristics of display fields on a display surface. Contrast with *screen*.

parallel channels. Parallel channels operate in either byte (BY) or block (BL) mode. You can change connectivity to a parallel channel operating in block mode.

parameter. (1) A variable that is given a constant value for a specified application and that may denote the application. (2) An item in a menu for which the user specifies a value or for which the system provides a value when the menu is interpreted. (3) Data passed to a program or procedure by a user or another program, namely as an operand in a language statement, as an item in a menu, or as a shared data structure.

partition. (1) A fixed-size division of storage. (2) In VSE, a division of the virtual address area that is available for program processing. (3) On an IBM Personal Computer fixed disk, one of four possible storage areas of variable size; one can be accessed by DOS, and each of the others may be assigned to another operating system.

partitionable CPC. A CPC that can be divided into 2 independent CPCs. See also *physical partition*, *single-image mode*, *MP*, *side*.

partitioned data set (PDS). A data set in direct access storage that is divided into partitions, called *members*, each of which can contain a program, part of a program, or data.

passive monitoring. In SA z/OS, the receiving of unsolicited messages from z/OS systems and their resources. These messages can prompt updates to resource status displays. See also *active monitoring*.

PCE. Processor controller. Also known as the “support processor” or “service processor” in some processor families.

PDB. Policy Database

PDS. Partitioned data set.

physical partition. Part of a CPC that operates as a CPC in its own right, with its own copy of the operating system.

physical unit (PU). In SNA, the component that manages and monitors the resources (such as attached links and adjacent link stations) of a node, as requested by a system services control point (SSCP) through an SSCP-PU session. An SSCP activates a session with the physical unit to indirectly manage, through the PU, resources of the node such as attached links.

physically partitioned (PP) configuration. A mode of operation that allows a multiprocessor (MP) system to function as two or more independent CPCs having separate power, water, and maintenance boundaries. Contrast with *single-image (SI) configuration*.

POI. Program operator interface.

policy. The automation and monitoring specifications for an SA z/OS enterprise. See *System Automation for z/OS Defining Automation Policy*.

policy database. The database where the automation policy is recorded. Also known as the PDB.

POR. Power-on reset.

port. (1) System hardware to which the I/O devices are attached. (2) On an ESCON switch, a port is an addressable connection. The switch routes data through the ports to the channel or control unit. Each port has a name that can be entered into a switch matrix, and you

can use commands to change the switch configuration. (3) An access point (for example, a logical unit) for data entry or exit. (4) A functional unit of a node through which data can enter or leave a data network. (5) In data communication, that part of a data processor that is dedicated to a single data channel for the purpose of receiving data from or transmitting data to one or more external, remote devices. (6) power-on reset (POR) (7) A function that re-initializes all the hardware in a CPC and loads the internal code that enables the CPC to load and run an operating system.

PP. Physically partitioned (configuration).

PPT. Primary POI task.

primary host. The base program at which you enter a command for processing.

primary POI task (PPT). The NetView subtask that processes all unsolicited messages received from the VTAM program operator interface (POI) and delivers them to the controlling operator or to the command processor. The PPT also processes the initial command specified to execute when NetView is initialized and timer request commands scheduled to execute under the PPT.

primary system. A system is a primary system for an application if the application is normally meant to be running there. SA z/OS starts the application on all the primary systems defined for it.

problem determination. The process of determining the source of a problem; for example, a program component, machine failure, telecommunication facilities, user or contractor-installed programs or equipment, environment failure such as a power loss, or user error.

processor controller. Hardware that provides support and diagnostic functions for the central processors.

processor operations. The part of SA z/OS that monitors and controls processor (hardware) operations. Processor operations provides a connection from a focal-point system to a target system. Through NetView on the focal-point system, processor operations automates operator and system consoles for monitoring and recovering target systems. Also known as ProcOps.

processor operations control file. Named by your system programmer, this file contains configuration and customization information. The programmer records the name of this control file in the processor operations file generation panel ISQDPG01.

Processor Resource/Systems Manager (PR/SM). The feature that allows the processor to use several operating system images simultaneously and provides logical partitioning capability. See also *LPAR*.

ProcOps. Processor operations.

ProcOps Service Machine (PSM). The PSM is a CMS user on a VM host system. It runs a CMS multitasking application that serves as "virtual hardware" for ProcOps. ProcOps communicates via the PSM with the VM guest systems that are defined as target systems within ProcOps.

product automation. Automation integrated into the base of SA z/OS for the products DB2, CICS, IMS, OPC (formerly called *features*).

program to program interface (PPI). A NetView function that allows user programs to send or receive data buffers from other user programs and to send alerts to the NetView hardware monitor from system and application programs.

protocol. In SNA, the meanings of, and the sequencing rules for, requests and responses used for managing the network, transferring data, and synchronizing the states of network components.

proxy resource. A resource defined like an entry type APL representing a processor operations target system.

PR/SM. Processor Resource/Systems Manager.

PSM. ProcOps Service Machine.

PU. Physical unit.

R

remote system. A system that receives resource status information from an SA z/OS focal-point system. An SA z/OS remote system is defined as part of the same SA z/OS enterprise as the SA z/OS focal-point system to which it is related.

requester. A requester is a workstation software, which enables users to log on to a domain, that is, to the server(s) belonging to this domain, and use the resources in this domain. After the log on to a domain, users can access the shared resources and use the processing capability of the server(s). Because the bigger part of shared resources is on the server(s), users can reduce hardware investment.

resource. (1) Any facility of the computing system or operating system required by a job or task, and including main storage, input/output devices, the processing unit, data sets, and control or processing programs. (2) In NetView, any hardware or software that provides function to the network. (3) In SA z/OS, any z/OS application, z/OS component, job, device, or target system capable of being monitored or automated through SA z/OS.

Resource Access Control Facility (RACF). A program that can provide data security for all your resources. RACF protects data from accidental or deliberate unauthorized disclosure, modification, or destruction.

resource group. A physically partitionable portion of a processor. Also known as a *side*.

Resource Monitoring Facility (RMF) Monitor III. A program that measures and reports on the availability and activity of system hardware and software resources, such as processors, devices, storage, and address spaces. RMF can issue online reports about system performance problems as they occur.

Resource Object Data Manager (RODM). A data cache manager designed to support process control and automation applications. RODM provides an in-memory data cache for maintaining real-time data in an address space that is accessible by multiple applications. RODM also allows an application to query an object and receive a rapid response and act on it.

resource token. A unique internal identifier of an ESCON resource or resource number of the object in the IODF.

restart automation. SA z/OS-provided automation that monitors subsystems to ensure that they are running. If a subsystem fails, SA z/OS attempts to restart it according to the policy in the automation control file.

Restructured Extended Executor (REXX). An interpretive language used to write command lists.

return code. A code returned from a program used to influence the issuing of subsequent instructions.

REXX. Restructured Extended Executor.

REXX procedure. A command list written with the Restructured Extended Executor (REXX), which is an interpretive language.

RMF. Resource Measurement Facility.

RODM. Resource Object Data Manager.

S

SAF. Security Authorization Facility.

SA z/OS. System Automation for z/OS

SA z/OS customization dialogs. An ISPF application through which the SA z/OS policy administrator defines policy for individual z/OS systems and builds automation control data and RODM load function files.

SA z/OS customization focal point system. See *focal point system*.

SA z/OS data model. The set of objects, classes and entity relationships necessary to support the function of SA z/OS and the NetView automation platform.

SA z/OS enterprise. The group of systems and resources defined in the customization dialogs under one enterprise name. An SA z/OS enterprise consists of connected z/OS systems running SA z/OS.

SA z/OS focal point system. See *focal point system*.

SA z/OS policy. The description of the systems and resources that make up an SA z/OS enterprise, together with their monitoring and automation definitions.

SA z/OS policy administrator. The member of the operations staff who is responsible for defining SA z/OS policy.

SA z/OS satellite. If you are running two NetViews on an z/OS system to split the automation and networking functions of NetView, it is common to route alerts to the Networking NetView. For SA z/OS to process alerts properly on the Networking NetView, you must install a subset of SA z/OS code, called an *SA z/OS satellite* on the Networking NetView.

SA z/OS SDF focal point system. See *focal point system*.

SCA. In SA z/OS, system console A, the active system console for a target hardware. Contrast with *SCB*.

SCB. In SA z/OS, system console B, the backup system console for a target hardware. Contrast with *SCA*.

screen. Deprecated term for display panel.

screen handler. In SA z/OS, software that interprets all data to and from a full-screen image of a target system. The interpretation depends on the format of the data on the full-screen image. Every processor and operating system has its own format for the full-screen image. A screen handler controls one PS/2 connection to a target system.

SDF. Status Display Facility.

SDLC. Synchronous data link control.

SDSF. System Display and Search Facility.

secondary system. A system is a secondary system for an application if it is defined to automation on that system, but the application is not normally meant to be running there. Secondary systems are systems to which an application can be moved in the event that one or more of its primary systems are unavailable. SA z/OS does not start the application on its secondary systems.

server. A server is a workstation that shares resources, which include directories, printers, serial devices, and computing powers.

service language command (SLC). The line-oriented command language of processor controllers or service processors.

service processor (SVP). The name given to a processor controller on smaller System/370 processors.

service period. Service periods allow the users to schedule the availability of applications. A service period is a set of time intervals (service windows), during which an application should be active.

service threshold. An SA z/OS policy setting that determines when to notify the operator of deteriorating service for a resource. See also *alert threshold* and *warning threshold*.

session. In SNA, a logical connection between two network addressable units (NAUs) that can be activated, tailored to provide various protocols, and deactivated, as requested. Each session is uniquely identified in a transmission header by a pair of network addresses identifying the origin and destination NAUs of any transmissions exchanged during the session.

session monitor. The component of the NetView program that collects and correlates session-related data and provides online access to this information. The successor to NLDM.

shutdown automation. SA z/OS-provided automation that manages the shutdown process for subsystems by issuing shutdown commands and responding to prompts for additional information.

side. A part of a partitionable CPC that can run as a physical partition and is typically referred to as the A-side or the B-side.

Simple Network Management Protocol (SNMP). An IP based industry standard protocol to monitor and control resources in an IP network.

single image. A processor system capable of being physically partitioned that has not been physically partitioned. Single-image systems can be target hardware processors.

single-image (SI) mode. A mode of operation for a multiprocessor (MP) system that allows it to function as one CPC. By definition, a uniprocessor (UP) operates in single-image mode. Contrast with *physically partitioned (PP) configuration*.

SLC. Service language command.

SMP/E. System Modification Program Extended.

SNA. Systems Network Architecture.

SNA network. In SNA, the part of a user-application network that conforms to the formats and protocols of systems network architecture. It enables reliable

transfer of data among end users and provides protocols for controlling the resources of various network configurations. The SNA network consists of network addressable units (NAUs), boundary function components, and the path control network.

SNMP. Simple Network Management Protocol (a TCP/IP protocol). A protocol that allows network management by elements, such as gateways, routers, and hosts. This protocol provides a means of communication between network elements regarding network resources.

solicited message. An SA z/OS message that directly responds to a command. Contrast with *unsolicited message*.

SSCP. System services control point.

SSI. Subsystem interface.

start automation. SA z/OS-provided automation that manages and completes the startup process for subsystems. During this process, SA z/OS replies to prompts for additional information, ensures that the startup process completes within specified time limits, notifies the operator of problems, if necessary, and brings subsystems to an UP (or ready) state.

startup. The point in time at which a subsystem or application is started.

status. The measure of the condition or availability of the resource.

status focal-point system. See *focal—point system*.

status display facility (SDF). The system operations part of SA z/OS that displays status of resources such as applications, gateways, and write-to-operator messages (WTORs) on dynamic color-coded panels. SDF shows spool usage problems and resource data from multiple systems.

steady state automation. The routine monitoring, both for presence and performance, of subsystems, applications, volumes and systems. Steady state automation may respond to messages, performance exceptions and discrepancies between its model of the system and reality.

structure. A construct used by z/OS to map and manage storage on a coupling facility. See cache structure, list structure, and lock structure.

subgroup. A named set of systems. A subgroup is part of an SA z/OS enterprise definition and is used for monitoring purposes.

SubGroup entry. A construct, created with the customization dialogs, used to represent and contain policy for a subgroup.

subsystem. (1) A secondary or subordinate system, usually capable of operating independent of, or asynchronously with, a controlling system. (2) In SA z/OS, an z/OS application or subsystem defined to SA z/OS.

subsystem interface. The z/OS interface over which all messages sent to the z/OS console are broadcast.

support element. A hardware unit that provides communications, monitoring, and diagnostic functions to a central processor complex (CPC).

support processor. Another name given to a processor controller on smaller System/370 processors; see *service processor*.

SVP. Service processor.

switches. ESCON directors are electronic units with ports that dynamically switch to route data to I/O devices. The switches are controlled by I/O operations commands that you enter on a workstation.

switch identifier. The switch device number (swchdevn), the logical switch number (LSN) and the switch name

symbolic destination name (SDN). Used locally at the workstation to relate to the VTAM application name.

synchronous data link control (SDLC). A discipline for managing synchronous, code-transparent, serial-by-bit information transfer over a link connection. Transmission exchanges may be duplex or half-duplex over switched or nonswitched links. The configuration of the link connection may be point-to-point, multipoint, or loop. SDLC conforms to subsets of the Advanced Data Communication Control Procedures (ADCCP) of the American National Standards Institute and High-Level Data Link Control (HDLC) of the International Standards Organization.

SYSINFO Report. An RMF report that presents an overview of the system, its workload, and the total number of jobs using resources or delayed for resources.

SysOps. System operations.

sysplex. A set of z/OS systems communicating and cooperating with each other through certain multisystem hardware components (coupling devices and timers) and software services (couple data sets).

In a sysplex, z/OS provides the coupling services that handle the messages, data, and status for the parts of a multisystem application that has its workload spread across two or more of the connected processors, sysplex timers, coupling facilities, and couple data sets (which contains policy and states for automation).

A parallel sysplex is a sysplex that includes a coupling facility.

sysplex application group. A sysplex application group is a grouping of applications that can run on any system in a sysplex.

sysplex couple data set. A couple data set that contains sysplex-wide data about systems, groups, and members that use XCF services. All z/OS systems in a sysplex must have connectivity to the sysplex couple data set. See also *couple data set*.

Sysplex Timer. An IBM unit that synchronizes the time-of-day (TOD) clocks in multiple processors or processor sides. External Time Reference (ETR) is the z/OS generic name for the IBM Sysplex Timer (9037).

system. In SA z/OS, system means a focal point system (z/OS) or a target system (MVS, VM, VSE, LINUX, or CF).

System Automation for z/OS. The full name for SA z/OS.

System Automation for OS/390. The full name for SA OS/390, the predecessor to System Automation for z/OS.

system console. (1) A console, usually having a keyboard and a display screen, that is used by an operator to control and communicate with a system. (2) A logical device used for the operation and control of hardware functions (for example, IPL, alter/display, and reconfiguration). The system console can be assigned to any of the physical displays attached to a processor controller or support processor. (3) In SA z/OS, the hardware system console for processor controllers or service processors of processors connected using SA z/OS. In the SA z/OS operator commands and configuration dialogs, SC is used to designate the system console for a target hardware processor.

System Display and Search Facility (SDSF). An IBM licensed program that provides information about jobs, queues, and printers running under JES2 on a series of panels. Under SA z/OS you can select SDSF from a pull-down menu to see the resources' status, view the z/OS system log, see WTOR messages, and see active jobs on the system.

System entry. A construct, created with the customization dialogs, used to represent and contain policy for a system.

System Modification Program/Extended (SMP/E). An IBM licensed program that facilitates the process of installing and servicing an z/OS system.

system operations. The part of SA z/OS that monitors and controls system operations applications and subsystems such as NetView, SDSF, JES, RMF, TSO, RODM, ACF/VTAM, CICS, IMS, and OPC. Also known as SysOps.

system services control point (SSCP). In SNA, the focal point within an SNA network for managing the configuration, coordinating network operator and problem determination requests, and providing directory support and other session services for end users of the network. Multiple SSCPs, cooperating as peers, can divide the network into domains of control, with each SSCP having a hierarchical control relationship to the physical units and logical units within its domain.

Systems Network Architecture (SNA). The description of the logical structure, formats, protocols, and operational sequences for transmitting information units through, and controlling the configuration and operation of, networks.

System/390 microprocessor cluster. A configuration that consists of central processor complexes (CPCs) and may have one or more integrated coupling facilities.

T

TAF. Terminal access facility.

target. A processor or system monitored and controlled by a focal-point system.

target control task. In SA z/OS, target control tasks process commands and send data to target systems and workstations through communications tasks. A target control task (a NetView autotask) is assigned to a target system when the target system is initialized.

target hardware. In SA z/OS, the physical hardware on which a target system runs. It can be a single-image or physically partitioned processor. Contrast with *target system*.

target system. (1) In a distributed system environment, a system that is monitored and controlled by the focal-point system. Multiple target systems can be controlled by a single focal-point system. (2) In SA z/OS, a computer system attached to the focal-point system for monitoring and control. The definition of a target system includes how remote sessions are established, what hardware is used, and what operating system is used.

task. (1) A basic unit of work to be accomplished by a computer. (2) In the NetView environment, an operator station task (logged-on operator), automation operator (autotask), application task, or user task. A NetView task performs work in the NetView environment. All SA z/OS tasks are NetView tasks. See also *communications task*, *message monitor task*, and *target control task*.

telecommunication line. Any physical medium, such as a wire or microwave beam, that is used to transmit data.

terminal access facility (TAF). (1) A NetView function that allows you to log onto multiple applications either on your system or other systems. You can define TAF sessions in the SA z/OS customization panels so you don't have to set them up each time you want to use them. (2) In NetView, a facility that allows a network operator to control a number of subsystems. In a full-screen or operator control session, operators can control any combination of subsystems simultaneously.

terminal emulation. The capability of a microcomputer or personal computer to operate as if it were a particular type of terminal linked to a processing unit to access data.

threshold. A value that determines the point at which SA z/OS automation performs a predefined action. See *alert threshold*, *warning threshold*, and *error threshold*.

time of day (TOD). Typically refers to the time-of-day clock.

Time Sharing Option (TSO). An optional configuration of the operating system that provides conversational time sharing from remote stations. It is an interactive service on z/OS, MVS/ESA, and MVS/XA.

Time-Sharing Option/Extended (TSO/E). An option of z/OS that provides conversational timesharing from remote terminals. TSO/E allows a wide variety of users to perform many different kinds of tasks. It can handle short-running applications that use fewer sources as well as long-running applications that require large amounts of resources.

timers. A NetView command that issues a command or command processor (list of commands) at a specified time or time interval.

TOD. Time of day.

token ring. A network with a ring topology that passes tokens from one attaching device to another; for example, the IBM Token-Ring Network product.

TP. Transaction program.

transaction program. In the VTAM program, a program that performs services related to the processing of a transaction. One or more transaction programs may operate within a VTAM application program that is using the VTAM application program interface (API). In that situation, the transaction program would request services from the applications program using protocols defined by that application program. The application program, in turn, could request services from the VTAM program by issuing the APPCCMD macro instruction.

transitional automation. The actions involved in starting and stopping subsystems and applications that

have been defined to SA z/OS. This can include issuing commands and responding to messages.

translating host. Role played by a host that turns a resource number into a token during a unification process.

trigger. Triggers, in combination with events and service periods, are used to control the starting and stopping of applications in a single system or a parallel sysplex.

TSO. Time Sharing Option.

TSO console. From this 3270-type console you are logged onto TSO or ISPF to use the runtime panels for I/O operations and SA z/OS customization panels.

TSO/E. TSO Extensions.

U

UCB. The unit control block; an MVS/ESA data area that represents a device and that is used for allocating devices and controlling I/O operations.

unsolicited message. An SA z/OS message that is not a direct response to a command. Contrast with *solicited message*.

user task. An application of the NetView program defined in a NetView TASK definition statement.

Using. An RMF Monitor III definition. Jobs getting service from hardware resources (processors or devices) are **using** these resources. The use of a resource by an address space can vary from 0% to 100% where 0% indicates no use during a Range period, and 100% indicates that the address space was found using the resource in every sample during that period. See also *Workflow*.

V

view. In the NetView Graphic Monitor Facility, a graphical picture of a network or part of a network. A view consists of nodes connected by links and may also include text and background lines. A view can be displayed, edited, and monitored for status information about network resources.

Virtual Storage Extended (VSE). An IBM licensed program whose full name is Virtual Storage Extended/Advanced Function. It is an operating system that controls the execution of programs.

Virtual Telecommunications Access Method (VTAM). An IBM licensed program that controls communication and the flow of data in an SNA network. It provides single-domain, multiple-domain, and interconnected network capability. Its full name is Advanced

Communications Function for the Virtual Telecommunications Access Method. Synonymous with *ACF/VTAM*.

VM/ESA. Virtual Machine/Enterprise Systems Architecture.

VM Second Level Systems Support. With this function, Processor Operations is able to control VM second level systems (VM guest systems) in the same way that it controls systems running on real hardware.

volume. A direct access storage device (DASD) volume or a tape volume that serves a system in an SA z/OS enterprise.

volume entry. A construct, created with the customization dialogs, used to represent and contain policy for a volume.

volume group. A named set of volumes. A volume group is part of a system definition and is used for monitoring purposes.

volume group entry. A construct, created with the customization dialogs, used to represent and contain policy for a volume group.

Volume Workflow. The SA z/OS Volume Workflow variable is derived from the RMF Resource Workflow definition, and is used to measure the performance of volumes. SA z/OS calculates Volume Workflow using:

$$\text{Volume Workflow \%} = \frac{\text{accumulated Using}}{\text{accumulated Using} + \text{accumulated Delay}} * 100$$

The definition of **Using** is the percentage of time when a job has had a request accepted by a channel for the volume, but the request is not yet complete.

The definition of **Delay** is the delay that waiting jobs experience because of contention for the volume. See also *Address Space Workflow*.

VSE. Virtual Storage Extended.

VTAM. Virtual Telecommunications Access Method.

W

warning threshold. An application or volume service value that determines the level at which SA z/OS changes the associated icon in the graphic interface to the warning color. See *alert threshold*.

workflow. See *Address Space Workflow* and *Volume Workflow*.

workstation. In SA z/OS workstation means the *graphic workstation* that an operator uses for day-to-day operations.

write-to-operator (WTO). A request to send a message to an operator at the z/OS operator console. This request is made by an application and is handled by the WTO processor, which is part of the z/OS supervisor program.

write-to-operator-with-reply (WTOR). A request to send a message to an operator at the z/OS operator console that requires a response from the operator. This request is made by an application and is handled by the WTO processor, which is part of the z/OS supervisor program.

WTO. Write-to-Operator.

WTOR. Write-to-Operator-with-Reply.

WWV. The US National Institute of Standards and Technology (NIST) radio station that provides standard time information. A second station, known as WWVB, provides standard time information at a different frequency.

X

XCF. Cross-system coupling facility.

XCF couple data set. The name for the sysplex couple data set prior to MVS/ESA System Product Version 5 Release 1. See also *sysplex couple data set*.

XCF group. A set of related members that a multisystem application defines to XCF. A member is a specific function, or instance, of the application. A member resides on one system and can communicate with other members of the same group across the sysplex.

XRF. Extended recovery facility.

Numerics

390-CMOS. Processor family group designator used in the SA z/OS processor operations documentation and in the online help to identify any of the following S/390 CMOS processor machine types: 9672, 9674, 2003, 3000, or 7060. SA z/OS processor operations uses the OCF facility of these processors to perform operations management functions. See *OCF-based processor*.

Index

Special characters

&COMPAPPL; variable 243
&DCOMP variable 243
&QCOMP variable 243
&RESAPPL variable 243

Numerics

256-character allow or prohibit
string 219, 221

A

ACF file manager command 7
ACFCMD common routine 12
ACFFQRY file manager command 21
ACFREP common routine 26
active message handler 101
ACTIVMSG generic routine 101
additional parameters
for system operations commands 133
address space management
INGRCLUP command 88
allow or prohibit attributes 221
defining 219, 224
AOCFLT generic routine 107
AOCGETCN common routine 34
AOCMSG common routine 35
AOCQRES common routine 40
AOCQRY common routine 41
AOCQRY TGLOBALs 46
AOCUPDT common routine 55
AOFADMON common routine 95
AOFAJMON common routine
See INGPJMON common routine 98
AOFAPMON common routine 96
AOFATMON common routine 96
AOFPCMSG generic routine 104
AOFPCPSM common routine 97
AOFEXCMD common routine 59
AOFPCCHILD.0 TGLOBAL 62
AOFPCCHILD.n TGLOBAL 63
AOFSHUTMOD global variable 92
AOFRTREE 253
AOFRTREE common routine 60
AOFUXMON common routine 97
API
assembler language CALLS 236
description 151
with REXX 231
ASF file manager command 64
ASFUSER file manager command 68
ASSIST TGLOBAL 50
automation control file
issuing commands from 12
automation control file WARM start 8
automation manager commands
INGPOST 80
INGRTCMD 89
AUTOTYPE TGLOBAL 50

C

cascaded switch
FICON 153
CDEMATCH common routine 71
CHKSUBS common routine 77
CHKTHRES common routine 77
CMDCNTHI TGLOBAL 15
code matching 71
commands
ACF 7
ACFCMD 12
ACFFQRY 21
ACFREP 26
AOCGETCN 34
AOCMSG 35
AOCQRES 40
AOCQRY 41
AOCUPDT 55
AOFADMON 95
AOFAPMON 96
AOFATMON 96
AOFPCMSG 104
AOFPCPSM 97
AOFEXCMD 59
AOFRTREE 60
AOFUXMON 97
ASF 64
ASFUSER 68
CDEMATCH 71
CHKSUBS 77
CHKTHRES 77
DELETE FILE 167
INGPJMON 98
INGPOST 80
INGPW 84
INGRCLUP 88
INGRTCMD 89
INGSTOBS 139
INGTIMER 141
INGUSS 89
INGVARS 143
INGVTAM 145
ISQMTSYS 100
MDFYSHUT 92
QUERY ENTITY CHP 168
QUERY ENTITY CNTLUNIT 173
QUERY ENTITY DEV 176
QUERY ENTITY HOST 179
QUERY ENTITY SWITCH 183
QUERY FILE 186
QUERY INTERFACE
CNTLUNIT 187
QUERY INTERFACE SWITCH 193
QUERY RELATION CHP 201
QUERY RELATION CNTLUNIT 202
QUERY RELATION DEV 202
QUERY RELATION HOST 203
QUERY RELATION SWITCH 204
QUERY SWITCH 205
REMOVE CHP 208
REMOVE DEV 211

commands (*continued*)

RESTORE CHP 208
RESTORE DEV 211
WRITEFILE 217
WRITEPORT 219
WRITESWCH 224
common routines
ACF 7
ACFCMD 12
ACFFQRY 21
ACFREP 26
AOCGETCN 34
AOCMSG 35
AOCQRES 40
AOCQRY 41
AOCUPDT 55
AOFADMON 95
AOFAPMON 96
AOFATMON 96
AOFPCPSM 97
AOFEXCMD 59
AOFRTREE 60
AOFUXMON 97
ASF 64
ASFUSER 68
CDEMATCH 71
CHKSUBS 77
CHKTHRES 77
INGPJMON 98
INGPOST 80
INGPW 84
INGSTOBS 139
ISQMTSYS 100
MDFYSHUT 92
communication mask 219, 221
connectivity
defining 219
connectivity, defining 221

D

DCOLOR parameter 241
default status descriptor color 241
define
color for SDF 244
I/O errors for SDF 251
maximum number of SDF
operators 246
SDF color/priority range 250
SDF color/priority relationship 248
SDF initial panel 246
SDF PF keys 242, 243, 244, 247
SDF screen buffer size 251
status colors 245
DELETE FILE command 167
descriptor codes 36
documents, licensed xiv
DPFKDESC1 parameter 243
DPFKDESC2 parameter 244
DPFKnn parameter 242

E

EHKACTION TGLOBAL 72
EHKCMD TGLOBAL 15
EHKEXITNME TGLOBAL 50
EHKEXITRSN TGLOBAL 50
EHKRPY TGLOBAL 27, 30
EHKRPYHI TGLOBAL 30
EHKVARn TGLOBALs 15, 30
EMPTYCOLOR parameter 244
ENDPANEL statement 264
ERRCOLOR 245

F

FICON cascaded switches 153
FICON switches 153
file manager commands
 ACF 7
 ACFFQRY 21
 ASF 64
 ASFUSER 68
 INGPW 84
filtering messages 107
FWDMSG generic routine 109

G

generic routine
 INGTIMER 141
 INGVARS 143
generic routines
 ACTIVMSG 101
 AOCFLT 107
 AOFCPMSG 104
 description 101
 FWDMSG 109
 HALTMSG 110
 INGDATA 137
 INGMON 138
 ISSUECMD 113
 ISSUEREP 117
 OUTREP 123
 TERMMMSG 126

H

HALTMSG generic routine 110

I

I/O operations
 programming commands 151
I/O operations commands
 DELETE FILE 167
 QUERY ENTITY CHP 168
 QUERY ENTITY CNTLUNIT 173
 QUERY ENTITY DEV 176
 QUERY ENTITY HOST 179
 QUERY ENTITY SWITCH 183
 QUERY FILE 186
 QUERY INTERFACE
 CNTLUNIT 187
 QUERY INTERFACE SWITCH 193
 QUERY RELATION CHP 201
 QUERY RELATION CNTLUNIT 202

I/O operations commands (*continued*)

 QUERY RELATION DEV 202
 QUERY RELATION HOST 203
 QUERY RELATION SWITCH 204
 QUERY SWITCH 205
 REMOVE CHP 208
 REMOVE DEV 211
 RESTORE CHP 208
 RESTORE DEV 211
 WRITEFILE 217
 WRITEPORT 219
 WRITESWCH 224
INGDATA generic routine 137
INGMON generic routine 138
INGPJMON common routine 98
INGPOST common routine 80
INGPW command 84
INGRCLUP command 88
INGRTCMD command 89
INGSTOBS common routine 139
INGTIMER command 141
INGUSS command 89
INGVARS command 143
 line-mode output 145
INGVTAM command 145
initialization parameters
 DCOLOR 241
 DPFKDESC1 243
 DPFKDESC2 244
 DPFKnn 242
 EMPTYCOLOR 244
 ERRCOLOR 245
 INITSCRN 246
 MAXOPS 246
 PFKnn 247
 PRIORITY 248
 PRITBLSZ 250
 PROPDOWN 250
 PROPUP 251
 SCREENSZ 251
 TEMPERR 251
INITSCRN parameter 246
ISQMTSYS common routine 100
ISSUECMD generic routine 113
ISSUEREP generic routine 117

L

languages supported by the API
 Assembler language 236
 REXX 231
 MVS REXX example 232
licensed documents xiv
load
 QUERY FILE command 186
load SDF tree structure 273
LookAt message retrieval tool xiv

M

mask 219, 221
MAXOPS parameter 246
MDFYSHUT common routine 92
message forwarding and
 notification 109
message generation and notification 35

message retrieval tool, LookAt xiv
minor resources 42, 46
modifying the current shutdown 92
monitoring routine
 INGSTOBS 139
 ISQMTSYS 100
MVS descriptor codes 36
MVS REXX example 232

N

NetView
 DSIPARM member 253

O

operating environment requirements 151
OUTDSN parameter 137
OUTMODE parameter 136
OUTREP generic routine 123

P

PANEL statement 255
panels
 AOCQRY 54
 Code Processing 73, 76, 124, 125
 Command Dialogs 135, 136
 DISPACF 52, 116, 130
 DISPFLGS 51, 54
 DISPINFO 107
 Flag Automation Specification 122
 Message Processing 16, 18, 20, 31, 33,
 73, 75, 121
 Policy Selection 121
 Reply Processing 122
 Thresholds Definition 79
parameter list
 for I/O operations API 233
parameters
 additional, for system operations
 commands
 OUTDSN 137
 OUTMODE 136
 TARGET 133
password protection feature 84
PF key
 defining for SDF 247
PFKnn parameter 247
PIB, see port information block 205
port information block (PIB) 205
PRIORITY parameter 248
PRITBLSZ parameter 250
PROPDOWN parameter 250
PROPUP parameter 251

Q

QUERY ENTITY CHP command 168
QUERY ENTITY CNTLUNIT
 command 173
QUERY ENTITY DEV command 176
QUERY ENTITY HOST command 179
QUERY ENTITY SWITCH
 command 183

QUERY FILE command 186
 QUERY INTERFACE CNTLUNIT
 command 187
 QUERY INTERFACE SWITCH
 command 193
 QUERY RELATION CHP command 201
 QUERY RELATION CNTLUNIT
 command 202
 QUERY RELATION DEV command 202
 QUERY RELATION HOST
 command 203
 QUERY RELATION SWITCH
 command 204
 QUERY SWITCH command 205

R

REMOVE CHP command 208
 REMOVE DEV command
 RESTORE DEV command 211
 resources
 minor 46
 RESTORE CHP command 208
 REXX coding instructions 231
 REXX EXEC
 MVS example 232

S

SAF environment policy definition 86
 sample SDF, definition 265
 save switch configuration
 WRITEFILE command 217
 saved switch configuration
 load file at IPL 186
 scheduling a command 59
 SCREEN command 275
 SCREENSZ parameter 251
 SDF
 automation control file entry 241
 initialization parameters 241
 sample definition 265
 tree structure hierarchy 253
 SDF definition statements
 AOFRTREE 253
 ENDPANEL 264
 PANEL 255
 PFKnn 263
 SCREEN 275
 SDFPANEL 274
 SDFRTREE 273
 STATUSFIELD 257
 STATUSTEXT 260
 TEXTFIELD 261
 TEXTTEXT 262
 status descriptor color 241
 status tree 250, 251
 STATUSFIELD statement 257
 STATUSTEXT statement 260
 store
 WRITEFILE command 217
 structure definitions
 AOFRTREE 253
 ENDPANEL 264
 PANEL 255
 PFKnn 263

structure definitions (*continued*)
 SCREEN 275
 SDFPANEL 274
 SDFRTREE 273
 STATUSFIELD 257
 STATUSTEXT 260
 TEXTFIELD 261
 TEXTTEXT 262
 SUBPAAAUTO TGLOBAL 48
 SUBPAAISTRT TGLOBAL 48
 SUBPAAARCVRY TGLOBAL 48
 SUBPAAARSTRT TGLOBAL 48
 SUBPAAASTART TGLOBAL 48
 SUBPAAATRMN8 TGLOBAL 48
 SUBPAFAUTO TGLOBAL 48
 SUBPAFISTRT TGLOBAL 48
 SUBPAFRVCVRY TGLOBAL 48
 SUBPAFRSTRT TGLOBAL 48
 SUBPAFSTART TGLOBAL 48
 SUBPAFTRMN8 TGLOBAL 48
 SUBPAPPL TGLOBAL 48
 SUBPASID TGLOBAL 48
 SUBPCMDPFX TGLOBAL 48
 SUBPDESC TGLOBAL 48
 SUBPEXTSTART TGLOBAL 48
 SUBPEXTSTOP TGLOBAL 48
 SUBPFILE TGLOBAL 48
 SUBPINFOLINK TGLOBAL 48
 SUBPIPLOPT TGLOBAL 49
 SUBPJOB TGLOBAL 49
 SUBPJOBTYPE TGLOBAL 49
 SUBPMDATE TGLOBAL 49
 SUBPMTIME TGLOBAL 49
 SUBPOPER TGLOBAL 49
 SUBPPARENT TGLOBAL 49
 SUBPPATH TGLOBAL 49
 SUBPPID TGLOBAL 49
 SUBPPORT TGLOBAL 49
 SUBPPROC TGLOBAL 49
 SUBPPROCESS 49
 SUBPRCYOPT TGLOBAL 49
 SUBPRSTOPT TGLOBAL 49
 SUBPSCHEDSS TGLOBAL 49
 SUBPSDATE TGLOBAL 49
 SUBPSESS TGLOBAL 49
 SUBPSHUTDLY TGLOBAL 49
 SUBPSHUTOPT TGLOBAL 49
 SUBPSPARM TGLOBAL 49
 SUBPSTAT TGLOBAL 49
 SUBPSTIME TGLOBAL 49
 SUBPSTOPTYE TGLOBAL 49
 SUBPSTRTDLY TGLOBAL 49
 SUBPSTRTTYPE TGLOBAL 49
 SUBPSUBTYPE TGLOBAL 49
 SUBPTERMDLY TGLOBAL 49
 SUBPTRANTY TGLOBAL 49
 SUBPTYPE TGLOBAL 49
 SUBPUSER TGLOBAL 49
 SUBPUSSJOB TGLOBAL 49
 SUBPxxxxx TGLOBALs 46
 SUBSAAAUTO TGLOBAL 47
 SUBSAAISTRT TGLOBAL 47
 SUBSAAARCVRY TGLOBAL 47
 SUBSAAARSTRT TGLOBAL 47
 SUBSAAASTART TGLOBAL 47
 SUBSAAATRMN8 TGLOBAL 47
 SUBSAFAUTO TGLOBAL 47

SUBSAFISTRT TGLOBAL 47
 SUBSAFRVCVRY TGLOBAL 47
 SUBSAFRSTRT TGLOBAL 47
 SUBSAFSTART TGLOBAL 47
 SUBSAFTRMN8 TGLOBAL 47
 SUBSAPPL TGLOBAL 47
 SUBSASID TGLOBAL 47
 SUBSCMDPFX TGLOBAL 47
 SUBSDESC TGLOBAL 47
 SUBSEXTSTART TGLOBAL 47
 SUBSEXTSTOP TGLOBAL 47
 SUBSFILE TGLOBAL 47
 SUBSINFOLINK TGLOBAL 47
 SUBSIPLOPT TGLOBAL 47
 SUBSJOB TGLOBAL 47
 SUBSJOBTYPE TGLOBAL 47
 SUBSMDATE TGLOBAL 47
 SUBSMTIME TGLOBAL 47
 SUBSOPER TGLOBAL 47
 SUBSPARENT TGLOBAL 47
 SUBSPATH TGLOBAL 47
 SUBSPID TGLOBAL 47
 SUBSPORT TGLOBAL 47
 SUBSPROC TGLOBAL 47
 SUBSPROCESS TGLOBAL 47
 SUBSRCYOPT TGLOBAL 47
 SUBSRSTOPT TGLOBAL 48
 SUBSSCHEDSS TGLOBAL 48
 SUBSSDATE TGLOBAL 48
 SUBSSESS TGLOBAL 48
 SUBSSHUTDLY TGLOBAL 48
 SUBSSHUTOPT TGLOBAL 48
 SUBSSPARM TGLOBAL 48
 SUBSSTAT TGLOBAL 48
 SUBSSTIME TGLOBAL 48
 SUBSSTOPTYE TGLOBAL 48
 SUBSSTRTDLY TGLOBAL 48
 SUBSSTRTTYPE TGLOBAL 48
 SUBSSUBTYPE TGLOBAL 48
 SUBSTERMDLY TGLOBAL 48
 SUBSTRANTY TGLOBAL 48
 SUBSTYPE TGLOBAL 48
 SUBSUSER TGLOBAL 48
 SUBSUSSJOB TGLOBAL 48
 SUBSWLMNAME TGLOBAL 48, 49
 SUBSxxxxx TGLOBALs 46
 switch
 FICON 153
 FICON cascaded 153
 syntax diagrams
 how to read 3
 system hierarchy tree 60
 system operations
 common routines for programming 7
 generic routines for
 programming 101
 monitoring routines for
 programming 95
 system operations commands
 additional parameters 133
 OUTDSN 137
 OUTMODE 136
 TARGET 133
 INGPOST 80
 INGRCLUP 88
 INGRTCMD 89
 INGUSS 89

system operations commands (*continued*)

INGVTAM 145

T

TARGET parameter 133

TEMPERR parameter 251

TERMMMSG generic routine 126

TEXTFIELD statement 261

TEXTTEXT statement 262

U

user-written programs

calling the API 151

W

WRITEFILE command 217

WRITEPORT command 219

256-character allow or prohibit

string 221

example 222

WRITESWCH command 224

Readers' Comments — We'd Like to Hear from You

System Automation for z/OS
Programmer's Reference
Version 2 Release 3

Publication No. SC33-7043-10

Overall, how satisfied are you with the information in this book?

	Very Satisfied	Satisfied	Neutral	Dissatisfied	Very Dissatisfied
Overall satisfaction	<input type="checkbox"/>	<input type="checkbox"/>	<input type="checkbox"/>	<input type="checkbox"/>	<input type="checkbox"/>

How satisfied are you that the information in this book is:

	Very Satisfied	Satisfied	Neutral	Dissatisfied	Very Dissatisfied
Accurate	<input type="checkbox"/>	<input type="checkbox"/>	<input type="checkbox"/>	<input type="checkbox"/>	<input type="checkbox"/>
Complete	<input type="checkbox"/>	<input type="checkbox"/>	<input type="checkbox"/>	<input type="checkbox"/>	<input type="checkbox"/>
Easy to find	<input type="checkbox"/>	<input type="checkbox"/>	<input type="checkbox"/>	<input type="checkbox"/>	<input type="checkbox"/>
Easy to understand	<input type="checkbox"/>	<input type="checkbox"/>	<input type="checkbox"/>	<input type="checkbox"/>	<input type="checkbox"/>
Well organized	<input type="checkbox"/>	<input type="checkbox"/>	<input type="checkbox"/>	<input type="checkbox"/>	<input type="checkbox"/>
Applicable to your tasks	<input type="checkbox"/>	<input type="checkbox"/>	<input type="checkbox"/>	<input type="checkbox"/>	<input type="checkbox"/>

Please tell us how we can improve this book:

Thank you for your responses. May we contact you? Yes No

When you send comments to IBM, you grant IBM a nonexclusive right to use or distribute your comments in any way it believes appropriate without incurring any obligation to you.

Name

Address

Company or Organization

Phone No.



Fold and Tape

Please do not staple

Fold and Tape



NO POSTAGE
NECESSARY
IF MAILED IN THE
UNITED STATES

BUSINESS REPLY MAIL

FIRST-CLASS MAIL PERMIT NO. 40 ARMONK, NEW YORK

POSTAGE WILL BE PAID BY ADDRESSEE

IBM Deutschland Entwicklung GmbH
Department 3248
Schoenaicher Strasse 220
D-71032 Boeblingen
Federal Republic of Germany

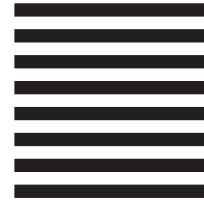

Fold and Tape

Please do not staple

Fold and Tape



Program Number: 5645-006

Printed in USA

SC33-7043-10



Spine information:



System Automation for z/OS

Programmer's Reference

Version 2 Release 3

SC33-7043-10