



IBM eServer iSeries

Selling Linux on iSeries: Power for the On Demand eBusiness

Michael Martin
Americas iSeries Brand - Linux Sales
mpmartin@us.ibm.com

Linux is NOW!

May 30, 2002: *USA Today*
Linux getting widespread support from
[Government](#)

Oct 21, 2002: *New York Times*
[Wall Street](#) Leans toward Linux

Feb 18, 2003: *Financial Times*
Linux takes on the big boys
[Alternative Operating Systems](#)

Feb 27, 2003: *New York Times*
[Sun, Again Bets Against Linux](#)

Why Linux*

1. Initial Price
2. Reliability/Availability
3. Issues with Microsoft Licensing
4. Ongoing Cost of Operations
5. Availability of Applications
6. Open Source Model
7. Linux features and functions
8. Reduce dependence on Current OS vendors



Why Linux on iSeries?

Linux on iSeries Value Proposition

- On Demand Virtualization
 - Up to 10 partitions per processor
 - On Demand Capacity
 - Virtual Storage, Ethernet, I/O
 - Independant Resource Movement
- Integration
 - Linux and OS/400 Applications
 - Server Management
 - Consolidated Storage Management
- 64-bit powerPC

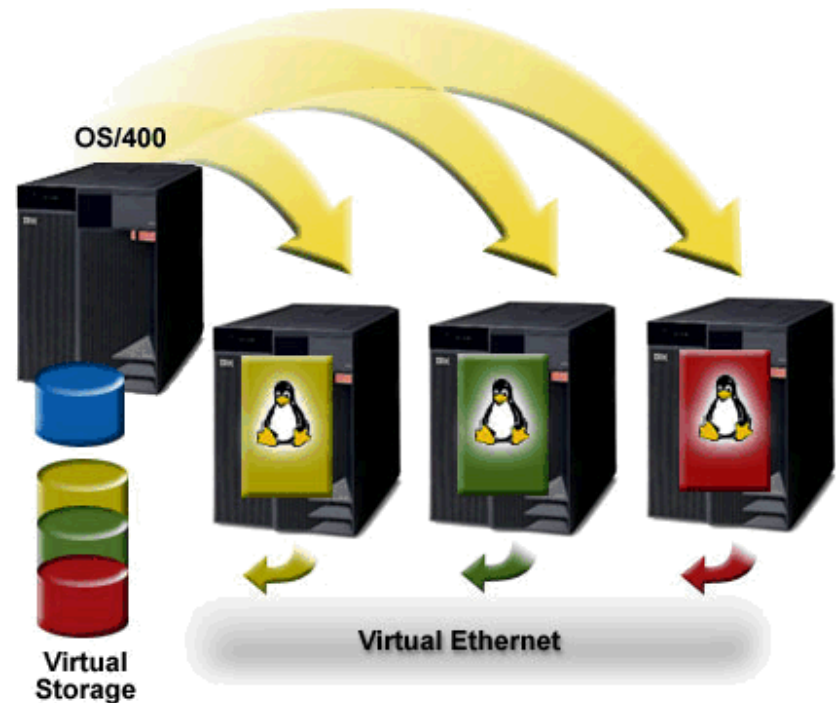

✓ *Quick consolidations*

✓ *Maximize IT investment*



✓ *Run multiple, yet independent workloads*

✓ *Extend iSeries advantages to Linux*

Why Linux and iSeries

- **What does Linux Bring to iSeries**
 - **Extends Application Portfolio**
 - **Open Source**
 - **Solution Providers on other platforms**
 - **Staffing flexibility**
 - **Abundant linux skills**

- **What does iSeries Bring to Linux**
 - **On Demand Virtualization**
 - **Integration**
 - **Reliability**
 - **Scalability**
 - **Low Cost of Ownership**



IBM eServer iSeries Wins "Best of Show"
LinuxWorld
San Francisco, CA
August 28-30, 2001

Linux Software Savings: MS vs Linux

MS Windows 2000 advanced Server (includes IIS HTTP server)	\$3,999	Comes w/ 25 Client Access License (CALs). Additional CALs are \$67 each.		SuSE ----- RedHat	priced per CPU starting @\$1,269 ----- Standard \$3,250 ** Premium \$4,250	All Linux Distributions include - file&print - DNS - FTP - Apache - POP mail - etc WITH NO CALs
Microsoft Exchange Server 2000	\$1,299	Comes w/ 5 CALs. Additional CALs are \$67 each		Bynari	Insight Server & 250 User Pack - \$6,000 Insight Server & 1500 User Pack 31,500	Fully functional alternative to Exchange!!
Microsoft Office Standard	\$479	Priced per users		Open Office	no-charge download	Linux Desktop Office solution

**RedHat has a 1Q03 promotion for \$1,050

http://www.cyber.com.au/cyber/about/linux_vs_windows_pricing_comparison.pdf

LPAR, Virtual I/O, and Shared Storage Spaces lowers TCO

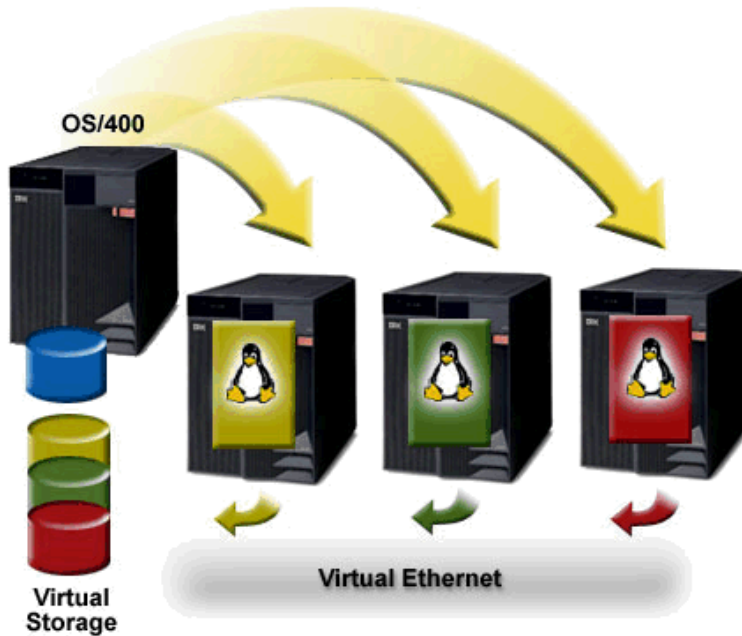
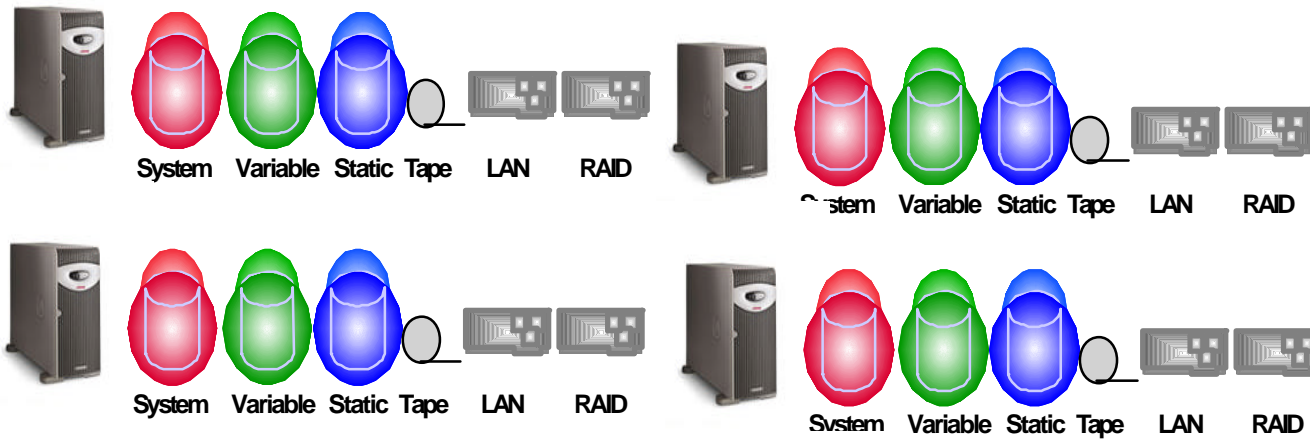

Intel Solutions

- LAN, RAID and TAPE device for each server
- memory, disk, and CPU is allocated to each server
- each server has to have its own backup and recovery solution
- Do you have a DR plan for this?

iSeriesSolutions

- Shared resources - Fewer disk drives, tape drives and LAN adapters can be used
- Reduce disk administration - iSeries Storage Mgmt
- Improve performance with more disk arms
- Consolidated Backup of OS/400, Windows, & Linux (now that's DR!!)
- Resources can easily be moved to where they are needed

Linux on iSeries Advantages

- **Run multiple Linux images on one Server**
 - Up to 31 Linux partitions
- **Dynamic Resource Movement**
 - 1/100th of a processor
 - Virtual storage spaces
 - Capacity Upgrade on Demand
- **Storage Virtualization**
 - Linux shares resources with OS/400 and other Linux partitions: disk, tape, CD, DVD
 - Simple to duplicate servers
- **Virtual Ethernet for safe/fast communications**
 - Up to 16 networks under the covers
- **Linux to OS/400 Application Integration**
 - ODBC and JDBC access to DB2/400
 - Samba and NFS for file access
- **Management Integration**
 - LPAR and Storage

# of Processors in Server	Maximum # of Linux Partitions*
1	9
2	19
4 and >	31

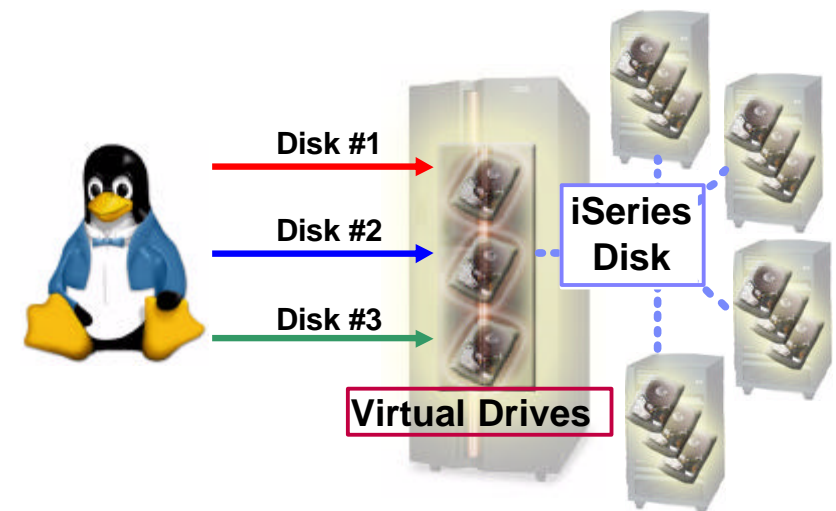

What can I sell my customer?

Linux on iSeries Solutions

Consolidation

- Replace Windows or Linux **Infrastructure** servers
 - File and Print Serving
 - DHCP
 - Firewall
 - e-mail
 - DNS
- Run multiple Linux servers in partitions
- Consolidation Lowers Cost of Computing

Integration

- Extend (Modernization) OS/400 applications with Linux **eBusiness Applications**
- Run Linux applications on same server as OS/400
- Integration Lowers Cost of Computing

Application Flexibility

- Leverage Linux **LOB application** portfolio
- Run Linux applications on iSeries
- Flexibility Lowers Cost of Computing

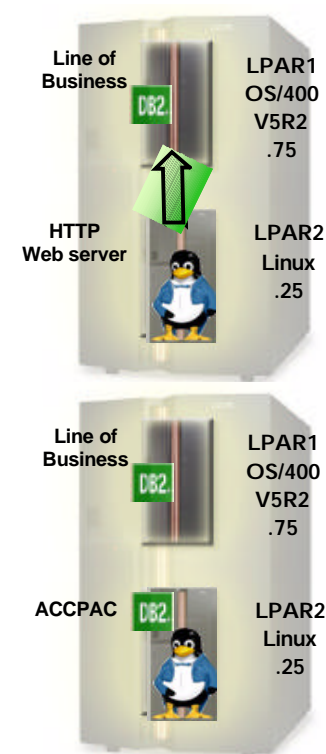

Infrastructure Solutions

Functions	Key Middleware and Applications
Web Serving	Apache
Mail Serving	POP3, IMAP, Sendmail MTA
Print Server	Samba
File Server	Samba, NFS
Proxy Server	Squid
FTP Server	w-ftpd
Firewall	NetFilter
DHCP	dhcpd
DNS	bind
Languages	C, PHP, Pearl, Java

Did You Know??

File & Print Costs (MS)

- MS Windows 2000 Advanced Server = \$3,999.00
- Comes with 25 Client Access Licenses (CALs). Additional CALs are \$67

File & Print Costs (Linux)

- SuSE = starts @ \$1,120
- RedHat = starts @ \$5,250

File and Print Server (100 users)	Quantity	Price
Hardware- Compaq ProLiant ML370 G2 • 512 MB memory • 1 - 1.4 GHz CPU • 60 GB Disk 5-10% CPU	2	\$9,195
Software • W2K Adv. Srv • (includes 25 CALs)	2	\$3,999
W2K CALs	50	\$67x50 = \$3,350
	Total	\$29,738
Hardware - iSeries 270 1way 1GB Memory 120GB disk 10-20% CPU	1	\$26,680
Software - SuSe Linux 2 Linux LPARs each with Samba File & Print Server	1	\$1,269
	Total	\$27,949

Linux Solutions -- Samba

- Replaces Windows NT file and print servers
- Replaces Domain controllers.
- Supports all Windows clients, including XP
- Included with all iSeries Linux Distributions
- Uses Microsoft's SMB and CFIS protocols
- GUI administration

Challenges

- Samba doesn't support Active Directory until Samba 3.0 (Expected 2H03)

Old National Bancorp

- **Background**
 - Largest independent banking company based in Indiana
- **Requirements**
 - Capacity for growing business
 - Consolidation of servers coming off lease
 - New Web-based Loan Application
 - Network Backup and Disaster Plan
 - Extend applications to Browsers
- **Solution**
 - iSeries Model 870
 - 5 Logical Partitions
 - WebSphere Application Server
 - Linux – Samba File andPrint
 - IBM WebFacing
- **Benefits**
 - Extend daily collection processing time by dynamically moving resources
 - Double processing power with Capacity on Demand



"Thanks to the impressive price performance of the iSeries 870 and the dynamic logical partitioning, we are able to delay our nightly processing window. This coupled with Capacity Upgrade on Demand, we are positioned to meet our future business requirements with much more assuredness."

Gary McDowell, Sr VP of
Data Processing

Architecture -- Common Infrastructure Services

- **Primary and Secondary DNS - (Domain Name Server)**
 - Translates domain names and IP addresses
 - Controls Internet email delivery
 - Most Internet services rely on DNS to work, and if DNS fails, web sites cannot be located and email delivery stalls
 - Primary DNS typically installed on a stand alone server

- **PDC and SDC (Primary and Secondary Domain Controllers)**
 - A Microsoft server that keeps track of all Microsoft users, and services that are available to an end user.
 - Single sign on gateway to Exchange, SQL, etc.
 - Larger customers will usually have many Domains
 - Replaced by Active directory, which enables consolidation of Domains

- **DHCP - (Dynamic Host Configuration Protocol)**
 - Assigns dynamic IP addresses to devices on a network.
 - Without this, no one can access the network (unless they have fixed IP)
 - Typically installed on a stand alone server

- **WINS - (Windows Internet Name Service)**
 - The Windows equivalent of DHCP. Still around in legacy implementations

Architecture -- Common Infrastructure Services

- **Web (HTTP) Server**
 - Server Engine that servers static Web content, dynamic HTML and JavaScript
 - Two most common servers are MS IIS and Apache

- **Proxy Server**
 - Proxy servers have two main functions.
 - Improve performance by Caching frequently accessed web pages.
 - Filter requests. For example, a company might use a proxy server to prevent its employees from accessing a specific set of Web sites.
 - Typically deployed on a separate server, in conjunction with a Web Server

- **FTP - (File Transfer Protocol)**
 - Protocol used to transfer data over the internet
 - Usually a separate server in the DMZ

- **Web Application Server**
 - Java application server. Delivers Servlets, EJBs and J2EE applications
 - WebSphere, BEA, iPlanet, Tomcat
 - Always a dedicated server

GHY & Co. Ltd.

Background

- International customs and trade service group
- Assist importers/exporters to buy/sell more effectively in world markets
- Corporate HQ: Winnipeg, Manitoba

Objectives

- 2 Intel Servers running Linux infrastructure applications
 - Samba, Netfilter, Squid, MySQL, Apache and Tomcat, Sendmail, VPN, DNS/DHCP, PHP
- Needed to solve reliability issues

Solution











- Alternative 1: Put each application on its own Intel server (9 in total)
- Better solution: iSeries 820 4-way with 9 LPARs supporting the Linux applications

Benefits

- Better reliability
- Better manageability

"We selected Linux on the iSeries because it was such a compelling alternative to the cost and complexity of managing nine separate Intel-based servers," Nigel Fortlage, Vice President of

iSeries 820

0	OS/400		1.00 768M
1	DOCUMENT IMAGING		0.30 256M
2	INTRANET		0.30 256M
3	FILE SERVER		0.40 256M
4	FIREWALL		0.20 256M
5	VPN		0.30 256M
6	VPN		0.30 256M
7	MAIL GATEWAY		0.40 256M
8	WEB SERVER		0.30 256M
9	TEST		0.50 256M



Firewall

➤ NetFilter

- Included in SuSE, Red Hat, and Turbolinux distributions

Firewall and iSeries

- Adding a Firewall to any iSeries solution can help bring down the TCO of delivering an eBusiness Solution
- Customers no longer have to purchase a separate non-iSeries server to have firewall protection
- Provides robust security for the corporate network and all mission critical applications
- Adds another core e-business application to the iSeries portfolio



Banco Do Brasil

Background

- Banco Do Brasil is the largest bank in South America

Objectives

- Centralize IT service and delivery
- Exploit open source software
- IT Europe had 8 branches with 250 users, 8 NT networks, and 41 NT Servers

Solution

- iSeries Model 820 Offering for Linux
- SuSE SLES 7
- 3 Integrated xSeries Servers
- 4 Integrated xSeries Adapters
- Replacing NT applications with Linux (firewall)

Benefits

- Centralized storage
- Reduced Administration and support
- More reliable IT service
- Software license savings

BANCO DO BRASIL



Sendmail

Separate Mail Server from Internet

- Sendmail Message Transfer Agent (MTA) (60% of the message routing marketshare)
 - Included in SuSE, Red Hat, and Turbolinux distributions
 - High performing reliable mail gateway
- Mail Server Solutions
 - Domino 400
 - Attach xSeries server to Linux

- DSD server can run Linux
- Extend Domino Solutions
 - Symantec Firewall
 - SMTP SendMail Gateway
 - Samba File and Print

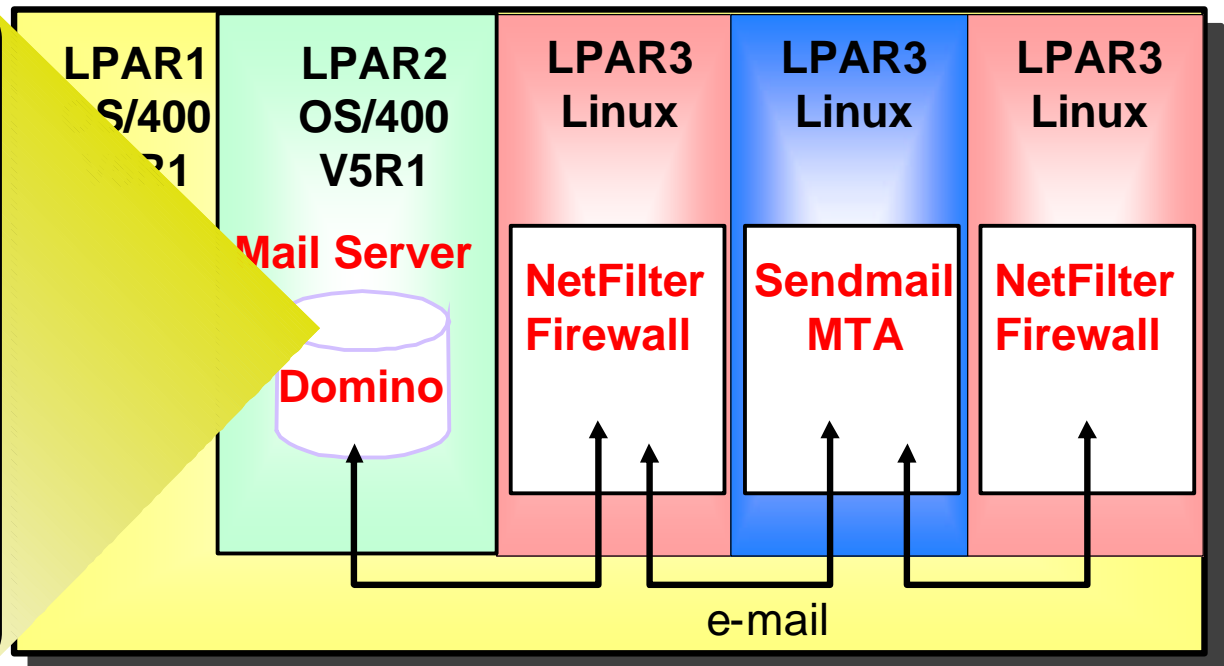

Open Office

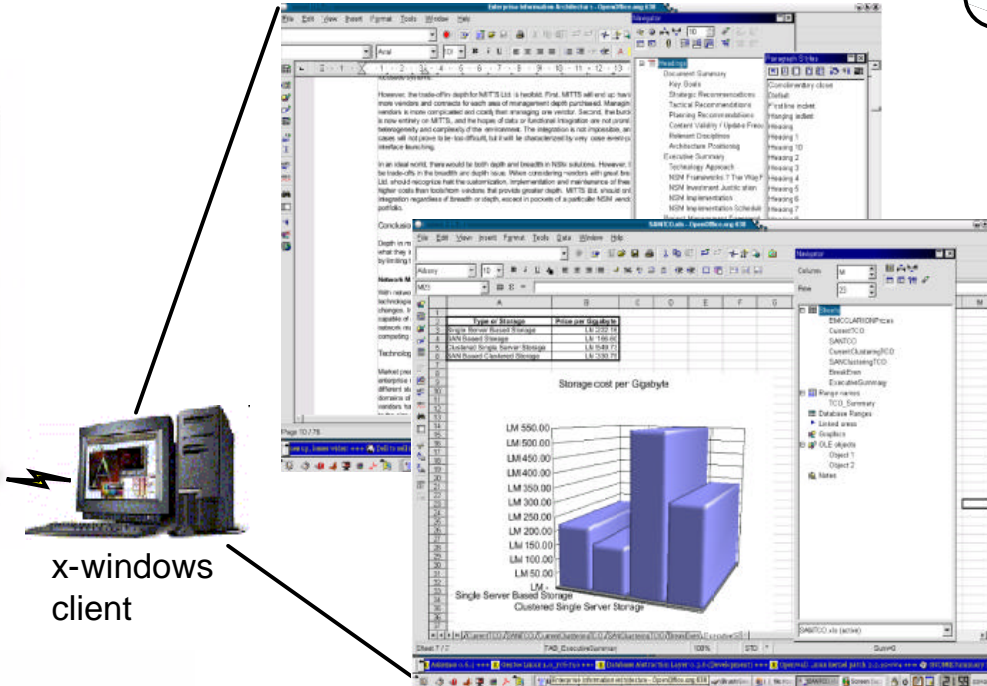
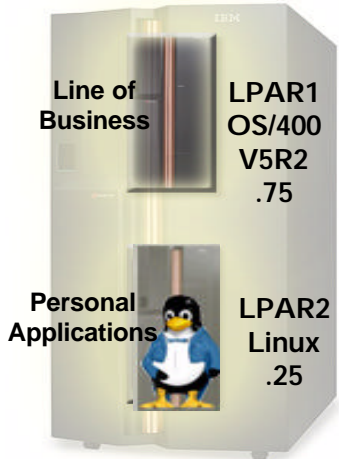

Did You Know??
MS Office 2K costs \$595 per CAL
MS Office XP costs \$635 per CAL
<http://www.microsoft.com/licensing> 12/02/02

- OpenOffice.org**
- Word processing
 - Spreadsheet, Presentation Builder
 - Reads and Creates MS Office documents (word, excel, powerpoint)
 - Runs on server, GUI sent to X-Windows client



Linux Client Investment Compared Over 5 Years VS Microsoft for 20 User System

- Linux OS and Open Office
- Linux OS and Star Office
- Windows OS and Open Office
- Windows OS and Star Office
- Windows OS and MS Office

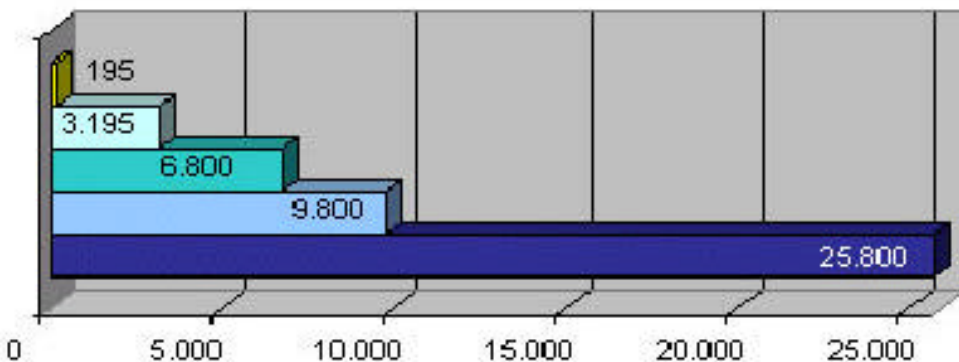

Key Solutions

Included with Distributions

- Samba - file server
- Apache - web server
- Squid - proxy server
- DNS/DHCP
- MySQL - database
- ...

Open Source

- Tomcat - web application server
- OpenOffice - office suite
- Netfilter - firewall
- ...

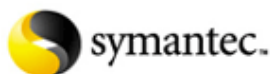

ISVs

Industry Solutions

- eOne - Commerce
- Assimilation Technologies - Transportation Scheduling
- MAPICS - ERP
- Dimensional Insight - BI
- abas - ERP
- ACCPAC
- MeritTrax - Food Industry Supply Chain

ISV Infrastructure Solutions

- Symantec - Enterprise Firewall
- Bynari - mail server
- Dimensional Insight - BI
- Vision Solutions - HA
- Lakeview Technologies - HA

More<http://www-1.ibm.com/servers/eserver/iseries/linux/apps.html>

Did You Know??

- MS Exchange License = \$1,299
- Comes with 5 MS Exchange CALs
- Additional CALs are \$67

<http://www.microsoft.com/exchange/howtobuy/pricing/default.asp>

Bynari <http://www.bynari.net/>

What is Bynari?

- Messaging and Collaboration Server
 - Directory Services, Calendaring, Collaboration
- Web Server
 - Internet Mail Server (SMTP, IMAP, POP3, MAPI)
 - Internet Mail Spec Compliant
 - Based on open standards Interoperable with all versions of Microsoft Outlook, Netscape, and other leading mail clients
- New WebBrowser Version
- Runs on all IBM eServer platforms and other manufacturers servers under Linux
- Full-function Outlook client

Cost Savings

Bynari Insight Mail Server

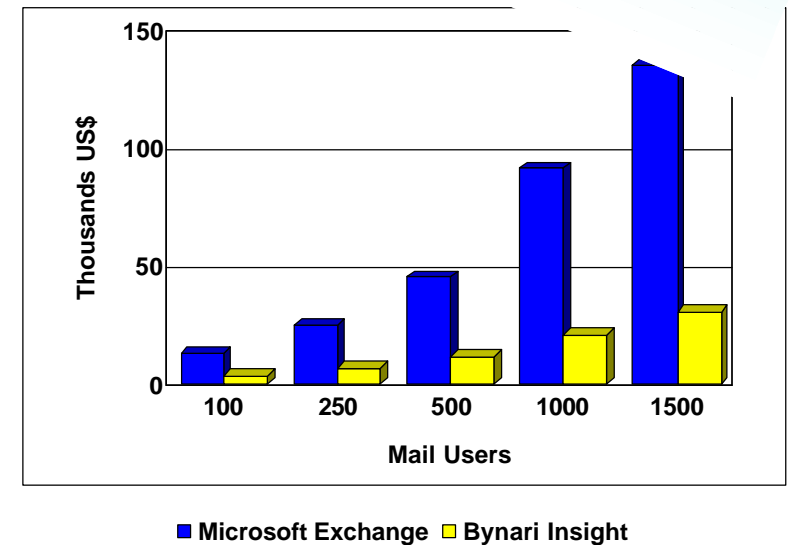

www.bynari.net

Users	Platform	MS (intel)
250 users	Linux on iSeries (.25 CPU)	
	OS	\$3,999
	e-mail Licensing	\$17,714
		\$21,713
1500 users	Linux on iSeries (.50 CPU)	
	OS	\$3,999
	e-mail Licensing	\$99,865
		\$103,864

Selling Opportunities

- **The Challenge** Customers want a lower cost and more secure / robust alternatives to MS Exchange Server while using MS Outlook clients
- **Solution A:** IBM eServer iSeries running Linux and Bynari Insight Server, Insight Connector and Insight LDAP Client
- **The Benefit:** Enables cost-effective, enterprise-level, scalable and robust messaging on existing client interfaces.

Microsoft Exchange Solution for 250 users (incl. OS Licensing + installation + Intel Server + 3 years support) = \$30,908

iSeries Solution for 250 users (incl Linux + Bynari Mail server + iSeries hardware, software + 3 years MA + S/W support) = \$28,620

- **Solutions B:** Add Linux LPAR running Bynari Insight Server, Insight Connector and Insight LDAP Client to existing iSeries LOB Application server.
- **The Benefit:** Reduces e-mail messaging costs and increase the TCO of the iSeries server by reducing hardware management and simplifying backups.
- **Cost justify 810 and 825 Upgrades by utilizing excess capacity with Linux and Bynari to replace MS Exchange Solutions on iSeries**
- **Target iSeries accounts running Microsoft Exchange with fewer than 1,000 users (typically easier sale as there are less e-mail politics and customers more interested in reducing costs.**

abas

- Linux Based ERP solution designed for SMB
- Focused solely on manufacturing and distribution
- Over 1400 current clients
 - Over 1100 clients now running Linux
 - Available on Suse and Red Hat
 - Linux clients available in Version 2002
 - Open Office Integration in Version 2003

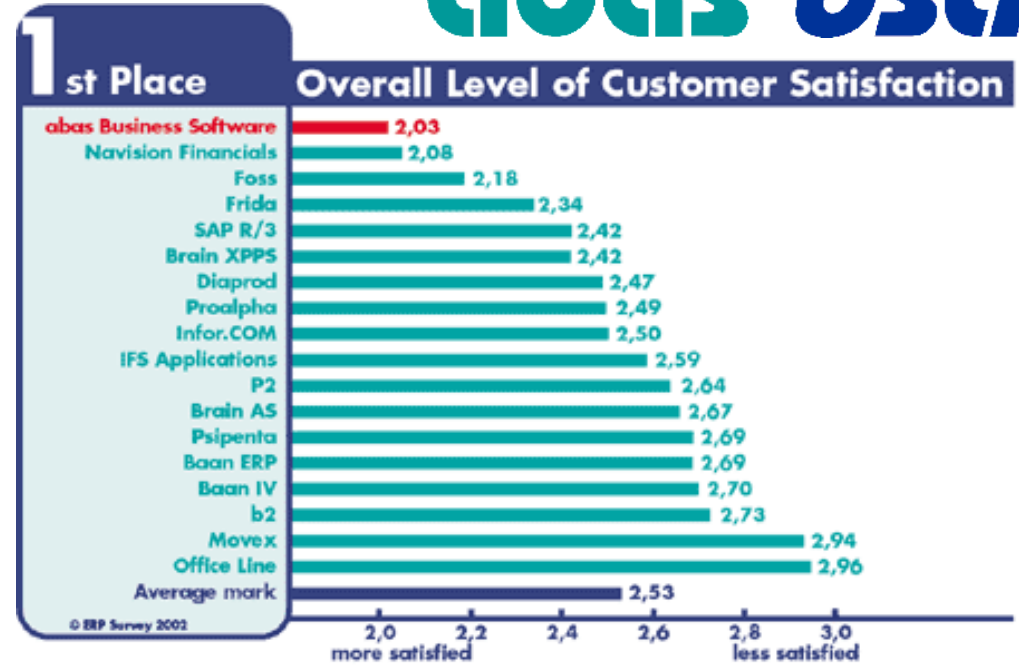

Konrad Group's ERP Study 2002

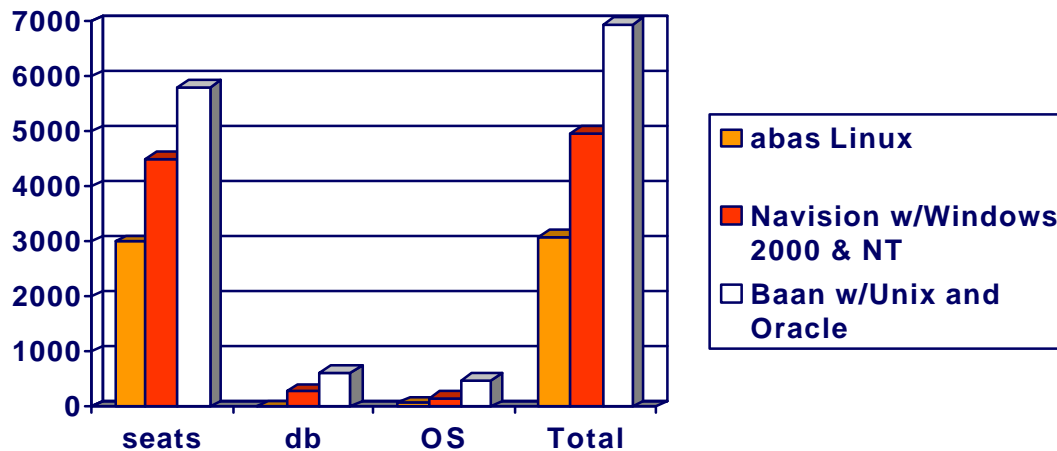

Alan Salton
Sales@abas-usa.com
www.abas-usa.com
 703-234-7855
 13800 Coppermine Rd
 Herndon, VA 20171

YKK

Background

- YKK (U.S.A.) Inc., the world's largest zipper manufacturer

Objectives

- New e-business infrastructure that will improve service for its U.S. distributors.
- Web portal that allows YKK's distributors to check inventory, securely place orders, track and review order status and history, and access a variety of links including an online product catalog.

Solution

- iSeries Model 820 Offering for Linux
- SuSE SLES 7
- eOne Commerce

Benefits

- "Our new customer service portal is a first for YKK in the U.S., so it was critical that we made the right choice for our customers," said Sara Carnell, director of operations, YKK (U.S.A.) Inc. "We explored several options before going with the e-business solution from IBM and eOne Group. IBM's Linux server running eOne Commerce gives us the scalable, flexible and secure Web site we need, and it also was very affordable."



Selling Strategy

3 Engaging Questions

- **What is your strategy to reduce your IT costs with Linux?**
- **Have you examined the cost savings available from Linux? (if not, then offer to show them!)**
- **Do you have a server consolidation strategy?**

Leverage the Linux "Buzz"

- **Business Week Linux Article**
- **Position the cost savings of Linux vs. Microsoft**
- **Identify main concerns (pains) with customers current Intel network? (Reliability, manageability, software licensing costs, security....)**

Positioning Server Consolidaiton with iSeries

- **iSeries virtual resources**
- **Cost savings of Linux & server consolidation**

Be sure to ...

Four tools you want to rely very heavily on IT Optimization

1. Open ended questions

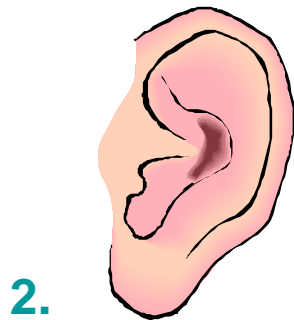

Try to use this

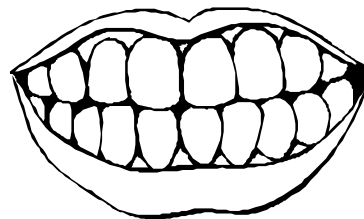

sparingly

Identifying the workloads to consolidate

- **Build an inventory of customers intel server**

- Identify different workloads
- Identify intel servers running Linux
- Identify low CPU utilization servers
- Identify server leases and age (server coming off of lease are a prime candidate)
- iSeries Consolidation Tree...

Infrastructure (file & print, dns, dhcp, firewall, sendmail gateways) = Linux
e-mail applications

Domino = consolidate natively on iSeries

Exchange = Bynari (low TCO simple mail) or migrate to Domino natively

WebSphere = migrate natively

Java Apps = migrate to Linux

Windows Apps = leverage IXS/IXA iSeries Windows Integration

intel server inventory.xls

Servers	PC Vendor	Location	Operating System	Prime Shift CPU		Hardware Configuration Information						Application Information		Lease information	
				Peak	Average	CPU Count	CPU MHz	Memory (MB)	Total Storage (GB)	Used Storage (GB)	Storage Type	Application Information	Application details	Own or Lease	Lease End Date
WebSphere	HP	New York	NT - 3.5	15%	5%	2	1000	2000	200	150	attached	Middleware	WebSphere	Own	
Exchange Mail Server	Compaq	New York	W2K	20%	5%	2	1000	2000	300	225	attached	Messaging-Exchange		Own	
WebServer	Dell	Buffalo	W2K	10%	3%	1	500	1000	100	25	attached	Infrastructure	Apache	Own	
SendMail Gateway	HP	Buffalo	Linux	10.0%	5.0%	1	550	1000	100	20	attached	Infrastructure	Send Mail	Own	
Imaging Server	HP	Buffalo	W2K	20.0%	10.0%	2	1.1GHz	2000	100	100	attached	wintel app	ing solutions	Lease	12/31/2003

LODRUN Linux on iSeries

...from zero to productivity in 3 steps



✓ Obtain LODRUN Linux

Step 1



Step 2

✓ Created LPAR
✓ Install & configure Linux server with a single command



➤ LODRUN Linux

- Packaged Linux Server Image
- Configured & Tested
- Integrated Installation Process

Step 3

✓ Start Linux and begin leveraging web and file & print serving immediately!



iSeries IDC ROI Study

"The ability of the IBM eServer iSeries platform to support multiple operating system environments on a single server made it an attractive consolidation platform for organizations that wish to lower their total costs."

- ❑ Three year ROI of 213.9% across all six sites.
- ❑ Consolidation on iSeries servers enables these organizations to continue to expand the automation of their businesses by integrating the Intel server based Windows and Linux computing environments.

Category	Data
Annual Cost Savings	\$183,716
Net present value (NPV)	\$302,052
Total investment	\$141,227
ROI = NPV/investment	213.9%
Payback = (investment/first-year cash flow)	261 days
Discount rate	12%

Source: IDC White Paper:
The Return on Investment of Windows /
Linux Infrastructure Server Consolidation
with iSeries. Case Studies in SMBs (7/03)

IDC

The cost savings delivered by deploying iSeries servers in workload-consolidation environments are dramatic, especially when compared with operating similar workloads on distributed x86 servers.

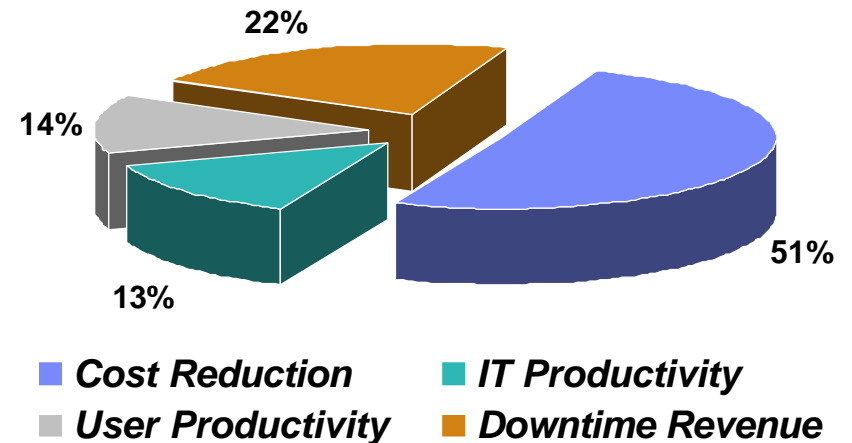









- ❑ Reduce hardware, software, maintenance, support costs by \$49,349 per 100 employees
- ❑ Users supported per FTE increased 24%
- ❑ 22% IT staffing monthly time savings (\$23,877 per 100 users savings)
- ❑ Increased IT staff “Business Support” from 39% → 47.4% with iSeries
- ❑ Loss user productivity dropped from 11.8 hours to 1.02 hours annually (91.4% increase in User Productivity)
- ❑ Lost revenue associated to downtime decreased 91% (\$528K → \$49K)

Source: IDC White Paper:
The Return on Investment of Windows / Linux
Infrastructure Server Consolidation with
iSeries. Case Studies in SMBs (7/03)

integrated Education & Services for iSeries

...helping customers take the first step

	Solution	Education	Services
WebSphere			
Linux			
Windows Integration			



■ Included with the Enterprise Package on the i825, i870 and i890

- Select one Getting Started service
 - WebSphere / **Linux** / Window Integration
- Receive IBM Learning Services education vouchers for selected courses
 - Systems Management / WebSphere / Linux / Windows Integration / Tech Conference
 - i825 – 1 voucher / i870 – 3 vouchers / i890 – 5 vouchers

Linux at No Additional Charge

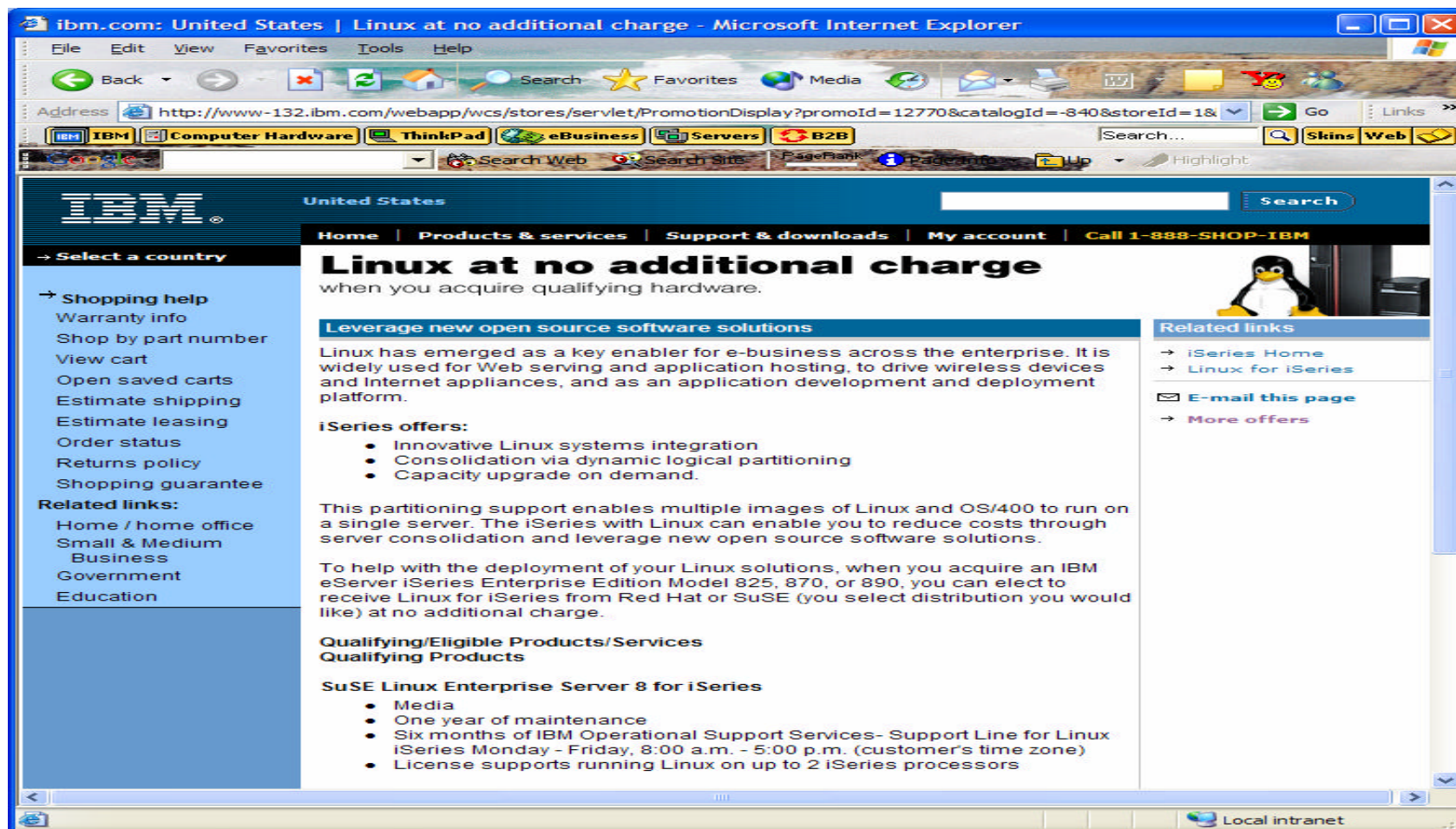

The screenshot shows a Microsoft Internet Explorer browser window displaying the IBM website. The address bar shows the URL: <http://www-132.ibm.com/webapp/wcs/stores/servlet/PromotionDisplay?promoId=12770&catalogId=-840&storeId=1&langId=-1>. The page title is "Linux at no additional charge". The main content area features the heading "Linux at no additional charge" with the subtext "when you acquire qualifying hardware." Below this, there is a section titled "Leverage new open source software solutions" which states: "Linux has emerged as a key enabler for e-business across the enterprise. It is widely used for Web serving and application hosting, to drive wireless devices and Internet appliances, and as an application development and deployment platform." The "iSeries offers:" section lists three bullet points: "Innovative Linux systems integration", "Consolidation via dynamic logical partitioning", and "Capacity upgrade on demand." A paragraph follows: "This partitioning support enables multiple images of Linux and OS/400 to run on a single server. The iSeries with Linux can enable you to reduce costs through server consolidation and leverage new open source software solutions." Another paragraph states: "To help with the deployment of your Linux solutions, when you acquire an IBM eServer iSeries Enterprise Edition Model 825, 870, or 890, you can elect to receive Linux for iSeries from Red Hat or SuSE (you select distribution you would like) at no additional charge." The "Qualifying/Eligible Products/Services" section is titled "Qualifying Products" and lists "SuSE Linux Enterprise Server 8 for iSeries" with three bullet points: "Media", "One year of maintenance", and "Six months of IBM Operational Support Services- Support Line for Linux iSeries Monday - Friday, 8:00 a.m. - 5:00 p.m. (customer's time zone)". The "Related links" section includes "iSeries Home" and "Linux for iSeries". There is also an "E-mail this page" link and a "More offers" link. The left sidebar contains navigation links such as "Select a country", "Shopping help", and "Related links".

<http://www-132.ibm.com/webapp/wcs/stores/servlet/PromotionDisplay?promold=12770&catalogId=-840&storeId=1&langId=-1>

Trademarks and Disclaimers

© IBM Corporation 1994-2003. All rights reserved.

References in this document to IBM products or services do not imply that IBM intends to make them available in every country. The following terms and trademarks or registered trademarks of International Business Machines Corporation in the United States, other countries, or both. This list is not a comprehensive list of all IBM trademarks.

400	ClusterProven	e business (logo)	IBM.COM	PowerPC	System/38
AIX	DataPropogator	e (logo) business	InfoPrint	PR/SM	ThinkPad
AIX/L (logo)	DB2	e-business (logo)	iSeries	pSeries	Tivoli
AIX 5L	DB2 Extenders	e-business Hosting	Magstar	Redbooks	VisualAge
Application System/400	DB2 OLAP Server	e-business on demand	MQSeries	SecureWay	WebSphere
AS/400	DB2 Universal Database	FlashCopy	Operating System/400	SmoothStart	X-Architecture
AS/400e	DRDA	IBM	OS/400	SQL/400	xSeries
Chipkill	e (logo) server	IBM (logo)	Parallel Sysplex	System/36	zSeries

Cc:Mail, Domino.Doc, Domino, Freelance Graphics, iNotes, LearningSpace, Lotus Notes, Lotus, Notes, QuickPlace, Sametime are trademarks owned by IBM-Lotus in the United States, other countries, or both.

C-bus is a trademark of Corollary, Inc. in the United States, other countries or both.

Java and all Java-based trademarks are trademarks of Sun Microsystems, Inc. in the United States, other countries, or both.

Microsoft, Windows, Windows NT, and the Windows logo are trademarks of Microsoft Corporation in the United States, other countries, or both.

ActionMedia, LANDesk, MMX, Pentium and ProShare are trademarks of Intel Corporation in the United States, other countries, or both.

UNIX is a registered trademark of The Open Group in the United States and other countries.

SET and the SET Logo are trademarks owned by SET Secure Electronic Transaction LLC.

Other company, product and service names may be trademarks or service marks of others.

Information is provided "AS IS" without warranty of any kind.

All customer examples described are presented as illustrations of how those customers have used IBM products and the results they may have achieved. Actual environmental costs and performance characteristics may vary by customer.

Information in this presentation concerning non-IBM products was obtained from a supplier of these products, published announcement material, or other publicly available sources and does not constitute an endorsement of such products by IBM. Sources for non-IBM list prices and performance numbers are taken from publicly available information, including vendor announcements and vendor worldwide homepages. IBM has not tested these products and cannot confirm the accuracy of performance, capability, or any other claims related to non-IBM products. Questions on the capability of non-IBM products should be addressed to the supplier of those products.

All statements regarding IBM future direction and intent are subject to change or withdrawal without notice, and represent goals and objectives only. Contact your local IBM office or IBM authorized reseller for the full text of the specific Statement of Direction.

Some information in this presentation addresses anticipated future capabilities. Such information is not intended as a definitive statement of a commitment to specific levels of performance, function or delivery schedules with respect to any future products. Such commitments are only made in IBM product announcements. The information is presented here to communicate IBM's current investment and development activities as a good faith effort to help with our customers' future planning.

Performance is based on measurements and projections using standard IBM benchmarks in a controlled environment. The actual throughput or performance that any user will experience may vary depending upon considerations such as the amount of multiprogramming in the user's job stream, the I/O configuration, the storage configuration, and the workload processed. Therefore, no assurance can be given that an individual user will achieve throughput or performance improvements equivalent to the ratios stated here.

Photographs shown are of engineering prototypes or representation of product functions. Changes may be incorporated in production models.