

IMS: Leading the 21st Century for e-Business and all your business needs



S H A R E, Long Beach

February, 2001

Session : 1234

Bob Gilliam

IMS Family Product Manager

gilliamb@us.ibm.com

www.ibm.com/ims

IMS Customers World-Wide

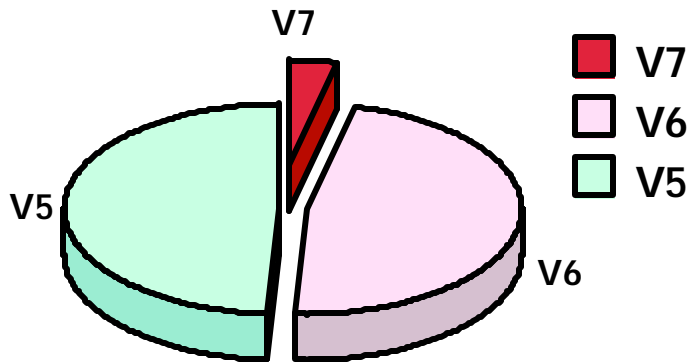
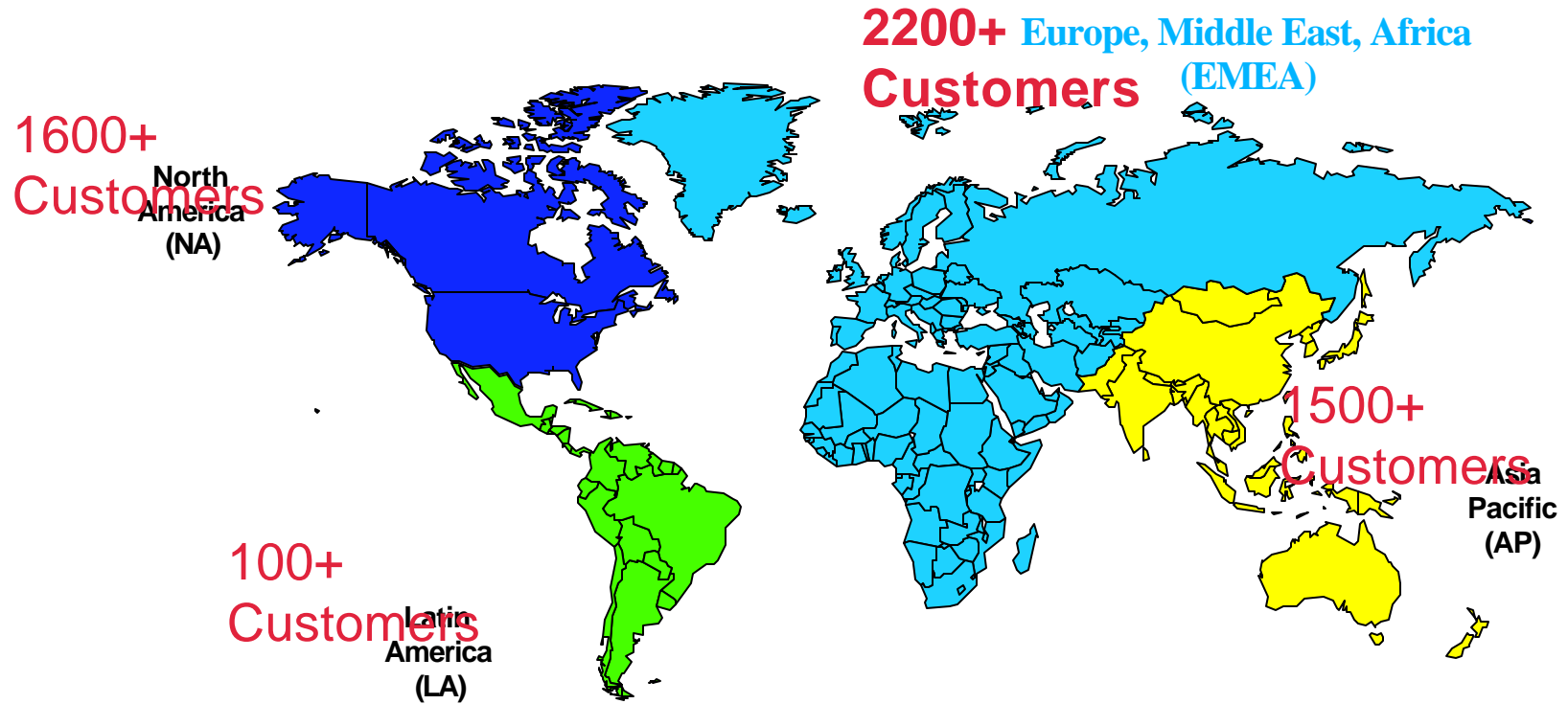

The World Depends on It !!

..shown good base code stability..."
Marge Harvey / Jim Chamberlain
Toronto Dominion Bank

e-business Powered by IMS

...the migration was achieved non-disruptively during our prime shift... "
Juergen Berghaus
GAD



an essential stepping stone to meet the future business and availability challenges at Barclays... "
Aly Bremner
Barclays

"...delivers cost savings and improved availability."
Tucson Medical



the world depends on it

"...very satisfied with the base functions..."
Stephan Nostadt
Deutsche Telekom

"... a still large and loyal IMS installed base due to the rock solid reputation ..."
Gartner Group report

CUSTOMERS

Service and Services

Application Development & APIs

IMS "Core"

Database & Transaction Management

IMS & DB2 Tools

CUSTOMERS

Service and Services

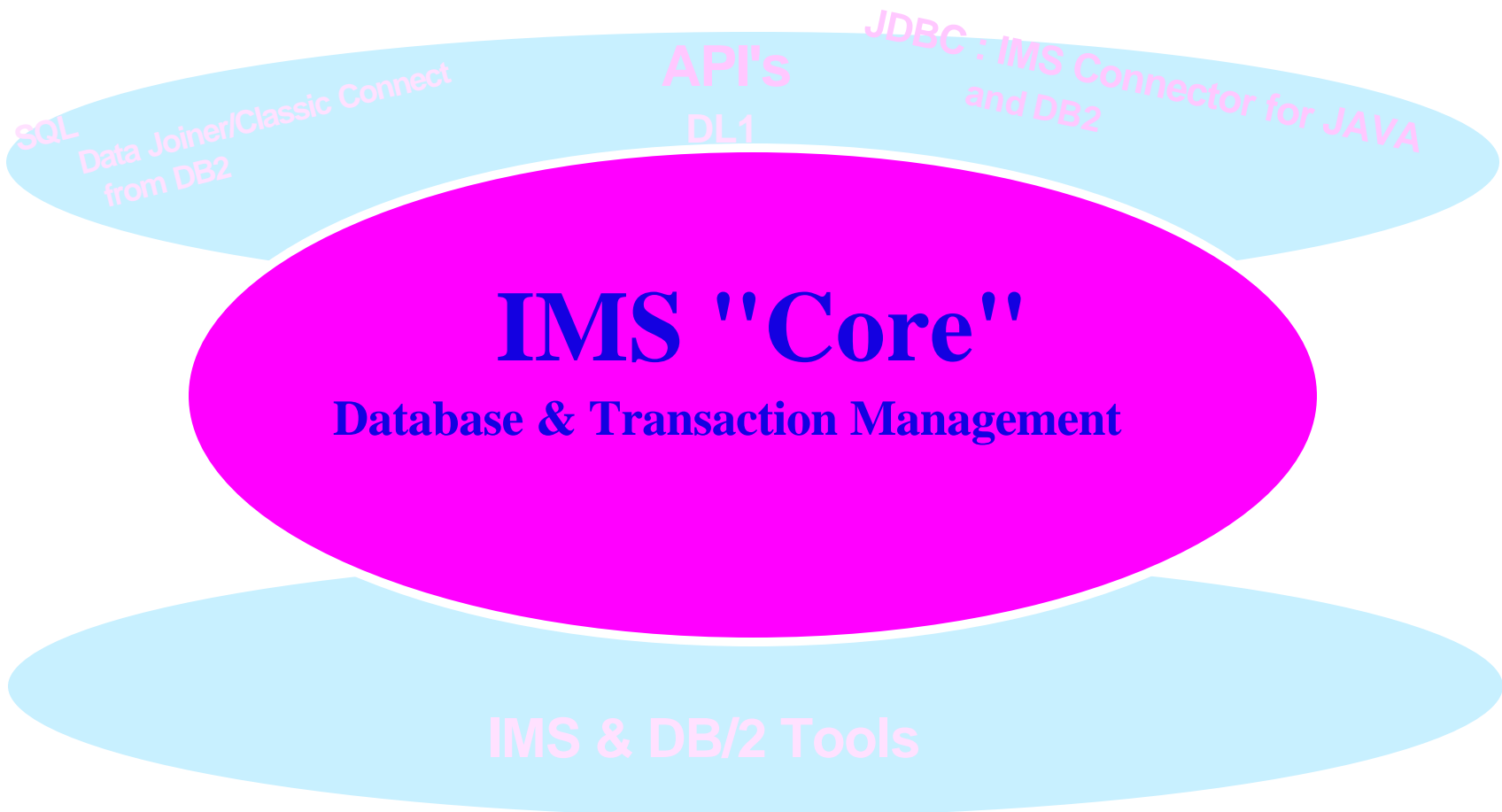

IMS Version 7



Availability

- Rapid Network Reconnect
- Enhanced Shared Queues/FP sharing
- SLUP session status
- RECON Upgrade/Coexistence
- I/O toleration
- Fast Path MADS enhancements

Performance/Capacity

- High Availability Large Database support
- DB Fiber Channel support
- DBRC enhancements
- Large DBRC Recon Record support
- MSC Descriptor Limit
- New Exits
- New execution parameters
- ACBGEN capacity/perf enhancements
- Fast Path Monitor support

Systems Management

- Tivoli Readiness
- ETO Autologon and Printer enhancements
- SHQs Associated Printer support
- RACF PassTicket
- USERID/LTERM clarification
- Deferred ACB open
- MSC exit usability enhancements
- Diagnostics/Serviceability enhancements
- Compatibility enhancements
- Installation enhancements
- Commands enhancements
- Migration
- Additional Operator Information
- Logger enhancements

IMS V7 Rapid Network Reconnect

for IMPROVED AVAILABILITY

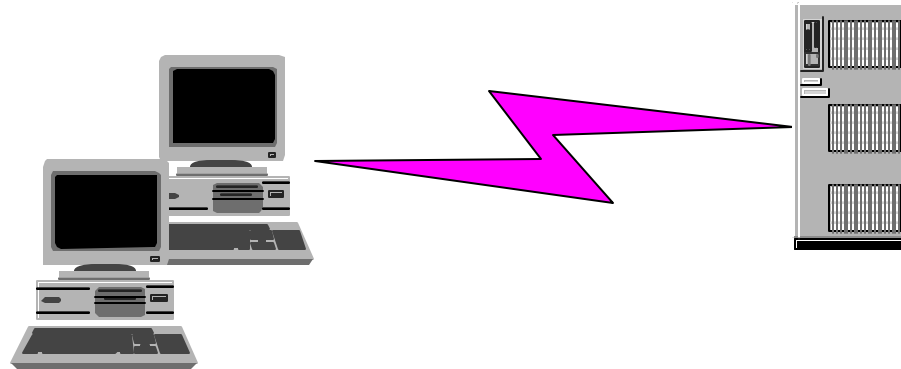

- ✓ Provides reduced network reconnect time after IMS, MVS, or VTAM failure in a sysplex environment
- ✓ Permits IMS TM to automatically reconnect terminal sessions following any kind of IMS failure and subsequent IMS restart

IMS V7 High Availability Large DB Support

for IMPROVED CAPACITY & DATA AVAILABILITY

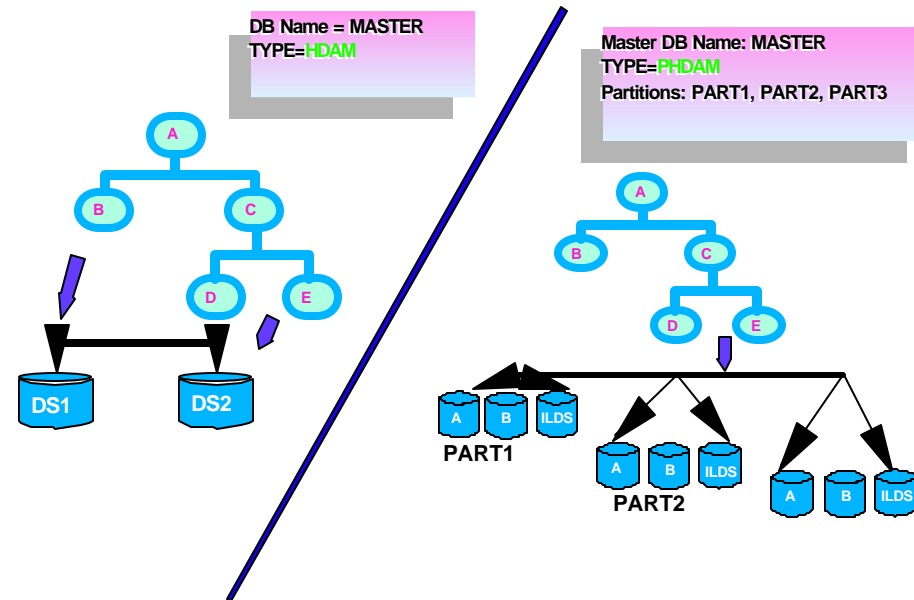

✓ Extends IMS Full Function database size

➔ 1001 Partitions x 10 data set groups x 4G = 40 Terabytes

✓ Provides data availability through partition independence

✓ Provides easier manageability with smaller partitions of the database

CUSTOMERS

Service and Services

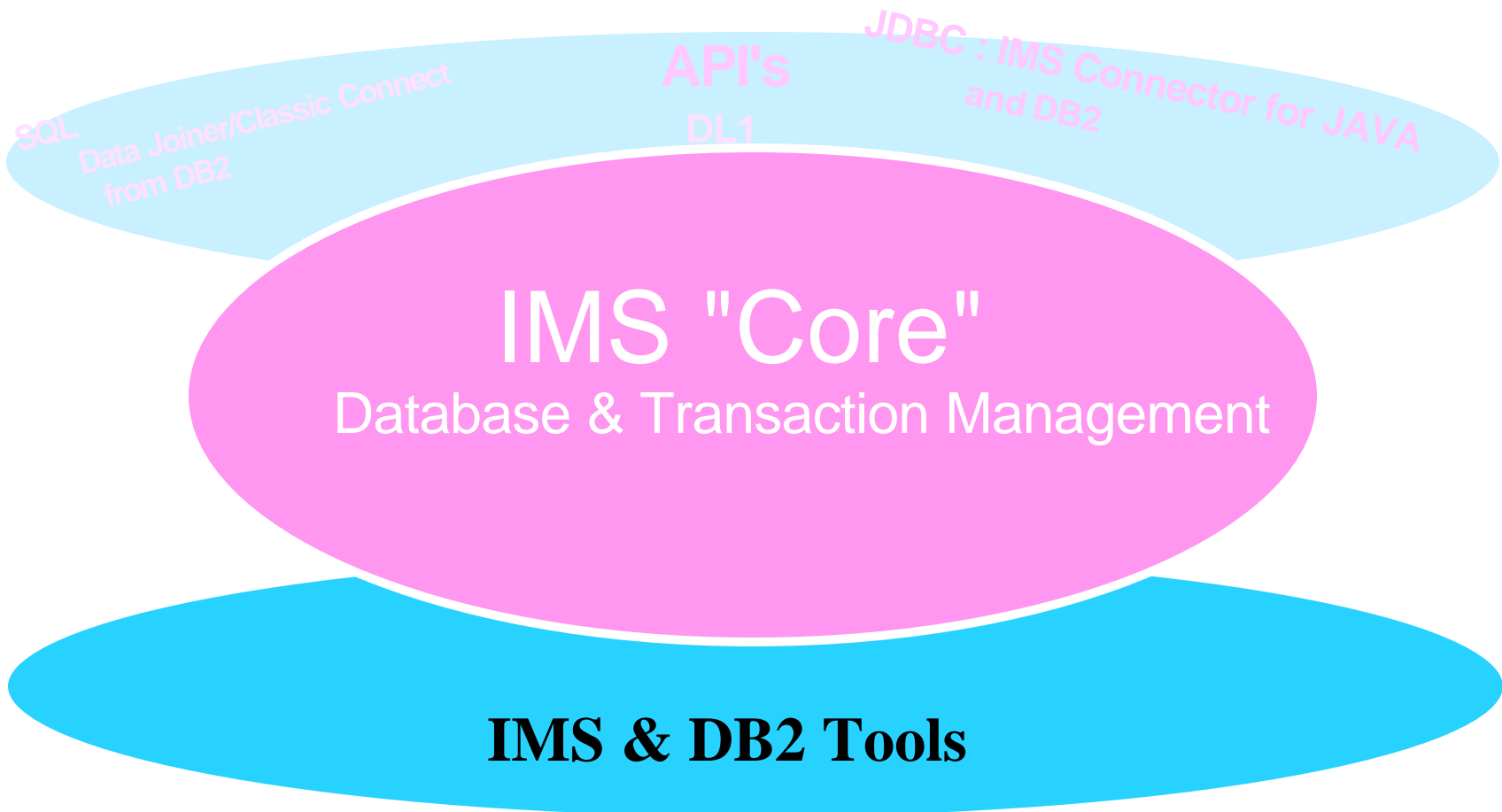

IMS Systems/Data Management Tools

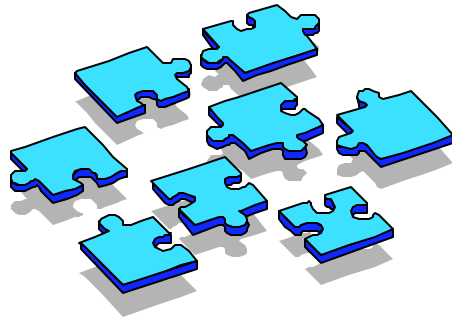

■ Administration

- ▶ IMS High Performance Load
- ▶ IMS High Performance Unload
- ▶ IMS Index Builder
- ▶ IMS Fast Path Basic Tools
- ▶ IMS Fast Path Online Tools
- ▶ IMS ETO Support
- ▶ IMS Library Management
- ▶ IMS Advanced ACB Generator
- ▶ IMS DB Repair Facility
- ▶ IMS HD Compression -Extended
- ▶ IMS High Performance Pointer Checker
- ▶ IMS High Performance Prefix Resolution
- ▶ IMS Sequential Randomizer Generator

■ Application Management

- ▶ IMS Program Restart Facility
- ▶ IMS Connect

■ Database Recovery and Replication Management

- ▶ IMS DEDB Fast Recover
- ▶ IMS Image Copy Extensions
- ▶ IMS Recovery Saver
- ▶ IMS Data Base Recovery Control Facility

■ Database Performance Management

- ▶ IMS Performance Analyzer
- ▶ IMS Queue Control Facility



IMS Online Recovery Service

for IMPROVED AVAILABILITY

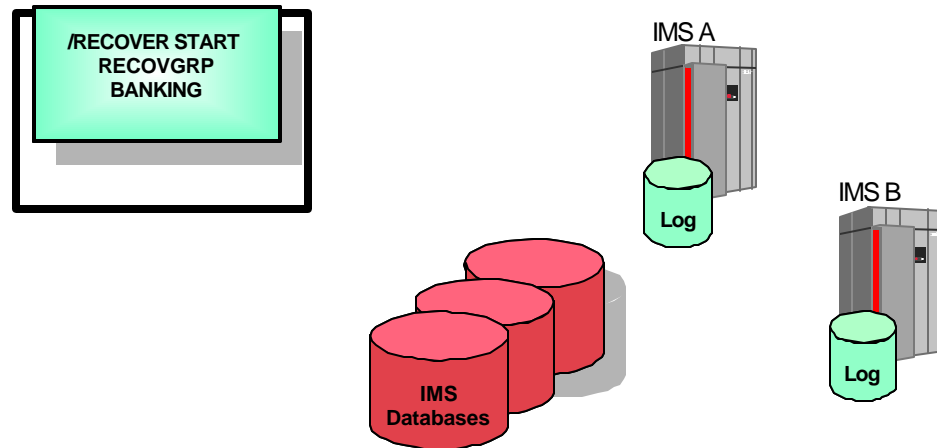

- ✓ **Increased performance in recovery situations**
 - Reduce the time that critical databases are unavailable
- ✓ **Increased flexibility in recovery options**
 - Perform 'logical recoveries' - true **Point-In-Time recovery**
- ✓ **Increased simplicity of the recovery process**
 - IMS manages the recovery

Significant decrease in DB Recovery Times - up to 4 times



IMS Connect

for High Performance access to IMS

- ✓ High performance with persistent sockets
- ✓ Excellent Serviceability with Dump formatting enhancements
- ✓ Manageability with SMP/E installability
- ✓ Unicode Support
- ✓ Local support

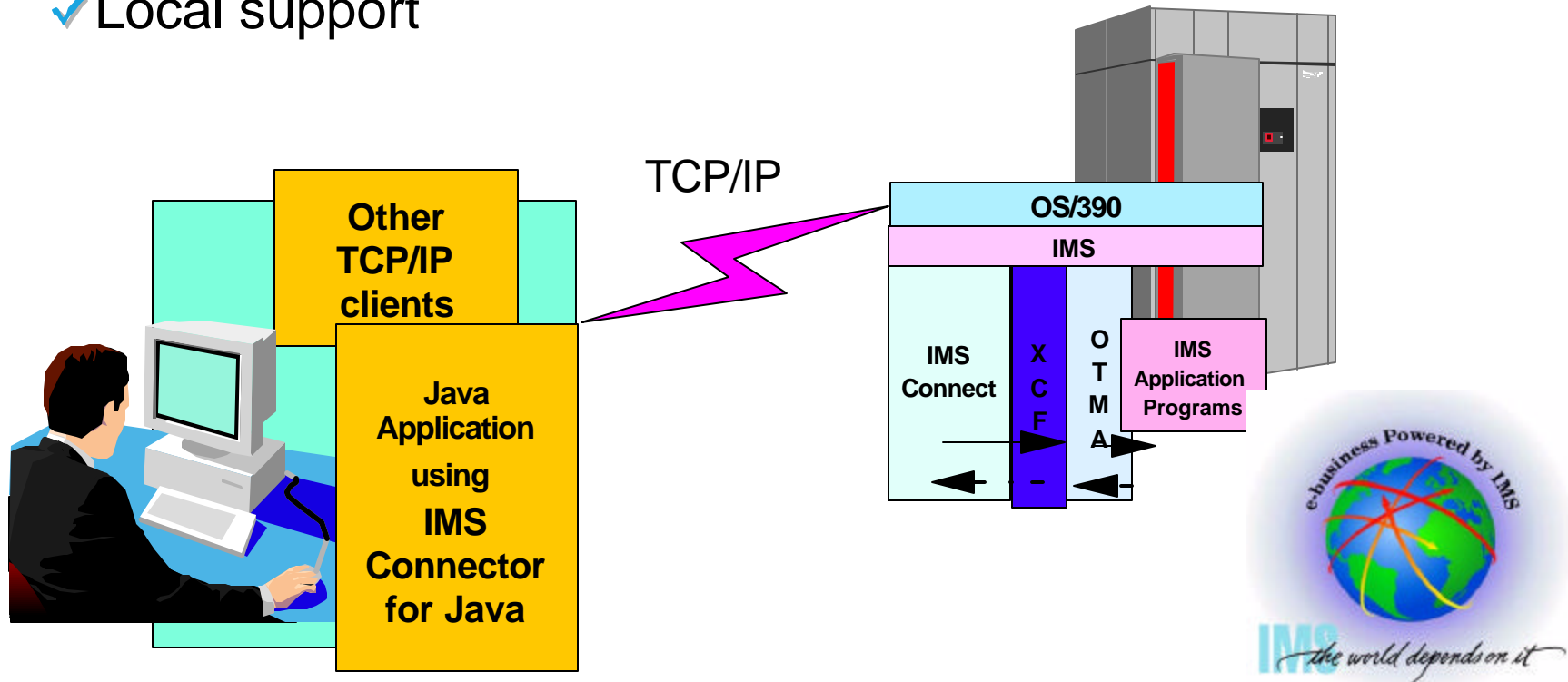

Web-Enablement

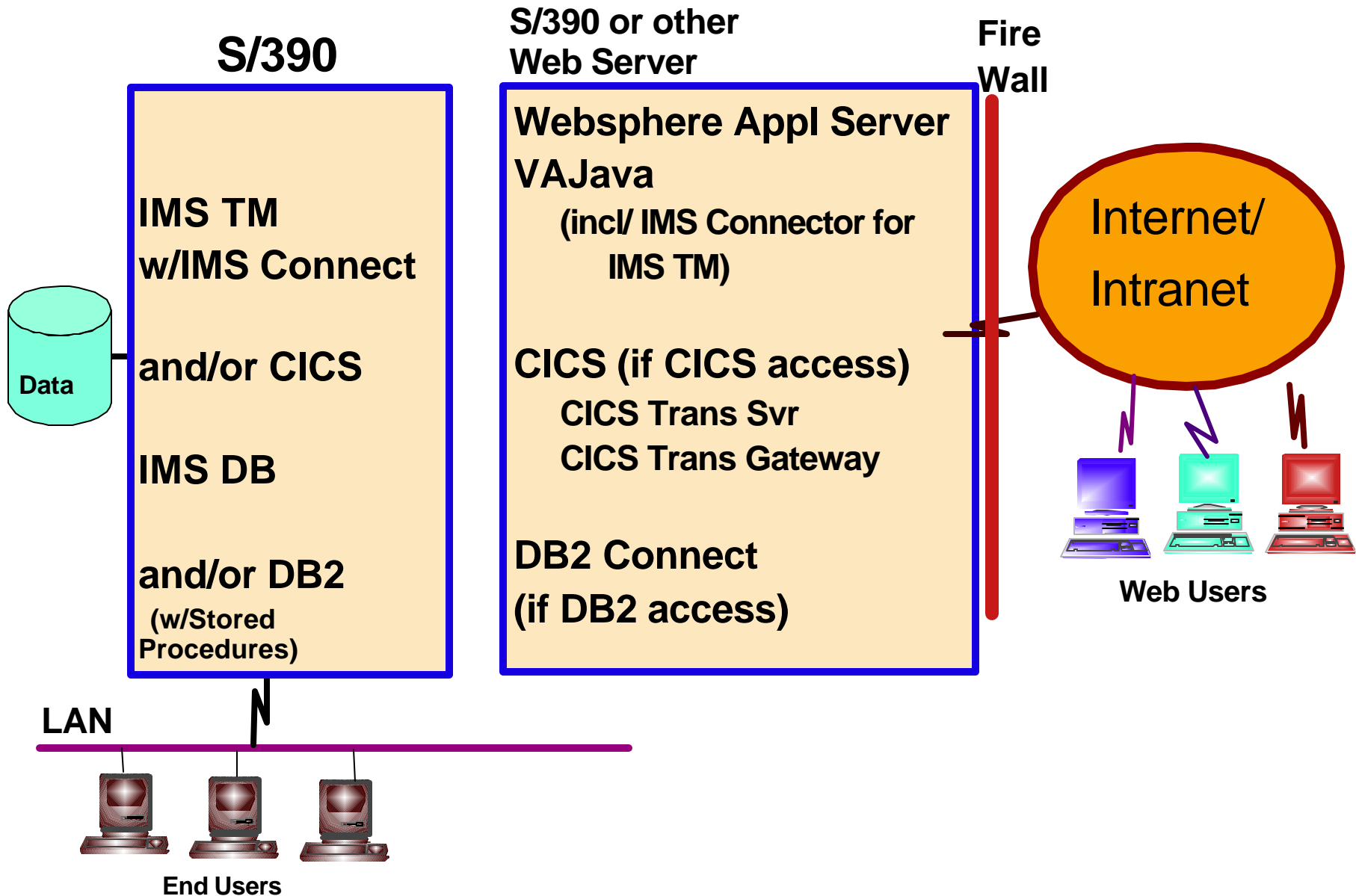

CUSTOMERS

Service and Services

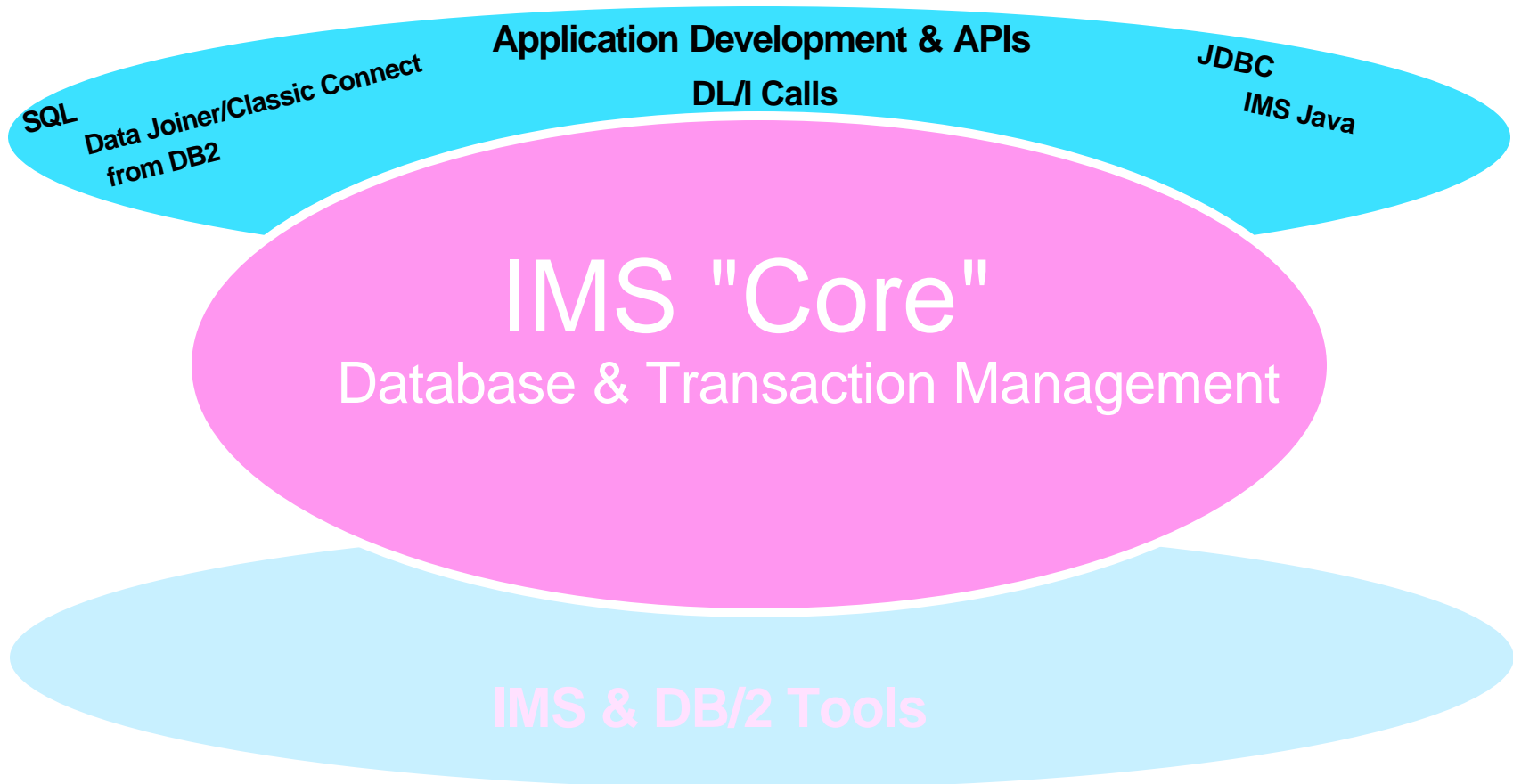

IMS V7 Java for Integrated e-Business *Application Development*



✓ Application programmer productivity

- Skills
 - Java access to IMS input/output message queues
 - JDBC to access IMS DB and DB2 data
 - Expanding for WAS, CICS & DB2 Stored Proc
- Tools
 - Uses VisualAge tools for development

IMS Connector for Java

- Helps customer make the transition to e-business by providing **easy Java access** to IMS transactions
- Create Java applications or servlets that can access existing IMS transactions by using **JAVA beans**
- Provides CCF-compliant **Java Class libraries** which interact with IMS via the IMS Connect on the host
- Provides **Java bean classes** to aid in visually composing applications.
 - ▶ Applications can be easily and rapidly built by 'wiring' the Java beans and components together using the **VisualAge for Java** visual development tool.
- Ships with **Visual Age for Java Enterprise Edition**

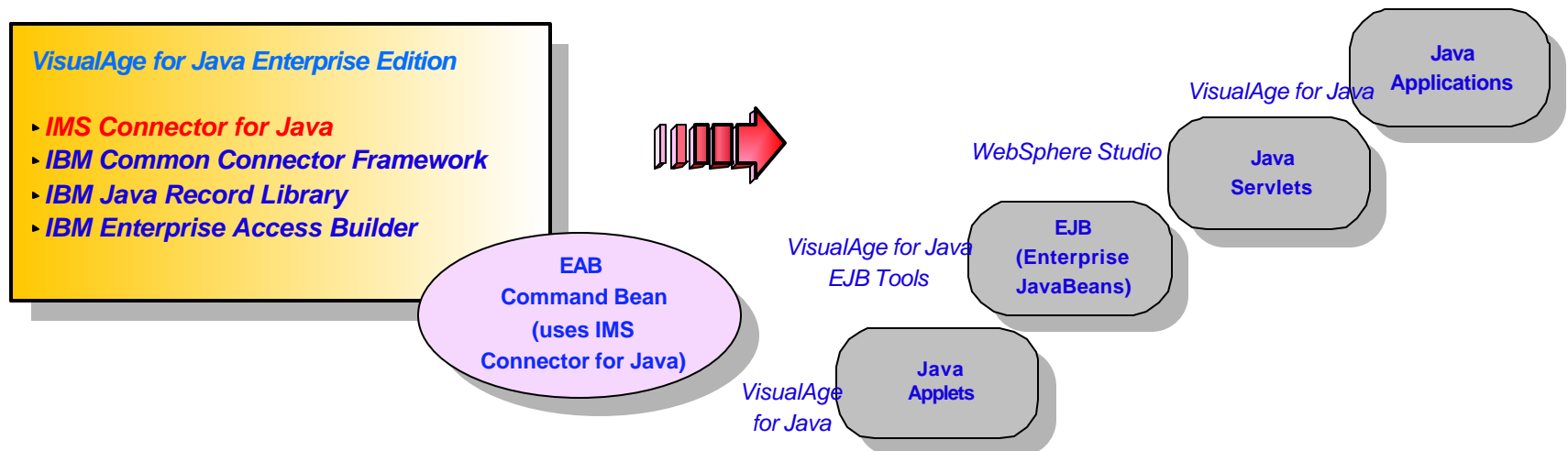

IMS Business Model Change

Delivery Cycles

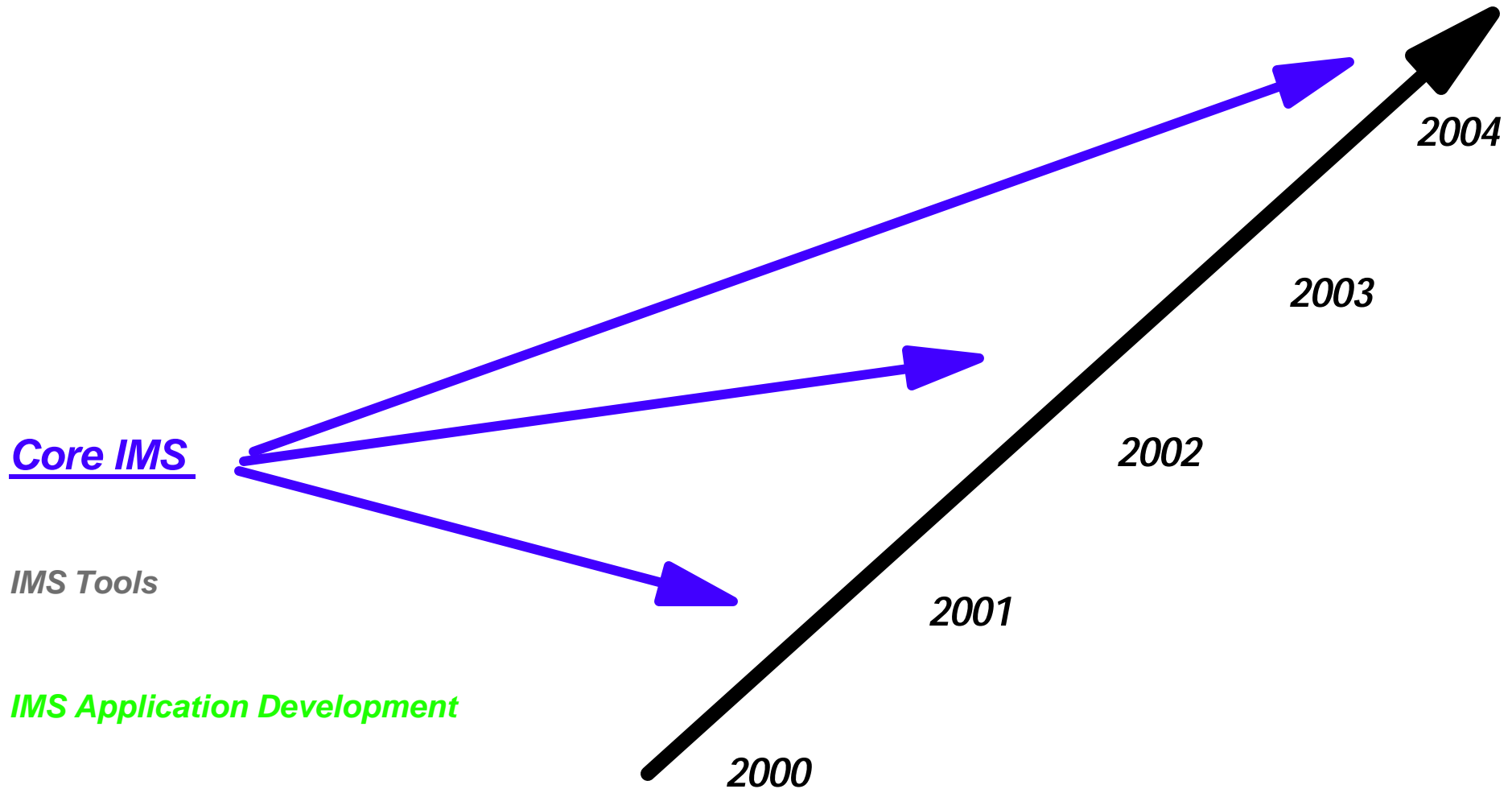

IMS Business Model Change

Delivery Cycles

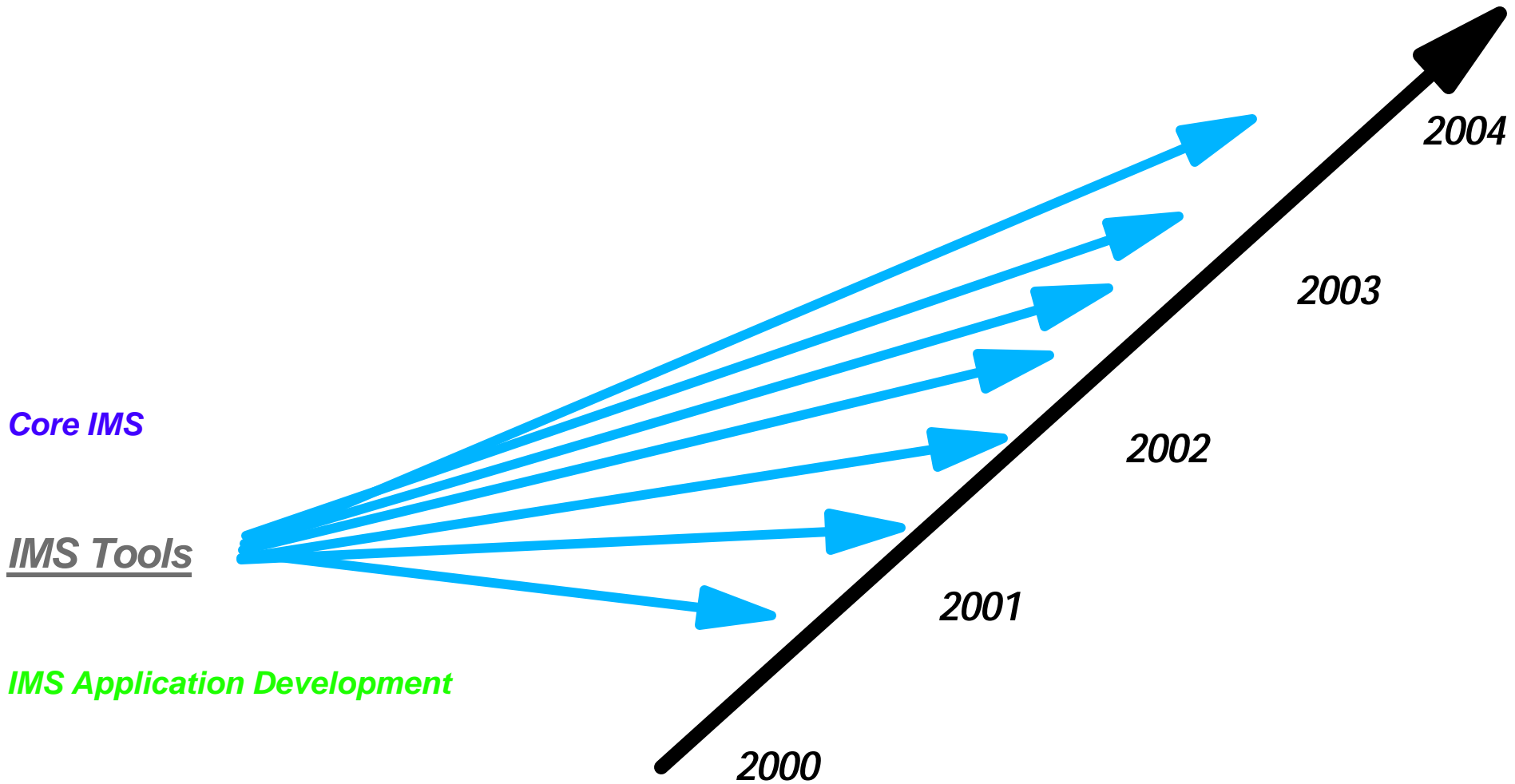

IMS Business Model Change

Delivery Cycles

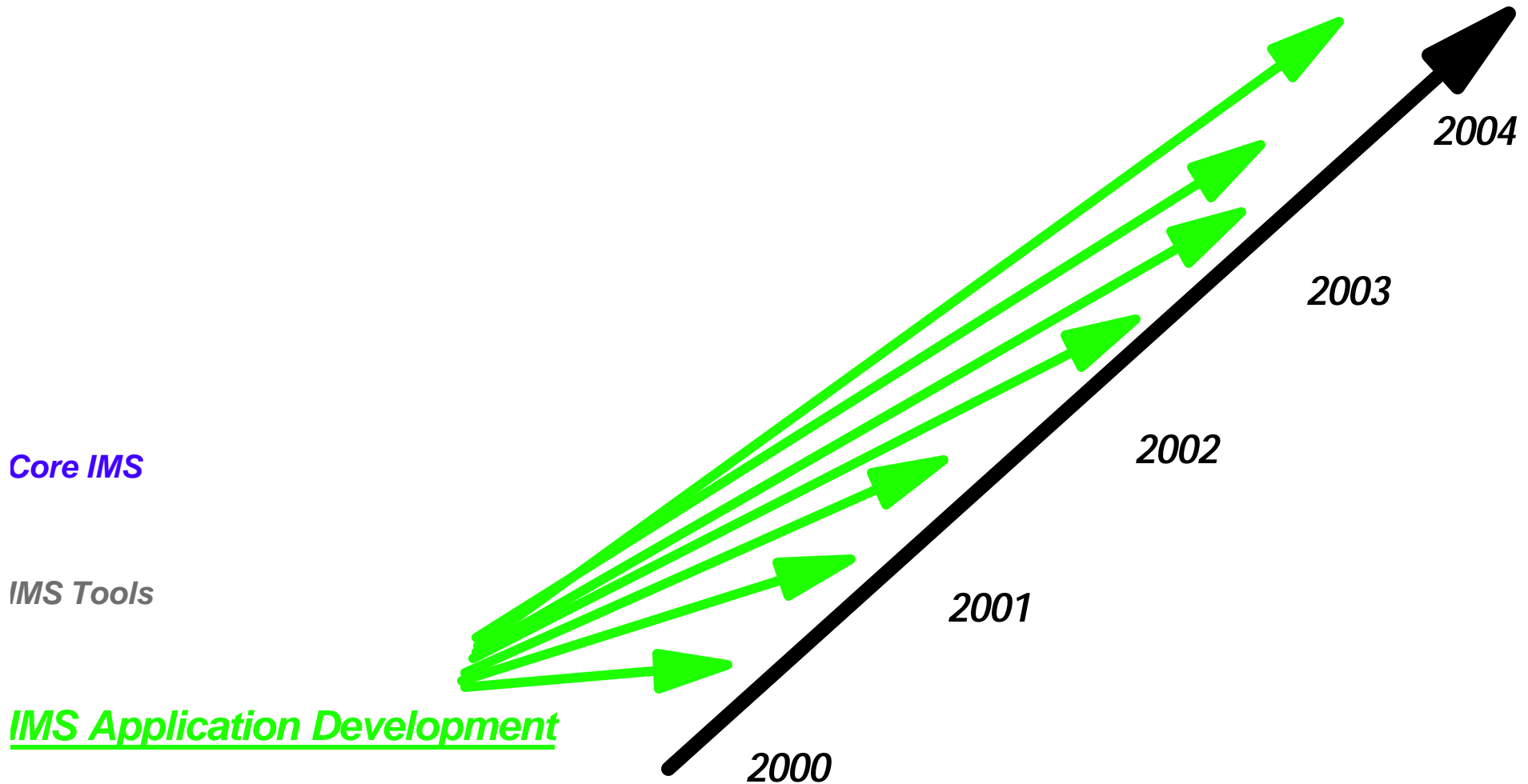

IMS - Now open for e-Business

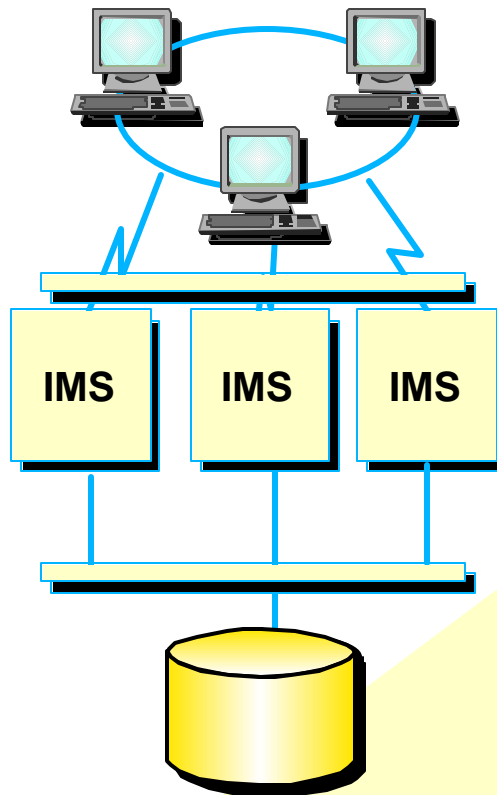

**Strategic Open Access
S/390 Enterprise Server**

Ideal for e-business

- ✓ Continuous Availability
- ✓ Systems Management
- ✓ Performance/Capacity
- ✓ Connectivity
- ✓ Rapid Appl Development

Enhancements

- Extended Large DB support
- Enhanced DB recovery
- Faster Restart with Multinode Persistent Sessions
- Enhanced Systems Mgmt Tools
- Enhanced Connectivity
- IMS Java

Benefits

- ✓ Enable Customer Growth
- ✓ Enhance Workload Balancing
- ✓ Increase Availability; Ease of Use
- ✓ Preserve Current Application Investment
- ✓ Enable New Applications

IMS: Ideal for e-Business

- ✓ Handles unpredictable volumes
- ✓ Continuous up time for applications
- ✓ High levels of security
- ✓ End-to-end transaction integrity
- ✓ Real time data currency



e-business with IBM extends the investment



IMS V 7 "Raised the Bar" in the Business of e-Business

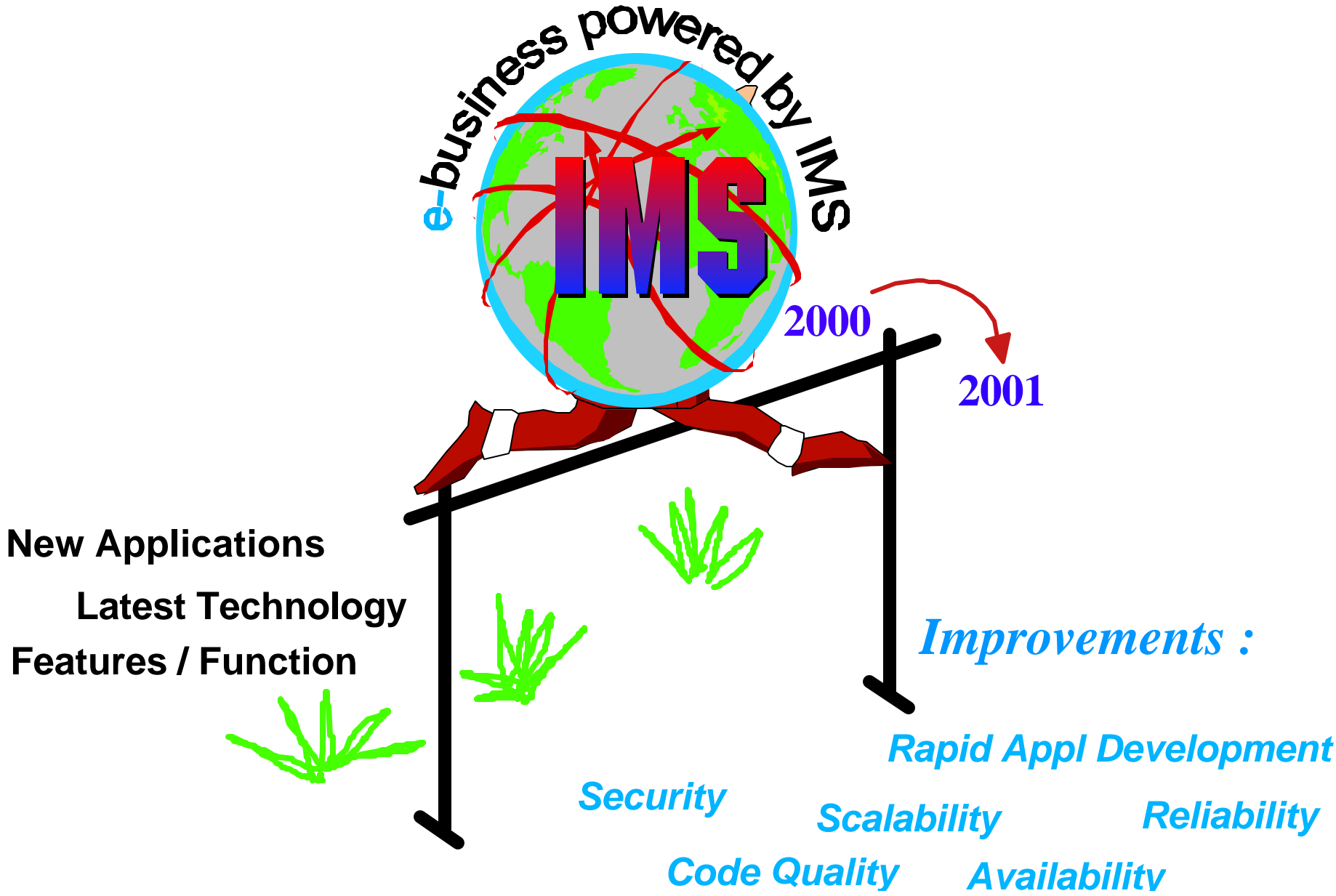

The New zSeries



- IMS V7 provides 64 bit real support in the database and logger
- IMS V5 V6 V7 will run on the z-Series --- faster and better
- IMS is announced as being enabled for License Manager to take advantage of new pricing structure
- **LINUX ENABLED !!!**

zSeries announcement October 2nd

*The first e-business Enterprise Server designed for
the high-performance data and transaction requirements for
next generation e-business*



IBM @-business servers. Technology. Innovation. Magic.

Enterprise Storage Server Performance (with ... IMS V7)

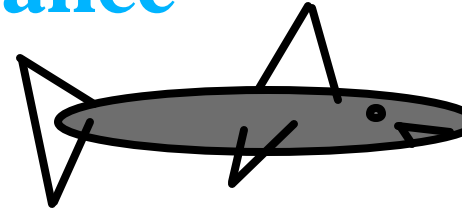

*Increase in
Bandwidth
Availability*

**IMS Serving Mission-critical Applications and Data
Access across the Enterprise and over the
Internet**

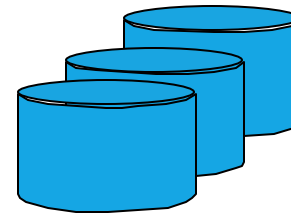

Achieved thru enhancements
across the IBM product line.

*Increase in Batch
Window Availability*



e-Business Development Means "End-to-End"

- e xtend Current Application Investment - Lifeline
- e xtend Availability and Reliability
- e nable new application growth

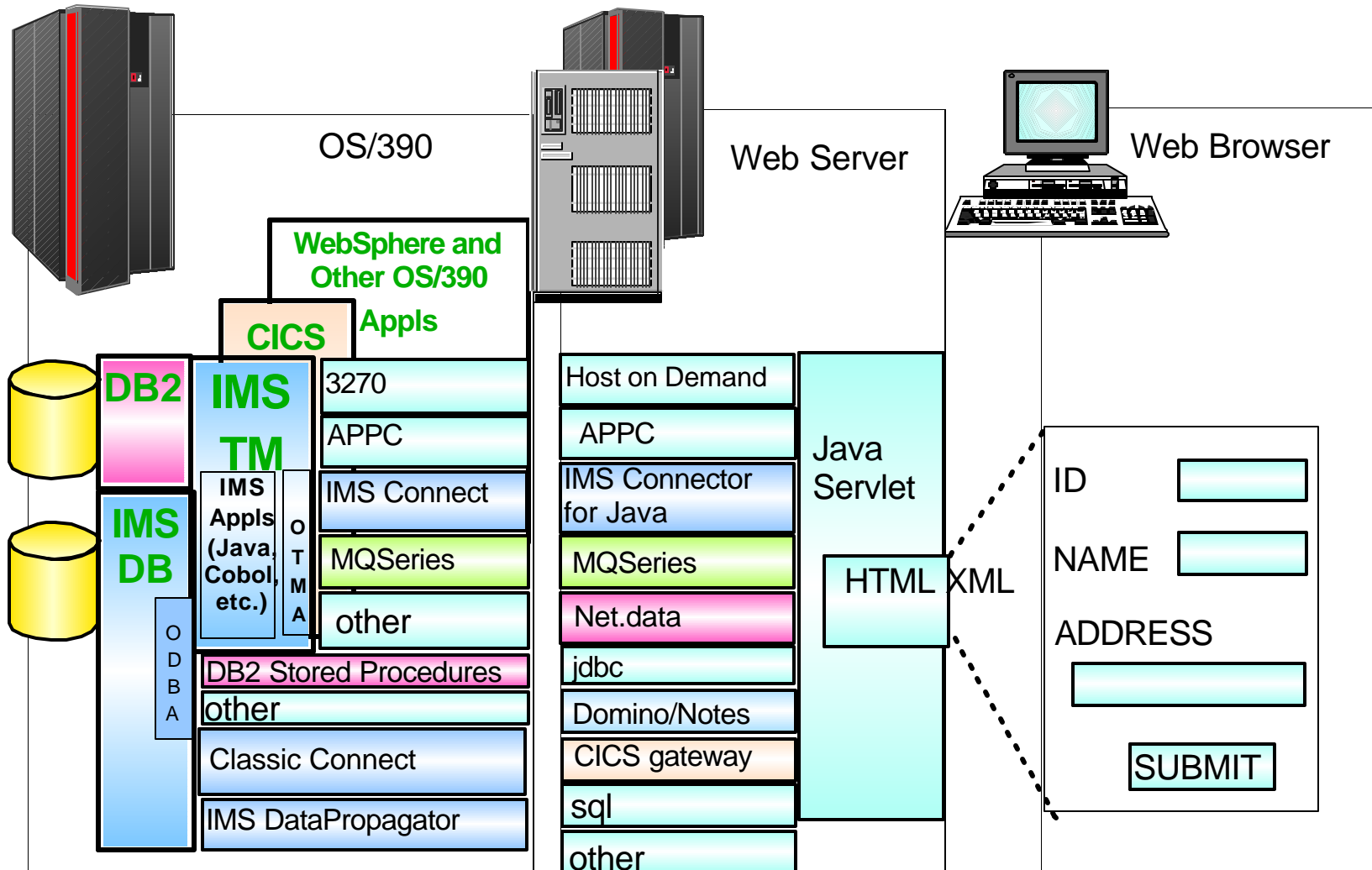

PMU - French Horse Racing

- **PRIX D'AMERIQUE 2000**
 - ▶ This 79th edition has seen the victory of General du Pommeau driven by Jules Lepennetier at a record speed of 1'12"6.
 - ▶ This 79th edition has seen the victory of the IMS Betting Application which reached 1100 transaction per second during half an hour!
- **IMS Betting Application Design**
 - ▶ 2 IMS subsystems without data sharing
 - designed for 1400 trans/sec
 - ▶ Using IMS Fast Path TM
 - Expedited Message Handler
 - ▶ Using IMS Fast Path DB
 - 3 VSO DEDBs with SDEPs



BETTING
Where to bet
How to bet

INFO
Forthcoming
race meetings
Programme
Results

DISCOVER
A day at the races
Live racing
The horse
French horseracing
institutions



CUSTOMERS

Service and Services

SQL
Data Joiner/Classic Connect
from DB2

Application Development & APIs

DL1 Calls

JDBC : IMS Connector for JAVA
and DB2

IMS "Core"
Database & Transaction Management

IMS & DB/2 Tools

 Search

Home | Products & services | Support & downloads | My account

Select a country

Products > Software > Database and Data Management



IMS

IBM's premier transactional and hierarchical database management system for critical on-line operational and e-business applications and data.

IMS

- How to buy
- Support
- News
- Case studies
- Library
- Services
- Events
- Education

Products

- IMS Version 7
- IMS Version 6
- IMS Version 5
- IMS Connect
- IMS Connector for Java
- Classic Connect
- IMS DataPropagator
- MQSeries
- Systems/Database Mgt. Tools

Info & Services

 IMS Newsletter

This is where the text should go. This is where the text should go.

Related links:

- IMS Library
- Feedback

IBM Worldwide

Recent News

- IMS V7 Library now available
- IMS V5 Service Discontinuance: 09/30/01
- DB2 & IMS Technical Conference in Hamburg, Germany March 5-9

Would you like to be notified of new IMS news? your email here



Featured Customer

IMS

Continuous Improvement

IMS Goals

Unlimited Growth

100% Accessable

100% Available

GEN-Less System

Dynamic Install

Latest Technology

IMS Directions...

Follow-on Enhancements

- Extend DB Connectivity
- Enhance SysplexOperations
- Simplify Install Process
- Enhance Mgmt Tools
- Online Reorganization

IMS Today

- HALDB
- Rapid Restart
- Enhanced DB Recovery
- Enhanced Connectivity
- IMS Java Applications



IBM Data Management Solutions...



*Our business is to help companies
leverage information to gain competitive
advantage.*

Transactions

Business Intelligence

Content Management



Are you
ready for
e-business?

- Thank You for Attending
- Enjoy the Conference

Think IMS for your e-business application

