

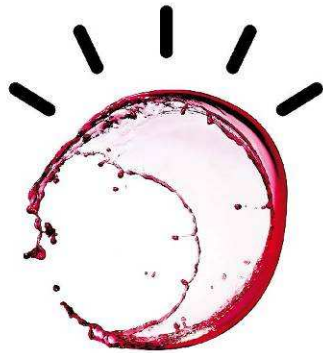

Degustare la crescita

Un percorso in 4 tappe alla scoperta delle soluzioni IBM

L'infrastruttura IT di nuova generazione per il mondo Mobile



100 years in the making

- Unparalleled expertise and level of investment
- Market leading systems and software
- Commitment to open standards
- Broadest ecosystem
- Unique ability to integrate
- Unwavering commitment to client success

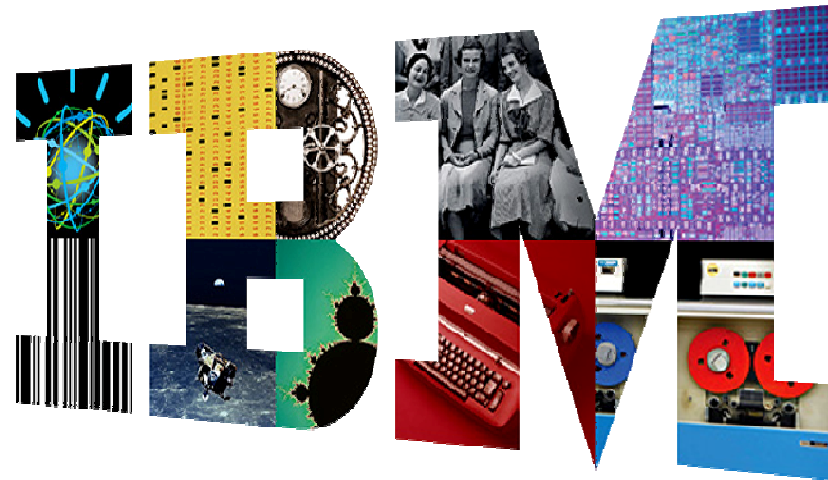

Simple

Mobile Monitoring UI



Chassis Map



New UI

IBM Flex System Manager™

Home -> Systems -> Monitor -> Security -> Utilities -> Find a System or Task

Deploy Compute Node Images

Select one or more X-Architecture compute nodes to which you want to deploy images. [Learn More...](#)

Note: Before you begin, validate the IBM Flex System Manager network port being used to attach to the data network is configured to be on the same network as the network ports on the compute node.

Deploy this image to all compute nodes: esx05.1-ix86_64-Install-Virtualization [Import additional images](#)

Chassis and Node	Bay	Access State	Discovered Operating System	Deploy Status	Image to Deploy
No filter applied.					
sm-19216801002					
BT10MM	3	OK	Not Discovered	Ready	esx05.1-ix86_64-Install-Virtualization
BT23mm	5	Offline	Not Discovered	Ready	esx05.1-ix86_64-Install-Virtualization
BT10MM	8	OK	Not Discovered	Ready	esx05.1-ix86_64-Install-Virtualization



IBM System x and BladeCenter evolution

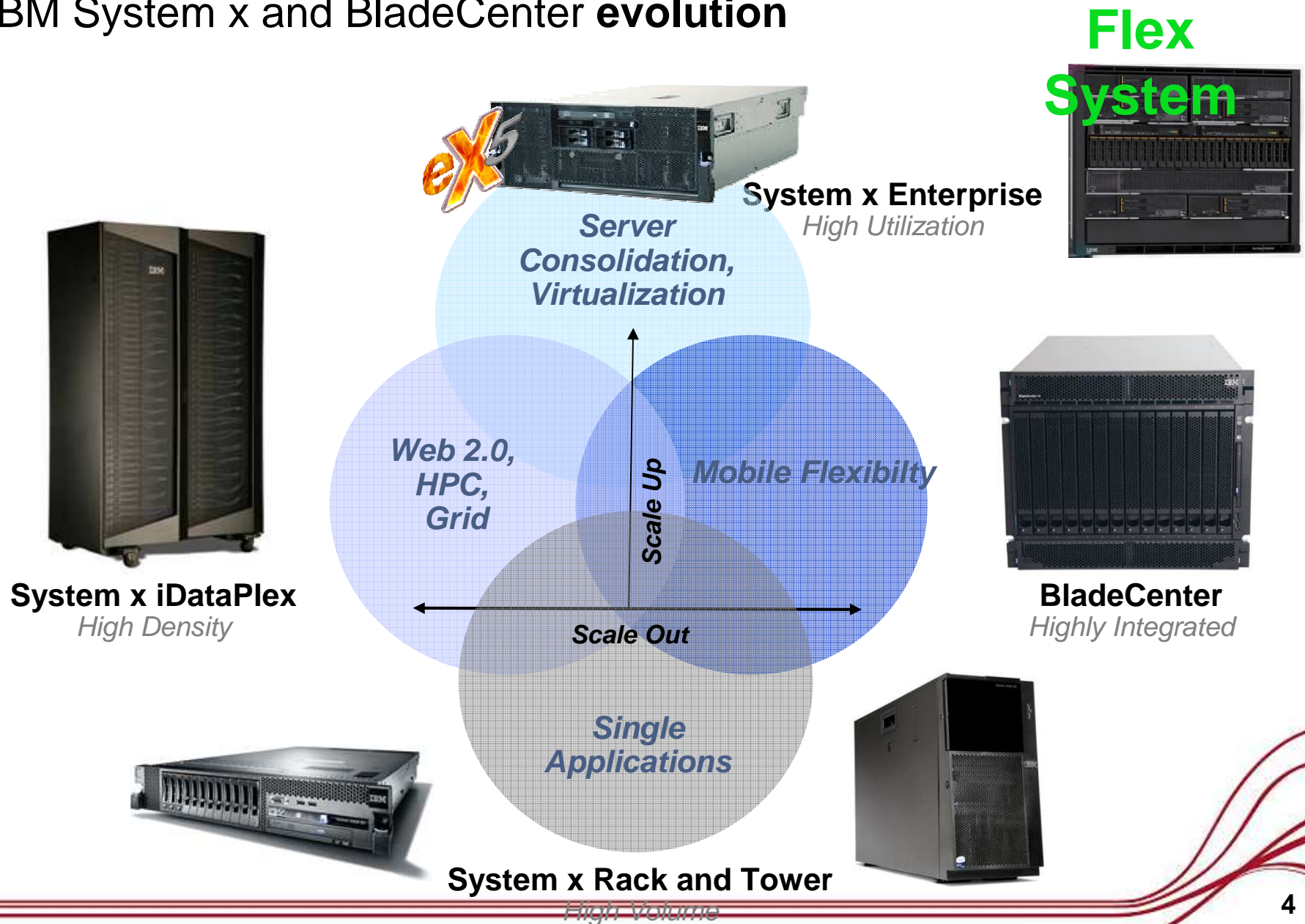



IBM PureSystems is Integrated by design

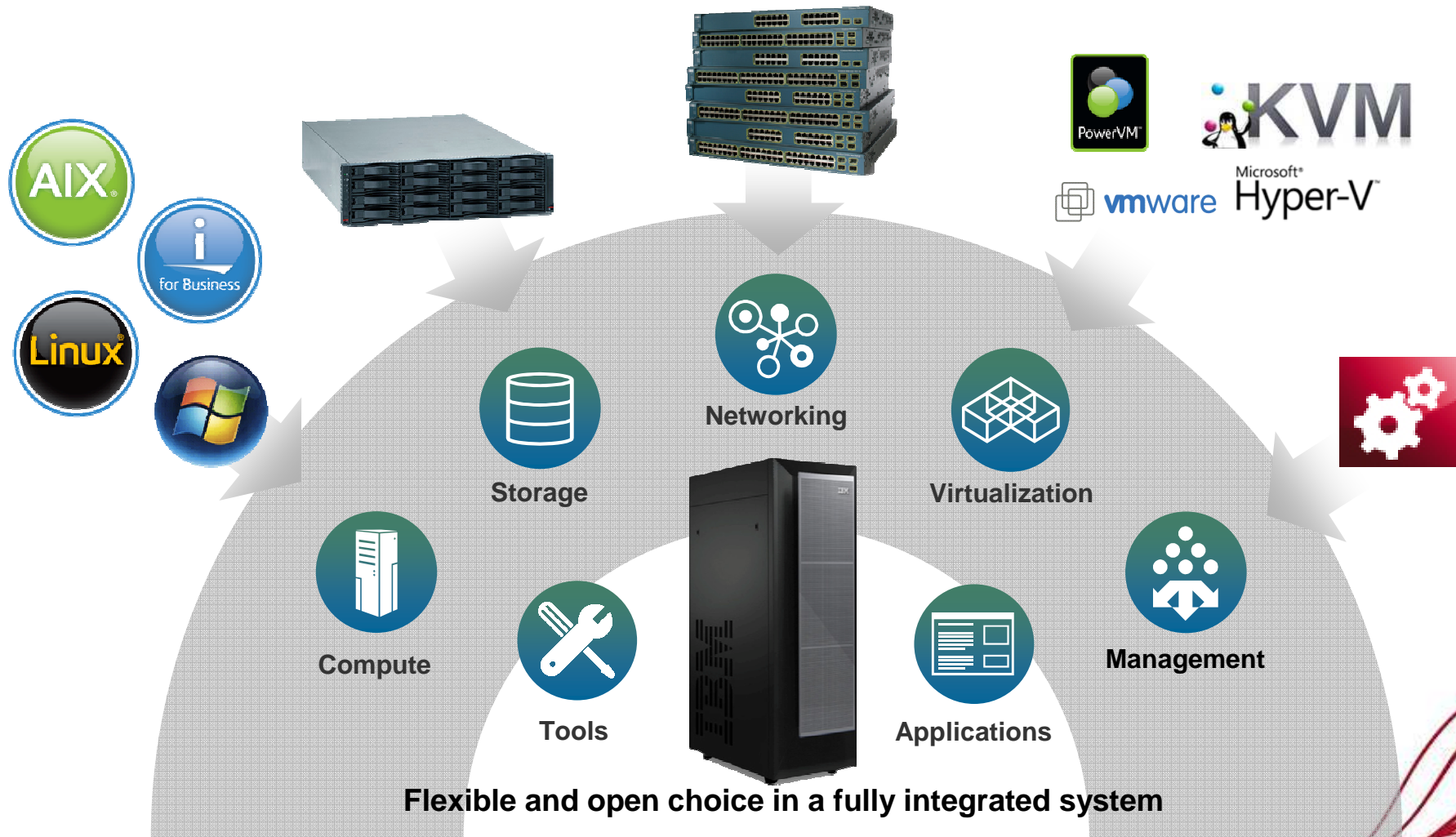



It is time for a new class of expert integrated systems

PureSystems

Built-in Expertise

*Capturing and automating
what experts do*



Integration by Design

*Deeply integrating and tuning
hardware and software*

Simplified Experience

Making every part of the IT lifecycle easier



PureSystems Solution: Simplifying the entire IT project lifecycle

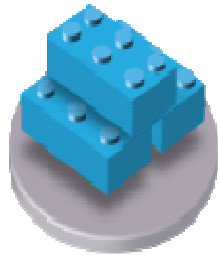

Expert Integrated System

Reduced Time, Cost and Risk

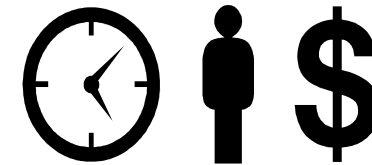

Built for Cloud

Clean slate design

Patterns of expertise

Scale-in Architecture

Integrated management

PureSystems

Flex System



Infrastructure Components

Next Generation Blade

PureFlex



Integrated Infrastructure

Delivering Infrastructure Services

PureApplication



Application Platform

Delivering Platform Services

PureData



Data Platform

Delivering Data Services



IBM PureFlex Systems

Built-in expertise of thousands of data center optimizations



Express

- Infrastructure for Small and midsize businesses. Most affordable entry point



Standard

- Infrastructure for application servers with supporting storage and networking



Enterprise

- Infrastructure for transactional and database systems. Redundancy for resilient operation





IBM Flex System:

The best "Blade" for today, for tomorrow, for your datacenter

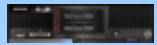

Best Blades

- Unmatched performance with max processor & memory capability for Intel based systems
- Integrated Flex System Flash to enable faster Database and High-IOPs workloads



Best Chassis

- Highest performance for IO. 40Gb Ethernet, 16Gb SAN speeds, 56Gb InfiniBand FDR
- Only platform to support a mixed environment of both x86 as well UNIX based systems



Best Management

- Significantly reduce the number of manual steps to greatly simplify management
- Manages IT as one; reducing complexity and automating everyday management tasks



Best Storage

- Reduce disk capacity needs by up to 80% with V7000 Real-time Compression
- Automatically optimize data between storage tiers with IBM Easy Tier

*Flex System deliver leading edge technology that increase resource utilization
and reduce ongoing management costs*



Simplified Lifecycle Experience & Built-in Expertise

Simplified Lifecycle Experience

- ✓ Set-up Wizards
- ✓ Element Discovery
- ✓ User Management
- ✓ Firmware & Software Updates/Upgrades
- ✓ Chassis Maps*
- ✓ Remote Presence
- ✓ Integrated Open Fabric Manager Support
- ✓ Reliable Logging / Events...

Built-in Expertise...

- ✓ Workload Placement Service
- ✓ Features On Demand
- ✓ System Pools Management
- ✓ VM Control Advance Manager
- ✓ Storage Control
- ✓ Network Control

Management Appliance



Flex System Manager

Managing the Lifecycle...
All Resources & Workloads,
Both Physical & Logical

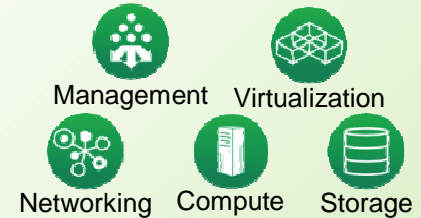

Setup Wizards...



Remote Presence...

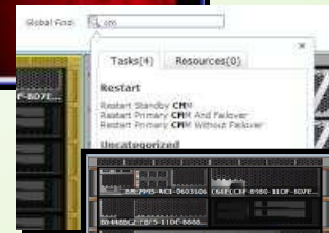

Quick Search...



Chassis Maps...



Meet The IBM Storwize™ Family

A comprehensive range of fully virtualized storage systems



Storwize V3500
(China only)



Storwize V3700
Nov. 6 2012



Storwize V7000
Oct. 2010



Storwize V7000 Unified
Oct. 2011



Flex System V7000
Nov. 13 2012

New!



SAN Volume Controller

2004

- One code base on all platforms
- One set of functions (selectively licensed)
- One user interface
- One CLI



Storwize V7000 Unified at a glance

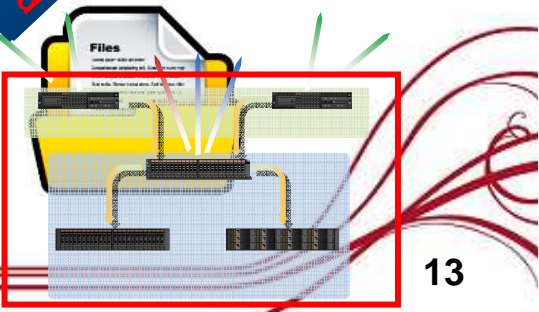
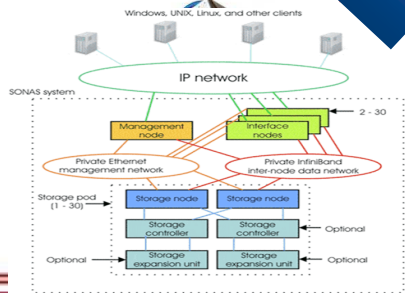
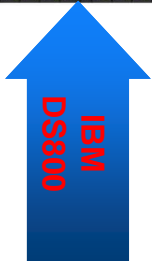
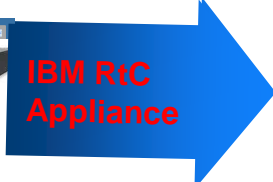
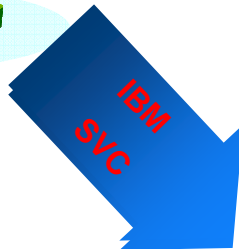
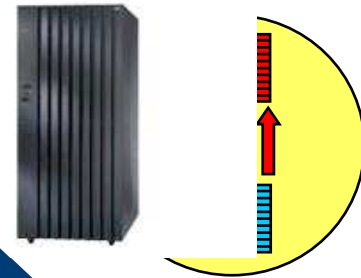
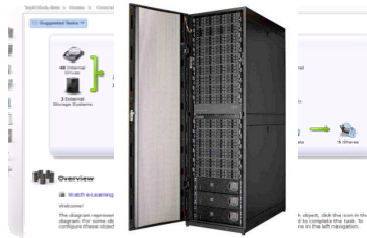
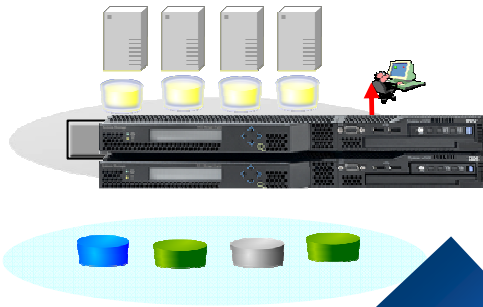



Resource Pooling & Automated Provisioning Expertise

Dramatically improve system utilization & admin productivity

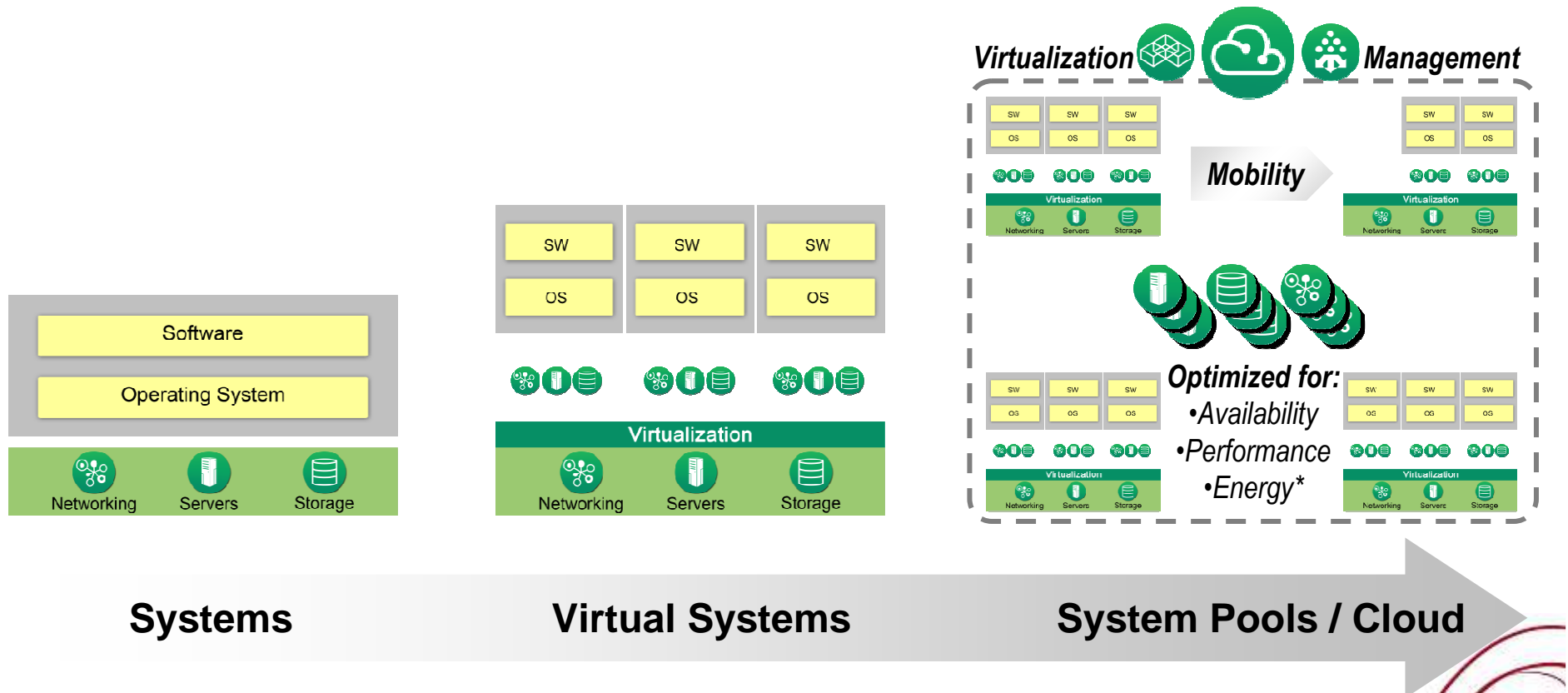

Manage a pool of system resources or a cloud as simply as managing a single system



Smarter Computing: the IT infrastructure that enables a Smarter Planet

Client-optimized system:

highly customizable systems designed to deliver the best in class capabilities uniquely tailored for the client's environment

Expert integrated systems:

combine the flexibility of a general purpose system with the simplicity of an appliance – and integrated expertise throughout

System z

Freedom through design



System x

Defining the next generation of x86 servers



Power Systems

Performance redefined



IBM Storage

Expect more from your Storage

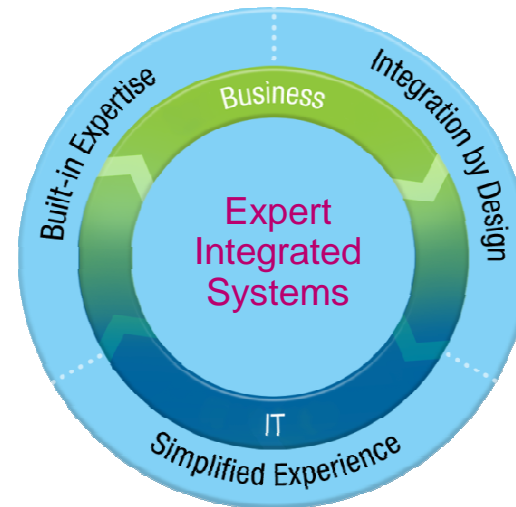

PureFlex