

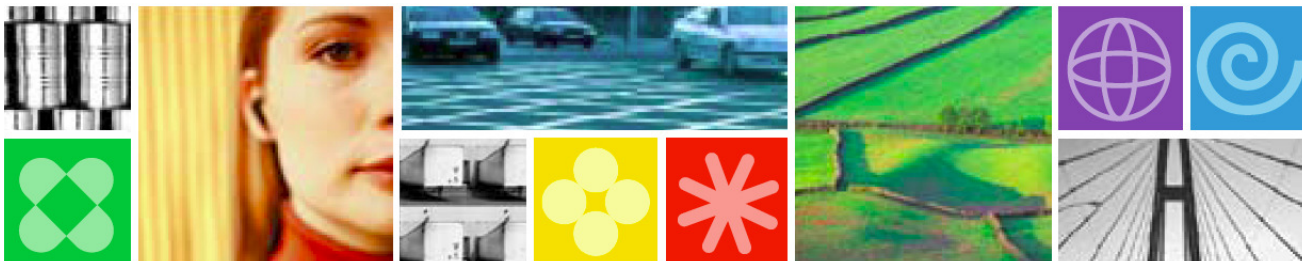

System z Software Strategy and Direction – New Software Capabilities and Enhancements

Ray Jones
WW Vice President, z Software





The Dynamic Infrastructure Journey





The Dynamic Infrastructure Journey - Ours





System z Software Strategy

Capitalize on Traditional System z Strengths

- Batch and Transaction processing, Messaging, Quality of Service, Data Serving
- Optimize to the evolving System z Hardware design point

Extend Value Proposition to New and Mixed Workloads

- Systematic re-engineering of the software stack for SOA
- Integrate with Modern Application Development Environments
- Deliver extensive Data Management services
- Leverage the wave of workload consolidation; zLinux
- Simplify System z – make it easier to install and manage for better TCO
 - New faces of z
 - More end-to-end management capability from a z central point of control
 - Simplified labor intensive tasks



Reinvigorate the System z Ecosystem

- Attract new System z customers and ISV application workloads
- Enable new Hybrid and Cloud environments
- Make System z relevant to the new IT generation



Preview: Smart Analytics Optimizer

Product Overview

- A special purpose, network attached appliance that is an add-on to an IBM DBMS system, that offloads typical Data Warehouse / Business Intelligence queries resulting in predictable and orders-of-magnitude faster query response times while reducing overall TCO
- Combines IBM DBMS with high performance Data Warehouse query software, based on advanced in-memory scale-out cluster technologies, while keeping the complete system centrally managed with unchanged interfaces for Business Intelligence applications



Highlights

- No changes to the applications
- DB2 transparently exploits the accelerator for application queries
- Significant price / performance and TCO improvements
- Improving performance of typical data warehouse queries 5 - 10x
- Achieving linear scalability with the number of CPUs
- Appliance-like form factor: user/reference guide assisted installation, initial configuration, hands free operation



Information-Led Transformation for System z

More new capabilities delivered in the past 3 years than at any point in the mainframe's history

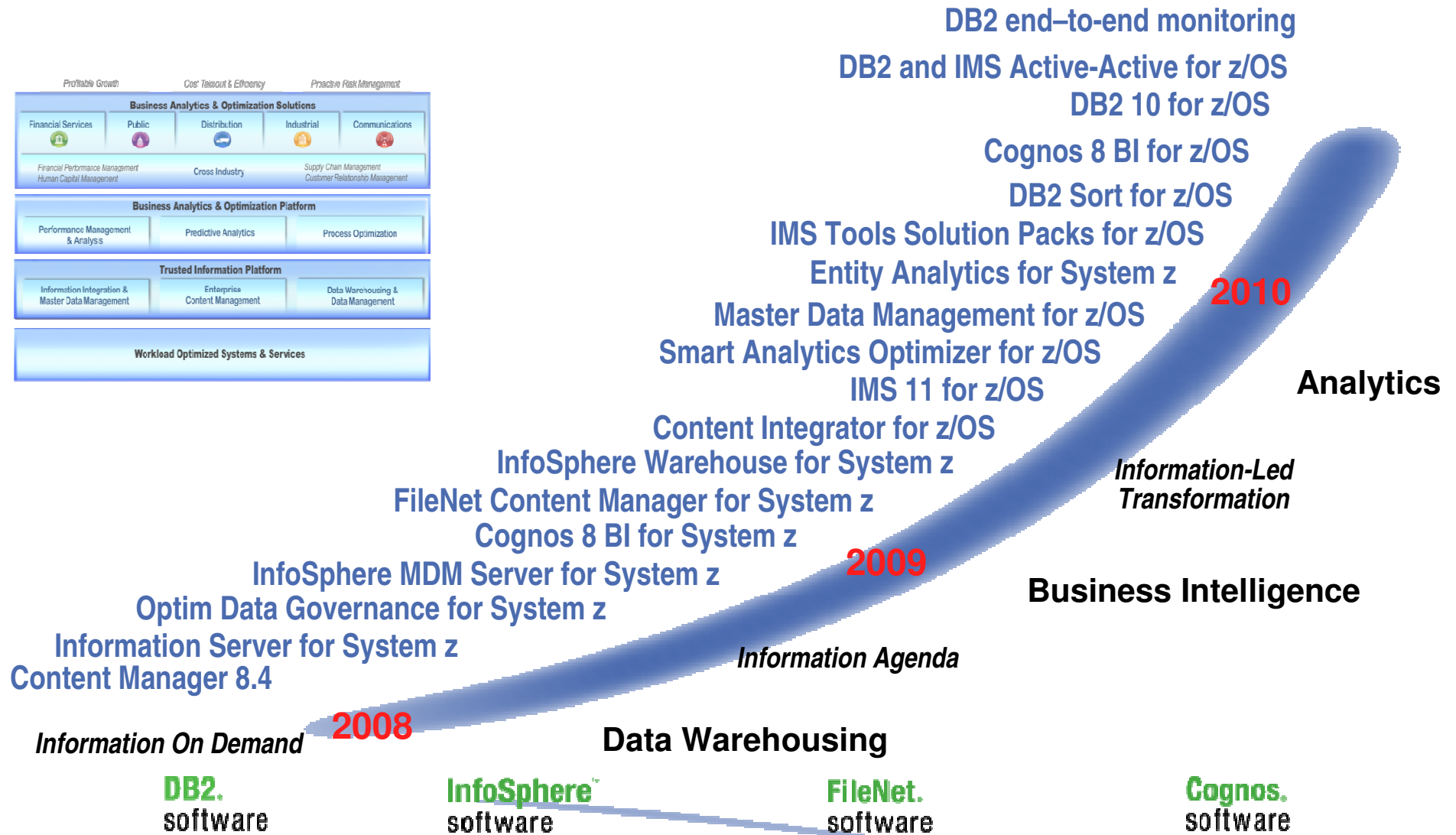
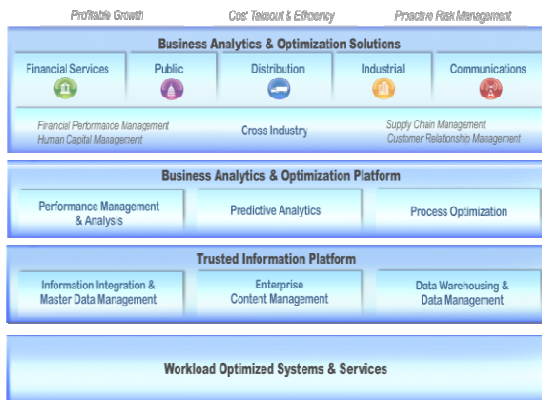



IMS Version 11

Delivering Unsurpassed Application and Data Serving

IMS V11 Key Features Include:

- Open database access support allows any application on any platform to access IMS data directly and transparently; extended Web services and connectivity for SOA
- Enhanced commands and user exits that simplify installation & system management
- Enhanced application development tooling
- Fast Path 64-bit buffer management, expanded storage, & security enhancements that increase performance stability, and reliability as well as improve security

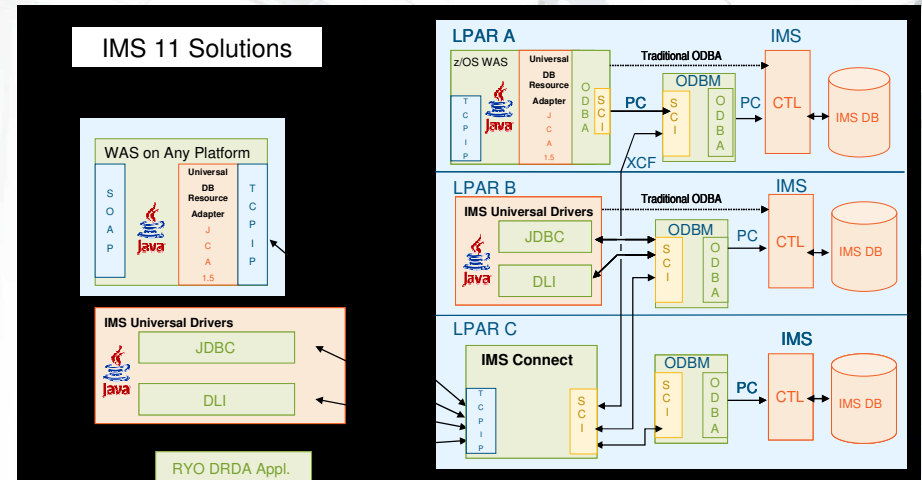

distributed IMS database access support

Database Manager

- IMS Open Database
- Database Quiesce
- ACBLIB Usability
- Database RAS
- OLR Performance
- Fast Path 64-bit Buffer Management

System

- IMS Connect Enhancements
- User Exit Interface
- Dump Formatter
- Syntax Checker & IVP
- LSQA Storage Reduction
- KBLA

Transaction Manager

- Type-2 Query TM Commands
- OTMA Enhancements
- OTMA Type-2 Commands
- Transaction Expiration
- Shared Queues Affinity Routing

DBRC

- BPE-Based DBRC
- Security Override for Non-Production RECON
- Unconditional deletion of PRILOG Information
- DBRC Migration / Coexist from IMS 9 & 10



What's New with Rational on System z

Rational Developer for System z v7.6

- Consolidate and standardize on a single multi-language development environment
- Makes traditional development more attractive to next generation of developers
- Reduce host CPU usage up to 50% with workstation syntax checking and debugging
- New support for RTCz 2.0, CICS TS 4.1, IMS 11, IBM File Manager, and CA Endevor®



Rational Team Concert for System z v2.0

- Cut costs with an agile and multiplatform team infrastructure for software delivery
- Reduce license, maintenance, and administration costs
- Automate and accelerate build and release processes across multiple platforms
- New integration with RDz 7.6

IBM Compilers for COBOL, PL/I and C/C++

- Increase capacity and performance without hardware upgrades
- Reduce cost of COBOL and PL/I XML parsing by offloading to specialty processors
- New Enterprise COBOL for z/OS v4.2
- New z/OS XL C/C++ v1.11
- New Enterprise PL/I for z/OS v3.9





WebSphere Application Server for z/OS

Feature Packs in 2010

- **WebSphere Application Server FEP for OSGI/JPA**
 - Provides a lightweight, simplified application framework that will increase developer productivity and time to value by delivering a simple to use, lightweight programming model for web applications
- **WebSphere Application Server FEP for Java Persistence API (JPA) 2.0**
 - Based on Apache OpenJPA, a leading open source Java persistence framework with IBM enhancements to benefit integration with WebSphere Application Server

z/OS Key Differentiation

Performance

- ✓ Improvements in response time for static and dynamic content with Fast Response Cache Acceleration
- ✓ Increased application runtime performance with focused analysis and code path improvement effort for JEE, Web Services and Connectors.
- ✓ **WOLA Enhancements:**
 - ✓ 2 Phase Commit protocol support for transaction inbound to CICS from WAS
 - ✓ WOLA support for IMS (in addition to CICS, ALCS, COBOL)

High Availability and Reliability

- ✓ High Availability Manager based on Cross-System Coupling Facility (XCF).
- ✓ Thread Hang Recovery improves server reliability and performance.

Consumability and Usability

- ✓ Redesigned data collection facility to improve chargeback capabilities.
- ✓ More unified install and configuration tasks (load modules in HFS).



IBM WebSphere Portal for System z

- **Helping Organizations to Rapidly Respond to Change**
 - Integrates the applications, transactions & data to deliver business value faster
 - Transform Mainframe Applications by providing a new and exceptional user experience
- **System z – Complement to the Portal environment**
 - Portal on z Platform provides a high Quality of Service for those mission critical applications
 - Having the Portal closer in proximity to the data, you are able to achieve better performance and response time
 - System z provides a highly secure, available, and reliable application delivery platform
- **Tight integration with CICS, IMS, DB2, MQ, Websphere Application Server, and Host Access Transformation Services**

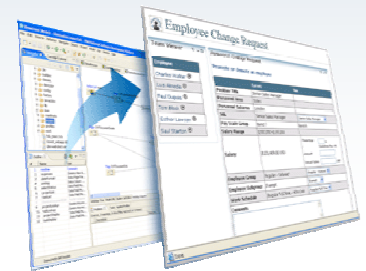
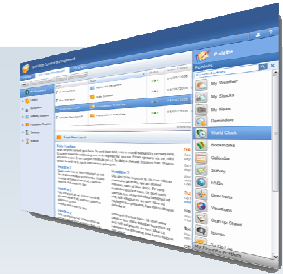

The characteristics that a mission critical PORTAL require are the same characteristics that z Platform was designed for...



Lotus Connections Social Collaboration on 'System z'

- The security of System z, your employee information is protected
- z Platform provides up to 2X improved performance due to robust I/O management and high bandwidth access to social data stores
- Enterprise SOA architecture provide robust application integration environment
- Dynamic allocation of virtual computing resources insures superior response times while driving down admin costs and lower power consumption





IBM ILOG's Business Rules Management Solutions

..... *on System z*

Powerful
**Business Rule
Management System**

Efficient
**Supply Chain
Management Solutions**



Advanced
Optimization Tools

Innovative
**Visual
Tools**

BRMS System z options:

- **Rules for COBOL**
 - Provides the full benefits of JRules BRMS while retaining the existing COBOL architecture
 - Rules are generated as COBOL source for execution in IMS, CICS, batch
- **JRules on System z**
 - Provides BRMS for rule-based applications and extends your SOA strategy while leveraging your System z assets
 - Rules are deployed, executed and monitored in J2EE services



Spotlight: CICS Transaction Server V4.1



- **Compete with insight into business processes and modify business applications quickly**
- **Comply with corporate, industry, and government policies to manage business risk**
- **Control costs by simplifying IT infrastructure and productivity through easier-to-use interfaces & functions**

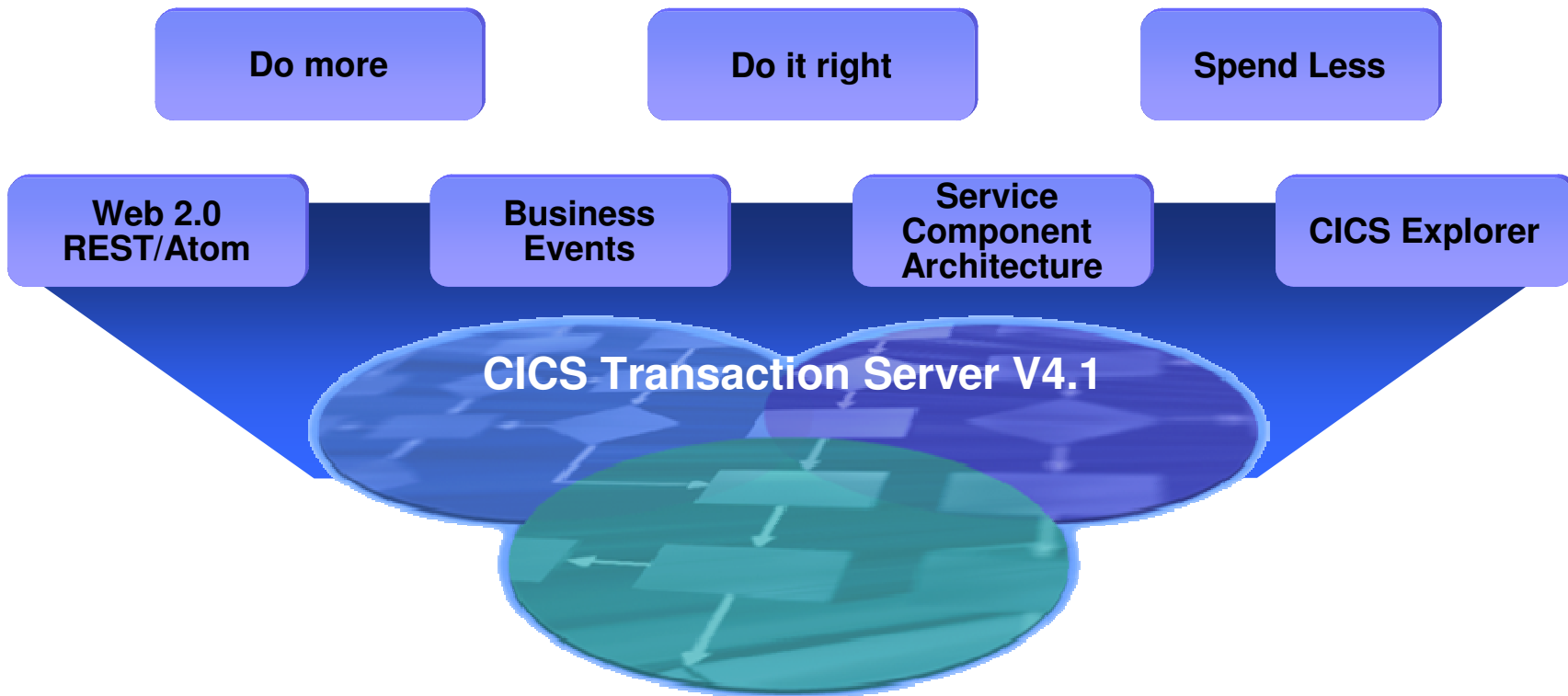



z/OS Version 1 Release 12* ...

... and z/OS Management Facility Version 1 Release 12*

... *simplified management*

- z/OS Management Facility provides more applications and function, and provides more value to operators and administrators.

... *Predicting problems*

- z/OS Predictive Failure Analysis (PFA) is planned to monitor the rate at which SMF records are generated. When the rate is abnormally high for a particular system, the system will be designed to issue an alert to warn you of a potential problem, potentially avoiding an outage.

... *Real-time decision making*

- A new z/OS Run Time Diagnostics function is planned to help you quickly identify possible problems in as little as one minute.

... *Automatic partitioning*

- sysplex components can automatically initiate actions to preserve sysplex availability to help reduce the incidence of sysplex-wide problems.

... *Avoiding data fragmentation and planned outages for data reorganizations*

- With the new CA (Control Area) Reclaim capability, applications that use VSAM key-sequenced data sets (KSDS), benefit from improved performance, minimized space utilization, and improved application availability.

... *Workload driven provisioning*

- Capacity Provisioning is planned to use CICS and IMS monitoring data to determine if additional resources are needed to meet service-level requirements

... *Storage management and scaling*

- Extended Address Volumes are planned to support additional data set types. EAV helps you relieve storage constraints as well as simplify storage management by providing the ability to manage fewer, large volumes.

... *Advanced cryptography*

- Support for Elliptic Curve Cryptography (ECC), Internet Key Exchange version 2 (IKEv2), Federal Information Processing Standard (FIPS) FIPS 140-2, and more.



System z With DB2 Scales Further Than Best HP Superdome Banking Benchmark

- **Asian Bank**
 - IBM System z9 and DB2
 - TCS BaNCS (Cobol)
 - 15,353 Transactions/second
 - 50 Million Accounts
 - IBM benchmark for customer

- **Bank of China ****
 - IBM System z9 and DB2
 - TCS BaNCS (Cobol)
 - 8,024*** Transactions/second
 - 380 Million Accounts
 - IBM benchmark for customer

- **HP/Temenos ***
 - HP Itanium
 - Temenos T24 (Java)
 - 2,153 Transactions/second
 - 13 Million Accounts
 - Largest banking benchmark performance claimed by HP

System z and BaNCS Online Banking Benchmarks

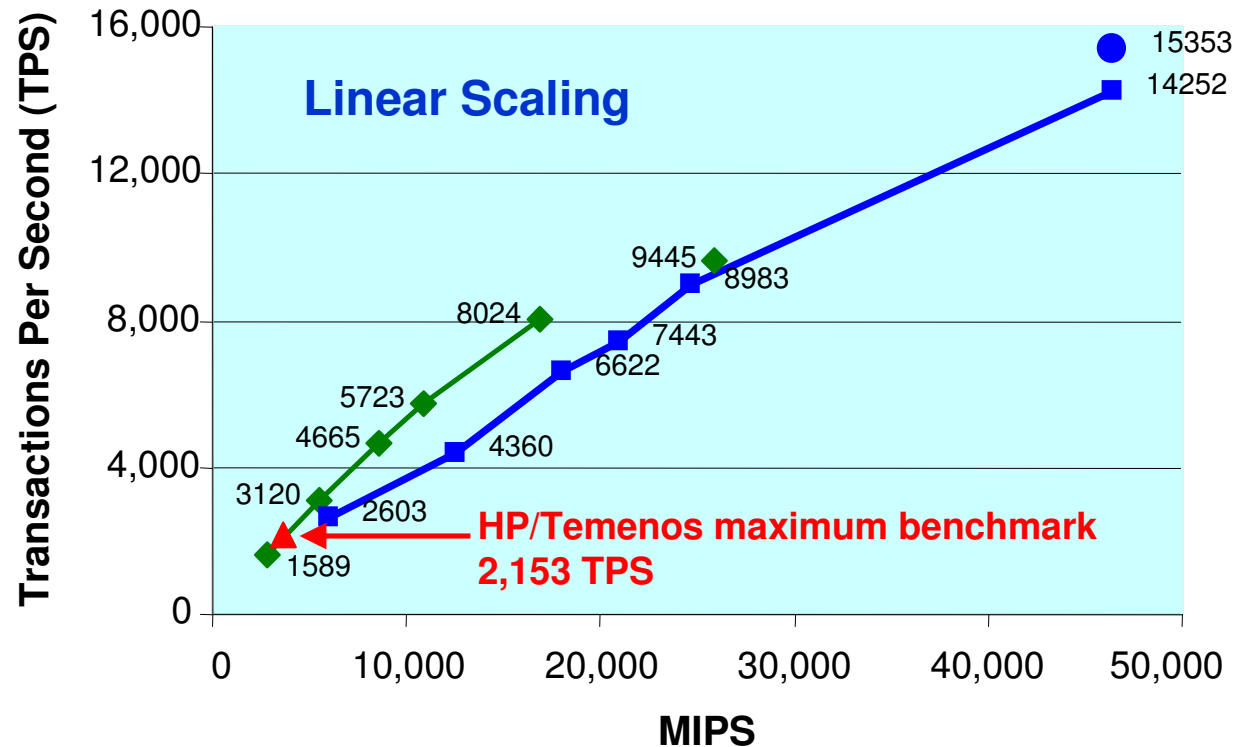

* SOURCE: TEMENOS BENCHMARKS; <http://h71028.www7.hp.com/enterprise/downloads/TemenosBenchmark.pdf>

** SOURCE: <http://www.enterprisenetworksandservers.com/monthly/art.php?2976> Source: InfoSizing FNS BANCS Scalability on IBM System z – Report Date: September 20, 2006

*** Standard benchmark configuration reached 8,024 tps, a modified prototype reached 9,445 tps



System z With DB2 Scales Further Than Best HP Superdome Banking Benchmark, with Java

- **Asian Bank**
 - IBM System z9 and DB2
 - TCS BaNCS (Cobol)
 - 15,353 Transactions/second
 - 50 Million Accounts
 - IBM benchmark for customer

- **IBM Benchmark**
 - IBM System z10, WAS, DB2
 - Temenos TCB (Java)
 - Result of preliminary Temenos TCB optimization prototype

- **HP/Temenos ***
 - HP Itanium
 - Temenos T24 (Java)
 - 2,153 Transactions/second
 - 13 Million Accounts
 - Largest banking benchmark performance claimed by HP

System z and Temenos TCB Online Banking Benchmarks

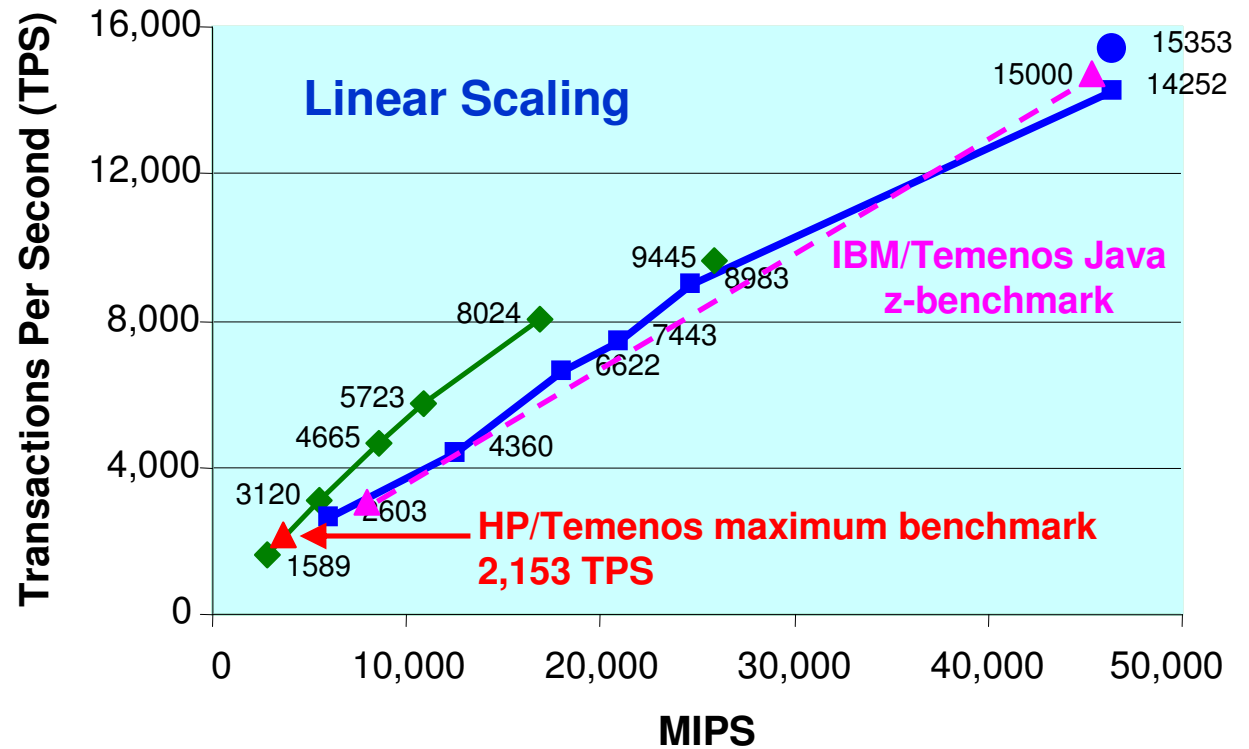

* SOURCE: TEMENOS BENCHMARKS; <http://h71028.www7.hp.com/enterprise/downloads/TemenosBenchmark.pdf>



z/VM Statements of Direction Clustered Hypervisor Support and Guest Mobility

- Provides shared resources for the z/VM systems and virtual machines
- Users can run z/VM system images on the same and/or different System z10 servers
- Simplifies systems management of a multi-z/VM environment
 - Single user directory
 - Cluster management from any system
- Clients can cluster up to four z/VM systems
- in a **Single System Image (SSI)**
 - Apply maintenance to all systems in the cluster from one location
 - Issue commands from one system to operate on another
 - Built-in cross-system capabilities
 - Resource coordination and protection: network and disks
- Dynamically move Linux guests from one z/VM system to another with **Live Guest Relocation**
 - Reduce planned outages; enhance workload management
 - Non-disruptively move work to available system resources **and** non-disruptively move system resources to work

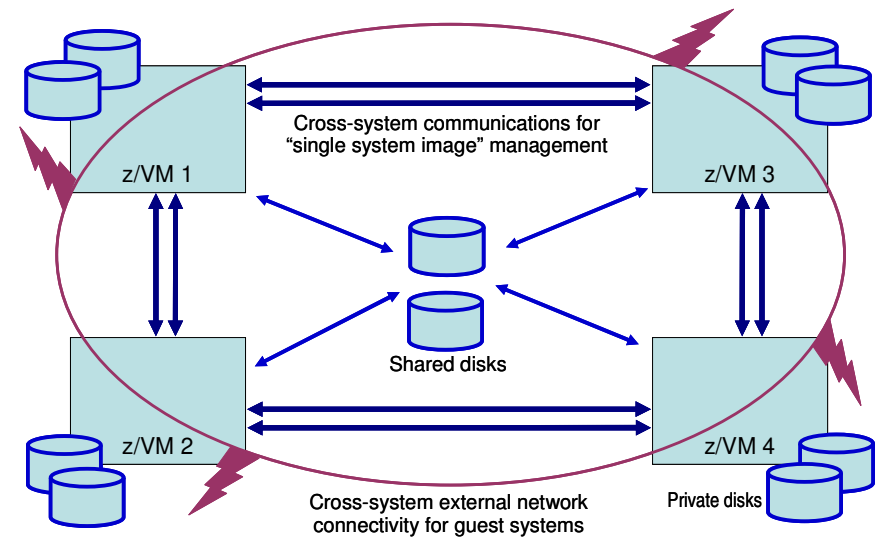



Processing WLM Resources

Prevent large queries from monopolizing a system

Number of critical queries that completed: tripled,
Response times for critical work improved 88% and more.

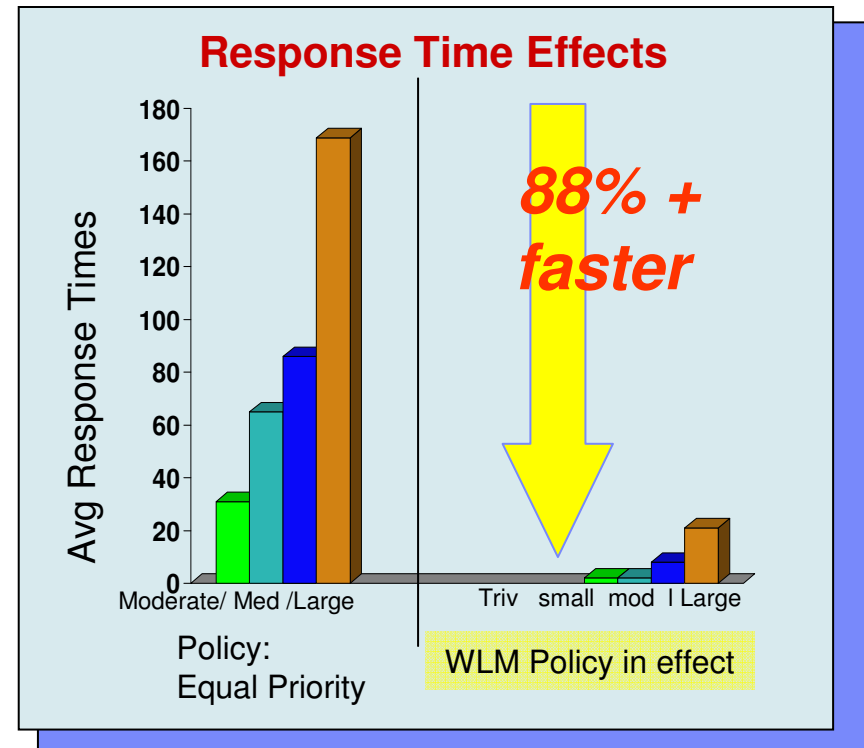
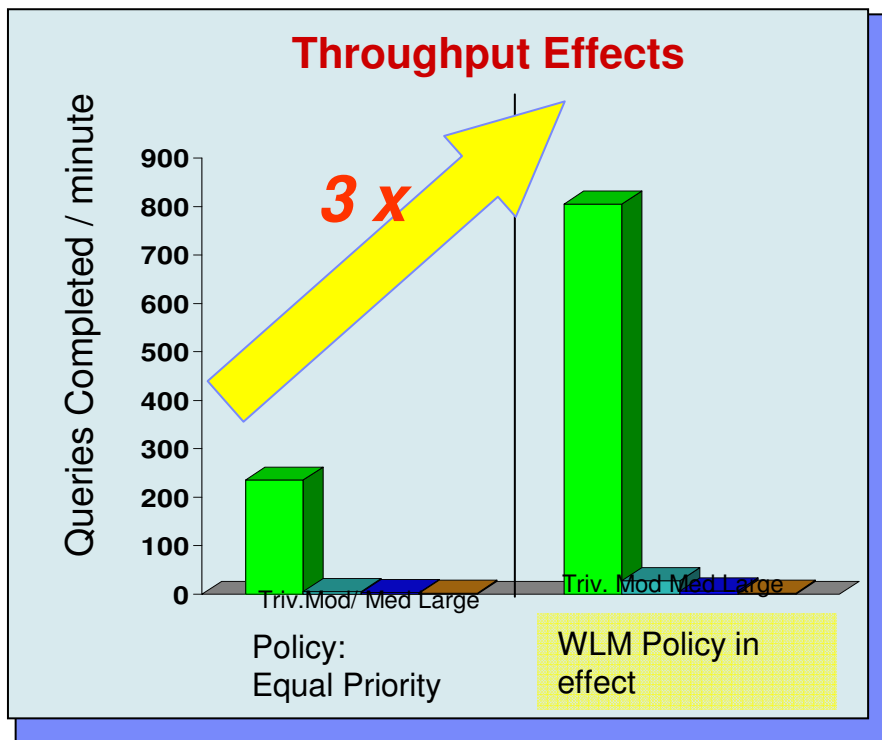



Continuous Batch Processing

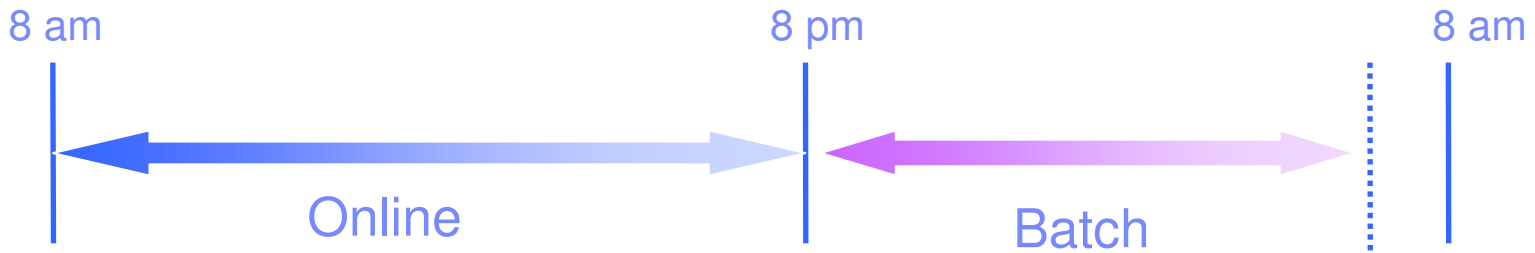

Current Batch Processing Technique

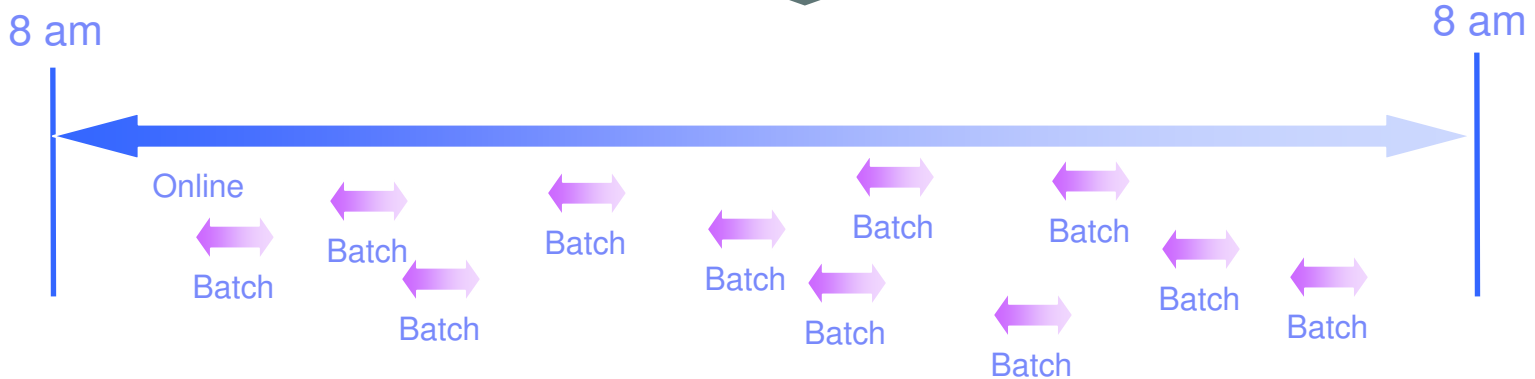

Going forward, Batch Processing Techniques



Fractional Availability Improvements Are Important

Example: Financial Services Company

- \$300B assets, 2500+ branches, 15M customers
- Retail banking, loans, mortgages, wealth management, credit cards
- CRM System – branches, financial advisors, call centers, internet
- Number of users – 20,000+

	Unix/ Oracle	Systemz DB2
Availability %	99.825%	99.975%
Annual outage	15h 20m	2h 11m
Cost of Downtime	\$22.9M	\$3.3M

Sources: ITG Value Proposition for Siebel Enterprise Applications, Business case for IBM System z & Robert Frances Group

Financial Impact of Downtime Per Hour

<i>Industry segment</i>	<i>Cost</i>
Energy	\$2,818K
Telecommunications	\$2,066K
Manufacturing	\$1,611K
Financial	\$1,495K
Information Technology	\$1,345K
Insurance	\$1,202K
Retail	\$1,107K
Pharmaceuticals	\$1,082K
Banking	\$997K
Consumer Products	\$786K
Chemicals	\$704K
Transportation	\$669K



Active/Active – What is it ?

- Two or more sites, separated by *unlimited* distances, running the same applications and having the same data to provide cross-site workload balancing and Continuous Availability / Disaster Recovery
- Paradigm shift: failover model => near continuous availability model

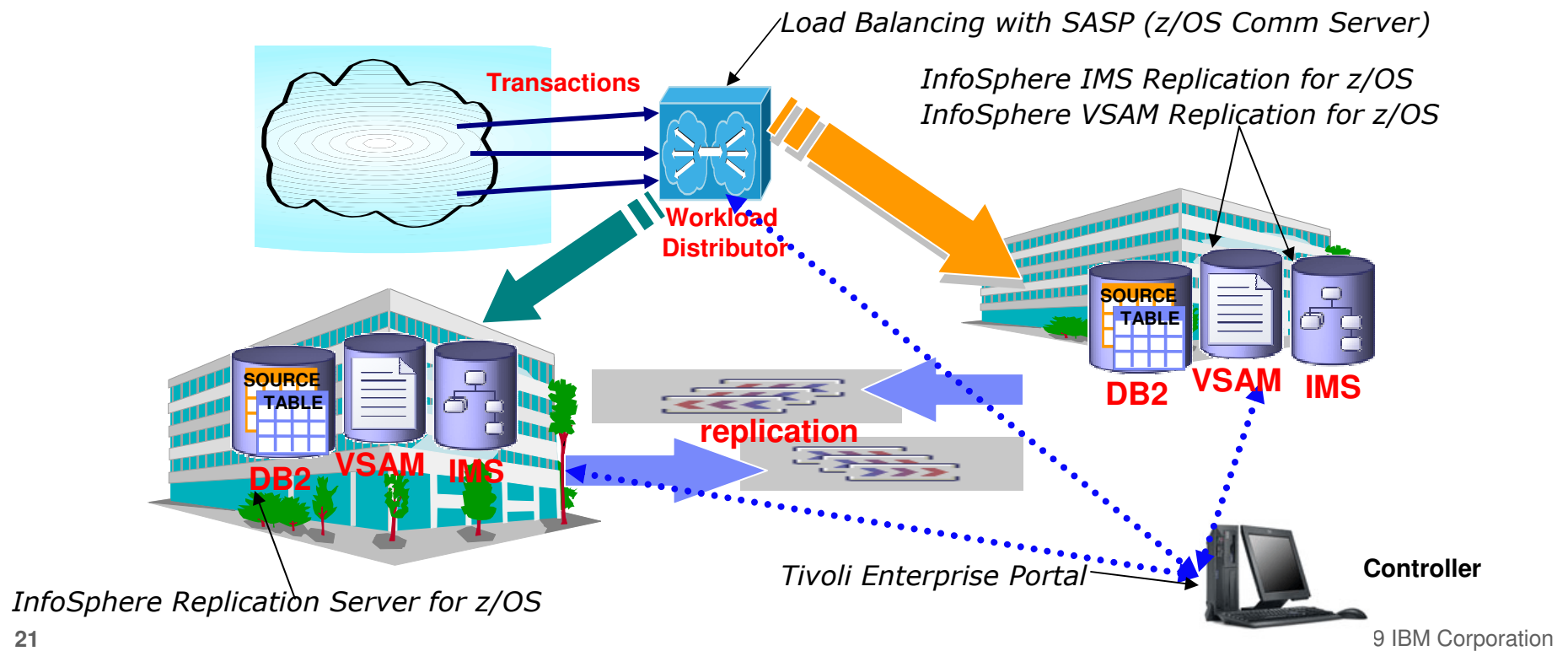

InfoSphere Replication Server for z/OS



High Cost of Security Breaches

- Average cost of security breaches continues to rise according to a 2008 Ponemon Security Study
- Average costs of a data breach: \$202 *per record*
 - ▶ Average total: \$6.6M *per breach*
 - ▶ Cost of lost business: on average \$4.59 M
 - ▶ Over 84% of organizations had over one breach
- Each breach involved paper notifications wasting energy and paper
 - Worst of all, damages company reputation

Costs per Breach

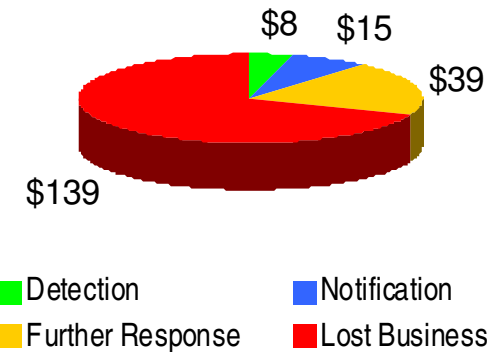

Notifications also consume at least one ton of paper!



(You don't see System z cited on front page news covering security breaches.)



A complete digital certificate solution

z/OS PKI Services

- **Alleviate need to pay a third party Certificate Authority**
 - z/OS PKI Services is a Certificate Authority solution in z/OS
 - Leverage z/OS skills and resources to address your certificate needs
- **Provides full certificate life cycle management**
 - Generate certificates for end users, network devices, browsers, and servers
 - Administration, approval, renewal, and revocation processes can be automated
- **PKI Services, many updates over the years!**
 - Improved automated e-mail notification for certificate requests, renewals, expirations (1.9)
 - Support for Unicode (UTF8 subset) – helps improve compatibility with existing CAs. (1.10)
 - New key archival/recovery capabilities – provides a backup process for recovery of keys (1.11)
 - Support for ECC keys (in addition to RSA and DSA), automation to find unused cert. serial numbers, support for Certification Management Protocol (CMP) for integration with existing Certificate Authority solutions (planned, R12*)

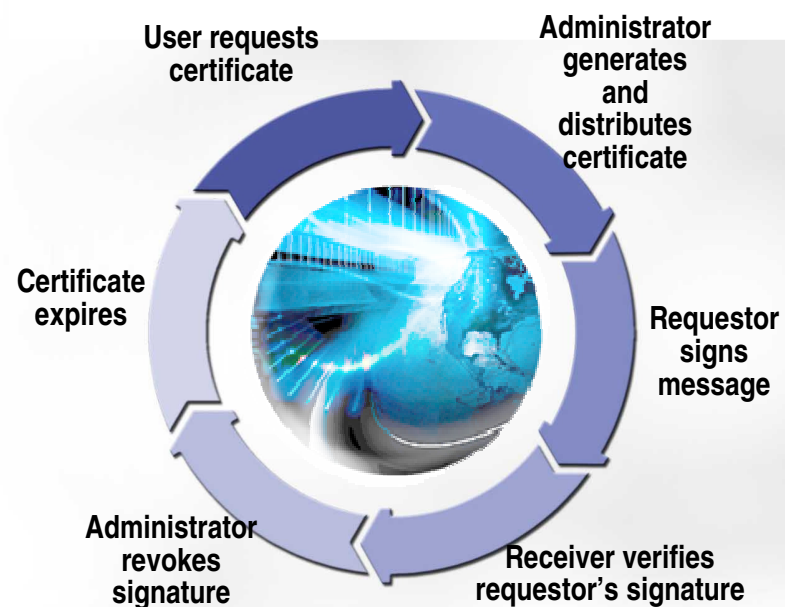

Example of feedback

Used by a large bank to help secure connection between data center and branch offices - *Saved an estimated \$16M a year*



New York Financial Services Company – Useful Lifetime Of 36 Month Lease

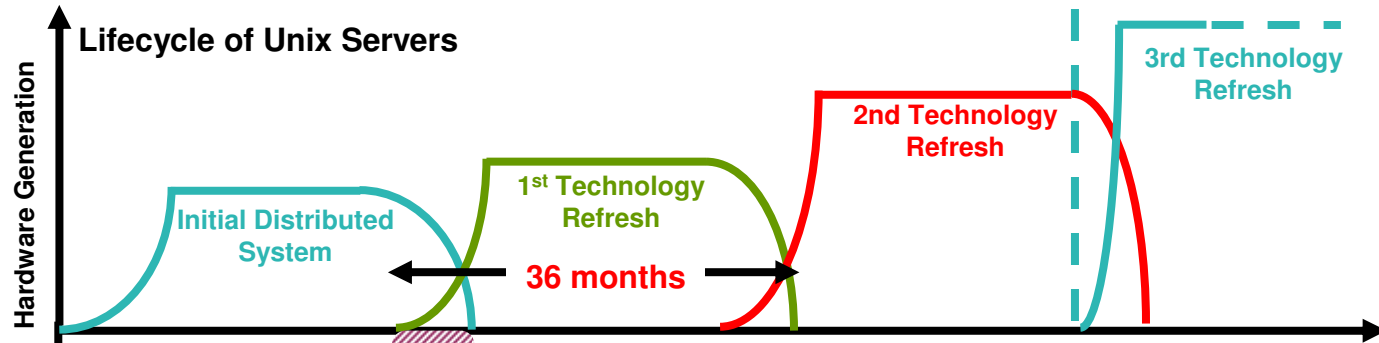

Observed at a large financial service customer

In each 36 month lease there are only 30 months production use

6 months provisioning
 30 months production
Setup and tear down 15 People, 5 full time

Setup and tear-down time costs 25% more. Plus . . . 41 hours of FTE setup and tear down labor per server = \$3,075

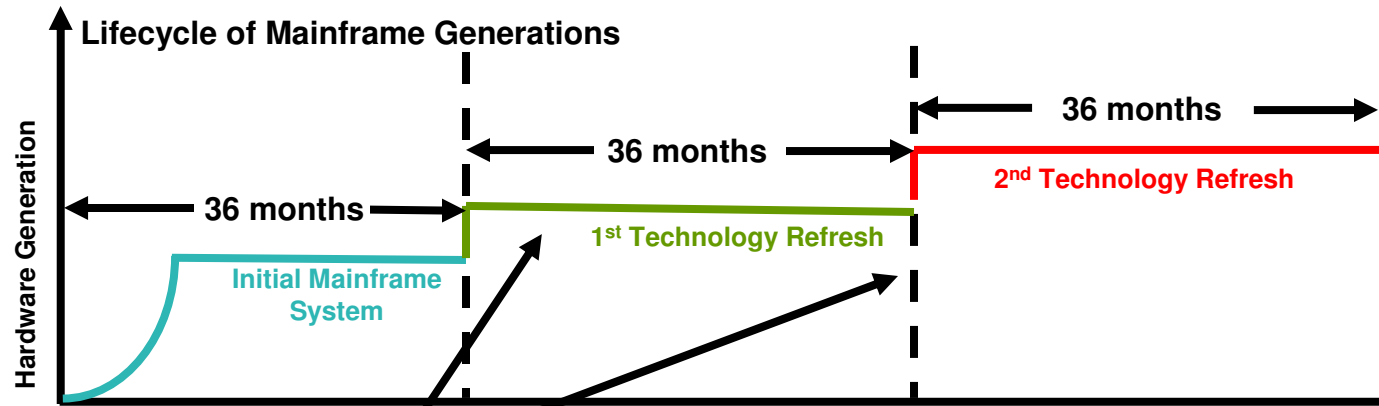

1 Weekend upgrading to new hardware and software levels
 36 months production
 No need to retire the server, upgrade in place

Weekend upgrades performed by IBM

Capacity on demand pricing



Simplified usage of On/Off Capacity On Demand

Efficient management of System z10 server capacity

- **z/OS Capacity Provisioning Manager**
 - Manual or automatic monitoring, activation, and deactivation of On/Off Capacity on Demand
 - You set the policies!
- **Capacity management challenge**
 - Events and workload spikes can be unexpected
 - Manual capacity management may be time-consuming or subject to some error
 - Flexibility - can activate OoCoD incrementally even in combination with CBU
 - Efficiency – policy based capacity management
 - Familiarity – modern GUI that uses RMF and CIM to gather system metrics
 - With z/OS V1.11 – now uses BCPii base component, TCP/IP connections not needed for connections to HMC or Support Element.
 - Planned for z/OS V1.12* -- Workload driven provisioning for CICS and IMS workloads.

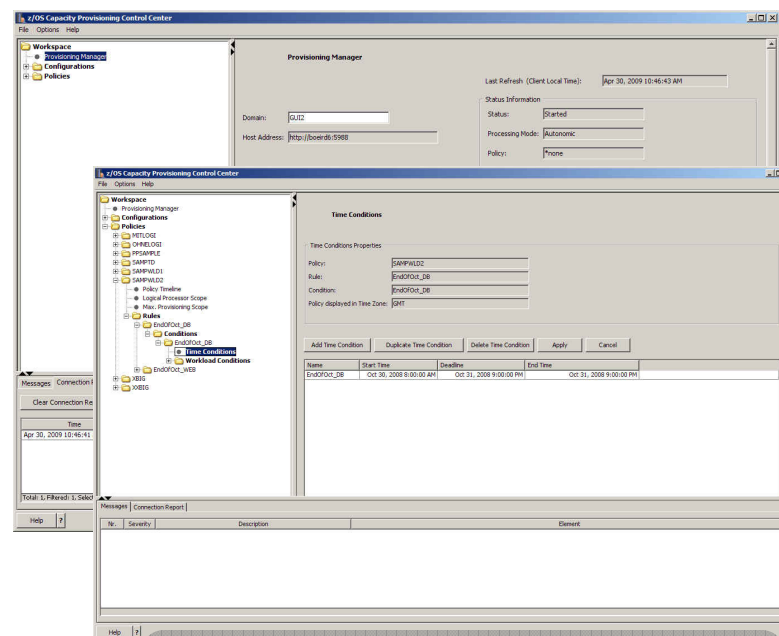

**Great Capacity Provisioning demo
at the IBM DEMOzone
www.demos.ibm.com**

<http://www-03.ibm.com/servers/eserver/zseries/zos/wlm/cp/>



Tivoli Service Automation Manager (TSAM)

- **Deploying & managing Cloud Services in a datacenter environment**
 - Dynamic instantiation and management of Cloud Services along their entire lifecycle
- **Raises the level of abstraction for Service Management in data centers from single LPARs, storage volumes, SW installations to Cloud Services as the units of management**
- **Integrated Management Solution**
 - Based on strategic Tivoli Process Automation Engine (TPAE)

The holistic view of a service...

...is more than the sum of its individual parts

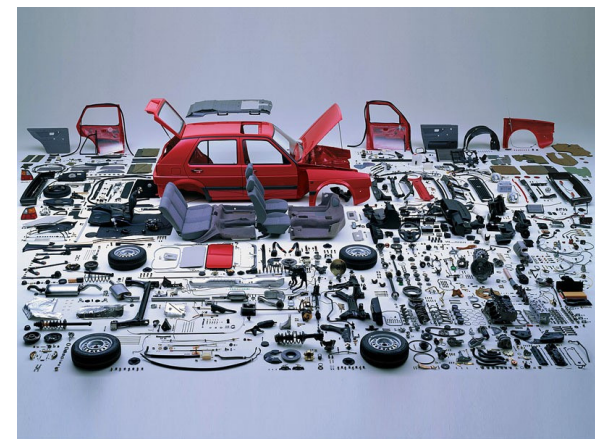



Summary

- We are delivering a New Generation of z software and hardware
- SOA and System z together, extend and leverage decades of massive business investments
- The z ecosystem now enables leap frogging to the Next Generation of Applications
- System z is being re-architected for Enterprise Data Serving
- It's all about the economies of scale and how System z capabilities and 'Quality of Service' makes a difference





THANK
YOU