

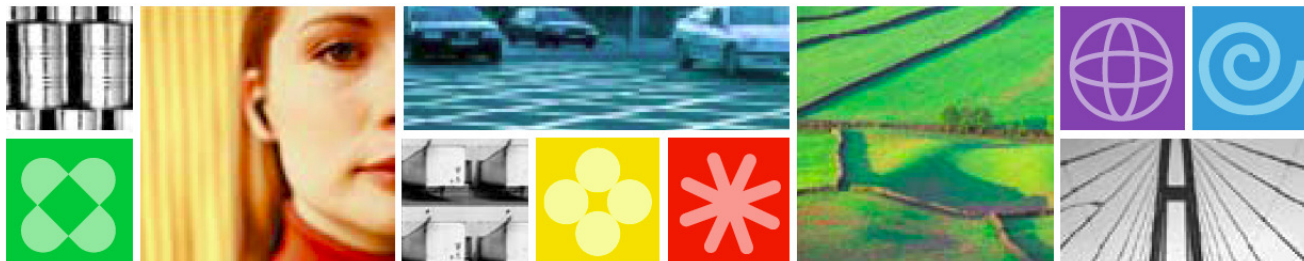

# DB2 for z/OS: Reducing Business Costs and Increasing Business Value

## System Z Premier Event

Jeff Josten  
Director, DB2 for z/OS





# Disclaimer/Trademarks

Information concerning non-IBM products was obtained from the suppliers of those products, their published announcements, or other publicly available sources. IBM has not tested those products and cannot confirm the accuracy of performance, compatibility, or any other claims related to non-IBM products. Questions on the capabilities of non-IBM products should be addressed to the suppliers of those products.

**The information on the new product is intended to outline our general product direction and it should not be relied on in making a purchasing decision. The information on the new product is for informational purposes only and may not be incorporated into any contract. The information on the new product is not a commitment, promise, or legal obligation to deliver any material, code or functionality. The development, release, and timing of any features or functionality described for our products remains at our sole discretion. \***

This information may contain examples of data and reports used in daily business operations. To illustrate them as completely as possible, the examples include the names of individuals, companies, brands, and products. All of these names are fictitious, and any similarity to the names and addresses used by an actual business enterprise is entirely coincidental.

Trademarks The following terms are trademarks or registered trademarks of other companies and have been used in at least one of the pages of the presentation:

The following terms are trademarks of International Business Machines Corporation in the United States, other countries, or both: AIX, AS/400, DataJoiner, DataPropagator, DB2, DB2 Connect, DB2 Extenders, DB2 OLAP Server, DB2 Universal Database, Distributed Relational Database Architecture, DRDA, eServer, IBM, IMS, iSeries, MVS, Net.Data, OS/390, OS/400, PowerPC, pSeries, RS/6000, SQL/400, SQL/DS, Tivoli, VisualAge, VM/ESA, VSE/ESA, WebSphere, z/OS, zSeries

Microsoft, Windows, Windows NT, and the Windows logo are trademarks of Microsoft Corporation in the United States, other countries, or both.

Intel and Pentium are trademarks of Intel Corporation in the United States, other countries, or both.

UNIX is a registered trademark of The Open Group in the United States and other countries.

Java and all Java-based trademarks are trademarks of Sun Microsystems, Inc. in the United States, other countries, or both.

Other company, product, or service names may be trademarks or service marks of others.



# Agenda Topics for Today

- **Business Overview**
- **Field Update on DB2 9**
- **DB2 X**
- **Questions**



## Top Challenges



1. Reducing Costs of Information Technology
2. Continuous Service Availability
3. Boost Business Resilience and Reduce Risks
4. Deliver Differentiating Innovative Solutions
5. Security, Auditing and Regulatory Compliance
6. Accessing intelligent information on demand



# DB2 for z/OS Technical Strategy

## ➤ **Extend the lead in availability, scalability and performance.**

- Parallel Sysplex: the best scale-out solution in the industry
- Tight integration between DB2 and the System z hardware and z/OS operating system
- Advanced solutions for compliance with data security and privacy regulations
- Workload consolidation: System z is the ultimate consolidation platform
- Eliminate all causes of outages

## ➤ **Reduce cost of ownership**

- Database technology that can handle large workloads with fewer people
- Storage and CPU optimization, including specialty engines
- Advanced autonomies to make the system more self-managing and self-tuning

## ➤ **Application enablement**

- Apps can easily connect to DB2 from anywhere
- Advanced SQL, XML capability, application portability

## ➤ **Improved data warehousing capabilities**



# DB2 for z/OS Into the Future

Delivering Customer Value

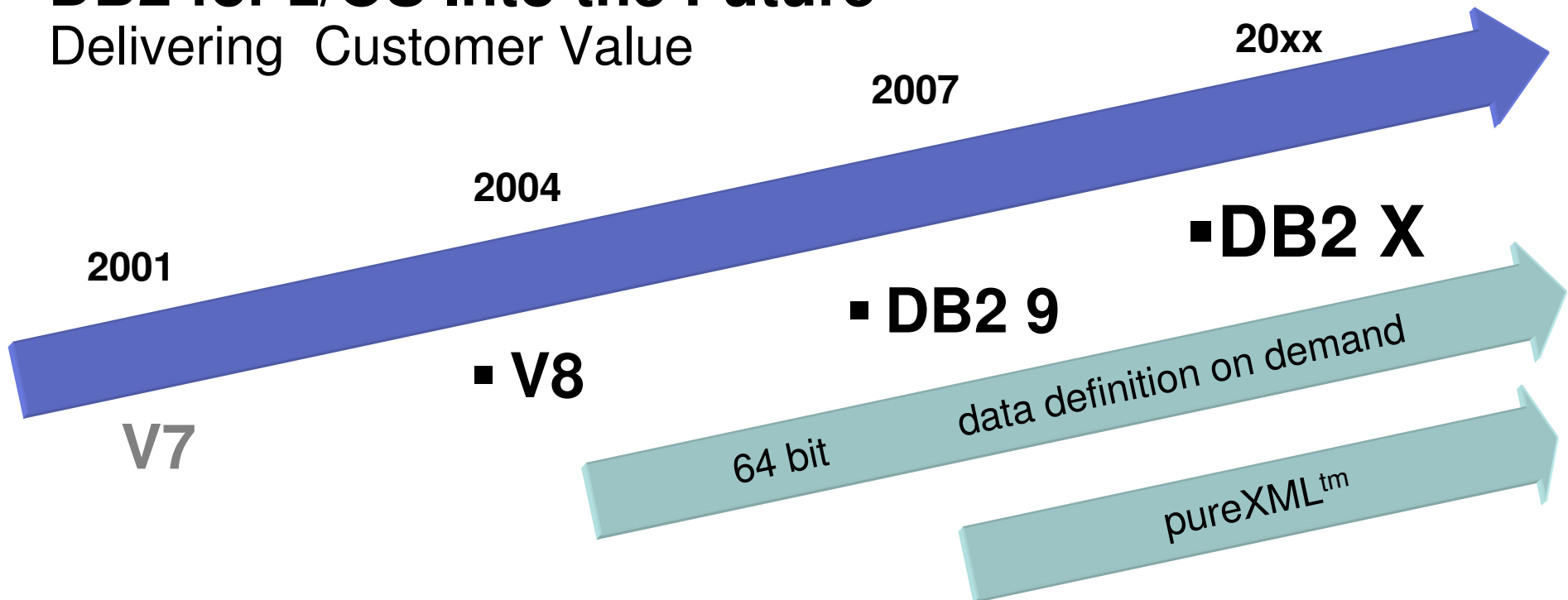

## Themes

Reliability Availability Serviceability  
Performance Scalability  
Security Productivity  
Application Development  
SQL XML SOA



# DB2 9 Field Update



## DB2 9 for z/OS field update

- **DB2 9: Climbing Sharply**
  
- **DB2 V8: Migration finishing in most of world**
  - **100% of Top 100            99.5% of Top 200**
  - **V7 End of Service: June 30, 2008**
  - **V8 Withdrawal from Marketing**
    - **Announced: Dec. 2, 2008**
    - **Effective: Sept. 8, 2009**
  
- **How's the Quality (compared to V8)?**
  - **Lower overall PMR volume**
  - **Less Severity 1 APARs**
  - **Lower PE rate**

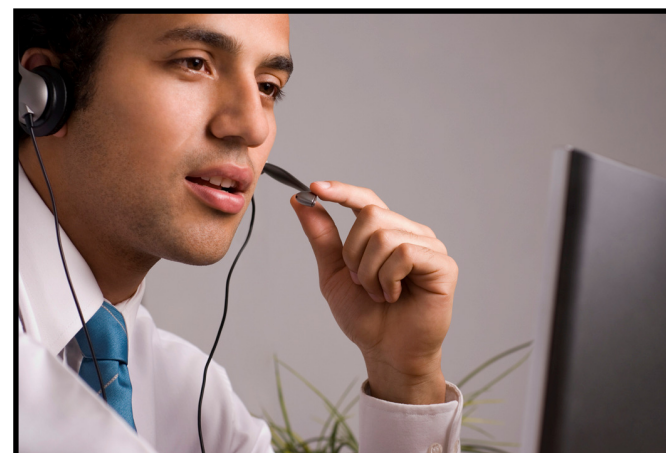





# Best Practices When Going to DB2 9

- **Leverage CST/RSU process: Start with latest RSU + Identified Hipers**
  - Apply 2 to 3 preventative service drops annually
  - Exploit Enhanced HOLDDATA to be vigilant on HIPERs and PEs
  
- **Use the DB2 9 'Package Stability' function for static SQL**
  - Offers access path preserving option. Recovers to prior access path if regression is encountered
  
- **Minimize potential query performance issues**
  - Use Optimization Service Center to capture SQL statements
  - Run Stats Advisor to generate the recommendation for stats collection
  - Run RUNSTATS to ensure critical stats are collected as recommended by the advisor
  
- **Every customer experience is different**
  - Contact your local DB2 Advisor for current information
  
- **Ensure an PMR is opened prior to migration start**



# Casas Bahia and DB2 9 for z/OS

- 👍 Migration is much easier compared to Version 8
- 👍 Migration process in phases helps your planning and it gives you more confidence during the whole process

“We turned to NFM in a Monday morning, few minutes before business hours...”





# DB2 X



# DB2 10 for z/OS At a Glance

## *Addressing Corporate Data Goals*

<b>Application Enablement</b>	<ul style="list-style-type: none"><li>• pureXML enhancements</li><li>• Temporal queries</li><li>• Last Committed reads</li><li>• Timestamp with timezone</li><li>• SQL improvements that simplify porting</li></ul>
<b>RAS, Performance, Scalability, Security</b>	<ul style="list-style-type: none"><li>• Wide range of performance improvements</li><li>• More online schema changes</li><li>• Catalog restructure for improved concurrency</li><li>• Fine grained access control</li><li>• Hash access to data</li><li>• New DBA privileges with finer granularity</li></ul>
<b>Simplification, Reduced TCO</b>	<ul style="list-style-type: none"><li>• Full 64-bit SQL runtime</li><li>• Auto stats</li><li>• Data compression on the fly</li><li>• Query stability and management enhancements</li><li>• Reduced need for REORG</li><li>• Utilities enhancements</li></ul>
<b>Data Warehousing</b>	<ul style="list-style-type: none"><li>• Moving sum, moving average</li><li>• Many query optimization improvements</li><li>• Query parallelism improvements</li><li>• Advanced query acceleration</li></ul>



## DB2 10 for z/OS: Out-of-the-Box Savings

### Up to 20% CPU reductions for transactions, queries, and batch

- Out-of-the-box CPU reductions of 5-10% for traditional workloads
- Out-of-the-box CPU reductions of up to 20% for new workloads
- Up to additional 10% CPU savings using new functions

### Scales with less complexity and cost

- 5-10x more concurrent users – up to 20,000 per subsystem
- Significant scale-up capabilities in addition to existing scale-out support
- Consolidate to fewer LPARs and subsystems

### Improved operational efficiencies and lower administration cost

- Automatic diagnostics, tuning, and compression

### Even better performance

- Elapsed time improvement for small LOBS and Complex Queries





## DB2 10 Performance Objective

- Historical goal under 5% performance regression
- Goal 5% -10% initial performance improvement
- Many customers reduce CPU time 10% - 20%

### Average %CPU improvements version to version

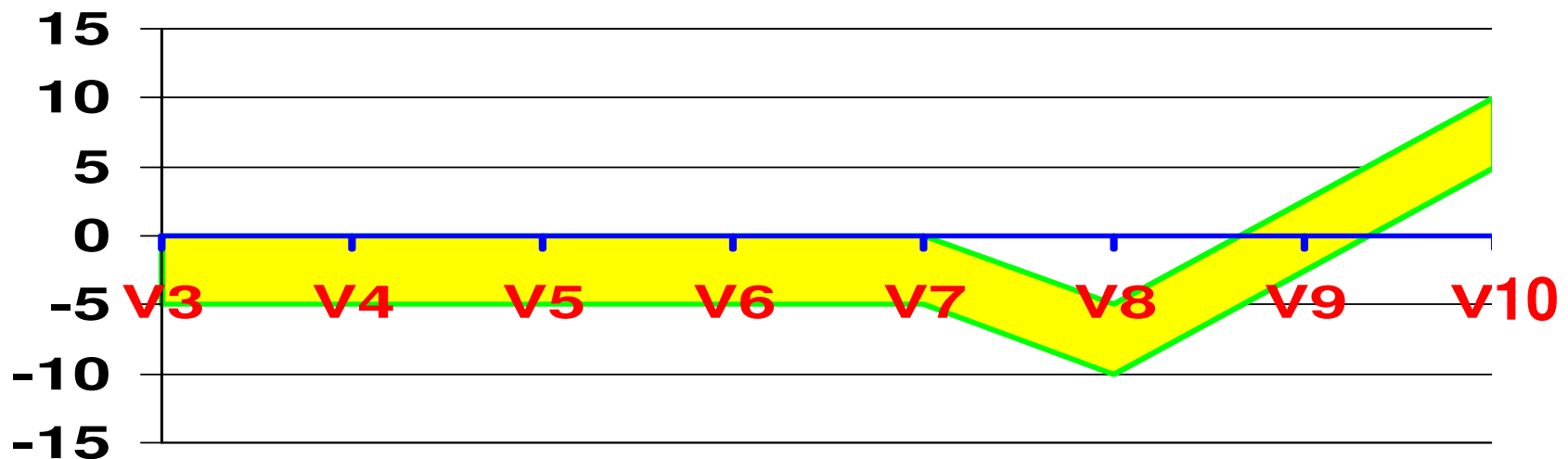



# Performance

- Internal performance optimizations – Improvements Day 1
  - Improved CPU cache performance
  - Exploit new z10 z/Architecture instructions
  - Streamlined DDF, RDS, DM, Index Mgr. performance-critical paths
  - Buffer pool enhancements: utilize z10 1MB page size
  - Virtual Storage Relief (64 bit exploitation)
  - New Access Path possibilities
  - No application changes required!
  
- Performance Improvements with NFM
  - Hash access path
  - Index include columns
  - Inline LOBs
  - Efficient caching of dynamic SQL statements with literals
  - Exploitation of Solid State Disk (SSD)



# Business Security & Compliance Needs

- **Simplify compliance**

- Simpler, easier security privileges with finer granularity authority
- Ability to have administrators without data access, better auditing



- **Fine grained access control**

- Allow masking of value
- Restrict user access to individual cells

*Use disk encryption*





# Scalability

- **DB2 scales to support the largest business needs**
  - 64 bit support: DB2 has supported 64-bit addressing since V6 ('99)
  - DB2 thread storage remains in the 31-bit region
    - Can limit number of active threads per DB2 member
    - Customers scale by adding DB2 members
- **DB2 10 moves thread storage to the 64-bit region**
  - 5-10x more threads per DB2 region
  - More concurrent work
  - Reduce need to monitor
  - Able to consolidate LPARs
  - Reduced cost
  - Easier to manage
  - Easier to grow

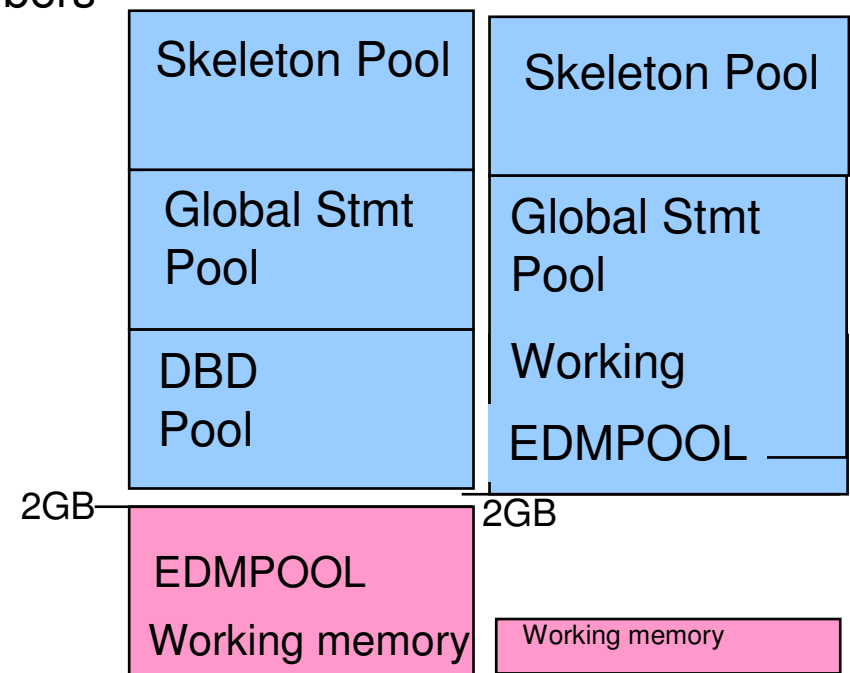



# Running a Large Number of Threads

## Today

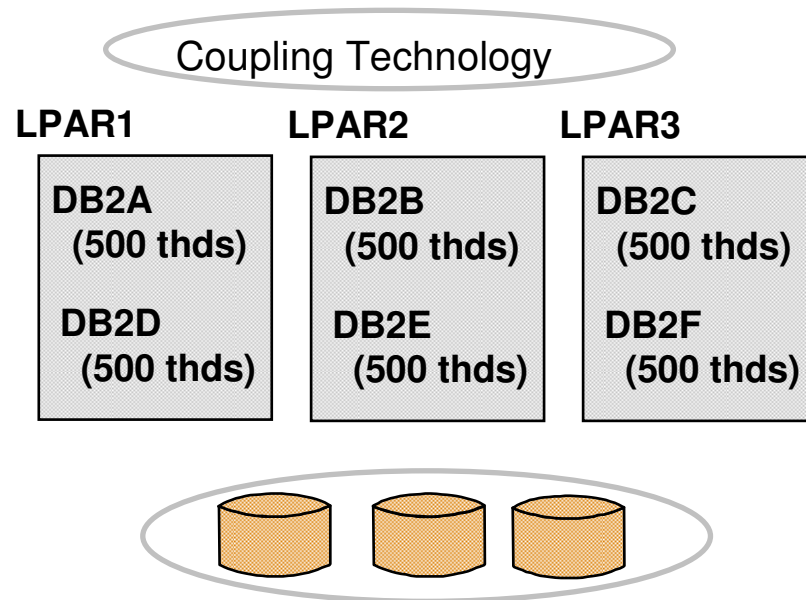

- Data sharing and sysplex allows for efficient scale-out of DB2 images
- Sometimes multiple DB2s / LPAR

## DB2 10

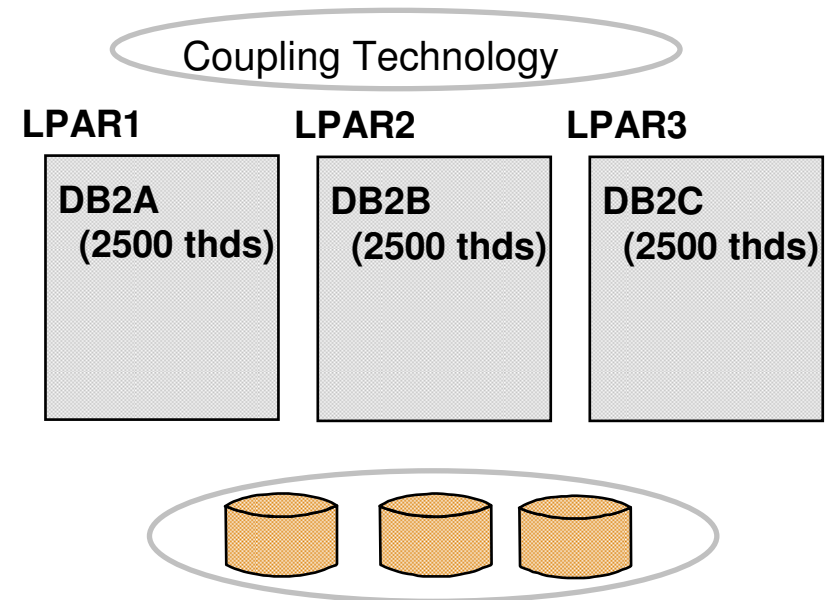

- More threads per DB2 image
- Potential for fewer members / LPARs
- More efficient use of large n-ways
- SSI constraints are relieved
- Easier growth, lower costs, easier management
- Data sharing required for continuous availability and XL scale



# Academic Initiative System z Milestones

- ✓ 608 schools, over 50,000 students in 61 countries worldwide
- ✓ 13 Student Contests in 13 countries with 14,672 students from 1,956 schools
- ✓ IBM Student Opportunity System (Student resume database)
- ✓ Entry Level Mastery Test (Validate student skills)
- ✓ Community involvement (Roundtables, partnerships, hiring)
- ✓ Access to Mainframes worldwide for teaching (6 University hubs)
- ✓ 30 Courses available (foundational to advanced), Ongoing faculty education
- ✓ More educators and students are embracing IBM Enterprise Systems
- ✓ Students are getting jobs



***“‘Master the Mainframe Contest’ helped me get a job at Bank of Montreal.”***

Elizabeth Bell, Georgian College

IBM | Information |  
ON Demand 2009



# DB2 for z/OS enables Application Development, Drives Innovation !

## Leveraging Technologies and Communities

- Use new converged SQL & Optim Studio tooling
- Key Database Technologies
  - SQL, SQL Procedures
  - XML
  - SOA, Web Services
- Developer communities
  - COBOL, PL/I, C, C++, assembler
  - REXX, APL2, Fortran
  - Java (JDBC / SQLJ)
  - .NET (C#, VB .NET)
  - Open Source
    - PHP
    - Perl
    - Python
    - Ruby on Rails
    - TOAD for DB2
  - Rational Developer for Z
  - WebSphere Developer for Z



*Design, develop, deploy,  
operate, optimize and govern  
enterprise data throughout its  
lifecycle*





# Integrated XML Support

- Declarative language, reduce complexity, dramatically improve application development
- Directly store and query XML in inherent hierarchical format
  - No decomposition/composition
  - No normalize/de-normalize
- Native processing with good XML index design = high performance
- Ideally suited
  - Versatile schemas that are diverse and evolve, and end-user customizable applications
  - Sparsely populated attribute values (null vs. absence)
- Manage XML data with ACID properties, auditing and regulatory compliance, together with relational data



# Temporal Data – Need to Query ‘AS OF’

## Temporal Query & Business Timestamp

- Table-level specification to control data management based upon time
- Two notions of time:
  - **System time:** notes the occurrence of a data base change
    - “row xyz was deleted at 10:05 pm”
    - Query at current or any prior period of time
    - Useful for auditing and compliance
  - **Business time:** notes the occurrence of a business event
    - “customer xyz’s service contract was modified on March 23”
    - Query at current or any prior/future period of time
    - Useful for tracking of business events over time, application logic greatly simplified
- New syntax in FROM clause to specify a time criteria for selecting historical data



# End Users & DBAs: Simpler, Easier, More Productive

- **Performance**
  - General performance enhancements
  - Hash Access, Inline LOBs
  
- **Workload is growing, while resources are shrinking**
  - CPU reductions without programming
  
- **I need to be more productive**
  - More online schema changes
  - Catalog restructure for improved concurrency
  
- **I need to be able to recover faster**
  - Query stability enhancements
  - Plan Stability



## DB2's Deep Synergy With System z

The key is leveraging integration points throughout the system

- Data sharing (availability and scale out)
- Instruction set and memory structure
- Hardware data compression
- zIIP specialty engines
- Unicode conversion
- Encrypted TCP/IP communication (SSL), encrypted data
- Cross-memory, memory protection keys
- Sorting
- Multi-core, large N-way
- 1 MB page size (z10 – DB2 VX)
- Decimal float arithmetic (z10)
- 64-bit addressing and large memory
- z/OS Workload Manager
- z/OS Security Server (RACF)
- z/OS RRS integrated commit coordinator







# DB2 for z/OS & IBM zIIP Continued Value

Portions of DB2 V8 and **DB2 9 (blue)** workloads may benefit from zIIP\*:

ERP, CRM, Business Intelligence or other enterprise applications

- Via DRDA over a TCP/IP connection
- **DB2 9 for z/OS Remote native SQL procedures**
- **DB2 9 XML parsing via DRDA to fully utilize zIIP**



Data warehousing applications\*: Large parallel SQL queries

**DB2 9 higher percentage of parallel queries eligible for zIIP**

**DB2 Utilities LOAD, REORG & REBUILD** maintaining index structures



**Today's  
News...**

# IBM Smart Analytics Optimizer

## Delivering Powerful Analytics to Existing Systems...Technology Preview

### **High Performance Extension**

- Order-of-magnitude faster, predictable analytic response times
- Less Administration & Lower Operating Costs

### **Application Transparency**

### **Extends System z Availability & Security & Skills to Smart Analytics Workloads**



### **Creates New Opportunities for Existing Systems By Using New Technology Approaches**

- Exploits In-memory techniques
- Leverages vector processing
- Evaluates predicates in parallel
- Employs new scanning strategies
- Minimizes need for indexes & related administration

\* Based on IBM Laboratory Tests. Actual results may vary depending on specific environment and configuration.



# Information Management Software for z/OS Solutions Information Center

- Find the latest product information for DB2® for z/OS®, IMS™, DB2 QMF™, IBM® DB2 and IMS Tools, Replication and Event Publishing, and Data Warehousing and Analytics.
- Learn how to use the information center by taking the animated tours that are available from the home page.
- Subscribe to RSS feeds for automatic notification of updates; information is frequently updated.
- Find troubleshooting information (search for Technotes, APARs, PTFs, and IBM Redbooks).
- Find product information through Google searches.

The screenshot shows the 'Information center home' page. At the top, it says 'Information Management Software for z/OS Solutions Information Center'. Below this is a welcome message: 'Welcome to the IBM® Information Management Software for z/OS® Solutions Information Center where you can find all the information that you need to install, configure, maintain, and use IBM products for managing your information on z/OS.' There are several links and sections: 'Order an installable version of this information center' (with a 'NEW' tag), 'Tour the information center', and 'Subscribe to information center updates' (with an RSS icon). The page is divided into two main columns. The left column has sections: 'In this information', 'Getting started' (with links for 'What's new in the information center', 'Subscribe to information center updates', 'Navigating in the information center', 'Searching in the information center', 'Searching from external sources', 'Planning for DB2® QMF™ Version 9', 'Planning for IMS™ Version 10', 'Replication and event publishing solutions', and 'Data warehousing and analytics solutions'), and 'Supported products' (with a link for 'DB2 Version 9.1 for z/OS'). The right column has sections: 'Provide feedback' (with links for 'Send documentation feedback', 'Send product feedback (survey)', and 'Help make IBM products easier to install and use.'), 'ibm.com and related resources', and 'Support and assistance' (with links for 'Search for technotes, APARs, and PTFs', 'IBM Software Support', 'IBM Information Management Software Support', 'DB2 for z/OS services', 'QMF Support', 'IMS services', 'IBM DB2 and IMS Tools services', 'WebSphere Replication Server for z/OS support', 'WebSphere Data Event Publisher for z/OS support', and 'InfoSphere Warehouse support').



Thank

You



# Important Disclaimer

**THE INFORMATION CONTAINED IN THIS PRESENTATION IS PROVIDED FOR INFORMATIONAL PURPOSES ONLY.**

**WHILE EFFORTS WERE MADE TO VERIFY THE COMPLETENESS AND ACCURACY OF THE INFORMATION CONTAINED IN THIS PRESENTATION, IT IS PROVIDED "AS IS", WITHOUT WARRANTY OF ANY KIND, EXPRESS OR IMPLIED.**

**IN ADDITION, THIS INFORMATION IS BASED ON IBM'S CURRENT PRODUCT PLANS AND STRATEGY, WHICH ARE SUBJECT TO CHANGE BY IBM WITHOUT NOTICE.**

**IBM SHALL NOT BE RESPONSIBLE FOR ANY DAMAGES ARISING OUT OF THE USE OF, OR OTHERWISE RELATED TO, THIS PRESENTATION OR ANY OTHER DOCUMENTATION.**

**NOTHING CONTAINED IN THIS PRESENTATION IS INTENDED TO, OR SHALL HAVE THE EFFECT OF:**

- **CREATING ANY WARRANTY OR REPRESENTATION FROM IBM (OR ITS AFFILIATES OR ITS OR THEIR SUPPLIERS AND/OR LICENSORS); OR**
- **ALTERING THE TERMS AND CONDITIONS OF THE APPLICABLE LICENSE AGREEMENT GOVERNING THE USE OF IBM SOFTWARE.**



# Backup



# DB2 10: Productivity – Doing More with Less!

- Auto statistics collection
- Easier scaling, simpler memory management
- Reduce contention, more online processing
- Access path stability
- Reduced need for REORG
  - Build compression dictionary on the fly
  - Index list prefetch enhancements
- Configure IBM UDFs and stored procedures
- Allow one SDSNEXIT data set for many subsystems
- Monitoring enhanced
  - Timeout / deadlock diagnostics
  - Identify SQL statements

Name	Monitoring Status		Alert		System			Database					
	Monitoring Status	Data Server Status	Critical	Warning	CPU Usage	Disk Space	Memory Usage	Locking	SQL Performance	Connections	Transactions	Logging	Maintenance
Production	■	■	3	8	■	■	■	■	■	■	■	■	■
Web	■	■	1	1	■	■	■	■	■	■	■	■	■
eCommerce	■	■	0	0	■	■	■	■	■	■	■	■	■
Support	■	■	1	1	■	■	■	■	■	■	■	■	■
Retail	■	■	0	0	■	■	■	■	■	■	■	■	■
New York	■	■	0	0	■	■	■	■	■	■	■	■	■
Los Angeles	■	■	0	0	■	■	■	■	■	■	■	■	■
Accounts	■	■	2	3	■	■	■	■	■	■	■	■	■
Marketing	■	■	0	4	■	■	■	■	■	■	■	■	■
Test	■	■	0	0	■	■	■	■	■	■	■	■	■
Development	■	■	0	0	■	■	■	■	■	■	■	■	■

Manual invocation of

- RUNSTATS
- COPY/BACKUP SYSTEM
- QUIESCE
- MODIFY RECOVERY
- REORG



## What customers are saying about DB2 9



We are in great shape. **DB2 9 is very solid and stable.** Our reorgs are running great and **performance is the best that it has ever been.** We are a very happy customer!  
*-Mark Shackelford, VP Infrastructure Baldor Electric*



"Like a good wine, DB2 has certainly gotten better with age!"  
*-Debra L Cook, ExxonMobil Global Services Company*



"We needed a database that represented the future and DB2 9 is the future. DB2 9 compression capabilities are key in helping reduce the size of our databases — in one case by up to **83 percent.** This ultimately helps us **minimize storage costs and increase performance.**"  
*-Jean Holley, CIO, Tellabs, Inc.*



"Not only is our IBM infrastructure **rock solid.** Our total cost of ownership is very low compared to other solutions. Our administrative framework for health education is **far superior in terms of cost compared to any other implementation** I've seen on campus. It took us a **fraction of the time** to develop than it would have on any other platform, and it's providing us with a reliable, fast solution for moving our health education program forward into the future."  
*- Steve Ware, Systems Coordinator, University of Florida Computing & Networking Services*