

A decorative graphic in the top left corner consists of several overlapping semi-circles of various colors, including yellow, orange, red, and purple, arranged in a cluster.

# **The Gold Standard for Enterprise Computing**

## **Advantages of a Private Cloud on zEnterprise**

# Businesses are choosing a variety of cloud deployment models



## Public cloud

Available to the general public or a large industry group and owned by an organization selling cloud services.



## Hybrid Cloud

Traditional IT and clouds (public and/or private) that remain separate but are bound together by technology that enables data and application portability



## Private cloud

On or off premises cloud infrastructure operated solely for an organization and managed by the organization or a third party



### Differences in Security, Availability, Performance

- Applications and data are publicly exposed
- Difficult to access logs and policies
- Minimal visibility into day-to-day operations
- Minimal customization

- Applications and data remain “inside the firewall”
- Easy to access logs and policies
- Good visibility into day-to-day operations
- More customization

# Applicability of the cloud is broadening to include more traditional enterprise workloads

## What types of applications do you plan to host on cloud platforms?

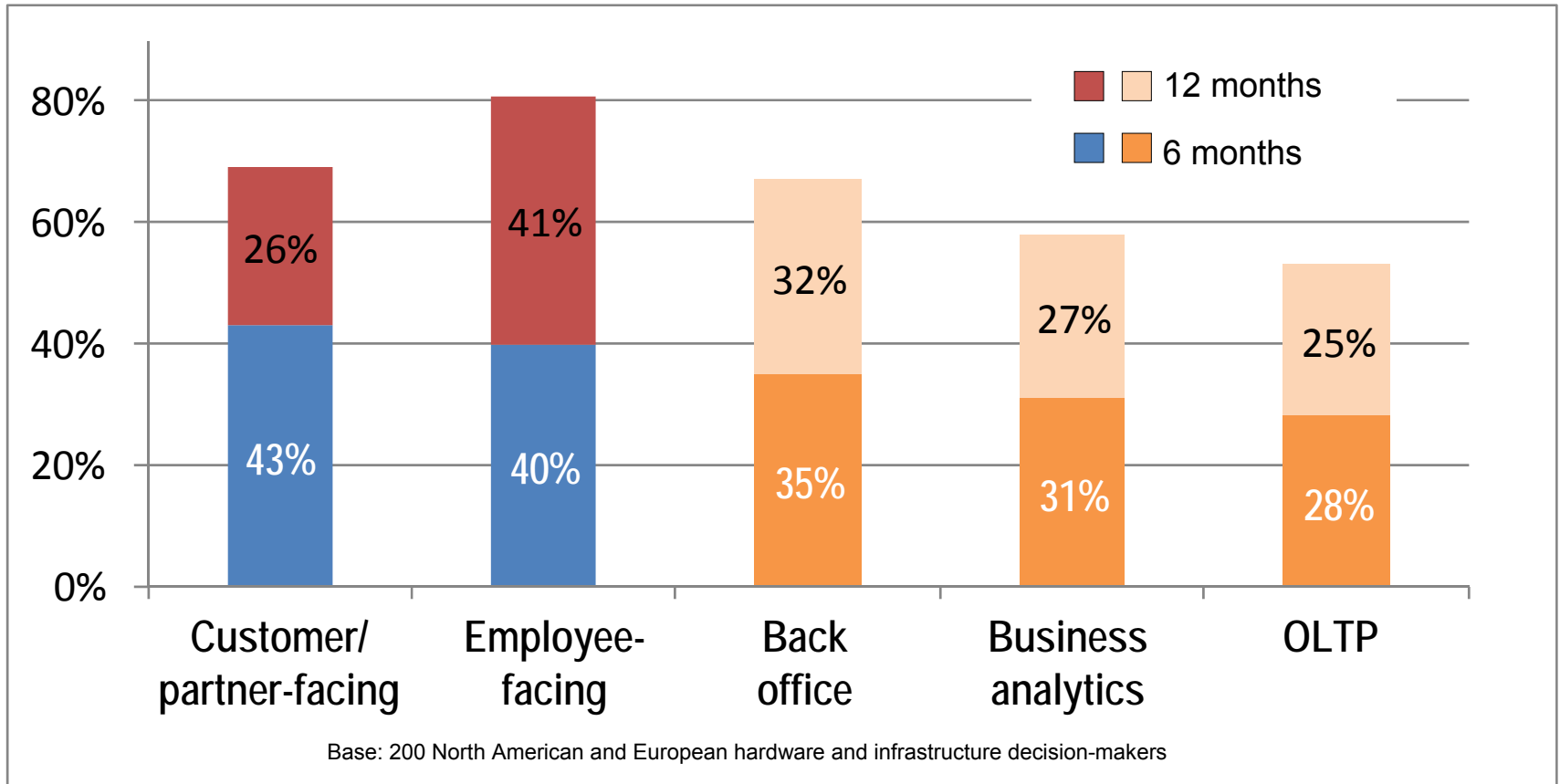

Source: A commissioned study conducted by Forrester Consulting on behalf of IBM, October, 2012

# zEnterprise excels at supporting enterprise workloads

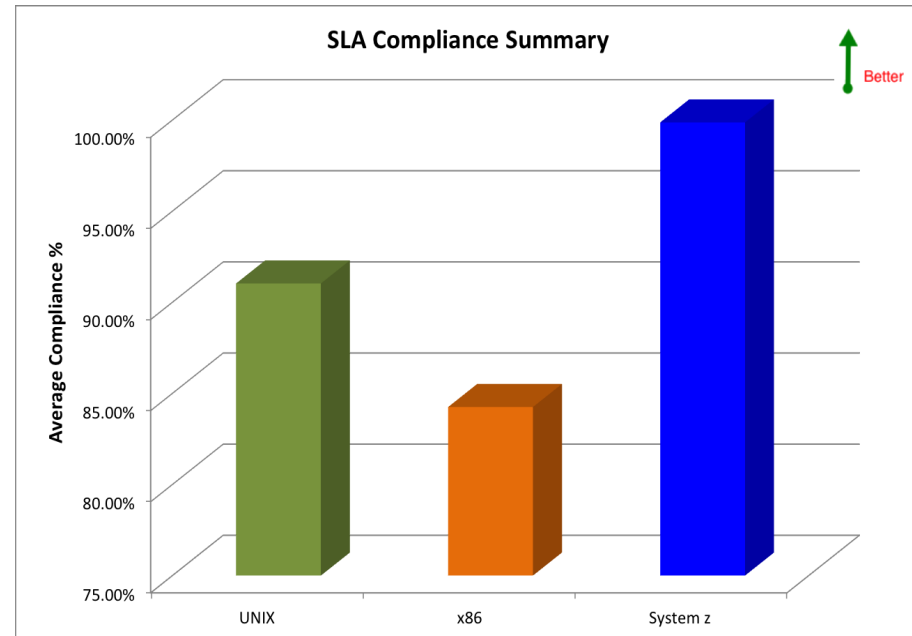
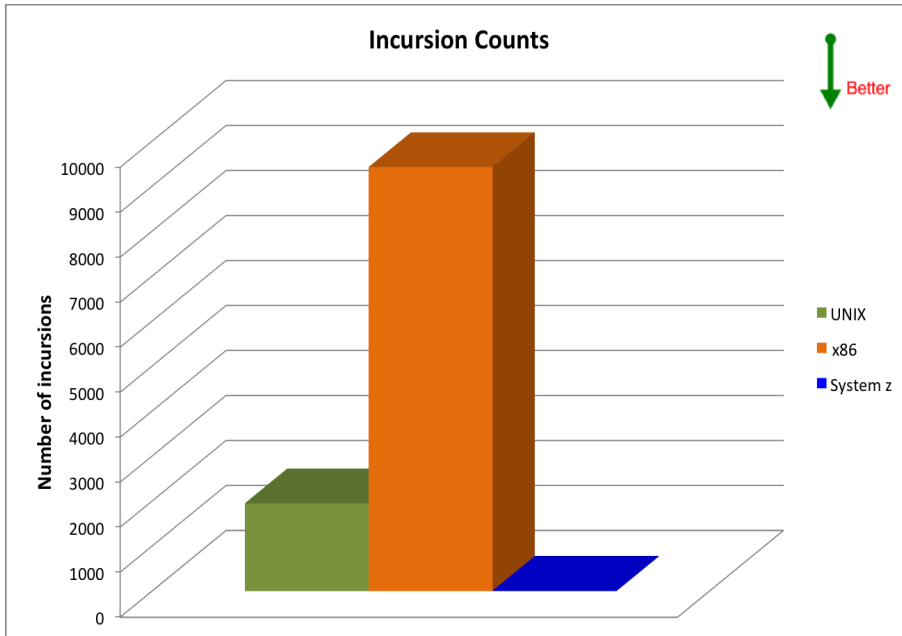

- Most secure
- Highly available
- Cost-effective
- High performance delivering quality service consistently
- Access to systems of record (z/OS) resident data

Source: "System z and Managed Service Providers," white paper by Solitaire Interglobal, 2013

# Key steps to deliver a robust private cloud on System z

## Virtualization

**IBM zEnterprise  
with Linux on z/VM**

- Consolidate and virtualize
- Streamlined management

## Entry Level Cloud

**IBMSmartCloud  
Provisioning**

## Advanced Cloud

**IBMSmartCloud  
Orchestrator\***

***Reduce costs and improve agility***

\*Under development for Linux on System z

# Virtualization was pioneered and perfected on IBM System z

Wisdom

Experience

Intelligence

Innovation

**System z continues to set the gold standard in virtualization!**

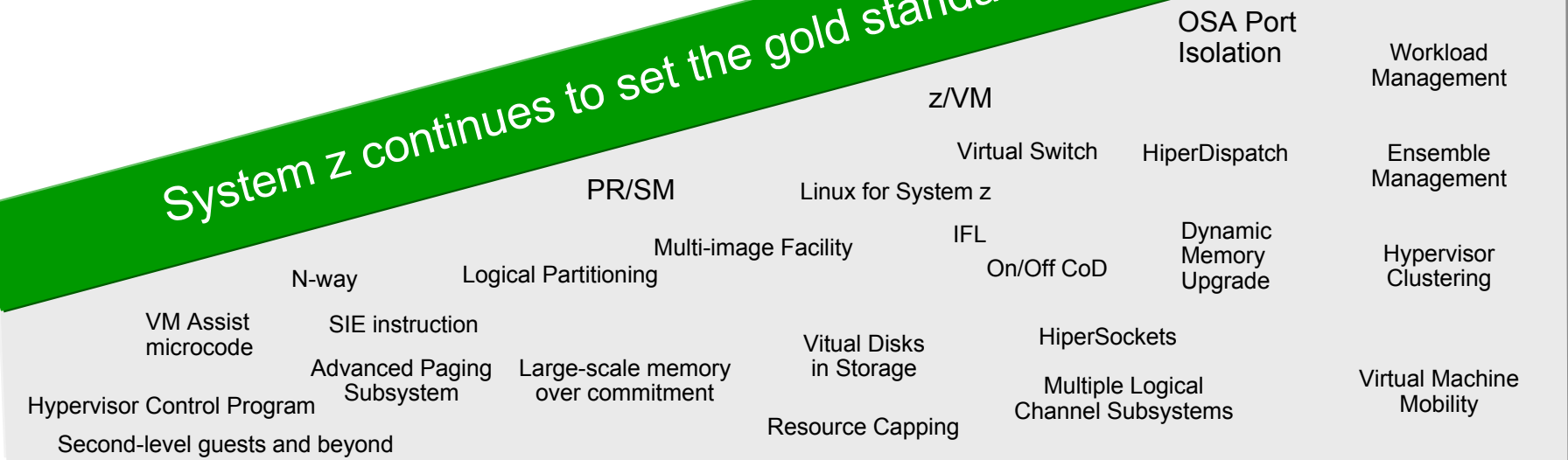

## z/VM has multi-system clustering and virtual server mobility

**z/VM Clustering** – Up to 4 z/VM instances on separate LPARs or other mainframes can be clustered as a single system image

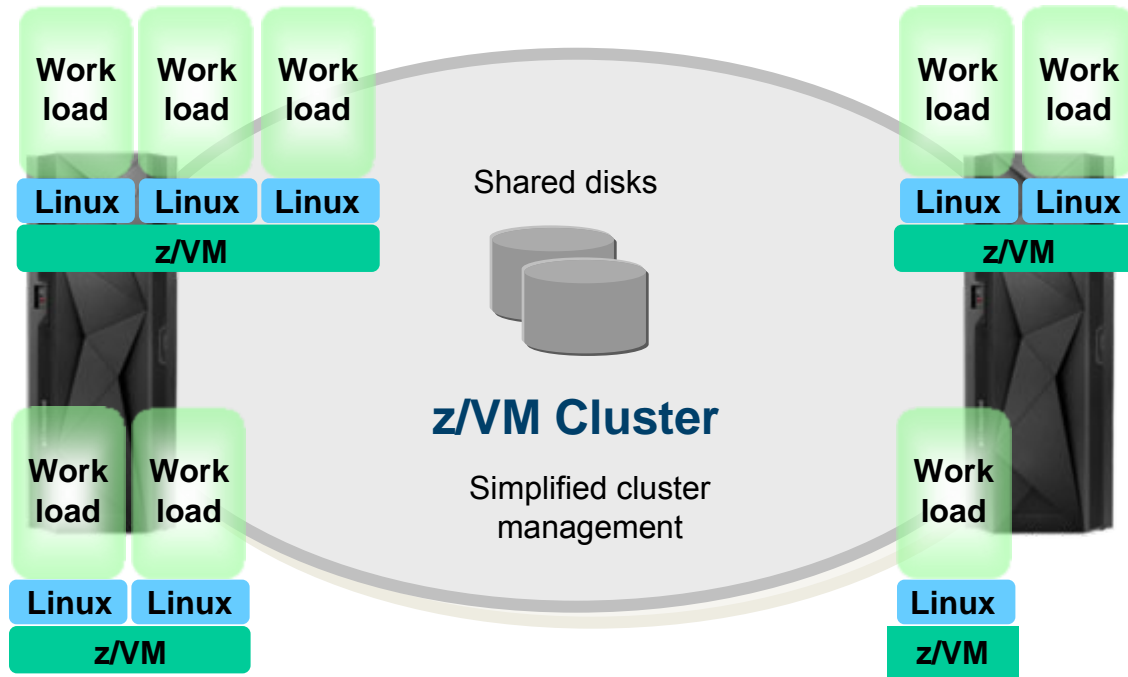

**Live Guest Mobility** – Move virtual servers non-disruptively to another LPAR on the same or another mainframe server in the single system image

**z/VM 6.3** – Now supports 1TB of real memory, 4 times more virtual servers, and offers increased performance for large VMs

# Simplified management of the z/VM virtualization layer

## CSL-WAVE virtualization management software for z/VM and Linux on zEnterprise environments

- Intuitive graphical workspace with powerful drag-and-drop capability
- Automatically detects all resources in the environment
  - Spans partitions, servers, sites, geographies
  - Supports SSI clustering and Live Guest Mobility
- Simplify and automate management
  - Monitor, provision, manage user accounts
- **Significantly reduces administration requirements and costs**

The screenshot displays the CSL-WAVE management console. On the left, a 'Hardware Viewer' shows a cluster of servers labeled 'DEMO-18' and 'QADIR51A'. Below it, the 'Property Viewer' shows details for a system named 'DEMO-38', including its status (Active), group (demo), type (Linux), and distribution (SLES 10 - 64 Bit). A 'Filter Definition' window is open, allowing users to filter objects by name or project. The main area shows a network topology with various nodes and connections. A context menu is open over a node, providing actions like 'Display Information', 'Update Information', 'Status', 'Activate', 'Deactivate', 'Recycle', 'Send Message', 'Execute Script', 'Access...', 'Cloning...', and 'More Actions'. At the bottom, a 'CSL-WAVE Log' table shows recent events:

WAVESTRY Time	User	System	Code	Type	Md
2011-08-01 12:38:46.0	oluser	WAVE	WAVESEC02	3	Adi
2011-08-01 12:40:37.0	oluser	DEMO-38	WAVEG014E	3	LAN



# DEMO: CSL-WAVE and Live Guest Mobility

The screenshot displays the IBM Tivoli Enterprise Console interface. The main window shows a network topology with various servers and network devices. A context menu is open over a server, listing actions such as 'Display Information', 'Update Information', 'Status', 'Activate', 'Deactivate', 'Recycle', 'Send Message', 'Execute Script', 'Access...', 'Cloning...', and 'More Actions'. The 'Activate' option is highlighted.

On the left, the 'Hardware Viewer' shows a tree structure with 'DEMO-18' selected. Below it, the 'Property Viewer' displays details for 'DEMO-18'.

Property	Value
Name	DEMOGAS
Status	Active
Group	demo
Type	Linux
Distribution	SLES 10 - 64 Bit
Net IP Address	192.168.20.88
Project	lab-test
Configuration	...

At the bottom, the 'CSL-WAVE Log' shows a table of events:

WAVESRV Time	User	System	Code	Type	Msg
2011-08-01 12:38:46.0	oluser	WAVE	WAVSEC0011	I	Ad
2011-08-01 12:40:37.0	oluser	DEMO-18	WAVGEN014E	I	Ad successfully.

10.

## Improve productivity with CSL-WAVE

Common Administrative Tasks	Manual (seconds)	With CSL-WAVE (seconds)	Reduction in Labor time
Create clone from guest	576	29	95%
Activate/deactivate guest	65	10	85%
Add virtual switch	88	20	77%
Execute scripts for guest	96	18	81%
Monitor z/VM	30	13	58%
Live guest migration	95	13	87%

Overall reduction in labor: **80%**

# Enterprise Linux Server solution provides cost-effective way to get started

- Solution includes:
  - Standalone zEnterprise server (either zBC12 or zEC12) with IFLs, memory, I/O connectivity ... plus z/VM
  - Hardware and software maintenance for 3 or 5 years
  - Linux available from distribution partners
    - SUSE and Red Hat
  
- For new Linux workload deployment and consolidation
  
- Designed from the ground up for enterprise-class workloads
  
- Extremely attractive pricing



**A perfect entry point for businesses  
with growing IT needs who are ready to make a commitment to Linux**

# Virtually all IBM middleware runs on Linux on System z (Total 244)

IBM Competitive Project Office



AIM / WebSphere (51)	IM (52)	SCI / Tivoli (57)	Industry Solutions (28)
<p>CICS Transaction Gateway Desktop Edition CICS Transaction Gateway for Multiplatforms Communications Server for Linux HTTP Server for WAS HE Novell SLES IBM Business Monitor IBM Business Process Manager Advanced IBM Business Process Manager Standard IBM Integration Bus IBM Mobile Foundation IBM Runtime Environment, Java Technology IBM Worklight TPF Toolkit WebSphere Adapter for Email WebSphere Adapter for ECM WebSphere Adapter for File Transfer Protocol WebSphere Adapter for Flat Files WebSphere Adapter for IBM i WebSphere Adapter for JDBC WebSphere Adapter for Lotus Domino WebSphere Adapter for Oracle E-Business WebSphere Adapter for PeopleSoft WebSphere Adapter for SAP Software WebSphere Adapter for Siebel Business WebSphere Adapters WebSphere Application Server WebSphere Application Server - Express WebSphere Application Server FP Web 2.0 WebSphere Application Server for Developers WebSphere Application Server Hypervisor WAS HE for Novell SLES on System z (2) WAS HE for Red Hat Enterprise Linux Server WAS HE Intelligent Management Pack WAS HE V7.0 on RHEL for System z (2) WebSphere Application Server Liberty Core WebSphere Application Server ND WebSphere Enterprise Service Bus WebSphere Extended Deployment WebSphere Extended Deployment CG WebSphere eXtreme Scale WebSphere Lombardi Edition WebSphere Message Broker WebSphere MB Connectivity for Healthcare WebSphere MQ, FTE, Low Latency (3) WebSphere Service Registry and Repository WebSphere SSR Advanced Lifecycle Edition WebSphere SSR Client WebSphere Virtual Enterprise</p>	<p>Cúram Social Program Management Database Enterprise Developer Edition DB2 Advanced Enterprise Server Edition DB2 Advanced Workgroup Server Edition DB2 Connect Application Server Advanced DB2 Connect Application Server Edition DB2 Connect Enterprise Edition DB2 Connect Unlimited Advanced z, I (3) DB2 Enterprise Server Edition DB2 for Linux, UNIX and Windows for SAP DB2 Merge Backup for Linux UNIX, Win DB2 Recovery Expert for Linux, UNIX, Win IBM Data Studio IBM InfoSphere Business Info. Exchange IBM InfoSphere Foundation Tools IBM InfoSphere Identity Insight IBM InfoSphere QualityStage Module US Cert IBM Metadata Workbench IBM solidDB Information Server Bus. Glossary Anywhere Informix Client Software Development Kit Informix Connect Runtime Informix Dynamic Server Enterprise Edition InfoSphere Business Glossary InfoSphere Change Data Capture InfoSphere Change Data Delivery InfoSphere Data Replication InfoSphere Federation Server InfoSphere Guardium InfoSphere Information Analyzer InfoSphere Information Server, SAP (2) InfoSphere Master Data Management InfoSphere Master Data Management Server InfoSphere Optim Configuration Manager InfoSphere Optim Performance Manager (2) InfoSphere Optim pureQuery Runtime z/OS InfoSphere Optim Query Capture and Replay InfoSphere Warehouse Advanced Depart. InfoSphere Warehouse Advanced Enterprise InfoSphere Warehouse Departmental Edition InfoSphere Warehouse Developer Edition InfoSphere Warehouse Enterprise Base InfoSphere Warehouse Enterprise Edition InfoSphere Warehouse Optim Data Retention Optim High Performance Unload for DB2 Optim Performance Manager (2) Optim Query Tuner for DB2</p>	<p>IBM License Metric Tool IBM SmartCloud Control Desk IBM SmartCloud Cost Management IBM TRIRIGA Application Builder IBM TRIRIGA Application Platform IBM TRIRIGA Connector Business Apps (2) IBM TRIRIGA Connector for Offline Forms Maximo Adapter for Microsoft Project Maximo Adapter for Primavera Maximo Archiving Adapter for Optim Data Gr. Maximo Asset Configuration Manager Maximo Asset Mgmt, Essentials, Schedule (3) Maximo Calibration Maximo Change and Corrective Action Mgr Maximo Enterprise Adapter, SAP (2) Maximo Everywhere Maximo for Government Maximo for Life Sciences Maximo for Nuclear Power Maximo for Oil and Gas Maximo for Service Providers Maximo for Transportation Maximo for Utilities Maximo Health, Safety and Environment Mgr Maximo Linear Asset Manager Maximo Mobile Asset Manager Maximo Mobile Inventory Manager Maximo Mobile Suite Maximo Mobile Work Manager Maximo Spatial Asset Management Tivoli Application Dependency Discovery Mgr Tivoli Asset Discovery for Distributed Tivoli Business Service Manager Tivoli Monitoring, Energy Mgmt, VE (3) Tivoli Netcool/Impact Tivoli Netcool/OMNIBus Tivoli NetView for z/OS Tivoli Network Manager IP Edition Tivoli Provisioning Manager Tivoli Service Automation Manager Tivoli Storage Productivity Center Editions (3) Tivoli System Automation Application Mgr Tivoli System Automation for Multiplatforms Tivoli Usage and Accounting Manager, Ent (2) Tivoli Workload Scheduler, z/OS, Agent (3) TotalStorage SAN Volume Controller</p>	<p>Case Foundation Case Manager Content Analytics Content Foundation Content Integrator Enterprise Edition Content Manager Enterprise Edition Content Manager OnDemand Multiplatforms Cúram Social Program Management Enterprise Records FileNet Business Process Manager FileNet Content Manager IBM WebSphere Multichannel Bank Toolkit Sterling B2B Integrator Sterling Connect:Direct Sterling Connect:Express Sterling Control Center WebSphere Commerce Enterprise WebSphere Multichannel Bank Toolkit WebSphere Transformation Extender WebSphere Transformation Extender SEPA WebSphere Transformation Extender SAP WebSphere Transformation Extender SWIFT WebSphere Transformation Extender EDI WebSphere Transformation Ext. Financial WebSphere Transformation Ext. Healthcare WebSphere Transformation Ext. NACHA</p>
			<b>Rational (19)</b>
<p><b>ICS / Portal (15)</b> IBM Connections IBM Connections Mail IBM Customer Experience Suite Rich Media IBM Domino IBM Forms Experience Builder IBM Forms Server IBM Mobile Portal Accelerator IBM Web Content Manager, Rich Media (2) IBM Web Experience Factory Lotus Domino WebSphere Dashboard Framework WebSphere Portal Enable, Extend, Server (3)</p>	<p><b>BA (15)</b> Cognos Business Insight Cognos Business Intelligence &amp; Analysis Cognos Insight Cognos Mobile Cognos Real-time Monitoring IBM SPSS License Authorization Wizard IBM SPSS Modeler Limited SPSS Collaboration and Deployment Services SPSS Decision Management SPSS Modeler &amp; Server (2) SPSS Statistics &amp; Server (2)</p>	<p><b>Security (7)</b> IBM Security Access Manager for Web IBM Security Identity Manager Tivoli Access Manager for e-business Tivoli Directory Integrator Tivoli Federated Identity Manager Tivoli Federated Identity Mgr Bus. Gateway Tivoli Key Lifecycle Manager</p>	<p>Rational Asset Manager Enterprise Edition Rational Asset Manager Standard Edition Rational Automation Framework Rational Build Forge Rational Build Forge Enterprise Edition Rational Build Forge Enterprise Plus Edition Rational Build Forge Standard Edition Rational ClearCase Rational ClearCase MultiSite Rational Collaborative Lifecycle Management Rational Developer for System z Rational Developer for zEnterprise Rational DOORS Rational Host Access Transformation Service Rational Programming Patterns Rational Programming Patterns for System z Rational Quality Manager Rational Requirements Composer Rational Team Concert</p> <p>Source: IBM Clearinghouse Last Updated: 9/11/13</p>

# IBM provides free services support to ISVs when moving Linux applications from x86 to zEnterprise

## Chiphopper services offering:

- Designed for IBM Business Partners (PartnerWorld members)
- Helps them port their existing Linux applications from competitive platforms onto IBM Power Systems or System z running Linux
  - Enablement and guidance services, plus Linux support
  - Access to IBM hardware and middleware, proof of concept environments and platforms for testing
  - Technical assistance during the port
  - Post-porting issue support
- Free of charge service

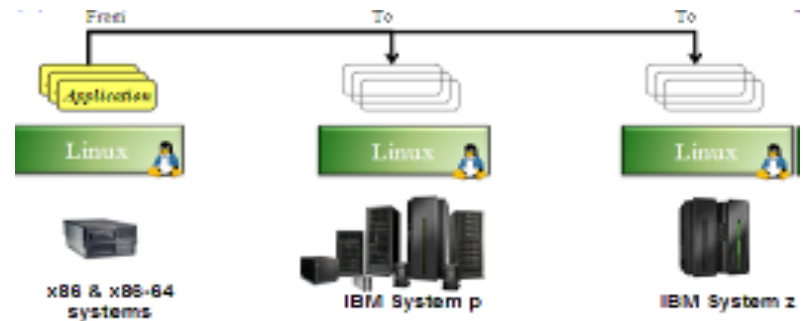

*"OpenPro and IBM Chiphopper team are working together to provide a flexible, scalable and fully featured business management ERP solution. This system uses the power of open source technologies with many advanced features that have saved clients millions of dollars in operating efficiencies. OpenPro works with the new IBM DB2 version on the powerful IBM System z or i."*

**- Jim Clark, CEO of OpenPro**

For more information, contact Chiphopper web page: [www.ibm.com/isv/go/chiphopper](http://www.ibm.com/isv/go/chiphopper), or send an email to [chiphop@us.ibm.com](mailto:chiphop@us.ibm.com)

# Examples of workloads best suited to consolidate on a private cloud on Linux on z/VM

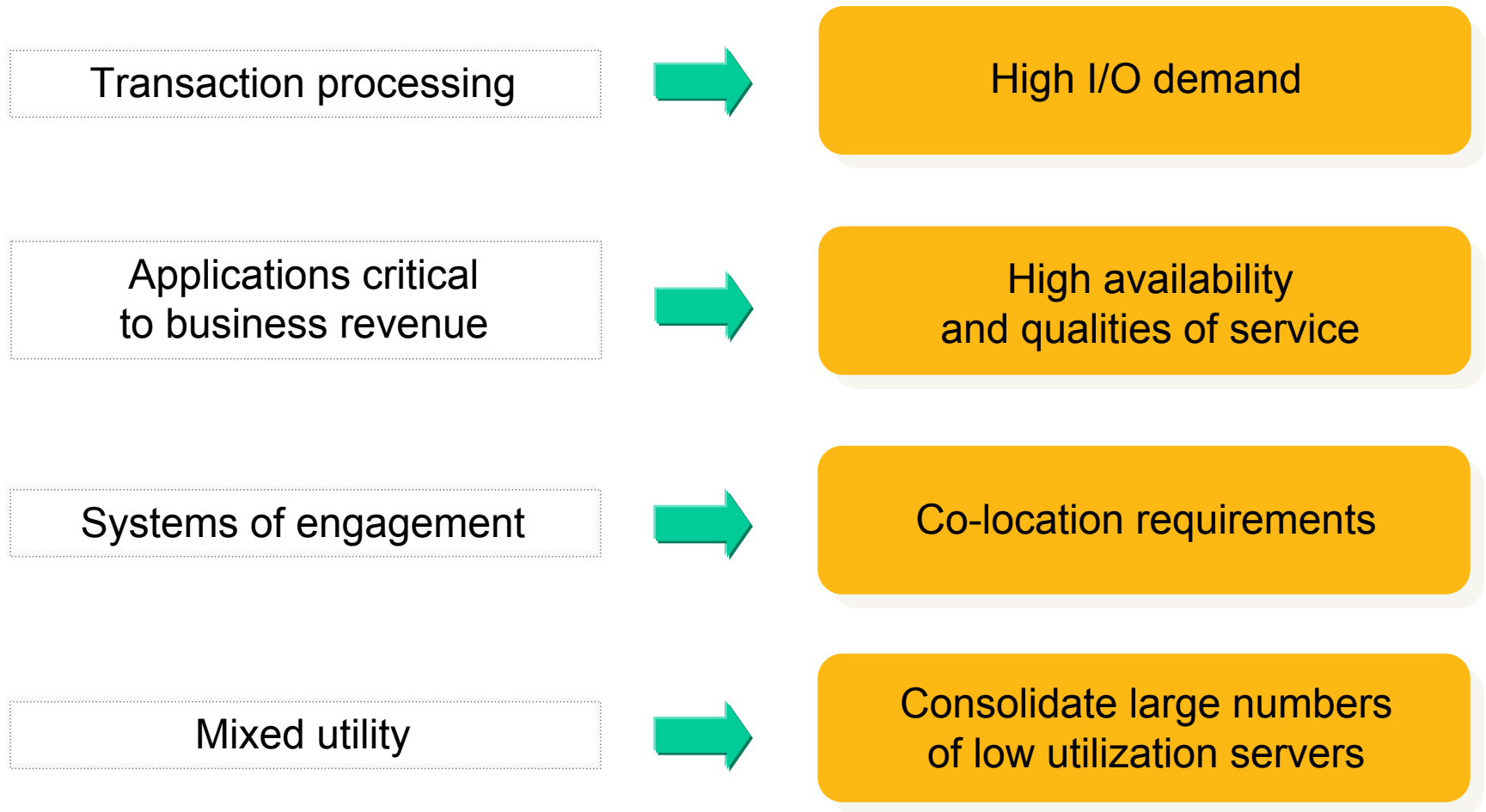

# Workloads with higher I/O bandwidth requirements benefit from zEnterprise architecture

*Which platform provides the lowest TCA over 3 years?*

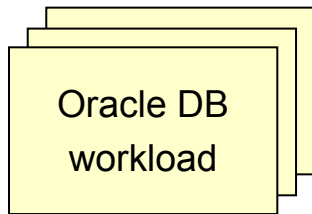

Customer Database Workloads  
each supporting 4K TPS

Oracle Enterprise Edition  
Oracle Real Application Cluster

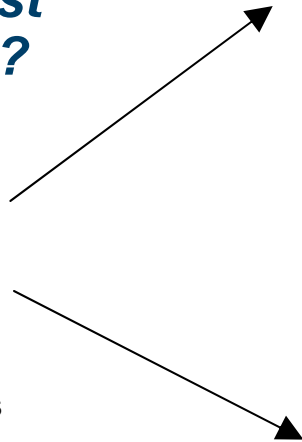

T5-8 server  
(128 cores)  
3 x 4-node Oracle RAC DB

**\$8.9M** (3 yr. TCA)



zEC12 with 16 IFLs  
3 x 4-node Oracle RAC DB

**\$3.6M** (3 yr. TCA)

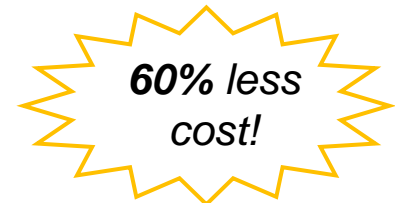

TCA includes hardware, software, maintenance, support and subscription. Workload Equivalence derived from a proof-of-concept study conducted at a large Cooperative Bank and projecting to T5-8 servers using published TPC-C Results normalizing them to Relative Performance Units as available from Ideas International

# Co-location benefits from zEnterprise architecture

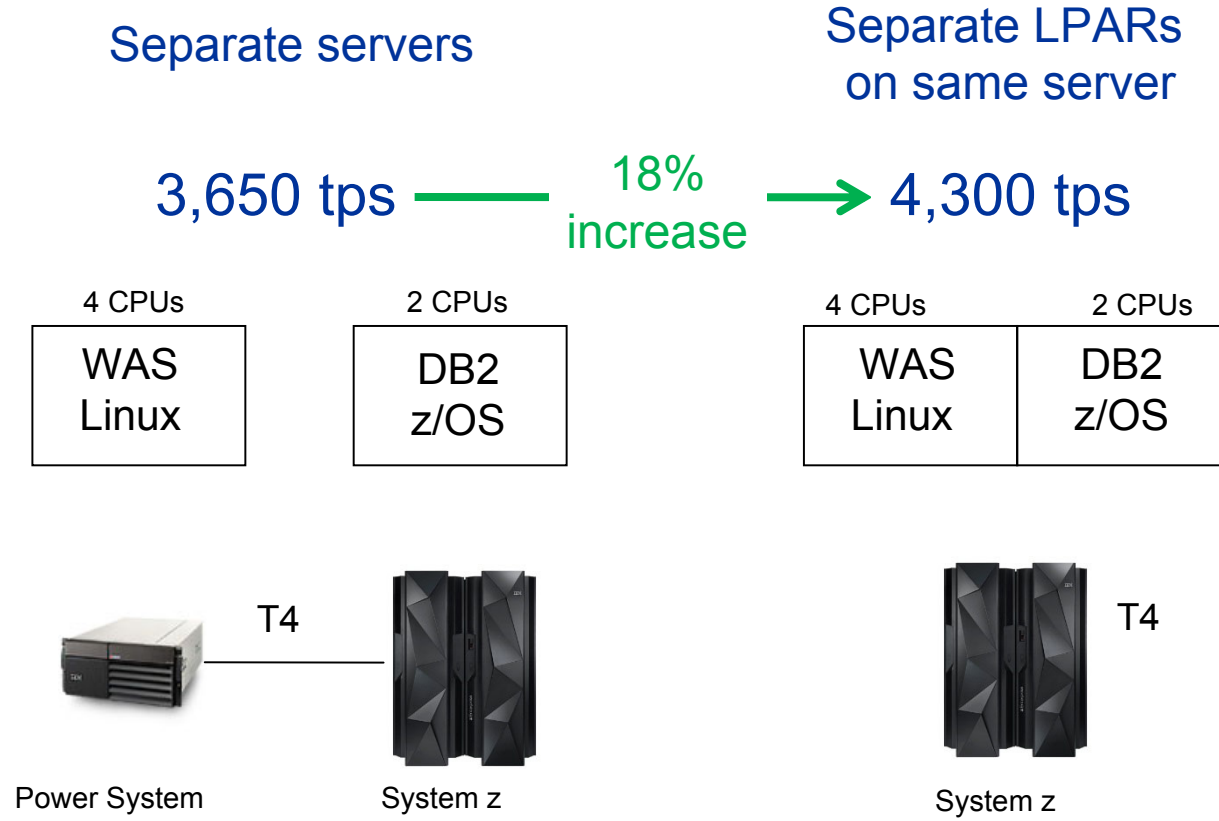

Source: IBM CPO.  
Type-4 driver used on both platforms to equalize database connectivity



# Consolidation onto System z also yields co-location benefits for SAP applications

## Business challenge:

- After acquiring a competitor, inherited 200+ standalone servers
- Faced untenable increases in IT costs from system complexity and incompatibility, maintenance and licensing issues
- Customer service was suffering as a result

## Solution:

Consolidated distributed servers *and* migrated its mission-critical SAP and DB2-based applications to an IBM System z running Linux, z/OS and z/VM operating systems

## Benefits:

- Reduced IT costs as proportion of sales by **50%**
- Consolidation cuts power by **40%** and reduces data center floor space from 6,000 to 1,000 sq. ft.
- Cut system administration and maintenance costs



SAP	DB2
Linux	z/OS

SAP applications  
co-located on System z

# Key steps to deliver a robust private cloud on system z

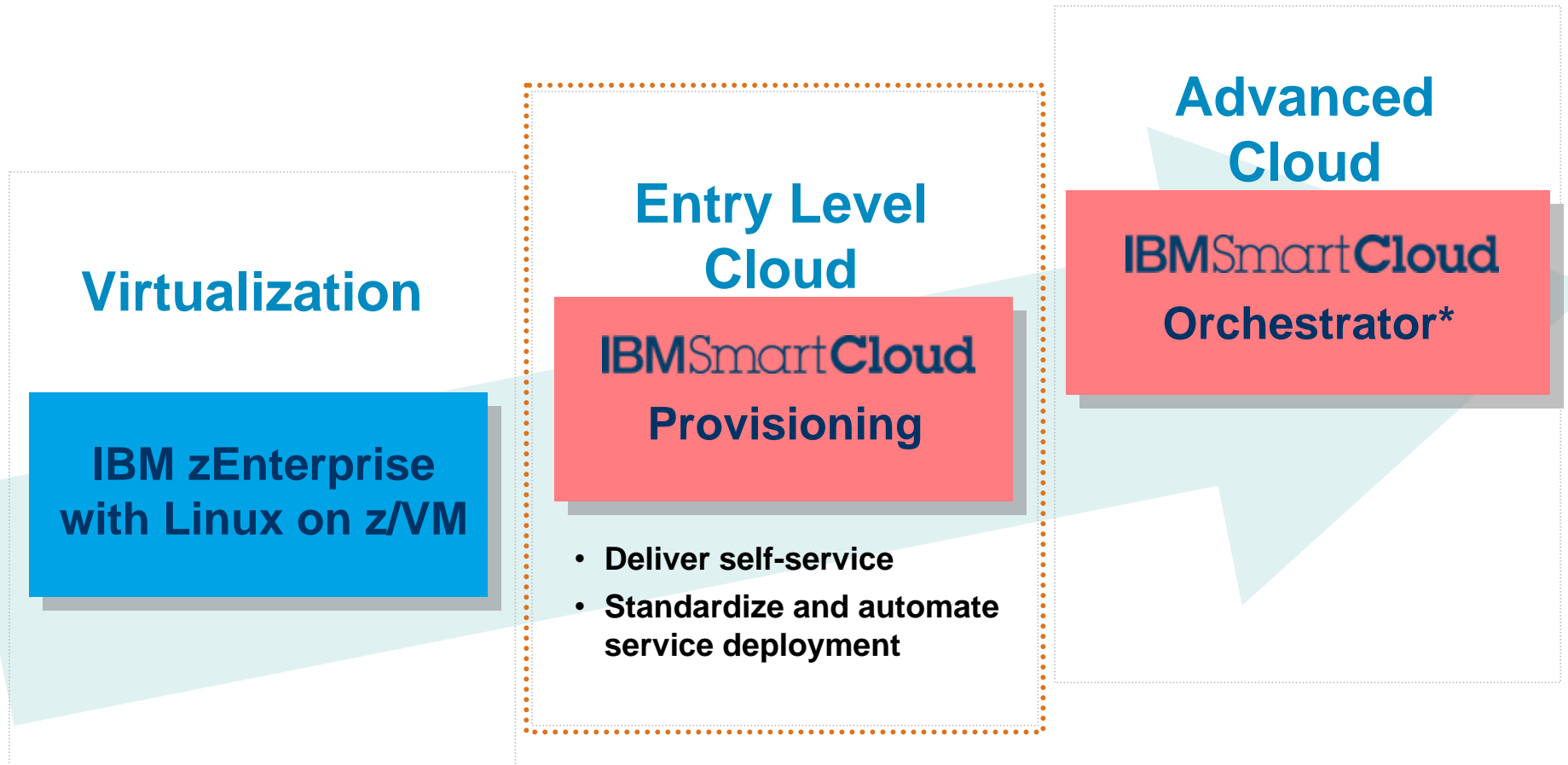

***Reduce costs and improve agility***

\*Under development on Linux on System z

# Examples of private cloud services

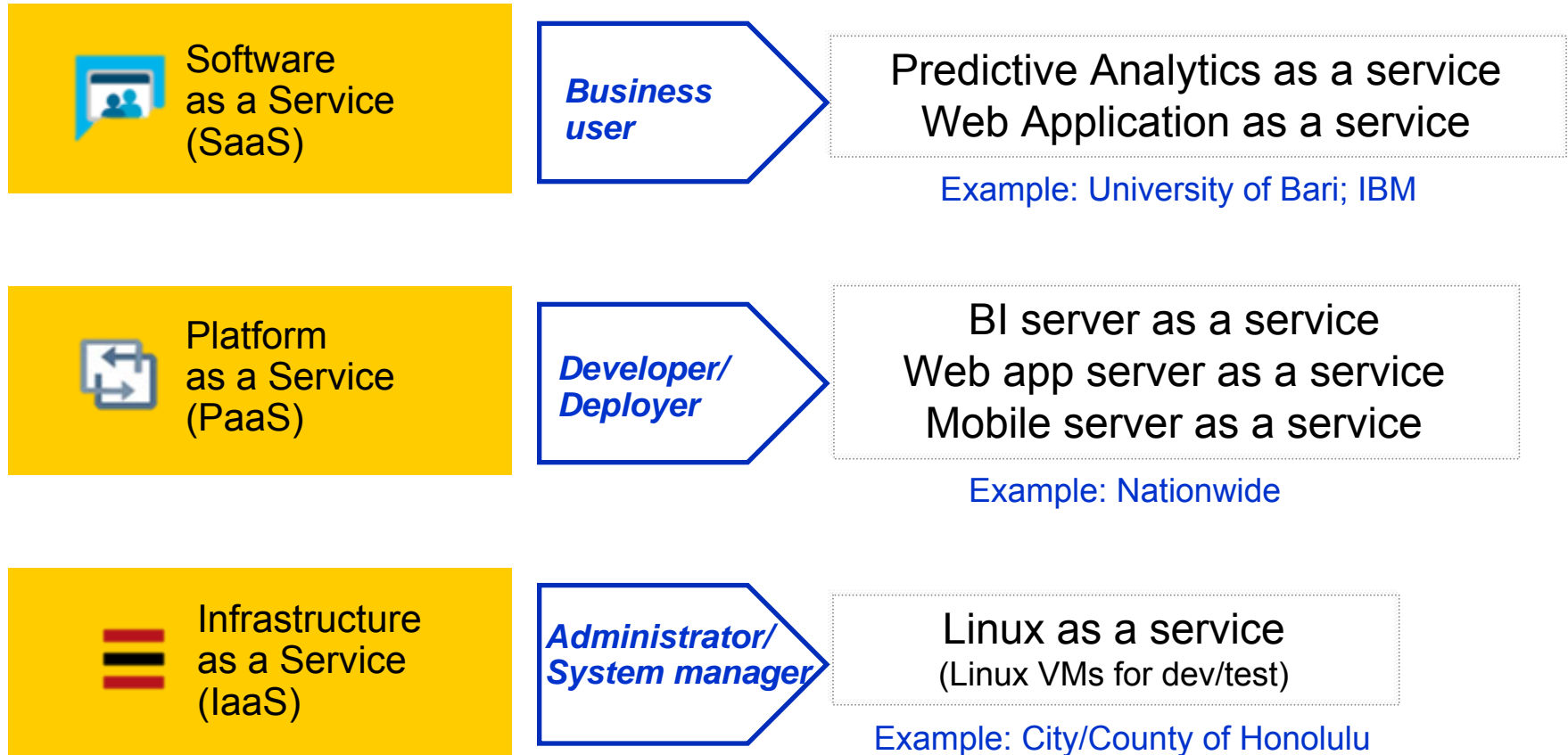

# Automate deployment of cloud services with IBM SmartCloud Provisioning

- Self-service automated provisioning of virtual machine images...
  - Images can include OS, middleware and applications
  - Deploy multiple virtual machines in a single operation with patterns
- ...into pools/clouds on virtualized hardware
  - Supports z/VM, PowerVM, VMware ESX, KVM, Xen, Microsoft Hyper-V

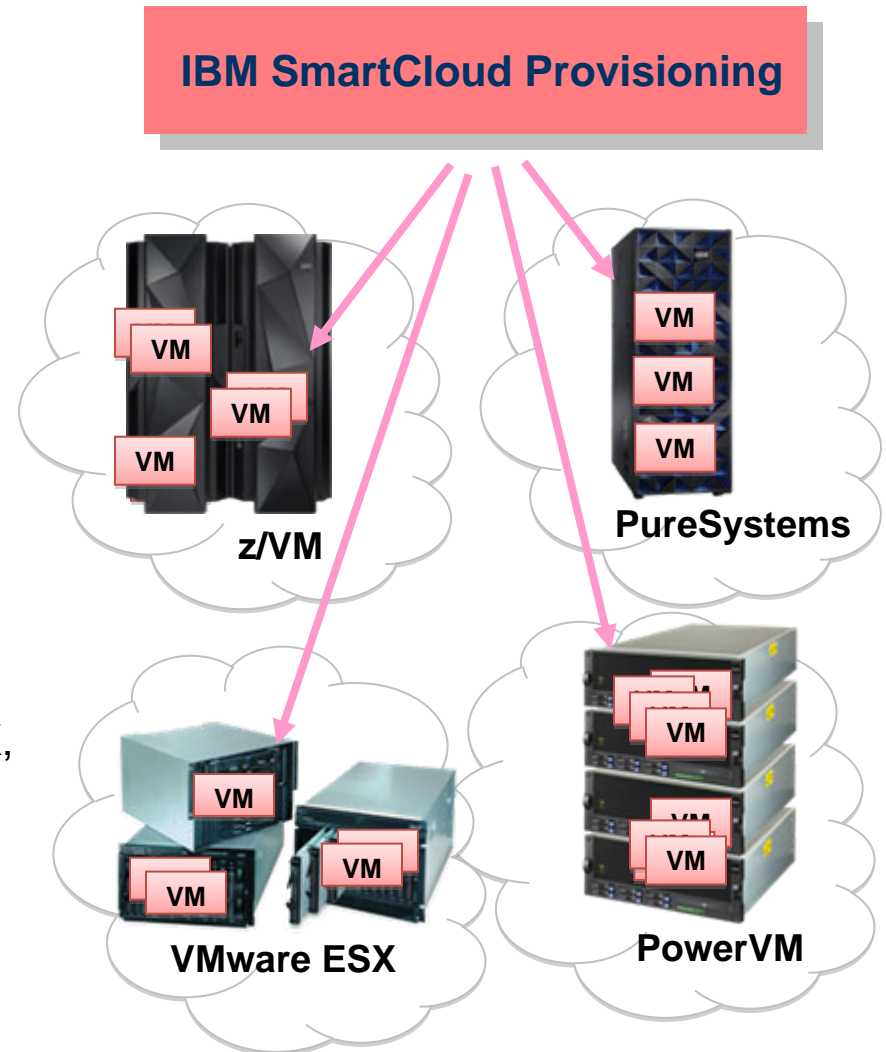

# Automation with IBM SmartCloud Provisioning can further reduce costs



User selects and deploys a pattern

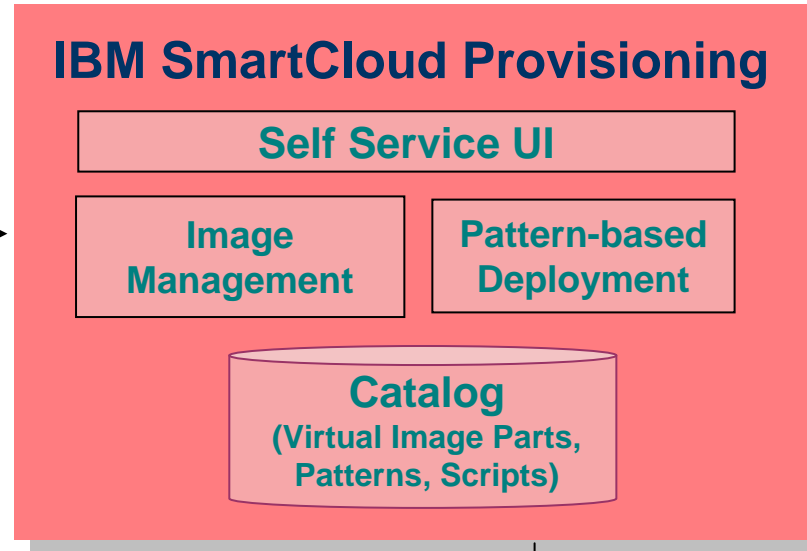

- Self-service console for users
- Virtual images and patterns for quick-starts
- Drag and drop tooling for creating and deploying cloud services using catalog
- Intelligent placement algorithm optimizes resource utilization based on cloud activity

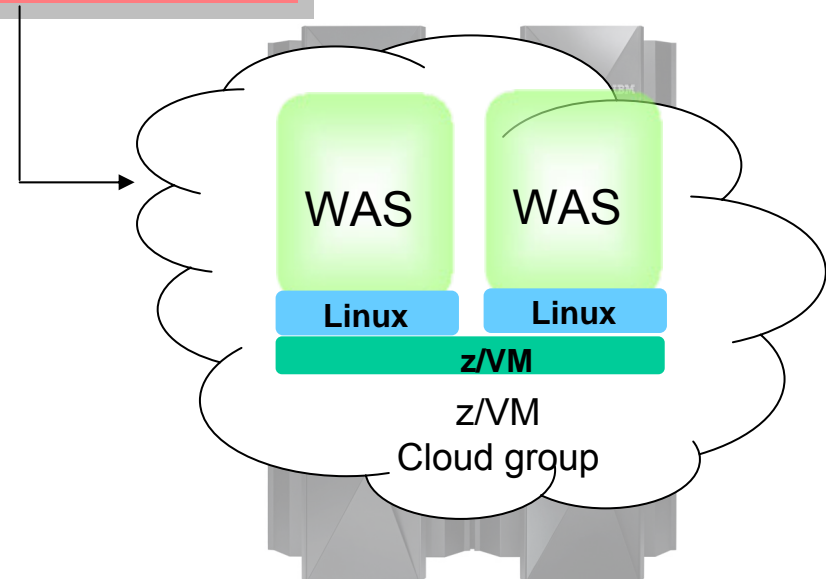

# IBM SmartCloud Provisioning makes it easier to get started with virtualized images

- IBM middleware packaged as Hypervisor Editions (.OVF virtual images), ready to run on a hypervisor
  - Includes pre-installed and pre-configured image, image-specific tuning/configuration and fast deploy-time activation capabilities
- Hypervisor Editions imported into catalog as virtual image parts that represent topology components
  - Example: deployment manager, custom node, etc.
- Virtual image parts can be used to create virtual system patterns

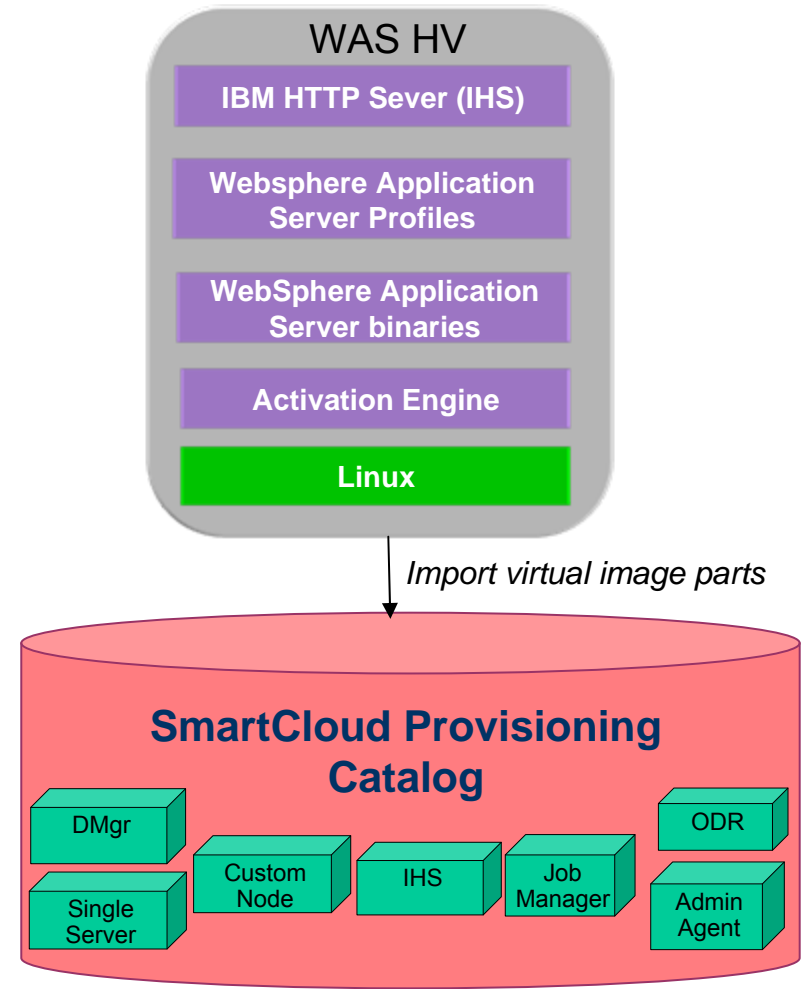

# IBM SmartCloud Provisioning deploys standardized virtual system patterns

**A Virtual System Pattern is one or more virtual images and script packages to satisfy a certain deployment topology**

Single Server

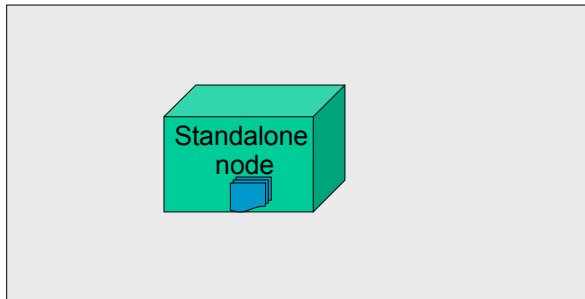

WebSphere cluster

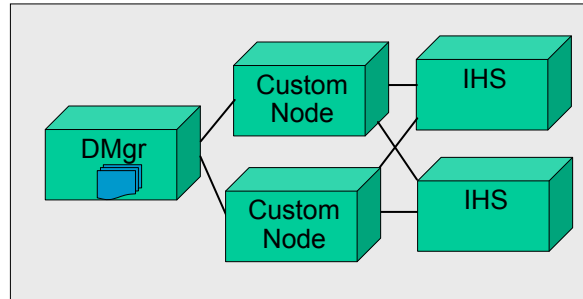

WebSphere Advanced Cluster

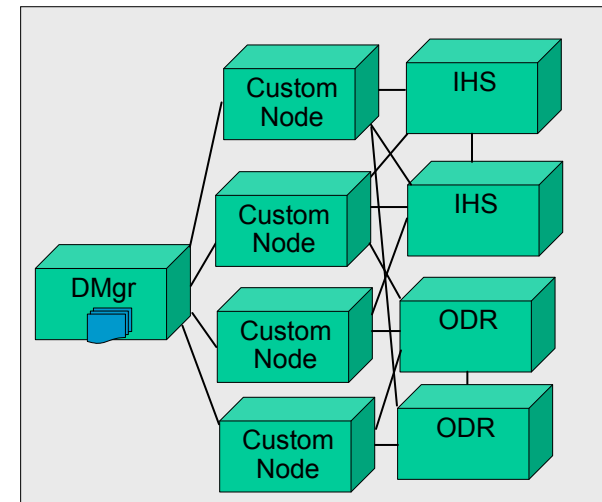

WebSphere cluster (dev)

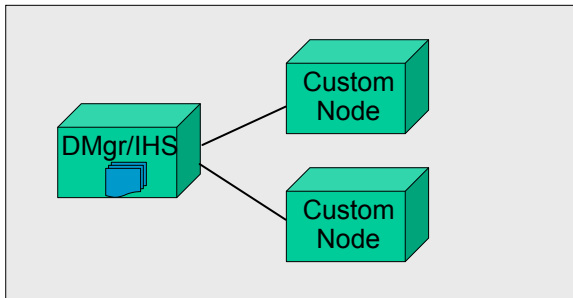

WebSphere Process Server (Scalable)

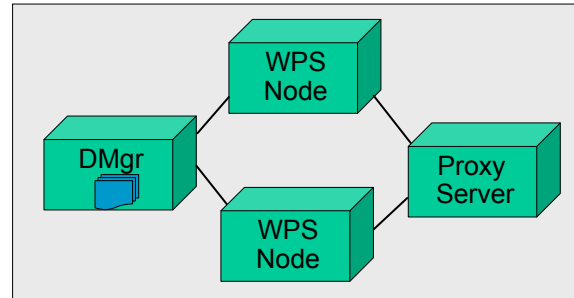

DMgr = Deployment Manager  
 IHS = IBM http Server  
 ODR=On Demand Router  
 23

# IBM SmartCloud Provisioning automated pattern-based deployment is fast

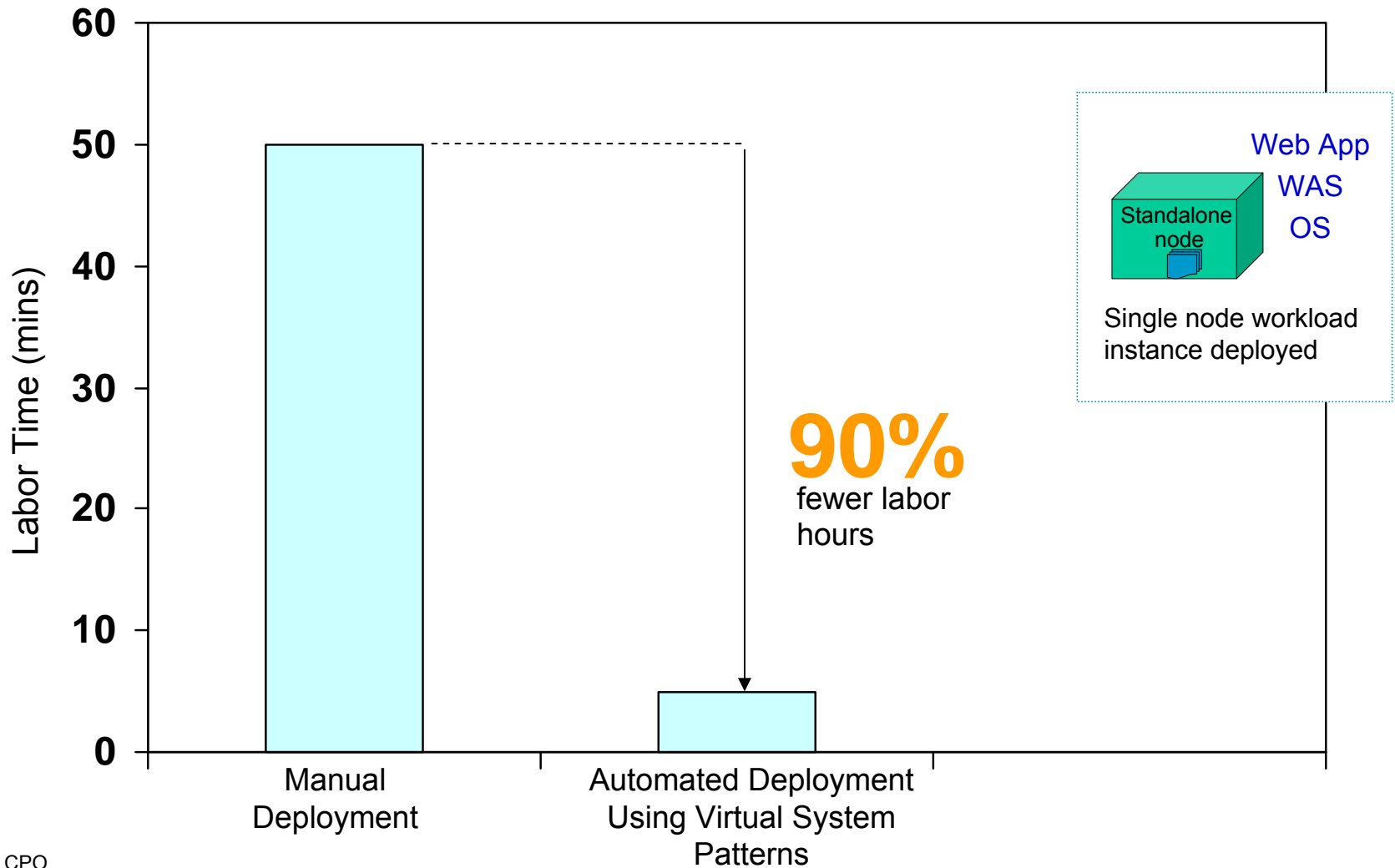

Source: IBM CPO



## DEMO: SmartCloud Provisioning enables fast deployment of business analytics on a private cloud on System z

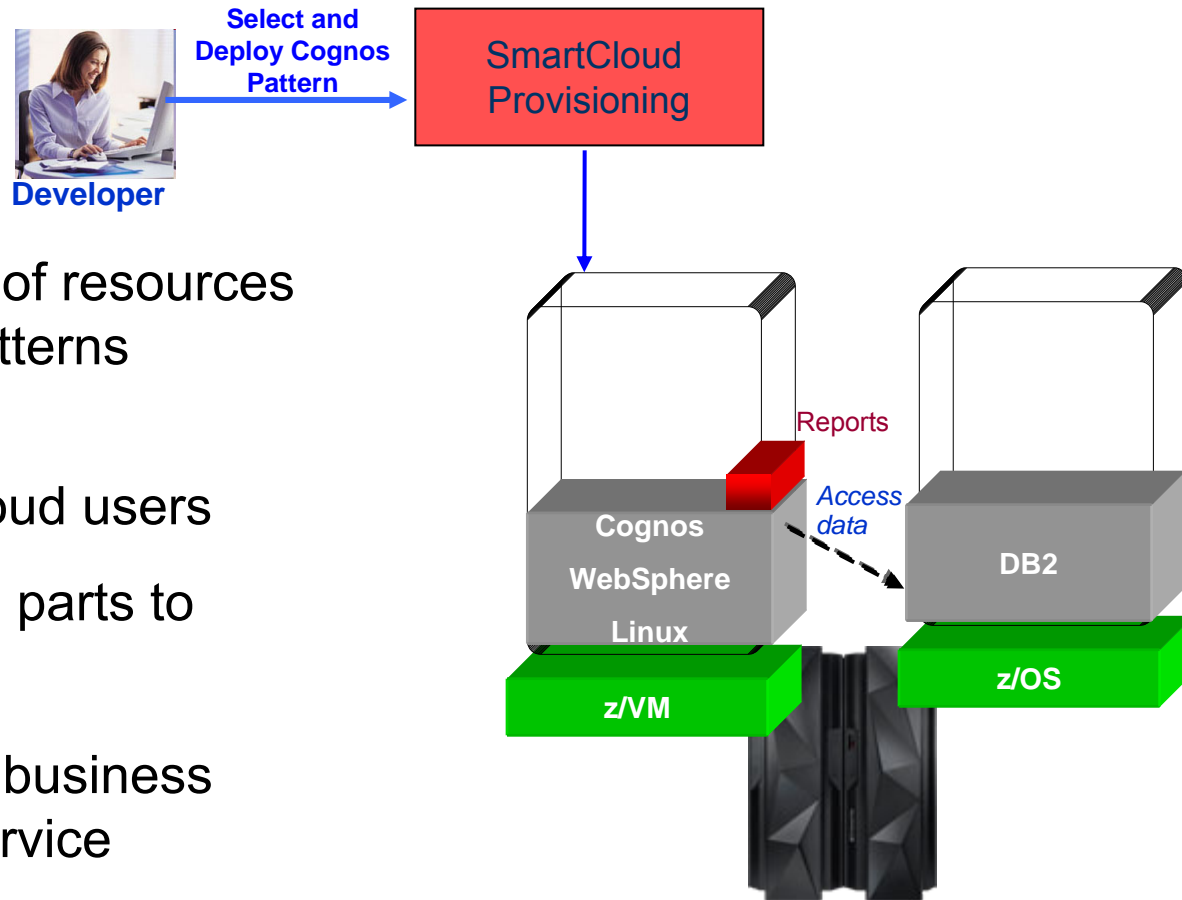

- Administrator sets up pool of resources and makes images and patterns available to cloud users
- Self-service console for cloud users
- Cloud users drag and drop parts to create patterns
- Automated provisioning of business analytics (Cognos) as a service

# Public vs. private cloud: Which option costs less for delivering mixed workloads?

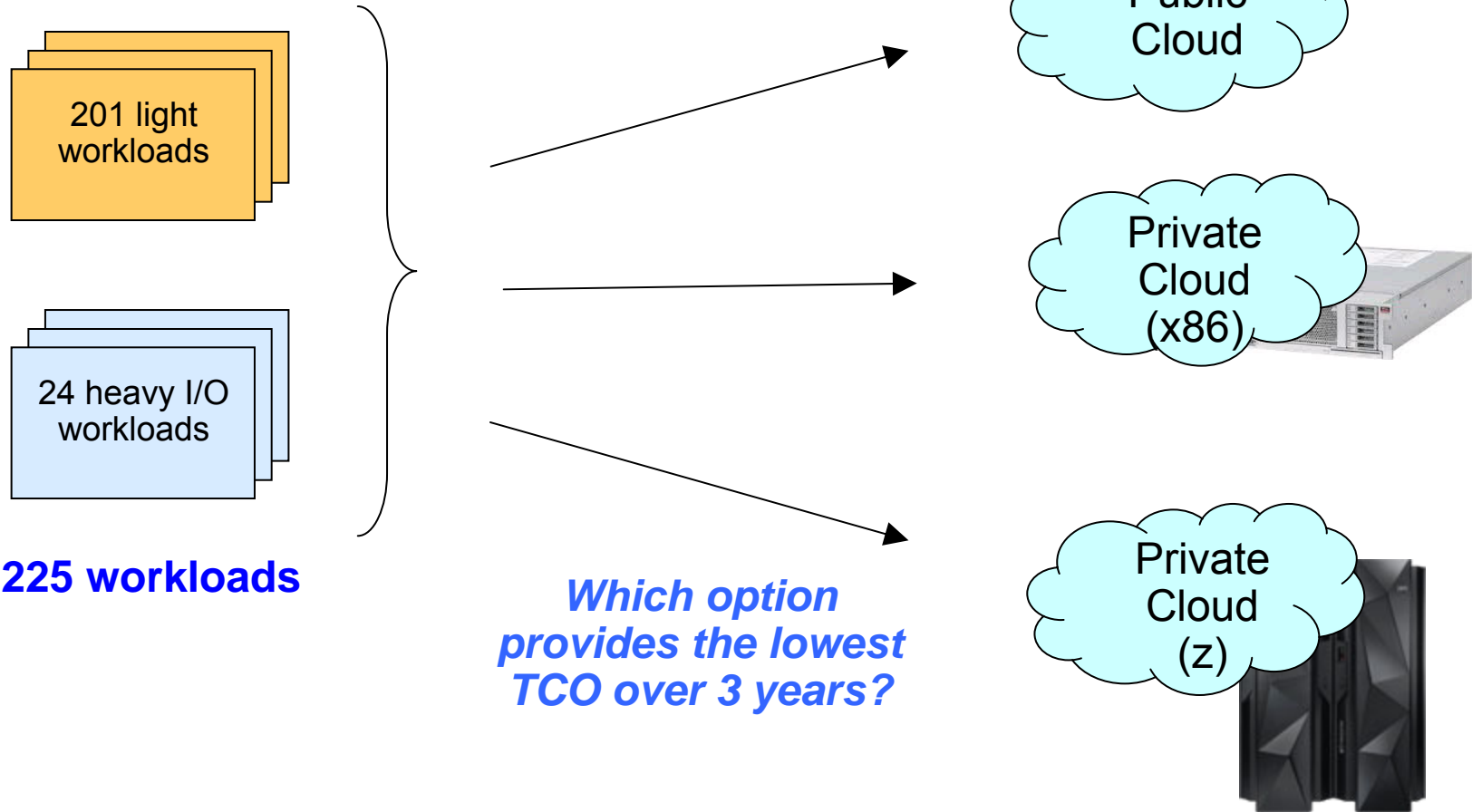

# Platform requirements for deploying light workloads

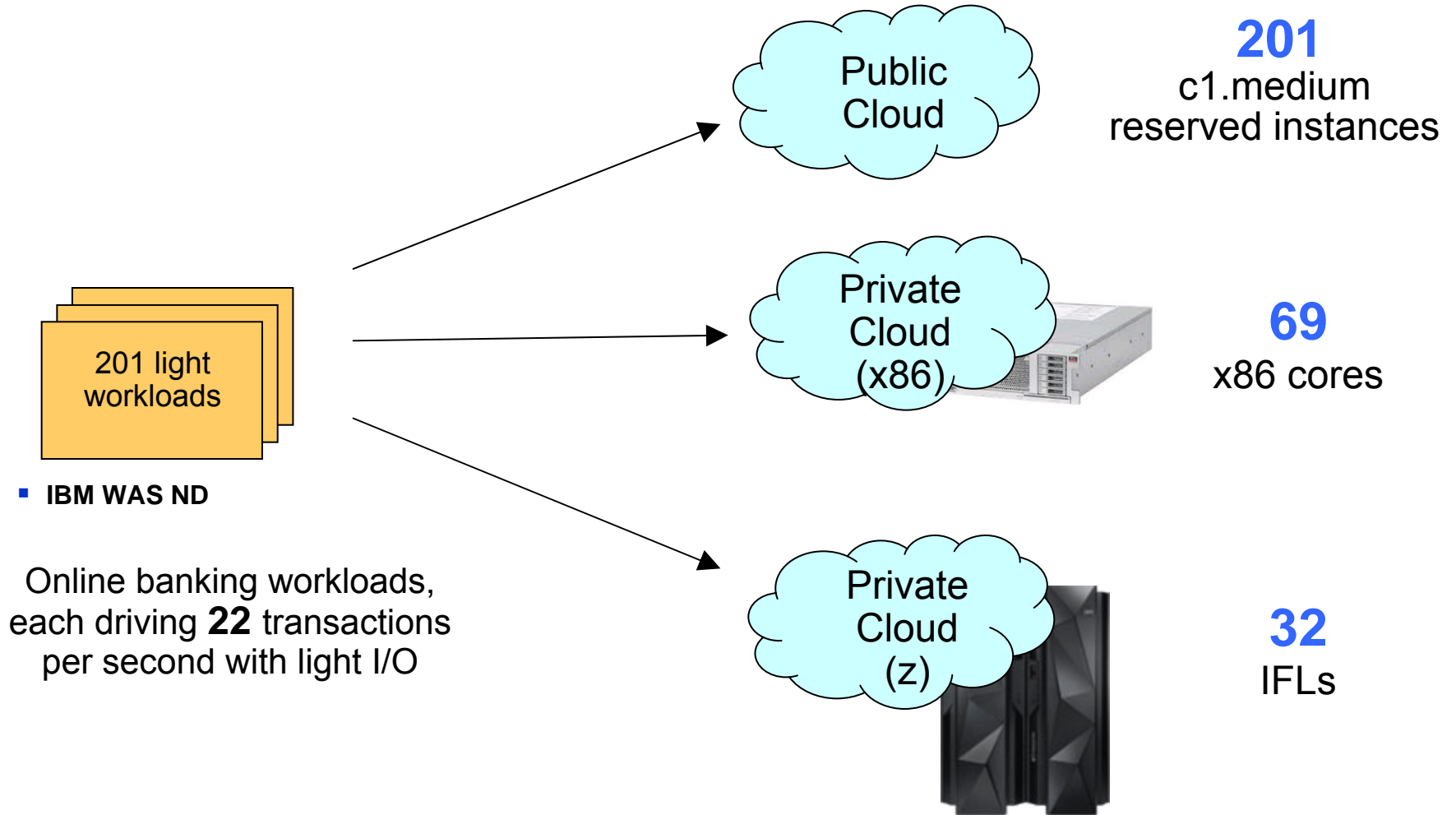

Server configurations are based on consolidation ratios derived from IBM internal studies.

# Platform requirements for deploying light workloads with heavy I/O

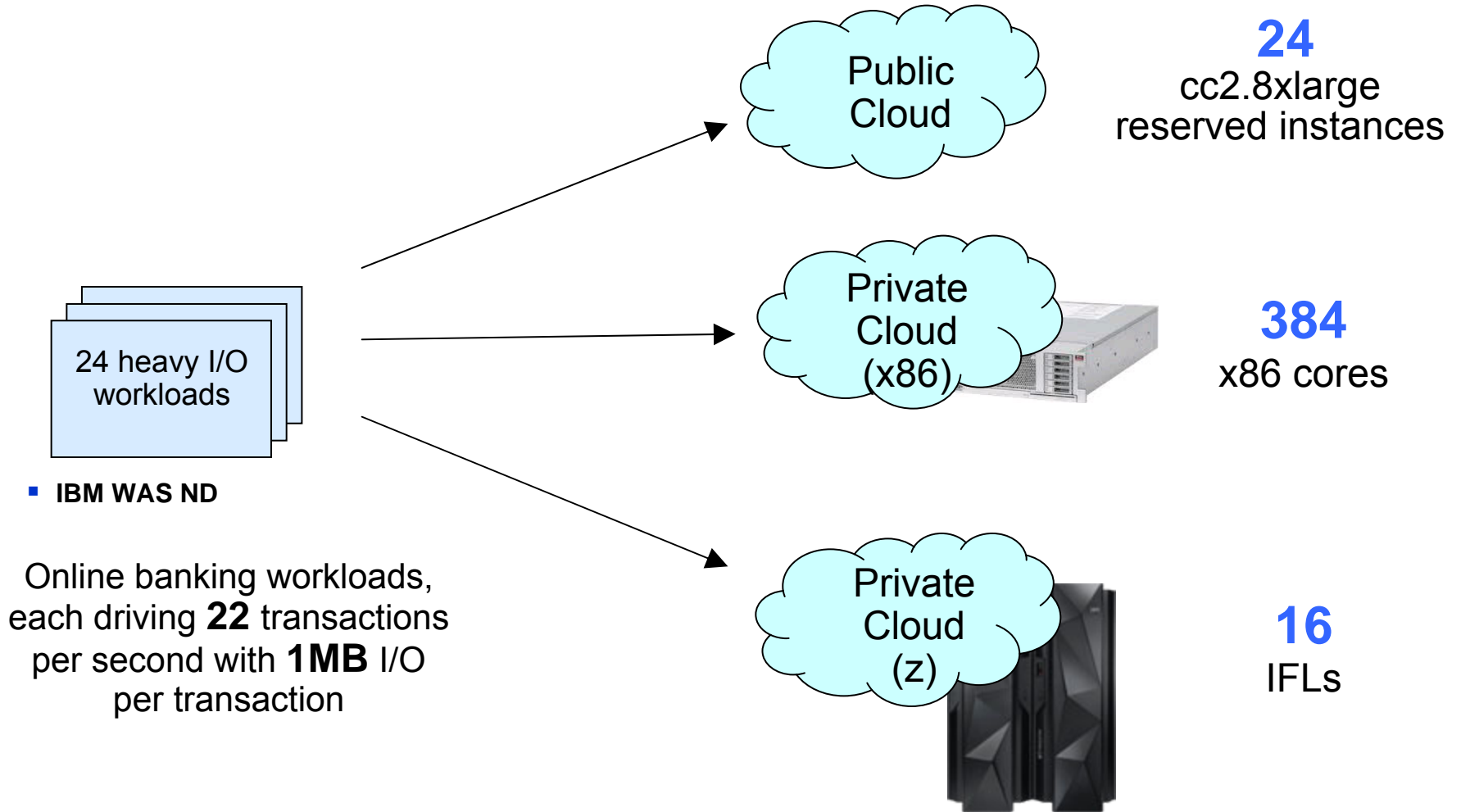

■ IBM WAS ND

Online banking workloads, each driving **22** transactions per second with **1MB** I/O per transaction

Server configurations are based on consolidation ratios derived from IBM internal studies.

# A private cloud on System z yields the lowest costs

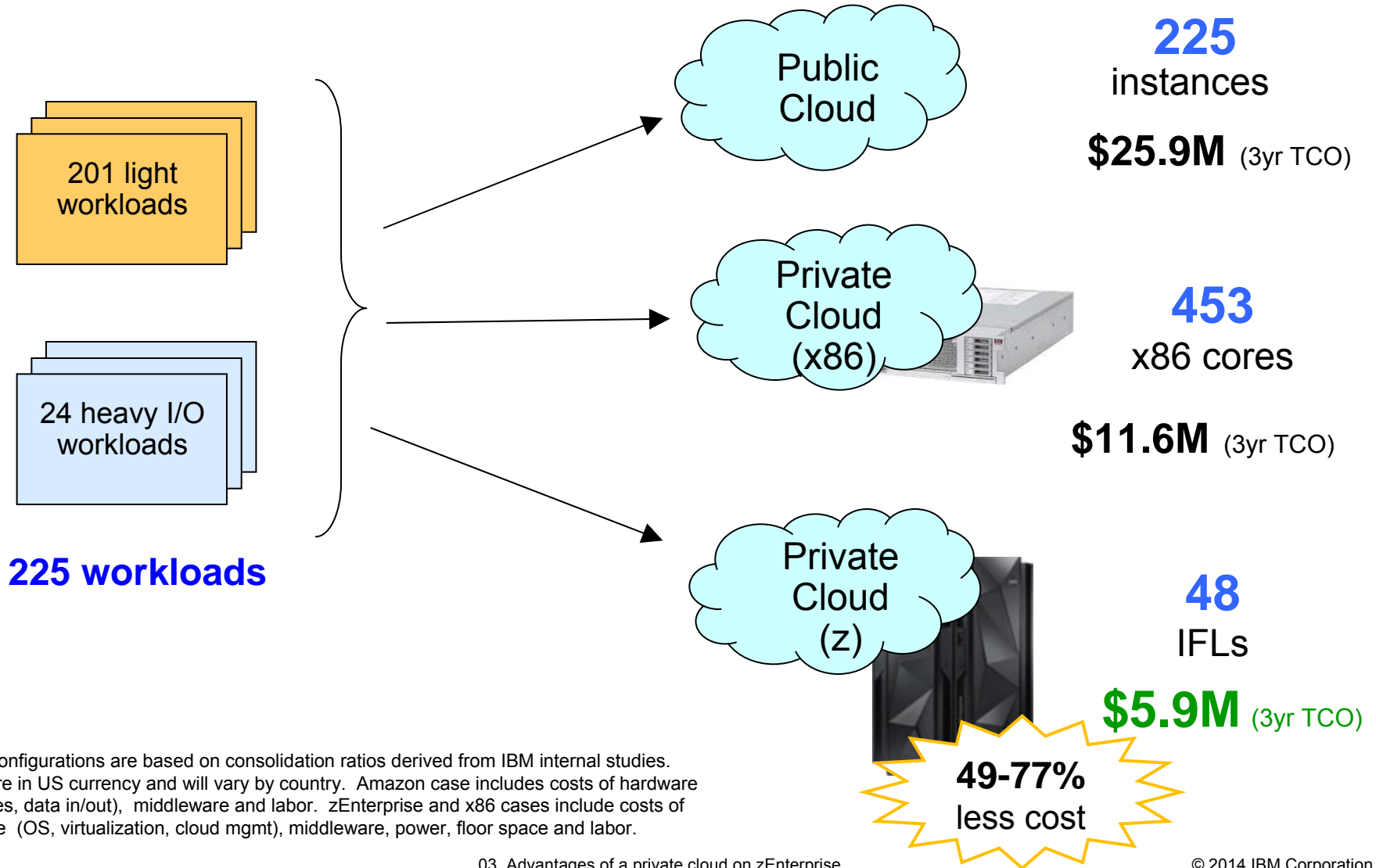

# Reduce costs with a System z private cloud

## Case Study: 225 Workloads

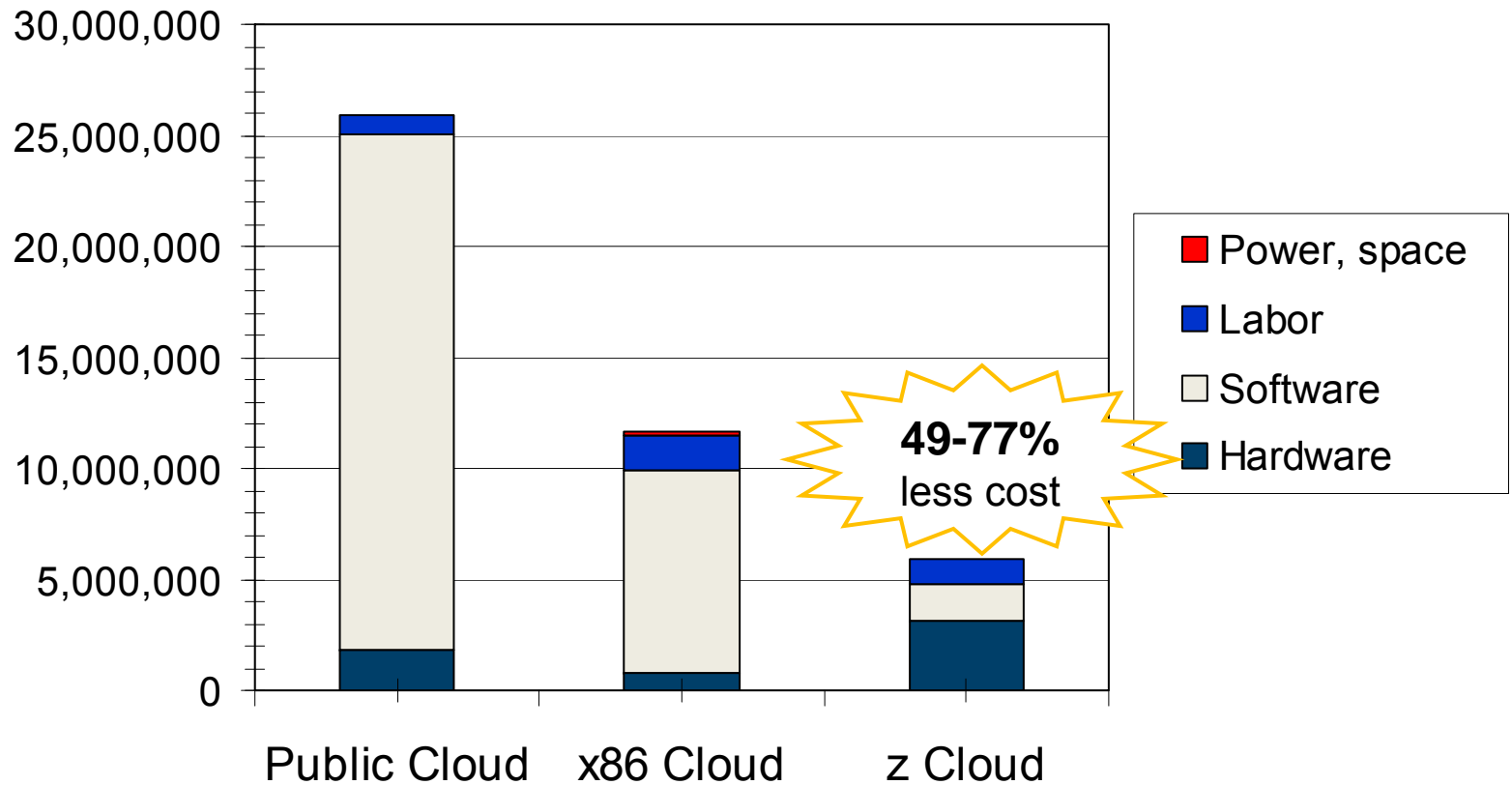

Server configurations are based on consolidation ratios derived from IBM internal studies. Prices are in US currency and will vary by country. Amazon case includes costs of hardware (instances, data in/out), middleware and labor. zEnterprise and x86 cases include costs of hardware (OS, virtualization, cloud mgmt), middleware, power, floor space and labor.

# Key steps to deliver a robust private cloud on system z

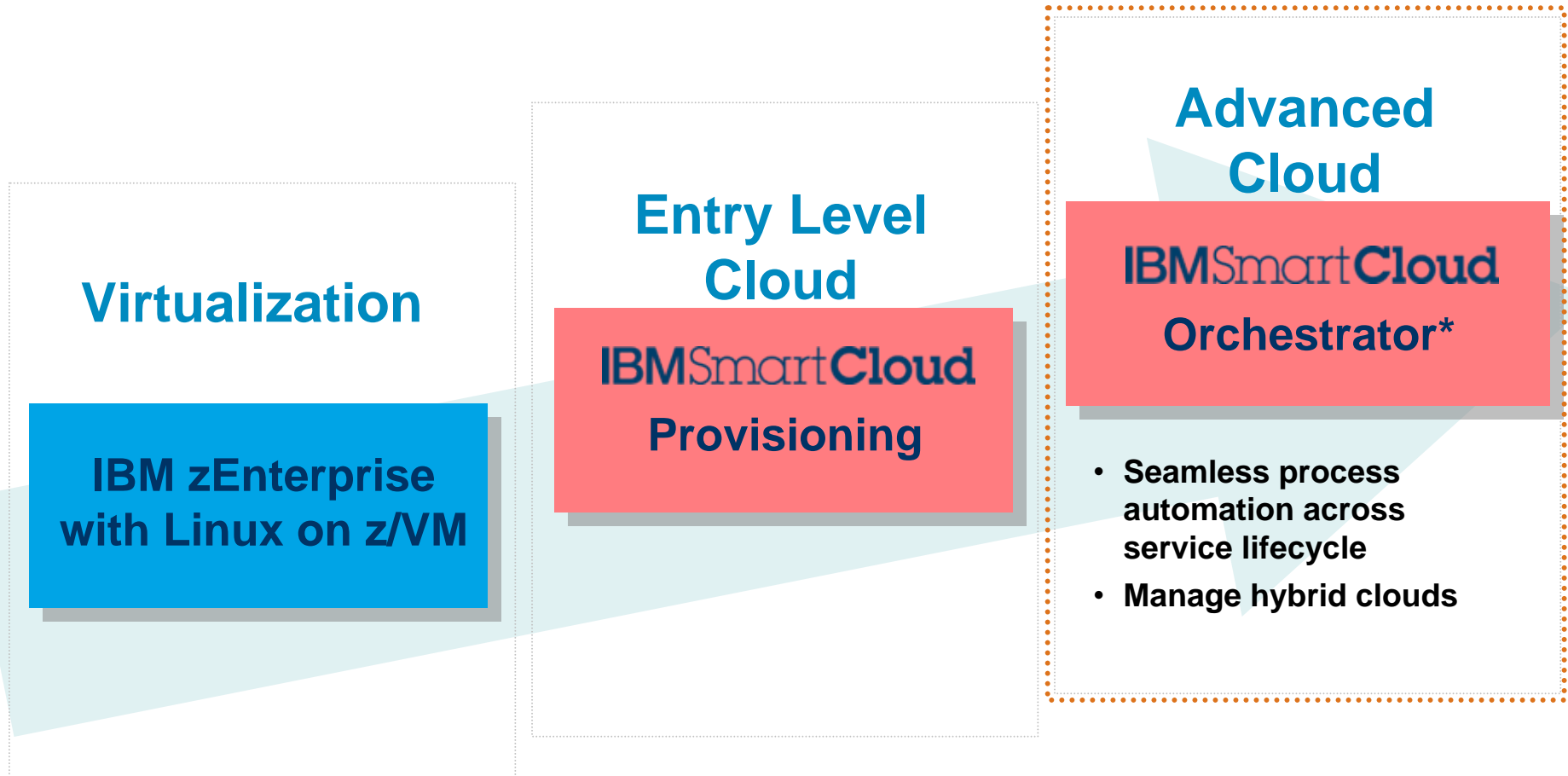

***Reduce costs and improve agility***

\*Under development on Linux on System z

# Managing workloads across the lifecycle

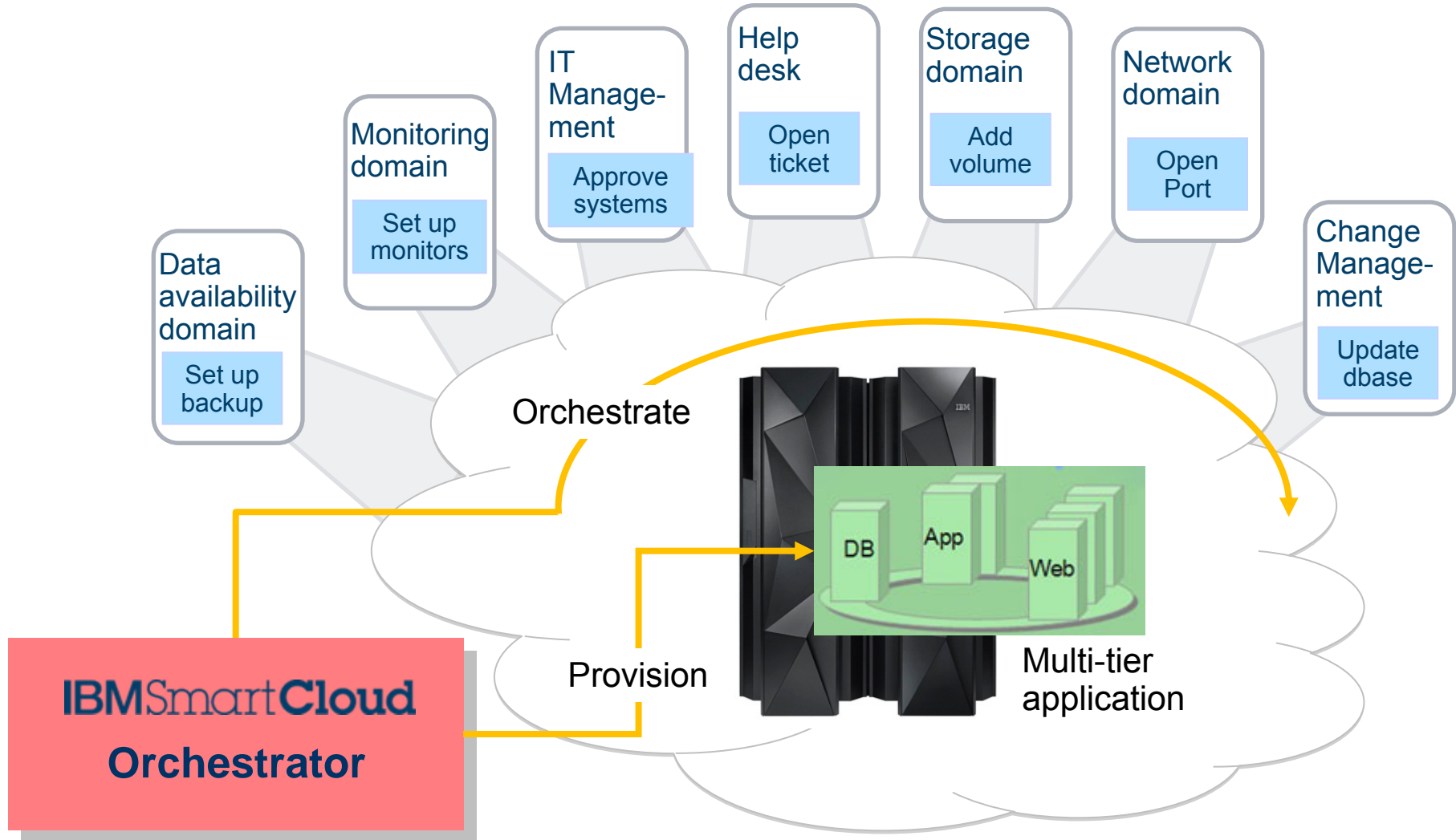



# IBM SmartCloud Orchestrator\*



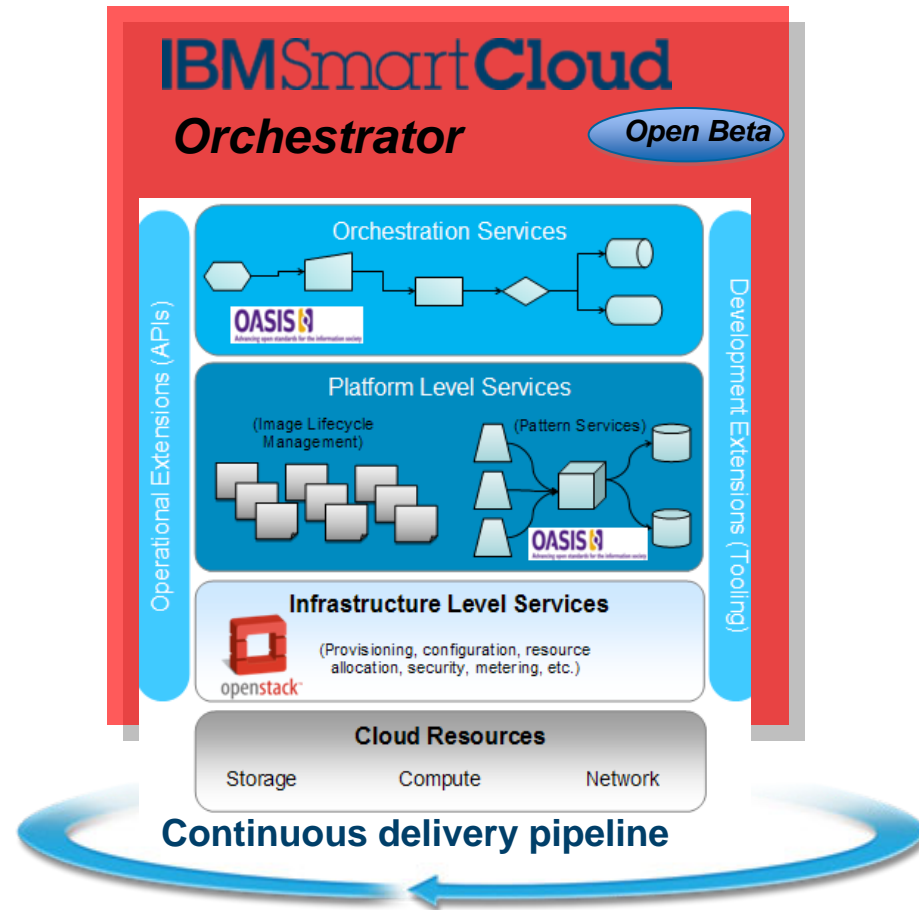

- New cloud offering based on open standard OpenStack
- Fully automates end-to-end service deployment across infrastructure and platform layers
- Accelerated deployments with reusable workload patterns and orchestration workflows
- Supports deployment to both private and public clouds
- Comprehensive monitoring and cost management
  - SmartCloud Monitoring
  - SmartCloud Cost Management



\*Under development on Linux on System z

# Check out the SmartCloud Orchestrator beta program

Public Community Site:  
<http://ibm.co/CPandO>

- 
**Use the hosted beta system**  
 Access a hosted system installed and configured with the latest evaluation code.  
 → More ...
- 
**Download beta code**  
 Download and install the latest beta code for evaluation in your own environment.  
 → More ...
- 
**Attend a live session**  
 See demos and designs, explore prototype UIs, share your feedback and discuss in live meetings with development.  
 → More ...
- 
**Comment and discuss**  
 Get engaged in existing discussion threads or start new ones.  
 → More ...
- 
**Watch videos and explore capabilities in the works**  
 Review brief feature demos at your leisure and provide feedback with a few mouse-clicks.  
 → More ...

## How to get started

- ***Think it***
  - No one-size-fits all
  - zEnterprise is ideal for enterprise workloads requiring high level of security, reliability, scalability, performance
  
- ***Build it***
  - zEnterprise or Enterprise Linux Server
  - SmartCloud Provisioning/Orchestrator
  
- ***Tap into it***
  - Strategically mix clouds to deliver business outcome
  - Open standards are important for dynamic hybrid cloud strategy
  - SmartCloud Orchestrator built on open standards