

# BUILDING SOFTWARE WITH CLEARCASE

*Release 4.0 and later*

Windows Edition

**Rational**  
unifying software teams

800-012614-000

**Building Software with ClearCase**  
**Document Number 800-012614-000 December 1999**  
**Rational Software Corporation 20 Maguire Road Lexington, Massachusetts 02421**

**IMPORTANT NOTICE**

**Copyright Notice**

Copyright © 1992, 1999 Rational Software Corporation. All rights reserved.  
Copyright 1989, 1991 The Regents of the University of California  
Copyright 1984–1991 by Raima Corporation  
Copyright 1992 Purdue Research Foundation, West Lafayette, Indiana 47907

**Trademarks**

Rational, the Rational logo, Atria, ClearCase, ClearCase MultiSite, ClearCase Attache, Clear DDTs, ClearQuest, ClearGuide, PureCoverage, Purify, Quantify, Rational Rose, and SoDA are trademarks or registered trademarks of Rational Software Corporation in the United States and in other countries. All other names are used for identification purposes only and are trademarks or registered trademarks of their respective companies.

Microsoft, MS, ActiveX, BackOffice, Developer Studio, Visual Basic, Visual C++, Visual InterDev, Visual J++, Visual Studio, Win32, Windows, and Windows NT are trademarks or registered trademarks of Microsoft Corporation.

Sun, Solaris, and Java are trademarks or registered trademarks of Sun Microsystems, Inc.

Oracle and Oracle7 are trademarks or registered trademarks of Oracle Corporation.

Sybase and SQL Anywhere are trademarks or registered trademarks of Sybase Corporation.

**U.S. Government Rights**

Use, duplication, or disclosure by the U.S. Government is subject to restrictions set forth in the applicable Rational License Agreement and in DFARS 227.7202-1(a) and 227.7202-3(a) (1995), DFARS 252.227-7013(c)(1)(ii) (Oct 1988), FAR 12.212(a) 1995, FAR 52.227-19, or FAR 52.227-14, as applicable.

**Patent**

U.S. Patent Nos. 5,574,898 and 5,649,200 and 5,675,802. Additional patents pending.

**Warranty Disclaimer**

This document and its associated software may be used as stated in the underlying license agreement, and, except as explicitly stated otherwise in such license agreement, Rational Software Corporation expressly disclaims all other warranties, express or implied, with respect to the media and software product and its documentation, including without limitation, the warranties of merchantability or fitness for a particular purpose or arising from a course of dealing, usage or trade practice.

**Technical Acknowledgments**

This software and documentation is based in part on BSD Networking Software Release 2, licensed from the Regents of the University of California. We acknowledge the role of the Computer Systems Research Group and the Electrical Engineering and Computer Sciences Department of the University of California at Berkeley and the Other Contributors in its development.

This software and documentation is based in part on software written by Victor A. Abell while at Purdue University. We acknowledge his role in its development.

# Contents

<b>Preface</b> .....	xiii
About This Manual .....	xiii
ClearCase Documentation Roadmap .....	xiv
Typographical Conventions .....	xv
Online Documentation .....	xvi
Technical Support .....	xvii
<b>1. ClearCase Build Concepts</b> .....	1
1.1 Overview of the ClearCase Build Scheme .....	2
1.2 Dependency Tracking of MVFS and Non-MVFS Files .....	3
Automatic Detection of MVFS Dependencies .....	4
Tracking Non-MVFS Files .....	4
1.3 Derived Objects and Configuration Records .....	4
1.4 Build Avoidance .....	5
Hierarchical Builds .....	6
Automatic Dependency Detection .....	6
1.5 Express Builds .....	7
1.6 Build Auditing with clearaudit .....	7
1.7 Compatibility with Other make Programs .....	8
<b>2. Derived Objects and Configuration Records</b> .....	9
2.1 Derived Objects Overview .....	9
Derived Object Naming .....	10
2.2 Configuration Records .....	11
Configuration Record Example .....	12
Contents of a Configuration Record .....	13
Header Section .....	13
MVFS Objects Section .....	14

	Non-MVFS Objects Section .....	14
	Variables and Options Section.....	14
	Build Script Section .....	14
	Configuration Record Hierarchies .....	15
	Configuration Record Cache.....	18
2.3	Kinds of Derived Objects.....	18
	Shareable DOs.....	18
	Nonshareable DOs.....	19
	Storage of Derived Objects .....	19
	Promotion and Winkin .....	20
	DO Versions .....	23
2.4	Reuse of DO-IDs .....	23
2.5	Derived Object Reference Counts .....	24
<b>3.</b>	<b>Pointers on Using ClearCase Build Tools .....</b>	<b>27</b>
3.1	Running omake or clearmake .....	27
	A Simple clearmake Build Scenario .....	28
3.2	Accommodating Build Avoidance.....	30
	Increasing the Verbosity Level of a Build .....	30
	Handling Temporary Changes in the Build Procedure .....	30
	Using a Build Options Specification (BOS) File .....	31
	Using a Separate makefile to Specify Build Options.....	31
	Handling Targets Built in Multiple Ways.....	32
	Using a Recursive Invocation of omake or clearmake .....	32
	Optimizing Winkin by Avoiding Pseudotargets .....	33
	Accommodating the Build Tool's Different Name.....	33
3.3	Declaring Source Dependencies in Makefiles .....	34
	Source Dependencies Declared Explicitly .....	34
	Explicit Dependencies on Searched-For Sources .....	35
3.4	Build-Order Dependencies.....	37
3.5	clearmake Build Script Execution and cmd.exe .....	37
3.6	Build Scripts and the rm Command .....	38
3.7	Pathnames in CRs.....	38

3.8	Problems with Forced Builds .....	38
3.9	How clearmake Interprets Double-Colon Rules .....	39
3.10	Continuing to Work During a Build.....	39
3.11	Using Config Spec Time Rules .....	40
	Inappropriate Use of Time Rules .....	41
3.12	Build Sessions, Subsessions, and Hierarchical Builds .....	42
	Subsessions.....	42
	Versions Created During a Build Session.....	42
	Coordinating Reference Times of Several Builds .....	43
	Objects Written at More than One Level .....	43
3.13	Build Auditing and Background Processes.....	44
3.14	Working with Incremental Update Tools.....	45
	Example: Incremental Linking .....	46
	Additional Incremental-Update Situations .....	46
3.15	Temporary Build Audit Files.....	46
3.16	Auditing 16-bit Tools.....	46
3.17	Adding a Version String or Time Stamp to an Executable .....	47
	Implementing a -Ver Option.....	48
<b>4.</b>	<b>Working with Derived Objects and Configuration Records .....</b>	<b>49</b>
4.1	Setting Correct Permissions for Derived Objects .....	49
4.2	Listing and Describing Derived Objects .....	50
	Listing Derived Objects Created at a Certain Pathname.....	50
	Listing a Derived Object's Kind .....	51
	Displaying a DO's OID.....	52
	Displaying a Description of a DO Version .....	52
4.3	Identifying the Views that Reference a Derived Object .....	52
4.4	Specifying a Derived Object in Commands .....	53
4.5	Winking in a DO Manually .....	54
4.6	Preventing Winkin.....	54
	Preventing Winkin to Your View .....	55
	Preventing Winkin to Other Views .....	55

	Using Express Builds to Prevent Winkin to Other Views .....	55
	Enabling Express Builds .....	56
	Configuring an Existing View for Express Builds .....	56
	Creating a New View that Uses Express Builds .....	56
	Preventing Winkin to or from Other Architectures .....	57
4.7	Converting Derived Objects to View-Private Files.....	57
4.8	Working with DO Versions.....	58
	Creating DO Versions .....	58
	Checking In DOs During a Build .....	58
	Accessing DO Versions.....	59
	Displaying Configuration Records for DO Versions.....	60
	Releasing DOs .....	61
4.9	Converting Nonshareable DOs to Shared DOs.....	62
	Automatic Conversion of Nonshareable DOs to Shareable DOs .....	62
4.10	Displaying VOB Disk Space Usage for Derived Objects .....	63
4.11	Deleting Derived Objects.....	63
	Removing Data Containers for Derived Objects.....	63
	Scrubbing Derived Objects and Data Containers .....	64
	Degenerate Derived Objects.....	64
	Data Container Deleted .....	64
	DO Deleted from VOB Database.....	64
	CR Unavailable .....	65
4.12	Displaying Contents of Configuration Records .....	65
4.13	Comparing Configuration Records.....	65
4.14	Attaching Labels or Attributes to Versions in a CR .....	66
4.15	Configuring a View to Select Versions Used to Build a DO .....	66
4.16	Including a Makefile Version in a Configuration Record.....	66
<b>5.</b>	<b>clearmake Makefiles and BOS Files .....</b>	<b>69</b>
5.1	Makefile Overview .....	69
5.2	Build Options Specification Files .....	70
5.3	Format of Makefiles.....	71
	Restrictions .....	71
	Libraries .....	72

	Command Echoing and Error Handling .....	72
	Built-In Rules .....	73
	Include Files .....	73
	Macros.....	73
	Order of Precedence of Make Macros and Environment Variables ..	73
	Make Macros.....	74
	Internal Macros.....	75
	VPATH Macro .....	76
	Special Targets .....	76
	Special Targets for Use in Makefiles .....	77
	Special Targets for Use in Makefiles or BOS Files.....	77
5.4	Using Makefiles on Windows .....	80
	Case-Sensitivity Guidelines .....	81
	Build Macros and Case-Sensitivity .....	81
	Makefile Target/Dependency Pathnames .....	81
	Supporting Both omake and clearmake.....	82
	Using UNIX-Style Command Shells in Makefiles.....	82
5.5	BOS File Entries .....	83
	Standard Macro Definitions.....	83
	Target-Dependent Macro Definitions .....	83
	Shell Command Macro Definitions .....	84
	Special Targets .....	84
	Include Directives .....	84
	Comments .....	84
<b>6.</b>	<b>Using clearmake Compatibility Modes .....</b>	<b>85</b>
6.1	Free Software Foundation Gnu make .....	86
	VPATH Separator Character .....	86
	Supported Gnu Make Command-Line Options .....	86
	Unsupported Gnu Make Command-Line Options .....	87
	Supported Gnu Make Features .....	88
	Unsupported Gnu Make Features .....	91

<b>7. Using ClearCase to Build C++ Programs .....</b>	<b>93</b>
7.1 Using clearmake or omake Instead of Other make Programs .....	94
7.2 Using Visual C++ with ClearCase .....	94
omake .....	95
clearmake .....	95
Incremental Repositories in Visual C++ .....	96
Alternative: Using C7 Compatible Debug Information .....	96
Using vcmake.mak to Prevent Reuse Mismatches .....	97
Browser Files .....	98
Using the winkin Command .....	98
<b>8. Using ClearCase Build Tools with Java .....</b>	<b>99</b>
8.1 ClearCase Build Problems with Java .....	99
Java Toolkits .....	100
Scope of the Problems .....	100
8.2 Benefits of Using make Tools with javac .....	101
Using javac Inside a Makefile .....	101
Using javac with clearmake or omake Instead of make .....	101
8.3 Unnecessary Rebuilds and Prevention of Winkin .....	102
8.4 Building Java Applications Successfully .....	102
Writing Correct Makefiles .....	103
No Mutually Dependent Files .....	103
Mutually Dependent Files .....	104
Allowing Rebuilds .....	104
Configuring Makefiles to Behave Like make .....	105
8.5 Java Compilers and Case-Sensitivity Issues .....	106
<b>Index .....</b>	<b>107</b>



# Figures

<b>Figure 1</b>	Building Software with ClearCase: Isolation and Sharing .....	3
<b>Figure 2</b>	Extended Pathname of a Derived Object .....	10
<b>Figure 3</b>	Kinds of Information in a Configuration Record .....	12
<b>Figure 4</b>	Configuration Record Hierarchy .....	16
<b>Figure 5</b>	Storage of a Shareable Derived Object.....	21
<b>Figure 6</b>	Storage of a Nonshareable Derived Object .....	22
<b>Figure 7</b>	clearmake Build Scenario.....	29



# Tables

<b>Table 1</b>	MVFS Settings and Case Requirements for Makefiles .....	82
<b>Table 2</b>	Using vcmake.mak .....	97



# Preface

ClearCase is a comprehensive software version control and configuration management system.

---

## About This Manual

This manual provides an overview of ClearCase build management features and describes how to use ClearCase's build tools. It is for new or experienced users of ClearCase who are familiar with software build concepts.

If you are not familiar with ClearCase build concepts and tools, read Chapter 1, *ClearCase Build Concepts*, Chapter 2, *Derived Objects and Configuration Records*, and Chapter 3, *Pointers on Using ClearCase Build Tools*.

For information about using ClearCase build tools with C++ programs or with Java tools, read Chapter 7, *Using ClearCase to Build C++ Programs* or Chapter 8, *Using ClearCase Build Tools with Java*.

# ClearCase Documentation Roadmap

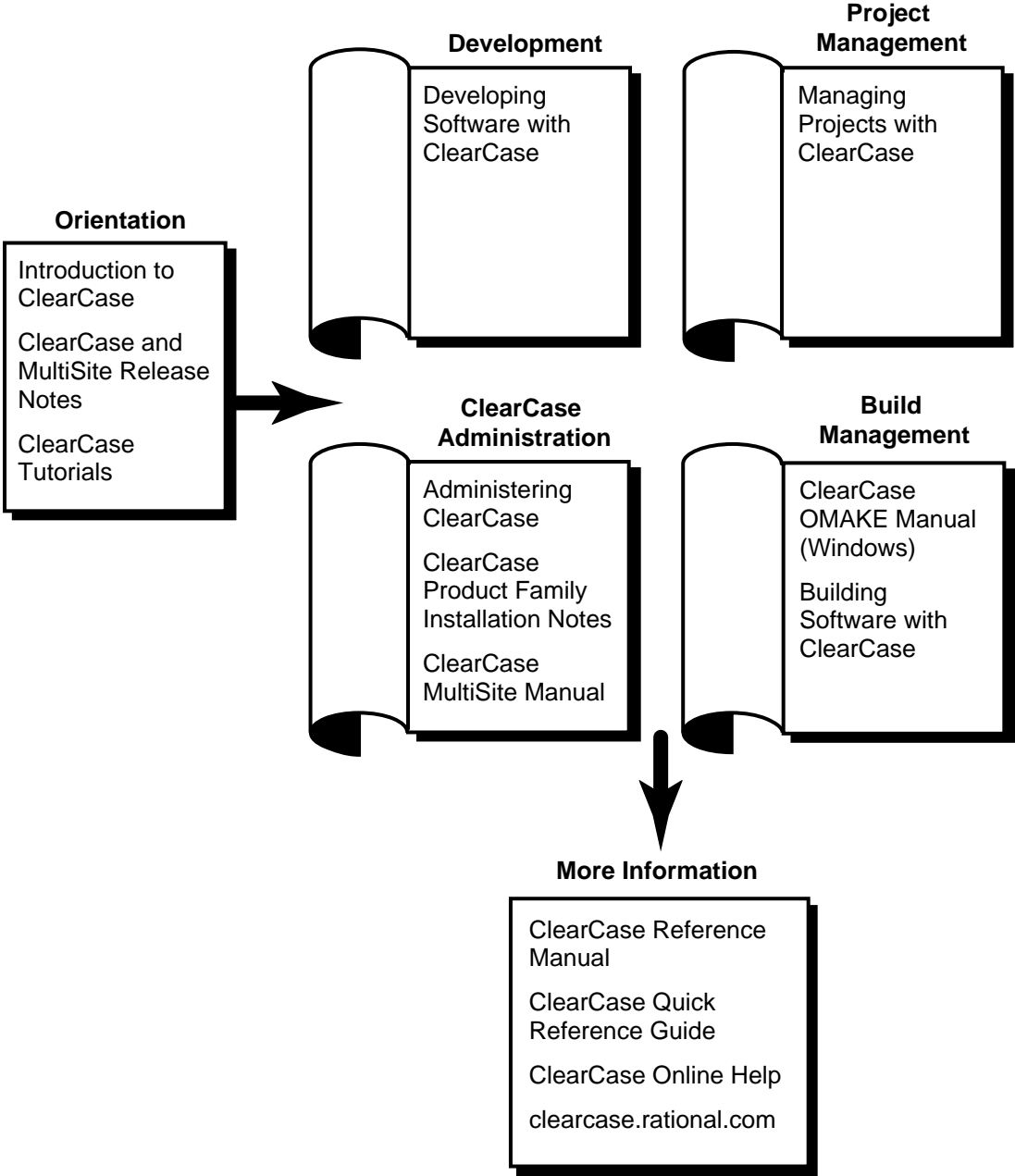

---

## Typographical Conventions

This manual uses the following typographical conventions:

- *ccase-home-dir* represents the directory into which the ClearCase Product Family has been installed. By default, this directory is **C:\Program Files\Rational\ClearCase**.
- *attache-home-dir* represents the directory into which ClearCase Attache has been installed. By default, this directory is **C:\Program Files\Rational\Attache**, except on Windows 3.x, where it is **C:\RATIONAL\ATTACHE**.
- **Bold** is used for names the user can enter; for example, all command names, file names, and branch names.
- *Italic* is used for variables, document titles, glossary terms, and emphasis.
- A monospaced font is used for examples. Where user input needs to be distinguished from program output, **bold** is used for user input.
- Nonprinting characters are in small caps and appear as follows: <EOF>, <NL>.
- Key names and key combinations are capitalized and appear as follows: F1, SHIFT, CTRL+G.
- [ ] Brackets enclose optional items in format and syntax descriptions.
- { } Braces enclose a list from which you must choose an item in format and syntax descriptions.
- | A vertical bar separates items in a list of choices.
- ... In a syntax description, an ellipsis indicates you can repeat the preceding item or line one or more times. Otherwise, it can indicate omitted information.

**NOTE:** In certain contexts, ClearCase recognizes “...” within a pathname as a wildcard, similar to “\*” or “?”. See the **wildcards\_ccase** reference page for more information.

- If a command or option name has a short form, a “medial dot” ( · ) character indicates the shortest legal abbreviation. For example:

### **lsc·heckout**

This means that you can truncate the command name to **lsc** or any of its intermediate spellings (**lsch**, **lsche**, **lschec**, and so on).

---

## Online Documentation

The ClearCase graphical interface includes a standard Windows help system.

There are three basic ways to access the online help system: the **Help** menu, the **Help** button, or the F1 key. **Help**→**Help Topics** provides access to the complete set of ClearCase online documentation. For help on a particular context, press F1. Use the **Help** button on various dialog boxes to get information specific to that dialog box.

ClearCase also provides access to full “reference pages” (detailed descriptions of ClearCase commands, utilities, and data structures) with the **cleartool man** subcommand. Without any argument, **cleartool man** displays the **cleartool** overview reference page. Specifying a command name as an argument gives information about using the specified command. For example:

- > **cleartool man** *(display the cleartool overview page)*
- > **cleartool man man** *(display the cleartool man reference page)*
- > **cleartool man checkout** *(display the cleartool checkout reference page)*

ClearCase’s **-help** command option or **help** command displays individual subcommand syntax. Without any argument, **cleartool help** displays the syntax for all **cleartool** commands. **help checkout** and **checkout -help** are equivalent.

```
> cleartool lsprivate -help  
Usage: lsprivate [-tag view-tag] [-invob vob-selector] [-long | -short]  
               [-size] [-age] [-co] [-do] [-other]
```

Additionally, the online *ClearCase Tutorial* provides important information on setting up a user’s environment, along with a step-by-step tour through ClearCase’s most important features. To start the *ClearCase Tutorial*, choose **Tutorial** from the **Getting Started** tab of the ClearCase Home Base.



---

## Technical Support

If you have any problems with the software or documentation, please contact Rational Technical Support via telephone, fax, or electronic mail as described below. For information regarding support hours, languages spoken, or other support information, click the **Technical Support** link on the Rational Web site at **[www.rational.com](http://www.rational.com)**.

<b>Your Location</b>	<b>Telephone</b>	<b>Facsimile</b>	<b>Electronic Mail</b>
North America	800-433-5444 toll free or 408-863-4000 Cupertino, CA	408-863-4194 Cupertino, CA 781-676-2460 Lexington, MA	<b><a href="mailto:support@rational.com">support@rational.com</a></b>
Europe, Middle East, and Africa	+31-(0)20-4546-200 Netherlands	+31-(0)20-4546-201 Netherlands	<b><a href="mailto:support@europe.rational.com">support@europe.rational.com</a></b>
Asia Pacific	61-2-9419-0111 Australia	61-2-9419-0123 Australia	<b><a href="mailto:support@apac.rational.com">support@apac.rational.com</a></b>



## ClearCase Build Concepts

# 1

ClearCase® supports *makefile*-based building of software systems, and provides a software build environment closely resembling that of the **make** program. **make** was developed for UNIX systems, and has been ported to other operating systems. You can use ClearCase-controlled files to build software, and use native **make** programs, third-party build utilities, your company's own build programs, or the ClearCase build tools **clearmake**, **omake**, and **clearaudit**.

The ClearCase build tools, **clearmake** and **omake**, provide compatibility with other **make** variants, along with powerful enhancements:

- *Build auditing*, with automatic detection of source dependencies, including header file dependencies
- Automatic creation of permanent bill-of-materials documentation of the build process and its results
- Sophisticated build-avoidance algorithms to guarantee correct results when building in a parallel development environment
- Sharing of binaries among views, saving both time and disk storage

The **clearaudit** build tool provides build auditing and creation of bill-of-materials documentation.

**clearmake**, **omake**, and **clearaudit** are intended for use in *dynamic views*. You can use them in a *snapshot view*, but the features that distinguish them from ordinary **make** programs (build avoidance, build auditing, derived object sharing, and so on) are not enabled in snapshot views.

Both **clearmake** and **omake** incorporate the major ClearCase build-related features described in the following sections. The **omake** program's strength lies primarily in its support for users who

require compatibility with other PC-based build programs. For **omake**-specific details, see the *ClearCase OMAKE Manual*. In all other build-related documentation, the primary emphasis is on **clearmake** behavior.

---

## 1.1 Overview of the ClearCase Build Scheme

Developers perform builds, along with all other ClearCase-related work, in *views*. Typically, developers work in separate, private views. Sometimes, a team shares a single view (for example, during a software integration period).

As described in *Developing Software with ClearCase*, each view provides a complete environment for building software that includes a particular configuration of source versions and a private work area in which you can modify source files, and use build tools to create object modules, executables, and so on.

As a build environment, each view is partially isolated from other views. Building software in one view never disturbs the work in another view, even another build of the same program at the same time. However, when working in a dynamic view, you can examine and benefit from work done previously in another dynamic view. A new build shares files created by past builds, when appropriate. This sharing saves the time and disk space involved in building new objects that duplicate existing ones.

You can (but need not) determine what other builds have taken place in a directory, across all dynamic views. ClearCase includes tools for listing and comparing past builds.

The key to this scheme is that the project team's VOBs constitute a globally accessible repository for files created by builds, in the same way that they provide a repository for the source files that go into builds. A file produced by a software build is a *derived object (DO)*. Associated with each derived object is a *configuration record (CR)*, which **clearmake** or **omake** uses during subsequent builds to decide whether the DO can be reused or shared.

Figure 1 illustrates the ClearCase software build scheme.

Figure 1 Building Software with ClearCase: Isolation and Sharing

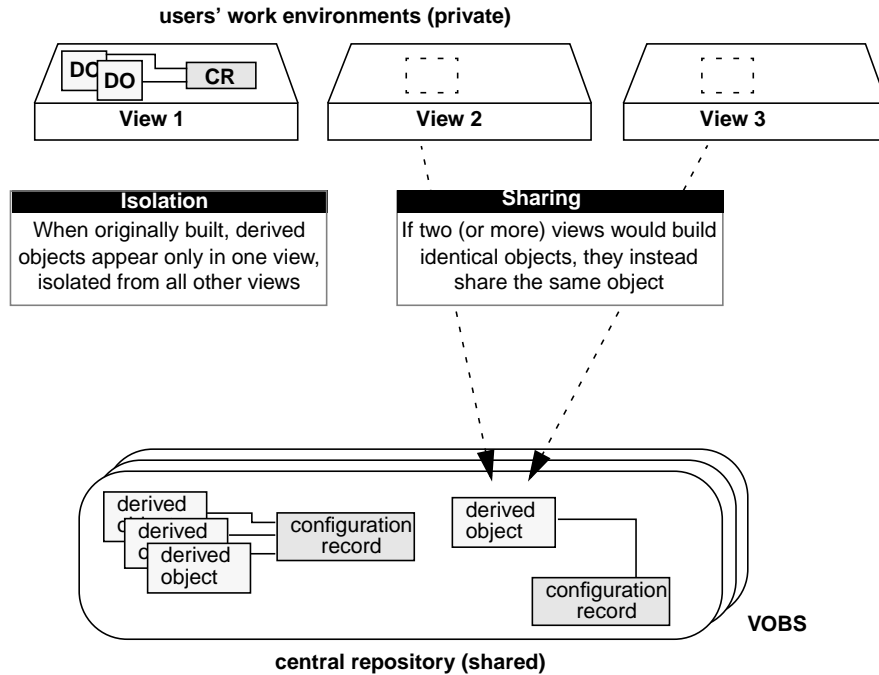

*Dependency Tracking of MVFS and Non-MVFS Files* describes how ClearCase keeps track of the objects produced by software builds. *Build Avoidance* on page 5 describes the mechanism that enables such objects to be shared among views.

---

## 1.2 Dependency Tracking of MVFS and Non-MVFS Files

During build-script execution in a dynamic view, a host's *MVFS* (*multiversion file system*) audits low-level system calls performed on ClearCase data: **create**, **open**, **read**, and so on. Calls involving the following objects are monitored:

- Versions of elements used as build input
- View-private files used as build input (for example, the checked-out version of a file element)
- Files created within VOB directories during the build

Some of these objects are stored in the VOB, and others are view-private files. The view combines them into a *virtual work area*, where they appear to be located in VOB directories. They are called *MVFS files*, because they are accessed through the MVFS.

---

## Automatic Detection of MVFS Dependencies

Because auditing of MVFS files is completely automated, you don't have to keep track of exactly which files are being used in builds. ClearCase does the tracking instead. For example, ClearCase determines which C-language source files referenced with `#include` directives are used in a build. Tracking eliminates the need both to declare such files in the makefile, and for dependency-detection tools.

If you store your build tools (compilers, linkers, and so on) as ClearCase elements and run them from the VOB, they are recorded in the configuration record as implicit detected dependencies.

---

## Tracking Non-MVFS Files

A build can also involve files that are not accessed through VOB directories. Such non-MVFS files are not audited automatically, but are tracked if you declare them as dependencies in a makefile. This tracking enables auditing of build tools that are not stored as ClearCase elements (for example, a C-language compiler), flag files in the user's home directory, and so on. Tracking information on a non-MVFS file includes its absolute path, time stamp, size, and checksum.

---

## 1.3 Derived Objects and Configuration Records

When it finishes executing a build script, **clearmake** or **omake** records the results, including build audit information, in the form of derived objects and configuration records.

A derived object (DO) is a file created in a VOB during a build or build audit with **clearmake** or **omake**. Each DO has an associated configuration record (CR), which is the bill of materials for the DO. The CR documents aspects of the build environment, the assembly procedure for a DO, and all the files involved in the creation of the DO.

**NOTE:** All derived objects created by executing a build script have equal status, even though some of them may be explicit build targets, and others may be created as side effects of the build script

(for example, compiler listing files). The term *siblings* describes a group of DOs created by the same script and associated with a single CR.

For more detailed information about DOs and CRs, see Chapter 2, *Derived Objects and Configuration Records*.

---

## 1.4 Build Avoidance

The build tool attempts to avoid rebuilding derived objects. If an appropriate derived object exists in the view, **clearmake** or **omake** reuses that DO. If there is no appropriate DO in the view, **clearmake** or **omake** looks for an existing DO built in another view that can be winked in to the current view. The search process is called *shopping*.

The process of qualifying a candidate DO is called *configuration lookup*. It involves matching information in the VOB from the candidate DO's config record against the user's current *build configuration*. This process guarantees correct results in a parallel development environment, which the standard time-stamp-based algorithm used by **make** cannot do. Even if an object module is newer than a particular version of its source file, the module may have been built using a different version. In fact, reusing object modules and executables built recently is likely to be incorrect when rebuilding a previous release of an application from old sources. The configuration lookup algorithm that ClearCase uses guarantees that your builds will be both correct (inappropriate objects are not reused) and optimal (appropriate objects are always reused).

For a DO to be reused or winked in, the build configuration documented in its configuration record must match the current view's build configuration. The build configuration consists of:

Files	The versions of elements listed in the CR must match the versions selected by the view in which the build is performed. Any view-private files or non-MVFS files listed in the CR must also match.
Build procedure	The build options in the CR must match the build options specified on the command line, in the environment, in makefiles, or in build options specification files.  The build script listed in the CR must match the script that will be executed if the target is rebuilt. The scripts are compared with all make macros expanded; thus, a match occurs only if the same build options apply (for example, "compile for debugging").

The search ends when **clearmake** or **omake** finds a DO whose configuration matches the view's current build configuration exactly. In general, a configuration lookup can have three outcomes:

- **Reuse.** If the DO (and its siblings) in the view match the build configuration, **clearmake** or **omake** keeps them.
- **Winkin.** If a DO built previously matches the build configuration, **clearmake** or **omake** causes that DO and its siblings to appear in this view. This operation is termed *winkin*.

**NOTE:** The build tool does not contact all views to determine whether they contain DOs that can be winked in. Instead, it uses DO information in the VOB to eliminate inappropriate candidates. Only if it finds a candidate does it contact the containing view to retrieve the DO's config record.

- **Rebuild.** If configuration lookup fails to find a DO that matches the build configuration, **clearmake** or **omake** executes the target's build script, which creates one or more new DOs, and a new CR.

Reuse and winkin take place only if **clearmake** or **omake** determines that a newly built derived object would be identical to the existing one. Winkin takes place when two or more views select the same versions of source elements used in a build. For example, you can create a clone view, with the same configuration as an existing view. Initially, the new view sees all the sources, but contains no derived objects. Running **clearmake** or **omake** winks in many derived objects from the existing view.

---

## Hierarchical Builds

In a hierarchical build, some objects are built and then used to build others. The build tool performs configuration lookup separately for each target. To ensure a consistent result, the build tool also applies this principle: when a new object is created, all targets that depend on it are rebuilt. Note that winkin does not cause rebuilds of dependencies.

---

## Automatic Dependency Detection

Configuration records enable automatic checking of source dependencies as part of build avoidance. All such dependencies (for example, on C-language header files) are logged in a build's configuration record, whether or not they are explicitly declared in a *makefile*.



---

## 1.5 Express Builds

During a regular audited build, the build tool writes to the VOB information about a newly built DO. Configuration lookup by future builds uses that information to determine whether or not the DO is a candidate for winkin.

There is a performance tradeoff when you create DOs. While the build is writing the DO information to the VOB database, other users cannot write to the VOB. This performance loss is offset when the DO is used by subsequent builds, which can make the builds faster. However, if the DO is never used by another view, the performance loss is not offset.

ClearCase express builds create derived objects, but do not write information to the VOB. Therefore, these DOs are nonshareable and are not considered for winkin by other views. They can be reused by the view in which they were built.

Express builds offer two advantages over regular builds:

- Scalability: During an express build, write access to the VOB is not blocked by time-consuming DO write operations. More users can build in a VOB without making VOB access slower.
- Performance: Express builds are faster than regular builds, because the build does not write DO information into the VOB.

Which kind of build occurs when you invoke **clearmake** or **omake** depends on how your view is configured. To use express builds, you must use a dynamic view whose DO property is set to nonshareable. For information on enabling express builds, see *Using Express Builds to Prevent Winkin to Other Views* on page 55.

---

## 1.6 Build Auditing with clearaudit

Some organizations, or some developers, may want to use ClearCase build auditing without using the **clearmake** or **omake** program. Others may want to audit development activities that do not involve *makefiles*. These users can do their work in an *audited shell*, a standard task with build auditing enabled.

All MVFS files read during execution of the audited shell are listed as inputs to the build. All MVFS files created become derived objects, associated with the single configuration record.

For more information, see the **clearaudit** reference page.

---

## 1.7 Compatibility with Other make Programs

Many **make** utilities are available in the multiple-architecture, multiple-vendor world of open systems. ClearCase's **clearmake** and **omake** programs share features with many of them, and have some unique features.

You can adjust the level of compatibility that **clearmake** or **omake** has with other **make** programs:

- Suppress special features of **clearmake** or **omake**.

Use command options to turn off such features as **winkin**, comparison of build scripts, comparison of detected dependencies, and creation of DOs and CRs. You can turn off configuration lookup altogether, so that the standard time-stamp-based algorithm is used for build avoidance.

- Enable features of other make programs.

**clearmake** and **omake** have several compatibility modes, which provide for partial emulations of popular **make** programs, such as Gnu Make, Opus Make, Microsoft Nmake, and Borland Bmake. For more information, see Chapter 6, *Using clearmake Compatibility Modes*, and *ClearCase OMAKE Manual*.

To achieve absolute compatibility with other **make** programs, you can actually use them to perform builds. However, builds with a standard **make** do not provide build auditing, configuration lookup, or sharing of DOs. The MVFS files that the build creates are view-private files, not derived objects. However, you can execute the **make** program in a **clearaudit** shell, which performs an audited build.

## Derived Objects and Configuration Records

# 2

This chapter describes derived objects and configuration records. ClearCase creates derived objects and configuration records only if you build in a dynamic view with one of the ClearCase build tools. For information on managing derived objects and configuration records, see Chapter 4.

---

### 2.1 Derived Objects Overview

As described in Chapter 1, *ClearCase Build Concepts*, derived objects are created during builds with ClearCase build tools. They are used for build avoidance and derived object sharing.

In a parallel-development environment, it is likely that many DOs with the same pathname will exist at the same time. For example, suppose that source file `msg.c` is being developed on three branches concurrently, in three different views. ClearCase builds performed in those three views produce object modules named `msg.obj`. Each of these is a DO, and each has the same standard pathname, for example, `\proj\src\msg.obj`.

In addition, each DO can be accessed with ClearCase extended names:

- Within each dynamic view, a standard Windows NT pathname accesses the DO referenced by that view. This is another example of ClearCase's *transparency* feature.

`msg.obj`

*(the DO in the current view)*

- You can use a view-extended pathname to access a DO in any view:

```
M:\drp\proj\src\msg.obj           (the DO in view drp)
M:\R2_integ\proj\src\msg.obj      (the DO in view R2_integ)
```

---

## Derived Object Naming

No name collisions occur among derived objects built at the same pathname, because each DO is cataloged in the VOB database with a unique identifier, its *DO-ID*. The DO-ID references a DO independently of views. The **lsdo** (list derived objects) command can list all DOs created at a specified pathname, regardless of which views (if any) can select them:

```
Z:\myvob> cleartool lsdo hello.obj
07-May.16:09   akp   "hello.obj@@07-May.16:09.623" on neptune
06-May.12:47   akp   "hello.obj@@06-May.12:47.539" on neptune
01-May.21:49   akp   "hello.obj@@01-May.21:49.282" on neptune
03-Apr.21:40   akp   "hello.obj@@01-May.21:40.226" on neptune
```

Together, a DO's standard name (**hello.o**) and its DO-ID (**07-May.16:09.623**) constitute a **VOB-extended pathname** to that particular derived object. (The extended naming symbol is host specific; most organizations use the default value, @@.)

Figure 2 Extended Pathname of a Derived Object

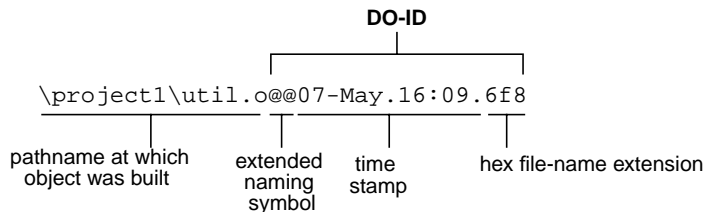

Standard software must access a DO through a dynamic view, using a standard pathname or view-extended pathname. You can use such names with debuggers, profilers, and so on. Only ClearCase programs can reference a DO using a VOB-extended pathname, and only the DO's metadata is accessible in this way:

**ClearCase commands can use the extended pathname of a derived object**

```
Z:\akp_hw\src> cleartool describe hello.exe@@07-Mar.11:40.217
created 07-Mar-96.11:40.217 by akp.users@phobos
references: 1 => C:\users\views\akp\tut\old.vws
```

```

Z:\akp_hw\src> cleartool catr hello.exe@@07-Mar.11:40.217
Target hello.exe built by akp.user
Host "cobalt" running NT 3.50 (i586)
Reference Time 07-Mar-96.11:40:41, this audit started
  07-Mar-96.11:40:46
View was C:\users\views\akp\tut\old.vws
Initial working directory was M:\akp_main\akp_hw\src
-----
MVFS objects:
-----
\akp_hw\src\hello.exe@@07-Mar.11:40.217
\akp_hw\src\hello.obj@@07-Mar.11:40.213
\akp_hw\src\util.obj@@07-Mar.11:40.215
-----
Variables and Options:
-----
MKTUT_LK=link
-----
Build Script:
-----
    link -out:hello.exe hello.obj util.obj
-----

```

**Standard programs cannot use the extended pathname of a derived object**

```

Z:\akp_hw\src> dir hello.exe@@07-Mar.11:40.217
...
File Not Found

```

**EXCEPTION:** You can use a view-extended pathname with the **winkin** command, to make the file system data of any DO available to your view. See *Winking in a DO Manually* on page 54.

---

## 2.2 Configuration Records

A configuration record (CR) is the bill of materials for a derived object or set of DOs. The CR documents aspects of the build environment, the assembly procedure for a DO, and all the files involved in the creation of the DO.

## Configuration Record Example

The **catcr** command displays the configuration record of a specified DO. Figure 3 shows a CR, with annotations to indicate the various kinds of information in the listing.

Figure 3 Kinds of Information in a Configuration Record

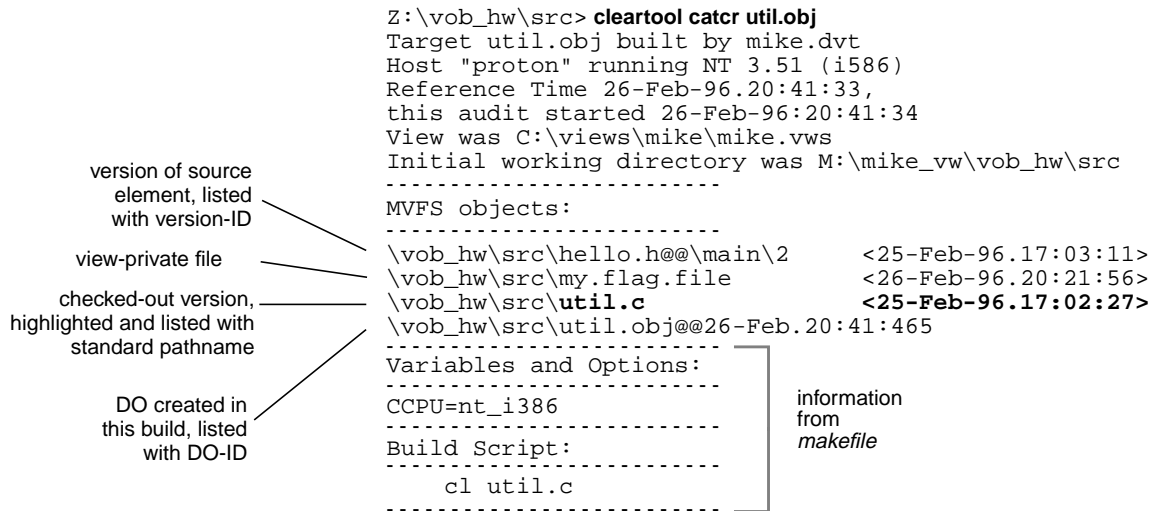

Some notes on Figure 3:

- Directory versions. By default, **catcr** does not list versions of the VOB directories involved in a build. To list this information, use the **-long** option:

### **cleartool catcr -long util.obj**

```
directory version \vob_hw\.\@\main\1          <25-Feb-96.16:59:31>
directory version \vob_hw\src@\main\3        <26-Feb-96.20:53:07>
...
```

- Declared dependencies. One of ClearCase's principal features is the automatic detection of source dependencies on MVFS files: versions of elements and objects in view-private storage.
- Listing of checked-out versions. Checked-out versions of file elements are highlighted. Checked-out versions of directory elements are listed like this:

```
directory version \vob_hw\src@\main\CHECKEDOUT <26-Feb-96.17:05:23>
```

When the elements are subsequently checked in, a listing of the *same* configuration record shows the updated information. For example,

```
\vob_hw\src\util.c <25-Feb-96.17:02:27>
```

becomes

```
\vob_hw\src\util.c@\main\4 <25-Feb-96.17:02:27>
```

The actual configuration record contains a ClearCase-internal identifier for each MVFS object. After the version is checked in, **catcr** lists that object differently.

**NOTE:** The time stamps in the configuration record are for informational purposes and are not used by ClearCase during rebuild or winkin decisions. ClearCase uses OIDs to track versions used in builds.

---

## Contents of a Configuration Record

The following sections describe the contents of configuration records.

### Header Section

As displayed by **catcr**, the header section of a CR includes the following lines:

- Makefile target associated with the build script and the user who started the build:

```
Target util.obj built by akp.dvt
```

For a CR produced by **clearaudit**, the target is `ClearAudit_Shell`.

- Host on which the build script was executed:

```
Host 'mars' running Windows NT 4.0
```

- Reference time of the build (the time **clearmake**, **omake**, or **clearaudit** began execution), and the time when the build script for this particular CR began execution:

```
Reference Time 15-Sep-93.08:18:56, this audit started 15-Sep-93.08:19:00
```

In a hierarchical build, involving execution of multiple build scripts, all the resulting CRs share the same reference time. (For more on reference time, see the **clearmake** reference page.)

- View storage directory of the view in which the build took place:

```
View was \\mars\views\930825.vws
```

- Working directory at the time build script execution or **clearaudit** execution began:

```
Initial working directory was s:\proj\hw\src
```

### **MVFS Objects Section**

An *MVFS object* is a file or directory in a VOB. The MVFS Objects section of a CR includes this information:

- Each MVFS file or directory read during the build. This includes versions of elements and view-private files used as build input, checked-out versions of file elements, DOs read, and any tools or scripts used during the build that are under version control.
- Each derived object produced by the target rebuild.

### **Non-MVFS Objects Section**

A *non-MVFS object* is an object not accessed through a VOB (compiler, system-supplied header file, temporary file, and so on). The Non-MVFS Objects section of a CR includes each non-MVFS file that appears as an explicit dependency in the makefile or is a dependency inferred from a suffix rule. See *Declaring Source Dependencies in Makefiles* on page 34.

This section is omitted if there are no such files or if the CR was produced by **clearaudit**.

### **Variables and Options Section**

The Variables and Options section of a CR lists the values of make macros referenced by the build script and command-line options.

This section is omitted from a CR produced by **clearaudit**.

### **Build Script Section**

The Build Script section of a CR lists the script that was read from a makefile and executed by **clearmake** or **omake**.

This section is omitted from a CR produced by **clearaudit**.



---

## Configuration Record Hierarchies

A typical makefile has a hierarchical structure. Thus, running **clearmake** or **omake** once to build a high-level target can cause multiple build scripts to be executed and, accordingly, multiple CRs to be created. Such a set of CRs can form a *configuration record hierarchy*, which reflects the structure of the makefile.

Figure 4 Configuration Record Hierarchy

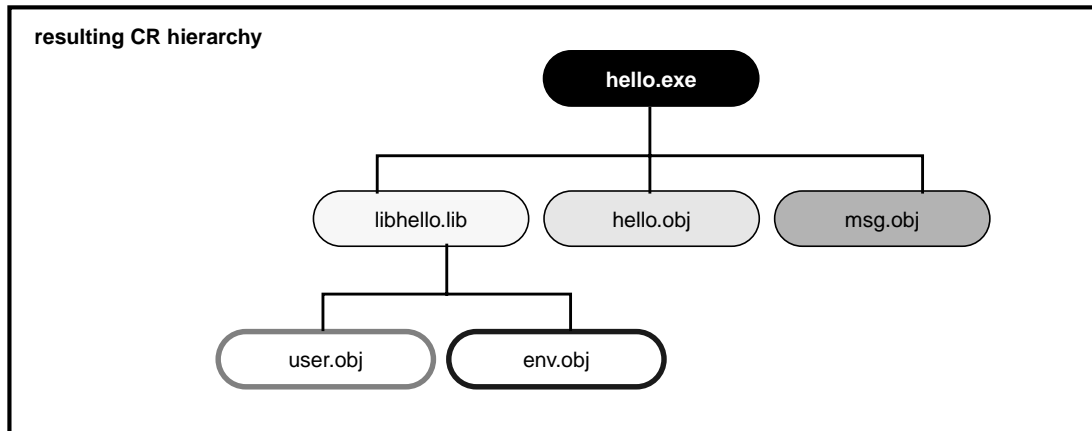
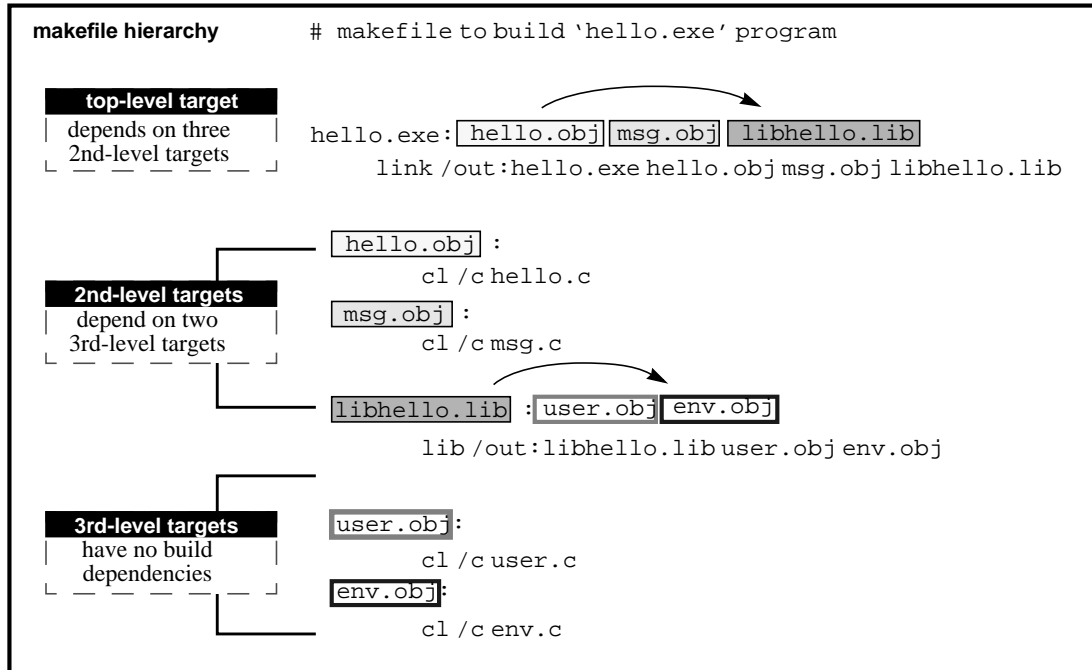

An individual parent-child link in a CR hierarchy is established in either of the following ways:

- In a target/dependencies line

For example, the following target/dependencies line declares derived objects **hello.obj**, **msg.obj**, and **libhello.lib** to be build dependencies of derived object **hello.exe**:

```
hello.exe: hello.obj msg.obj libhello.lib
...
```

Accordingly, the CR for **hello.exe** is the parent of the CRs for the **.obj** files and the **.lib** file.

- In a build script

For example, in the following build script, derived object **libhello.lib** in another directory is referenced in the build script for derived object **hello.exe**:

```
hello.exe: $(OBJS)
    cd ..\lib & $(MAKE) libhello.lib
    link /out: hello.exe $(OBJS) ..\lib\libhello.lib
```

Accordingly, the CR for **hello.exe** is the parent of the CR for **libhello.lib**.

**NOTE:** The recursive invocation of **clearmake** in the first line of this build script produces a separate CR hierarchy, which is not necessarily linked to the CR for **hello.exe**. The second line of the build script links the CR for **..\lib\libhello.lib** with that of **hello.exe** by causing **link** to read **..\lib\libhello.lib** and making it a detected dependency.

The **catcr** and **diffcr** commands have options for handling CR hierarchies:

- By default, they process individual CRs.
- With the **-recurse** option, they process the entire CR hierarchy of each derived object specified, keeping the individual CRs separate.
- With the **-flat** option, they combine (or flatten) the CR hierarchy of each specified derived object.

Some ClearCase features process entire CR hierarchies automatically. For example, when the **mklabel** command attaches version labels to all versions used to build a particular derived object (**mklabel -config**), it uses the entire CR hierarchy of the specified DO. Similarly, ClearCase maintenance procedures do not scrub the CR associated with a deleted DO if it is a member of the CR hierarchy of a higher-level DO.

---

## Configuration Record Cache

When a derived object is created in a view, both its data container and its associated configuration record are stored in the view's private storage area. The CR is stored in the view database, in compressed format. To speed configuration lookup during subsequent builds in this view, a compressed copy of the CR is also cached in a view-private file, `.cmake.state`, located in the directory that was current when the build started.

When a DO is winked in for the first time, the associated CR moves from the view's private storage area to the VOB database, as shown in Figure 5 and Figure 6.

---

## 2.3 Kinds of Derived Objects

The following sections describe the kinds of DOs and their lifecycles.

During a regular build, ClearCase build tools create shareable derived objects. During an express build, they create nonshareable derived objects. Both kinds of DOs have configuration records, but only shareable DOs can be winked in by other views.

---

### Shareable DOs

When a ClearCase build tool creates a shareable DO, it creates a configuration record for the DO and writes information about the DO into the VOB. (At this point, the DO is shareable but unshared.) Builds in other views use this information during configuration lookup. If the build determines that it can wink in an existing DO, it contacts the view containing the DO and promotes the DO to the VOB. (The DO is now shareable and shared.)

As noted in *Express Builds* on page 7, you must consider whether the performance benefit of winking in DOs is worth the performance cost of making them available for winking.

**NOTE:** The process of looking for a DO to wink in does not slow performance, because the build tool uses an efficient algorithm to eliminate mismatches.

The configuration lookup process cannot guarantee that the DO is suitable for use. The process uses details in the config record to determine whether a DO is suitable for winking, but the config record does not record all parameters of a build. For example, a config record may list only a

compiler's name and the options used. If two builds use incompatible compilers with the same name, unwanted winking from one build to the other can occur.

**NOTE:** To minimize occurrences of incorrect winking, all developers must use the same set of tools. For example, put your build tools under version control and always run them from the VOB.

---

## Nonshareable DOs

During an express build, the ClearCase build tool creates nonshareable DOs. The build tool creates a configuration record for the DO, but does not write information about the DO into the VOB. Because scanning the information in the VOB is the only method other builds use to find DOs, other builds cannot winking in nonshareable DOs. However, a nonshareable DO can be reused by the view in which it was built.

A nonshareable DO can have shareable sub-DOs, but not shareable siblings. A nonshareable DO can be built using a winked-in shareable DO. (However, a shareable DO cannot have nonshareable sub-DOs or siblings.)

For information on enabling express builds, see *Using Express Builds to Prevent Winking to Other Views* on page 55.

You can use the same commands that you use with shareable DOs on nonshareable DOs, but some commands work differently on the two kinds of DOs. The reference pages for the commands describe the differences.

---

## Storage of Derived Objects

When a DO is created, its data container is located in the view storage area. For a shareable DO, the ClearCase build tool creates the VOB database object for the DO, and also writes to the VOB information about the DO that can be used during configuration lookup. A nonshareable DO has no VOB database object, and the build tool does not write any configuration lookup information into the VOB.

A DO consists of the following parts:

- VOB database object (shareable DOs only)—Each DO is cataloged in the VOB database, where it is identified by an extended name that includes both its standard pathname (for example, `\hw\src\hello.c`) and a unique DO-ID (for example, `23-Feb.08:41.391`).

- Data container—The data portion of a derived object is stored in a standard file within a ClearCase storage area. This file is called a *data container*; it contains the DO's file system data.
- Configuration record—Actually, a CR is associated with a DO; it is not part of the DO itself. More precisely, a CR is associated with the entire set of sibling DOs created by a particular invocation of a particular build script. See *Configuration Records* on page 11.

When a shareable DO is first created, it is unshared:

- It appears only in that view.
- Its data container is a file in the view's private storage area.
- **clearmake** or **omake** writes information about the DO into the VOB.

### Promotion and Winkin

The first time a shareable derived object is winked in by another dynamic view, or when either kind of DO is promoted manually with a **winkin** or **view\_scrubber -p** command, its status changes to shared:

- Its data container is *promoted* to a derived object storage pool in the VOB.
- (shareable DOs only) If the winkin was done by the build tool or the command was executed in another view, the DO now appears in two dynamic views.

When the winkin occurs during a **clearmake** or **omake** build:

- The dynamic view to which the DO is winked in, and all other views to which the DO is subsequently winked in, use the data container in VOB storage.
- The original view continues to use the data container in view storage. (The **view\_scrubber** utility removes this asymmetry, which causes all dynamic views to use the data container in VOB storage.)

When the winkin is done with the **winkin** or **view\_scrubber -p** command, the data container in the view is removed after it is promoted to VOB storage. The original view and all other views to which the DO is subsequently winked in use the data container in VOB storage.

Figure 5 Storage of a Shareable Derived Object

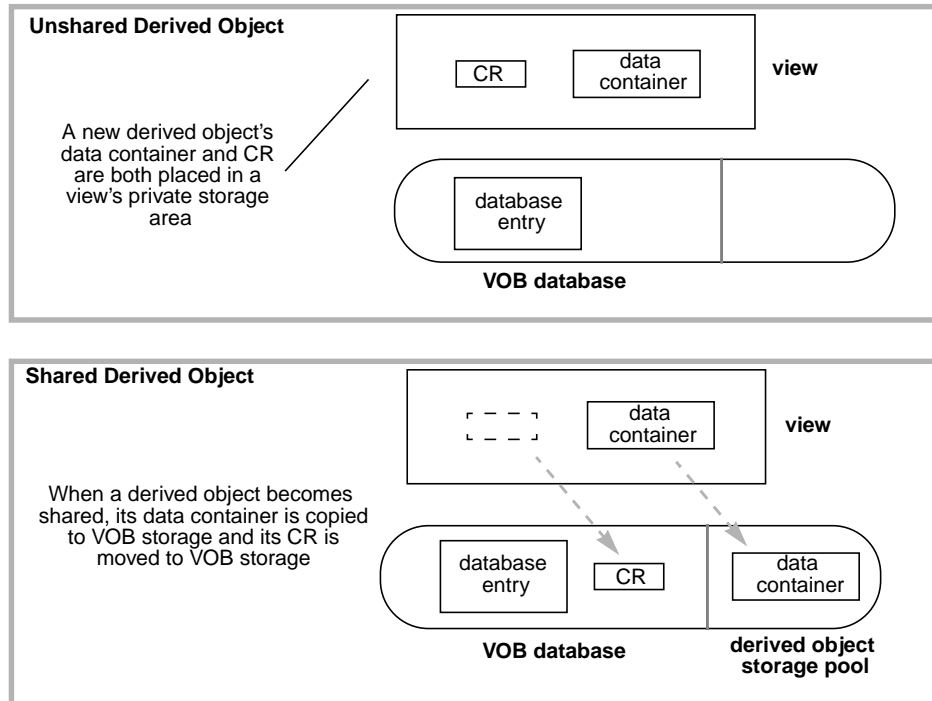
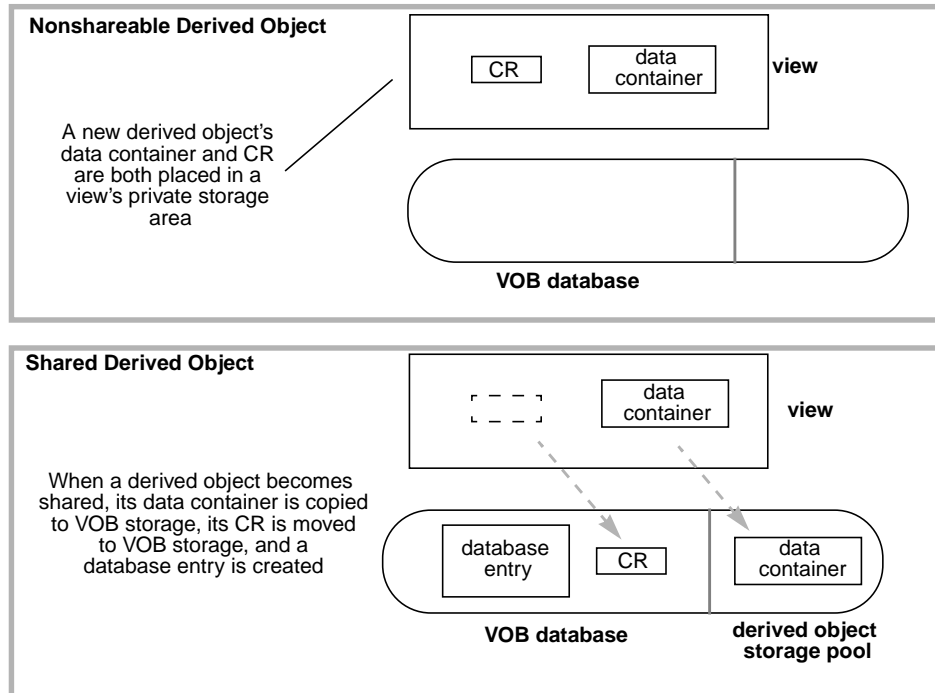

Figure 6 Storage of a Nonshareable Derived Object



After a derived object is winked in, it remains shared, no matter how many times it is winked in to additional dynamic views, and even if subsequent rebuilds or deletion commands cause it to appear in only one dynamic view (or zero views).

When a derived object's data container is in the VOB, any number of views can share the derived object without having to communicate with each other directly. For example, view **alpha** can be unaware of views **beta** and **gamma**, with which it shares a derived object. The hosts on which the view storage directories are located need not have network access to each other's disk storage.

For more information, see the **winkin** and **view\_scrubber** reference pages.



---

## DO Versions

You can check in a derived object as a version of an element, creating a *DO version*. Other versions of such an element can also be, but need not be, derived objects. A DO version behaves like both a version and a derived object:

- You can use its *version-ID* to reference it as both a VOB database object and a data file.
- You can apply a version label to it and reference it using that label.
- You can display its configuration record with **catcr** or compare the CR to another with **diffcr**.
- A **clearmake** or **omake** build can wink it in if the element is located at the same pathname where the DO was originally built.
- You can wink it in with a **winkin** command.
- The **describe** command lists it as a `derived object version`. (The **lsdo** command does not list it at all.)

For more information on DO versions, see *Working with DO Versions* on page 58.

---

## 2.4 Reuse of DO-IDs

The DO-ID for a shareable derived object is guaranteed to be unique within the VOB, for all views. That is, if you delete a shareable DO, its numeric file-name extension is not reused (unless you reformat the VOB that contains it).

The DO-ID for a DO created by an express build (a nonshareable derived object) is unique only at a certain point in time. If you delete a nonshareable DO, the ClearCase build tools can reuse its numeric file-name extension. (Because ClearCase tracks derived objects using their VOB database identifiers, so no build confusion will occur if a file-name extension is reused.)

DO-IDs change when any of these events occur:

- The DO passes its first birthday. The time stamp changes to include the year the DO was created:

<code>util.obj@15-Jul.15:34.8896</code>	<i>(when first created)</i>
<code>util.obj@15-Jul-1998.8896</code>	<i>(after a year)</i>

- You convert a nonshareable DO to a shareable DO. (See *Converting Nonshareable DOs to Shared DOs* on page 62.)
- You process a VOB's database with **reformatvob**. All DO-IDs receive new numeric file-name extensions:
 

util.obj@15-Jul.15:34.8896	(before reformatvob)
util.obj@15-Jul.17:08.734	(after reformatvob)

The configuration record reflects these DO-ID changes.

---

## 2.5 Derived Object Reference Counts

A DO's reference count is the number of times the derived object appears in ClearCase dynamic views throughout the network. ClearCase also tracks the identifiers for the views that reference the DO. When a new derived object is created, **clearmake** sets its reference count to 1, indicating that it is visible in one view. Thereafter, each winkin of the DO to an additional view increments the reference count.

The **lsdo -long** command lists the reference count and referencing views for a DO. For example:

```
cleartool lsdo -long
01-Sep-99.18:56:45      Suzanne Lee (sgl.user@neon)
  create derived object "file.txt@@01-Sep.18:56.2147483683"
  size of derived object is: 10
  last access: 01-Sep-99.18:56:46
  references: 1 => neon:C:\views\sgl_test.vws
01-Sep-99.19:03:19      Suzanne Lee (sgl.user@neon)
  create derived object "util@@01-Sep.19:03.81"
  size of derived object is: 10
  last access: 01-Sep-99.19:03:33
  references: 2 (shared)
=> neon:C:\views\sgl_test.vws
=> neon:C:\views\point_of.vws
```

For a nonshareable DO, the reference count is always 1.

A reference count can also decrease. When a program running in any of the views that reference a shared derived object overwrites or deletes that object, the link is broken and the reference count is decremented. That is, the program deletes the view's reference to the DO, but the DO itself remains in VOB storage. This occurs most often when a compiler overwrites an old build

target. You can also remove the derived object with a standard **del** command, or if the makefile has a **clean** rule, a **clearmake clean** invocation.

A derived object's reference count can become zero. For example, suppose you build program **hello.exe** and rebuild it a few minutes later. The second **hello.exe** overwrites the first **hello.exe**, decrementing its reference count. Because the reference count probably was 1 (no other view has winked it in), it now becomes 0. Similarly, the reference counts of old DOs, even of DOs that are widely shared, eventually decrease to zero as development proceeds and new DOs replace the old ones.

The **lsdo** command ignores such DOs by default, but you can use the **-zero** option to list them:

```
Z:\vob_hw\src> cleartool lsdo -zero -long hello.obj
.
.
08-Mar-96.12:47:54      akp.user@cobalt
  create derived object "hello.obj@08-Mar.12:47.259"
  references: 0
  ...
```

A derived object that is listed with a `references: 0` annotation does not currently appear in any view. However, some or all of its information may still be available:

- If the DO was ever promoted to VOB storage, its data container is still in the VOB storage pool (unless it has been scrubbed), and its CR is still in the VOB database. You can use **catcr** and **diffcr** to work with the CR. You can get to its file system data by performing a **clearmake** build in an appropriately configured view, or by using the **winkin** command.
- If the DO was never promoted, its CR may be gone forever. Until the scrubber runs and deletes the data container, the **catcr** command prints the message `Config record data no longer available for DO-pname`.



## Pointers on Using ClearCase Build Tools

# 3

This chapter presents some pointers on making best use of **clearmake** and **omake**.

ClearCase includes two independent build programs, **clearmake** and **omake**. The sample build scenario that follows uses **clearmake**. However, both programs incorporate the major ClearCase build-related features, including *configuration lookup*, *derived object sharing*, and *config record maintenance*.

The **omake** program's strength lies primarily in its support for users who require compatibility with other PC-based build programs, including Borland® Make, Microsoft® NMAKE, Intersolv® Polymake™, and OPUS Make™.

For more information on **omake**, see the following:

- **omake** reference page
- *ClearCase OMAKE Manual*

---

### 3.1 Running omake or clearmake

Typically, you run **omake** or **clearmake** from a dynamic view context using the following procedure:

1. Set a view context by assigning a drive to a dynamic view (in Windows Explorer, click **Tools**➔**Map Network Drive** or run the **net use** command) and then changing to that view:

```
c:\> net use f: \\view\myview
c:\> f:
f:\>
```

2. Change to the appropriate directory and run **omake** or **clearmake**:

```
f:\> cd myvob\src (‘\myvob’ is the VOB-tag)
```

```
f:\myvob\src> omake options
```

or

```
f:\myvob\src> clearmake options
```

A view context prevents VOB pathnames from being dependent on the view the build occurs in. From **f:**, you and your makefiles can access versioned objects with non-view-extended, *absolute VOB pathnames* like `\vob2\src\main.c` in either **cleartool** subcommands or standard operating system commands.

If you work directly on **M:**, in view-extended namespace, full pathnames to VOB objects include a view-specific prefix, which affects configuration lookup so as to prevent DO sharing between views.

---

## A Simple clearmake Build Scenario

**clearmake** is designed to let developers in makefile-based build environments continue working in their accustomed manner. The following simple build scenario demonstrates how little adjustment is required to begin building with **clearmake**.

1. Go to a development directory within any VOB.
2. Edit some source files. Typically, you need to edit some sources before performing a build; accordingly, you check out some file elements and revise the checked-out versions.
3. Start a build. You can use your existing makefiles, but invoke **clearmake** instead of your standard **make** program. For example:

```
clearmake (build the default target)  
clearmake cwd.obj libproj.lib (build one or more particular targets)  
clearmake -k monet CFLAGS=-g (use standard options and make-macro overrides)
```

(We recommend that you avoid specifying make-macro overrides on the command line. See *Using a Build Options Specification (BOS) File* on page 31)

**clearmake** builds targets (or avoids building them) in a manner similar to, but more sophisticated than, other make variants. Figure 7 illustrates the results of a typical build.

Figure 7 clearmake Build Scenario

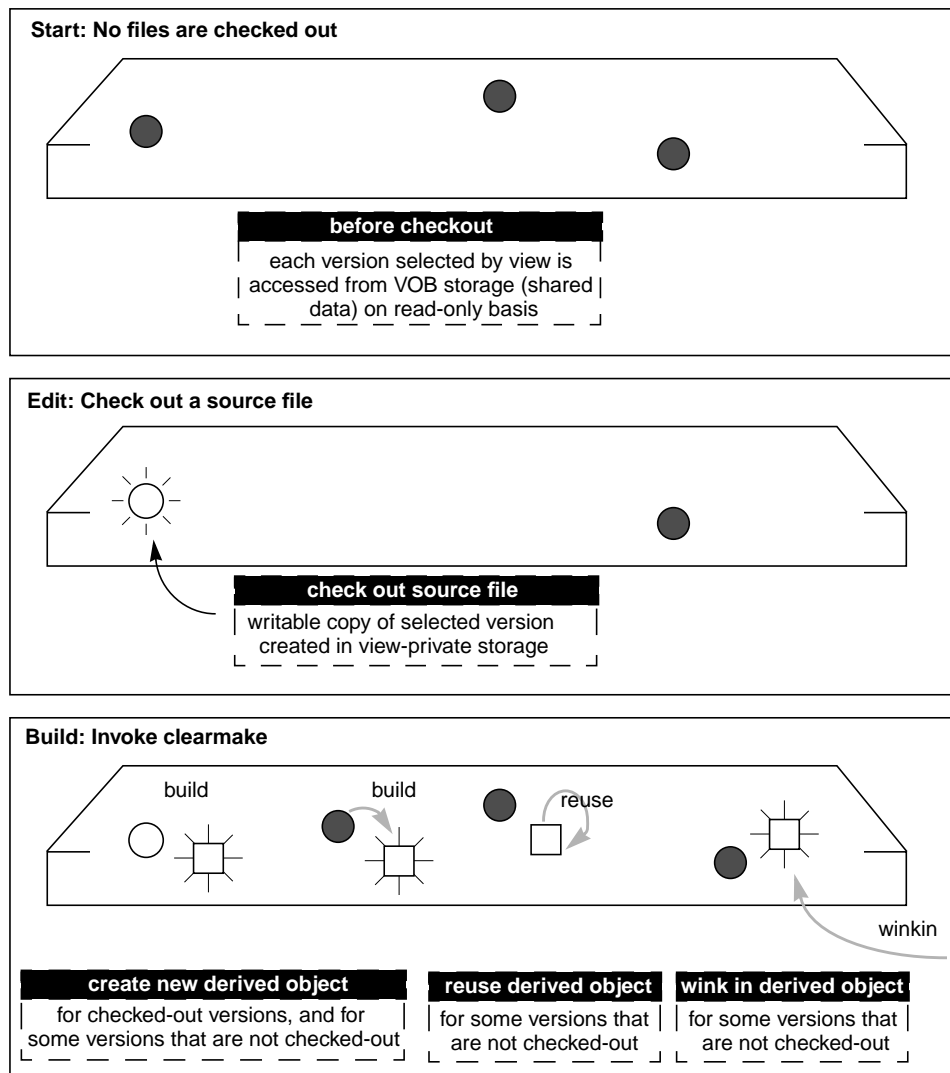

**clearmake** builds a new derived object for each checked-out source file, because no other view's build could possibly have used your checked-out version.

Note that **clearmake** does not attempt to verify that you have actually edited the file; the checkout makes a rebuild necessary. As you work, saving a file or invoking **clearmake** causes a rebuild of the updated file's dependents, in the standard make manner.

For source files that you have not checked out, **clearmake** may or may not build a new derived object:

- It may reuse a derived object that appears in your view, produced by a previous build.
- It may wink in an existing derived object built in another view. (It's even possible that a winked-in DO was originally created in your view, shared, then deleted from your view—for example, by a **make clean** rule.)
- Changes to other aspects of your build environment may trigger a **clearmake** rebuild: revision to a header file; change to the build script, use of a make-macro override; change to an environment variable used in the build script.

---

## 3.2 Accommodating Build Avoidance

When you first begin to build software systems with ClearCase, the fact that **omake** (or **clearmake**) uses a different build-avoidance algorithm than other **make** variants may occasionally surprise you. This section describes several such situations and presents simple techniques for handling them.

---

### Increasing the Verbosity Level of a Build

If you don't understand **omake**'s (or **clearmake**'s) build-avoidance decisions, use the **-v** (somewhat verbose) or **-d** (extremely verbose) option. For **clearmake** you can also set environment variable **CCASE\_VERBOSITY** to **1** or **2**, respectively, for equivalent behavior.

---

### Handling Temporary Changes in the Build Procedure

Typically, you do not edit a target's build script in the *makefile* very often. But you may often change the build script by specifying overrides for *make macros*, either on the command line or in the Windows NT environment. For example, target **hello.obj** is specified as follows in the makefile:



```
hello.obj: hello.c hello.h
    del hello.obj
    cl /c $(CFLAGS) hello.c
```

When it executes this build script, **omake** (or **clearmake**) enters the build script, after macro substitution, into the config record. The command

```
Z:\myvob> omake hello.obj CFLAGS="/O2 /G5"
```

produces this configuration record entry:

```
-----
Build script:
-----
    cl /c /O2 /G5 hello.c
```

The **omake** (or **clearmake**) build-avoidance algorithm compares effective build scripts. If you then use the command **omake hello.obj** without specifying **CFLAGS="/O2 /G5"**, **omake** (or **clearmake**) rejects the existing derived object, which was built with those flags. The same mismatch occurs if you create a **CFLAGS** environment variable with a different value, and then invoke **omake** (or **clearmake**) with the **-e** option.

### Using a Build Options Specification (BOS) File

To manage temporary overrides for make macros and EVs, place macro definitions in *build options specification* (BOS) files. **clearmake** provides several ways for using a BOS file. For example, if your *makefile* is named **project.mk**, macro definitions are read from **project.mk.options**. You can also keep a BOS file in your home directory, or specify one or more BOS files with **clearmake -A**. For details, see Chapter 5, *clearmake Makefiles and BOS Files*.

### Using a Separate makefile to Specify Build Options

To manage these temporary overrides with **omake**, you can place macro definitions in a separate makefile. To include this makefile, specify the **-f makefile** option.

Using a BOS file or separate makefile to specify make macro overrides relieves you of having to remember which options you specified for the last build. If you have not modified the BOS or separate makefile recently, derived objects in your view are not disqualified for reuse on the basis of build script discrepancies. Some of the sections that follow describe other applications of BOS files.

---

## Handling Targets Built in Multiple Ways

Because **omake** (and **clearmake**) compare build scripts, undesirable results may occur if your build environment includes more than one way to build a particular target. For example, suppose that the target **test\_prog\_3** appears in two makefiles in two directories. The first is in its source directory, **util\_src**:

```
test_prog_3.exe: ...
    cl /Fl test_prog_3.c ...
```

The second is in another directory, **app\_src**:

```
..\util_src\test_prog_3.exe: ...
    cd ..\util_src & cl /Fl test_prog_3.c
```

Derived objects built with these scripts may be equivalent, because they are built as the same file name (**test\_prog\_3**) in the same VOB directory (**util\_src**). But by default, a build in the **app\_src** directory never reuses or winks in a DO built in the **util\_src** directory, because build-script comparison fails.

You can suppress build-script comparison for this target by using an **omake** special build target, **.NOCMP\_SCRIPT**, or a **clearmake** special build target, **.NO\_CMP\_SCRIPT** in the makefile or in an associated BOS file:

```
.NO_CMP_SCRIPT: ..\util_src\test_prog_3.exe           (clearmake build target)
.NOCMP_SCRIPT: ..\util_src\test_prog_3.exe           (omake build target)
```

To suspend build-script comparison once, you can use either **omake -O** or **clearmake -O**.

---

## Using a Recursive Invocation of **omake** or **clearmake**

You can eliminate the problem of different build scripts described in *Handling Targets Built in Multiple Ways* by adding a recursive invocation of **clearmake** to the makefile in **app\_src**:

```
..\util_src\test_prog_3.exe: ...
    cd ..\util_src & $(MAKE) test_prog_3.exe         ($(MAKE) invokes omake or
                                                    clearmake recursively)
```

Now, target **test\_prog\_3** is built the same way in both directories. You can turn on build-script comparison again, by removing the **.NOCMP\_SCRIPT** or **.NO\_CMP\_SCRIPT** special target.

---

## Optimizing Winkin by Avoiding Pseudotargets

Like other **make** variants, **omake** (or **clearmake**) always executes the build script for a *pseudotarget*, a target that does not name a file system object built by the script. For example, in the section *Using a Recursive Invocation of omake or clearmake*, you may be tempted to use a pseudotarget in the **app\_src** directory's *makefile*:

```
test_prog_3.exe: ...                               (shortened from ..\util_src\test_prog_3)
               cd ..\util_src & $(MAKE) test_prog_3.exe
```

A build of any higher-level target that has **test\_prog\_3.exe** as a build dependency always builds a new **test\_prog\_3.exe**, which in turn triggers a rebuild of the higher-level target. If the rebuild of **test\_prog\_3.exe** was not necessary, the rebuild of the higher-level target may not have been necessary, either. Such unnecessary rebuilds decrease the extent to which you can take advantage of ClearCase's derived object sharing capability.

---

## Accommodating the Build Tool's Different Name

The fact that the ClearCase build utility has a unique name, **omake** (or **clearmake**), may conflict with existing build procedures that implement recursive builds. Most make variants automatically define the make macro **\$(MAKE)** as the name of the build program, as it was typed on the command line:

```
Z:\avob> make hello.obj                          (sets MAKE to "make")
Z:\avob> omake hello.obj                         (sets MAKE to "omake")
Z:\avob> clearmake hello.obj                    (sets MAKE to "clearmake")
Z:\avob> my_make hello.obj                      (sets MAKE to "my_make")
```

This definition enables recursive builds to use **\$(MAKE)** to invoke the same build program at each level. The section *Optimizing Winkin by Avoiding Pseudotargets* includes one such example; here is another one:

```
SUBDIRS = lib util src

all:
    for %DIR in ($(SUBDIRS)) do cd %DIR & $(MAKE) all
```

Executing this build script with **omake** (or **clearmake**) invokes **omake all** (or **clearmake all**) recursively in each subdirectory.

---

## 3.3 Declaring Source Dependencies in Makefiles

To implement build avoidance based on time stamps, standard **make** variants require you to declare all the source file *dependencies* of each build target. For example, object module **hello.obj** depends on source files **hello.c** and **hello.h** in the same directory:

```
hello.obj: hello.c hello.h
    del hello.obj
    cl /c hello.c
```

Typically, these source files depend on project-specific header files through `#include` directives, perhaps nested within one another. The standard files do not change very often, but programmers often lament that “it didn’t compile because someone changed the project’s header files without telling me.”

To alleviate this problem, some organizations include every header file dependency in their makefiles. They rely on utility programs to read the source files and determine the dependencies.

**omake** and **clearmake** do not require that source-file dependencies be declared in *makefiles* (but see *Source Dependencies Declared Explicitly on page 34*). The first time a derived object is built, its build script is always executed; thus, the dependency declarations are irrelevant for determining whether the target is out of date. After a derived object has been built, its configuration record provides a complete list of source-file dependencies used in the previous build, including those on all header files (nested and nonnested) read during the build.

You can leave source-file dependency declarations in your existing makefiles, but you need not update them as you revise the makefiles. And you need not place source-file dependencies in new makefiles to be used with **omake** or **clearmake**.

**NOTE:** Although source-file dependency declarations are not required, you may want to include them in your makefiles, anyway. The principal reason for doing so is portability: you may need to provide your sources to another team (or another company) that is not using ClearCase.

### Source Dependencies Declared Explicitly

The ClearCase *build auditing* facility tracks only the MVFS objects used to build a target. Sometimes, however, you may want to track other objects. For example:

- The version of a compiler that is not stored in a VOB
- The version of the operating system kernel, which is not referenced at all during the build
- The state of a *flag-file*, used to force rebuilds

You can force such objects to be recorded in the CR by declaring them as dependencies of the makefile target:

```
hello.obj: hello.c hello.h my.flag
    del hello.obj
    cl /c hello.c
```

This example illustrates dependency declarations for these kinds of objects:

- **(hello.c, hello.h)** Dependencies on MVFS objects are optional. These are recorded by `clearmake` and `MVFS` anyway.
- **my.flag** — Dependencies on view-private objects can implement a *flag-file* capability.

### Explicit Dependencies on Searched-For Sources

There are situations in which the configuration lookup algorithm that `clearmake` and `omake` use qualifies a derived object, even though rebuilding the target would produce a different result. Configuration lookup requires that for each object listed in an existing CR, the current view must select the same version of that object. However, in cases where you use search paths to find an object, a target rebuild may use a different object than the one listed in the CR. Configuration lookup does not take this possibility into account.

When files are accessed by explicit pathnames, configuration lookup qualifies derived objects correctly. Configuration lookup may qualify a derived object incorrectly if files are accessed at build time by a search through multiple directories, for example, when the `-I` option to a C or C++ compiler specifies a header file, or when the `-L` option to a linker specifies a library file. The following build script uses a search to locate a header file, **foo.h**:

```
hello.obj:
    cl /c /I \projvob\privh /I \projvob\stdh hello.c
```

The command `clearmake hello.obj` may qualify an existing derived object built with `C:\projvob\privh\foo.h`, even though rebuilding the target would now use `C:\projvob\stdh\foo.h` instead.

**omake** and **clearmake** address this problem in the same way as some standard **make** implementations:

- ▶ You must declare the searched-for source object as an explicit dependency in the makefile:

```
hello.obj: fio.h
    ...
```

- ▶ You must use the **VPATH** macro to specify the set of directories to be searched:

```
VPATH = \projvob\privh;projvob\stdh
```

Given this makefile, **omake** (or **clearmake**) uses the **VPATH** (if any) when it performs configuration lookup on **fio.h**. If a candidate derived object was built with **C:\projvob\privh\fio.h**, but would be built with **C:\projvob\stdh\fio.h** in the current view, the candidate is rejected.

**NOTE:** The **VPATH** macro is not used for all source dependencies listed in the config record. It is used only for explicitly declared dependencies of the target. Also, **clearmake** searches only in the current view.

**Build Tool Dependencies.** You can use this mechanism to implement dependencies on build tools. For example, you can track the version of the C compiler used in a build as follows:

```
msg.obj: msg.c $(CC)
    $(CC) /c msg.c
```

With this makefile, either your **VPATH** must include the directories on your search path, or you must use a full pathname as the **\$(CC)** value.

**NOTE:** If your C compiler is stored in a VOB and you invoke it from the VOB, ClearCase tracks its version and you do not have to include it as a dependency.

---

## 3.4 Build-Order Dependencies

In addition to source dependencies, *makefiles* also contain build-order dependencies. For example:

```
hello.exe: hello.obj libhello.lib
    ...
libhello.lib: hello_env.obj hello_time.obj
    ...
```

These dependencies are buildable objects, and are called *subtargets*. The executable **hello.exe** must be built after its subtargets, object module **hello.obj** and library **libhello.lib**, and the library must be built after its subtargets, object modules **hello\_env.obj** and **hello\_time.obj**.

ClearCase does not detect build-order dependencies; you must include such dependencies in makefiles used with **omake** (or **clearmake**), as you do with other **make** variants.

---

## 3.5 clearmake Build Script Execution and cmd.exe

By default, **clearmake** invokes **cmd.exe** to execute build scripts. It finds **cmd.exe** in `%SYSTEMROOT%\system32`; if `SYSTEMROOT` is not set, **clearmake** uses `c:\winnt` as the default system root directory. If it cannot find the shell, **clearmake** exits.

You can override the default shell by using a **SHELL** make macro (note that you must specify a full pathname and include the file's extension). The following anomalies may occur if you use a different shell, or if you execute a batch file from a build script:

- **clearmake** may not recognize failed commands and continue the build with unpredictable results.
- **clearmake** may display an extra command prompt after a build script command completes successfully.

**NOTE:** If **clearmake** determines that it can execute the build script directly, it does not use the shell program even if you specify one explicitly. If you use **.bat** files in build scripts, you must make them executable (use the **cleartool protect** command). To force **clearmake** to use the shell program, set the environment variable `CCASE_SHELL_REQUIRED`.

---

## 3.6 Build Scripts and the rm Command

It is common for a makefile to include a target whose build script invokes a command like **rm** to delete files. Some Windows installations include **rm** commands that do not actually delete a file, but move it to another directory. As a result, build script temporary files become sibling DOs of the targets. To avoid this effect, make sure to use a delete command—**del**, for example—that actually deletes files.

---

## 3.7 Pathnames in CRs

In a config record created on Windows, MVFS object pathnames begin with the VOB-tag and do not include view-tag prefixes. For example:

```
...
----- MVFS objects: -----
\proj1\include\cmmsg.h@@\main\nt3\39          <22-Jul-94.17:49:53>
\proj1\lib\fsut1.h@@\main\12                 <22-Jun-94.12:07:24>
...
```

Pathnames in this format can be cut or copied and applied elsewhere “as is,” if you are on a drive assigned to a view with **Tools**→**Map Network Drive** in Windows Explorer or the **net use** command).

---

## 3.8 Problems with Forced Builds

**omake** has an unconditional option **-a** (on **clearmake** it is **-u**), which forces rebuilds. Using this option reduces the efficiency of derived object sharing, however. If you force **clearmake** or **omake** to build a target in a situation where it would have winked in an existing DO, you create a new DO with the same configuration as an existing one. In such situations, a developer who expects a build to share a particular existing DO may get another, identically configured DO instead. This may confuse the team and waste disk space.

We suggest that you use a flag-file to force a rebuild, rather than using **omake -a** or **clearmake -u**. (See *Source Dependencies Declared Explicitly on page 34*.)



---

## 3.9 How **clearmake** Interprets Double-Colon Rules

Double-colon rules are a special kind of makefile construct that allows several independent rules for one target, each with a possibly different build script. The semantics given to these rules by other **make** programs (and for **clearmake** when CRs are not being generated) are that commands within each double-colon rule are executed if the target is older than any dependencies of that particular rule. The result can be that none, any, or all of the double-colon rules are executed.

However, when **clearmake** creates CRs and associates them with the results of its builds, this interpretation runs the risk of generating incomplete CRs, which do not contain all the versions and build scripts used to build the targets. For this reason, **clearmake** interprets these rules in a more conservative way.

When building a target specified by a number of double-colon rules, **clearmake** concatenates all build scripts from all the double-colon rules for that target, and runs them in a single audited script.

To produce the correct results, any subtargets must already have been built, so **clearmake** builds any out-of-date subtargets before it executes the concatenated build script.

As a result, you may observe these differences in behavior between **clearmake** and other **make** programs concerning double-colon rules:

- **clearmake** runs more of the build scripts than other **make** programs.
- **clearmake** may run the build scripts in a different order than other **make** programs.

However, given the intended use and standard interpretation of double-colon rules, these differences still produce correct builds and complete correct CRs.

---

## 3.10 Continuing to Work During a Build

As your build progresses, other developers continue to work on their files, and may check in new versions of elements that your build uses. If your build takes an hour to complete, you do not want build scripts executed early in the build to use version 6 of a header file, and scripts executed later to use version 7 or 8.

To prevent such inconsistencies, any version whose selection is based on a **LATEST** config spec rule is locked out if it is checked in after the instant that **omake** (or **clearmake**) was invoked. The moment that the **omake** (or **clearmake**) build session begins is the *build reference time*.

The same reference time is reported in each configuration record produced during the build session, even if the session lasts hours (or days):

```
Z:\avob> cleartool catcr hello.obj
Target hello.obj built by drp.dvt
Host "fermi" running Windows NT 3.5 (807)
Reference Time 26-Feb-99.16:53:58, this audit started 26-Feb-99.16:54:10 ...
```

**NOTE:** The `reference time` is the build reference time, when the overall **omake** (or **clearmake**) build session began. The `this audit started` time is when the execution of the individual build script began.

When determining whether an object was created before or after the build reference time, **omake** (or **clearmake**) adjusts for *clock skew*, the inevitable small differences among the system clocks on different hosts. For more on build sessions, see *Build Sessions, Subsessions, and Hierarchical Builds on page 42*.

**CAUTION:** A build's coordinated reference time applies to elements only, providing protection from changes made after the build began. You are not protected from changes to view-private objects and non-MVFS objects. For example, if you begin a build and then change a checked-out file used in the build, a failure may result. Therefore, do not work on the same project in a view where a build is in progress.

---

## 3.11 Using Config Spec Time Rules

**NOTE:** If you use a UCM view, your config spec is generated by ClearCase. Do not add time rules to your config spec.

Using the reference time facility described in *Continuing to Work During a Build*, **omake** (or **clearmake**) blocks out potentially incompatible source-level changes that take place after your build begins. But sometimes, the incompatible change has already taken place. ClearCase allows you to block out recently created versions.

A typical ClearCase team-development strategy is for each team member to work in a separate view, but to have all the views use the same config spec. In this way, the entire team works on the same branch. As long as a source file remains checked out, its changes are isolated to a single view; when a developer checks in a new version, the entire team sees the new version on the dedicated branch.

This incremental integration strategy is often very effective. But suppose that another user's recently checked-in version causes your builds to start failing. Through an exchange of e-mail, you trace the problem to header file **project\_base.h**, checked in at 11:18 A.M. today. You, and other team members, can reconfigure your views to roll back that one element to a safe version:

```
element project_base.h ... \onyx_port\LATEST -time 5-Mar.11:00
```

If many interdependent files have been revised, you can roll back the view for all checked-in elements:

```
element * ... \onyx_port\LATEST -time 5-Mar.11:00
```

For a complete description of time rules, see the **config\_spec** reference page.

---

## Inappropriate Use of Time Rules

Your view interprets time rules with respect to the create version event record written by the **checkin** command. The checkin is read from the system clock on the VOB server host. If that clock is out of sync with the clock on the view server host, your attempt to roll back the clock may fail. Thus, don't strive for extreme precision with time rules: select a time that is well before the actual cutoff time (for example, a full hour before, or in the middle of the night).

Do not use time rules to freeze a view to the current time immediately before you start a build. Allow **omake's** (or **clearmake's**) reference time facility to perform this service. Here's an inappropriate use scenario:

1. You check in version 12 of **util.c** at 7:05 P.M. on your host. You do not know that clock skew on the VOB host causes the time 7:23 P.M. to be entered in the create version event record.
2. To freeze your view, you change your config spec to include this rule:

```
element * \main\LATEST -time 19:05
```

3. You issue an **omake** (or a **clearmake**) command immediately (at 7:06 P.M.) to build a program that uses **util.c**. When selecting a version of this element to use in the build, your view consults the event history of **util.c** and rejects version 12, because the 7:23 P.M. time stamp is too late for the **-time** configuration rule.

---

## 3.12 Build Sessions, Subsessions, and Hierarchical Builds

The following terms are used to describe the details of ClearCase build auditing:

- ▶ Invoking **clearmake**, **omake**, or **clearaudit** starts a *build session*. The time at which the build session begins becomes the *build reference time* for the entire build session, as described on *Continuing to Work During a Build* on page 39.
- ▶ During a build session, one or more *target rebuilds* typically take place.
- ▶ Each target rebuild involves the execution of one or more *build scripts*. (A double-colon target can have multiple build scripts; see *How clearmake Interprets Double-Colon Rules* on page 39.)
- ▶ During each target rebuild, **clearmake**, **omake**, or **clearaudit** conducts a *build audit*.

---

### Subsessions

A build session can have any number of *subsessions*, all of which inherit the reference time of the build session. A subsession corresponds to a nested build or recursive make, which is started when a **clearmake**, **omake**, or **clearaudit** process is invoked in the process family of a higher-level **clearmake**, **omake**, or **clearaudit**. For example:

- ▶ Including a **clearmake**, **omake**, or **clearaudit** command in a *makefile* build script executed by **clearmake**, **omake**, or **clearaudit**
- ▶ Entering a **clearmake**, **omake**, or **clearaudit** command in an interactive process started by **clearaudit**

A subsession begins while a higher-level session is still conducting build audits. The subsession conducts its own build audits, independent of the audits of the higher-level session; that is, the audits are not nested or related in any way, other than that they share the same build reference time.

---

### Versions Created During a Build Session

Any version created during a build session and selected by a **LATEST** config spec rule is not visible in that build session. For example, a build checks in a derived object it has created;

subsequent commands in the same build session do not select the checked-in version, unless it is selected by a config spec rule that does not use the version label **LATEST**.

An effect of this behavior is that you cannot check in and label a version during a single build session. Instead, you must check in the version during one build session, and label the version during another build session. Use the **mklabel -config** command to label versions associated with a specific derived object.

---

## Coordinating Reference Times of Several Builds

Different build sessions have different reference times. The best way to assign a series of builds the same reference time is to structure them as a single, hierarchical build.

An alternative approach is to run all the builds within the same **clearaudit** session. For example, you can write a batch file, **multi\_make.bat**, that includes several invocations of **clearmake**, **omake**, or **clearaudit** (along with other commands). Running the script as follows ensures that all the builds are subsessions that share the same reference time:

```
> clearaudit -c multi_make.bat
```

---

## Objects Written at More than One Level

Problems occur when the same file is written at two or more session levels (for example, a top-level build session and a subsession): the *build audit* for the higher-level session does not contain complete information about the file system operations that affected the file. For example:

```
> clearaudit -c "clearmake shuffle > logfile"
```

The file **logfile** may be written twice:

- During the **clearaudit** build session, by the command invoked from **clearaudit**
- During the **clearmake** subsession, when the **clearaudit** build session is suspended

In this case, **clearaudit** issues this error message:

```
clearaudit: Error: Derived object modified; cannot be stored in VOB.  
Interference from another process?
```

To work around this limitation, postprocess the derived object at the higher level with a **copy** command:

```
> clearaudit -c "clearmake shuffle > log.tmp& copy log.tmp logfile& del log.tmp"
```

---

### 3.13 Build Auditing and Background Processes

The ClearCase build programs—**omake**, **clearmake**, and **clearaudit**—use the same procedure to produce configuration records:

1. Send a request to the host's *multiversion file system* (MVFS), to initiate build auditing.
2. Invoke one or more child processes (typically, commands), in which *makefile* build scripts or other commands are executed.
3. Turn off MVFS build auditing.
4. If all the subprocesses have indicated success, and at least one MVFS file has been created, compute and store one or more configuration records.

Any subprocesses of the child processes invoked in Step #2 inherit the same MVFS build audit. (Recursive invocations of ClearCase build programs conduct their own, independent audits; see *Build Sessions, Subsessions, and Hierarchical Builds* on page 42.)

A problem can occur if a build script (or other audited command) invokes a background subprocess, and exits without waiting for it to complete. The build program has no knowledge of the background process and may proceed to Step #3 and Step #4 before the background process has finished its work. In such situations, ClearCase cannot guarantee what portion, if any, of the actions of background commands will be included in the resulting CR. The contents of the CR depend on system scheduling and timing behavior.

The ClearCase build programs audit background processes correctly only if both of the following conditions are true:

- The build script does not complete until all background processes are known to have finished.
- Each background process performs its first MVFS file access while it is still a descendant process of the **clearmake**, **omake**, or **clearaudit** process. (The ClearCase kernel component determines whether to audit a given process when that process first accesses the MVFS. If

the process's ancestors include a process already being audited, the descendant process is similarly marked for auditing.)

If either or both of these conditions are not true, avoid using background processes in audited build scripts.

---

## 3.14 Working with Incremental Update Tools

The design of ClearCase's *build auditing* capability makes it ideal for use with tools that build derived objects from scratch. Because newly created objects have no history, ClearCase can learn everything it needs to know at build time. But this reliance on build-time file-system-level auditing can cause ClearCase to record incomplete information for objects that are updated incrementally, which do have a history.

In ClearCase, incremental updating means that an object is updated partially during the builds of multiple *makefile* targets, instead of generated completely by the build of one target. By default, **omake** and **clearmake** do not update an existing CR incrementally when they build a target. Instead, they do the following:

- Each time a build script incrementally updates an object's file system data, **omake** and **clearmake** write a completely new CR, which describes only the most recent update, not the entire build history.
- The new CR does not match the desired build configuration for any of the other targets that update the object incrementally.

This results in a situation that is both unstable and incorrect: all incremental-update targets are rebuilt each time that **omake** (or **clearmake**) is invoked; when the build is finished, the DO has the correct file system data, but its CR may not describe the DO's configuration accurately.

**omake** and **clearmake** provide a special makefile target **.INCREMENTAL\_TARGET**, which can be used to guarantee correct CR information for incremental updates. The following sections give examples of how to use **.INCREMENTAL\_TARGET**.

---

## Example: Incremental Linking

If your makefile is structured properly, configuration records are not likely to lose information during incremental links.

Incremental linkers typically work by determining which object files have changed since the last link, and relinking those objects only. Because the linker may read only some of the objects each time it links, a CR can, in theory, lose information as repeated links are made. However, in practice, because all dependencies of the link are listed in the build script, the build script does not change from one link invocation to the next. And, because you typically list the objects or predefined dependencies of the link, those dependencies are included in the CR.

---

## Additional Incremental-Update Situations

You may encounter incremental updating in other situations, as well. For example, Visual C++ supports a program database file (PDB) that contains debugging information and is updated incrementally as different targets are built. ClearCase includes special *makefile* rules to work around problems associated with incremental files produced by Visual C++. For more information, see Chapter 7, *Using ClearCase to Build C++ Programs*.

---

### 3.15 Temporary Build Audit Files

By default, **omake** and **clearmake** generate temporary build audit files in the directory identified by the **TMP** environment variable. You can set the **CCASE\_AUDIT\_TMPDIR** environment variable to relocate these files. If you do not set this variable, make sure **TMP** is set to a valid temporary storage directory on a FAT, NTFS, or LAN Manager file system.

---

### 3.16 Auditing 16-bit Tools

Compilers, linkers, and other tools written to run under MS-DOS® or Windows (16-bit tools) require special handling when used in audited builds with **clearmake** or **omake**.



The program **vdmaudit** allows auditing of 16-bit tools and does not affect programs run outside a build. To use **vdmaudit**, you need to have **clearmake** or **omake** run **vdmaudit** and let it call the tool. This involves either editing the **makefile** where it calls the tool or if your **makefile** defines a macro for each tool, redefining the macros in the **makefile** or on the **clearmake** or **omake** command line.

If the makefile defines a macro for each 16-bit tool, you can change the macros to call **vdmaudit**. For example, if your makefile contains macros like:

```
CPP=cl.exe  
LINK=link.exe
```

change them as follows:

```
CPP=vdmaudit cl.exe  
LINK=vdmaudit link.exe
```

You can redefine the macros on the **clearmake** or **omake** command line like this:

```
omake -EN -f disptree.mak CPP="vdmaudit cl.exe" LINK="vdmaudit link.exe"  
clearmake -f disptree.mak CPP="vdmaudit cl.exe" LINK="vdmaudit link.exe"
```

Call all 16-bit tools from **vdmaudit**. If you do not, **clearmake** and **omake** do not audit all tools and the configuration record is incomplete.

An alternative method for auditing 16-bit tools is to use the ClearCase Virtual Device Driver (VDD). To install the VDD during ClearCase installation, select **16-bit build auditing** on the **ClearCase Client Options** or **ClearCase Server Options** page. The VDD runs any time a 16-bit tool is run, whether during an audit or not. However, the VDD can cause 16-bit tools to fail to display all output or to fail to clear the screen when done.

---

### 3.17 Adding a Version String or Time Stamp to an Executable

This section describes a simple technique for incorporating a version string and/or time stamp into a C-language compiled executable. Including a version string or time stamp allows anyone (for example, a customer) to determine the exact version of a program by entering a shell command.

The technique involves adding a “what version?” command-line option to the executable itself:

```
Z:\> monet -Ver
monet R2.0 Baselevel 1 (Thu Feb 11 17:33:23 EST 1996)
```

After the particular version of the program is determined, you can use ClearCase commands to find a local copy, examine its config record, and if appropriate, reconstruct the source configuration with which it was built. (Presumably, the local copy is a derived object that has been checked in as a version of an element.)

You can identify the appropriate derived object by attaching a ClearCase attribute with the version string to the checked-in executable.

---

## Implementing a -Ver Option

You can write a program to display the information stored in the **version\_string** and **version\_time** variables. An example of such a program is shown below:

```
#include <stdio.h>

main(argc,argv)
    int argc;
    char **argv;
{
    /*
     * implement -Ver option
     */
    if (argc > 1 && strcmp(argv[1],"-Ver") == 0) {
        char *version_string = "monet R2.0 Baselevel 1";
        char *version_time= "Thu Feb 11 17:33:23 EST 1996";
        /*
         * Print version info
         */
        printf ("%s (%s)\n",
                version_string, version_time);
        exit(0);
    }
}
```

## Working with Derived Objects and Configuration Records

# 4

This chapter describes the operations you can perform on derived objects and configuration records. For more information and examples, see the reference pages for the commands.

The information in this chapter applies only to dynamic views.

---

### 4.1 Setting Correct Permissions for Derived Objects

If you and other members of your team want to share derived objects (DOs), make sure that your views are configured to create shareable DOs, and that the DOs are created with a mode that grants both read and write access to team members.

Permissions on DOs affect the extent to which they are shareable:

- ▶ When you perform a build, the ClearCase build tool winks in a derived object to your view only if you have read permission on the DO.
- ▶ The ClearCase build tool can wink in DOs for which you do not have write permission. But `permission denied` errors may occur during a subsequent build, when a compiler (or other build script command) attempts to overwrite such a DO. To work around this problem, you can rewrite your makefile to remove the target before rebuilding it. You can also set a policy for how users must set their permissions.

For information on fixing the permissions of DO versions, see the **protect** reference page.

---

## 4.2 Listing and Describing Derived Objects

The following sections describe how to use the **lsdo**, **describe**, **ls**, and **lsprivate** commands to list derived objects.

---

### Listing Derived Objects Created at a Certain Pathname

Use the **lsdo** command to list derived objects created at a specific pathname. For information on the kinds of DOs included in the listing, see the **lsdo** reference page.

- To list all DOs created at the pathname **adm.h**:

**cleartool lsdo adm.h**

```
01-Jul.13:49 "adm.h@@01-Jul.13:49.1286781"  
30-Jun.20:03 "adm.h@@30-Jun.20:03.1278990"  
30-Jun.18:14 "adm.h@@30-Jun.18:14.1277470"  
29-Jun.19:11 "adm.h@@29-Jun.19:11.1253509"  
29-Jun.18:13 "adm.h@@29-Jun.18:13.1252790"  
29-Jun.16:09 "adm.h@@29-Jun.16:09.1249897"
```

- To list all DOs created by you at the pathname **adm.h**:

**cleartool lsdo -me adm.h**

```
30-Jun.18:14 "adm.h@@30-Jun.18:14.1277470"
```

---

## Listing a Derived Object's Kind

To display a derived object's kind, use the **cleartool** commands **ls -l**, **lsprivate -l -do**, or **describe -fmt "%[DO\_kind]p"**. The kind can be one of the following values:

non-shareable	The DO was created during an express build and cannot be winked in by other views.
unshared	The DO was created during a regular build. Its data container is located in view storage, not in the VOB.
promoted	The DO's data container has been promoted to the VOB by a <b>winkin</b> or <b>view_scrubber -p</b> command. The DO is referenced by only one view.
shared	The DO's data container has been promoted to the VOB by a ClearCase build tool or a manual <b>winkin</b> or <b>view_scrubber -p</b> command.

- List, in long form, a particular DO.

### **cleartool ls -l util**

```
derived object (non-shareable) util@@01-Sep.10:54.2147483681
```

- To list all DOs created in the current view in the `\dev` VOB, including the DO kind:

### **cleartool lsprivate -long -invob \dev -do**

```
derived object (unshared) \dev\file2.txt@@02-Jul.13:51.124
derived object (unshared) \dev\file2sub.txt@@02-Jul.13:51.123
```

- To list the name and kind of all DOs created in the current view:

### **cleartool lsprivate -long -do**

```
derived object (shared) \dev\file2.txt@@02-Jul.13:51.124
derived object (unshared) \dev\file2sub.txt@@02-Jul.13:51.123
derived object (unshared) \dev\dir1\foo.obj@@01-Jul.14:23.186
derived object (unshared) \dev\api\bin\adm.exe@@04-Jul.04:01.776
```

---

## Displaying a DO's OID

A derived object's OID is the permanent identifier recorded in the VOB database for the DO. It does not change over the life of the DO, unlike the DO-ID (see *Reuse of DO-IDs* on page 23). To display the OID, use the command **describe -fmt "%On"**. For example:

```
cleartool describe -fmt "%On\n" foo.o
b7afc83e.2f2311d3.a382.00:01:80:7b:09:69
```

---

## Displaying a Description of a DO Version

The **describe** command displays descriptions of DO versions, as it does descriptions of regular versions. You can use the **-fmt** option to extract parts of the description. For example, the following command prints the name, predecessor version, and element type of a DO version:

```
cleartool describe -fmt "%n\t%[version_predecessor]p\t%[type]p\n" file1.obj
file1.obj@@\main\2      \main\1  text_file
```

For more information on the **-fmt** option, see the **fmt\_ccase** reference page.

---

## 4.3 Identifying the Views that Reference a Derived Object

The VOB stores information about which views reference a derived object. To display this information, use the **lsdo** command:

```
Z:\vob_hw\src> cleartool lsdo -l hello.obj
10-Mar-99.15:25:52 akp.user@copper
  create derived object "hello.obj@@10-Mar.15:25.213"
  size of derived object is: 450
  last access: 15-Mar-99.14:22:17
  references: 2 (shared)
=> copper:C:\views\akp\tut\old.vws
=> copper:C:\views\akp\tut\fix.vws
```

---

## 4.4 Specifying a Derived Object in Commands

In general, you use standard pathnames to access DOs when you're working in a view that references them. To standard software (for example, linkers and debuggers), the standard pathname of a derived object (**util.o**) references the DO.

This is another example of ClearCase's transparency feature: a standard pathname accesses one of many different variants of a file system object. Note this distinction, however:

- A version of an element appears in a dynamic view because it is selected by a config spec rule.
- A particular derived object appears in a dynamic view as the result of a build or a winkin.

To access a DO in another dynamic view, use a view-extended pathname:

```
M:\drp\vob_proj\src\msg.obj           (the DO in view drp)
M:\R2_integ\vob_proj\src\msg.obj      (the DO in view R2_integ)
```

**NOTE:** You cannot use view-extended pathnames in makefiles.

To specify a certain DO in a ClearCase command, use the DO-ID. For example, you can use a DO-ID in the **catcr** command to view the contents of a specific DO's config record:

```
cleartool catcr foo.o@@29-Jun.14:40.88
```

**NOTE:** You cannot use a DO-ID in standard commands.

Because DO-IDs can change, avoid using them in files or scripts that operate on a DO. Instead, use a standard pathname or the derived object's object identifier (OID), which never changes. To determine a DO's object identifier, use **cleartool describe -fmt "%On\n"**. For example:

```
cleartool describe -fmt "%On\n" foo.o@@29-Jun.14:40.88
2c5fc68a.2e5311d3.a382.00:01:80:7b:09:69
```

Also, a derived object gets a permanent identifier when it is checked in as a version of an element. See *Working with DO Versions* on page 58.

---

## 4.5 Winking in a DO Manually

You can manually wink in any DO to your view, using the **winkin** command. For example:

```
Z:\vob_hw> cleartool lsdo hello.exe
08-Mar.12:48   akp           "hello.exe@@08-Mar.12:48.265"
07-Mar.11:40   george       "hello.exe@@07-Mar.11:40.217"
```

```
Z:\vob_hw> cleartool winkin hello.exe@@07-Mar.11:40.217
Winked in derived object "hello.exe"
```

```
Z:\vob_hw> hello
...
```

You can wink in a DO that doesn't match your build configuration for any of the following reasons: to run it, to perform a byte-by-byte comparison with another DO, or to perform any other operation that requires access to the DO's file system data.

The **winkin** command can also wink in the set of DOs in a hierarchy of CRs. You can use this recursive **winkin** to seed a new view with a set of derived objects. For example:

```
cleartool winkin -recurse foo@@20-Jul.14:32.146
Winked in derived object "\smg_test\file2.txt"
Winked in derived object "\smg_test\file2sub.txt"
Promoting unshared derived object "\smg_test\foo".
Winked in derived object "\smg_test\foo"
```

You can use the **winkin** command to convert a nonshareable DO to a shared DO. For more information, see *Converting Nonshareable DOs to Shared DOs* on page 62.

---

## 4.6 Preventing Winkin

The following sections describe how to prevent **winkin** to or from your view while using the ClearCase build tools. (You can prevent **winkins** altogether by building in a snapshot view or by not using the ClearCase build tools.)



---

## Preventing Winkin to Your View

To direct **clearmake** or **omake** to limit reuse to DOs created in the current view, use **clearmake -V** or **omake -W**. For more information, see the **clearmake** or **omake** reference page.

---

## Preventing Winkin to Other Views

To prevent any derived objects you create from being winked in to other views, use one of the following techniques:

- Use express builds. See *Using Express Builds to Prevent Winkin to Other Views*.
- Use the **-T** or **-F** options with **clearmake** or the **-L** option with **omake** to create view-private files with no config records. **clearmake** and **omake** do not perform configuration lookup, but this does not matter if you are not changing other files.
- Use special targets that prevent winkin. For example, use **.NO\_WINK\_IN** with **clearmake**. For more information on special targets, see *Special Targets* on page 76.

---

## Using Express Builds to Prevent Winkin to Other Views

During an express build, ClearCase creates DOs that are nonshareable and cannot be used by builds in other views. These nonshareable DOs have configuration records, but the ClearCase build tools do not write information into the VOB for these DOs. Therefore, the DOs are invisible to builds in other views.

**NOTE:** During an express build, the ClearCase build tools wink in DOs from other views. For information on avoiding winkins from other views, see *Preventing Winkin to Your View* on page 55.

Use express builds when DOs created by the build are not appropriate for use by other views. As a general rule:

- Use express builds for development builds that use relatively unstable, checked-out versions.
- Use regular builds for release or nightly builds that use stable, checked-in versions. DOs created by these builds are more likely to be winked in by other views.

## Enabling Express Builds

When you invoke a ClearCase build tool, the kind of build that occurs depends on how your view is configured. To use express builds, configure an existing dynamic view with the nonshareable DOs property, or create a new dynamic view with the nonshareable DOs property. Then, run your ClearCase build tool (**clearmake**, **omake**, or **clearaudit**) in the view.

The following sections describe how to configure your view to use express builds.

### Configuring an Existing View for Express Builds

To configure an existing view, use one of the following methods:

- Use the command **chview -nshareable\_dos** *view-tag*. For more information, see the **chview** reference page.
- Use the View Properties browser:
  - a. From **ClearCase Home Base**, click the **Views** tab and click **Edit View Properties**.
  - b. Click the view whose properties you want to change, then click **OK**.
  - c. Click the **Advanced** tab.
  - d. Clear the **Create shareable derived objects** check box.
  - e. Click **OK**.

Future builds in the view will create nonshareable derived objects. However, existing DOs in the view are shareable; they are not converted to nonshareable. These existing DOs can still be winked in by other views.

### Creating a New View that Uses Express Builds

To create a new view, use one of the following methods:

- Use the **mkview** command with the **-nshareable\_dos** option. For more information, see the **mkview** reference page.
- Use the View Creation Wizard:
  - a. In Step 3, click **Advanced Options**.
  - b. Clear the **Create shareable derived objects** check box.

- c. Follow the prompts of the View Creation Wizard.

**NOTE:** The ClearCase administrator can set a site-wide default for the DO property. If a site-wide default exists and you do not specify the DO property when you create the view, ClearCase uses the site-wide default. For more information, see the **setsite** reference page.

---

## Preventing Winkin to or from Other Architectures

By default, the build tool winks in derived objects built on different architectures. For example, a build on a Sun machine may wink in a DO built on a Windows NT machine. If you want to prevent this behavior, use one of the following techniques:

- Differentiate the build script for different architectures:
  - > Add the architecture name to your build script so that the build tool differentiates among the build scripts.
  - > Store the architecture name in a macro and pass it to the build tool on the command line.
  - > Use architecture-specific subdirectories to store DOs.
- Make your tools a build dependency by storing them in a VOB. Also, store your system header files in a VOB.

---

## 4.7 Converting Derived Objects to View-Private Files

Using a standard command or program to modify a derived object in any way converts it from a DO to a view-private file. For example, use **ls -long** to list a derived object:

```
cleartool ls -long msg.obj
derived object (shared)      msg.obj@10-Mar.15:33.333
```

Modify the DO with a standard command:

```
echo "" >>msg.obj
```

The `ls -long` command now lists the file as a view-private object:

```
cleartool ls -long msg.obj
view private object      msg.obj
```

---

## 4.8 Working with DO Versions

The following sections describe how to create and manipulate DO versions.

---

### Creating DO Versions

You can convert DOs to elements, or check them in as versions of existing elements. The element-creation and version-creation processes are the same for shareable and nonshareable DOs, with this exception: when you check in a nonshareable DO, it is converted to a shared DO before being checked in.

For more information, see the `mkelem` and `checkin` reference pages.

---

### Checking In DOs During a Build

You can write a build script that creates a derived object, and then checks it in or converts it to an element. However, the ClearCase build tool does not create a config record until the build script has completed (all commands after the *target-name*: have executed). Therefore, if the same build script that created the DO checks it in or converts it to an element, the resulting version is not a DO version.

For example, the version created by the following build script is not a DO version:

```
buildit : buildit.c
         cleartool co -unres -nc $@
         del /F $@
         cl /c $@ $*.c
         cleartool ci -nc buildit
```

You can work around this problem by building and checking in a derived object in two steps. For example, the makefile contains one build script that creates the DO, and another build script that checks it in, as shown here:

```
buildit : buildit.c
    cleartool co -unres -nc $@
    del /F $@
    cl /c $@ $*.c

stageit : buildit
    cleartool ci -nc buildit
```

The command **clearmake stageit** performs the following steps:

1. Brings the target **buildit** up to date. This creates a DO named **buildit** and an associated config record.
2. Brings the target **stageit** up to date. This step checks in the **buildit** derived object as a DO version.

---

## Accessing DO Versions

When you check out a DO version, it is winked in to your dynamic view. You can use a standard pathname to access the DO's file system data. However, VOB-database access is handled in the following ways:

- A standard pathname to the DO references the version in the VOB database from which the checkout was made:

```
z:\myvob\bin> cleartool checkout -nc hello           (wink in derived object
Checked out "hello" from version "\main\3".         hello)
```

```
z:\myvob\bin> cleartool mklabel EXPER hello         (use standard pathname to
Created label "EXPER" on "hello" version "\main\3". access version from which
                                                       checkout was made)
```

- To access the checked-out placeholder version, you must use an extended pathname:

```
z:\myvob\bin> cleartool mklabel -replace EXPER hello@@\main\CHECKEDOUT
Moved label "EXPER" on "hello" from version "\main\3" to
"\main\CHECKEDOUT".
```

If you process a checked-out DO version as described in *Converting Derived Objects to View-Private Files* on page 57, ClearCase reverts to its usual handling of checked-out versions. In this case, a standard pathname references the placeholder version in the VOB database.

---

## Displaying Configuration Records for DO Versions

The **catcr** command displays the configuration record for a DO version. When you use **catcr -recurse** to display the CRs for a DO and all its subtargets, it does not display the CRs for DO versions unless you use the **-ci** option.

The following examples show how to display configuration records for DO versions.

- To display the configuration record for a single DO version:

### **cleartool catcr test**

```
Target test built by smg.user
Host "duck" running NT 4.0 (i586)
Reference Time 20-Jul-99.14:27:38, this audit started 20-Jul-99.14:27:39
View was swan:C:\views\smg_build2.vws
Initial working directory was V:\smg_build\dir
-----
MVFS objects:
-----
\smg_build\dir\test@@20-Jul.14:27.71
\smg_build\dir\test.txt@@\main\1          <20-Jul-99.14:27:23>
-----
Build Script:
-----
          copy test.txt test
-----
```

- To display the configuration record for a derived object, including the CRs of all subtargets except DO versions:

### **cleartool catcr -recurse foo**

```
-----
-----
Target foo built by smg.user
...
Target file2.txt built by smg.user
...
Target file2sub.txt built by smg.user
...
-----
```

- To display the configuration record for a derived object, including the CRs of all subtargets:

```
cleartool catcr -recurse -ci foo
-----
-----
Target foo built by smg.user
...
Target file1.txt built by smg.user
...
Target file1sub.txt built by smg.user
...
Target file2.txt built by smg.user
...
Target file2sub.txt built by smg.user
...
```

For more information, see the **catcr** reference page.

---

## Releasing DOs

A project team can use DO versions to make its product (for example, a library) available to other teams. Typically, the team establishes a release area in a separate VOB. For example:

- A library is built by its project team in one location—perhaps `\monet\lib\libmonet.lib`.
- The team periodically releases the library by creating a new version of a publicly accessible element—perhaps `\publib\libmonet.lib`.

You can generalize the idea of maintaining a development release area to maintaining a product release area. For example, a Release Engineering group maintains one or more release tree VOBs. The directory structure of the trees mirrors the hierarchy of files to be created on the release medium. (Because a release tree involves directory elements, it is easy to change its structure from release to release.) A release tree can be used to organize Release 2.4.3 as follows:

- When an executable or other file is ready to be released, a release engineer checks it in as a version of an element in the release tree.
- An appropriate version label (for example, **REL2.4.3**) is attached to that version, either manually by the engineer or automatically with a trigger.

- ▶ When all files to be shipped have been released in this way, a release engineer configures a view to select only versions with that version label. As seen through this view, the release tree contains exactly the set of files to be released.
- ▶ To cut a release tape, the engineer issues a command to copy the appropriately configured release tree.

---

## 4.9 Converting Nonshareable DOs to Shared DOs

**NOTE:** You cannot convert a shared or unshared DO to a nonshareable DO.

To convert a nonshareable DO to a shared DO, use the **winkin** command. **winkin** advertises the DO by making it shareable and writing information into the VOB, and then promotes it (makes it shared). The command also advertises the DO's sub-DOs and siblings, even if you did not specify the **-siblings** option. This process changes the DO-ID for each derived object.

The **view\_scrubber -p** command performs the same operation. See the **winkin** and **view\_scrubber** reference pages.

---

### Automatic Conversion of Nonshareable DOs to Shareable DOs

Because you can change a view's DO property, and shareable DOs cannot have nonshareable sub-DOs or siblings, situations can occur in which the build tool must convert nonshareable DOs into shareable DOs.

For example, you set your view's DO property to nonshareable DOs, and then perform a build, creating nonshareable DOs. You then set your view's DO property to shareable DOs, and perform another build. The build tool determines that it can reuse some of the nonshareable DOs created in the first build to create shareable DOs in the second. It converts the nonshareable DOs to shareable DOs and reuses them.



---

## 4.10 Displaying VOB Disk Space Usage for Derived Objects

The **dospace** command and the ClearCase Administration Console report VOB disk space usage for shared derived objects. For more information, see the **dospace** reference page and *Administering ClearCase*.

---

## 4.11 Deleting Derived Objects

The **rmdo** command removes the data container and the VOB database object for a derived object. See the **rmdo** reference page for more information.

Shareable derived objects and their data containers can be deleted independently. Deleting a nonshareable derived object deletes the DO.

---

### Removing Data Containers for Derived Objects

The standard **del** command causes a shareable derived object to disappear from the dynamic view. The effect on physical data storage is as follows:

- If the DO's data container is in the view's private storage area, **del** deletes that data container.
- If the DO's data container is in a VOB storage pool, the data container is not affected.

In both cases, the derived object in the VOB database is not deleted. The only change to the derived object is that its reference count is decremented.

When a build overwrites a nonshareable or unshared DO, the MVFS removes the old data container from the dynamic view's private storage area, and creates a new one there. It also creates a new CR. At the operating system level, the effect is that an existing file is overwritten.

---

## Scrubbing Derived Objects and Data Containers

A reference count of zero means that the derived object has been deleted or overwritten in every view that ever used it. This situation calls for *scrubbing*: automatic deletion of DO-related information from the VOB. Scrubbing can remove the derived object from the VOB database, its data container from a VOB storage pool (if the DO had ever been shared), and in some cases its associated CR, as well.

The **scrubber** utility removes derived objects from a VOB database and data containers from VOB storage pools. The **view\_scrubber** utility removes data containers from a dynamic view's private storage area. For more on scrubbing, see *Administering ClearCase*.

---

## Degenerate Derived Objects

A derived object is complete if its VOB database object, data container, and configuration record (CR) are accessible. Because these entities exist independently, a derived object can become incomplete, or degenerate, if one entity is missing.

### Data Container Deleted

When an unshared DO is removed with **del** or by a target rebuild, its VOB database object continues to exist in the VOB database (with a zero reference count), but the data container no longer exists. Such DOs are usually ignored by **lsdo**, but can be listed with the **-zero** option. The **scrubber** utility deletes zero-referenced DOs.

The **checkvob** command can find and fix missing container problems.

### DO Deleted from VOB Database

When an unshared DO is removed from its VOB database with **rmdo**, the data container continues to be visible:

```
Z:\myvob\test> cleartool rmdo Vhelp.log           (in general, avoid 'rmdo'!)
Removed derived object "Vhelp.log@14-Sep.72783".
```

```
Z:\myvob\test> cleartool ls Vhelp.log
Vhelp.log [no config record]
```

## CR Unavailable

A newly created CR is stored in the dynamic view where its associated DOs were built. If that view becomes unavailable (for example, it is inadvertently destroyed or its host is temporarily down), the DO continues to exist in the VOB database, but operations that must access the CR fail:

```
cleartool: Error: Unable to find view '\\mars\vw_store\pink.vws'  
from albd: error detected by ClearCase subsystem  
cleartool: Error: See albd_log on host mars  
cleartool: Error: Unable to contact View - error detected by ClearCase  
subsystem
```

---

## 4.12 Displaying Contents of Configuration Records

The `catcr` command displays the contents of a configuration record. See the `catcr` reference page for more information.

---

## 4.13 Comparing Configuration Records

Because config records provide complete records of how DOs are built, you can use them to determine how two builds differ. For example, you expected the build to reuse or wink in a DO that it rebuilt instead. You can compare the CRs for the two DOs to find out what aspect of the build environment was different.

To compare two existing CRs, use the `diffcr` command. For more information, see the `diffcr` reference page.

---

## 4.14 Attaching Labels or Attributes to Versions in a CR

You can attach a label or an attribute to the versions in the CR hierarchy of a derived object.

For example, to attach the `SMG_BUILD_5_99` label to the versions in the CR hierarchy of `file.obj`:

```
cleartool mklabel -c "may 99 build" -config file.obj SMG_BUILD_5_99
```

```
Created label "SMG_BUILD_5_99" on "\smg_test\" version "\main\CHECKEDOUT".
```

```
Created label "SMG_BUILD_5_99" on "\smg_test\acc.c" version "\main\2".
```

```
Created label "SMG_BUILD_5_99" on "\smg_test\file.c" version "\main\1".
```

For more information, see the description of the `-config` option in the `mkattr` and `mklabel` reference pages.

---

## 4.15 Configuring a View to Select Versions Used to Build a DO

To select the versions in the CR hierarchy of a derived object, use the `-config` version selector in your view's config spec. For example, the following config spec selects the versions in the CR hierarchy for `hello.obj`:

```
element * CHECKEDOUT
element * -config \dev\lib\hello.obj
element * \main\v3.8\LATEST
```

For more information, see the `config_spec` reference page.

---

## 4.16 Including a Makefile Version in a Configuration Record

To record a makefile version in a CR, use one of the following methods:

- Declare it as an explicit dependency in the makefile. To do this, you can use the `$(MAKEFILE)` variable. You must explicitly list any included makefiles you want recorded.

The drawback to this method is that it causes targets that depend on the makefile to be rebuilt if there is any change to the makefile.

- Make it an implicit dependency by referring to it in a build script, and use the special target **.DEPENDENCY\_IGNORED\_FOR\_REUSE** to ignore it in subsequent rebuild decisions. You must explicitly list any included makefiles you want recorded.

For example:

```
.DEPENDENCY_IGNORED_FOR_REUSE: $(MAKEFILE)
targ: dep1 dep2
    type $(MAKEFILE) > c:\temp\makefile
    touch targ
```

The drawback to this method is that the makefile dependency is ignored for reuse, but it is not ignored for winkin.



This chapter describes *makefiles* processed by the ClearCase build program **clearmake**. This is a discussion of differences and ClearCase extensions, rather than a complete description of makefile syntax. This chapter also describes build option specification files (BOS files), which contain temporary macros and ClearCase special targets.

For information on the **omake** build program, see the *ClearCase OMAKE Manual*.

---

### 5.1 Makefile Overview

A makefile contains a sequence of entries, each of which specifies a build target, some dependencies, and the *build scripts* of commands to be executed. A makefile can also contain *make macro* definitions, target-dependent macro definitions, and build directives (*special targets*.)

- ▶ **Target/dependencies line.** The first line of an entry is a white-space-separated, nonnull list of *targets*, followed by a colon (:) or a double colon (::), and a (possibly empty) list of *dependencies*. Both targets and dependencies may contain ClearCase pathname patterns. (See the **wildcards\_ccase** reference page.)

The list of dependencies may not need to include source objects, such as header files, because **clearmake** detects these dependencies. However, the list must include build-order dependencies, for example, object modules and libraries that must be built before executables. (See *Build-Order Dependencies* on page 37.)

- ▶ **Build script.** Text following a semicolon (;) on the same line, and all subsequent lines that begin with a <TAB> character, constitute a *build script*: a set of commands to be executed in a

command interpreter. A command can be continued onto the next text line with a `\<NL>` sequence. Any line beginning with a number sign (`#`) is a comment.

A build script ends at the first nonempty line that does not begin with a `<TAB>` or number sign (`#`); this begins a new target/dependencies line or a make macro definition.

Build scripts must use standard pathnames only. Do not include view-extended or version-extended pathnames in a build script.

Executing a build script updates the target, and is called a *target rebuild*. The commands in a build script are executed one at a time, each in its own instances of the command interpreter.

Note that **clearmake** always completely eliminates a `\<NL>` sequence, even in its compatibility modes. Some other **make** programs sometimes preserve such a sequence.

- ▶ **Make macro.** A *make macro* is an assignment of a character-string value to a simple name. By convention, all letters in the name are uppercase (for example, **CFLAGS**).
- ▶ **Target-dependent macro definitions.** A target-dependent macro definition takes the form *target-list := macro\_name = string*

You can use macros in makefiles or in BOS files. For more information, see *Target-Dependent Macro Definitions* on page 83.

- ▶ **Special targets.** A line that begins with a dot (`.`) is a *special target*, which acts as a directive to **clearmake**.

---

## 5.2 Build Options Specification Files

A *build options specification* (BOS) file is a text file containing macro definitions and/or ClearCase special targets. We recommend that you place temporary macros (such as **CFLAGS=/Zi** and others not to be included in a makefile permanently) in a BOS file, rather than specifying them on the **clearmake** command line.



By default, **clearmake** reads BOS files in this order:

1. The default BOS files
  - a. The file **.clearmake.options** in your home directory (as indicated by the **HOME** environment variable or in the user profile), which is the place for macros to be used every time you execute **clearmake**.
  - b. One or more local BOS files, each of which corresponds to one of the makefiles specified with a **-f** option, or read by **clearmake**. Each BOS file has a name in the form *makefile-name.options*. For example:

```
makefile.options
Makefile.options
project.mk.options
```
2. BOS files specified in the **CCASE\_OPTS\_SPECS** environment variable.
3. BOS files specified on the command line with **-A**.

If you specify **-N**, **clearmake** does not read default BOS files.

**clearmake** displays the names of the BOS files it reads if you specify the **-v** or **-d** option, or if **%CCASE\_VERBOSITY%>= 1**.

For information on the contents of BOS files, see *BOS File Entries* on page 83.

---

## 5.3 Format of Makefiles

The following sections describe the special considerations for using makefiles with **clearmake**.

---

### Restrictions

**clearmake** does not support the use of standard input as a makefile.

---

## Libraries

If a target or dependency name contains parentheses, it is assumed to be an archive (library) created by **lib**, or some other librarian. For example:

```
hello.lib : hello.lib(mod1.obj) hello.lib(mod2.obj)
```

The string within parentheses refers to a member (object module) within the library. Use of function names within parentheses is not supported. Thus, **hello.lib(mod1.obj)** refers to an archive that contains object module **mod1.obj**. The expression **hello.lib(mod1.obj mod2.obj)** is not valid.

Inference rules for archive libraries have this form:

**.sfx.lib**

where **sfx** is the file-name extension (suffix) from which the archive member is to be made.

The way in which **clearmake** handles incremental archive construction differs from other **make** variants. For more on this topic, see *Working with Incremental Update Tools* on page 45.

---

## Command Echoing and Error Handling

You can control the echoing of commands and the handling of errors that occur during command execution on a line-by-line basis, or on a global basis.

You can prefix any command with one or two characters, as follows:

- Causes **clearmake** to ignore any errors during execution of the command. By default, an error causes **clearmake** to terminate.  
The command-line option **-i** suppresses termination-on-error for all command lines.
- @ Suppresses display of the command line. By default, **clearmake** displays each command line just before executing it.  
The command-line option **-s** suppresses display of all command lines. The **-n** option displays commands, but does not execute them.
- @ @- These two prefixes combine the effect of **-** and **@**.

The **-k** option provides for partial recovery from errors. If an error occurs, execution of the current target (that is, the set of commands for the current target) stops, but execution continues on other targets that do not depend on that target.

---

## Built-In Rules

File-name extensions (suffixes) and their associated rules in the makefile override any identical file-name extensions in the built-in rules. **clearmake** reads built-in rules from the file *ccase-home-dir\etc\builtin.mk* when you run in standard compatibility mode. In other compatibility modes, other files are read. See Chapter 6, *Using clearmake Compatibility Modes*.

---

## Include Files

If a line in a makefile starts with the string **include** or **sinclude** followed by white space (at least one <SPACE> or <TAB> character), the rest of the line is assumed to be a file name. (This name can contain macros.) The contents of the file are placed at the current location in the makefile.

For **include**, a fatal error occurs if the file is not readable. For **sinclude**, a nonreadable file is silently ignored.

---

## Macros

The following sections describe the order of precedence of macros in a **clearmake** build, and the different types of macros.

### Order of Precedence of Make Macros and Environment Variables

By default, the order of precedence of macros and environment variables is as follows:

1. Target-dependent macro definitions
2. Macros specified on the **clearmake** command line
3. Make macros set in a BOS file

4. Make macro definitions in a makefile
5. Environment variables

For example, target-dependent macro definitions override all other macro definitions, and macros specified on the **clearmake** command line override those set in a BOS file.

If you use the **-e** option to **clearmake**, environment variables override macro definitions in the makefile.

All BOS file macros (except those overridden on the command line) are placed in the build script's environment. If a build script recursively invokes **clearmake**:

- ▶ The higher-level BOS file setting (now transformed into an EV) is overridden by a make macro set in the lower-level makefile. However, if the recursive invocation uses **clearmake**'s **-e** option, the BOS file setting prevails.
- ▶ If another BOS file (associated with another makefile) is read at the lower level, its make macros override those from the higher-level BOS file.

See *Special Environment Variables* in the **clearmake** reference page for a list of build-related environment variables.

## Make Macros

A *macro definition* takes this form:

```
macro_name = string
```

Macros can appear in the makefile, on the command line, or in a *build options specification* file. (See *Build Options Specification Files* on page 70.)

Macro definitions require no quotes or delimiters, except for the equal sign (=), which separates the macro name from the value. Leading and trailing white space characters are stripped. Lines can be continued using a `\<NL>` sequence; this sequence and all surrounding white space is effectively converted to a single `<SPACE>` character. *macro\_name* cannot include white space, but *string* can; it includes all characters up to an unescaped `<NL>` character.

**clearmake** performs macro substitution whenever it encounters either of the following in the makefile:

```
$(macro_name)  
$(macro_name:subst1=subst2)
```

It substitutes *string* for the macro invocation. In the latter form, **clearmake** performs an additional substitution within *string*: all occurrences of *subst1* at the end of a word within *string* are replaced by *subst2*. If *subst1* is empty, *subst2* is appended to each word in the value of *macro\_name*. If *subst2* is empty, *subst1* is removed from each word in the value of *macro\_name*.

For example:

```
z:\myvob> type Makefile
C_SOURCES = one.c two.c three.c four.c
test:
    echo OBJECT FILES are: $(C_SOURCES:.c=.obj)
    echo EXECUTABLES are: $(C_SOURCES:.c=.exe)

z:\myvob> clearmake test
OBJECT FILES are: one.obj two.obj three.obj four.obj
EXECUTABLES are: one.exe two.exe three.exe four.exe
```

## Internal Macros

**clearmake** maintains these macros internally. They are useful in rules for building targets.

<b>\$*</b>	(Defined only for inference rules) The file name part of the inferred dependency, with the file-name extension deleted.
<b>@\$</b>	The full target name of the current target.
<b>\$&lt;</b>	(Defined only for inference rules) The file name of the implicit dependency.
<b>\$?</b>	(Defined only when explicit rules from the makefile are evaluated) The list of dependencies that are out of date with respect to the target. When configuration lookup is enabled (default), it expands to the list of all dependencies, unless that behavior is modified with the <b>.INCREMENTAL_TARGET</b> special target. In that case, <b>\$?</b> expands to the list of all dependencies different from the previously recorded versions.  When a dependency is an archive library member of the form <code>lib(file.obj)</code> , the name of the member, <b>file.obj</b> , appears in the list.
<b>\$%</b>	(Defined only when the target is an archive library member) For a target of the form <code>lib(file.obj)</code> , <b>@\$</b> evaluates to <code>lib</code> and <b>\$%</b> evaluates to the library member, <b>file.obj</b> .
<b>MAKE</b>	The name of the make processor (that is, <b>clearmake</b> ). This macro is useful for recursive invocation of <b>clearmake</b> .

**MAKEFILE** During makefile parsing, this macro expands to the pathname of the current makefile. After makefile parsing is complete, it expands to the pathname of the last makefile that was parsed. This holds only for top-level makefiles, not for included makefiles or for built-in rules; in these cases, it echoes the name of the including makefile.

Use this macro as an explicit dependency to include the version of the makefile in the CR produced by a target rebuild. For example:

```
supersort: main.obj sort.obj cmd.obj $(MAKEFILE)
        link /out:$@ $?
```

For more information, see *Including a Makefile Version in a Configuration Record* on page 66.

## **VPATH Macro**

The **VPATH** macro specifies a search path for targets and dependencies. **clearmake** searches directories in **VPATH** when it fails to find a target or dependency in the current working directory. **clearmake** searches only in the current view. The value of **VPATH** can be one directory pathname, or a semicolon-separated list of directory pathnames. (In Gnu compatibility mode, you can also use spaces as separators.)

Configuration lookup is **VPATH**-sensitive when qualifying makefile dependencies (explicit dependencies in the makefile). Thus, if a newer version of a dependent file appears in a directory on the search path before the pathname in the CR (the version used in the previous build), **clearmake** rejects the previous build and rebuilds the target with the new file.

The **VPATH** setting may affect the expansion of internal macros, such as **\$<**.

---

## **Special Targets**

Like other build tools, **clearmake** interprets certain target names as declarations. Some of these special targets accept lists of patterns as their dependents, as noted in the description of the target. Pattern lists may contain the pattern character, **%**. When evaluating whether a name matches a pattern, the tail of the prefix of the name (subtracting directory names as appropriate) must match the part of the pattern before the **%**; the file-name extension of the name must match the part of the pattern after the **%**. For example:

Name	Matches	Does not match
\dir\subdir\x.obj	%.obj x.obj subdir\%.obj subdir\x.obj	\dir\subdir\otherdir\x.obj

The following targets accept lists of patterns:

- **.DEPENDENCY\_IGNORED\_FOR\_REUSE**
- **.INCREMENTAL\_REPOSITORY\_SIBLING**
- **.INCREMENTAL\_TARGET**
- **.NO\_CMP\_NON\_MF\_DEPS**
- **.NO\_CMP\_SCRIPT**
- **.NO\_CONFIG\_REC**
- **.NO\_DO\_FOR\_SIBLING**
- **.NO\_WINK\_IN**
- **.SIBLING\_IGNORED\_FOR\_REUSE**

### Special Targets for Use in Makefiles

#### **.DEFAULT :**

If a file must be built, but there are no explicit commands or relevant built-in rules to build it, the commands associated with this target are used (if it exists).

#### **.IGNORE :**

Same effect as the `-i` option.

#### **.PRECIOUS : tgt ...**

The specified targets are not removed when an interrupt character (typically, `<CTRL-C>`) is typed.

#### **.SILENT :**

Same effect as the `-s` option.

### Special Targets for Use in Makefiles or BOS Files

You can use the following special targets either in the makefile itself or in a *build options specification* file. See *Build Options Specification Files* on page 70.

#### **.DEPENDENCY\_IGNORED\_FOR\_REUSE:** *file ...*

The dependencies you specify are ignored when **clearmake** determines whether a target object in a VOB is up to date and can be reused. By default, **clearmake** considers that a target cannot be reused if its dependencies have been modified or deleted since it was built. This target applies only to reuse, not to winkin. Also, this target applies only to *detected* dependencies, which are not declared explicitly in the makefile.

You can specify the list of files with a tail-matching pattern; for example, **%.module**.

Unlike the files listed in most special targets, the files on this list refer to the names of dependencies and not the names of targets. As such, the special target may apply to the dependencies of many targets at once. This special target is most useful when identifying a class of dependencies found in a particular toolset for which common behavior is desired across all targets that have that dependency.

#### **.INCREMENTAL\_REPOSITORY\_SIBLING:** *file ...*

The sibling files listed are incremental repository files created as siblings of a primary target, may contain incomplete configuration information, and prevent **clearmake** from winking in the primary target. This special target is useful for situations where a toolset creates an incremental sibling object, and you want more control over how that object is used.

You can specify the list of files with a tail-matching pattern; for example, **%.pdb**.

Unlike the files listed in most special targets, the files on this list refer to the names of sibling objects and not the names of targets. As such, the special target may apply to the siblings of many targets at once. This special target is most useful when identifying a class of siblings found in a particular toolset for which common behavior is desired across all targets that have that sibling.

#### **.INCREMENTAL\_TARGET:** *tgt ...*

Performs incremental configuration record merging for the listed targets; in other words, combines dependency information from instances of this target generated previously with the current build of this target. This special target is most useful when building libraries, because typically only some of the objects going into a library are read each time the library is updated.

You can specify the list of files with a tail-matching pattern; for example, **%.lib**.

For information on restructuring a makefile to build incremental archive files, see *Working with Incremental Update Tools* on page 45.



**NOTE:** `.INCREMENTAL_TARGET` applies only to makefile targets built incrementally using a single make rule. Do not use it for the following kinds of files:

- Files built incrementally that are not makefile targets. For example, sibling objects like log files or template repositories.
- Files built incrementally from several different build scripts.

The general guideline is that if you're not building a library in a single makefile rule, and you're not building an executable using an incremental linker, you should not use `.INCREMENTAL_TARGET`.

`.NO_CMP_NON_MF_DEPS : tgt ...`

The specified targets are built as if the `-M` option were specified; if a dependency is not declared in the makefile, it is not used in configuration lookup.

You can specify the list of files with a tail-matching pattern; for example, `%.obj`.

`.NO_CMP_SCRIPT : tgt ...`

The specified targets are built as if the `-O` option were specified; build scripts are not compared during configuration lookup. This is useful when different makefiles (and, hence, different build scripts) are regularly used to build the same target.

You can specify the list of files with a tail-matching pattern; for example, `%.obj`.

`.NO_CONFIG_REC : tgt ...`

The specified targets are built as if the `-F` option were specified; modification time is used for build avoidance, and no CRs or derived objects are created.

You can specify the list of files with a tail-matching pattern; for example, `%.obj`.

`.NO_DO_FOR_SIBLING: file ...`

Disables the creation of a derived object for any file listed if that file is created as a sibling derived object (an object created by the same build rule that created the target). These sibling derived objects are left as view-private files.

You can specify the list of files with a tail-matching pattern; for example, `%.tmp`.

Unlike the files listed in most special targets, the files on this list refer to the names of sibling objects and not the names of targets. As such, the special target may apply to the siblings of many targets at once. This special target is most useful when identifying a class of siblings found in a particular toolset for which common behavior is desired across all targets that have that sibling.

**.NO\_WINK\_IN** : *tgt* ...

The specified targets are built as if the **-V** option were specified; configuration lookup is restricted to the current view.

You can specify the list of files with a tail-matching pattern; for example, **%.obj**.

**.SIBLING\_IGNORED\_FOR\_REUSE**: *file* ...

The *files* are ignored when **clearmake** determines whether a target object in a VOB is up to date and can be reused. This is the default behavior, but this special target can be useful in conjunction with the **.SIBLINGS\_AFFECT\_REUSE** special target or **-R** command-line option. This target applies only to reuse, not to winkin.

You can specify the list of files with a tail-matching pattern; for example, **%.sbr**.

Unlike the files listed in most special targets, the files on this list refer to the names of sibling objects and not the names of targets. As such, the special target may apply to the siblings of many targets at once. This directive is most useful when identifying a class of siblings found in a particular toolset for which common behavior is desired across all targets that have that sibling.

**.SIBLINGS\_AFFECT\_REUSE**:

Build as if the **-R** command line option were specified; examine sibling derived objects when determining whether a target object in a VOB can be reused (is up to date). By default, when determining whether a target is up to date, **clearmake** ignores modifications to objects created by the same build rule that created the target (sibling derived objects). This directive tells **clearmake** to consider a target out of date if its siblings have been modified or deleted.

---

## 5.4 Using Makefiles on Windows

There are several rules to follow when constructing, or converting, makefiles for use by **clearmake** on a Windows host. Note that, as a general rule, your makefiles must match the syntax required by **clearmake** on UNIX.

In many cases, you cannot use UNIX makefiles on Windows NT without modification. However, to avoid rewriting makefiles, you can use **Imake** to generate host-specific makefiles from a common source.

---

## Case-Sensitivity Guidelines

The following sections describe how you must specify build macros, targets, and dependencies in makefiles to avoid case problems.

### Build Macros and Case-Sensitivity

**clearmake** is case-sensitive with respect to makefile macros. Consider a makefile macro reference, `$(CPU)`. There are numerous input sources from which to satisfy this macro:

- From the makefile itself
- From the current table of environment variables
- From the command line
- From a build option specification (BOS) file

For any macro to be expanded correctly from any of these sources, the macro definition and macro reference must be in the same case. For example, `$(CPU)` is not replaced by the value of an EV named `cpu`.

### Makefile Target/Dependency Pathnames

When you write makefiles, you must be aware of the MVFS setting on your computer and specify targets and dependencies accordingly. If the MVFS is case-preserving, you must use case-correct pathnames in makefiles to guarantee the consistency of the resulting config records. Even if your MVFS is not case-preserving, we recommend that you use case-correct pathnames so that users on case-preserving computers can share the makefile.

**NOTE:** The `-d` option to **clearmake** warns you when case is the only difference in pathnames in the makefile and on the file system.

Table 1 describes makefile requirements for the different MVFS settings.

Table 1 MVFS Settings and Case Requirements for Makefiles

MVFS Setting	Build Tool and MVFS Behavior	Makefile Requirements
Case-insensitive and case preserving	The MVFS preserves the case of created files. The build tool looks for the file as it is specified in the makefile.	The case of the target must match the case of the file produced by the MVFS.
Case-insensitive and non-case-preserving	The MVFS converts the names of all files created to lowercase. The build tool looks for a lowercase file name.	The case of the target does not matter.
Case-sensitive and case-preserving	The MVFS preserves the case of created files. The build tool looks for the file as it is specified in the makefile.	The case of the target must match the case of the file produced by the MVFS.

---

## Supporting Both **omake** and **clearmake**

It is possible, but not trivial, to prepare makefiles that can be used with either **omake** or **clearmake**. The general approach is to supply **omake**-specific macro definitions in the makefile, and to supply **clearmake**-specific macro overrides in a build options specification (BOS) file; **clearmake** reads the BOS file, but **omake** does not. When **clearmake** executes, it looks for macro definitions in two locations:

- `%HOME%\clearmake.options`
- `makefile.options`, in the same directory as `makefile` (substitute the actual name of your makefile, if it is not `makefile`)

BOS files at other locations can be passed to **clearmake** with the `-A` option.

---

## Using UNIX-Style Command Shells in Makefiles

On Windows, **clearmake** accepts either slashes (`/`) or backslashes (`\`) in pathnames. However, **clearmake** uses a backslash as the separator in any pathnames that it constructs in build scripts

(for example, as a result of `VPATH` directory searching). This can cause problems with UNIX-like command shells that require slashes in any pathnames supplied to them in command lines.

If you are using such a shell (for example, by setting the `SHELL` makefile variable accordingly), you can force **clearmake** to use slashes when constructing pathnames. To do this, set the `CMAKE_PNAME_SEP` variable:

```
CMAKE_PNAME_SEP = /
```

You can set `CMAKE_PNAME_SEP` in the makefile, in the BOS file, on the command line, or as an environment variable.

---

## 5.5 BOS File Entries

The following sections describe the entries you can put in BOS files.

---

### Standard Macro Definitions

A standard macro definition has the same form as a make macro defined in a makefile:

```
macro_name = string
```

For example:

```
CDEBUGFLAGS = /Zi
```

---

### Target-Dependent Macro Definitions

A target-dependent macro definition takes this form:

```
target-pattern-list := macro_name = string
```

Any standard macro definition can follow the `:=` operator; the definition takes effect only when targets matching patterns in *target-pattern-list* and their dependencies are processed. Patterns in the *target-pattern-list* must be separated by white space. For example:

```
foo.o bar.o := CDEBUGFLAGS=/zi
```

Two or more higher-level targets can have a common dependency. If the targets have different target-dependent macro definitions, the dependency is built using the macros for the first higher-level target **clearmake** considered building (whether or not **clearmake** actually built it).

---

## Shell Command Macro Definitions

A shell command macro definition replaces a macro name with the output of a shell command:

```
macro_name :sh = string
```

This defines the value of *macro\_name* to be the output of *string*, any shell command. In command output, <NL> characters are replaced by <SPACE> characters. For example:

```
NT_VER :sh = VER
```

---

## Special Targets

You can use some ClearCase special targets in a build options spec. See *Special Targets for Use in Makefiles or BOS Files* on page 77.

---

## Include Directives

To include one BOS file in another, use the **include** or **sinclude** (silent include) directive. For example:

```
include \lib\aux.options
```

```
sinclude $(OPTS_DIR)\pm_build.options
```

---

## Comments

A BOS file can contain comment lines, which begin with a number sign (#).

## Using **clearmake** Compatibility Modes

# 6

**clearmake** is designed for compatibility with existing **make** programs, which minimizes the changes you need to make to your makefiles. There are many variants of **make**, and each provides different sets of extended features. **clearmake** does not support all features of all variants, and we do not guarantee absolute compatibility.

If your makefiles use only the common extensions, they will probably work with **clearmake** without changes. If you must use features that **clearmake** does not support, consider using another **make** program in a **clearaudit** shell. This alternative provides build auditing (configuration records), but does not provide build avoidance (*winkin*).

**NOTE:** When building with configuration records, **clearmake** handles double-colon rules differently from other **make** programs. For details, see *How clearmake Interprets Double-Colon Rules* on page 39.

To specify a compatibility mode, do one of the following things:

- ▶ Use the environment variable **CCASE\_MAKE\_COMPAT** in a build options specification file or in your environment. For more information, see *Build Options Specification Files* on page 70.
- ▶ Use the **-C** option with **clearmake**. For more information, see the **clearmake** reference page.

In either case, you can use any of these compatibility modes:

<b>gnu</b>	Free Software Foundation Gnu make
<b>std</b>	Standard <b>clearmake</b> with no compatibility mode enabled (Use this option to nullify a setting of the environment variable <b>CCASE_MAKE_COMPAT</b> )

The following section describes **clearmake**'s compatibility with Free Software Foundation Gnu make.

---

## 6.1 Free Software Foundation Gnu make

The following sections describe supported and unsupported Gnu make features.

---

### VPATH Separator Character

You can use semicolons or spaces as separators in the **VPATH** macro. For more information, see *VPATH Macro* on page 76.

---

### Supported Gnu Make Command-Line Options

**clearmake** supports most of the single-character subset of Gnu make's command-line interface. However, **clearmake** does not accept any of the long-form spellings for Gnu make command options.

**NOTE:** If you need to use the long-form spellings, you can write a Perl wrapper that translates the long-form options into short-form and invokes **clearmake** with the short-form options.

**clearmake -C gnu** supports the following Gnu make command-line options:

- d** Prints debugging information in addition to normal processing messages.
- e** Gives variables taken from the environment precedence over variables from makefiles.
- f FILE** Reads *FILE* as a makefile.
- i** Ignores all errors in commands executed to remake files.



- k**  
Continues as much as possible after an error.
- I DIR**  
Specifies a directory *DIR* to search for included makefiles.
- n**  
Prints the commands that would be executed, but does not execute them.
- P**  
Prints the data base (rules and variable values) that results from reading the makefiles, and then executes as usual or as otherwise specified.
- r**  
Eliminates use of the built-in implicit rules.
- s**  
Silent operation. Does not print the commands as they are executed.
- v**  
Prints the version of the make program.
- w**  
Prints a message containing the working directory both before and after executing the makefile.
- q**  
Question mode. Does not run any commands, or print anything. Returns an exit status of zero if the specified targets are already up to date, or one if any remaking is required.

---

## Unsupported Gnu Make Command-Line Options

- **-C DIR**  
--directory=DIR
- **--no-print-directory**
- **--warn-undefined-variables**
- **-h**  
--help

- `-t`  
`--touch`
- `-j [JOBS]`  
`--jobs=[JOBS]`
- `-l [LOAD]`  
`--load-average[=LOAD]`  
`--max-load[=LOAD]`
- `-o FILE`  
`--old-file=FILE`  
`--assume-old=FILE`
- `-W FILE`  
`--what-if=FILE`  
`-new-file=FILE`  
`--assume-new=FILE`
- `-S`  
`--no-keep-going`  
`--stop)`
- `-f -`

---

## Supported Gnu Make Features

The following features are enabled with `-C gnu` (see the *Gnu Make* manual for details):

- Conditional makefile interpretation. For example:

```
ifeq ($(CC),gcc)
    $(CC) -o foo $(objects) $(libs_for_gcc)
else
    $(CC) -o foo $(objects) $(normal_libs)
endif
```

- Simply expanded variables

```
y := $(x) bar
```

in which the right side is expanded once when the assignment is first scanned

- The += syntax to append to the value of a variable
- Stripping leading sequences of .\ from file names, so *.\file* and *file* are considered to be the same target
- Variable references using pattern substitution:

```
${VAR:PATTERN_1=PATTERN_2}
```

- Text-manipulation functions, such as these:

```
$(subst FROM,TO,TEXT)
```

```
$(patsubst PATTERN,REPLACEMENT,TEXT)
```

```
$(strip STRING)
```

```
$(findstring FIND,IN)
```

```
$(filter PATTERN...,TEXT)
```

```
$(filter-out PATTERN...,TEXT)
```

```
$(sort LIST)
```

```
$(dir NAMES...)
```

```
$(notdir NAMES...)
```

```
$(suffix NAMES...)
```

```
$(basename NAMES...)
```

```
$(addsuffix SUFFIX,NAMES...)
```

```
$(addprefix PREFIX,NAMES...)
```

```
$(join LIST1,LIST2)
```

```
$(word N,TEXT)
```

```
$(words TEXT)
```

```
$(wordlist START, END, TEXT)
```

```
$(firstword NAMES...)
```

```
$(wildcard PATTERN)
```

```
$(foreach VAR,LIST,TEXT)
```

```
$(origin VARIABLE)
```

```
$(shell COMMAND)
```

- The **VPATH** variable for specifying a search path for every dependency

**NOTE:** **clearmake** searches only in the current view. See *VPATH Macro* on page 76.

- The **vpath** statement for specifying a search path for a specified class of names
- The **export** statement
- The **unexport** directive
- The **.PHONY** target declaration
- All of Gnu Make's built-in implicit rules
- Pattern rules. For example:

```
%.o : %.c  
    COMMANDS  
    ...
```

- Static pattern rules:

```
TARGETS ...: TARGET-PATTERN: DEP-PATTERNS ...  
    COMMANDS  
    ...
```

- The automatic variables

```
$@ $* $< $% $? $^ $+
```

and their file-name and directory-name variants. For example:

```
$(@F) $(@D) ...
```

- Multiline variable definition:

```
define VAR
    TEXT
    ...
endif
```

- Error processing of rules

In standard make, a rule stops processing when any command in it returns an error. In Gnu make, the rule continues processing unless the shell was invoked with the `-e` flag. **clearmake -C gnu** conforms to the Gnu make behavior.

---

## Unsupported Gnu Make Features

The following features are not currently supported:

- Automatic remaking of any makefiles that are declared as targets. You must rebuild them explicitly.
- Controlling sub-makes by manipulating the `MAKEFLAGS` variable.
- The declarations `.DELETE_ON_ERROR`, `.INTERMEDIATE`, `.SECONDARY`.
- Syntax and semantics for target-scoped variables introduced in 3.77 of Gnu Make.
- Automatic makefile regeneration and restart if the makefile and included makefile fragments are targets in the makefile itself.
- Automatic deletion of intermediate results of a chain of implicit rules.
- Special search method for library dependencies written in the form `-lname`. For each directory on the `VPATH/vpath` list, Gnu make searches in `DIR/lib`.
- When the `EV MAKEFILES` is defined, Gnu make considers its value as a list of names of additional makefiles to be read before the others, as though they were included implicitly.



## Using ClearCase to Build C++ Programs

# 7

This chapter provides guidelines and instructions for using the ClearCase build utilities, **omake** and **clearmake**, in C++ development environments such as Microsoft® Visual C++®. The way that C++ development environments manage their files can cause conflicts with the ClearCase build utilities. Possible symptoms of the conflict:

- **clearmake/omake** rebuilds an object it could have winked in.
- When **clearmake** or **omake** winks in an *incremental repository* (database) file, information can be lost if the winked-in repository was not built with the same components that exist in the development view.

The exact nature of the symptoms depends on the compiler you use. For most Windows NT C++ compilers, these problems do not arise. The Microsoft Visual C++ environment causes a number of conflicts, which ClearCase works around by including a special makefile fragment if you use the SCC integration with Visual C++. This chapter describes how this makefile fragment works and also presents alternate possibilities for working around the problems.

These C++ compilers apparently do not cause any conflict with ClearCase building:

- Borland C++
- Symantec C++
- Watcom C/C++

---

## 7.1 Using clearmake or omake Instead of Other make Programs

**clearmake** and **omake** ensure correctness of reuse decisions despite differing versions of files selected by a *config spec*, determine the complete dependency list accurately with build auditing, and allow identical *derived objects* (DOs) from other views to be winked in to the current view. However, using another **make** program may be desirable for performance or compatibility reasons. If you use other **make** programs, do so with caution.

A standard **make** program compares the date and time of the target with that of its dependencies. If any dependency is newer than the target, **make** rebuilds the target. Because of ClearCase config specs and the *winkin* feature of ClearCase, the set of files visible in a view at any given time is very dynamic. It is common for a target to require a rebuild because the view selects a dependency that is different, though not necessarily newer, than the one used in the previous build of the target. The ClearCase *build avoidance* mechanism provides a more precise method of determining whether targets are up to date during builds, by using the information stored in *configuration records* (CRs) to make correct decisions about reuse. CRs record the versions of all dependencies (whether listed in the makefile or not) of a target, rather than only the date and time of its last modification. If the version of a dependency from a CR doesn't match the version of the file selected by the view, **clearmake** or **omake** rebuilds the target.

The problem with using a **make** tool other than **clearmake** or **omake** is that the tool may make incorrect rebuild decisions if the view's config spec is changed and selects different file versions. However, if you are sure that the config spec will not change and that any labels used in it will not be moved to versions with earlier dates, then a standard **make** program will make correct reuse decisions. Using the **rmver** command to remove a version used in a build can also change the modification time and cause **make** to fail to rebuild when necessary. However, this is not a recommended practice; you do not obtain the benefits of CRs and it is not realistic to assume that no one will change the config spec or move any referenced labels improperly. Because it is somewhat risky to use common **make** programs, use them for debug builds, not for production.

---

## 7.2 Using Visual C++ with ClearCase

The ClearCase build utility **omake** (and, to a much lesser degree, **clearmake**) can be used to build in a Visual C++ development environment.



---

## omake

**omake** can read Visual C++ makefiles, but only if NMAKE emulation mode is specified with the **-EN** parameter. In addition, if you are working outside the ClearCase MVFS (that is, neither on the **M:** drive nor on a drive assigned to a ClearCase view), or if you disable configuration management (CM) features with the **-L** option, **omake** behaves like Visual C++ NMAKE, and no special options are needed. However, if you want to use **omake** within the MVFS (that is, in ClearCase VOBs) to produce ClearCase DOs, you will find it most convenient to use the SCC integration with Visual C++, which maximizes the cooperation between ClearCase and Visual C++. For information on using **omake** with Visual C++, see the online help for the **omake**/Visual C++ integration.

If you are not using the SCC integration or are using Visual C++ 2.x, **omake** does not have access to the internal environment of the Visual C++ development environment. Therefore, you must set the **INCLUDE**, **LIB**, and **PATH** environment variables before you run Visual C++ rather than rely on the directory lists set in the IDE options. Also, **omake** cannot access the Visual C++ build rules, so it must get build script information from either the **builtins.nm** file or the makefile.

If you are using Visual C++ 5.0 or 6.0, you must export your makefile before running **omake**. You can either click **Tools**→**Options**→**Build** and set the option **Export makefile when saving project file**, or export your makefile after making changes to the project settings. To export your makefile:

1. Check out the file *project-name.mak* (if it is an element).
2. Click **Project**→**Export Makefile**.
3. If you are prompted to select which configurations to export, make sure you select any configurations that will be built with **omake**.

Visual C++ creates *project-name.mak*.

---

## clearmake

You can use **clearmake** only if you are not using makefiles generated by Visual C++ — that is, if you write your own makefiles that call the Visual C++ compiler, linker, and so on.

---

## Incremental Repositories in Visual C++

Program Database files (PDBs) and Incremental Database files (IDBs) are built up with information from compilations of many `.c/.cpp` source files. This type of database file is referred to as an *incremental repository* in ClearCase. The consequence of using these incremental repositories is that object files cannot be winked in without making the PDB/IDB out of date. There is no way to wink in a portion of a file, a feature that would be required to wink in the object and the section of the PDB/IDB that holds the debug info for that specific object. For this reason, the SCC integration disables `winkin` for targets with a PDB or IDB sibling DO. Note that manual `winkin` with the **cleartool winkin** command can be used to wink these objects in; this method is described in the section *Using the winkin Command* on page 98.

### Alternative: Using C7 Compatible Debug Information

The C/C++ compiler generates debug information in two different ways:

- C7 compatible info (`/Z7` parameter from the command line), which is compatible with the V7 compiler. Debug information is stored in resultant object files.
- Create one or more `.PDB` files that store the debug information.

C7-style debug info is the ideal choice when using **clearmake** or **omake**. With C7 debug info, information is stored directly in the object file. Because there are no files that are shared by builds of multiple targets, `winkin` is automatic. If you use multiple views to build the same versions of files, this method is the most advantageous way of working. Automatic `winkin` means that **clearmake/omake** shops in the VOB for similar DOs and determines whether the previously built DO is the same as would be produced by executing the target's build script. If they would be the same, the target build previously is winked in (an operation that is in most cases faster than executing the build script), and the two views share a single disk image of the target file.

Base the decision on which debug information style to use on whether PDBs are necessary, whether other necessary features require PDBs (some types of precompiled headers and incremental compiles, for example), and whether an appropriate DO in your environment is likely to exist and be shareable.

Switching between PDBs and C7 debug information is simple. In the Visual C++ IDE:

1. Click **Project**➤**Settings**.
2. Select the debug target in the **Settings For** tree.
3. Click the `C/C++` tab.

4. In the **Category** list, click **General**.
5. In the **Debug Info** list, click either **Program Database** or **C7 Compatible**.

---

## Using vcmake.mak to Prevent Reuse Mismatches

The makefile fragment **vcmake.mak** defines files with a **.pdb** or **.idb** extension as incremental repositories. Specifying these siblings, which may contain incomplete information, prevents the ClearCase build tool from incorrectly winking in their associated primary target.

To use the information in **vcmake.mak**, find your particular environment in Table 2 and follow the instructions.

Table 2 Using vcmake.mak

Environment	Instructions
<b>omake</b> and the SCC integration with Visual C++	No action. <b>vcmake.mak</b> is included by <b>omake</b> .
<b>omake</b> without Visual C++	Do one of the following:
<b>omake</b> and Visual C++ without the SCC integration	<ul style="list-style-type: none"> <li>▶ On the <b>omake</b> command line, add <i>@ccase-home-dir\bin\vcmake.opts</i> or specify <i>-f ccase-home-dir\bin\vcmake.mak</i></li> <li>▶ Set the <b>OMAKEOPTS EV</b> to <i>ccase-home-dir\bin\vcmake.opts</i></li> </ul> <p><b>NOTE:</b> Substitute your ClearCase installation directory for <i>ccase-home-dir</i>.</p>
<b>clearmake</b>	Insert the following lines in your makefile: <pre>.INCREMENTAL_REPOSITORY_SIBLING : %.idb %.IDB %.pdb %.PDB .NO_WINK_IN : %.trg %.TRG</pre>

If you do not use the appropriate procedure, DOs built in one environment cannot be shared with other environments, and you see error message like this one:

```
Cannot reuse "..\..\bin.pcu\jdsample.obj" - mismatch between config record flag
and makefile directive for "\adept\src\pub\libjpeg\bin.pcu\vc50.idb"
```

---

## Browser Files

The browser generator, **bscmake**, has a performance enhancement that can create problems with configuration records. By default, when **bscmake** runs, it truncates all existing browser info files (SBRs, because they have a **.sbr** extension.) If you use C7 debug info to allow **winkin** to work automatically, running **bscmake** in the default mode causes **winkin** to fail. **clearmake/omake** never finds a DO that can be winked in: the SBR that was created when the object file was created is no longer available, because **bscmake** overwrote it. A **bscmake** option is available to cause it to run in nonincremental mode, where it reads all existing SBR files without modifying them. Using this parameter with C7 debug mode permits **winkin** to work correctly.

To run **bscmake** in nonincremental mode, you must specify the **/n** parameter. Add this parameter on all release builds in which the DOs are versioned. To add **/n** using the IDE:

1. Click **Project**►**Settings**.
2. Select the desired target in the **Settings For** tree.
3. Click the **Browse Info** tab.
4. In the **Project Options** edit box, add **/n**.

---

## Using the **winkin** Command

If you choose a method that disables automatic **winkin**, you may still gain the space and performance benefits of DOs and CRs by **winkin** in DOs manually. The **cleartool winkin** command can **winkin** in a specified DO or, with the **-recurse** parameter, **winkin** in a DO and its sub-DOs. If your team runs nightly builds, an entire project can be **winked in** (even if PDBs and IDBs were used.) Issue a **cleartool winkin -recurse do-pname** command in the development view. You can use view-extended naming to select the *do-pname*. The target and all targets used to build it are **winked in** to the development view.

Because the **winkin -recurse** command **winks in** a hierarchy of DOs without regard to the makefile or config spec selections in the current view, run **clearmake** or **omake** after completing the manual **winkin** to ensure that all DOs are up to date. If the development view selects the same versions of files that were referenced during the nightly build, this build does not require anything to be rebuilt. If development has continued since the nightly build on a subset of the files, only the necessary objects need to be recompiled or relinked.

See the **winkin** reference page for more information.

## Using ClearCase Build Tools with Java

# 8

The building behavior of Java™ tools causes various problems for **clearmake** and **omake**. This chapter presents these problems and some possible solutions.

---

### 8.1 ClearCase Build Problems with Java

Java source is kept in files with extension **.java**, where the file name must be constructed from the name of the class it defines. For example, a class **foo** referenced by other Java source files must be in a file named **foo.java**. Compiling **foo.java** with the Java compiler creates a file called **foo.class**. Subsequent compilations may read the **.class** files generated previously.

When the Java compiler encounters a reference to a class defined in another file, it rebuilds that class file if it is out of date or does not exist. This behavior puts extra information in the configuration record:

- Extra **.class** files as siblings of the target **.class** file
- Extra dependencies on **.java** sources from building the siblings

This information can cause unnecessary rebuilding, prevent winks, and create confusing **catcr** output. The major Java development toolkits exhibit this behavior.

---

## Java Toolkits

These are the major Java development toolkits:

- ▶ The standard Java toolkit is Sun's JDK, which includes the **javac** compiler and is available for many platforms.
- ▶ Microsoft provides its own extended version of the development kit, including the **javc.exe** compiler, which is upward compatible with **javac** and has the same behavior. The Microsoft® Visual J++® invokes **javc.exe** and also has the same behavior, but does not use makefile-based building.
- ▶ Like Visual J++, Symantec Cafe invokes its own compiler (also called **javac.exe**) underneath. The Symantec compiler is fully compatible with the Sun compiler, and you can set up options in Cafe to use the Sun compiler instead. Cafe uses an internal dependency tracking mechanism to control rebuilds, without an external makefile format.

The remainder of this chapter uses **javac** from Sun as the example, but the discussion also applies to Microsoft's **javc.exe** and Symantec's **javac.exe**.

---

## Scope of the Problems

The build problems relate to conflicts between the dependency analyses of **clearmake/omake** and **javac**. Because the Java compiler does some dependency analysis, some developers may not require **make** tools. Environments such as Visual J++® do not require that you use makefiles, nor do they generate and use makefiles themselves as Visual C++® does.

The need for **make** tools is reduced further because the Java language minimizes the need to recompile a dependent class file when the depended-on file changes. Java keeps interface and implementation in the same file, so changes to the implementation part of the file do not strictly require recompilation. This behavior contrasts with C/C++ applications, in which interface is separated from implementation by splitting the source into header (**.h**) and implementation (**.c**) files. Some developers may prefer to control when to rebuild Java sources. However, none of the current tool environments is based on such a language-sensitive recompilation; like **make**, **javac** uses time stamps to determine when to rebuild.

---

## 8.2 Benefits of Using make Tools with javac

Although **javac** does a good job taking care of dependency analysis, using **javac** by itself misses rebuilds that a **make** tool does not. There are additional benefits of using **clearmake** or **omake** beyond those of using a non-ClearCase **make** tool, especially given the building behavior of **javac**.

---

### Using javac Inside a Makefile

**make** detects modifications of indirect dependencies that **javac** does not. If **a.java** depends on **b.java** and **b.java** depends on **c.java**, when you change **c.java**, **javac a.java** does not rebuild **c.class**. Therefore, if you are using **javac** directly, you must recompile each file as you change it.

In addition, many Java applications have some components that are compiled natively or are written in another language. For at least those parts of their applications, developers need makefile-based building.

---

### Using javac with clearmake or omake Instead of make

**clearmake** and **omake** provide additional benefits to those gained by using **make** or running **javac** directly. In addition to recording a build configuration, **clearmake** and **omake** are better at rebuild determination than the Java tools, with or without **make**. For example, **clearmake** or **omake** detects the following rebuild cases, but **javac** does not:

- Selection of an older version of a **.java** file. Because the rebuild decision is based on an older/newer comparison, **javac** does not detect that a rebuild is necessary.

**NOTE:** Clock skew between machines can cause similar time stamp problems outside of ClearCase.

- Change of the **javac** command line. If the command-line options used to build a **.class** file have changed since the last build, **clearmake** or **omake** rebuilds the **.class** file. For example, if you add the **-g** switch to direct the compiler to rebuild with debugging information, you must invoke the compiler on all your **.java** files to ensure that they are rebuilt to contain the debugging information.

- Manual winkin of a **.class** file that is out of sync with, but newer than, the corresponding **.java** source selected by the view. Because the rebuild decision is based on an older/newer comparison, **javac** does not detect that a rebuild is necessary.

---

### 8.3 Unnecessary Rebuilds and Prevention of Winkin

**javac**'s build behavior causes **clearmake** and **omake** to perform extra rebuilds and prevent winkins:

- Because a **.class** file is sometimes built as a sibling of another **.class** file, the build script for the sibling differs from what it would be if the **.java** file were compiled directly. **clearmake** and **omake** rebuild unnecessarily in this case because the build scripts do not match. Mutually dependent **.java** files are an extreme case of this behavior, because the build of one can change the build script of the other.
- Similarly, because the set of dependencies does not remain consistent from one build to the next, **clearmake** or **omake** rebuilds because versions do not match.
- If a sibling derived object is overwritten, winkins are prevented.

---

### 8.4 Building Java Applications Successfully

The following alternatives allow you to successfully build Java applications with **clearmake** or **omake**:

- Write the makefile correctly
- Allow **clearmake** or **omake** to rebuild
- Configure **clearmake** or **omake** makefiles to behave like **make**

The following sections describe each option in detail.



---

## Writing Correct Makefiles

A correctly written makefile results in a correct set of configuration records, which gives you the full power of ClearCase configuration records and `winkin` without unnecessary rebuilding and without missing rebuilds. You can restructure a makefile to avoid `javac`'s automatic building behavior by enforcing that files on which other files depend are built before their dependents.

**NOTE:** `clearmake` and `omake` detect implicit dependencies but cannot determine build order dependencies. If you want files to build in a certain order, you must declare that order in the makefile by adding additional dependencies.

You must take extra care when handling mutually dependent files, because there is not necessarily a correct order for building them. One possibility is to always generate all mutually dependent files as one unit, that is, in one configuration record. You can write the build script for a set of mutually dependent files to delete all class files corresponding to those files before building any of them. This ensures that they are not overwritten individually and makes them available as a unit for `winkin`.

The advantage of writing your makefile correctly is that it does not cause extra compilations or rebuilds. No special makefile directives are required, the configuration records have no unusual properties, and `winkins` will work fully. The disadvantage is that the makefile must always be synchronized with the structure and dependencies of the application.

The following sections are makefile examples for applications with particular dependency characteristics.

### No Mutually Dependent Files

In this application, classes `x`, `y`, and `z` have a hierarchical dependency graph:

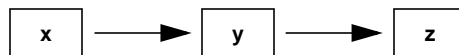

The makefile for such a dependency structure is very simple:

```
.SUFFIXES: .java .class

.java.class:
    javac $<
x.class: y.class
y.class: z.class
```

## Mutually Dependent Files

This application consists of classes **top**, **a**, **b**, **c**, and **d**, which have a more complex dependency structure:

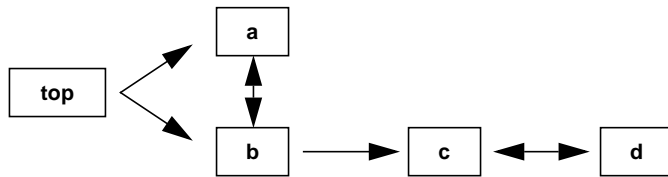

The makefile for this dependency structure is somewhat longer, but correct:

```
top.class: a.class b.class
    javac top.java

a.class: b.class

b.class:
    rm -f a.class b.class
    javac a.java b.java

b.class: c.class

c.class: d.class

d.class:
    rm -f c.class d.class
    javac c.java d.java
```

---

## Allowing Rebuilds

If you continue to invoke **clearmake** or **omake** until it determines that all files are up to date, the other ClearCase features work correctly. The configuration records record all class files as implicit dependencies rather than siblings, which allows **winkin** to work.

However, the number of rebuilds can become very large if the makefile is written incorrectly. It is possible to map out a correct set of dependencies as described in *Writing Correct Makefiles* on page 103; it is also possible to request (however inadvertently) that **clearmake** or **omake** build the files in exactly the reverse, and most inefficient, order.

In addition, **clearmake** and **omake**'s default behavior is to ignore modifications to siblings for the purposes of rebuilding. For **winkin** to work correctly, you must reenable that behavior by using a command-line option or special makefile directive.

Another drawback to this method is that the builds of mutually dependent source files do not fit well, because the files are never up to date. The makefile for these must be written carefully, as described in *Writing Correct Makefiles* on page 103.

---

## Configuring Makefiles to Behave Like **make**

By using special targets (called directives in **omake**), you can configure your **clearmake** or **omake** makefile so that **clearmake** or **omake** behaves as **make** does with regard to Java builds. The following targets eliminate the extra rebuilding described in *Allowing Rebuilds* on page 104:

```
.NOCMP_SCRIPT: %.class           (omake only)
.NO_CMP_SCRIPT: %.class         (clearmake only)
.DEPENDENCY_IGNORED_FOR_REUSE: %.class
```

**.NOCMP\_SCRIPT** and **.NO\_CMP\_SCRIPT** disable build script checking. However, relevant build-script changes are ignored also. In addition, **.NOCMP\_SCRIPT** and **.NO\_CMP\_SCRIPT** have no effect during **winkin**, so even when they are in use, **winkins** are prevented because of build script differences. Therefore, you must use manual **winkins** (see the **winkin** reference page) or forego them entirely.

**.DEPENDENCY\_IGNORED\_FOR\_REUSE** disables the version checking of implicit dependencies when **clearmake** or **omake** is looking for DOs to reuse. This can cause desired rebuilds to be missed, however. One benefit of using **clearmake** or **omake** is automatic dependency detection (for example, of **.h** files in a C build), so it is not desirable to give this up.

To improve the missed implicit dependency checking caused by **.DEPENDENCY\_IGNORED\_FOR\_REUSE**, you can add the missing dependencies as explicit dependencies in the makefile. However, this is a manual process, and you still lose build script checking and **winkin**. The remaining benefit of using **clearmake** or **omake** is configuration records (though the **catcr** output for them may be confusing).

---

## 8.5 Java Compilers and Case-Sensitivity Issues

The Microsoft Visual J++ 1.1 compiler (JVC) and the Sun JDK 1.1 compiler (and possibly others) require that the case of file names exactly match the case of the class names in the Java source. Running the MVFS in the Case Insensitive mode recommended on Windows converts view-private file names to lowercase. Instead, use the Case Insensitive, Case Preserving MVFS mode to get the correct case behavior for Java builds.

For more information on case-sensitivity and preservation, see *Administering ClearCase*.

# Index

## A

### archives

format in makefile 72

*attache-home-dir* directory xv

attributes, attaching to versions in CR 66

auditing, *See* build auditing

## B

### BOS files

about 70

clearmake read order 71

format of contents 83

recommended use 70

special targets for 77

when read by clearmake and omake 82

bscmake, impact on configuration records 98

### build auditing

16-bit tools 46

about 3

effect of background processes 44

including non-MVFS files 34

incremental updates and 45

multiple levels, problems 43

temporary files, location 46

without clearmake 7

### build avoidance

about 5

differences in clearmake and make 30

multiple build scripts for target 32

scheme for in make 34

### build environment

for clearmake and make 28

views used 1

build hosts, rules for makefile 80

build options specification, *See* BOS files

build scheme in ClearCase 2

### build scripts

DO-IDs in 53

format in makefile 69

multiple for single target 32

overriding cmd.exe 37

rm vs. del command in 38

temporary changes to 30

when omitted from CRs 14

### builds

*See also* express builds; hierarchical builds

DOs and performance 7

forced, problems with 38

javac behavior 102

labeling versions created in 42

reference time 13

starting 27

subsessions 42

verbosity levels, increasing 30

working while in progress 39

built-in rules in makefiles 73

## C

### C++ development environments

benefits of clearmake and omake 94

conflicts with clearmake and omake 93

### C7 debug information

about 96

mode for bscmake 98

case-sensitivity in makefiles 81

### catcr command

DO versions 60

sample listing 12

CCASE\_AUDIT\_TMPDIR environment variable 46

CCASE\_OPTS\_SPECS environment variable 71

CCASE\_SHELL\_REQUIRED environment variable 37

CCASE\_VERBOSITY environment variable 30

*ccase-home-dir* directory xv

### clearaudit

about 7

contents omitted from CR 14

coordinating multiple builds 43

multiple log files, workarounds 43

use with make programs 85

ClearCase Virtual Device Driver, build auditing 47

## clearmake

- 16-bit auditing tools 46
- build scenario 28
- compatibility modes 8, 85
- declaring dependencies in makefiles 34
- double-colon rules 39
- format of makefiles 69
- increasing verbosity level for builds 30
- internal macros 75
- Java behavior 99
- macro substitution 74
- pathname separator, how interpreted 82
- recursive invocation 32
- standard input as makefile 71
- starting builds 27
- temporary audit files 46
- Visual C++ makefiles 95

## clock skew

- about 40
- time rules and 41

## CMAKE\_PNAME\_SEP environment variable 83

## cmd.exe, overriding 37

## commands, control of echoing during build 72

## compatibility modes in clearmake

- about 85
- adjusting levels of 8
- Gnu make 86

## config specs, time rules in 40

## configuration lookup

- about 5
- common outcomes 6
- in hierarchical builds 6
- problems with dependencies 35
- VPATH macro 76

## conventions, typographical xv

## CRs (configuration records)

- about 4
- attaching labels and attributes to versions in 66
- bscmake problems 98
- comparing 65
- contents of 11
- contents of, effect of background processes 44
- displaying contents of 65
- displaying for DO versions 60
- double-colon rules and contents of 39
- effect on DOs when unavailable 65
- example 12
- hierarchy of 15
- hierarchy, and winkin 54
- hierarchy, processing by cleartool commands 17
- how created 44
- incremental updates and 45

- Java builds 99
- MVFS pathnames in 38
- recording makefile version 66
- storage of 18

## D

### .DEFAULT target 77

### dependencies

- build order, in makefiles 37
- case-sensitive 81
- declaring in makefiles 34
- detected, log of 6
- format in makefiles 69
- problems when searching directories for 35
- tracking 4
- tracking non-MVFS files 4

### .DEPENDENCY\_IGNORED\_FOR\_REUSE target 78

### describe command 52

### diffcr command 65

### DO versions

- about 23
- access to 59
- as release mechanism 61
- creating 58
- creating in builds 58
- displaying configuration records 60
- displaying description of 52

### documentation

- online help description xvi

### DO-IDs

- about 10
- displaying 52
- in build scripts 53
- in cleartool commands 53
- vs. OID 52

### DOs (derived objects)

- See also* nonshareable DOs; shareable DOs
- about 4, 9
- attaching labels and attributes to sources in CR 66
- build avoidance role 5
- converting to view-private files 57
- costs of creating 7
- criteria for reuse or winkin 5
- degenerate 64
- disk space usage, displaying 63
- displaying kind of 51
- effect of forced builds 38
- environmental obstacles to sharing 97
- incremental updating 45
- incremental updating, links in 46
- incremental updating, scenarios 46
- kinds of 18
- listing at specific pathnames 50

- listing views that reference 52
- overwriting 63
- removing 63
- scrubbing 64
- selecting versions for in view 66
- siblings of 4
- siblings of, types 19
- specifying in commands 53
- storage 19
- when created 29

**dospace command** 63

**double-colon rules, how clearmake interprets** 39

## E

### environment variables

- CCASE\_AUDIT\_TMPDIR 46
- CCASE\_OPTS\_SPECS 71
- CCASE\_SHELL\_REQUIRED 37
- CCASE\_VERBOSITY 30
- CMAKE\_PNAME\_SEP 83
- order of precedence in makefiles 73
- required for Visual C++ 95
- TMP 46

**error handling, control of in makefile** 72

### express builds

- about 7
- creating views for 56
- reconfiguring views for 56
- when to use 55
- winkin to 55

## F

**files deleted by build script, effects of** 38

**function names in makefiles** 72

## G

**Gnu make compatibility mode** 86

## H

### hierarchical builds

- configuration lookup in 6
- reference time of 13
- use of 43

## I

**.IGNORE target** 77

**include files in makefiles** 73

**Incremental Database files (IDBs)** 96

**incremental repositories** 96

**.INCREMENTAL\_REPOSITORY\_SIBLING target** 78

**.INCREMENTAL\_TARGET target** 78

## J

### Java compilers

- benefits of using make with 101
- build problems 99
- building in clearmake or omake 101
- case-sensitivity issues 106
- configuring makefiles 105
- makefiles for 103
- rebuilding targets 104

**Java toolkits** 100

## L

**labels, attaching to versions in CR** 66

**libraries, format in makefile** 72

**lsdo command** 52

- examples 50

**lsprivate command** 51

## M

### macros

- internal clearmake 75
- order of precedence in makefiles 73
- substitution by clearmake 74
- target-dependent definitions 70

**\$(MAKE) macro, defining for clearmake** 33

### make

- about 1
- build avoidance scheme 34
- use with Java 101

### make macros

- case-sensitivity 81
- format in makefile 70
- format of definition 74
- temporary overrides of 30

### makefiles

- about 69
- adjustment provided for Visual C++ 93
- built-in rules 73

- case-sensitivity issues 81
- controlling execution of 72
- declaring dependencies in 34
- double-colon rules and clearmake 39
- exporting 95
- format for clearmake 69
- format of libraries 72
- function names in 72
- include files in 73
- Java compilers 103
- javac, using with 101
- non-MVFS dependencies and 4
- order of precedence, macros and environment variables 73
- overriding build scripts in 30
- single, for clearmake and omake 82
- special targets 76
- standard input as, in clearmake 71
- temporary macro overrides 31
- UNIX, on Windows NT 80
- vcmake.mak 97
- version of in CR 66
- Windows build hosts 80

#### **MVFS files**

- about 4
- in configuration records 14
- pathnames in CRs 38

**MVFS setting, case-sensitive targets and dependencies 81**

## **N**

**NMAKE emulation mode 95**

**.NO\_CMP\_NON\_MF\_DEPS target 79**

**.NO\_CMP\_SCRIPT target 79**

**.NO\_CONFIG\_REC target 79**

**.NO\_DO\_FOR\_SIBLING target 79**

**.NO\_WINK\_IN target 80**

#### **non-MVFS files**

- as dependencies, tracking 4
- in configuration records 14

#### **nonshareable DOs**

- about 7, 19
- automatic conversion to shareable 62
- converting to shareable 62
- promotion and winkin 20
- storage 19
- types of siblings 19
- unique DO-IDs for 23

## **O**

#### **OIDs**

- how used 13

#### **omake**

- 16-bit auditing tools 46
- about 1
- build avoidance differences with make 30
- compatibility modes 8
- handling Visual C++ makefiles 95
- javac and 101
- starting builds 27
- strengths of 1
- temporary audit files 46
- temporary macro overrides in makefiles 31

**online help, accessing xvi**

**order of precedence in makefiles 73**

## **P**

#### **pathnames**

- accessing DOs 53
- and DO-IDs 10
- for DO versions 59
- form in build scripts 70
- of MVFS files, in CRs 38
- separator in, how handled 82
- view context and 28

**.PRECIOUS target 77**

**Program Database files (PDBs) 96**

**pseudotargets, and winkin 33**

## **R**

**rebuilding targets, See builds**

#### **reference count**

- about 24
- when zero 64

#### **reference time**

- about 13
- effect on source control 39
- for multiple builds 43

**release areas, structure and management 61**

**rm command, in build scripts 38**

**rmdo command 63**

## **S**

**SCC integration with Visual C++ 93**

**scrubbing DOs 64**

#### **shareable DOs**

- about 18
- components of 19
- converting to nonshareable 62
- in views reconfigured for express builds 56



- permissions to share 49
- promotion and winkin 20
- removing data containers 63
- storage 19
- types of siblings 19
- unique DO-IDs for 23
- shell**
  - auditing build in 7
  - overriding in build script 37
- .SIBLING\_IGNORED\_FOR\_REUSE target** 80
- siblings of DOs**
  - about 4
  - shareable and nonshareable 19
  - unintended 38
- .SIBLINGS\_AFFECT\_REUSE target** 80
- .SILENT target** 77
- subsessions in builds** 42
- subtargets in makefiles** 37

## T

- targets**
  - build rules and clearmake macros 75
  - case-sensitive 81
  - format in makefiles 69
  - multiple build scripts for 32
  - rebuilding by Java compilers 104
  - recursive invocation of clearmake 32
  - special 76
  - special, format in makefile 70
  - special, lists of 77
  - temporary files as sibling DOs 38
  - when winkin is disabled 96
- technical support** xvii
- time rules**
  - effect of clock skew 41
  - use in config specs 40
- time stamps, adding to C-language executables** 47
- TMP environment variable** 46
- typographical conventions** xv

## V

- vcmake.mak, environments for** 97
- vdmaudit, about** 47
- version strings, adding to C-language executables** 47
- versions**
  - checked-out, how clearmake handles 29
  - created in builds, labeling 42
  - of DOs 23

- view-extended pathnames for DOs** 53
- views**
  - configuring for express builds 56
  - configuring to select versions for DO 66
  - for builds 1
  - preventing winkin to and from 55
  - references to DOs, listing 52
  - time rules and 40
- Visual C++ development environment**
  - adjustments for ClearCase 94
  - incremental repositories in 96
  - makefile adjustments provided 93
- VPATH macro** 76

## W

- winkin**
  - about 6
  - criteria for 5
  - failure of with bscmake 98
  - from other platforms, preventing 57
  - incremental repositories 96
  - javac behavior 102
  - manual 54
  - permissions for 49
  - preventing 54
  - pseudotargets and 33
  - recursive, performance benefits for Visual C++ 98
  - recursive, uses of 54
  - reference count and 24

