



A “Rational” Approach to Enterprise Modernization

Hayden Lindsey
Vice President and Distinguished Engineer
IBM Rational Enterprise Tools & Compilers

Change is the new norm

Soon there will be over 2 billion people are on the web



By 2010, there will be 1 billion transistors per human

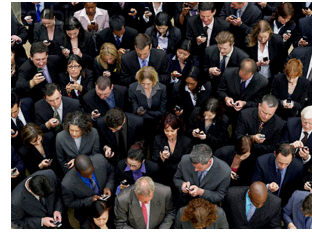

China sends more text message in a week than the U.S. does in 1 year

“8 of 10 CEOs see significant change ahead” - 2008 IBM CEO Survey



By 2010, there will be 30 billion RFID tags in circulation

By 2011 there will be trillions of interconnected objects – cars, planes, cameras, roadways, pipelines forming an “Internet of Things”

There are 1 billion camera phones in use today



Companies are struggling to keep up

“The gap between expected change and the ability to manage it has almost tripled since 2006.”

– 2008 IBM CEO study

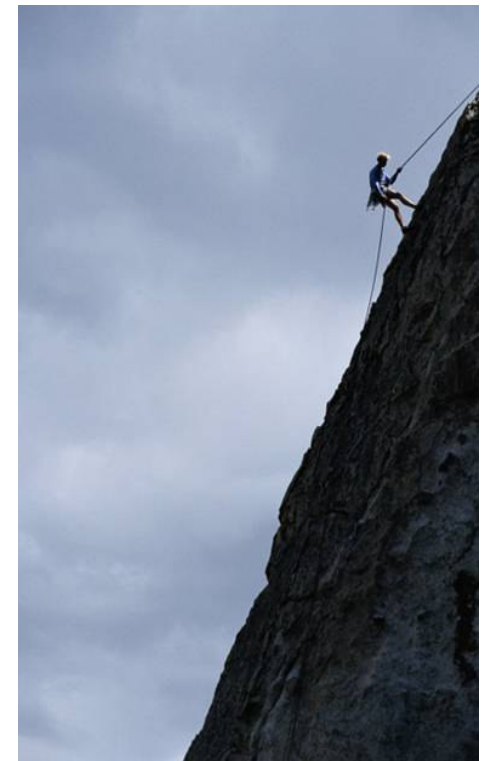

IT should be an enabler, not a burden



“IT investments made 10 to 20 years ago are ... constraining the speed with which these businesses can change and respond to industry threats.”

– Gartner’s Top Predictions for Industry Leaders, 2007 and Beyond

Companies want to

Understand how their IT systems support their business processes, and then enhance them in a predictable manner

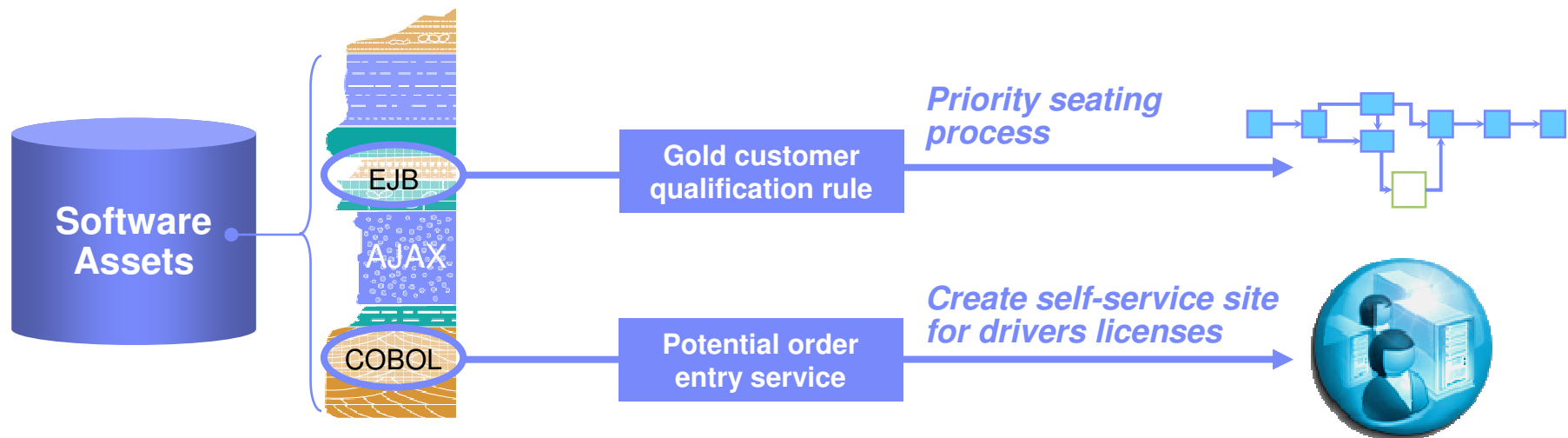

But...

They have no business intelligence inventory of their application assets, relying instead on manual processes & incomplete knowledge

Companies want to

Have an IT architecture that quickly adapts to support current business needs

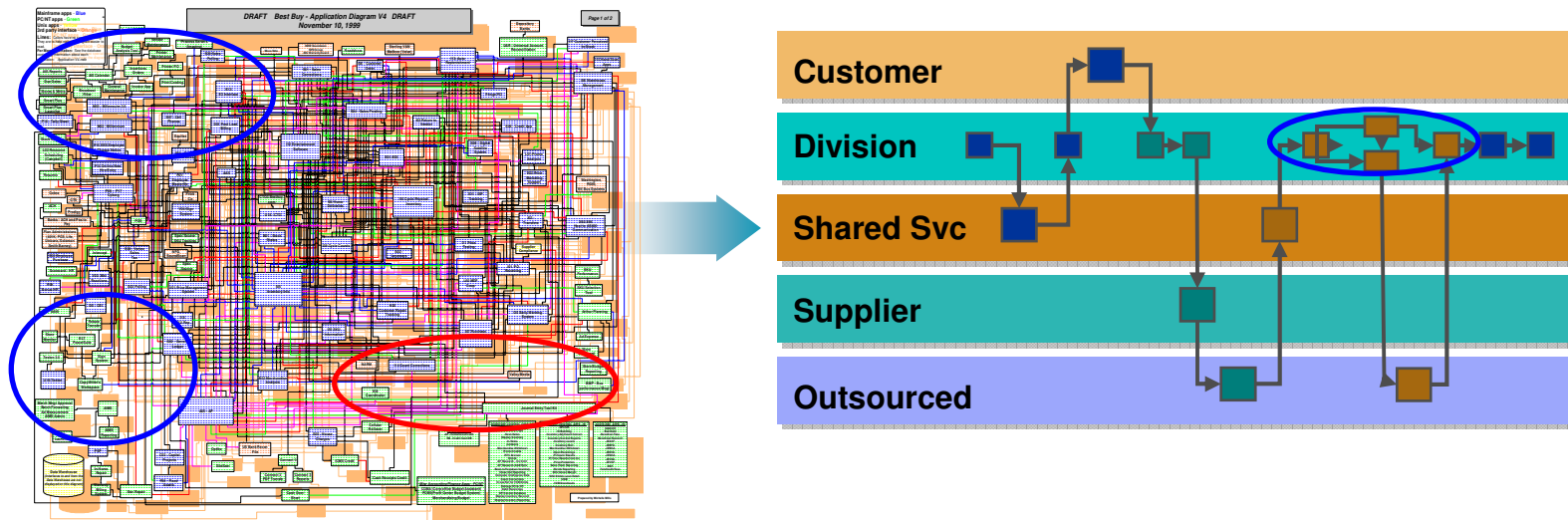

But...

They have application architectures that were incrementally built over the last 20-30 years that are no longer flexible or agile

Companies want to

Use existing developers to build modern cross-platform apps that leverage new technologies like Web 2.0

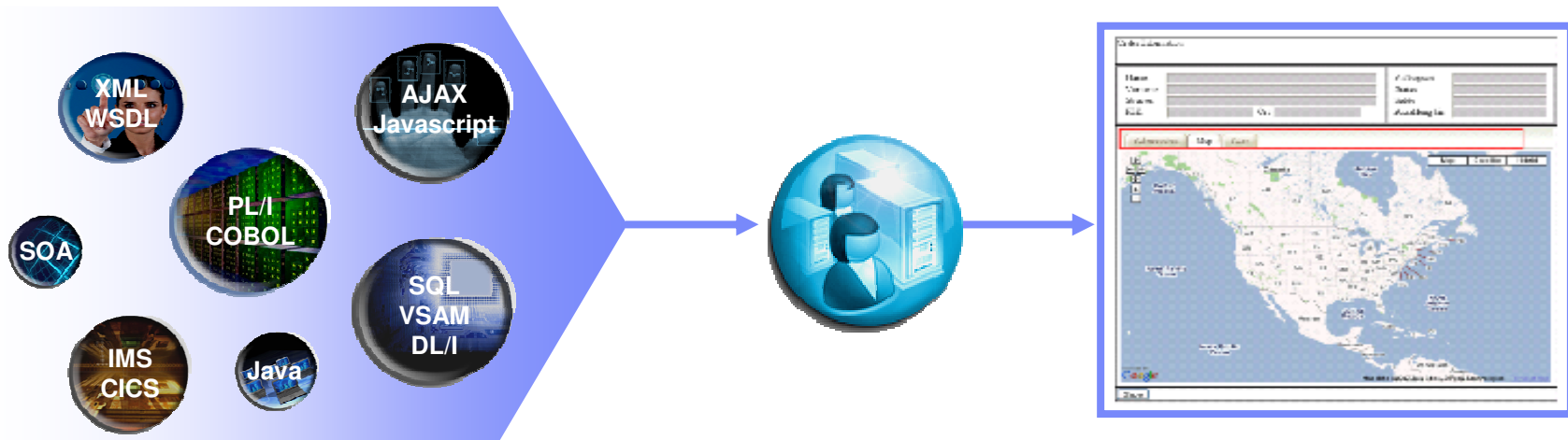

But...

They have developers that do not know all of these new technologies, and hiring all new people or doing massive retraining is unrealistic

Companies want to

Enable multi-platform and cross-geo collaboration and governance

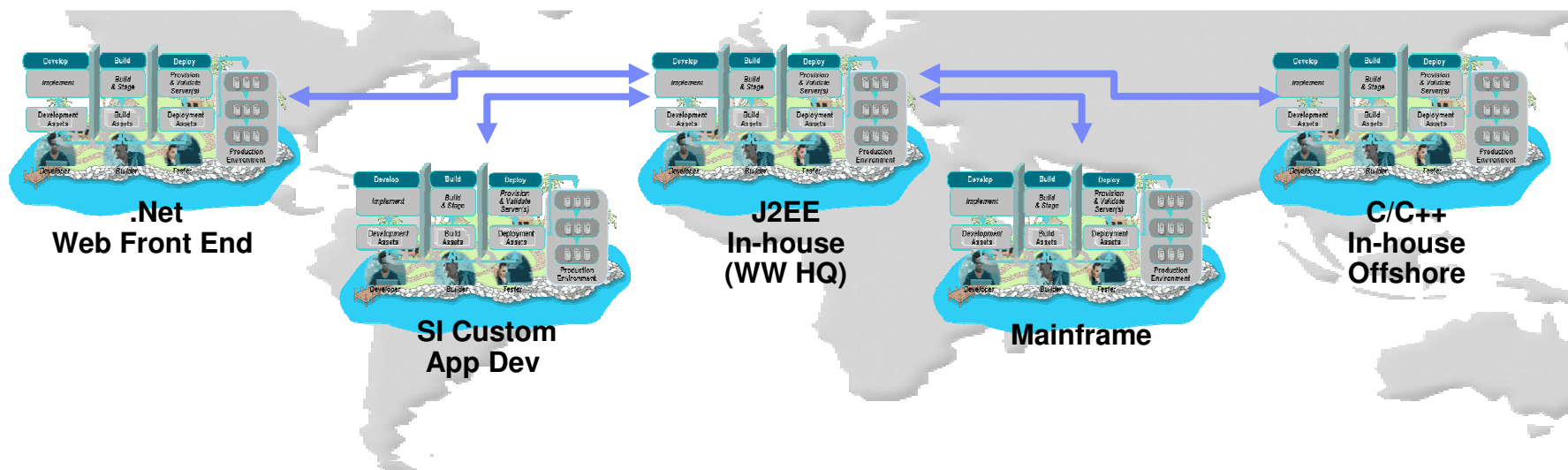

But...

They have different tools, processes and team infrastructure for each deployment platform, greatly complicating development of composite apps

Companies want to

Present a sophisticated, modern user interface to their customers and employees

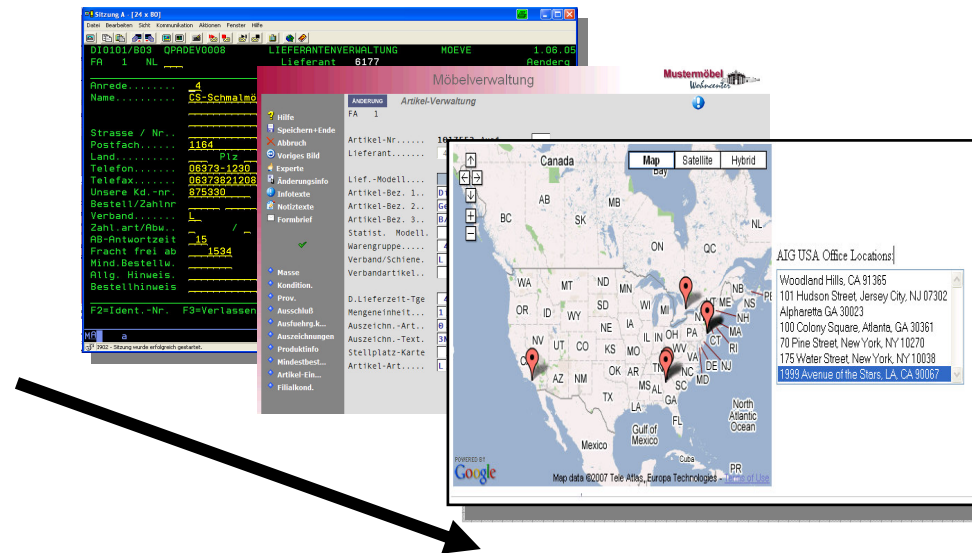

But...

They don't know how to upgrade their archaic green screen applications without rewriting their applications

Companies want to

Reduce costs and move to modern platforms, languages, and tools for all development

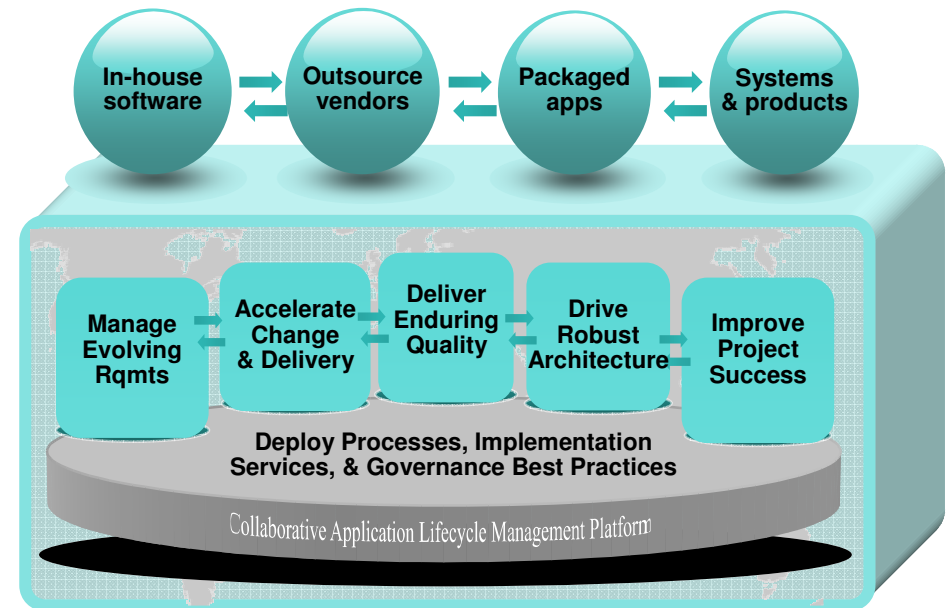
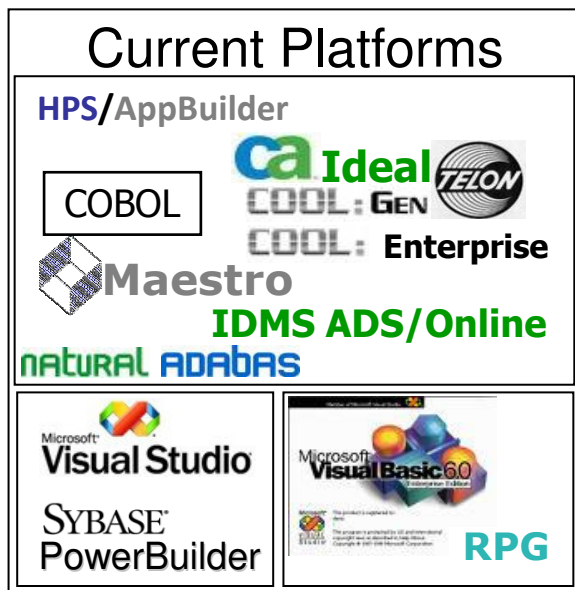

But...

They are stuck on unsupported, expensive, legacy development platforms

Managing Software Delivery - for System z ... and distributed

- ▶ Multi-platform development is the norm; System z is key in most enterprises
- ▶ However, many think of z development as “different and unique”, constraining efficiency & flexibility
- ▶ Rational’s Enterprise Modernization solutions provide:
 - a consolidated platform for multi-platform application development
 - a collaborative, integrated environment that supports innovation
 - the same power and flexibility for all types of applications, including z
- ▶ With totally modern tools for System z, you can choose your deployment platform for new applications based upon runtime requirements (e.g. QoS, proximity to data)
... and NOT based on out-dated perceptions of z development
- ▶ It is time to re-think how z development is done! Let’s look at some of our solutions



Enterprise Modernization – Improving IT Flexibility

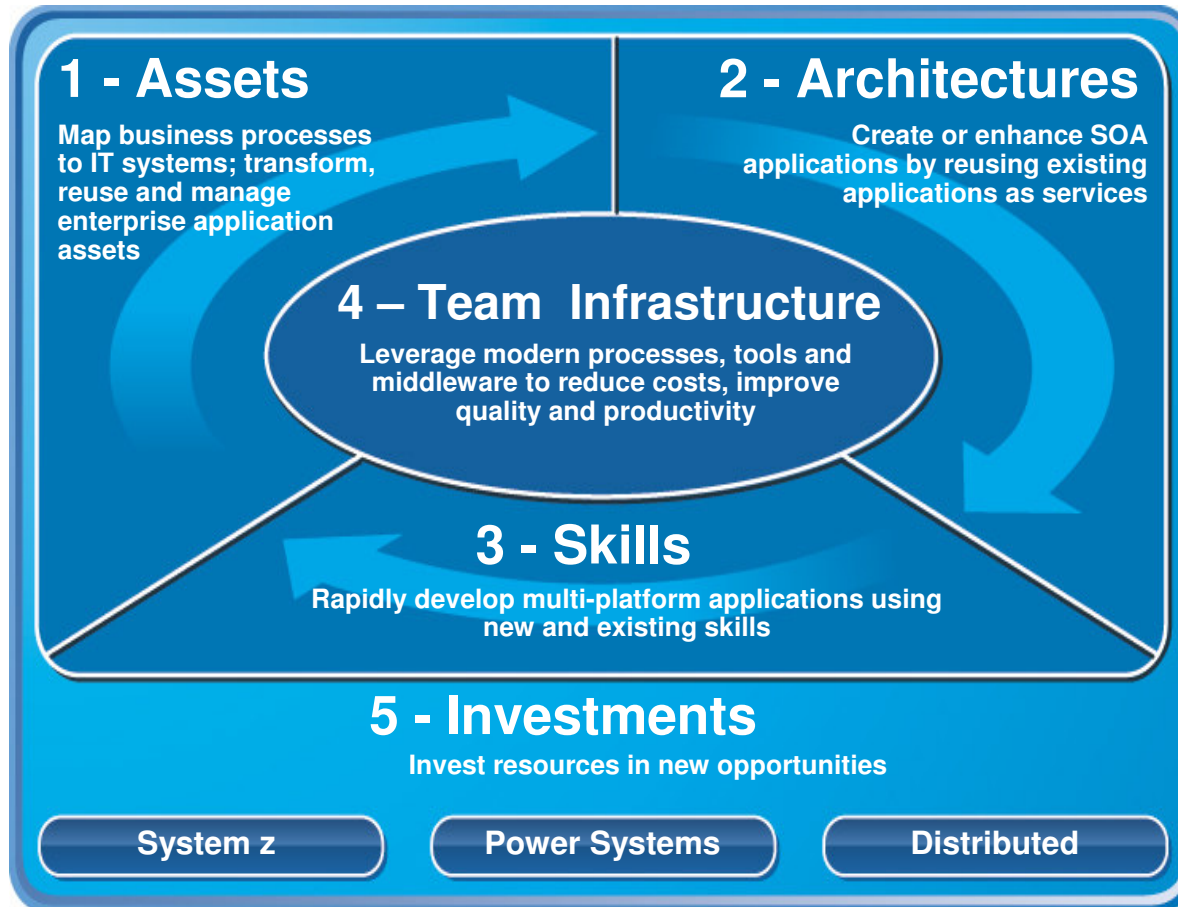

1. ***Leverage value in existing assets to support and enhance business processes***
2. ***Drive innovation with SOA and web technology advancements***
3. ***Leverage existing and new staff on multi-platform projects***
4. ***Improve quality and flexibility with a consolidated team infrastructure***
5. ***Reduce maintenance costs***

<http://www-306.ibm.com/software/info/developer/solutions/em/>

Business intelligence and technical analysis of application systems

- ✓ Map business processes to IT systems
- ✓ Harvest business rules & potential services within existing apps, including 3270 apps
- ✓ Refactor existing System z apps for reuse
- ✓ Perform impact analysis for all enterprise assets
- ✓ Manage asset development & deployment throughout the software lifecycle

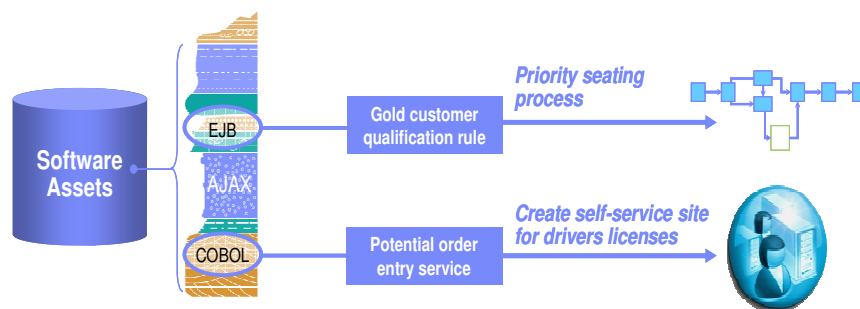

Enterprise portfolio management



- ✓ Identified obsolete code within automotive systems, and began “decommissioning”
- ✓ Performed impact analysis across massive systems with WSAA and RTW
- ✓ Communicated impacts to affected development teams

New!

Rational Asset Analyzer
WebSphere Studio Asset Analyzer
Rational Transformation Workbench
Rational Asset Manager
WebSphere Service Registry & Repository
Enterprise PL/I Compiler
X-Analysis (from Databorough)

New!

Flexible architectures to enable business agility

- ✓ Expose 3270 and 5250 applications as web services
- ✓ Quickly create web services from existing COBOL, RPG, PL/I, Java or EGL code
- ✓ Create new platform-independent services
- ✓ Leverage MDD - transform UML to EGL, COBOL, WSDL, etc

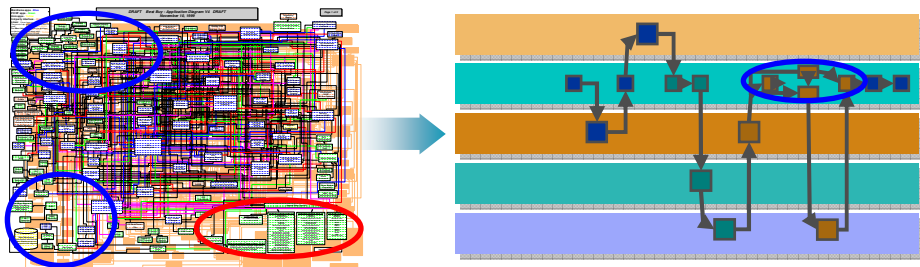

Modern architectures



- ✓ Used RDz to enable SOA and web initiatives to position the company for growth
- ✓ Aligned mainframe development plans with technological roadmap
- ✓ Implemented modern application modeling such as workflows and web enablement with RDz

- Host Access Transformation Services
- Rational Developer for System z with Java
- Rational Developer for System z with EGL
- Rational Developer for System i for SOA
- Rational Business Developer
- Rational Software Architect

Leverage new & existing skills to build new applications

- ✓ Use existing staff to build end-to-end, multi-platform apps, including sophisticated Web 2.0 and SOA solutions
- ✓ Use abstractions to hide technology, middleware, and platform complexities
- ✓ Attract new staff with EGL - “IBM’s newest business language”
- ✓ Harness a growing community of partners, ISVs, and customers with the [EGL Café](#)

Cross-platform application development

- ✓ Platform independence of EGL making movement of core banking application from IBM i to System z possible
- ✓ One application, supported on multiple platforms with EGL

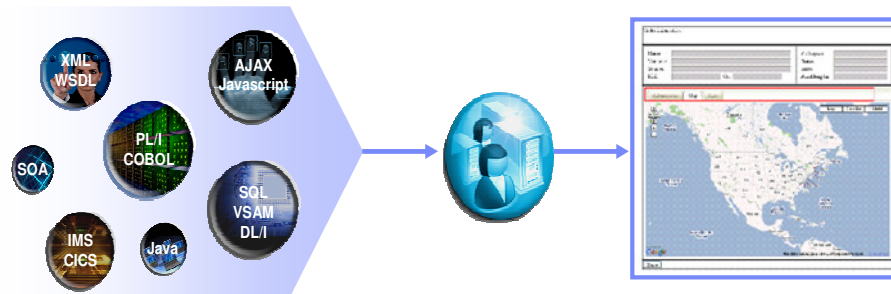

New! *Rational Business Developer*
Rational Developer for System z with EGL

EGL – Enabling Web 2.0 for the enterprise



- ✓ Users now expect modern, interactive UIs (e.g. Google™ Maps, ESPN™ Gamecast)
- ✓ Browsers are ubiquitous and increasingly powerful
- ✓ Web 2.0 for enterprise apps requires browsers for presentation logic, backend servers for business and data access logic
- ✓ Implementation involves many low-level technologies
- ✓ EGL Rich UI hides complexities, enabling business developers to build sophisticated Web 2.0 solutions



RSDC conference scheduler application for iPhone, built with EGL Rich UI



Google Maps is a familiar example of Web 2.0 technology at work

Achieve high productivity, attract new talent with modern IDEs

- ✓ Attract new talent with modern Eclipse-based IDEs
- ✓ Develop new workloads faster using built-in high productivity features
- ✓ Reduce System z MIPS by offloading edit & test to developer workstations

Rapid application development

- ✓ Consolidated its software development environment to better support the organization's core applications
- ✓ Leveraged RDz to integrate Java and PL/I development environments
- ✓ Permitted end-to-end debugging, regardless of platform

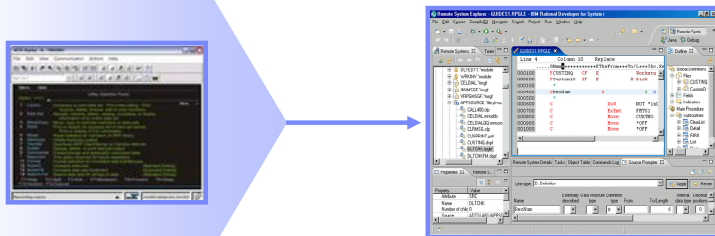

- Rational Developer for System z with Java*
- Rational Developer for System z with EGL*
- Rational Developer for System i*
- Rational Developer for System i for SOA Construction*
- Rational Business Developer*
- Rational Application Developer*

Common infrastructure & tooling to improve collaboration and governance

- ✓ Use the same end-to-end lifecycle tools, and processes for System z, i and distributed
- ✓ Exploit Jazz to increase collaboration and communication for all geographies, roles, programming languages and development platforms
- ✓ Improve governance with project management and reporting that spans all platforms
- ✓ Automate testing, including 3270 apps

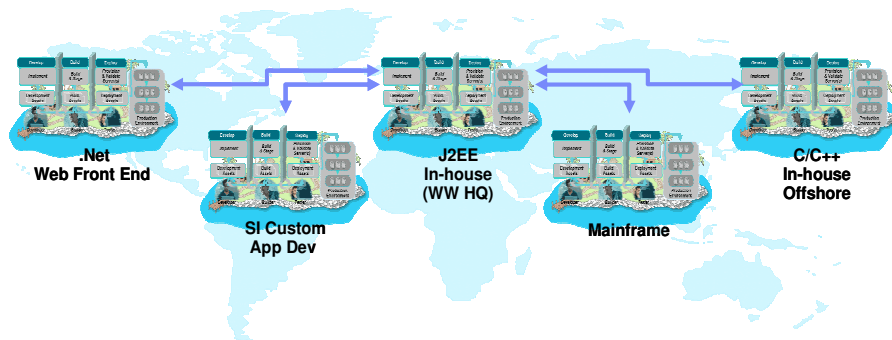

Unified change and release management

- ✓ TSO users can use ClearCase from a familiar environment
- ✓ Significantly less effort to synchronize z/OS and distributed teams
- ✓ Increased productivity/reduced errors per build and release cycle



Rational AppScan

Rational ClearCase

Rational ClearQuest

Rational BuildForge

Rational Functional Tester

Rational Method Composer

Rational Performance Tester

Rational RequisitePro

New!

Rational Team Concert

New!

Rational Team Concert for System z

New!

Rational Team Concert for System i

Software innovation through collaboration



eGA 4Q08

- ✓ **Real time, in-context team collaboration**
 - Make software development more automated, transparent and predictive
- ✓ **"Think and work in unison"**
 - Integrated source control, work item and build management
- ✓ **Assess real-time project health**
 - Capture data automatically and unobtrusively
- ✓ **Automate best practices**
 - Dynamic processes accelerate team workflow
 - Out-of-the-box or custom processes
- ✓ **Unify software teams**
 - Integrate a broad array of tools and clients
 - Extend the value of ClearQuest and ClearCase
- ✓ **Exploit Quality of Service of z/OS**
 - Hosted on z/OS with DB2 & WAS
- ✓ **z/OS and IBM i development support (coming)**
 - RPG support, COBOL, PL/I & EGL support, native builds, RDz, RBD, RDi integration, existing SCM integration

Open and extensible on

- ✓ Collaborate in context
- ✓ Right-size governance
- ✓ Day one productivity

IBM Rational Team Concert for System z/i

transparent *integrated presence*
 wikis OPEN real-time reporting
 chat automated hand-offs Web 2.0
custom dashboards automated data gathering
EXTENSIBILITY Eclipse plug-ins services
 architecture **FREEDOM TO CREATE**

JAZZ TEAM SERVER

Create impressive UIs quickly

- ✓ Quickly and easily extend your 3270 and 5250 applications to the web
- ✓ Leverage rich UI and Web 2.0 technologies with existing and new developers

User interface modernization



- ✓ Decreased development cycle time from 11 to 6 months with HATS
- ✓ Sped creation of new customer services
- ✓ Improved operational efficiency

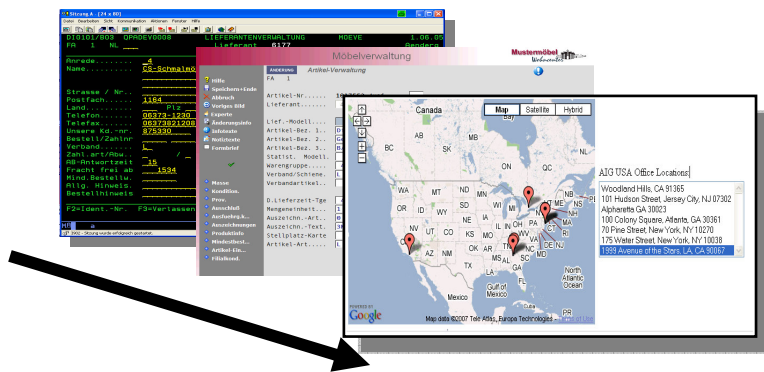

*Host Access Transformation Services
Rational Business Developer 7.5 (4Q08)
Rational Developer for System z with EGL
On AlphaWorks today!*

Modernize your development investments

- ✓ Migrate from out-of-date and expensive legacy development platforms onto the IBM Rational Software Delivery Platform (SDP)
- ✓ Transform Natural/ADABAS apps to EGL/DB2 to move to modern language and tools platform, save money
- ✓ Transform RPG apps to EGL for customers and ISVs requiring multi-platform solutions

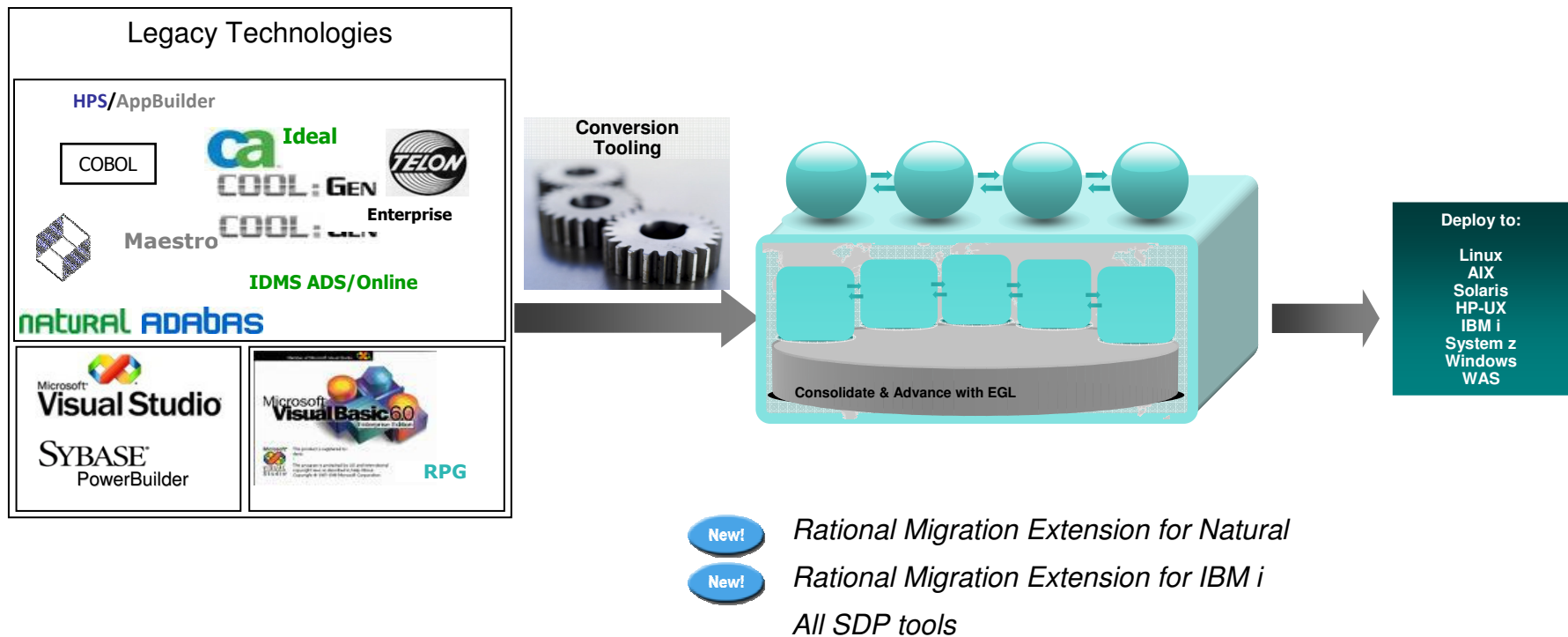

What can I do now?

Jump-start your
modernization
projects!



Learn new stuff

- **Modern Application Architecture for COBOL Developers** - *design and integrate composite applications across CICS and WebSphere*
- **EGL Distance Learning** - *10 days of FREE instructor-led virtual class*
- **Web 2 Architectures for IBM Mainframe Developers** – *extend the value of mainframe applications in modern Web 2.0 architectures*
- **System z Solution Videos & Demos** - *Translated solution videos and demo to help you raise awareness of Enterprise Modernization offerings*



Get quick ROI today

- **Rational Asset Analyzer** – *find out what assets can be reused today*
- **Host Access Transformation Services** – *quickly turn your green screens into web UIs*
- **Rational AppScan** – *make sure your web sites are hacker-proof*



Take small steps

System z & IBM i Starter packs - *Software bundles to simplify getting started on your modernization journey*

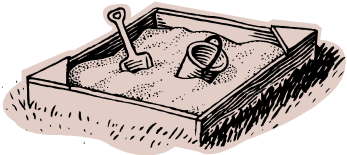

Try it out

System z & IBM i Sandboxes - *Fully hosted online System z and IBM i environments to experiment, try and buy*

Learn more at: www.ibm.com/rational/modernization

The Rational Software Delivery Platform

Accelerating software innovation for the *entire* enterprise

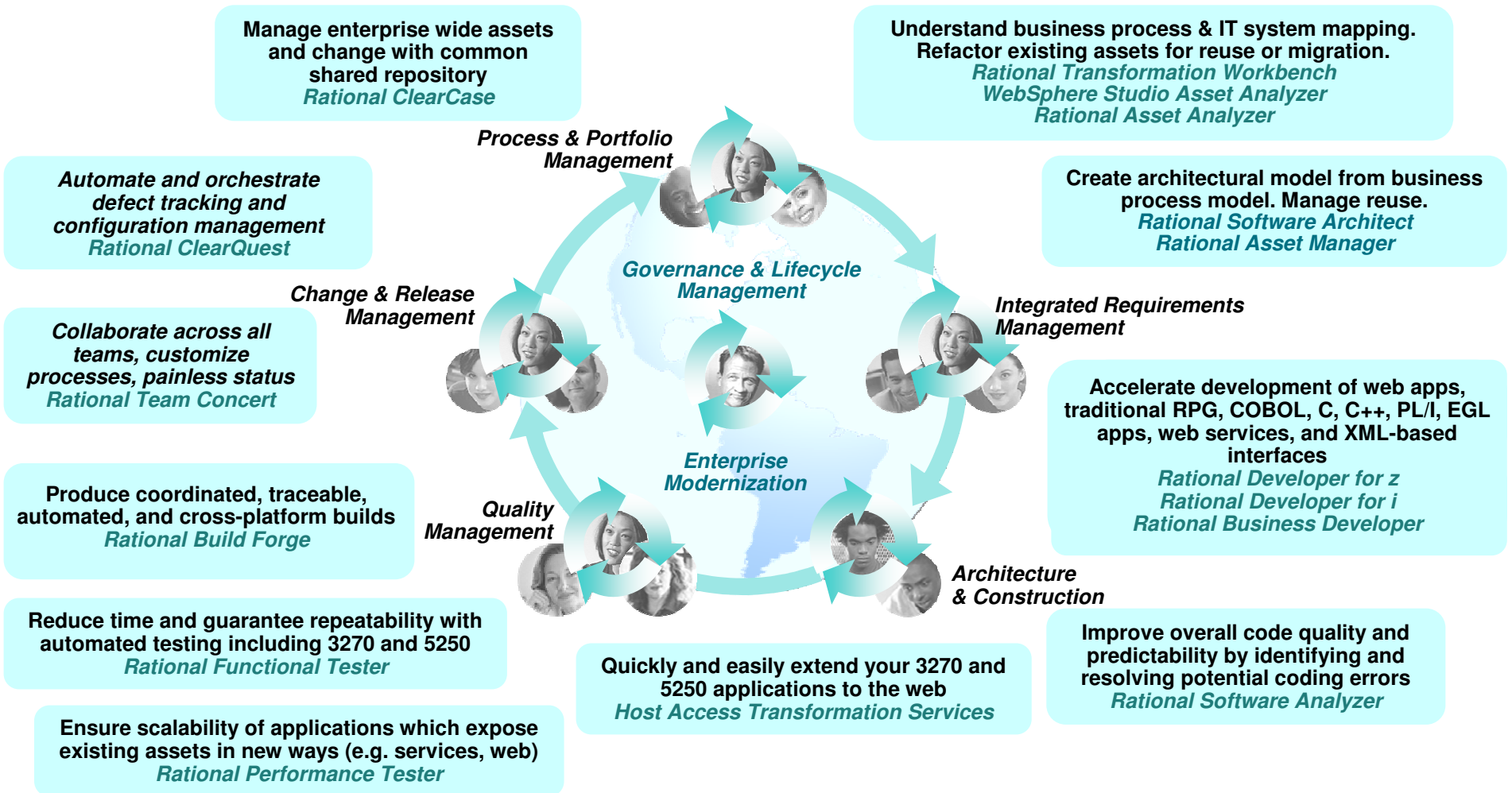



Perform business intelligence & technical analysis of application systems

- New!** ✓ Rational Asset Analyzer 5.5 - 7/2008
- ✓ Rational Asset Manager 7.1.0.1, with zLinux support
- ✓ Rational Host Access Transformation Services 7.5
- ✓ Rational Host Integration Solution 7.5
- ✓ Rational Transformation Workbench 3.1
- ✓ WebSphere Service Registry & Repository 6.2
- ✓ WebSphere Studio Asset Analyzer 5.1

Leverage new and existing skills

- ✓ Rational Business Developer 7.5, 7.5.1

Achieve high productivity, attract new talent:

- New!** ✓ Rational Developer for System z 7.5
 - RDz for SOA Construction with EGL
 - RDz for SOA Construction with Java
- ✓ Rational Business Developer 7.5, 7.5.1
- ✓ Rational Application Developer 7.5

Products in blue will ship in 4Q08

- New!** Identifies a new Rational product or offering introduced in 2008

Enable common infrastructure, collaboration and governance:

- ✓ Rational AppScan Build Edition 7.8 **New!**
- ✓ Rational AppScan Developer Edition 7.8 **New!**
- ✓ Rational AppScan Enterprise Edition 5.5
- ✓ Rational AppScan Standard 7.8 **New!**
- ✓ Rational AppScan Tester Edition 5.5
- ✓ Rational BuildForge 7.1, with zLinux support
- ✓ Rational ClearCase 7.1, with z/OS Extensions
- ✓ Rational ClearQuest 7.1
- ✓ Rational Functional Tester 7.1, with 3270 extensions
- ✓ Rational Method Composer 7.5
- ✓ Rational Performance Tester 7.1
- ✓ Rational Policy Tester 5.5
- ✓ Rational Quality Manager 1.0 **New!**
- ✓ Rational RequisitePro 7.1
- ✓ Rational Requirements Composer 1.0 **New!**
- ✓ Rational Service Tester for SOA Quality 7.1 – formerly Rational Tester for SOA Quality
- ✓ Rational Software Analyzer 7.0 – 4/2008
- ✓ Rational Software Architect 7.5
- ✓ Rational Team Concert 1.0 – 6/2008 **New!**
- ✓ Rational Team Concert for System z 1.0 **New!**
- ✓ Rational Test Lab Manager 7.1 **New!**

Learn more...

External Web sites

- [EM Solution Page on ibm.com](#)
- [EM Sandbox](#)
- [EGL Cafe](#)

Demos

- [Video: Accelerating software innovation on System z](#)
- [Enterprise Modernization Product Demos](#)

Whitepapers/Brochures

- [Brochure: Enterprise modernization solution overview](#)
- [Solution Sheet: IBM Enterprise Modernization Solutions for System z](#)
- [Developer Productivity Study – EGL vs. .NET](#)
- [Whitepaper: Unleash the power of mainframe assets into SOA](#)

Customer Facing Webcasts/Podcasts

- [Webcast by Scott Hebner: Accelerating software innovation on System z](#)
- [Podcast by Hayden Lindsey: Roadmap to Enterprise Modernization](#)



ibm.com/rational/modernization



Learn more at:

- [IBM Rational software](#)
- [IBM Rational Software Delivery Platform](#)
- [Process and portfolio management](#)
- [Change and release management](#)
- [Quality management](#)
- [Architecture management](#)
- [Rational trial downloads](#)
- [Leading Innovation Web site](#)
- [developerWorks Rational](#)
- [IBM Rational TV](#)
- [IBM Business Partners](#)
- [IBM Rational Case Studies](#)

© Copyright IBM Corporation 2008. All rights reserved. The information contained in these materials is provided for informational purposes only, and is provided AS IS without warranty of any kind, express or implied. IBM shall not be responsible for any damages arising out of the use of, or otherwise related to, these materials. Nothing contained in these materials is intended to, nor shall have the effect of, creating any warranties or representations from IBM or its suppliers or licensors, or altering the terms and conditions of the applicable license agreement governing the use of IBM software. References in these materials to IBM products, programs, or services do not imply that they will be available in all countries in which IBM operates. Product release dates and/or capabilities referenced in these materials may change at any time at IBM's sole discretion based on market opportunities or other factors, and are not intended to be a commitment to future product or feature availability in any way. IBM, the IBM logo, Rational, the Rational logo, and other IBM products and services are trademarks of the International Business Machines Corporation, in the United States, other countries or both. Other company, product, or service names may be trademarks or service marks of others.

Questions