



ND8401 Network Video Recorder User's Manual

VAST inside • HD Local Display •
Full Integration with VIVOTEK Cameras



Rev. 1.2

Table of Contents

Revision History	7
Chapter One Hardware Installation and Initial Configuration	9
Introducing ND8401 Network Video Recorder	9
Special Features	9
Physical Description	10
Hardware Installation.....	11
Network Deployment.....	14
Initial Configuration.....	15
Ready to Use.....	18
NVR Desktop Elements.....	21
Control Center.....	21
Menu Bar.....	22
Alarm Sound	22
Chapter Two NVR LiveClient Configuration	23
VAST LiveClient Functionality	24
VAST Server.....	25
Activating the VAST Server	25
How to Stop/Reboot the Server.....	25
LiveClient Configuration	26
Opening the LiveClient Interface and Logging in	26
LiveClient User Interface	27
Menu Bar.....	27
Status Panel.....	27
Quick Access Bar	28
Live Video Monitoring Window	28
Hierarchical Management Tree	29
Camera Control Panel.....	30
Pan/Tilt/Zoom (PTZ) Control Panel.....	30
Two Way Audio Control Panel.....	31
Event Window	32
Instant Playback (on Remote LiveClient).....	33
Instant Replay (on Remote LiveClient)	33
Audio Control	35
How to Manage Devices (Cameras)	36
Insert Cameras.....	36
Enable SVC	40
Update Devices.....	43
Delete Devices from the Station.....	44
Batch Insert Cameras	45
Camera Configuration	49
View Live Videos	52

Dual / Multiple Streams	52
Fisheye Display Modes	52
Refresh.....	57
Streaming Server	57
Get Public IP	57
Camera Settings	58
Remove Live Video from the Video Monitoring Window	58
How to Change the VAST LiveClient Layout.....	59
Changing the Layout of the Live Video Monitoring Window	59
Switch Video Channels	59
Configure Layout Mode.....	59
Rotating Video Pages	60
Edit Layout	60
Maximize the Live Video Monitoring Window.....	62
How to Manage Stations	64
Relay Settings	64
How to Manage User Accounts	65
The Default User Roles and Permissions of User Accounts	65
Manage a User Account.....	67
Add a New User Account	67
Permission of the User Account	68
Delete the User Account	69
How to Set up Association Management.....	70
Association Management.....	70
How to Set up Event Management.....	72
Event Management	73
How to Configure the Station General Settings.....	80
Server Settings.....	80
Log Settings	80
Reboot Settings.....	81
How to Configure Station Network Settings	82
Port Settings.....	82
UPnP Settings.....	82
Proxy Settings	82
Web Access Settings.....	82
How to Edit Recording Storage	83
Recording Storage Settings	83
Default Storage Group Settings	84
Add New Storage Group(s).....	87
How to Edit Recording Schedules.....	88
Edit Schedule List	89
Add Schedules	89
Rename Schedules.....	89
Delete Schedules	89
Load/Save Schedule Templates.....	90

Edit Camera List.....	91
Edit Time Frame List	92
Add New Time Frames.....	93
Recording Settings.....	94
The Concept of Repeat Frequency	95
Repeat Frequency: Daily Setting	96
Repeat Frequency: Weekly Setting (Day-based).....	99
Repeat Frequency: Monthly Setting (Day-based).....	102
Repeat Frequency: Yearly Setting (Day-based).....	104
How to Manually Begin /Stop Recording.....	106
How to Edit Scheduled Backup Settings	107
Select Backup Source	107
Setup Backup Schedule	108
Select Backup Target	108
Other Options	108
How to Configure Station Server Settings.....	109
DDNS Settings	109
Network Storage Server Settings.....	110
SMTP Settings	111
How to Use the Talk Panel	112
Add a Camera to the Talk Panel.....	112
Remove a Camera from the Talk Panel	114
How to Configure E-map Settings	115
Upload an E-map	115
E-map Settings Page (View Mode)	116
Quick Access Bar	117
Status Panel.....	117
E-map Settings Page (Edit Mode).....	118
Device Management	119
Live View Dialog Settings.....	120
Open Live View Dialog	120
Send to Single View	120
E-map Link	121
How to Configure Client Settings	124
Snapshot Settings	124
Taking a Snapshot.....	125
Recording Settings	126
Type 1: Record to EXE	126
Type 2: Record to 3GP.....	126
Type 3: Record to AVI	127
Built-in Media Player--EXE.....	130
View Settings.....	132
Display Location.....	132
Date and Time Format	133
Video Display Mode	133
Font Settings.....	133

General Settings	134
System Settings	134
Event Settings	135
Rotation Settings	135
Display Settings	136
Joystick Settings	138
Enable Joystick	138
Proxy Settings	142
How to Use PiP (Picture-in-Picture)	143
Enable PiP	143
Global View	143
ROI (Region of Interest)	144
Digital Zoom In	144
Snapshot Zoomed In Image	144
PiP Settings	144
How to Configure Video Enhancement	145
Basic Image Adjustment	145
Defog	147
Apply a Preset Defog Profile	147
Create a New Defog Profile	148
How to Search for a Device on the Hierarchical Device Tree	150
How to Lock LiveClient for Security Concerns	151
How to Log out from the VAST Server	151
How to Exit VAST LiveClient	151
Launch Playback	152
Second View	152
Chapter Three NVR Playback Configuration	153
Activating VAST Playback and Logging in to a Server	153
VAST Playback User Interface	155
Menu Bar	155
Status Panel	155
Quick Access Bar	156
Recorded Video Playback Window	156
Query Panel-- Browsing Page	157
Query Panel--Time Search Page	158
Audio Control	159
How to Change the Playback Layout	160
Changing the Layout of the Recorded Video Playback Window	160
Switch Video Channels	160
Layout Mode	160
Maximize the Recorded Video Playback Window	161
How to Backup Recorded Video	163
How to Search for a Video Clip Taken at a Specific Time	169
How to Add a Bookmark	170
How to Search for Events	171
Select Event Category	172

Event Category- All Events	172
Event Category- All Motion Events.....	172
Event Category- All IVA events	173
Event Category- All DI Events.....	173
Event Category- Named DI Events.....	174
Start Event Search	175
Backup the Event Videos	176
How to Search for a Bookmark	177
How to Search Logs	178
Select Log Category/Log Type/Log Level	179
Search All Local Logs.....	180
Search Login History.....	180
Search Login Activities	181
How to Configure Client Settings	183
Snapshot Settings	183
Export Settings	183
View Settings.....	185
Proxy Settings	185
General Settings	185
System Settings	185
Display Settings	185
How to Configure Video Enhancement	185
How to Search for a Device on the Hierarchical Management Tree	185
How to Lock VAST Playback for Security Concerns	186
How to Log out from the VAST Server	186
How to Exit VAST Playback.....	186
Chapter Four Auxiliary Utilities	187
Service	188
Import and Export Utility	188
Installation Wizard 2	190
Shepherd.....	191
Upgrade	193
File Manager	194
Keyboard	194
Disk Status	195
Network Status	196
System Status	197
Appendix A Rebuilding a RAID Volume.....	198
Appendix B ONVIF Support.....	200

Revision History

Rev. 1.0: Initial release.

Rev. 1.1a: Corrected description of the functions on e-map's right-click menu.

Rev. 1.1b:

- Added short description for the Auto stream size feature.
- Added the Bookmark function.
- Added description for the Instant Replay function (on a remote client).

Rev. 1.2:

- Added Appendix B ONVIF Support.
- Added the description for CPU and memory usage indicators.

Read Before Use

The use of surveillance devices may be prohibited by law in your country. The Network Camera is not only a high-performance web-ready camera but can also be part of a flexible surveillance system. It is the user's responsibility to ensure that the operation of such devices is legal before installing this unit for its intended use.

It is important to first verify that all contents received are complete according to the Package Contents listed below. Take note of the warnings in the Quick Installation Guide before the Network Camera is installed; then carefully read and follow the instructions in the Installation chapter to avoid damage due to faulty assembly and installation. This also ensures the product is used properly as intended.

The Network Camera is a network device and its use should be straightforward for those who have basic networking knowledge. It is designed for various applications including video sharing, general security/surveillance, etc. The Configuration chapter suggests ways to best utilize the Network Camera and ensure proper operations. For creative and professional developers, the URL Commands of the Network Camera section serves as a helpful reference to customizing existing homepages or integrating with the current web server.

Package Contents

- ND8401
- Power cord
- Software CD
- Warranty Card
- Quick Installation Guide
- Screws and bezel keys

**NOTE:**

The operating system and VAST server are installed on an IDE flash mounted on the main board. There is no need to install software.

Symbols and Statements in this Document



INFORMATION: provides important messages or advices that might help prevent inconvenient or problem situations.



NOTE: Notices provide guidance or advices that are related to the functional integrity of the machine.



Tips: Tips are useful information that helps enhance or facilitate an installation, function, or process.



WARNING! or **IMPORTANT:** These statements indicate situations that can be dangerous or hazardous to the machine or you.



Electrical Hazard: This statement appears when high voltage electrical hazards might occur to an operator.

Chapter One Hardware Installation and Initial Configuration

Introducing ND8401 Network Video Recorder

VIVOTEK ND8401 is a 16-CH Network Video Recorder designed for sophisticated recording applications. The unit is equipped with an Intel Dual-core Atom Processor with maximum recording throughput at a robust 96 Mbps. RAID 0/1/5/10 is supported with four HDDs, with an external eSATA port for additional expansion. Like VIVOTEK NVR ND8301, a local display output port is available with full HD resolution (1920x1080), eliminating the need for a separate PC to view video from the unit. Setup of parameters such as IP address, HDD to logical volumes, and basic camera configuration can easily be performed with the setup wizard, making the ND8401 the easiest NVR to use yet. When connecting ND8401 to more than one of the same model of VIVOTEK camera, the “Shepherd” program can be used to duplicate the configuration to multiple cameras.

VIVOTEK’s professional software VAST is installed in ND8401 with performance tuning, allowing for simple and effective management of a surveillance system using the LiveClient and Playback programs. As VIVOTEK’s camera features are fully integrated into VAST, cutting-edge technologies such as Activity Adaptive Recording can be utilized to conserve bandwidth and optimize recording. A CMS server running VAST software can also directly control the ND8401, and compatibility with the iViewer application allows for remote access to the ND8401 on handheld devices. By integrating all of the components together using VIVOTEK’s ND8401, network cameras, VAST and iViewer software, users can realize a fully-featured and robust next-generation surveillance system.

Special Features

- Intelligent PiP Function -- Digital Zoom In Mode
- Convenient Remote Access via Client/Server Architecture
- Effective & Reliable Event Trigger Management
- Real-time 16-channel Live Viewing and single channel (VGA) Playback
- Multiple Simultaneous Streams for Different Media Platforms
- Activity Adaptive Streaming for Dramatically Reducing Bandwidth and Storage Space
- Extremely Versatile Settings for Recording Storage and Recording Schedule Management
- Role-based User Management to Enhance Security Operations
- Efficient Data Backup, Search, and Export
- Intelligent PTZ/ E-PTZ Remote Camera Control
- Overall Device Management through Intuitive E-map Feature
- Supports Two Way Audio
- Supports Auto Stream Size
- Supports SVC adaptive frame rate setting

* The number of linked devices will depend on the license purchased along with the system.

* The ability to extend devices is also subject to the network bandwidth and computer performance.

Physical Description

● Front View

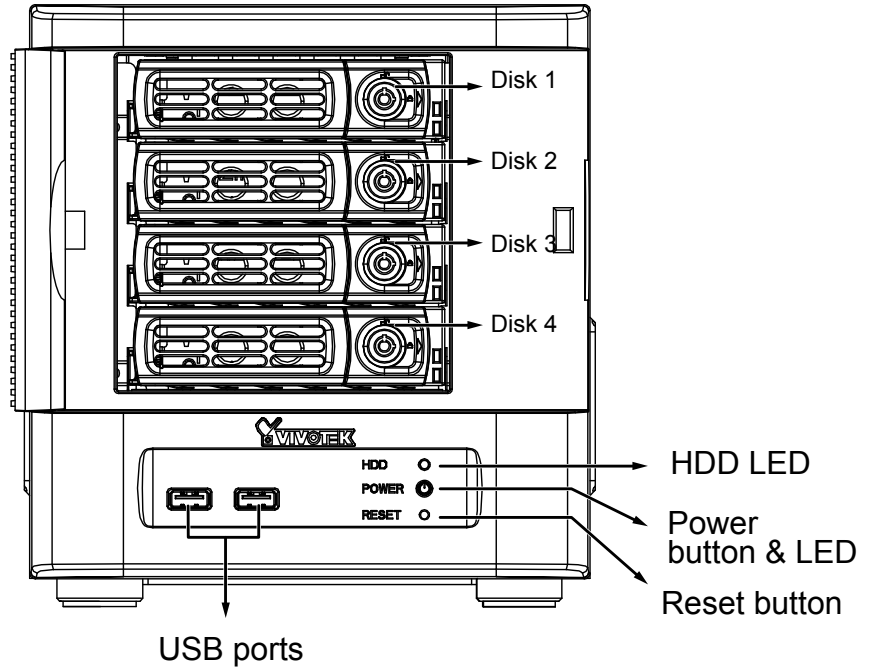

● Rear View

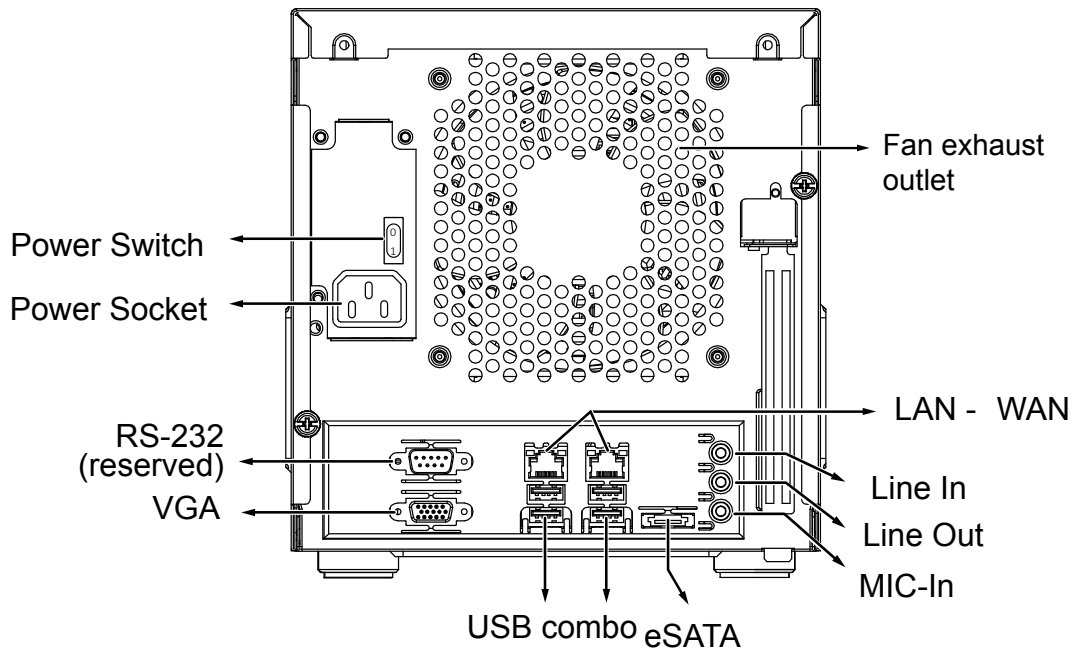

⚠ IMPORTANT:

It is important to leave a clearance of 15cm to the rear side of the chassis. The clearance is required to ensure an adequate airflow through the chassis to ventilate heat. A 5cm clearance is also required on both sides of the chassis.

To ensure normal operation, maintain ambient airflow. Do not block the airflow around chassis such as placing the system in a closed cabinet.

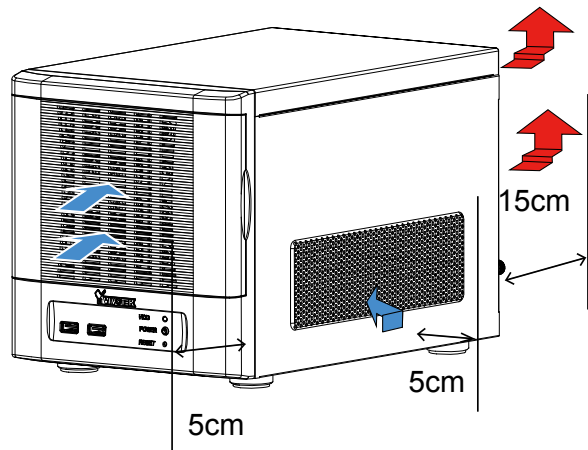

⚠ IMPORTANT:

For a RAID volume configuration, it is recommended you use hard drives of the same model featuring the same capacity and rotation speed, even running the same version of firmware.

Hardware Installation

SATA hard disk(s) are user-supplied. The network video recorder can readily accommodate most of the off-the-shelf SATA hard drives.

1. Open the front panel.
2. Use the included bezel key to unlock the bezel lock.
3. Open the drive tray bezel by flipping the bezel latch to the side. The bezel lever will spring open, and you can then remove the drive tray.

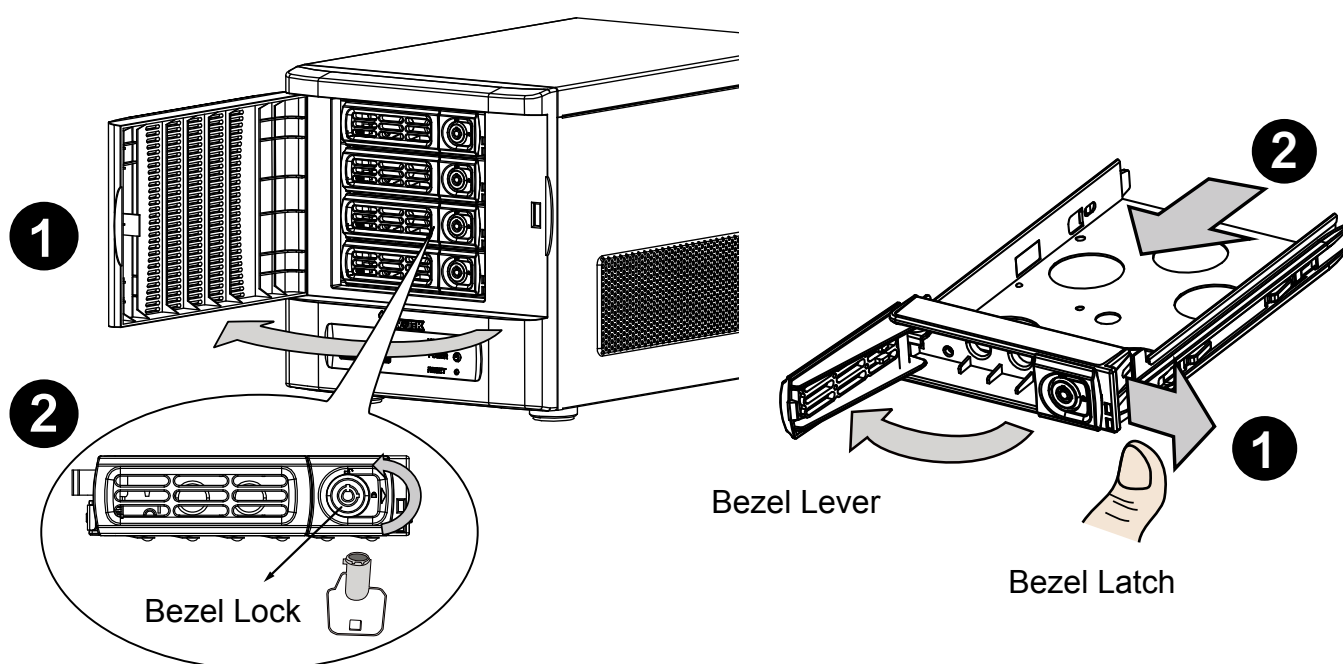

4. Install your hard disk to the drive tray. Gently put the hard disk into drive tray with its label side facing up and the connector side facing the inside of the chassis. Flip the hard drive and drive tray over, and then secure the hard drive by fastening 3 screws.

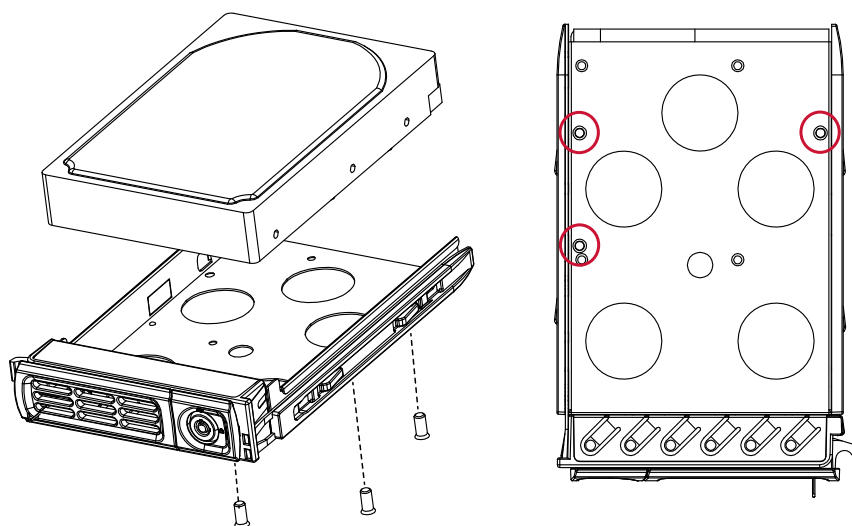

**IMPORTANT:**

Avoid touching the hard drive's circuit board or connector pins. Doing so can damage the hard drive by electro-static discharge.

5. Install drive tray by pushing it into drive bay. when it is almost fully inserted, close the bezel. The bezel will secure the back-end connection to the backplane.

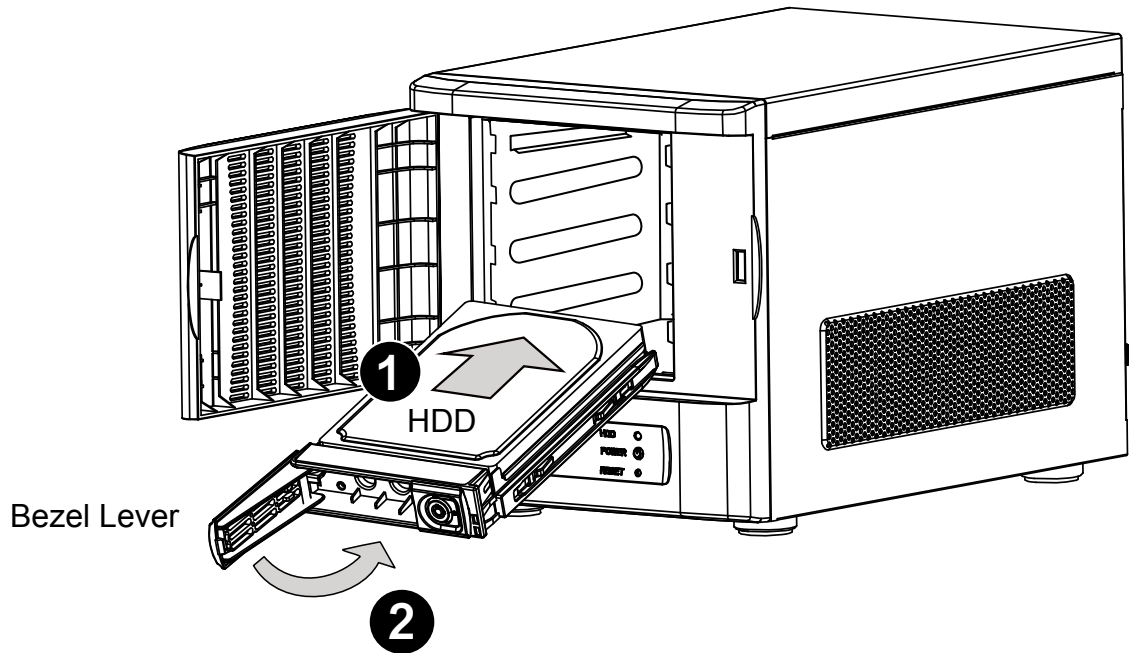

6. Use the bezel key to lock the drive tray. Repeat the process to install more disk drives.

Bezel Lock

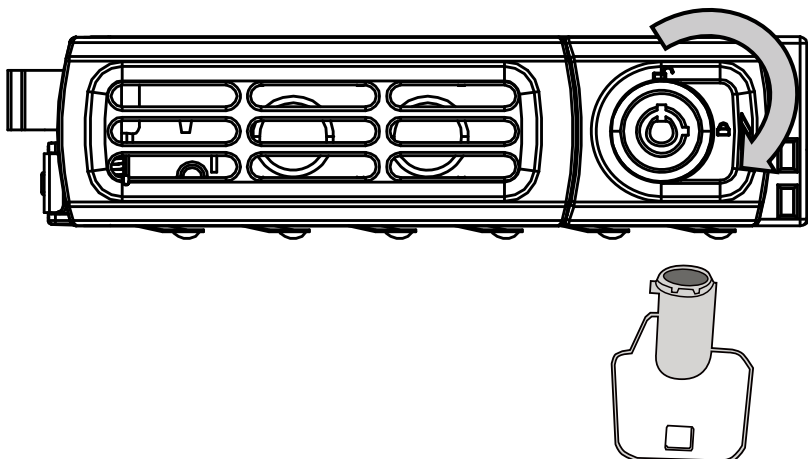

Interface Connections

- 1 & 2. Connect CAT5 or better-quality Ethernet cables to cameras via a local, switched network, or clients through the Internet. Refer to next page for more information.
3. Connect the DB15 VGA port to a monitor (with resolutions up to 1920x1080).
4. Connect USB devices such as keyboard and mouse.
5. If an external eSATA storage enclosure is available, connect it to the eSATA port.
6. Connect speakers or microphone to the phone-jack connectors.
7. Connect the power cord to the power socket 100-240V AC. (50~60Hz, 3~1.5A)

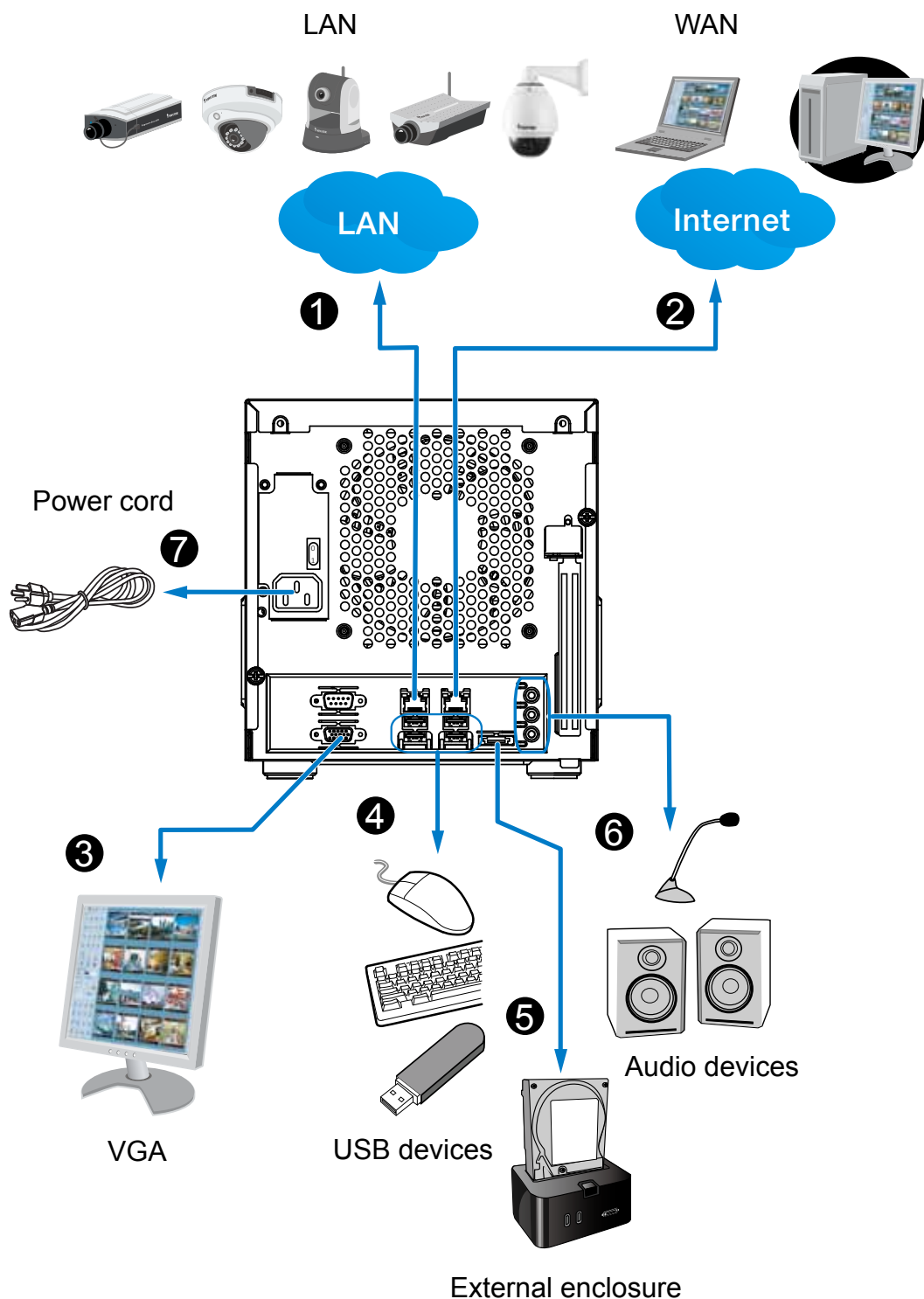

Network Deployment

1. Connect network cameras to the NVR's LAN ports.
2. If you want to access NVR over the Internet, connect the NVR to the Internet via the WAN port. A web console can be established from a remote PC by keying `http://<public IP>:3454` in a browser's URL address field. However, port forwarding on the router for the TCP port will be necessary.
3. Flip the power switch (at the rear of chassis) to the ON position, and push the power button to run the NVR.

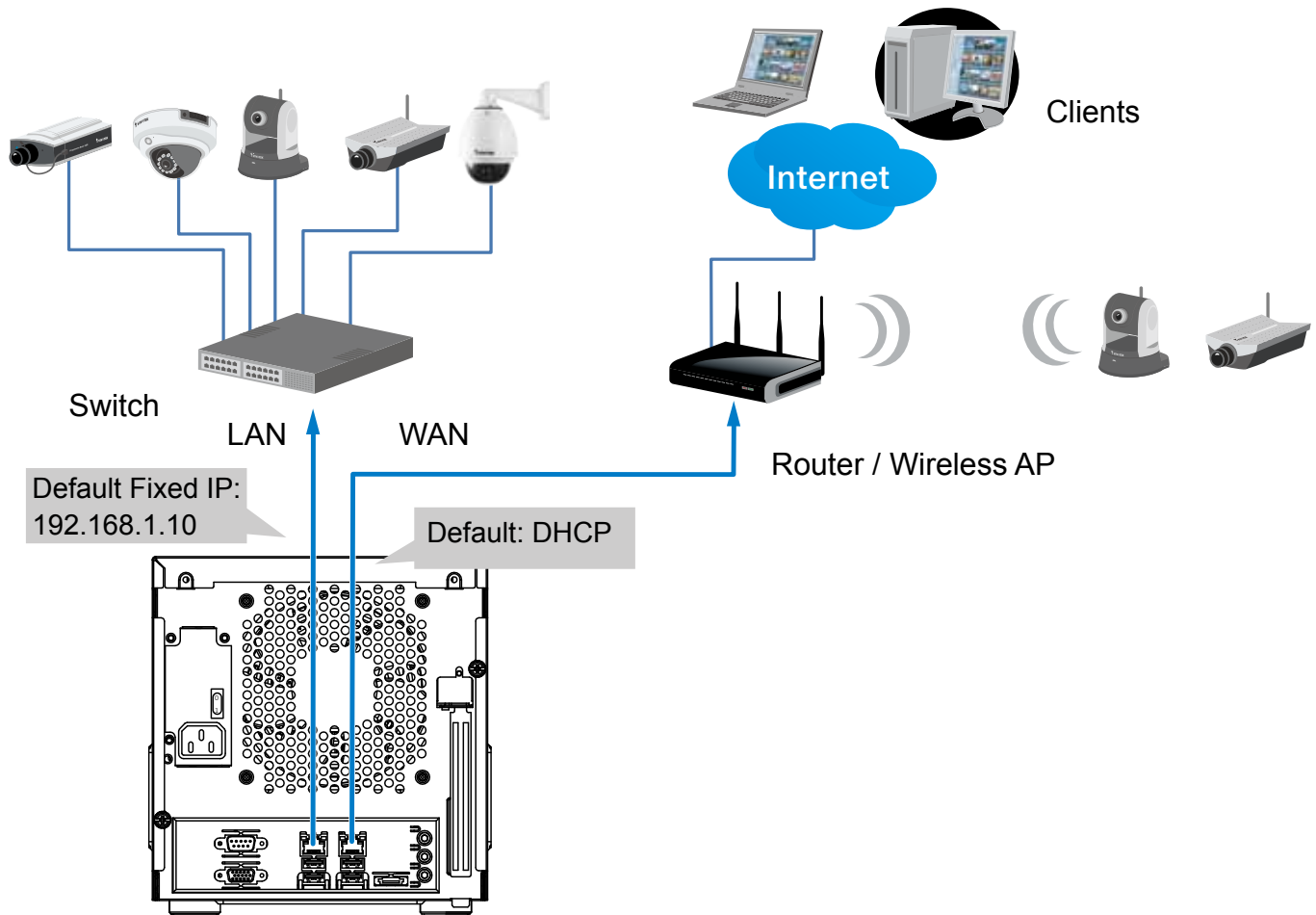

NOTE:

The LAN and WAN ports can be configured into the same or different subnets.

If you have cameras connected via the WAN port, make sure the WAN port acquires an IP address from a DHCP server on router or AP. If not, the cameras detected through the WAN port will use the default IPs, e.g., 169.254.xx.xx, and the LiveClient software will not be able to detect their presence.

Initial Configuration

1. The system power on self test and OS initialization takes about 2 minutes to complete. Once your NVR is started, you will be prompted by the **Setup Wizard**. You should then begin the initial setup. The system is booted from an embedded IDE flash. No software installation is required.



IMPORTANT:

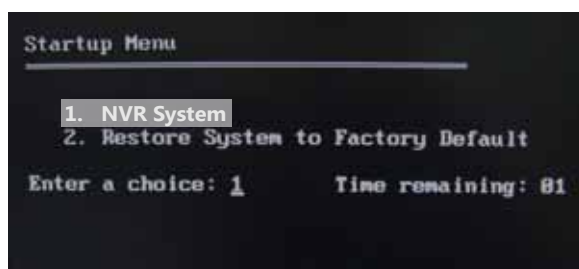

1. During boot-up, a Startup Menu will prompt allowing you to restore system to factory defaults. This function is only required in circumstances that you need to renew all system settings, such as moving the NVR to a different installation site or network environment.
 2. You must install at least one hard drive for the initial configuration. Otherwise, the LiveClient console will not start.
-
2. Enter the default User name and Password as **admin & admin**. It is recommended you change the password later to prevent unauthorized access.
 3. Click **Next** to proceed with configuration and follow the onscreen instructions to finish the configuration process.
 4. Note the following when you move to the **Network** page:
 - 4-1. If your local network has a DHCP server, you can select the "**Get IP address automatically (DHCP)**."
 - 4-2. If your LAN port connects to an isolated switch with cameras attached to it, you can manually assign IP addresses to cameras, and the address for the LAN port itself.

The default static IP for the LAN port is 192.168.1.10.

4-3. Connect your WAN port to a router or AP with the routing capability and then to a DSL or Cable modem.

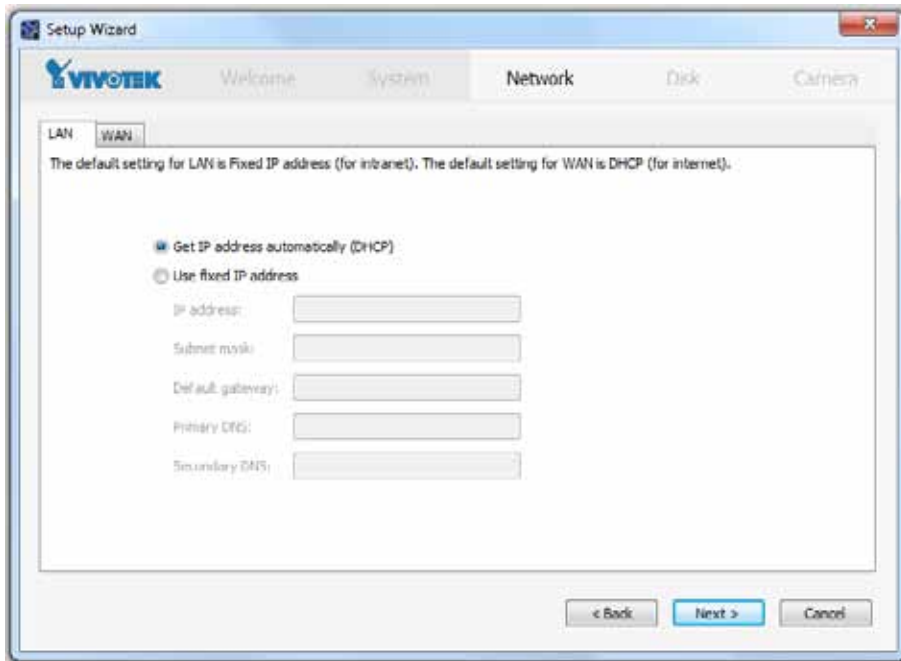

5. On the **Disk** page, Select disk drives by clicking the checkboxes in front of disk drives. Select **Build single disk**, **Build RAID0**, **RAID1**, **RAID5**, **RAID10** or other option from the **Disk configuration** pull-down menu. Click **Apply** and wait for a few minutes for the configuration to take effect.

Refer to the description available with every disk volume type on the screen, such as those for RAID0, RAID1, RAID5, or RAID10.

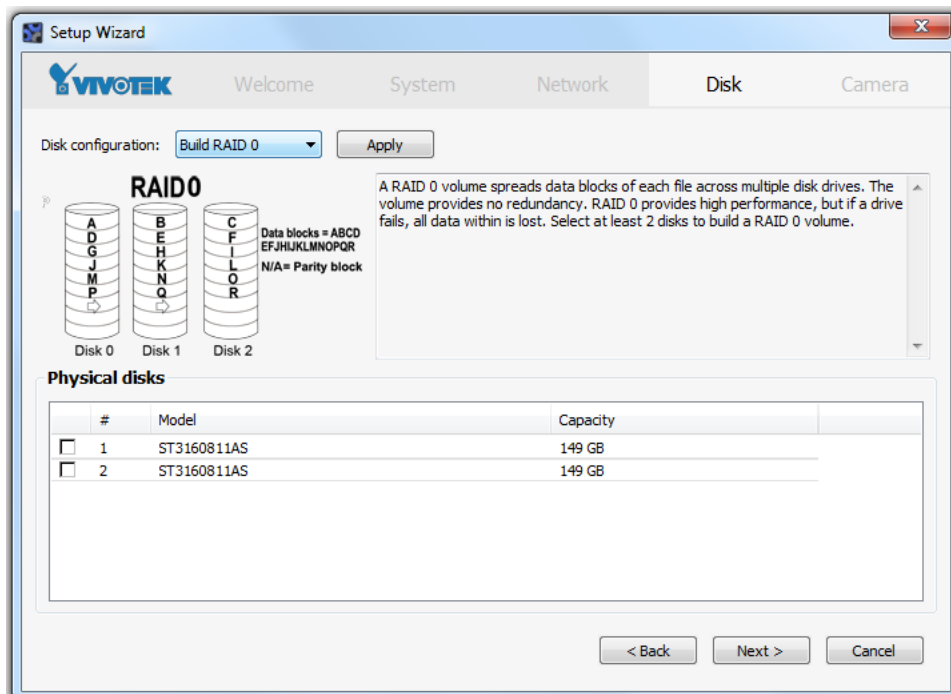

6. On the Camera page, all cameras connected through the local network should appear on a **Camera list** after a brief search. You can manually assign IP addresses by clicking on the cameras' address field. You can also select the "Assign IP addresses to all cameras" checkbox and let NVR assign IPs to cameras.

Click **Next** to end the initial setup. Make sure you have the cameras' access credentials in order to make individual changes. It is also highly recommended to **synchronize** cameras' time with that of the NVR system. Click the checkbox below for an automated synchronization.

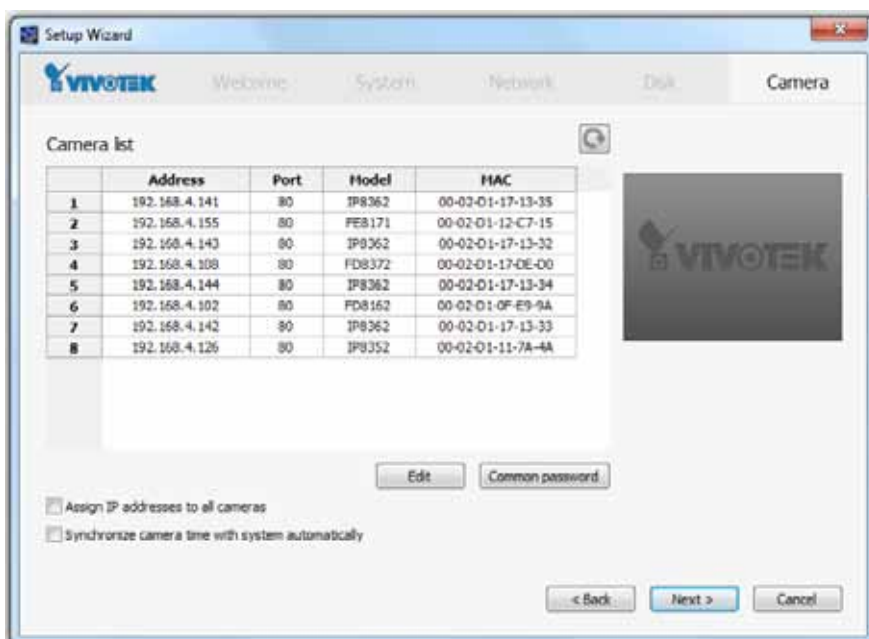

Ready to Use

1. You will then be at the **Control Center** screen. Double-click on the **LiveClient** or **Playback** buttons to configure live viewing and recording settings.



2. Open the LiveClient utility to change live view layout, camera streaming frame rate, and other options.
3. 3-1. By default, the **Batch Insert Cameras** window will prompt for you to recruit cameras into your configuration.

You may also access the same configuration page in the **Configuration** menu. Select **Camera Management > Batch Insert Cameras**.

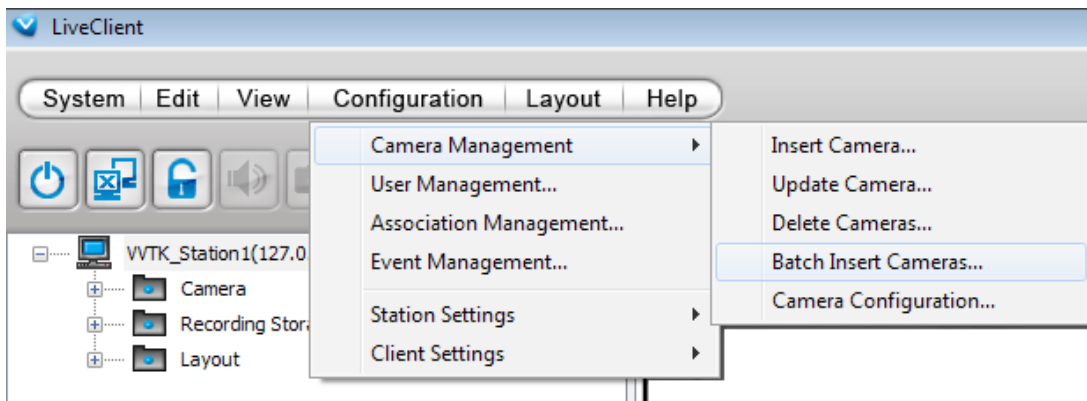

3-2. Click on the **Search** button.

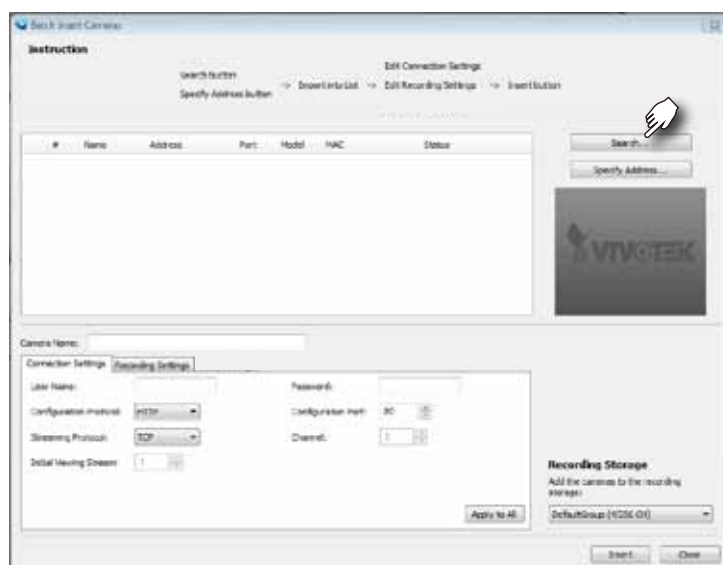

3-3. Select cameras by clicking their checkboxes.

3-4. Click **OK**, return to the previous window, and click the **Insert** button.

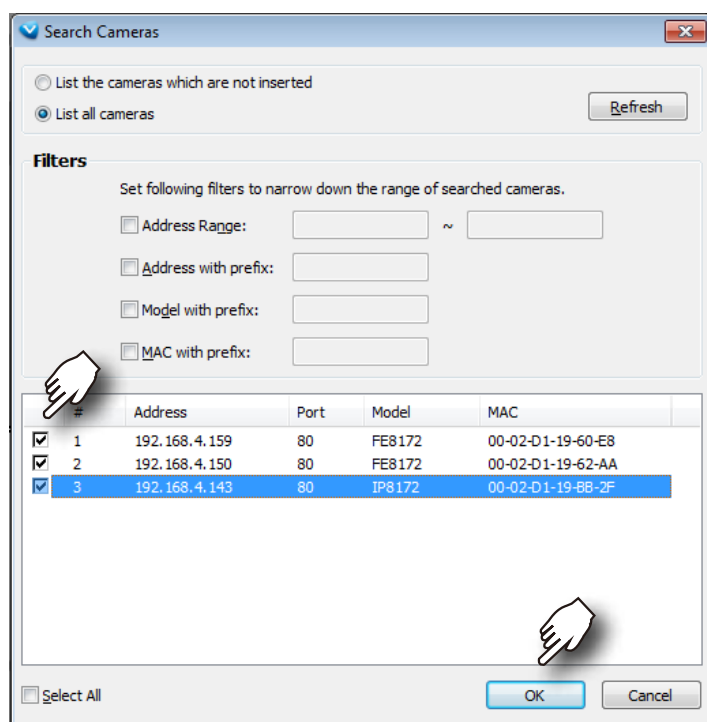

4. It is important to ensure that the live viewing and recording configuration does not exceed the system's limits:

In terms of **local display**, the default stream 1 for live view can be configured with a resolution up to Full HD 30fps. Stream 1 is also a source for continuous recording. **Make sure your cameras' stream 1 resolution does not exceed 1080P at 30fps.**

Compression	MJPEG				H.264			
Resolution	1080P	720P	VGA	CIF	1080P	720P	VGA	CIF
Frame rate	15fps				30fps			
by bit rate / video quality	Good				6Mbps	6Mbps	1Mbps	512kbps
No. of streams	-	-	9	16	1	1	3	7

Compression	MPEG-4			
Resolution	1080P	720P	VGA	CIF
Frame rate	30fps			
by bit rate / video quality	6Mbps	6Mbps	1Mbps	512kbps
No. of streams	2	2	5	16

The NVR supports **Auto Stream Size**, which automatically adjusts streaming display for efficient leverage of system resources. If you disable the Auto Stream Size function and manually configure your stream settings, you must comply with the limitations listed above.

IMPORTANT:

You may need to configure a recording stream of a particular resolution and bit rate. When doing this, you should make sure the **Recording load** does not exceed the maximum **96Mbps** as the sum of bit rates per second allocated for all recording streams. If you have multiple cameras and the upper bound is exceeded, proceed with the following:

If you configure a RAID5 volume as the recording storage, the maximum system throughput will be reduced to half of the 96Mbps limitation.

Configure the Recording setting in **Configuration > Camera Management > Update Camera**. When the **Update** window prompts, select a camera. Click on the **Recording Settings** tabbed menu, and select a smaller stream (in higher or lower bit rate or resolution) as the source of recording. Click **Update** to save your configuration and repeat the setting until the recording load is back within the 96Mbps limitation.

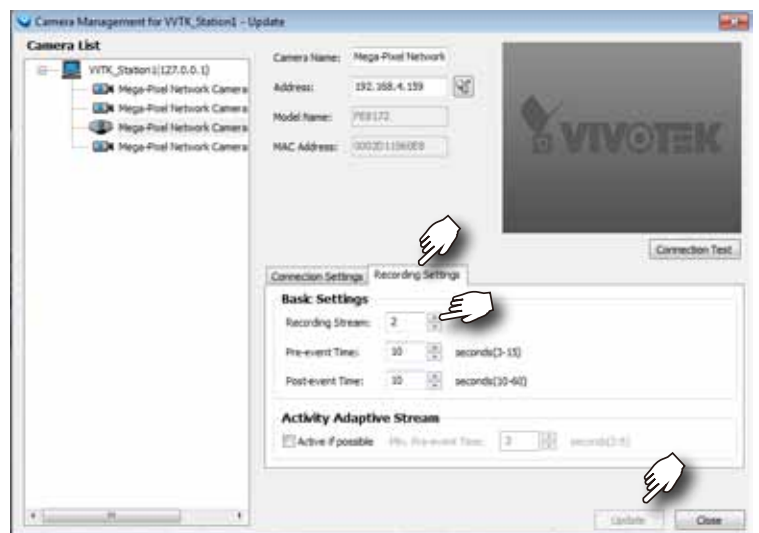
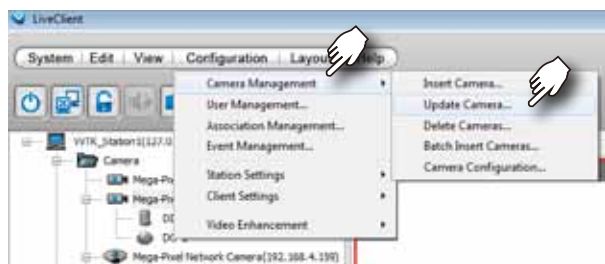







NVR Desktop Elements





Control Center



Normally the desktop defaults to the Control Center view, which provides direct access to various functional utilities such as LiveClient and Playback. The functions of these utilities are summarized as follows:

Utility	Description
 Setup Wizard	The Setup Wizard guides you through important steps on initial setup. Most of the storage-related settings are managed through this wizard, such as creating disk volumes, formatting, and breaking down existing disk volumes.
 LiveClient	LiveClient and Playback are the most important interfaces to the NVR's various functionalities. LiveClient provides a centralized management interface to the NVR system, provides live viewing, PTZ / E-PTZ operation, PiP, E-Map, etc. Refer to Chapter Two on page 23 for the operation details.
 Playback	Playback enables access to recorded videos, snapshot, bookmark, backup, and retrieval of recorded video, and more. Refer to Chapter Three on page 153 for the operation details.
 Service	Services enables you to restart or stop the embedded NVR server (VAST server).
 Import/ Export	The Import/ Export utility helps preserve current system configuration or reload a previously-saved configuration.
 Installation Wizard 2	The IW2 utility offers a glimpse of VIVOTEK cameras and the access to them in a local area network.
 Shepherd	You can use Shepherd to quickly duplicate individual camera configuration (system, video streams, network, security, etc.) to multiple cameras. Please refer to page 191 for more about this utility.

Except for LiveClient and Playback, detailed description of the auxiliary functions can be found in **Chapter Four** on page 187.

	Upgrade	The Upgrade provides access to NVR system updates.
	File Manager	The File Manager helps locate particular system or video data when the need arises, say, for retrieving forensic evidences.
	Keyboard	If a keyboard is not available, use this virtual keyboard for entering data.
	Power down button	Use it to power down or restart the system.

 **NOTE:**

The system should always be powered off using the **Power Down** button on the desktop. If the system should hang for some reasons, you can press the power button on the front panel for 4 seconds to power off the system.

Menu Bar

The menu bar contains the following menus:

Menu	Description
Control Center	As previously described, the Control Center is the main access point to major functionalities.
Disk Status	Disk Status provides a glimpse of Logical Volumes, Physical disk statuses, HDD status reported through S.M.A.R.T. (Self-Monitoring, Analysis and Reporting Technology), and a test tool to check the integrity of individual disk drives.
Network Status	Displays the network statuses of the NVR's two GbE Ethernet ports, including network type, IP address, subnet, and gateway information.
System Status	Reports system overall working status.

Most of the NVR's major functionalities are managed through the LiveClient and Playback interfaces, refer to Chapter 4 for description of auxiliary functions.

The operating system and VAST server are installed on an IDE flash mounted on the main board. There is no need to install software.

Except for LiveClient and Playback, detailed description of the auxiliary functions can be found in **Chapter Four** started from page 187.

Alarm Sound

The onboard buzzer will sound if the following occurs: A **hard drive** is removed or if the **LAN** or **WAN** port is disconnected. Mute the alarm by closing the event prompt.

The hard disk reported as "failed" via S.M.A.R.T. will also trigger the alarm sound and a warning message.

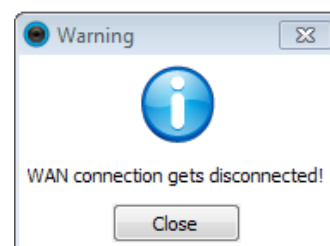

Chapter Two NVR LiveClient Configuration

- Centralized management site for all the logged in clients
- An NVR can also be managed using a separately-installed LiveClient on a remote PC (rev. 1.7.x or later).
- Local 1080P HD display
- Up to 16 video recording channels
- Store recorded data onto a total of four hard disks (single disks, RAID0, RAID1, RAID5, or RAID10 configurations)
- Live video for the local/remote LiveClient users
- Retrieval of recorded video for the local/remote Playback users

LiveClient is the management interface to your NVR server. The server-related settings are made via the VAST LiveClient utility. The convenient and intuitive user interface on the LiveClient helps managing cameras, live monitoring, and recording configurations.

i Information:

- Only users with the Administrator's privileges can manage the LiveClient/s various function groups.
- The maximum length of recording will depend on the video recording settings, the number of cameras, and Storage Group settings.

Below are the approximate numbers for a recording task. A Constant Bit Rate method (fixed bit rate per second) is recommended to control the bandwidth and total file size consumed with continuous recording.

If the max. bit rate for each camera is set to 6Mbps at the 1080P resolution (in H.264), each recording channel requires $6\text{Mb} \times 86400 / 8 = 63.3\text{GB}$ each day as storage space. With 16 recording channels, a 1,518GB of storage space is required for continuous recording for one day.

A RAID0 volume consisting of 4x 2TB disk drives can hold the 16 HD streaming recording for 5 days.

VAST LiveClient Functionality

- Server function control
 - User account management
 - Recording storage management
 - Recording schedule management
 - Recorded data backup and automated schedule
 - Event trigger management
- Flexible video live view layout
 - A screen for a maximum of 8 channels for simultaneous monitoring
 - 1x1, 2x2, 3x3, 4x4, 1+5, and 1+12 monitoring layouts
 - Multiple video viewing pages
- Intelligent PiP (Picture in Picture) function
- E-map for overall management
- Networked storage for recorded video
- PTZ / E-PTZ operation panel for camera control
- Supports two way audio
- Supports joystick control
- Remote configuration for network cameras
- Instant Replay of video taken seconds earlier (on a remote LiveClient console due to limitations on system sources)

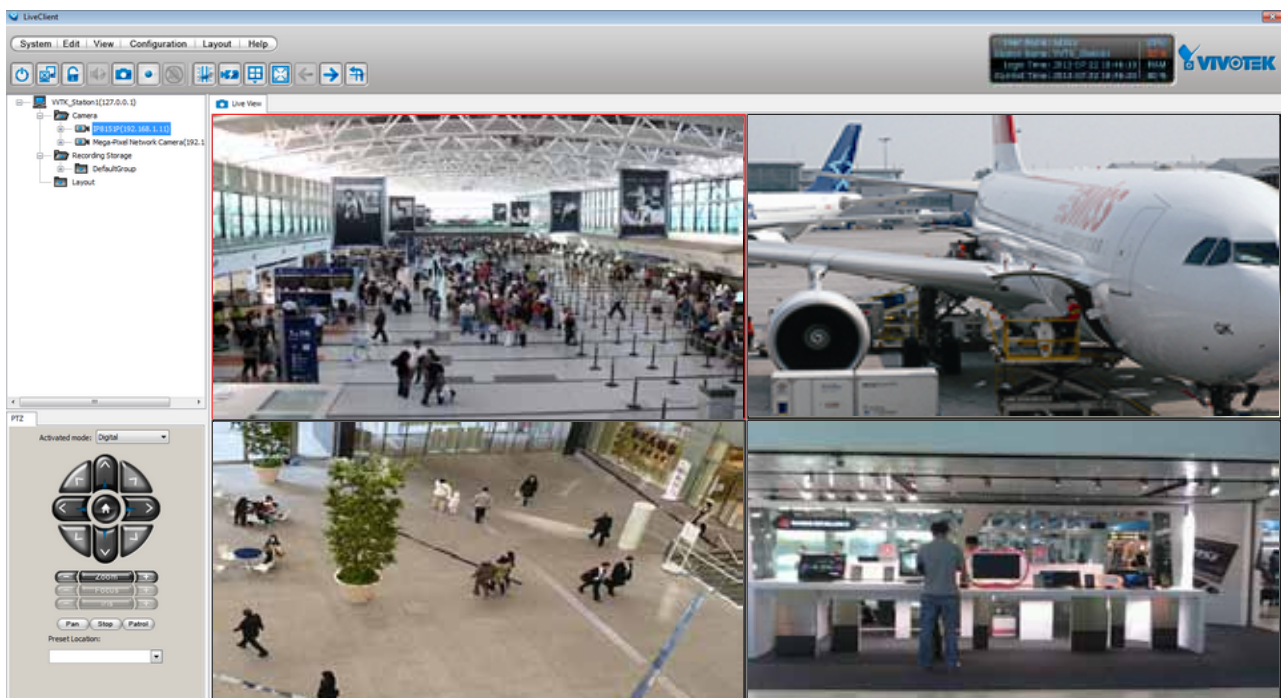

VAST Server

Activating the VAST Server

VAST Server is a service program that will run automatically when your NVR system starts. The VAST server manages video recording, live view monitoring, and other related surveillance functions.

How to Stop/Reboot the Server

Please follow the steps below to stop/reboot the server:

1. Click on the VAST Service shortcut on the Control Center desktop.



2. There are 3 options: Start Service, Stop Service, and Restart Service. It's selectable using the buttons below. Stop Service can be used to promptly stop a recording task or access from a remote computer.



LiveClient Configuration

Opening the LiveClient Interface and Logging in

VAST LiveClient allows you to monitor live video from cameras managed by the NVR; it is also the main access to the server's functional control.

Double-click on the LiveClient shortcut on the desktop to open the LiveClient utility:

1. The login box will prompt. Provide the default User Name and password as **admin** and **admin**.
2. Click on the **Login** button to continue.

A screenshot of the VAST LiveClient login dialog box. The window title is "VAST LiveClient". It contains two text input fields: "User Name:" with the text "admin" entered, and "Password:" with six dots representing a masked password. Below the fields are three buttons: "Login", "Cancel", and "More >>".

3. The VAST LiveClient monitoring window will prompt.



NOTE:

Available functions of the LiveClient program will be enabled according to the privileges granted for your login account. For more details about user account, please refer to [How to Manage User Accounts](#) on page 56.

LiveClient User Interface

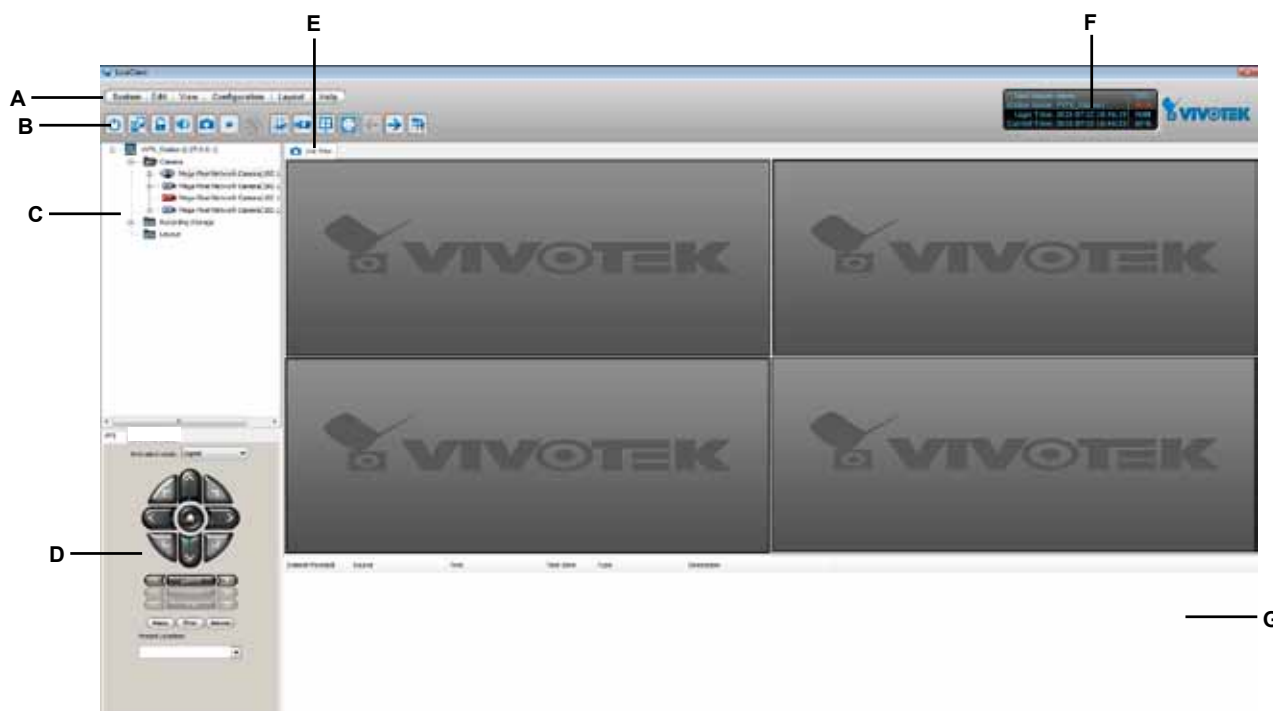

- A. Menu bar
- B. Quick access bar
- C. Hierarchical management tree
- D. Camera control panel (PTZ / Two way audio / Instant Playback control panel)
- E. Live view window
- F. Status panel
- G. Event window

Menu Bar

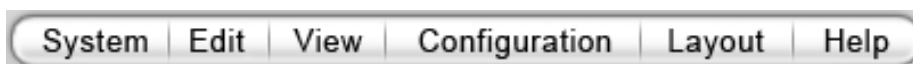

Menu Item	Drop-down Options
System	Lock / Enable Click On Image (Disable Click On Image) / E-map / Launch Playback / Logout / Exit
Edit	Manually Begin Recording (Stop Manual Recording) / Snapshot / Record to EXE / Snapshot Zoomed Image / Find
View	PTZ Panel / Two Way Audio Panel / Event Window / Full Screen / Minimize
Configuration	Camera Management (Insert Camera / Update Camera / Delete Cameras / Batch Insert Cameras / Camera Configuration) / User Management / Association Management / Event Management / Station Settings (General Settings / Network Settings / Recording Storage Settings / Recording Schedule Settings / Scheduled Backup Settings / Server Settings / Relay Settings) / Client Settings (Snapshot Settings / Recording Settings / View Settings / General Settings / Joystick Settings / PiP Settings) / Video Enhancement (Basic Image Adjustment / Defog)
Layout	Start Rotating (Stop Rotating) / Save to / Delete / Choose / Patrol
Help	About

Status Panel

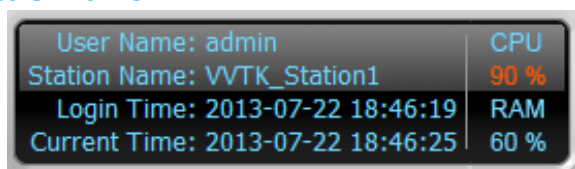

User Name	CPU
Station Name (IP Address)	usage
Login Time (yyyy-mm-dd hh:mm:ss)	RAM
Current Time (yyyy-mm-dd hh:mm:ss)	usage

Quick Access Bar

Icon	Function	Description
	Exit	Exit the system
	Logout	Log out from the current station
	Lock	Click to Lock the system for security concerns (Unlock the system)
	Volume	Adjust the audio volume of the current video (Mute)
	Snapshot	Capture pictures from the focus live video cell
	Record to Media	Record media in EXE/3GP/AVI format (Recording Media)
	Alert Sound	Silence a triggered alarm when an event occurs, e.g., a DI is triggered.
	Adjust SVC Level	Dynamically adjust the SVC control over frame rates
	Remove All Connections	Remove all live videos from the live view window
	Layout	Change the layout of the live view window
	Full Screen	Maximize the live video cell
	Page Up	Switch to the previous live view page
	Page Down	Switch to the next live view page
	Start / Stop Rotating	Start or stop live view layout rotating

NOTE:

Some buttons will be disabled if the selected devices do not support the related functions.

Live Video Monitoring Window

The "VIVOTEK" logo is displayed where no camera has been assigned to a video cell.

The red frame () represents the current selection.

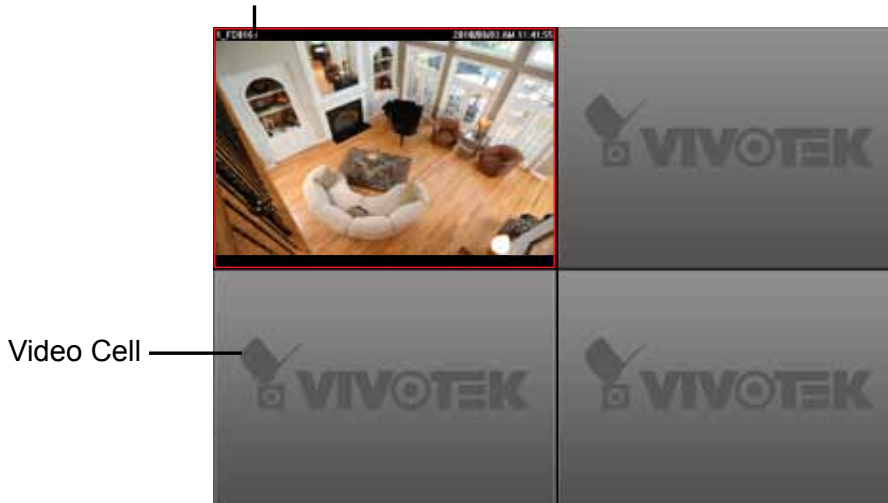

Hierarchical Management Tree

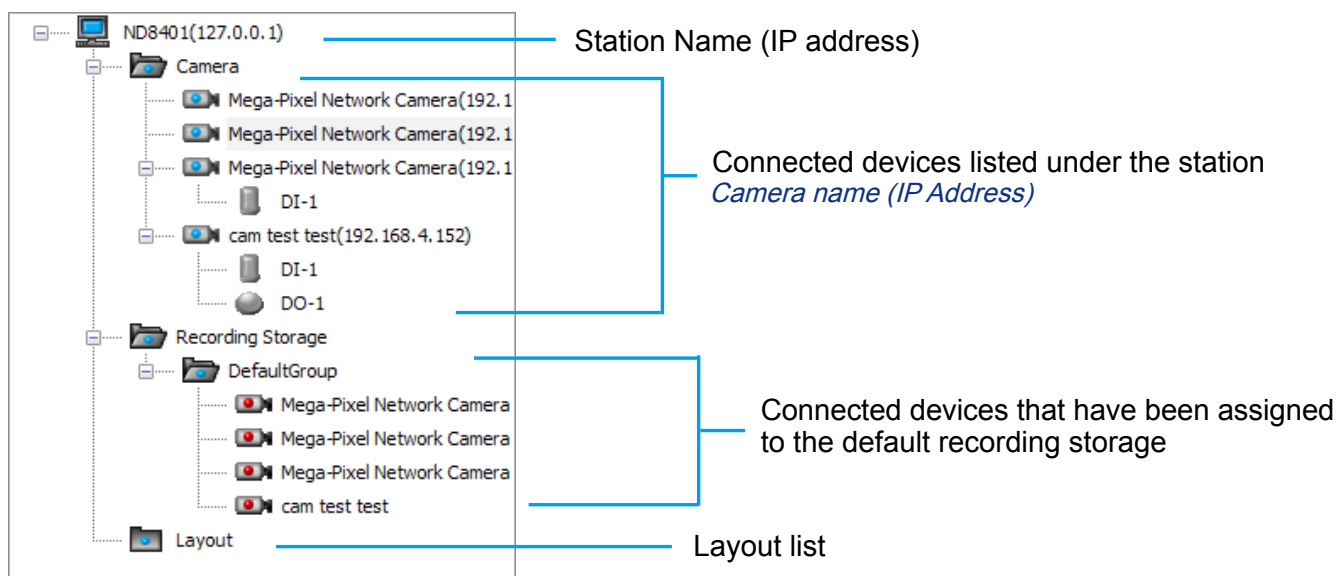

Icon	Description
	A station (The NVR running the VAST Server)
	VIVOTEK fixed network camera Red dot signifies that the camera is recording.
	VIVOTEK PTZ network camera Red dot signifies that the camera is recording.
	VIVOTEK dome network camera Red dot signifies that the camera is recording.
	VIVOTEK fisheye network camera Red dot indicates that the camera is recording.
	VIVOTEK video server Red dot signifies that the video server is recording.
	Digital input on / off
	Digital output on / off
	A layout of the live monitoring window
	A station that's not able to be connected currently.
	A device that's not able to be connected currently.

NOTE:

A Logical Tree will be available with the LiveClient console separately installed on a remote PC. The Live Client instance will be available in the Software CD that comes with the NVR system (rev. 1.7.x). That particular edition allows the NVR and cameras under it to be listed with other VAST server configurations.

Camera Control Panel

Pan/Tilt/Zoom (PTZ) Control Panel

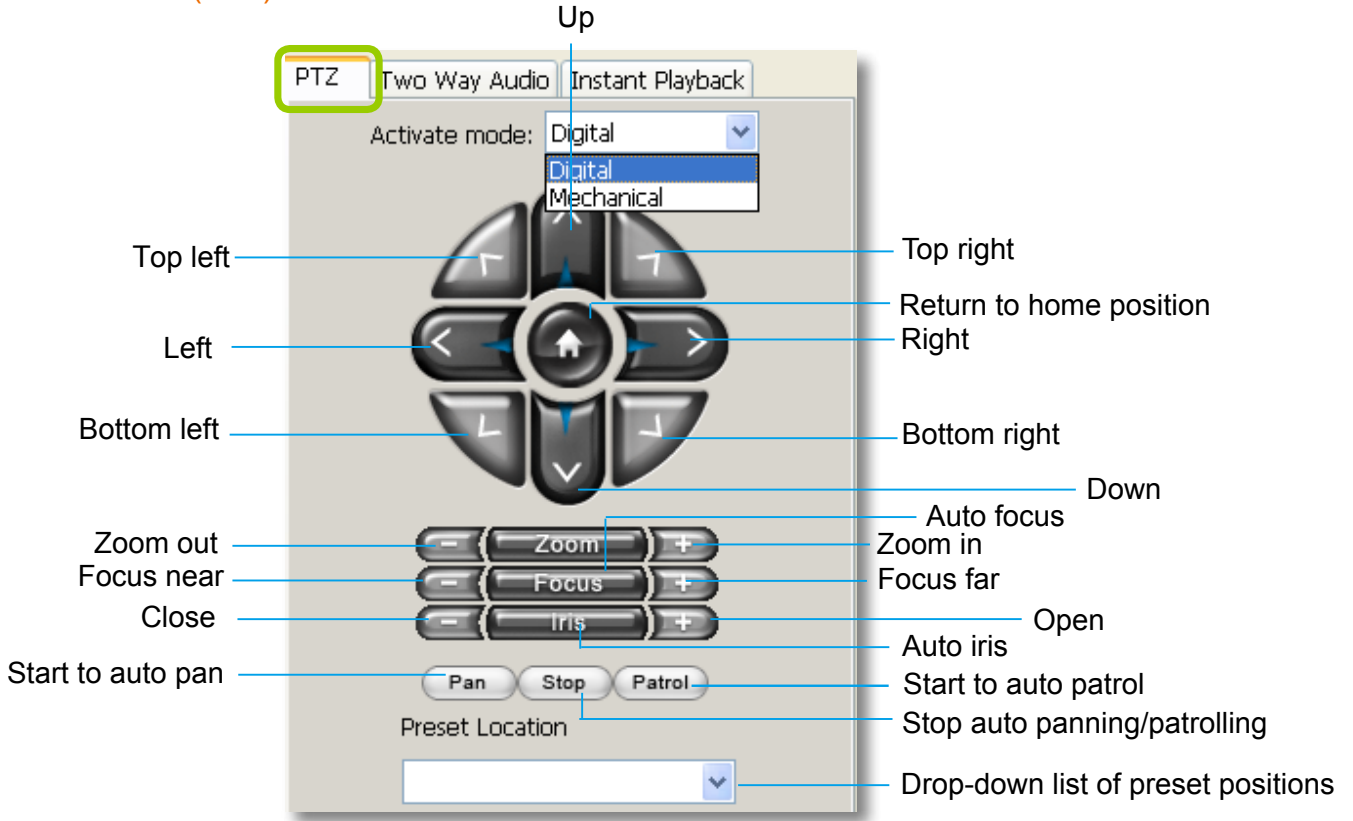

NOTE:

- There are two types of PTZ control: Digital (E-PTZ for megapixel cameras) and Mechanical (PTZ cameras or fixed cameras with camera control via RS-485). If the connected cameras support PTZ/E-PTZ function, the PTZ option(s) will appear on the drop-down list. For detailed camera control settings, please refer to the user's manual of VIVOTEK network camera.
- Click **System > Enable Click On Image** to use the mouse for the control of the PTZ and e-PTZ functions in the video cells for linked cameras. An icon  will appear in the video cell as shown below.

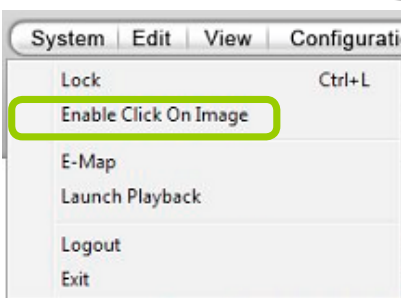

- You can control the PTZ function through a joystick as well. For more information regarding to the joystick configuration, please refer to instructions on page 138.

Two Way Audio Control Panel

The two way audio function allows the user to remotely communicate with people nearby the network camera.

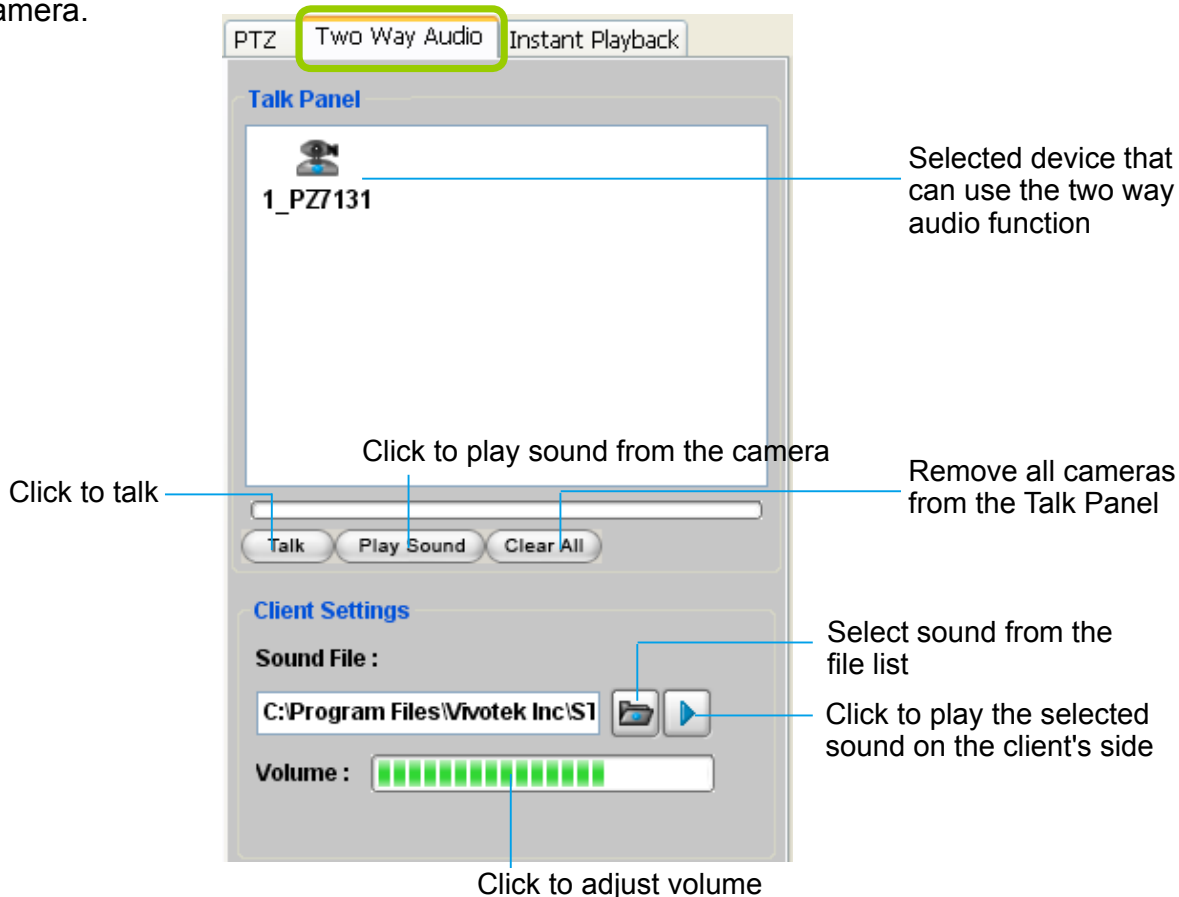

NOTE:

- For detailed information about **How to Use the Talk Panel**, please refer to page 112.
- Only cameras that come with the two way audio function can be added to the Talk Panel.
- The Language selection menu has been moved to the Setup Wizard.

Event Window

Click **View > Event Window** to insert a window showing the real-time information for event triggers. If you want to hide this window, deselect this option on the menu bar.

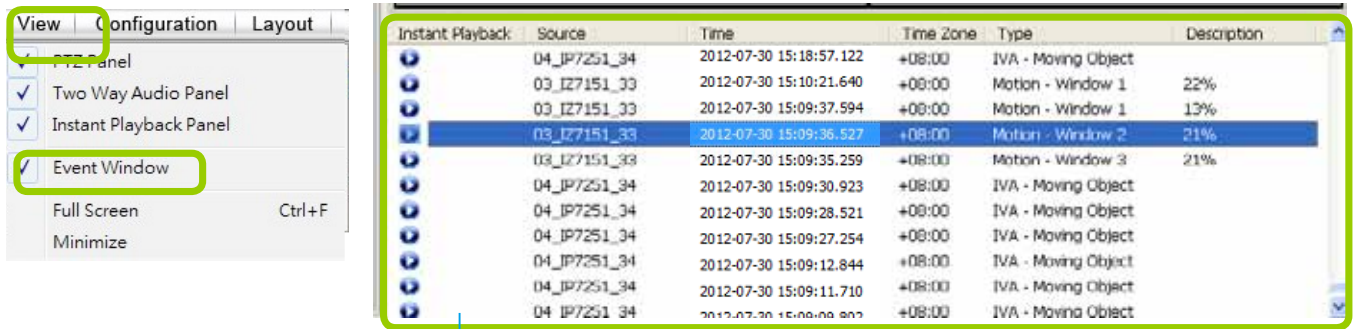

Event Window

The default event window is fixed on the bottom of the LiveClient. If you want to change the event window as a popup page, please click **Configuration > Client Settings > General Settings** to switch the modes.

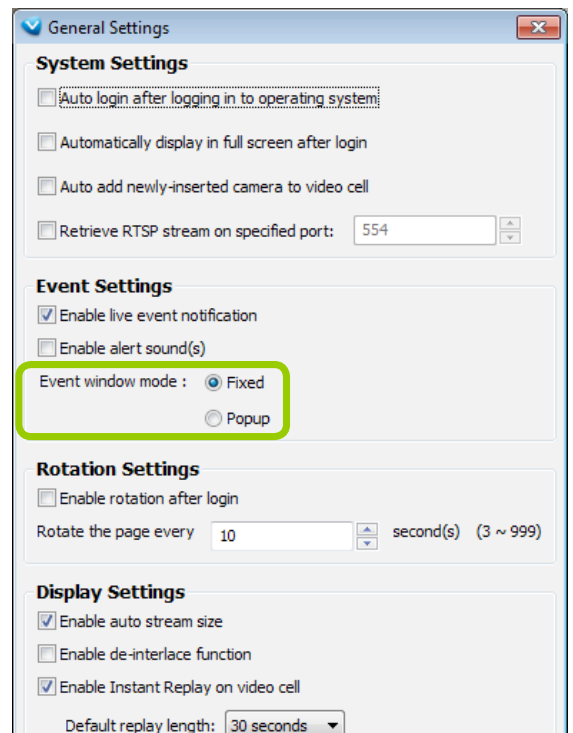
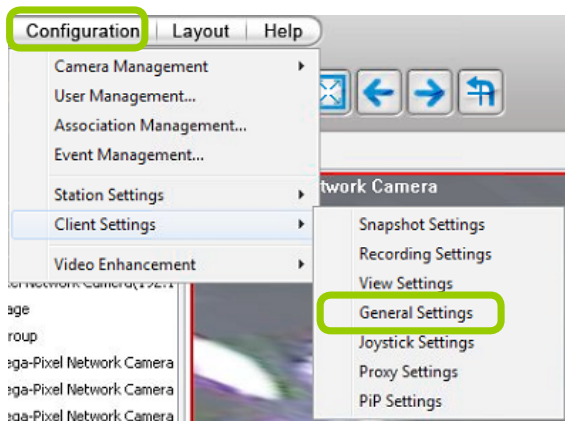

- The **Type** field in the event window shows the event category and another field **Description** displays the **percentage** of motion in the detection window. You can open an individual web console with the camera (left-click to select, right-click to open Camera Setting) to configure Motion Detection and set the percentage.

Enable motion detection



NOTE:

For more information about DI/DO settings, please refer to **Association Management** on page 70.

Instant Playback (on Remote LiveClient)

Instant Playback is available on a remote LiveClient console. Check **View > Instant Playback** to open the window on the panel. The entries are the short recordings made from triggered events.

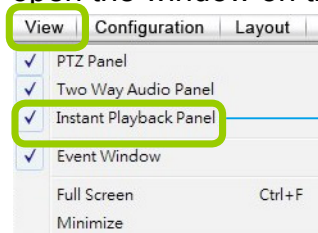

Uncheck this item if you want to hide this window.

 A screenshot of the 'Instant Playback' window. On the left is a video player showing a living room scene. Below the video is a playback control bar with a progress slider, play/pause, and stop buttons. On the right is a table of event recordings.

Instant Playback	Source	Time	Time Zone	Type	Description
	04_IP7251_34	2012-07-30 15:18:57.122	+08:00	IVA - Moving Object	
	03_I27151_33	2012-07-30 15:10:21.640	+08:00	Motion - Window 1	22%
	03_I27151_33	2012-07-30 15:09:37.594	+08:00	Motion - Window 1	13%
	03_I27151_33	2012-07-30 15:09:36.527	+08:00	Motion - Window 2	21%
	03_I27151_33	2012-07-30 15:09:35.259	+08:00	Motion - Window 3	21%
	04_IP7251_34	2012-07-30 15:09:30.923	+08:00	IVA - Moving Object	
	04_IP7251_34	2012-07-30 15:09:28.521	+08:00	IVA - Moving Object	
	04_IP7251_34	2012-07-30 15:09:27.254	+08:00	IVA - Moving Object	
	04_IP7251_34	2012-07-30 15:09:12.844	+08:00	IVA - Moving Object	
	04_IP7251_34	2012-07-30 15:09:11.710	+08:00	IVA - Moving Object	
	04_IP7251_34	2012-07-30 15:09:09.897	+08:00	IVA - Moving Object	

Instant Playback Window with a slide bar, play, pause, and stop function

The recorded media that was triggered by an event will be indicated by an icon.

You can **double-click** an event on the list to playback the recorded video. Each event contains a video clip of about 20-seconds in length. (The default recording data of an event is 20 seconds. For more information about event recording, please refer to page 86.)

Instant Replay (on Remote LiveClient)

If a camera is currently recording to the NVR, then a Replay button will be available at the lower left corner of its view cell. This allows you to immediately retrieve the video recording in the past 30 seconds.

The Instant Replay function enables you to quickly retrieve videos of what has just happened (20 seconds to 15 minutes ago), without the need to open the Playback utility for the past videos.

NOTE:

The Switch Monitor button is available on an independent LiveClient instance installed on a remote PC. For a direct connection with the NVR, this button is not available.

Prerequisites for Instant Replay:

1. The function is enabled by default, only available on a LiveClient installed on a PC.
2. There must be recorded videos of the immediate past. If the video streams from a camera were not recorded, you can not retrieve videos using the Instant Replay function.

NOTE:

1. When using the Instant Replay function and you change the stream number on a video cell, the Instant Replay will be interrupted.
2. The Instant Replay will also be interrupted when the time comes for a rotation of Live View pages. For example, if you have multiple Live View pages and you set up a rotation of these pages by every 10 seconds, page swap (rotation) still has a higher priority even if you are viewing the Instant Replay.

How to Use:

1. On a selected view cell, mouse over to the lower left corner. A Replay icon  will appear.
2. Click on it to display the Replay control bar. Click on the play button.



3. The default queue length is 30 seconds. You can click on the number on the right to change the queue length.

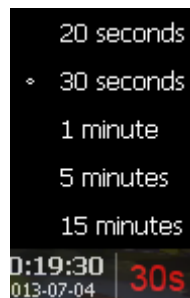

The queue length configuration stays with the view cell, and it will not go unless you remove and insert the camera again.

4. To stop the Replay and return to the Live View, click on the Return to Live button. 
5. On a Replay view cell, you can apply the same Snapshot, Print, Single view and Full screen control as those on a normal view cell. You can also right-click to display the Display Mode and Video Enhancement functions.

Click and drag the playhead to skip or move to a different point in time on the playback. 

An active Replay view cell is indicated by the Replay text indicator and the time of occurrence of the current playback.



To change the default Replay settings, open the Configuration > Client Settings > General Settings menu.

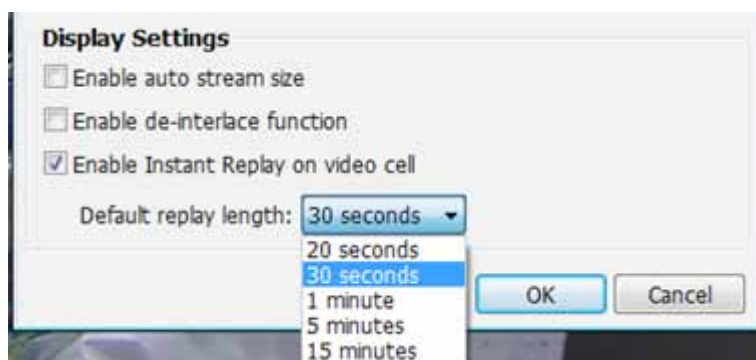

Audio Control



The audio function will be enabled if the device is equipped with an internal or external microphone. For detailed audio control settings, please refer to page 138.

How to Manage Devices (Cameras)

Please follow the steps below to open the Camera Management window:

- Select the station from the hierarchical management tree.
- Click **Configuration > Camera Management** on the menu bar (or **right-click** the station, then select **Camera Management**).
- Then you can choose to insert, update, delete, or batch insert cameras.

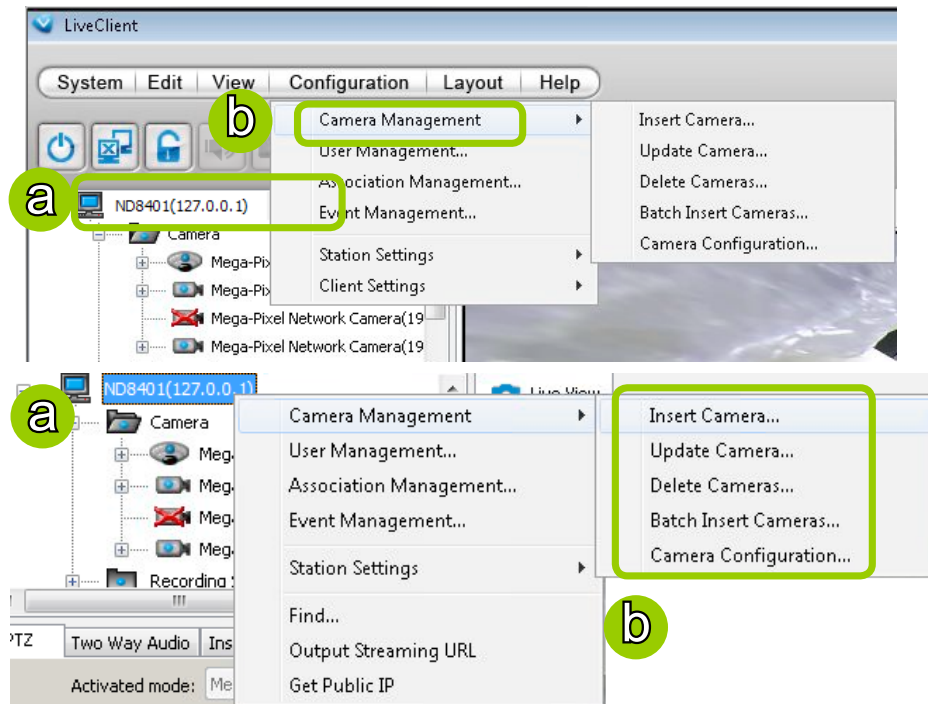

Insert Cameras

Please follow the steps below to add devices (cameras or video servers) to a station:

- Click **Configuration > Camera Management > Insert Camera** on the menu bar (or **right-click** the device/station, then select **Camera Management > Insert Camera**).
- The **Camera Management - Insert** window will pop up. The device tree managed by the station will be displayed in the Camera List window on the left.
- Enter the **Camera Name**, **IP address** (or you can enter an **IP address** and check **Auto** to get a camera name automatically) and configure the **Connection Settings**.
 - If the camera is on the LAN, you can click  **Search Camera** to detect all VIVOTEK network cameras on the LAN. A **Camera List** window will pop up and show a list of detected cameras on the LAN. On the top of **Camera List** window, you can select "**List the cameras which are not inserted**" or "**List all cameras**". The items listed below will then change accordingly. You can click **Mac**, **IP Address**, **Model**, **HTTP port** to sort the items. Then select a camera from the list to insert to the station.
 - The streaming protocol determines how the live video stream is sent from the camera to the local computer. Please refer to the note on the next page for a detailed description of each transmission protocol. Specify the recommended live monitoring stream for the device. If you want to change the live viewing stream, please refer to the next page to update the camera settings. Or you can **right-click** the desired view cell, then select a desired stream. Please refer to Dual / Multiple Streams on page 52 for a detailed illustration.
 - Click **Detect Model** to detect the device. The Model Name and MAC Address of the device will automatically be displayed in the respective fields if the connection is successful.
- If you want to make sure you are connected to the target device, click **Connection Test** to preview the live video from the device.

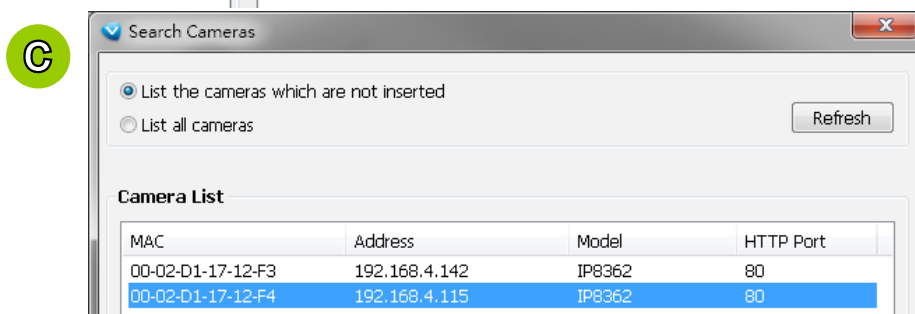
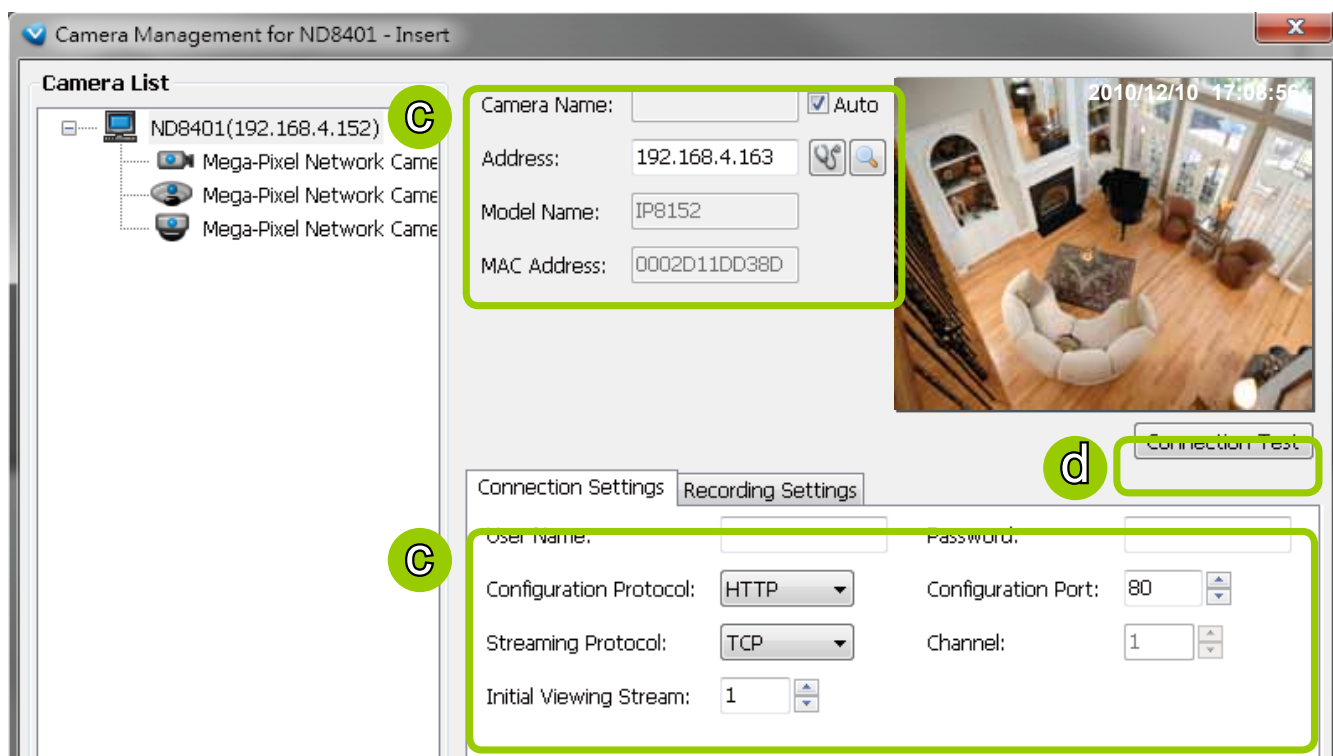

NOTE:

- If you want to use "HTTPS Port", please enable the HTTPs settings on the configuration page of a web console with a Network Camera. Refer to the camera's User Manual for details.
- The characteristics of each protocol are shown in the following table:

Protocol	Description
UDP	UDP uses a simple transmission model without implicit hand-shaking dialogues for guaranteeing reliability, ordering, or data integrity. Thus, UDP provides an unreliable service and data grams may arrive out of order, appear duplicated, or go missing without notice. This protocol allows for almost real-time audio and video streams. However, network packets may be lost due to network burst traffic and images may be obscured. Activate UDP connection when occasions require time-sensitive responses and video quality is less important.
TCP	TCP provides the service of exchanging data reliably directly between two network hosts, whereas IP handles addressing and routing message across one or more networks. In particular, TCP provides reliable, ordered delivery of a stream of bytes from a program on one computer to another program on another computer. This protocol guarantees the delivery of streaming data and thus provides better video quality. The downside with this protocol is that the real-time effect is worse than that with UDP for a narrower bandwidth.
HTTP	HTTP is a networking protocol for distributed, collaborative, hypermedia information systems. It's the foundation of data communication for the World Wide Web. This protocol allows for the same quality as TCP and the users need not open a specific port for streaming under some network environment. Users inside a firewall can utilize this protocol to allow streaming data through.
HTTPS	This protocol enables authentication and encrypted communication over SSL (Secure Socket Layer), which protects streaming data transmission over the Internet on higher security level.

e. Configure **Recording Settings**:

- **Recording Stream:** By default, the stream source of the recording stream is stream 1, if you want to change it later on, please refer to the previous page to update the camera settings.
- **Pre-event time:** Enter a number to decide how much time to record before an event is triggered.
- **Post-event time:** Enter a number to decide the duration of recording after an event is triggered.

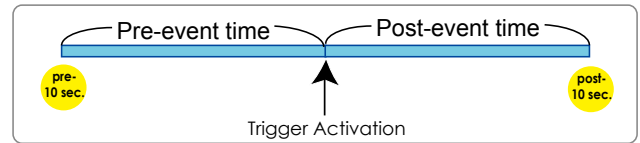
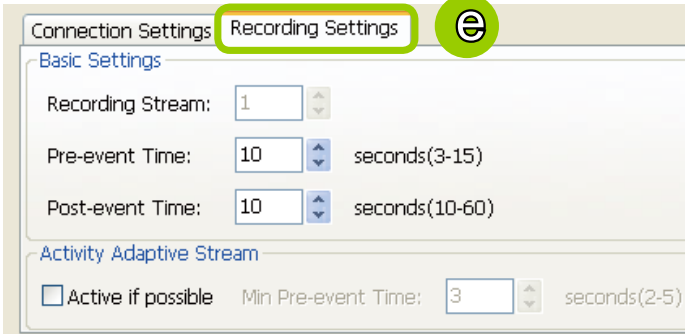

NOTE:

Please note that if you want to enable activity adaptive stream, we suggest you **right-click** the camera on the hierarchical management tree > **Camera Settings** to open a management session. Move to **Configuraion > Media > Audio and Video** to activate **"Time Shift Cache Stream"** on the camera and select a stream source. This will help record complete pre-event recording.

Note that some of VIVOTEK's latest cameras have this function enabled by default. No configuration option is needed on the camera.

Video title:

Color:

Power line frequency:

Iris mode:

Select caching stream:

Video orientation: Flip Mirror

Overlay title and time stamp on video and snapshot.

Enable time shift caching stream

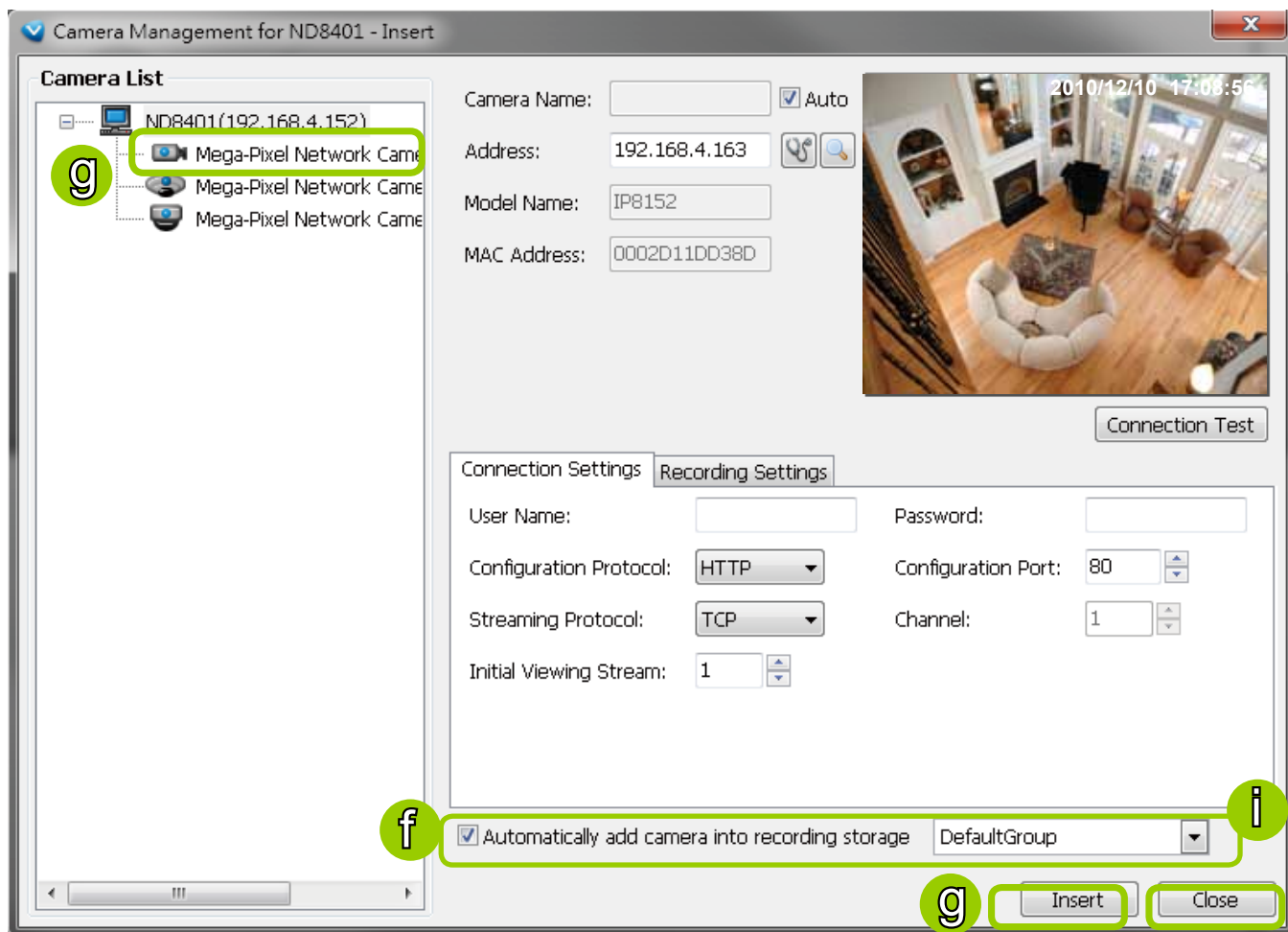

- f. The device will automatically be assigned to the default Storage Group. Deselect the item if you want to cancel this setting.
- g. When all settings are completed, click **Insert** to add the device to the station. The device will be displayed under the Camera List on the left.
- h. To insert more devices to the station, repeat the above steps.
- i. When completed, click **Close** to exit the camera management window.
- j. Return to the main window, you will find the newly-inserted devices listed under the VAST station and then you can click and drag cameras into the live cells.

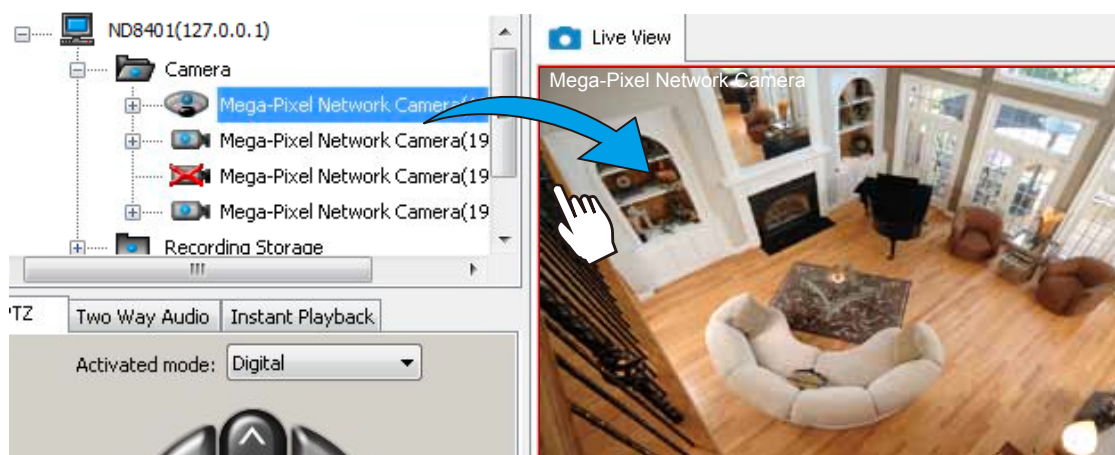

Enable SVC

If the camera to-be-added supports the latest SVC (Scalable Video Coding) feature, select the SVC checkbox to enable the related control. The SVC feature enables streaming of videos for multiple clients from one single set of layered IP packets. Designed for saving bandwidth and CPU load on client stations, the frame rate of a video stream appearing through a view cell can be individually adjusted. This feature applies when an administrator experiences unstable video streaming due to the lack of network bandwidth, less-than-ideal hardware, or during an occurrence of network problems.

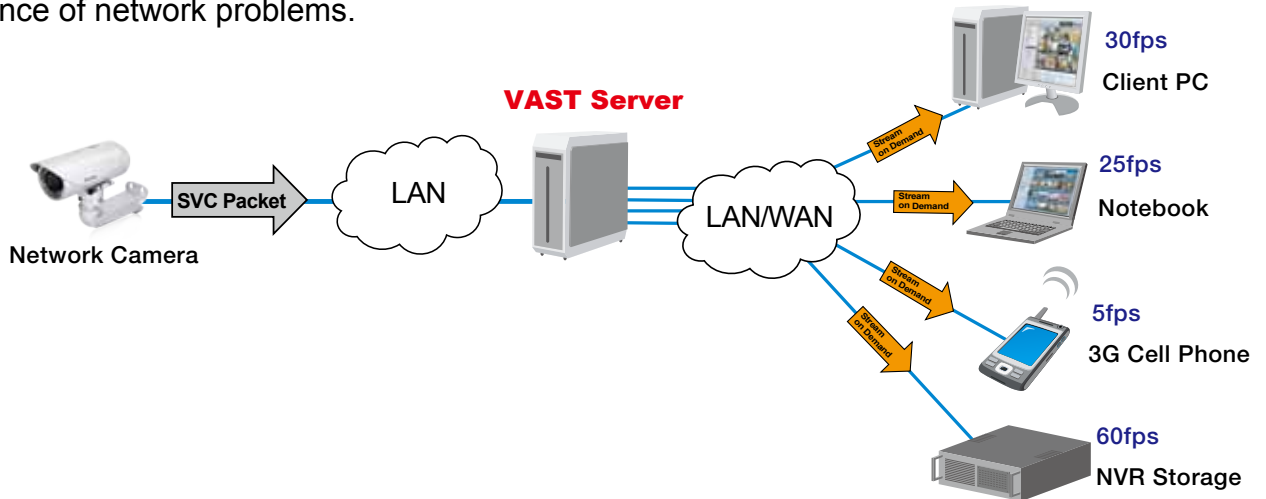

The VAST server automatically negotiates with a camera and determines whether a network camera comes with the SVC feature. The SVC checkbox appears if the network camera supports the feature. The same checkbox also appears in the Batch Insert Cameras window.

To configure the SVC-related feature:

1. When inserting a new camera into your configuration, click on the **Detect Model** button.
2. select the **Enable SVC** checkbox.

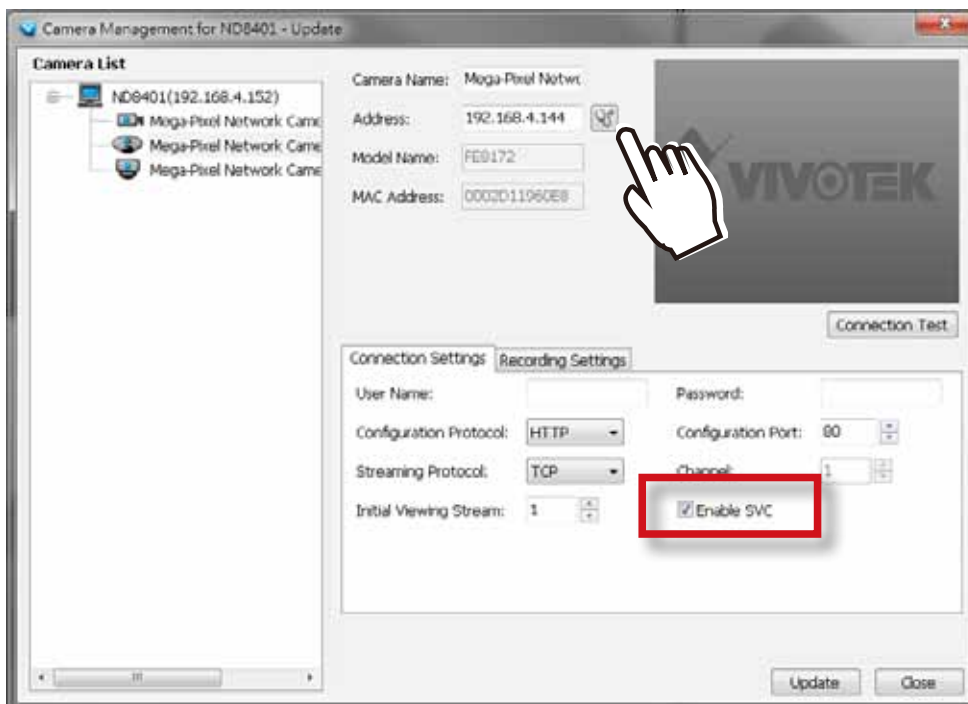

2. Right-click on the view cell of an SVC-enabled camera. Select **SVC fps adjust bar**.

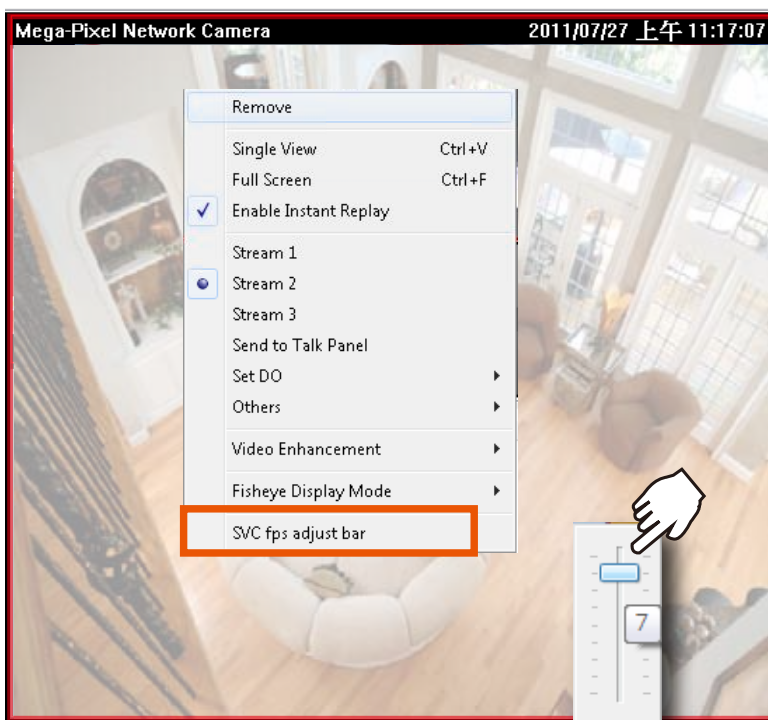

3. A slide bar will appear above the view cell. Click and drag the slide bar. A numeric indicator will display the current selection. See below for the frame rates represented by the numeric indicator.

Indicator	Frames per second (fps)
Maximum	30
7	26
6	22
5	18
4	12
3	8
2	4
1	1
Minimum	1/4



NOTE:

The SVC feature only applies to video streams using VIVOTEK's proprietary **SVC** compression format. It is not applicable to **MPEG-4** streams. Please refer to Configuration -> Media -> Video for individual stream settings.

If you have multiple SVC-enabled cameras, you can enable a collective setting via the **Adjust SVC level** button on the tool bar. The frame rate selected here will then apply to all view cells on the VAST LiveClient console.

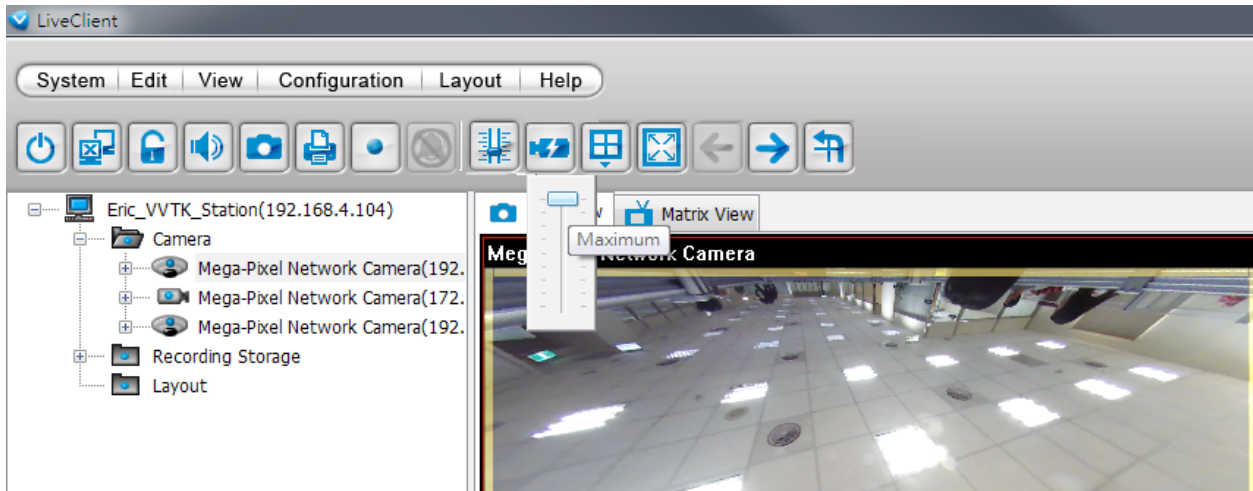

Please note that the SVC related setting can not take effect while the LiveClient station is running the Layout Rotation. Stop the layout rotation before configuring the SVC function.

NOTE:

*While you save your bandwidth for live viewing, you can still record full-frame-rate video by changing the recording setting. For example, you can enable resource-saving SVC on stream #1 and configure stream #2 to be recorded with full details, in terms of frame size, frame rate, and video quality. Please note that you should use the **Constant Bit Rate** methodology to limit the size of recording stream to 6Mb per second.*

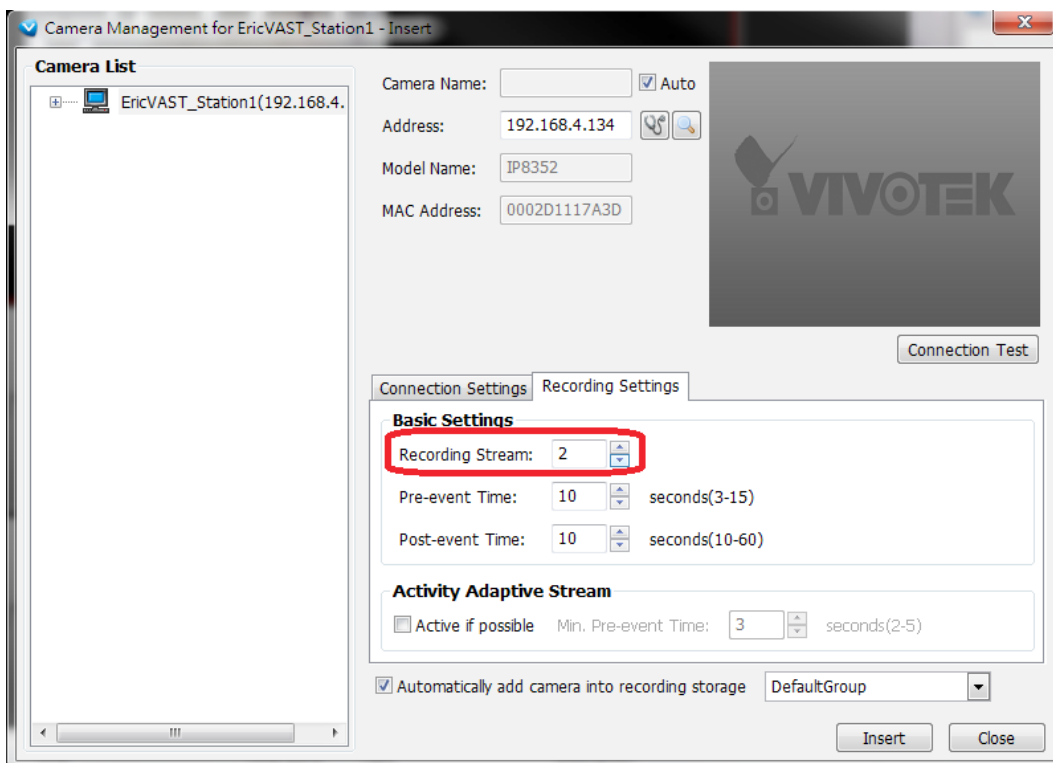

Update Devices

Please follow the steps below to update a device via Camera Management window:

- Click **Configuration > Camera Management > Update Camera** on the menu bar (or **right-click** the device/station, then select **Camera Management > Update Camera**).
- The **Camera Management - Update** window will pop up. The device tree managed by the station will be displayed in the Camera List on the left.
- Select a device from the list you want to update. Its related information will automatically be displayed in the corresponding fields in the Camera Management window. Then you can modify **Connection Settings** and **Recording Settings** of the device.
- After modifying the settings, you can click **Connection Test** to preview the live video from the device.
- When all settings are completed, click **Update** to enable the settings.

The image shows a sequence of steps to update a camera device in the VIVOTEK software. Step (a) shows a right-click context menu over a camera device in the 'Camera List' tree, with 'Update Camera...' highlighted. Step (b) shows the 'Camera Management for ND8401 - Update' window. Step (c) shows a device selected in the 'Camera List'. Step (d) shows the 'Connection Test' button. Step (e) shows the 'Update' button.

Camera List

- ND8401(127.0.0.1)
 - Camera
 - Mega-Pixel Network Camera
 - Mega-Pixel Network Camera
 - Mega-Pixel Network Camera
 - Mega-Pixel Network Camera
 - Recording Storage

Camera Management for ND8401 - Update

Camera Name: Mega-Pixel Network
 Address: 192.168.4.165
 Model Name: FE8172
 MAC Address: 0002D11960E8

Connection Settings

User Name: Password:
 Configuration Protocol: HTTP Configuration Port: 80
 Streaming Protocol: TCP Channel: 1
 Initial Viewing Stream: 1 Enable SVC

Update **Close**

Delete Devices from the Station

■ Delete a device:

Right-click the device on the device tree, then select **Delete**. A dialog box will pop up. Click **Yes** to delete the device along with the recorded data; click **No** to delete the device but retain the recorded data; click **Cancel** to cancel the delete action.

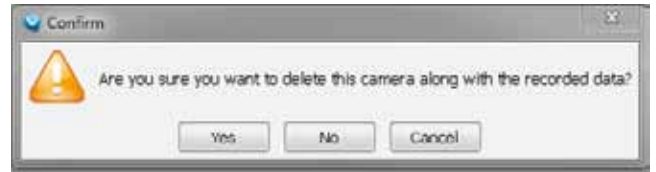
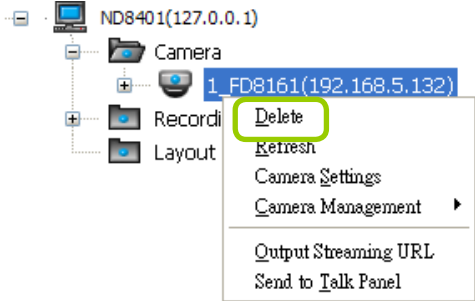

■ Delete more than one device at a time:

- Click **Configuration > Camera Management > Delete Cameras** on the menu bar (or **right-click** the device/station, then select **Camera Management > Delete Cameras**).
- The **Delete Cameras** window will pop up.
- Select the devices you want to delete from the list, then click **Delete**.
- A dialog box will pop up. Click **Yes** to delete the device along with the recorded data; click **No** to delete the device but retain the recorded data; click **Cancel** to cancel the delete action.
- When completed, click **Close** to exit the **Delete Cameras** window and return to the main window. The deleted device will disappear from the station.

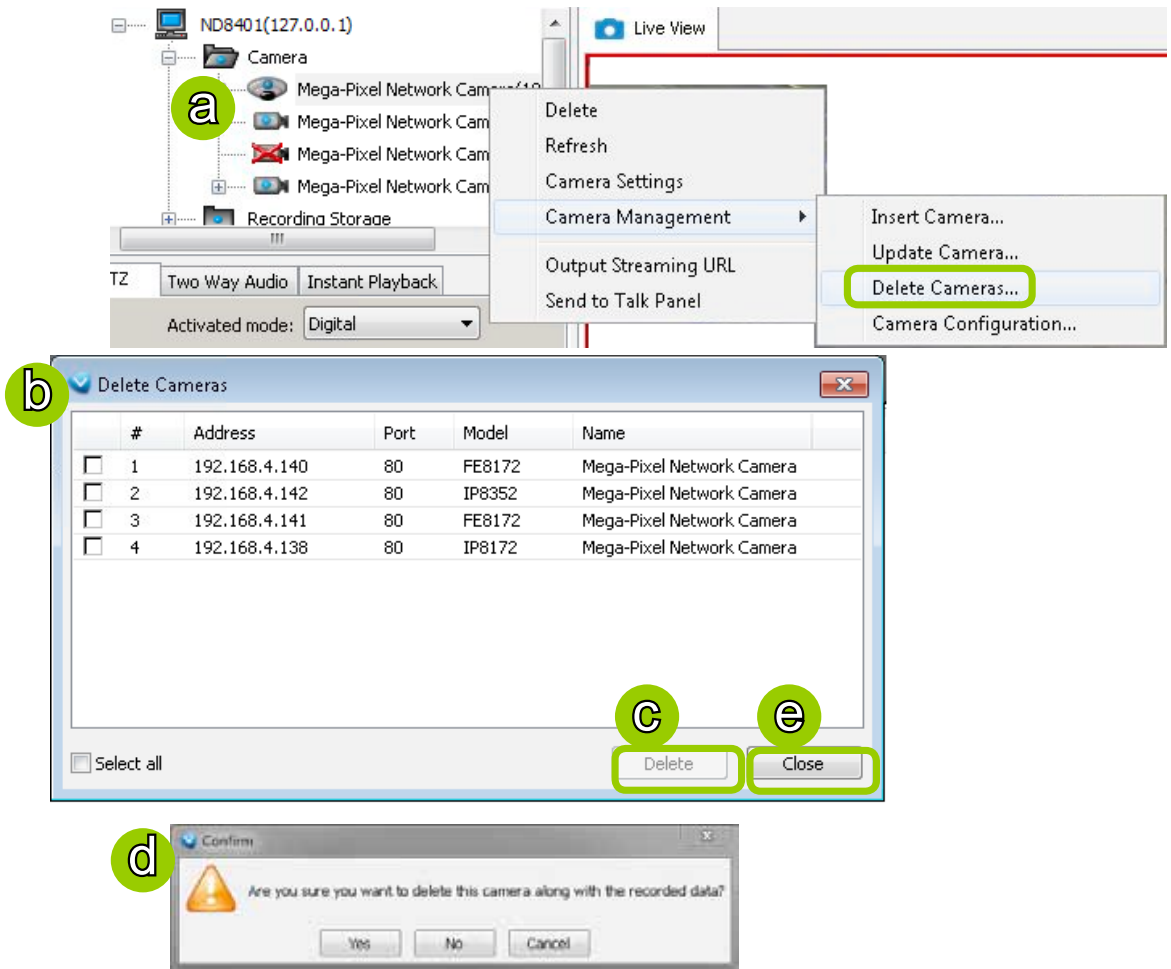

Batch Insert Cameras

Batch insert is a very useful function that allows user to search, filter, and import a row of devices that are in the same LAN to an NVR station. Basic settings can also be applied to those inserted devices simultaneously.

Please follow the steps below to batch insert devices to the station:

- Click **Configuration > Camera Management > Batch Insert Cameras** on the menu bar (or **right-click** the station, then select **Camera Management > Batch Insert Camera**).
- The **Batch Insert Cameras** window will pop up. Then click **Search** to open the Search Camera window.
- On top of the Camera List window, you can select "List the cameras which are not inserted" or "List all cameras". The items listed below will then change accordingly.
- Use the 4 Filters to narrow down the range of the wanted cameras from the list.
 - IP Range: Key in a range of IP address to narrow down the list; the filter automatically applies after you fill in a correct IP range.

Batch Insert Cameras

Instruction

Search button -> Import into List -> Edit Connection Settings -> Insert button
Specify Address button -> Edit Recording Settings -> Edit Video Settings

#	Name	Address	Port	Model	MAC	Status

Search Cameras

List the cameras which are not inserted
 List all cameras

Filters

Set following filters to narrow down the range of searched cameras.

Address Range: 192.168.4.1 ~ 192.168.4.254
 Address with prefix:
 Model with prefix:
 MAC with prefix:

#	Address	Port	Model	MAC
<input type="checkbox"/> 1	192.168.4.115	80	IP8362	00-02-D1-17-12-F4
<input type="checkbox"/> 2	192.168.4.163	80	IP8152	00-02-D1-1D-D3-8D
<input type="checkbox"/> 3	192.168.4.117	80	FD8161	00-02-D1-1A-A9-AD
<input type="checkbox"/> 4	192.168.4.146	80	PD8136	00-AB-CD-AB-CD-EF
<input type="checkbox"/> 5	192.168.4.142	80	IP8362	00-02-D1-17-12-F3

Select All

Recording Storage

Add the cameras to the recording storage:
DefaultGroup (2/256 CH)

Insert Close

- IP with prefix: Key in in the prefix of the IP address to narrow down the list.

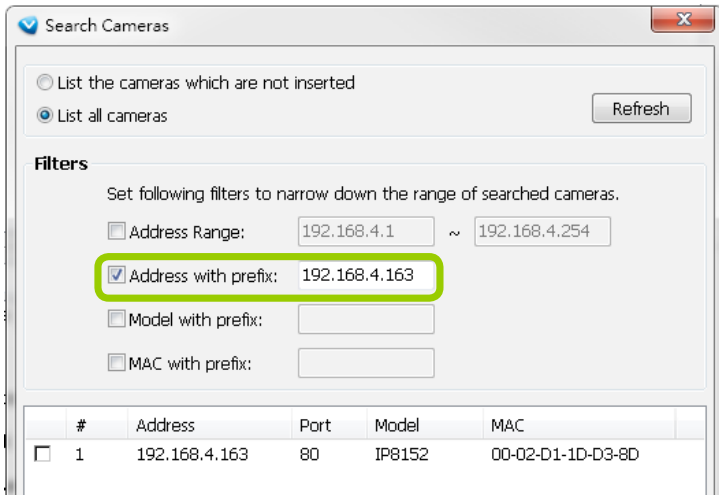

- Model with prefix: The user can type in the prefix of the model name or the complete model name of the cameras to narrow down the list.

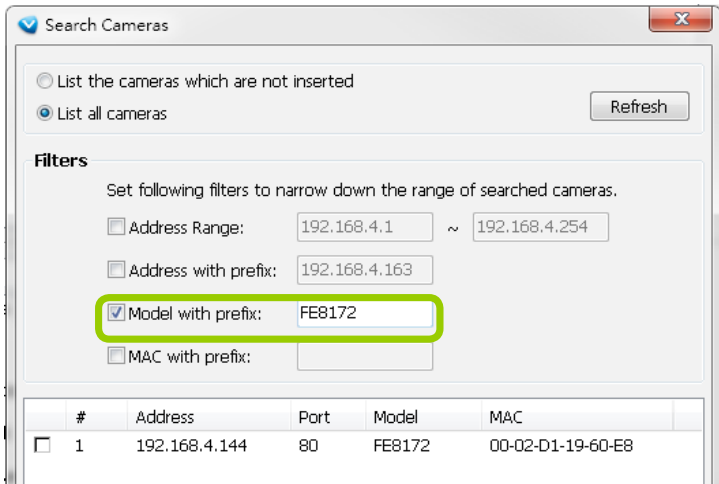

- MAC with prefix: You can type in the prefix of the MAC address of the cameras to narrow down the list.

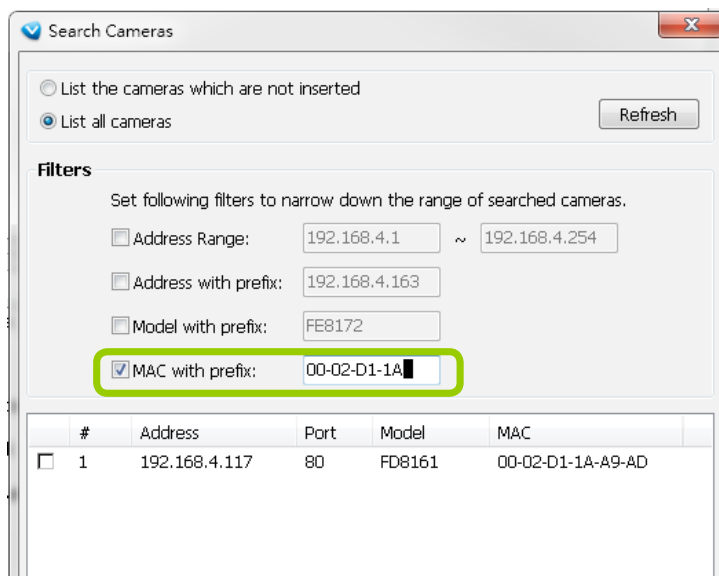

e. When the list is filtered, you can select the cameras one by one or check **Select All** to add them to the batch insert list. Then click **OK** to finish searching.

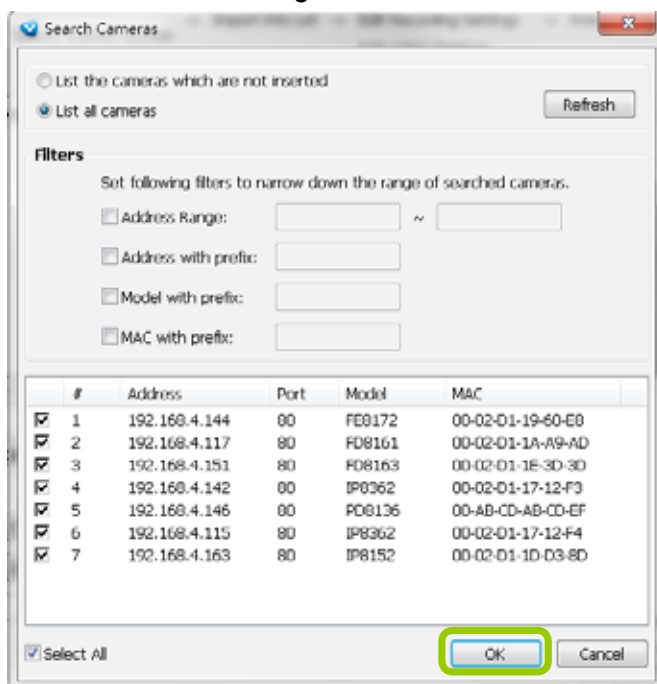

f. The selected cameras will be shown on the batch insert camera list with the camera information and the connection status. When you click on a camera, a snapshot will appear up on the right side for you to identify the cameras on the list. If you want to remove a camera from the list, click the trash can icon to delete it.

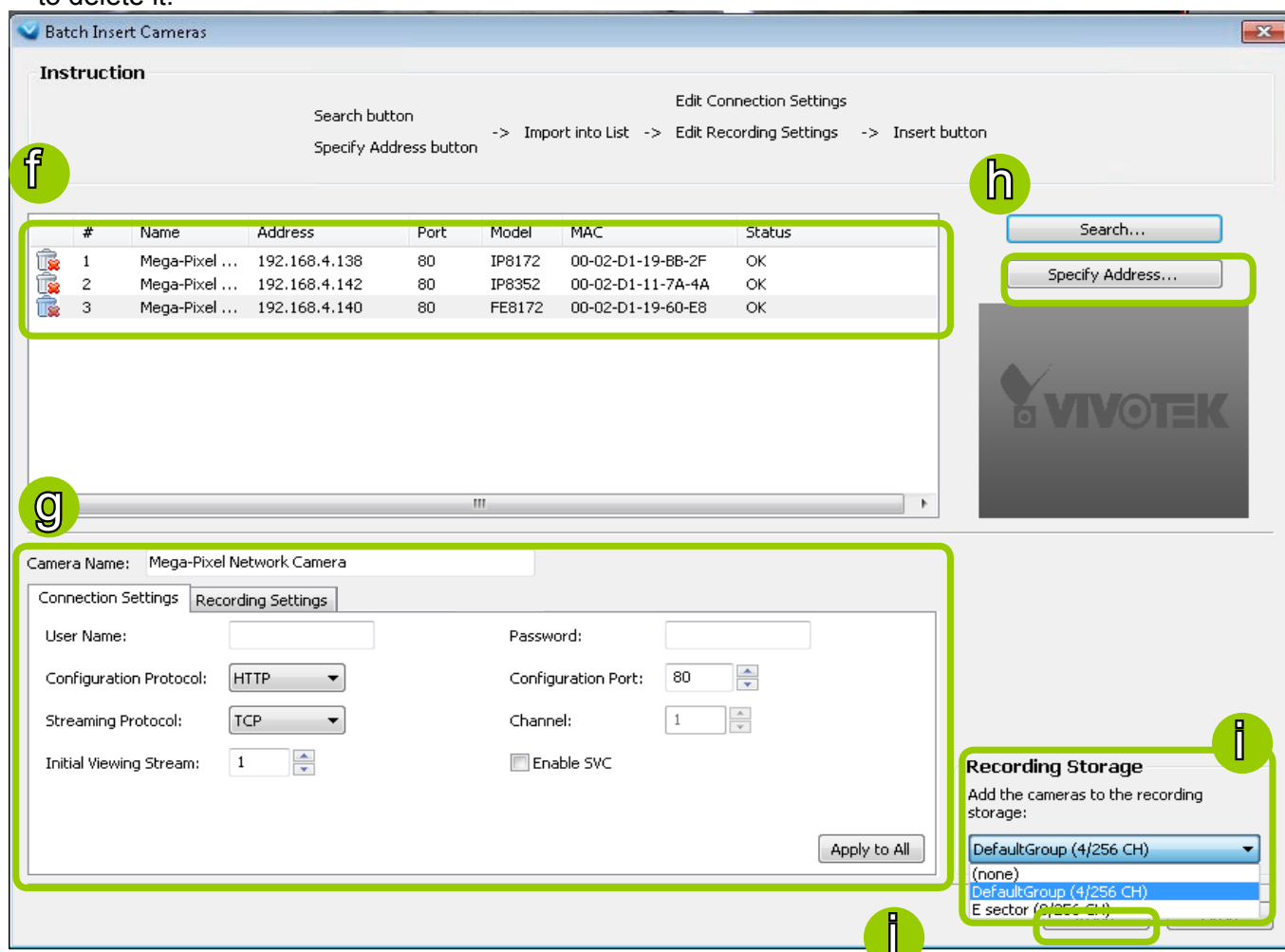

g. At the bottom of the window, there is a field for you to alter the camera settings including Connection Settings and Recording Settings. You can apply the new settings to each camera on the list, or click **Apply to All** to apply the same configurations to all the cameras. For more information about Connection Settings and Recording Settings, please refer to Insert Device on page 36 for detailed information.

h. Specify host: If you want to add a camera to the list, click **Specify Address** to directly add a wanted camera. Click **Add** after filling in the correct information. The camera will be added to the list of the Batch Insert Camera window.

i. By default, all inserted devices will be applied to the default recording storage. Deselect the **Add** checkbox if you do not want to assign the selected devices to the default recording storage.

j. Click **Insert** when all the settings are done. Cameras will be added.

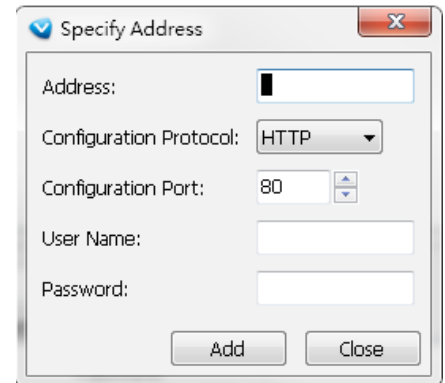

NOTE:

When you modify the camera settings, and when the connection information (Configuration Protocol and Configuration Port) does not match the current network environment, the camera will be disconnected and the status of the camera will become "Camera cannot be found" as shown below.

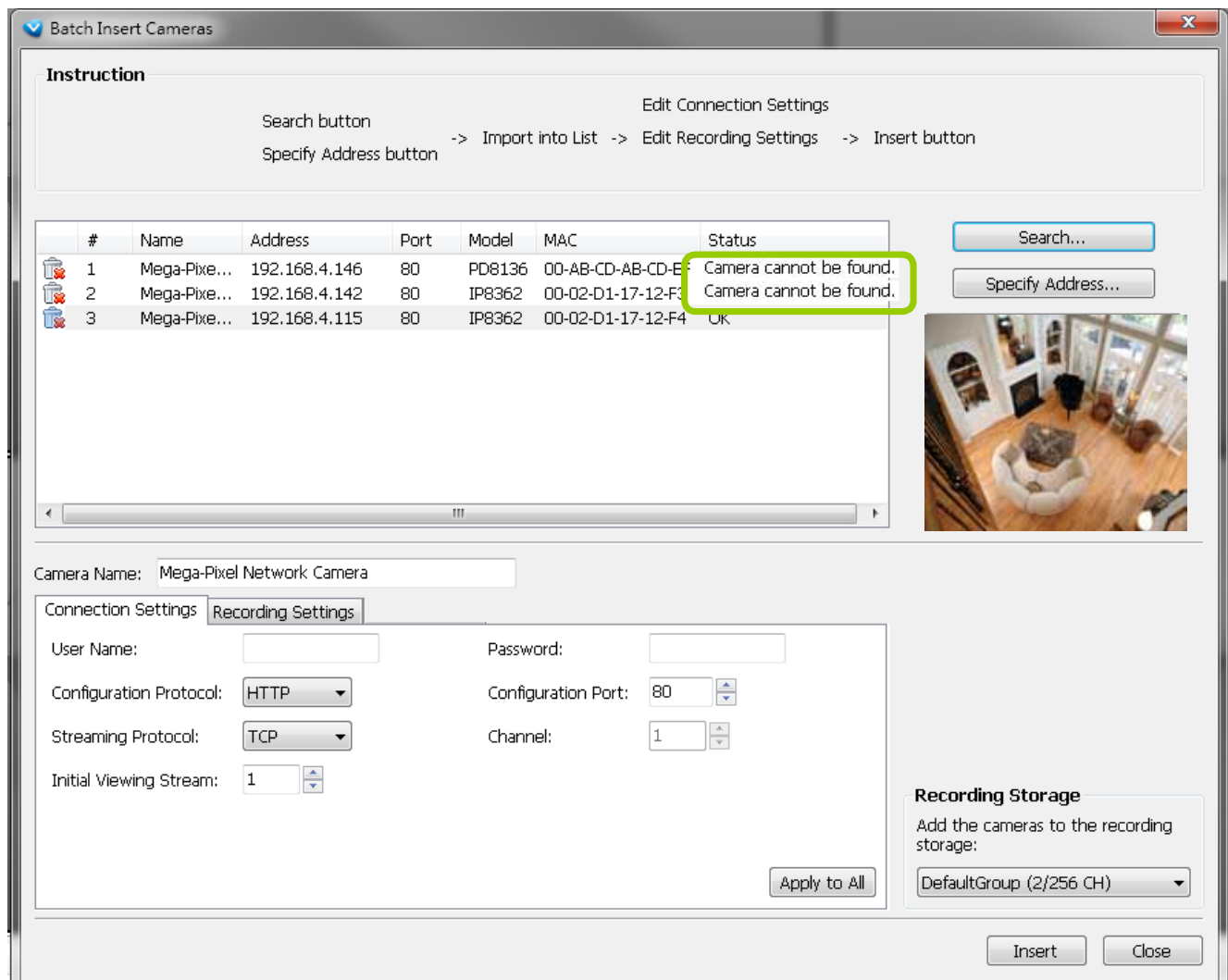

Camera Configuration

The **Camera Configuration** function group provides immediate access to the video streaming and other settings without the need to open a web console. The function group is accessed by selecting a camera on the device tree, and right-click to select **Camera Management > Camera Configuration**.

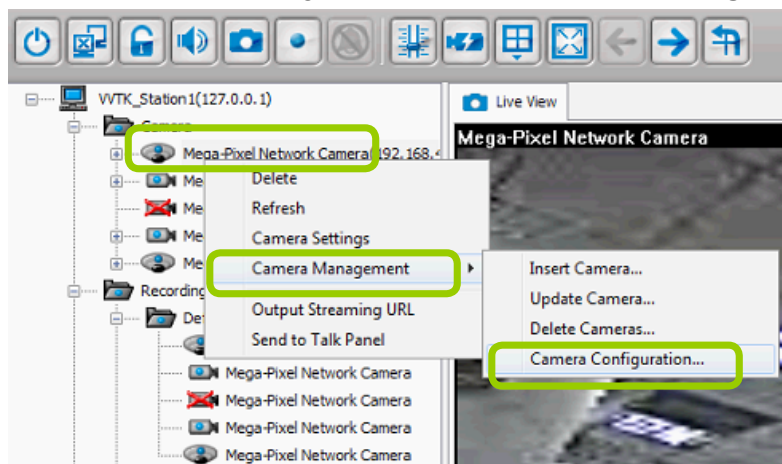

■ FOV (Field of View)

The FOV configuration is available for 5 megapixel cameras (such as FE8172, IP8372, and IP8172P), which allows you to crop a portion of the image captured by the sensor. The FOV setting applies in the scenario where you do not need all of the video a camera can capture. For example, when shooting a parking lot where the upper half of the image is the sky. Cropping a field of view can help save bandwidth and reduce the requirements for storage space.

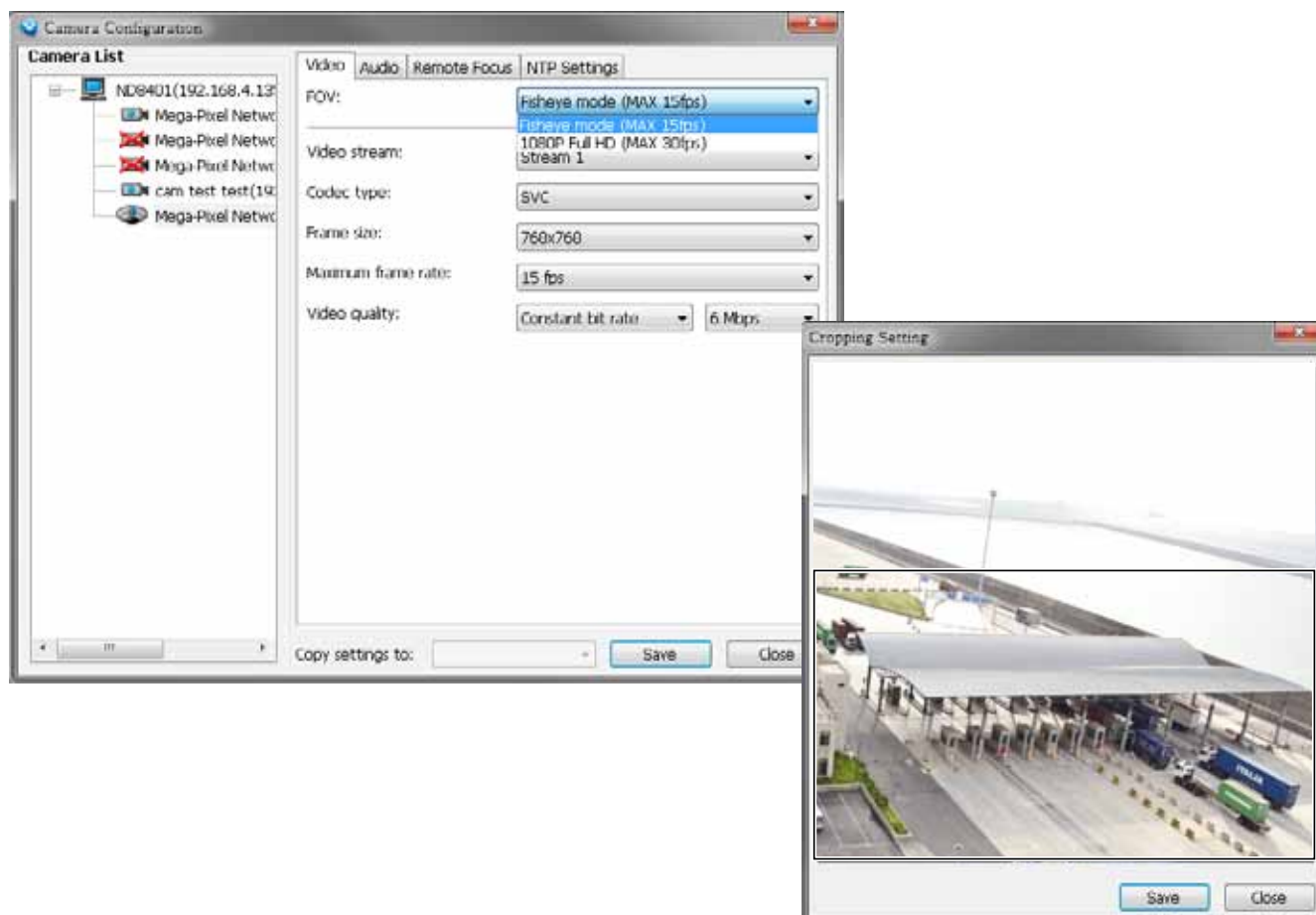

■ Video

This tabbed window provides access to the selection of the live view stream, its compression codec, frame size, max. frame rate, and video quality. Note that the **Constant Bit Rate** methodology can be used to ensure that the size of video stream does not exceed a preferred threshold, regardless of the complexity or the changes of pixels in the image. You should use a maximum of 1080P as **frame size** and 6Mbps as **constant bit rate** for video streams managed by this system.

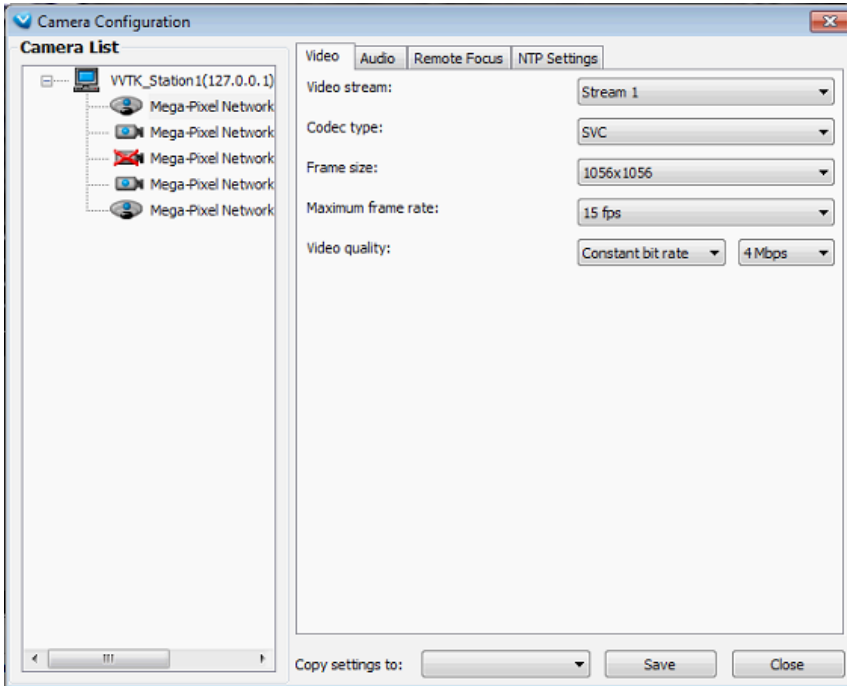

■ Audio

If audio feed is preferred, configure the audio codec type and operating mode in here.

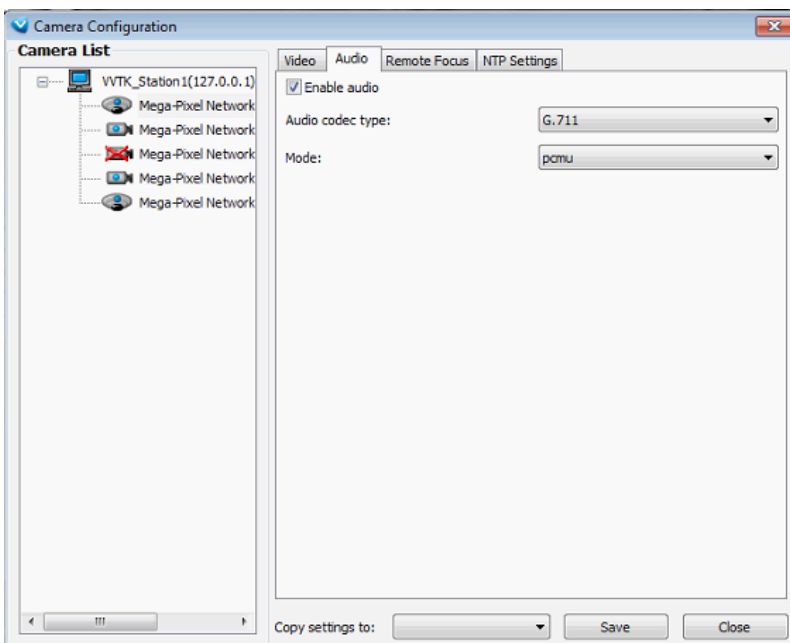

■ Remote Focus

For cameras supporting the remote focus feature, such as the FD8362E that comes with a motorized lens, this window provides finetune buttons and full-range scan function to help reach the best image focus.

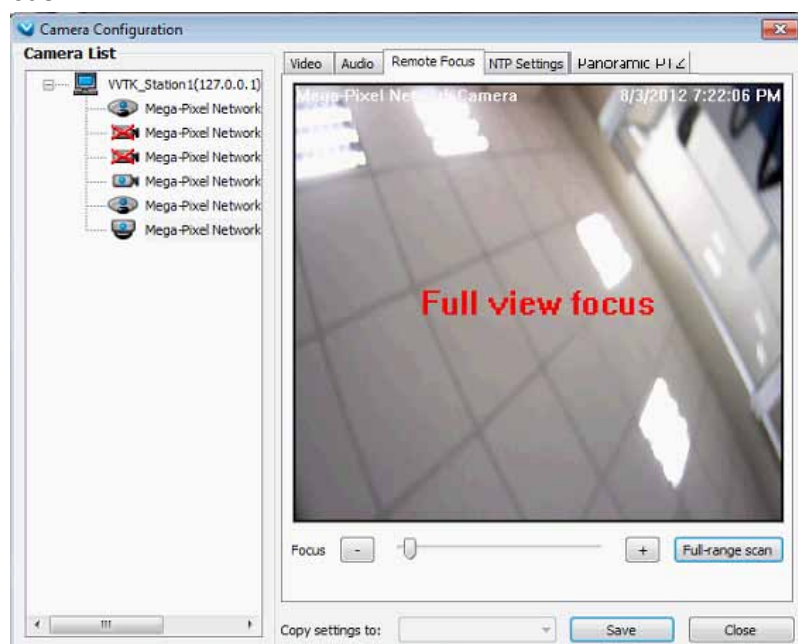

■ NTP Settings

If cameras' real time clocks are set to be synchronized with a time server, enter the NTP server's address or domain name and specify an Updating interval. If you select the "Synchronize camera time with system automatically" checkbox during the initial setup, the NTP server IP will be the NVR's IP.

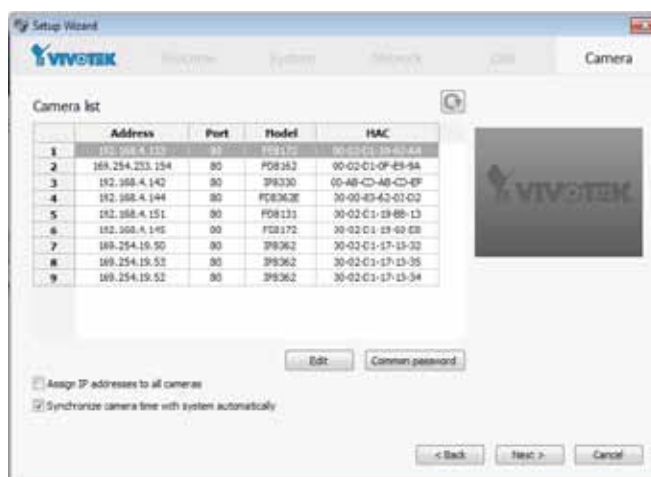
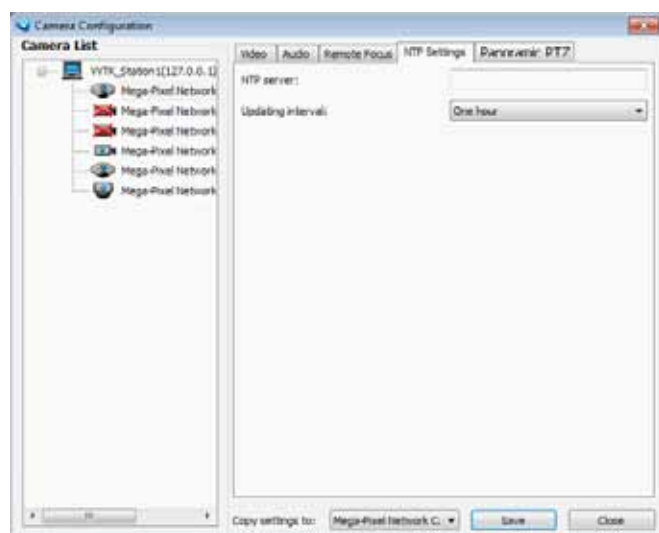

Always remember to **Save** your configuration before leaving this window. You can also use the "Copy settings to" button below to duplicate your current settings to adjacent cameras.

View Live Videos

You should **double-click** on the target device or **drag-and-drop** the target device from the hierarchical management tree window to a video cell.

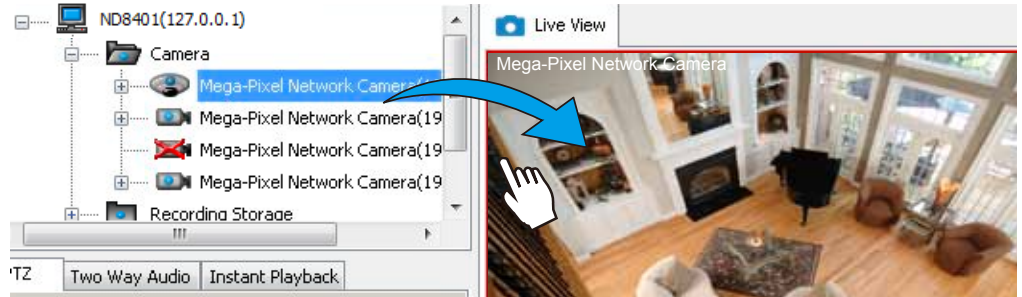

Dual / Multiple Streams

For multiple-stream devices, you can **right-click** on the focused view cell to select a stream. The NVR system automatically selects a video stream depending on the size of the current layout and view window. Normally it is not necessary to change the video stream.

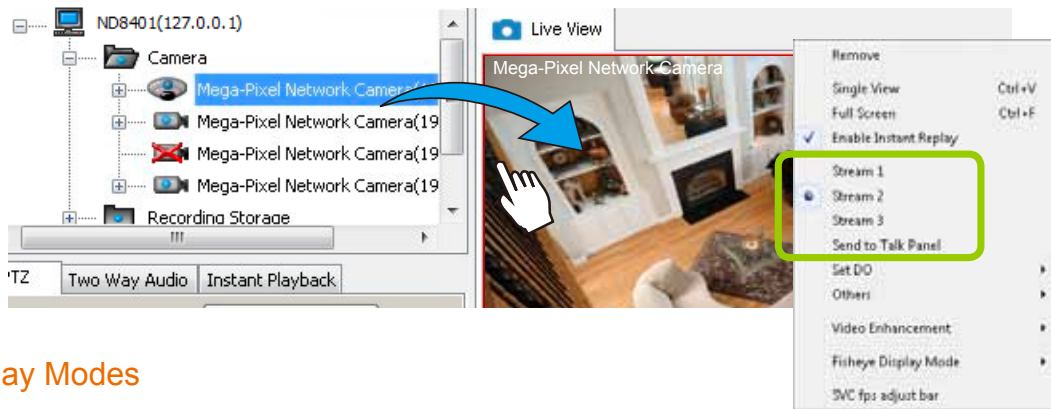

Fisheye Display Modes

By default, a round view is displayed when a fisheye camera is successfully connected. To display Regional, Panoramic, or the combination of different views, **right-click** on a fisheye camera's live view to display the associated commands. The display modes available are: 1O (Original), 1P (Panoramic), 1R (Regional), 2P (2 Panoramic), 1O3R (1 Original & 3 Regional), 1P3R (1 Panoramic & 3 Regional), 4R (Quad Regional), 1O8R (1 Original & 8 Regional), and 4R Pro (4 Proactive) modes.

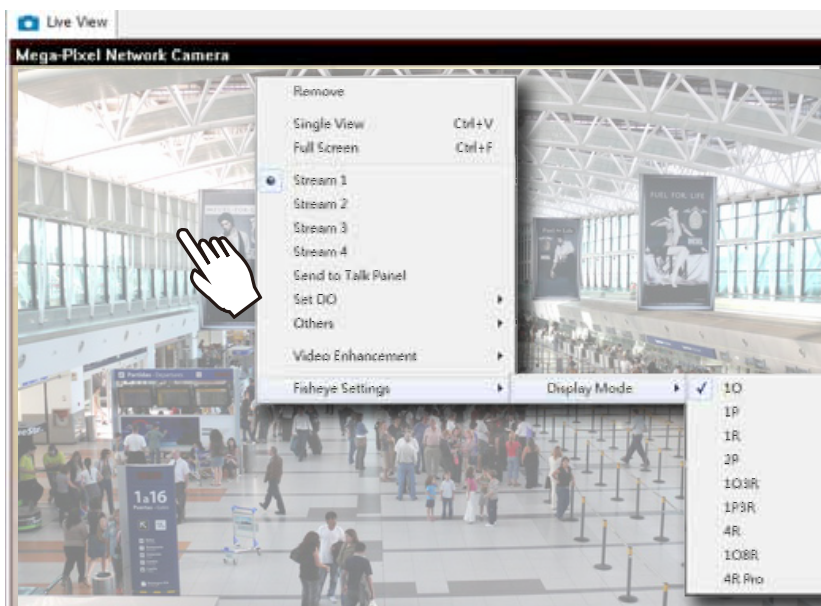

Fisheye Display Modes: below are conceptual drawings for different display modes.

1O (Single Original) Display mode:

An **Original** oval view covers the hemisphere taken by the fisheye lens.

1O View (Original View)

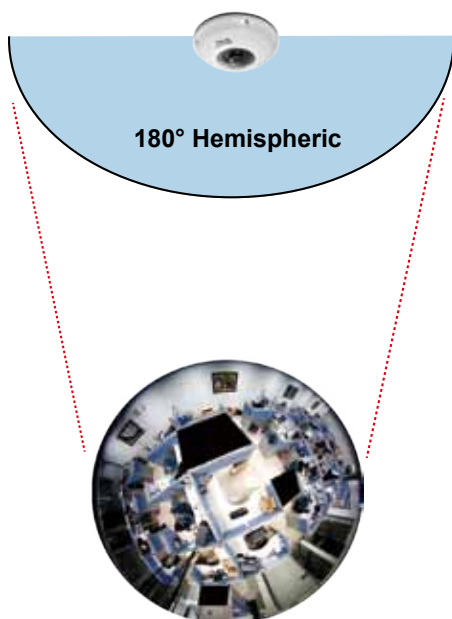

1R (Single Regional) Display mode:

A **Regional** view crops a portion of the hemisphere as a region of interest. You can zoom in or out or move the view area elsewhere from on the regional view.

1R View (Single Regional View)

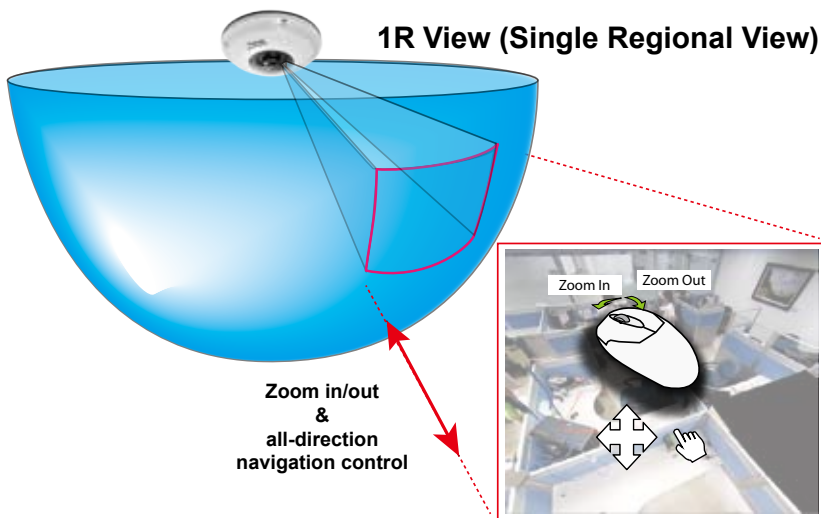

A Regional view is dewarped, by correcting images from the distorted oval view to a rectangular and visually proportional image.

1P (Single Panoramic) Display mode:

With image correction algorithms in firmware, the hemispheric image is transformed into a rectilinear stripe in the 1P display mode. Viewers can use the PTZ panel or simply use mouse control to quickly move through the 360° panoramic view.

Note that the 1P view is apt for an overview, the Zoom in/out function does not apply in this mode.

1P (Panoramic) Mode Screen Control



2P (2 Panoramic) Display mode:

Two dewarped rectangular views are placed one on top of another each showing 180 degree of panoramic view. The 2P view looks like the upper view shows the front of hemisphere, and the lower view the rear half of the hemisphere.

2P (Panoramic) Mode Screen Control



1O3R (One Original & 3 Regional) Display mode:

Fisheye cameras also support the display of multiple regional views taken from within the same hemisphere, and they can be displayed with or without an Original view in its view cell.

3R View (Regional View)

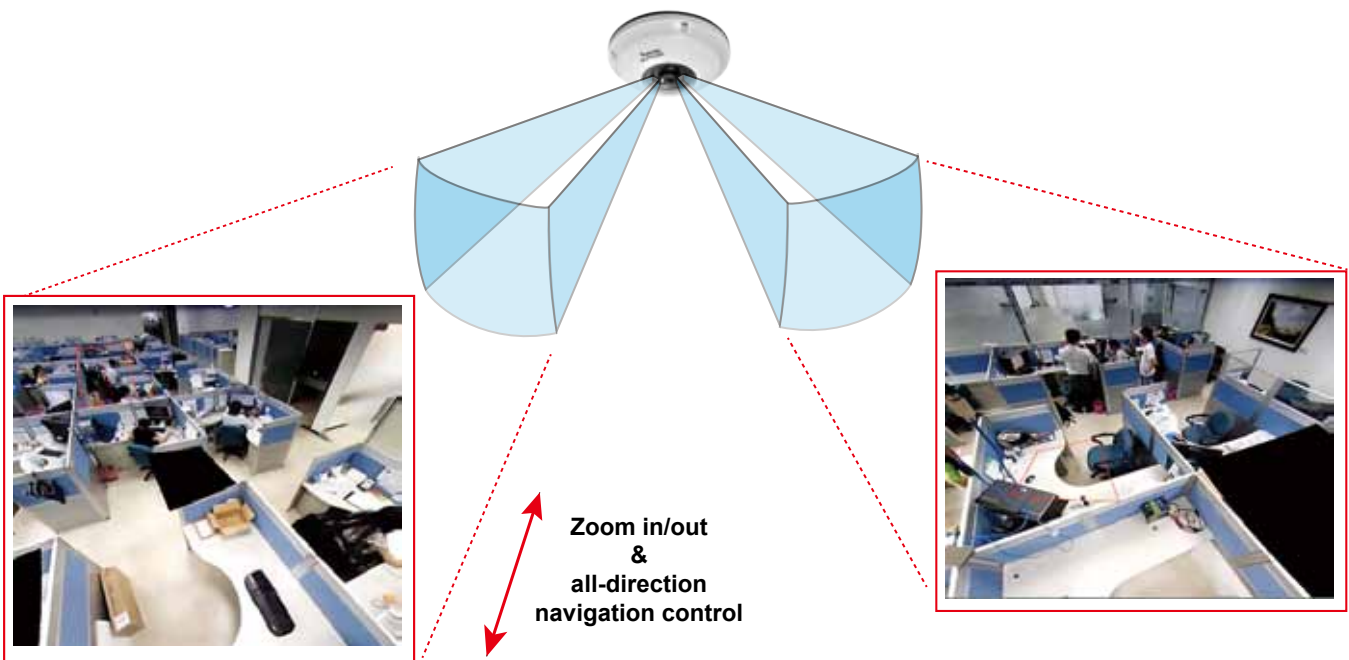

* Only two regional views are shown for simplicity reason

PTZ Mouse Control

The "Mount type" setting also determines the display modes available to your fisheye cameras. Please refer to fisheye camera's User Manual for more information.

A highly versatile mouse control is implemented with fisheye cameras. The same control takes effect on a browser management session, on the LiveClient utility, and even on a video playback screen. See the drawing below for how it works.

You can click and hold down the left mouse button to quickly swipe through the field of view, change the view angle, or use the mouse wheel to zoom in/out on a region of interest. However, the PTZ mouse control is only available in the "**R**" (**Regional**) mode. In the **Panoramic mode**, you can only scroll horizontally across the 180° or 360° panoramic view.

103R (Original & Regional) Mode Screen Control

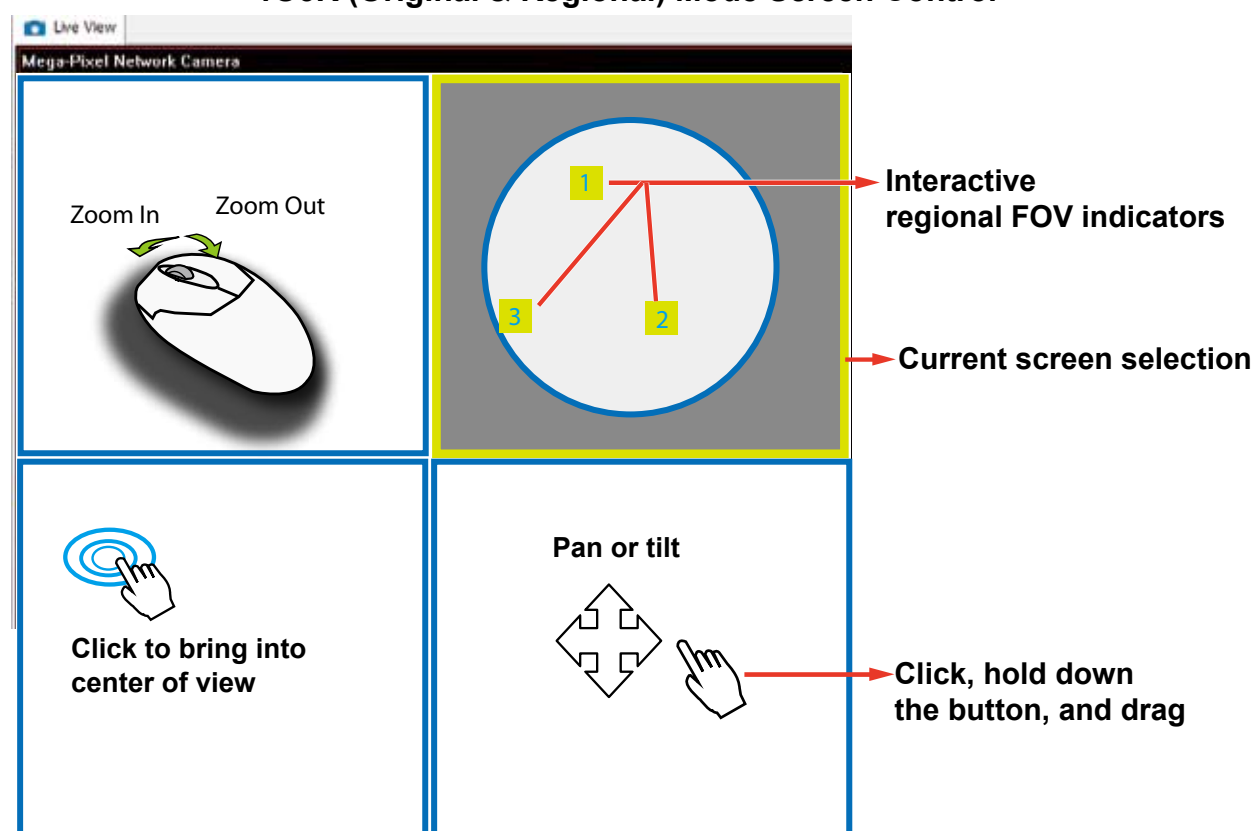

NOTE:

The various display modes require the support of D3D technologies by your display card. Most off-the-shelf display cards today support this feature.

The onscreen mouse control is very agile. Therefore, use the PTZ panel for more delicate moves in a field of view. **Pan** and **Patrol** moves are also supported if you have configured preset PTZ positions in the camera's firmware. Note that the Pan move takes place in the Panoramic and Regional views, while the Patrol function through preset positions applies only in the Regional views.

Below are the conceptual drawings for other display modes:

1P3R (One Panoramic & 3 Regional) Display mode:

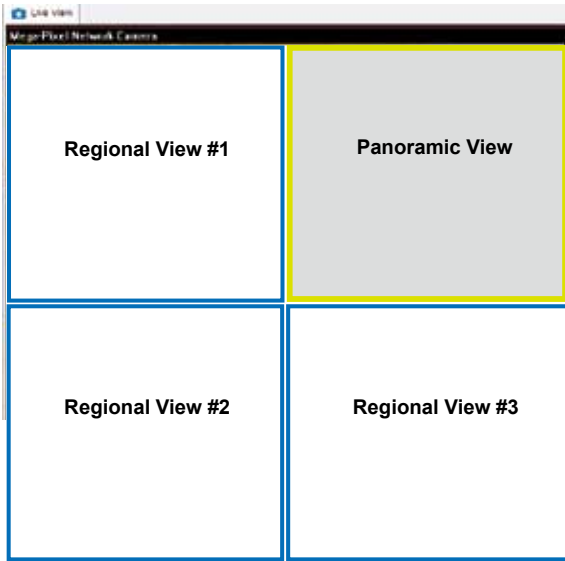

4R (Quad Regional) Display mode:

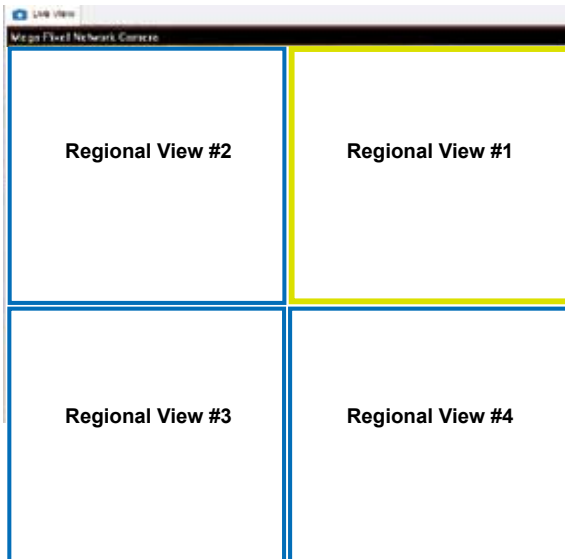

4RPro (4 Regional Proactive) Display mode:

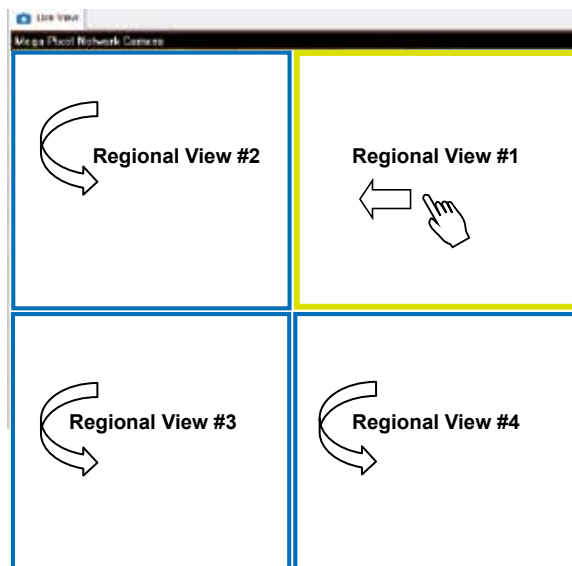

1O8R (One Original & 8 Regional) Display mode:

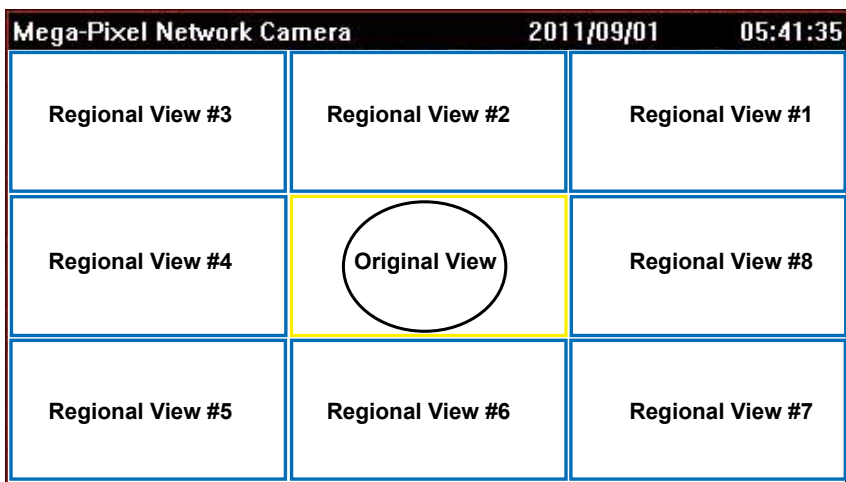

NOTE:

For Fisheye video playback and recording concerns, refer to page 131 and page 167.

Refresh

Right-click the device, then click **Refresh**, the camera information will be refreshed from the server.

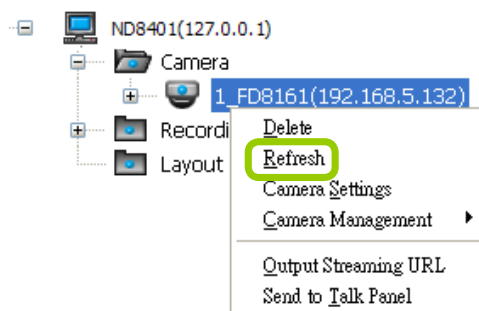

Streaming Server

Right-click the station or the device and click **Output Streaming URL**. A .txt file with streaming URL will pop up. Then you can use this URL to link to the live streaming through QuickTime Player.

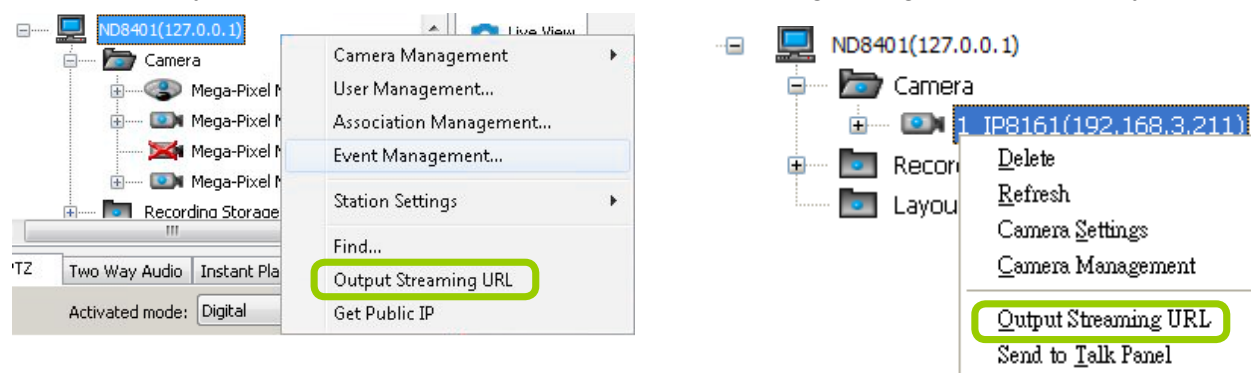

Get Public IP

If your access to Internet is via PPPoE, this function will display the public IP provided by your service provider. If your access to Internet is via a router, please consult your network administrator or consult your ISP for a valid public IP.

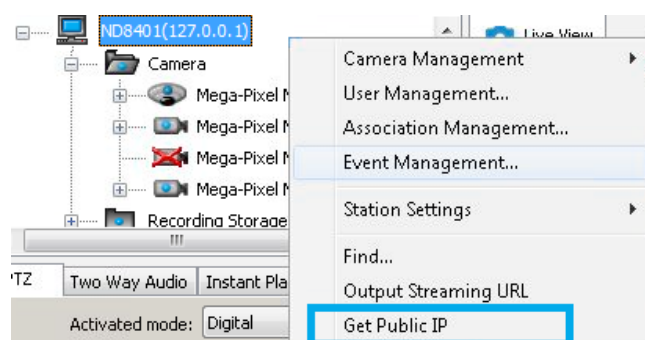

Camera Settings

Right-click the device, then click **Camera Settings** to open a browser's session to the camera.

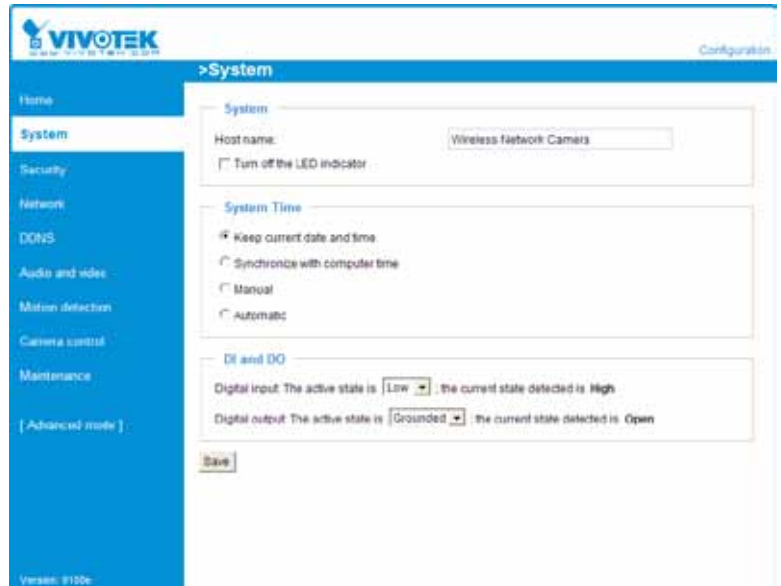
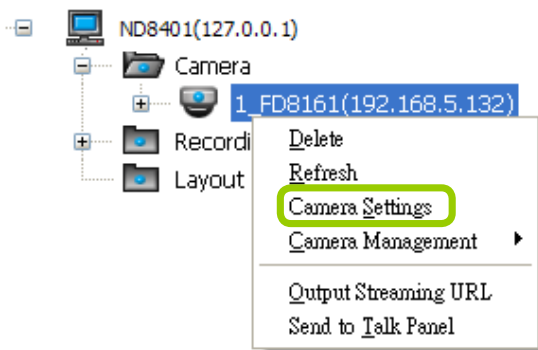

Remove Live Video from the Video Monitoring Window

There are two ways to remove a live video from the video cell:

Method 1. **Right-click** the video cell and select **Remove**.

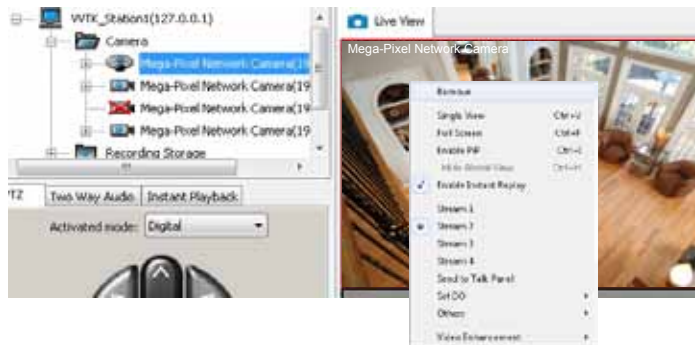

Method 2. **Drag-and-drop** the live view from the video cell to the hierarchical management tree window.

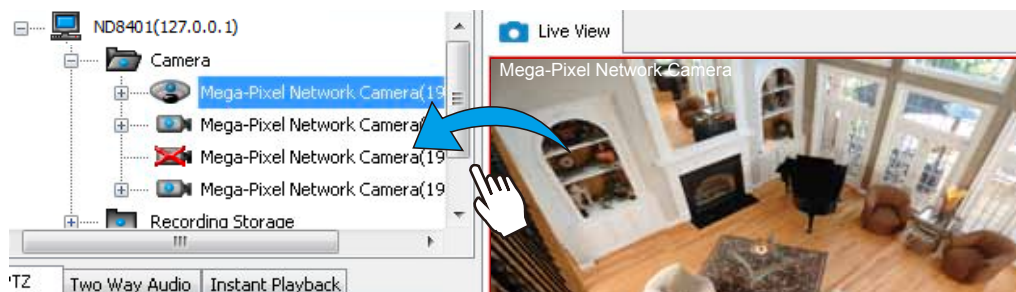

NOTE:

If you want to remove all live videos from the video cells, please click  on the menu bar.



How to Change the VAST LiveClient Layout

Changing the Layout of the Live Video Monitoring Window

The NVR's LiveClient supports up to 16 simultaneous video viewing on a single monitor and allows you to change the layout of the live video monitoring window based on the number of inserted devices.

Switch Video Channels

To move a video channel to another empty video cell, **drag-and-drop** the view to the target video cell.





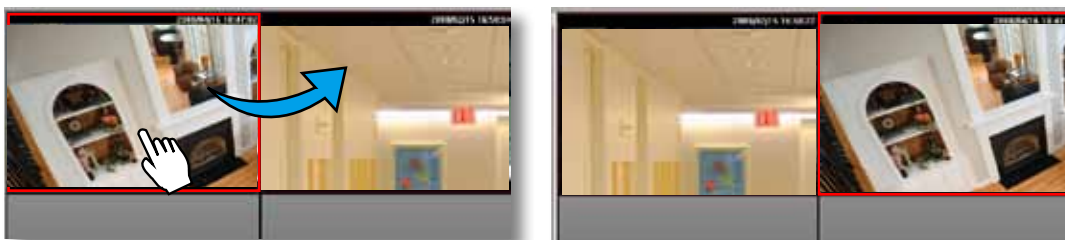



To switch two different channels, **drag-and-drop** one view to the other, then the two different channels will be switched to the opposite.



Configure Layout Mode



Click the **Layout** button  on the quick access bar. Select a desired layout mode, and the layout window will change accordingly. Below we illustrate 6 types of layout modes and the corresponding page numbers:



Layout mode	Description	Video page
1 x 1		32
2 x 2		8
1 + 5		4
3 x 3		3
1 + 12		2
4 x 4		2

More than 1 video page;
rotation function is enabled

Some layout modes (1 x 1, 2 x 2, 1 + 5, 3 x 3, 1 + 12, 4 x 4) will spread the view cells of video channels over several pages.



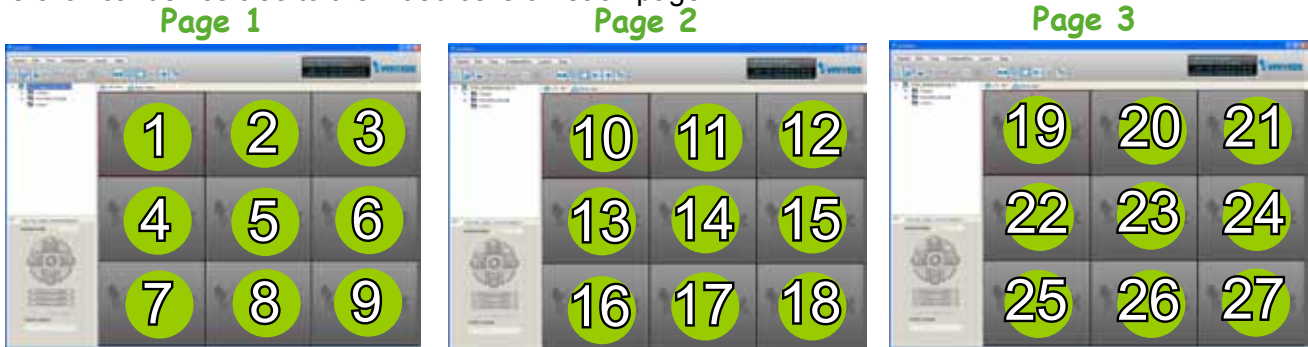

For example, under the 3 x 3 layout mode, you can switch among the pages by clicking  and  on the quick access bar. To arrange the content of each page, manually **drag-and-drop** cameras from the hierarchical device tree to the video cells on each page.



Rotating Video Pages



For layout modes that contain more than one page, the LiveClient offers the rotating function for displaying all video pages in turn.

- To enable this function, click  on the Quick Access Bar, which will become  **Stop Rotating**, and the video pages will start to rotate so that the user does not have to click  to move to the next page.
- To disable this function, click  **Stop Rotating**, which will become  on the Quick Access Bar.

You can also click **Layout > Start to Rotate/Stop Rotating** to enable/disable this function.

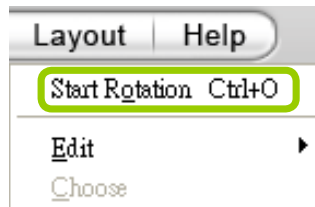

The default rotating time interval is 6 seconds. If you want to edit rotation settings, please refer to **Rotation Settings** on page 134.

Edit Layout

Please follow the steps below to save a layout:

- Arrange a layout mode and drag devices to their desired video cells.
- Click **Layout > Edit > Save to > New** on the menu bar. A **Layout Name** dialog box will pop up.

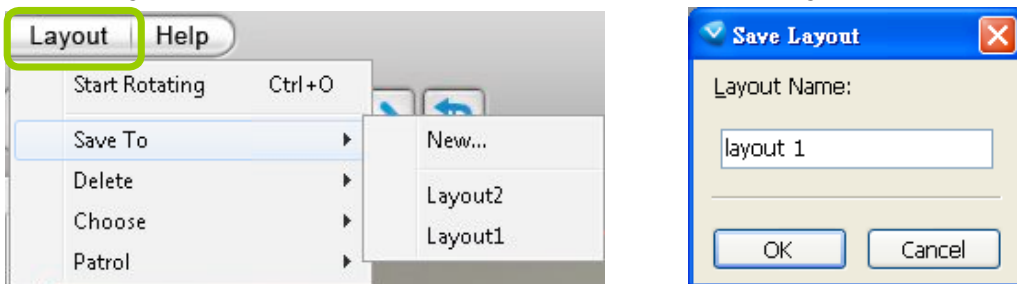

- Enter a name for the the layout, then click **OK** to enable the setting.

- d. Back to the monitoring window, the new layout will appear under the device tree as shown below. You can save up to 10 layouts.
- e. To change to another layout, **double-click** the layout options on the hierarchical management tree, or click **Layout > Choose** on the menu bar to select a desired layout.

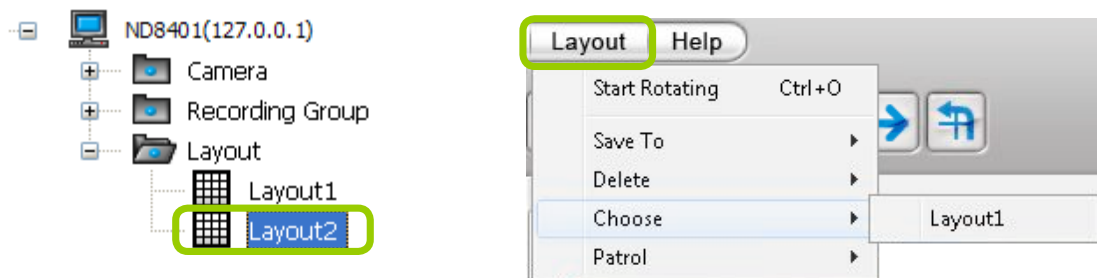

- If you want to edit an existing layout, arrange a layout mode and drag devices to the desired video cells, then click **Layout > Edit > Save to > New** to save as a new layout or an **existing layout** to replace with the new one.

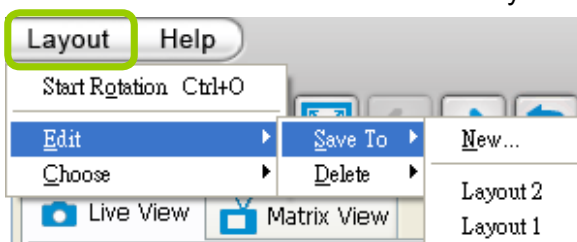

- If you want to delete an existing layout, **right-click** the layout item on the hierarchical management tree or click **Layout > Edit > Delete** on the menu bar to delete it.

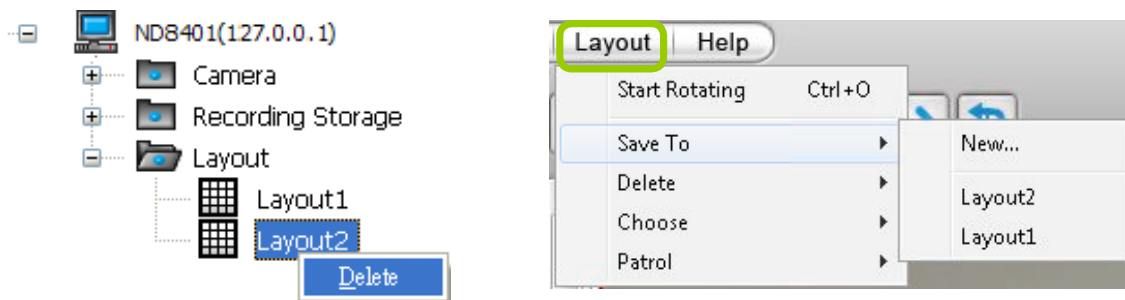

NOTE:

Whenever you close the LiveClient or Playback programs and changes in screen layout have been made, you will be prompted to save your current configuration.

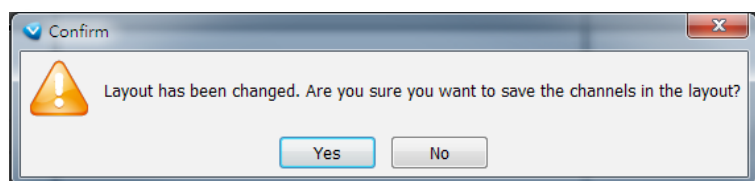

Maximize the Live Video Monitoring Window

- Single View: to maximize a video cell to the entire live video window

Double-click the video cell, or **right-click** the video cell and select **Single View**. The focused video will occupy the entire playback window as shown below.

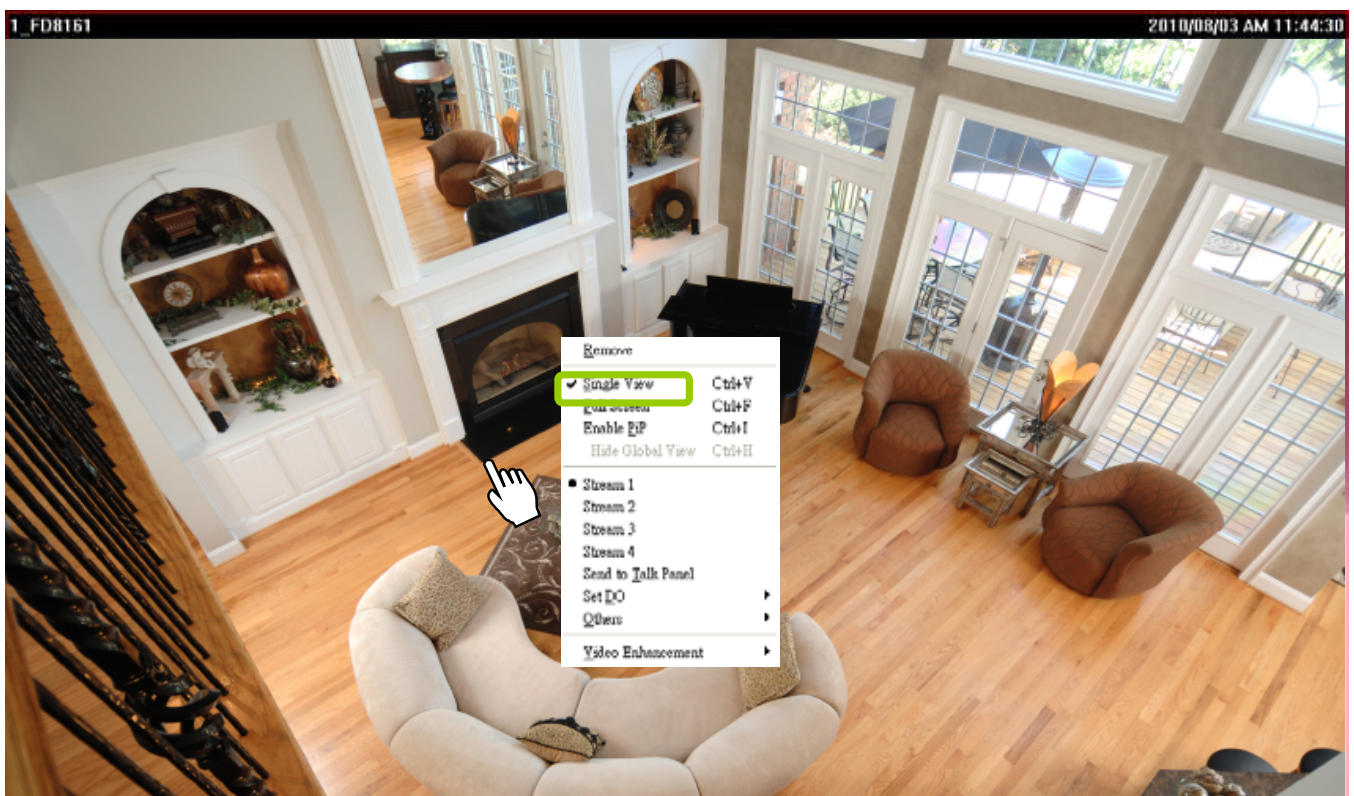
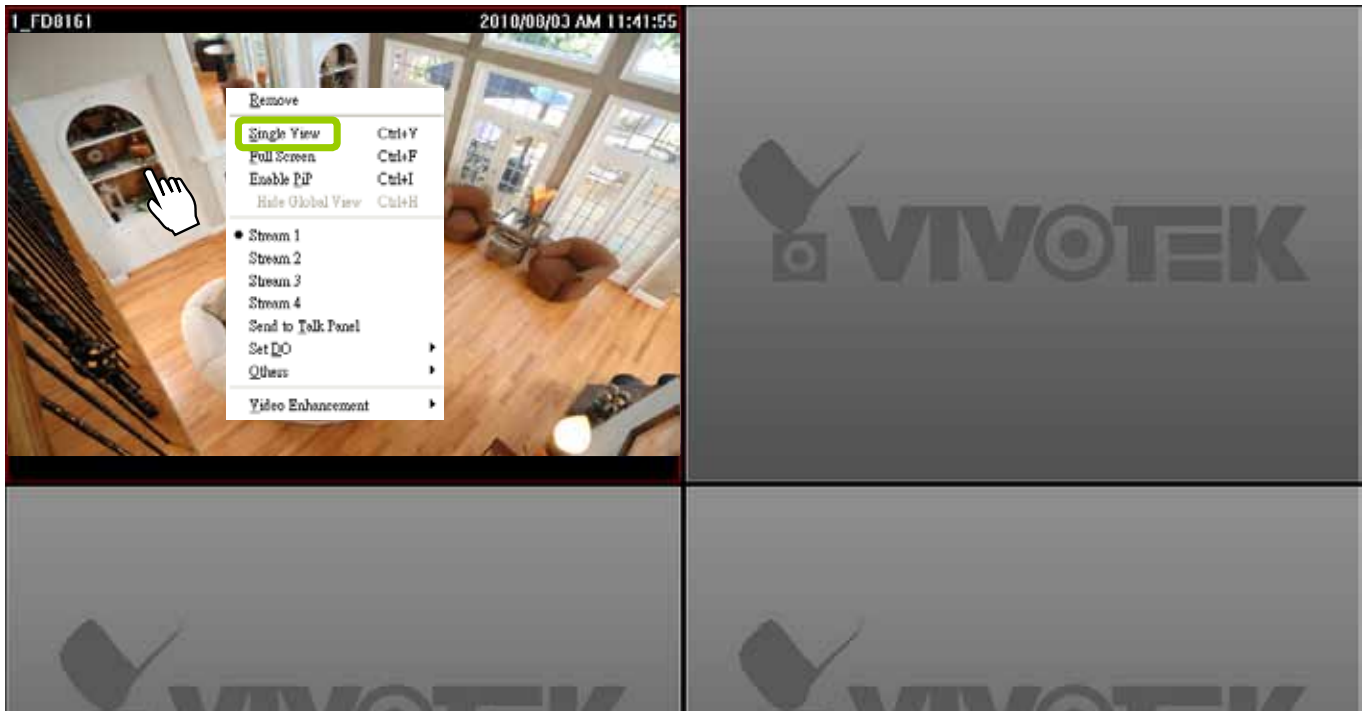

To restore to the original layout, **double-click** the video cell or **right-click** the video cell and uncheck **Single View**.

- Full Screen: Maximize the live video monitoring window to the entire screen

Click **Full Screen**  on the quick access bar or **right-click** the video cell and select **Full Screen**. In addition, you can also click **View > Full Screen** on the menu bar to maximize the live video monitoring window.

To restore to the original layout, you can **right-click** a video cell and uncheck **Full Screen** or click the **Esc** button on the keyboard to exit full screen mode.

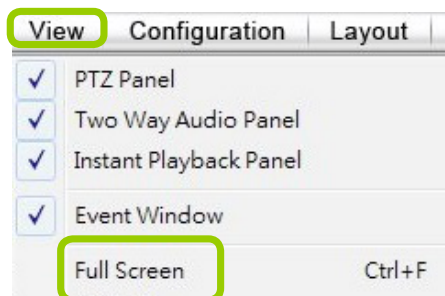

How to Manage Stations

A standard VAST Server allows you to construct a hierarchical management system by adding more sub-stations to the root station. The NVR system can be included into a hierarchy managed by a dominating VAST server. The NVR system itself can not manage other sub-stations.

Relay Settings

Before adding a sub-station, please follow the instruction below to enable the sub-station's Relay Settings first.

- Login to the sub-station.
- Select the station from the hierarchical management tree.
- Click **Configuration > Station Settings > Relay Settings** on the menu bar (or **right-click** the station on the hierarchical management tree and select **Station Settings > Relay Settings**).

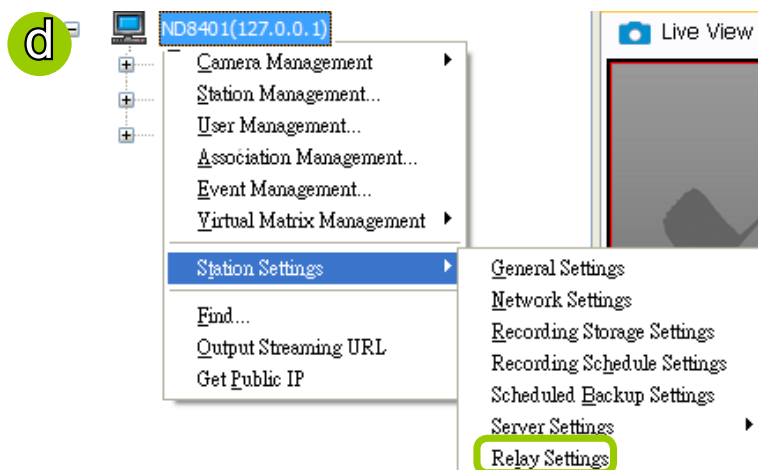
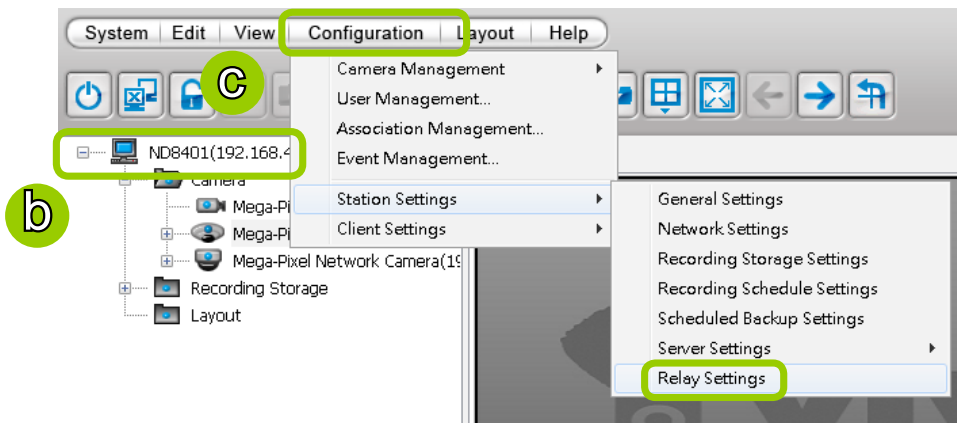

- The **Relay Settings** window will pop up. Check **Allow Relay Connection** and enter a **Password**. Then click **OK** to enable the settings.



How to Manage User Accounts

VAST on NVR allows users to apply multiple user accounts to a station with five levels of user roles: Administrator > Power User > User > Operator > Guest. Each role has different permissions listed as shown below. Moreover, Administrators have the highest privileges, while Power Users can only add/edit users as Power Users, Users, Operators, and Guests.

The Default User Roles and Permissions of User Accounts

Functions \ User Roles	Administrator	Power User	User	Operator	Guest	Description
User Management	✓	✓	✓			Manage user accounts
Camera Management	✓	✓				Insert and configure the camera settings
Association Management	✓	✓	✓			Access and modify the association settings
Access Event Management	✓	✓	✓			Access event management
Modify Event Management	✓	✓	✓			Modify event management
General Station Settings	✓	✓				Modify general station settings
Station Network Settings	✓	✓				Modify network settings
Access Recording Storage/ Recording Schedule Settings	✓	✓	✓	✓		Access the Storage Group and recording schedule
Modify Recording Storage/ Recording Schedule Settings	✓	✓	✓			Configure the Storage Group and recording schedule
Manually Record	✓	✓	✓	✓		Enable the recording function manually
Scheduled Backup Settings	✓	✓	✓			Configure backup schedule
Access Server Settings	✓	✓	✓			Access server settings
Modify Server Settings	✓	✓	✓			Modify server settings
Relay Management	✓	✓				Allow user to manage station relaying settings
Client Settings	✓	✓	✓	✓		Configure the client settings: snapshot, AVI, etc.
Video Enhancement Settings	✓	✓	✓			Allow user to edit profile for video enhancement and assign profile to camera in LiveClient

Privileges \ User Roles	Administrator	Power User	User	Operator	Guest	Description
Modify Directories	✓	✓	✓			Add, remove and rename directories
Delete Camera	✓	✓				Delete camera from the station
PTZ Control	✓	✓	✓	✓		PTZ control for PTZ cameras and speed domes in LiveClient
Device Control	✓	✓	✓	✓		Control the digital output or white light/IR illuminators of the cameras
Talk Control	✓	✓	✓	✓		Two way audio function for the cameras
Access Camera Configuration	✓	✓	✓			Access the camera settings
Modify E-map	✓	✓	✓	✓		Allow user to modify the E-map
Event Search	✓	✓	✓	✓		Use built-in search engine to search specific events
Log Viewer	✓	✓	✓	✓		Use built-in search engine to search the log
Backup	✓	✓	✓	✓		Back up database manually
Record/Export Media	✓	✓	✓	✓		Record live stream or export playback stream to local files
Playback Authority	✓	✓				Allow user to access Playback

Manage a User Account

Add a New User Account

- Select the station from the hierarchical management tree.
- Click **Configuration > User Management** on the menu bar (or **right-click** the station, then select **User Management**).

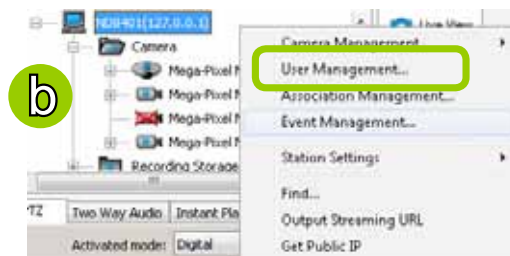
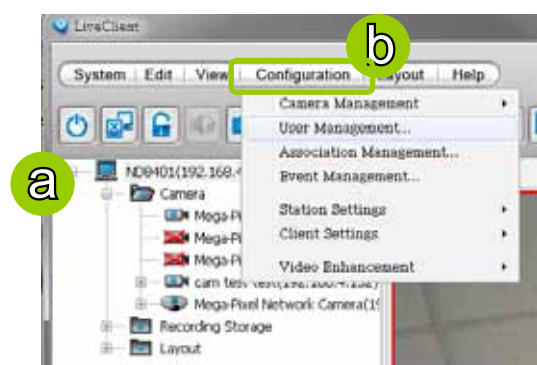

- The **User Management** window will pop up. The user accounts under the station will be displayed under the left User List tree.
- Enter the **User Name**, **Password**, and specify the **User Role** of this user.
- Click **Add** to add the user account to the station. It will be displayed under the User List.

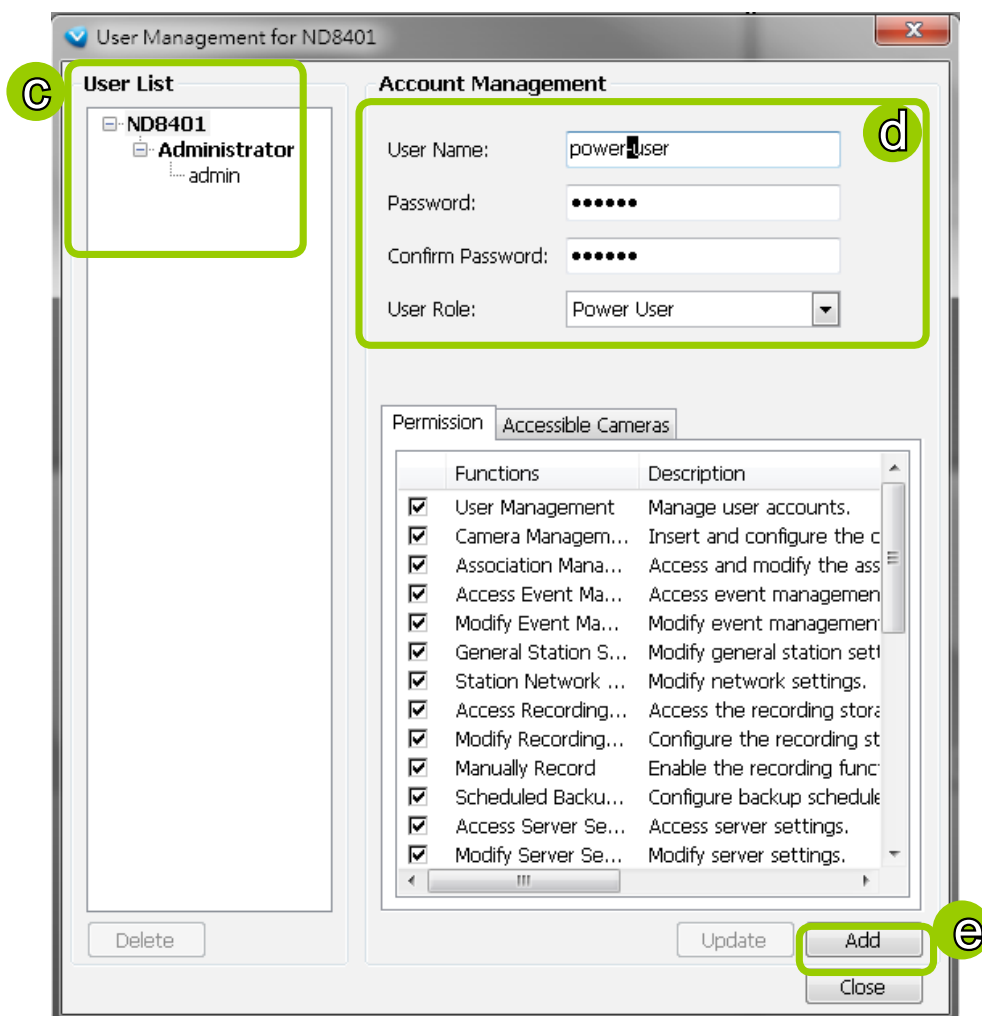

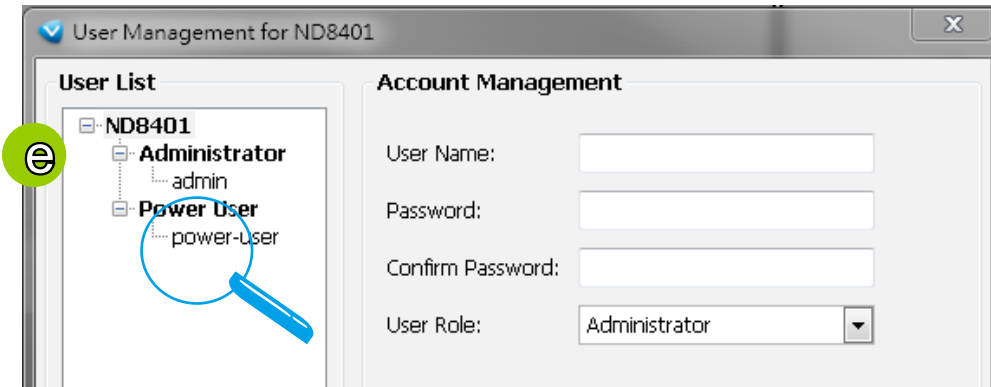

Permission of the User Account

Administrator is granted with all access privileges, while other user roles' permission is limited. If you want to modify the permission, please login as the Administrator to configure the settings.

f. Select a User account from the User List tree.

g. If you want to set the limit of the permission of the user, click **Permission** tab to check or uncheck the items.

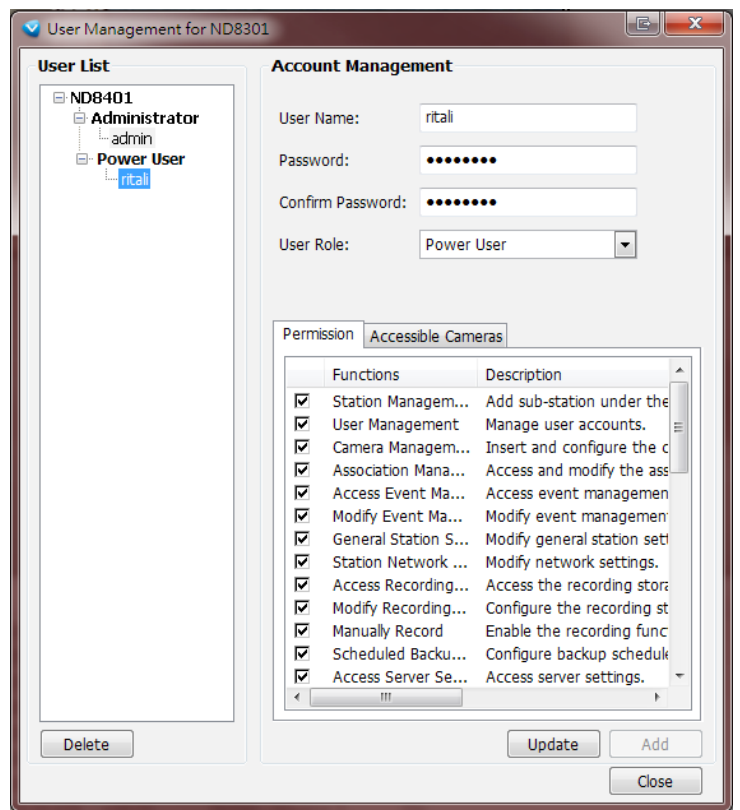

h. If you want to limit the devices accessible by the user, click **Accessible Cameras** tab to select the desired devices.

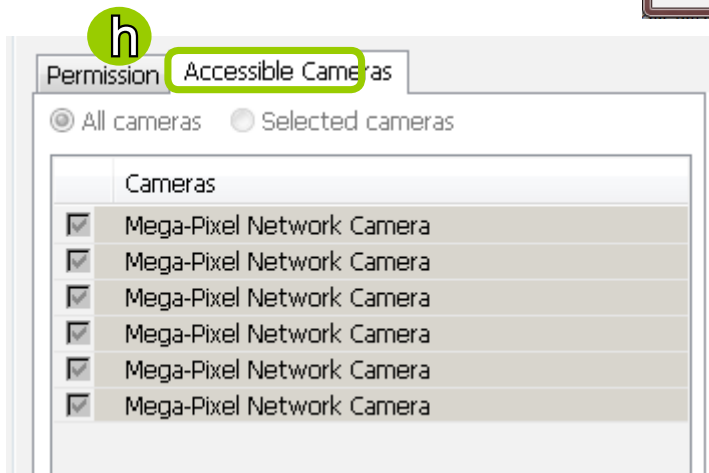

NOTE:

If you want to remove access permission mentioned above from the account, the user will not be able to operate some functions listed in the following warning dialog.



j. When completed, click **Update** to enable the new settings.

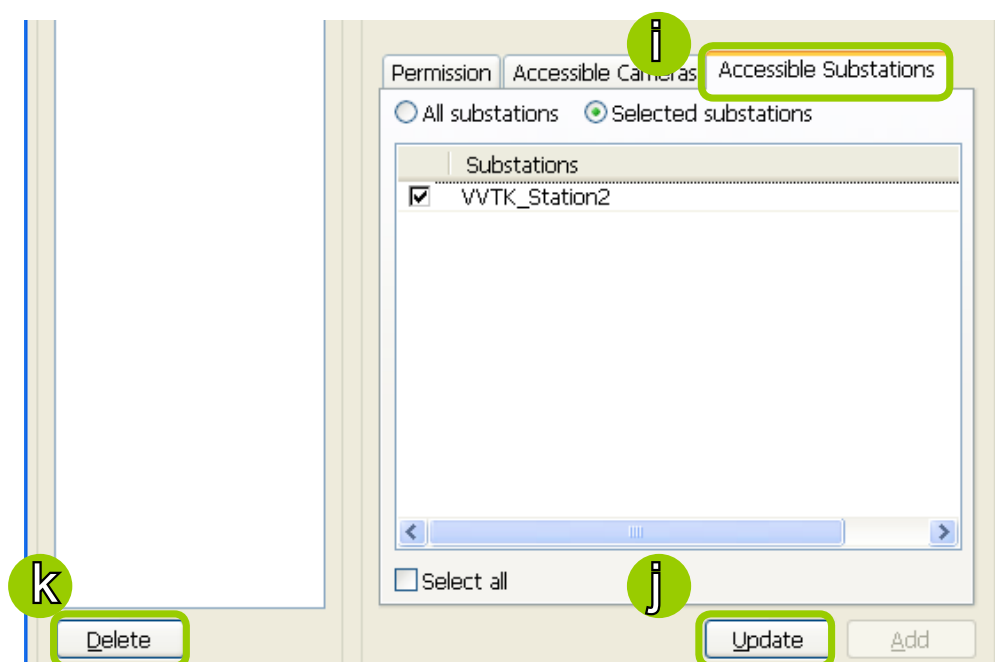

Delete the User Account

k. Click **Delete**, a delete user dialog will pop up. Click **OK** to delete the user account.

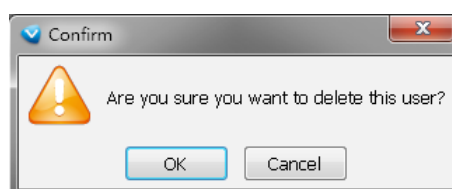
**NOTE:**

If the Administrator modifies or deletes the User Account, that modified user might be kicked off from the station.

How to Set up Association Management

The LiveClient supports association management which allows the user to configure relative event trigger notifications of the connected network devices. (E.g., DI/DO status on the management tree, motion detection windows appearing in the video cell, or the event list in the event window)

Association Management

Please follow the steps below to configure association settings:

- a. Select the station from the hierarchical management tree.
- b. Click **Configuration > Association Management** on the menu bar (or **right-click** the station and select **Association Management**).

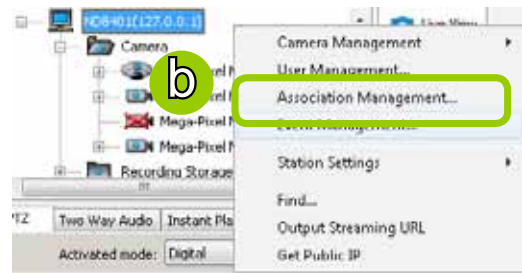
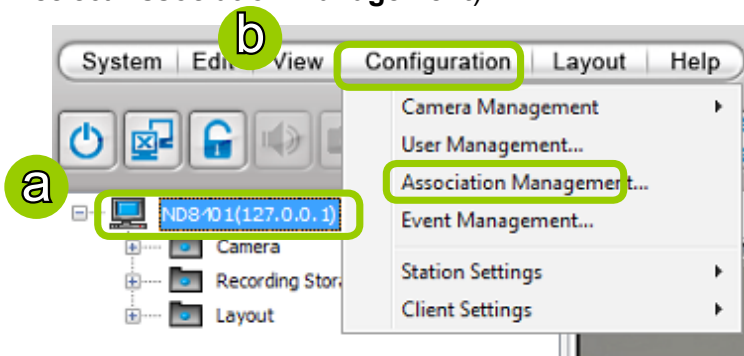

- c. The **Association Management** window will pop up. Check or uncheck the items and click **Save** to enable the settings. The items you've selected will also be displayed under the hierarchical management tree.

For example:

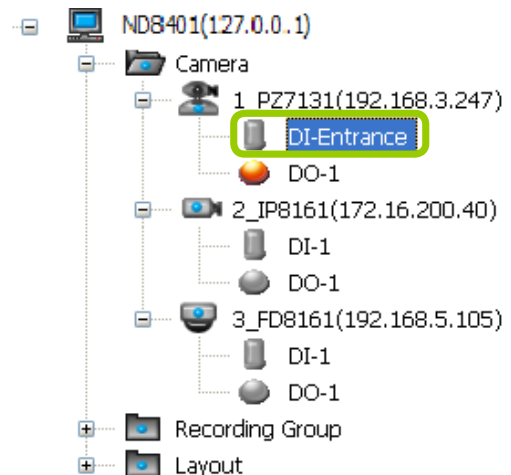

- d. If you want to rename the DI device, select the DI item and click the **Rename** button. It will be very convenient for you to recognize the target DI device.

NOTE:

- To manually enable DI/DO settings, please **right-click** the video cell and select **Set DO** to enable (**Trigger**) or disable (**Normal**) the digital output of the linked device.

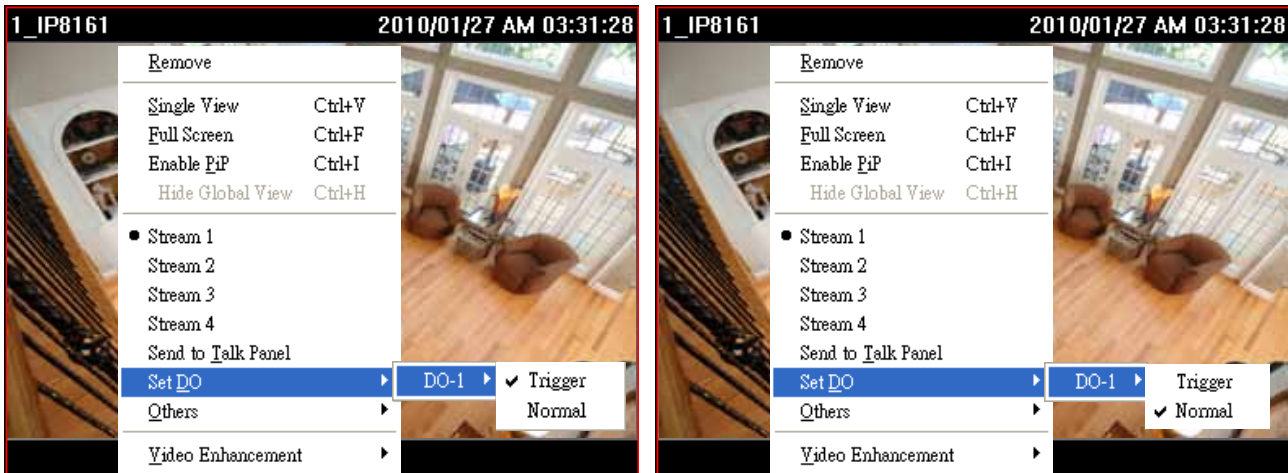

- Before you configure the DI/DO Settings for VAST, please enable DI/DO configurations on your network device and set up the camera correctly on the configuration page. You can **right-click** the device and click **Camera Settings** to open the configuration page.

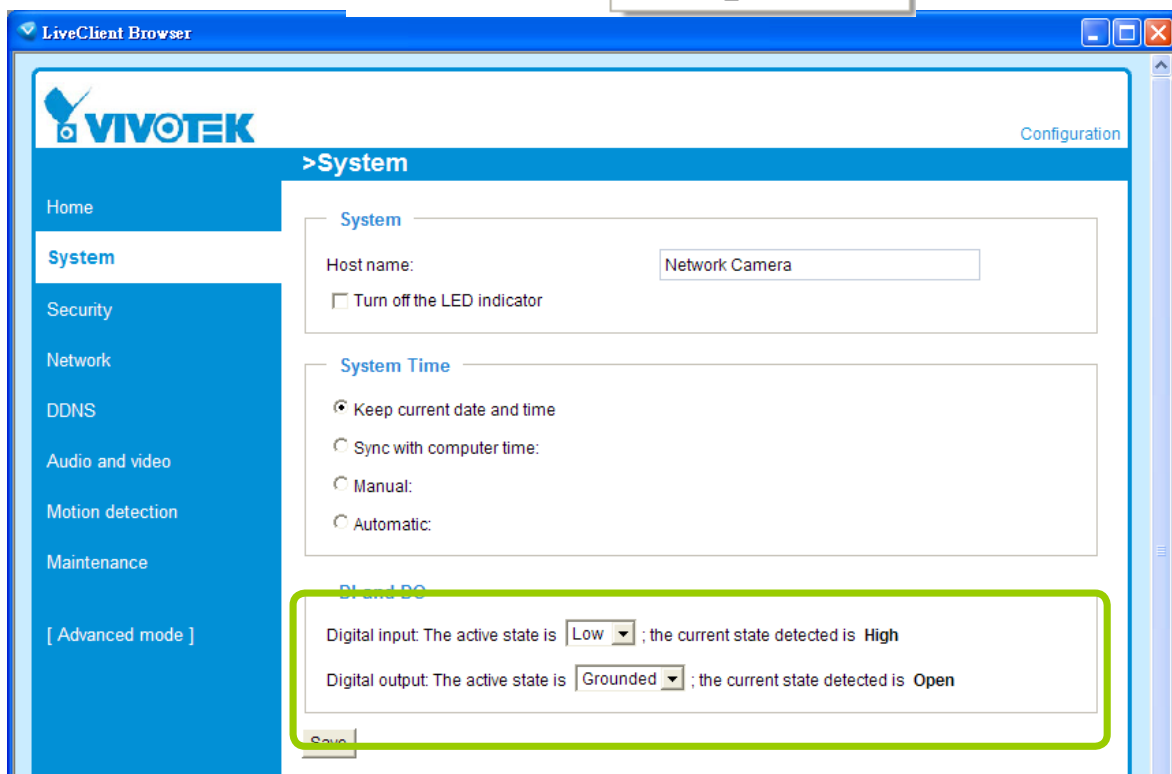
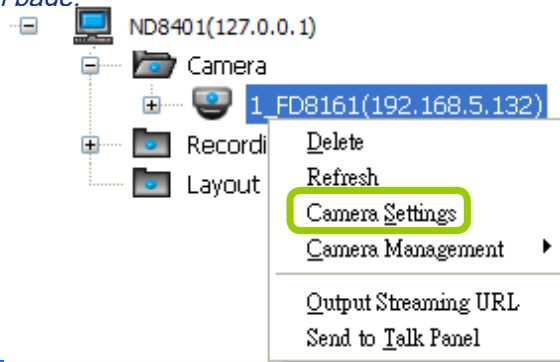

How to Set up Event Management

The NVR's LiveClient supports event management which allows the server to respond to particular situations (events). LiveClient can correspond with cameras' input and respond with associated reactions, such as sending notifications, telling cameras to move to preset locations, etc.

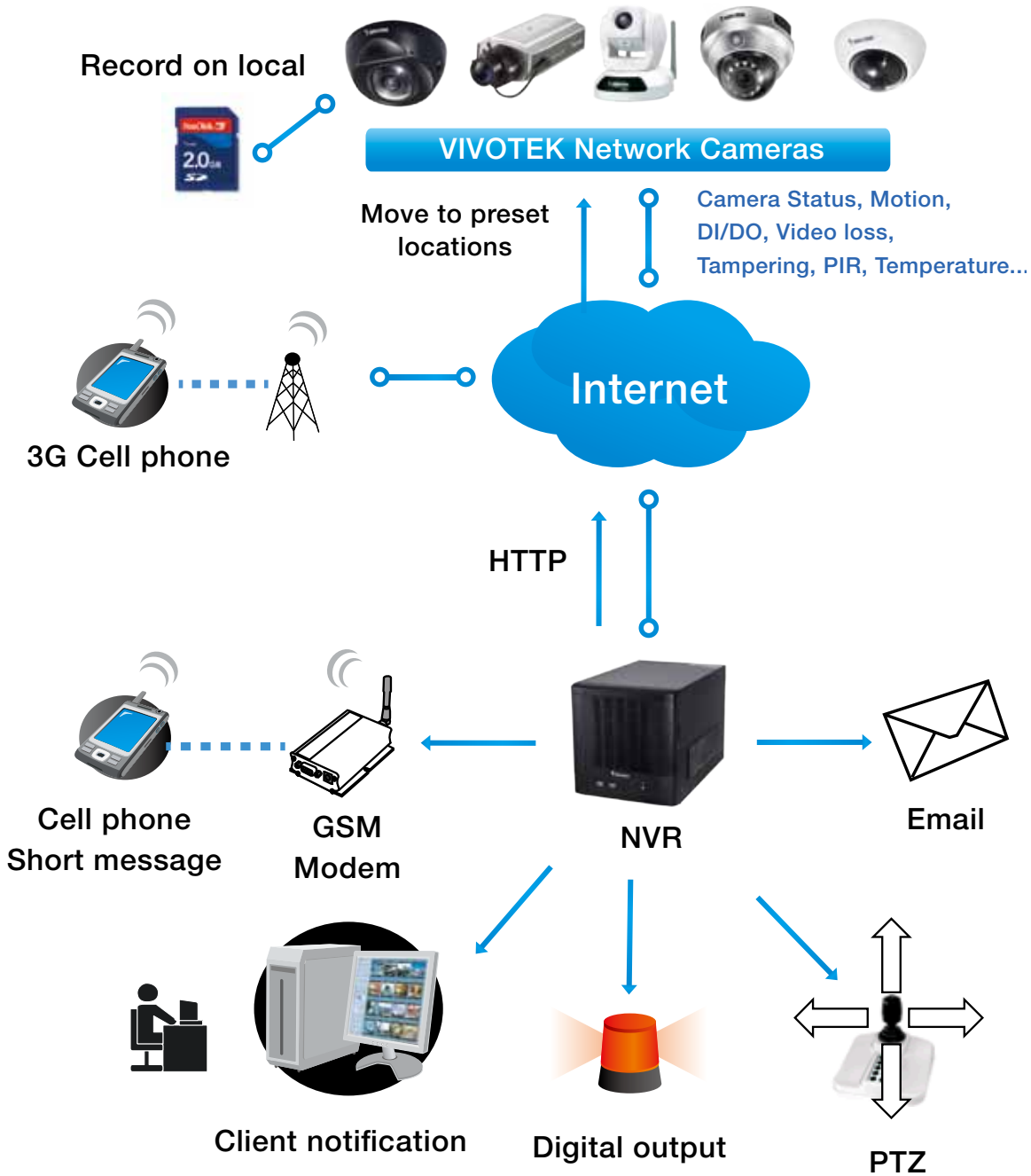

Event Management

Please follow the steps below to configure event management:

- a. Select the station from the hierarchical management tree.
- b. Click **Configuration > Event Management** on the menu bar (or **right-click** the station and select **Event Management**).

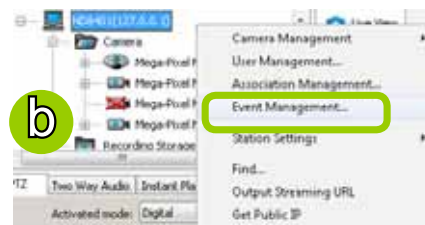
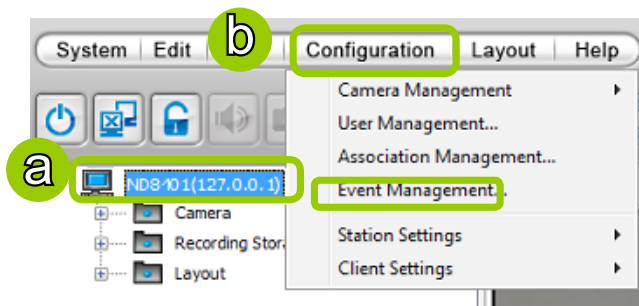

- c. The **Event Management** window will pop up. Click **New** to set up a new event. When you finish the general settings, click **Next** to set up trigger source settings.

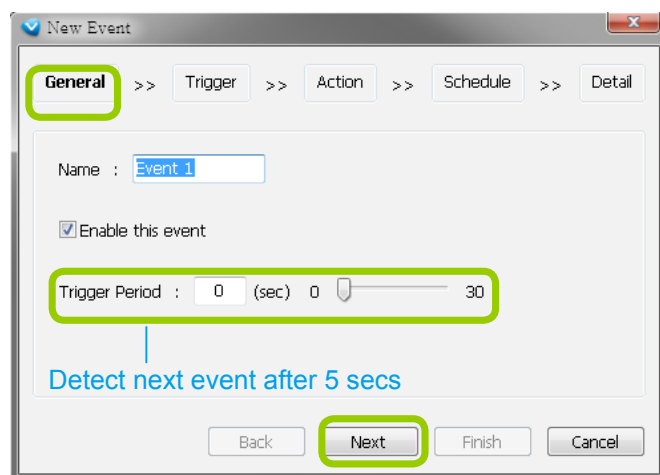
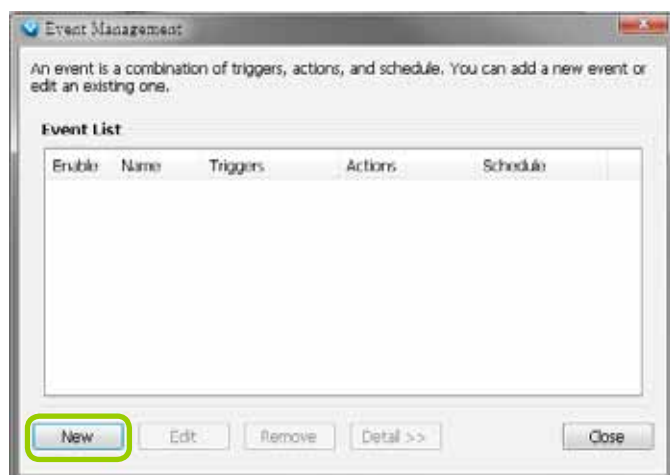

- d. Click **Add** to select the trigger source by Device or Trigger Type.

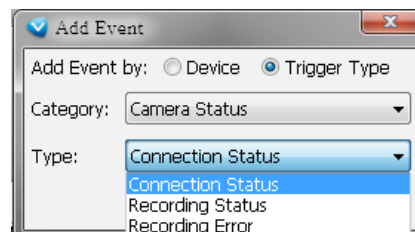
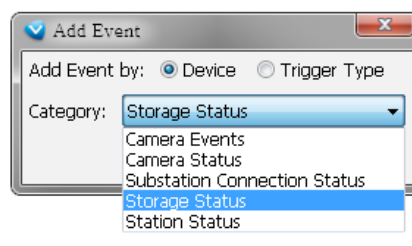
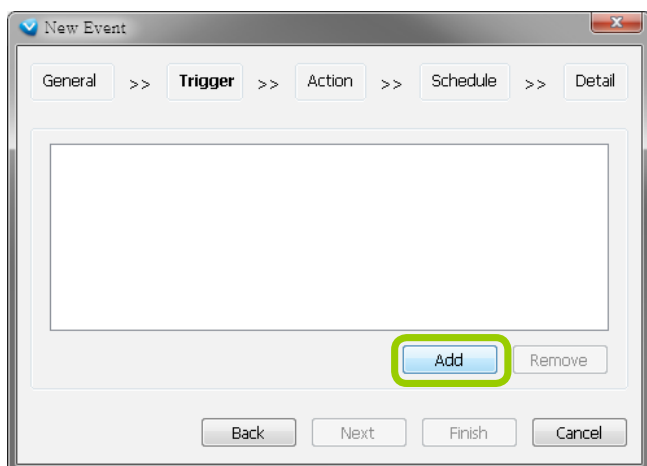

e. The Device List window will prompt. Select one or more devices and set the Notification Type. Depending on the trigger source, the Notification Type will be different. Then click **OK** to close the window.

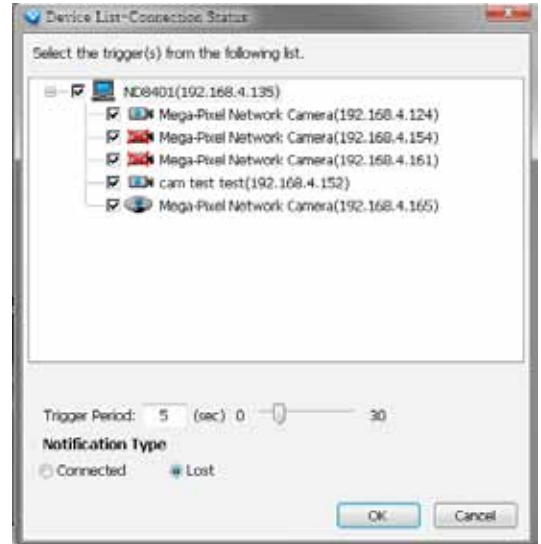

f. The trigger source(s) will be listed on the window as shown below. If you want to add more Trigger sources, click **Add** and repeat steps d.and e. Then click **Next** to assign action(s) to the trigger source(s).

g. Click **Add** to open the **Action** Settings window.

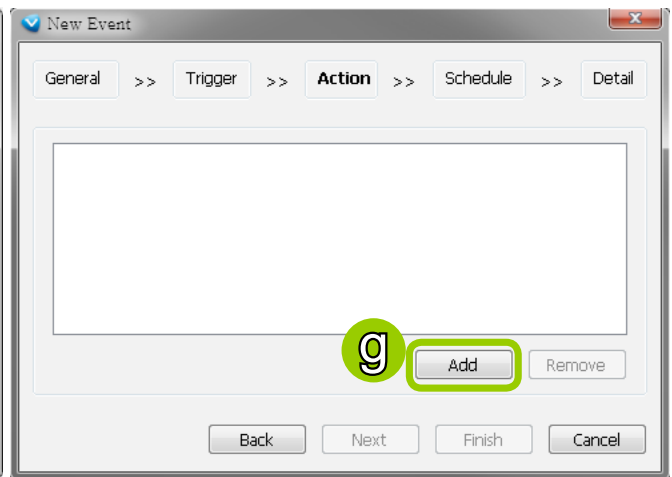
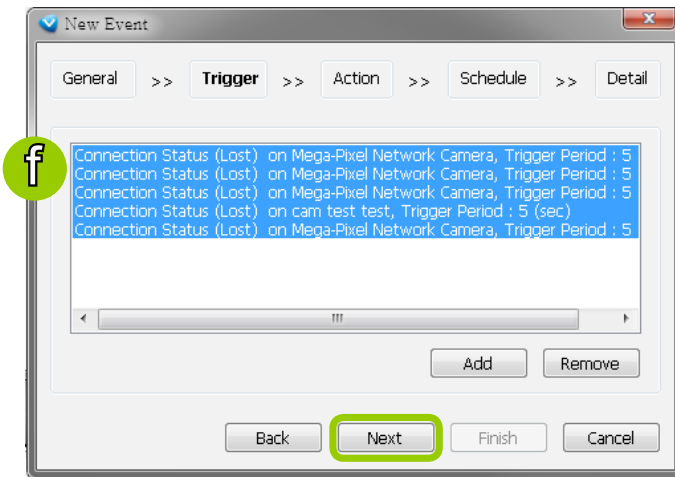

There are several options with the Action Settings.

- Email: The sever will send a notification via e-mail when a trigger is activated.
- h. To enable this function, please set up the SMTP server first. Click **SMTP Setting** to open the window and refer to page 111 for detailed information.
- i. Enter the related informtaion. You can modify the mail content in the blank. If you want to modify the content, click **Insert Macro** to select the parameter. When completed, click **OK** on the bottom to enable the setting.

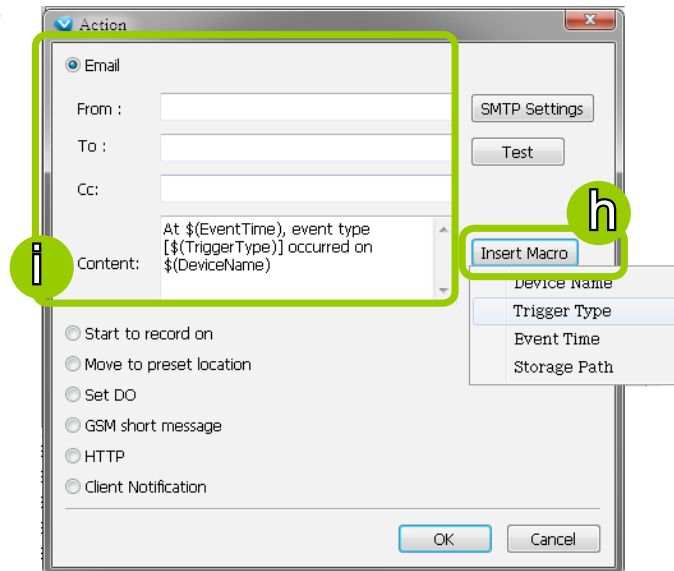

- Start to record on: The sever will start to record video from selected camera(s) when an event is triggered.
 - j. Click **Add Camera** to select the target camera(s).
 - k. The selected camera(s) will be listed on the left window below. When completed, click **OK** at the bottom to enable the setting.

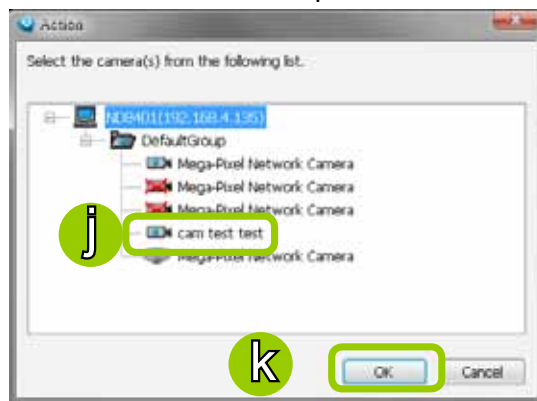
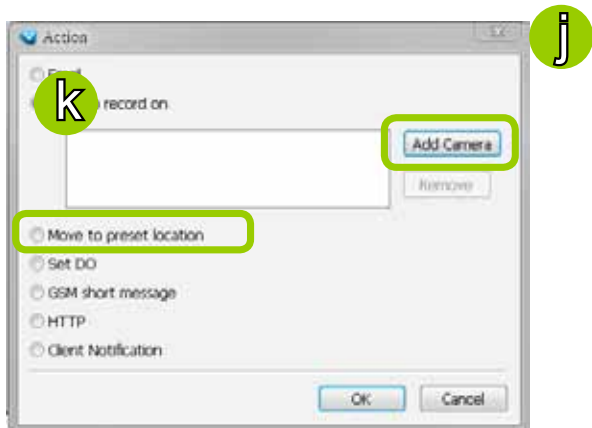

- Move to preset location: The target camera(s) will move the shooting area to the preset location(s) when an event is triggered.
 - l. To enable this function, please set preset locations on the camera configuration page first.
 - m. Click **Add Location** to select preset location(s).
 - n. The selected preset location(s) will be listed on the left window below. When completed, click **OK** at the bottom to enable the setting.

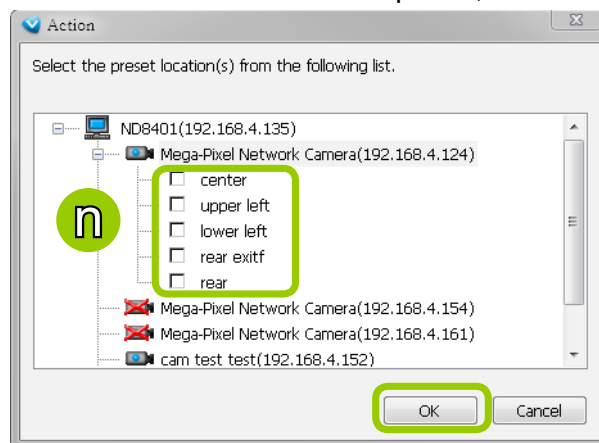
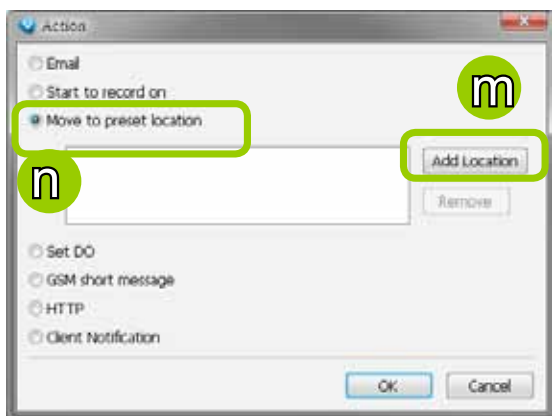

- Set DO: Select this option to turn on external digital output device(s) when an event is triggered. For more information about how to set DI/DO settings on the target camera, please refer to page 70.
 - o. Click **Add DO** to select DO decive(s) and select a DO status (Normal or Trigger).
 - p. The selected DO device(s) will be listed on the left window below. When completed, click **OK** to enable the setting.

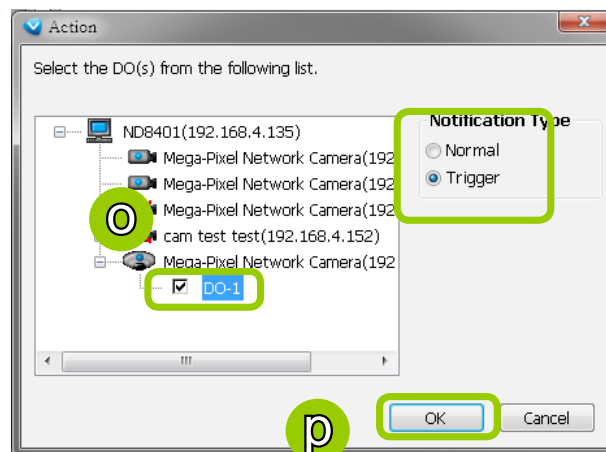
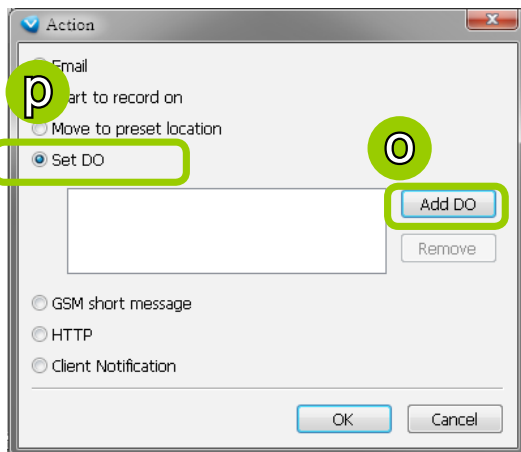

- GSM Short Message: The sever will send a short message to a GSM cell phone when an event is triggered. A GSM modem is necessary.
 - q. Please enter the Phone Number and open **GSM Settings** window to set related information if necessary. When completed, click **OK** to enable the setting.



Please enter the country code if you use overseas call.

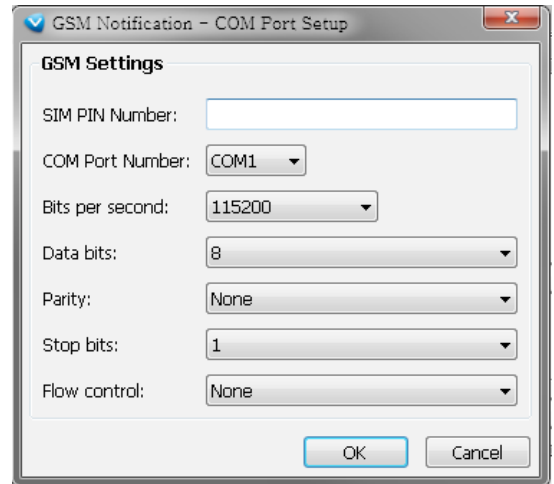

- HTTP: This function allows user to send a CGI command to the linked network camera, such as pan/tilt/zoom function or enable DO devices.
 - r. You can click **Insert Macro** to select the parameter. Please enter authentication information if necessary. For example: `http://192.168.3.66/cgi-bin/admin/setparam.cgi?system_hostname=$(EventTime)$(CameraName)`
 If you want to use special characters such as \$-_.+!*(),#%+\$,@:./=?=&, please refer to the following table to transfer the Code (Hex).
 For example: `http://192.168.3.66/cgi-bin/admin/setparam.cgi?system_hostname=123&456`
 --> `http://192.168.3.66/cgi-bin/admin/setparam.cgi?system_hostname=123%26456`

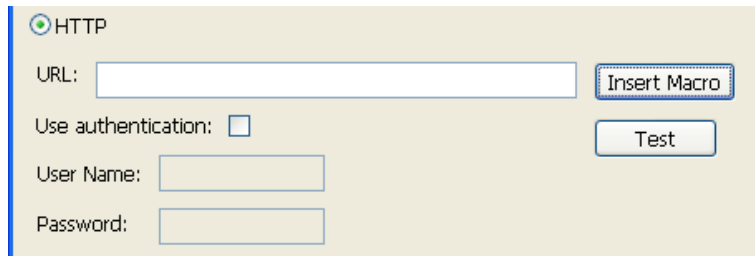

Character	Code (Hex)	Character	Code (Hex)
!	21	,	2C
#	23	-	2D
\$	24	.	2E
%	25	/	2F
&	26	:	3A
'	27	;	3B
(28	=	3D
)	29	?	3F
*	2A	@	40
+	2B	_	5F
		~	7E

- **Client Notification:** This function allows a notification video cell to prompt when an event is triggered. You can select the size of the video cell, and select how long the view cell will stay on top of the screen.

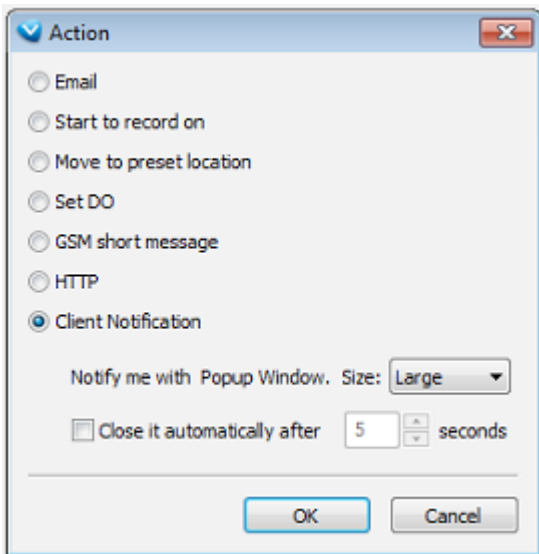

s. The action(s) will be listed in the window as shown below.

Then click **Next** to set up schedule(s) to the action(s).

For more information about **Schedule Settings**, please refer to Recording Schedule Settings on page 88. You can assign more than one time frame during twch an action will take effect.

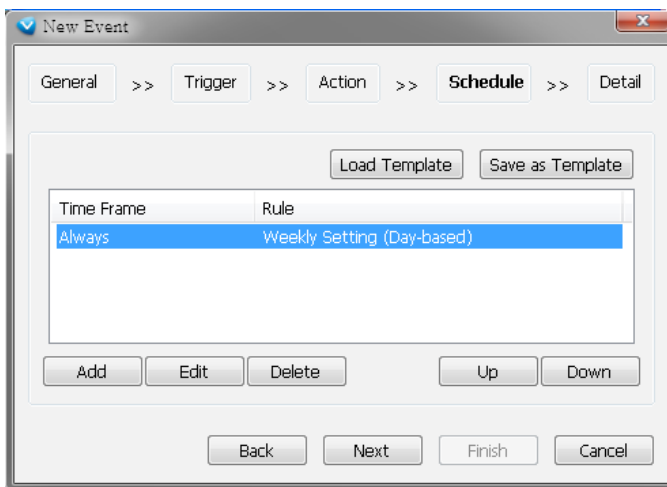
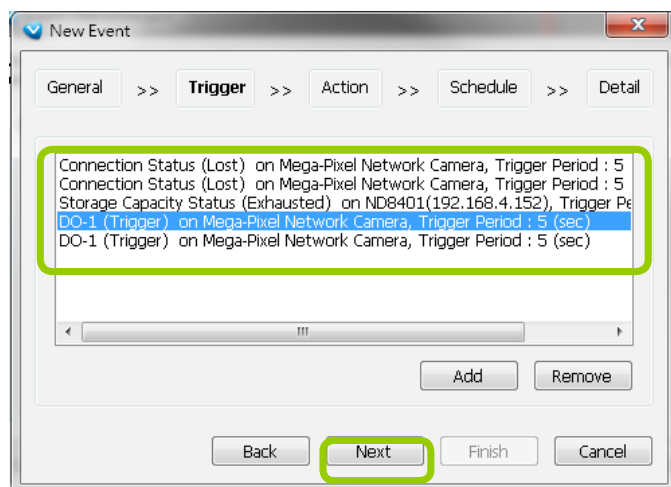

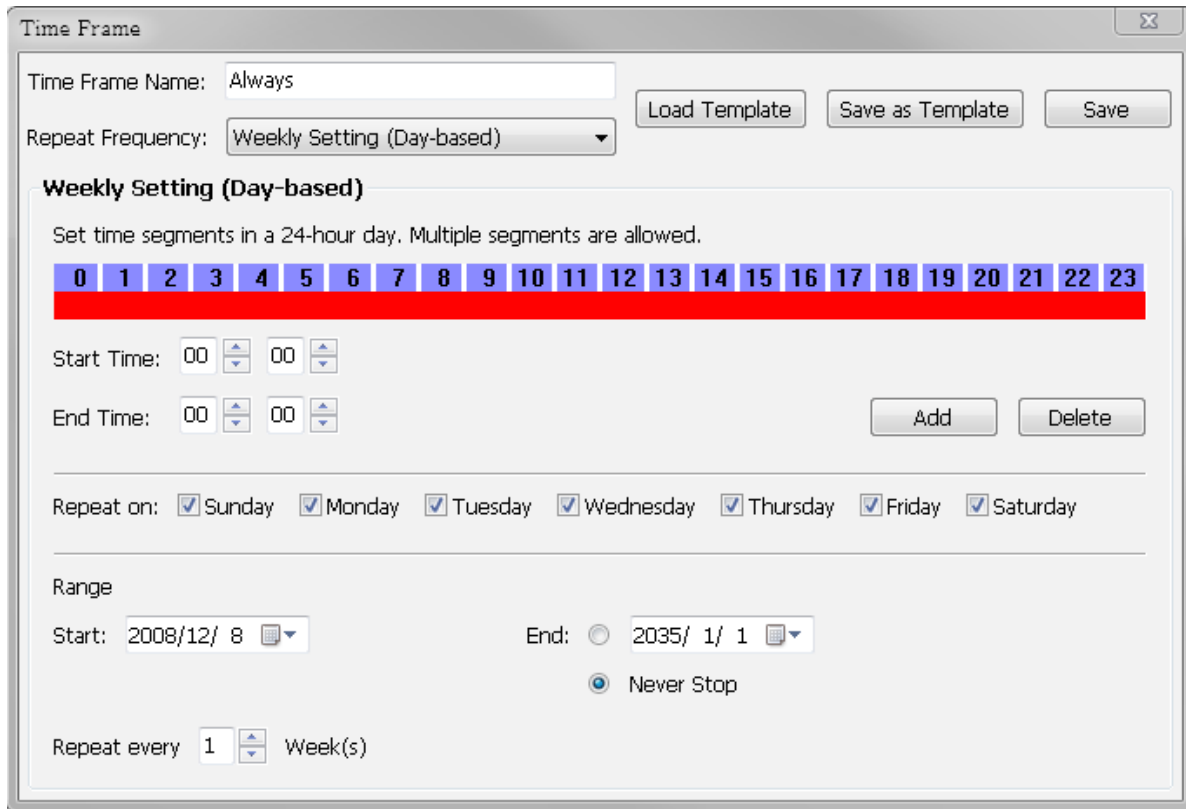

t. When you finish schedule settings, click **Next** to review the detailed information of the new event settings.

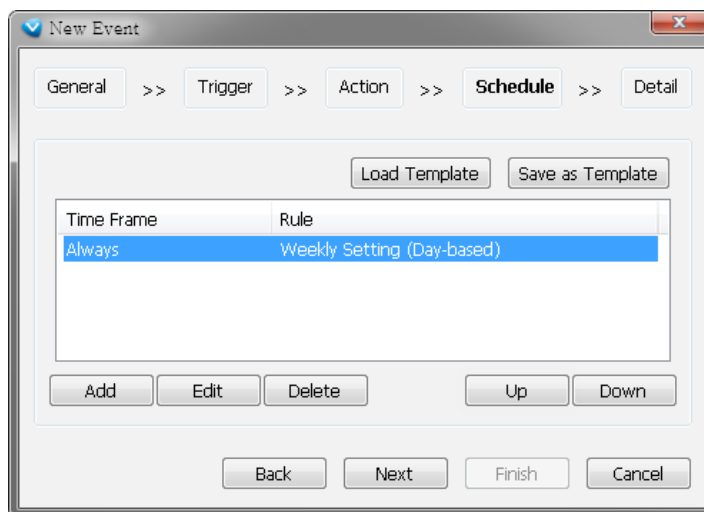

- u. Following is the detailed information of the new event setting. You can click **Back** to modify the event setting or click **Finish** to close the window.

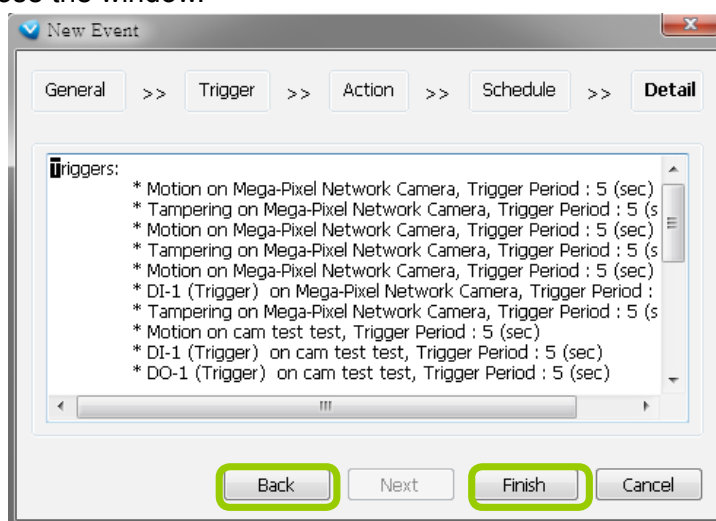

- v. Following is an example of an enabled event. You can click **New** to set up more events or click **Close** to exit the window.

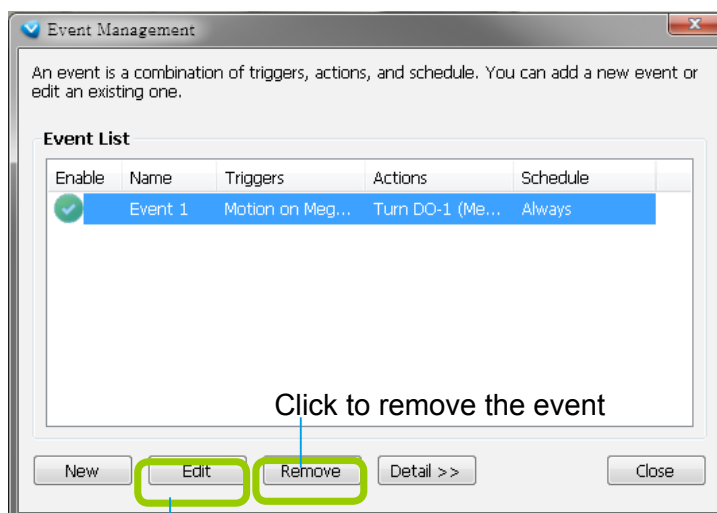

Click to disable or modify the selected event

How to Configure the Station General Settings

Select the target station from the hierarchical management tree, then click **Configuration > Station Settings > General Settings** on the menu bar (or **right-click** the station on the hierarchical management tree and select **Station Settings > General Settings**). The **Station General Settings** window will pop up.

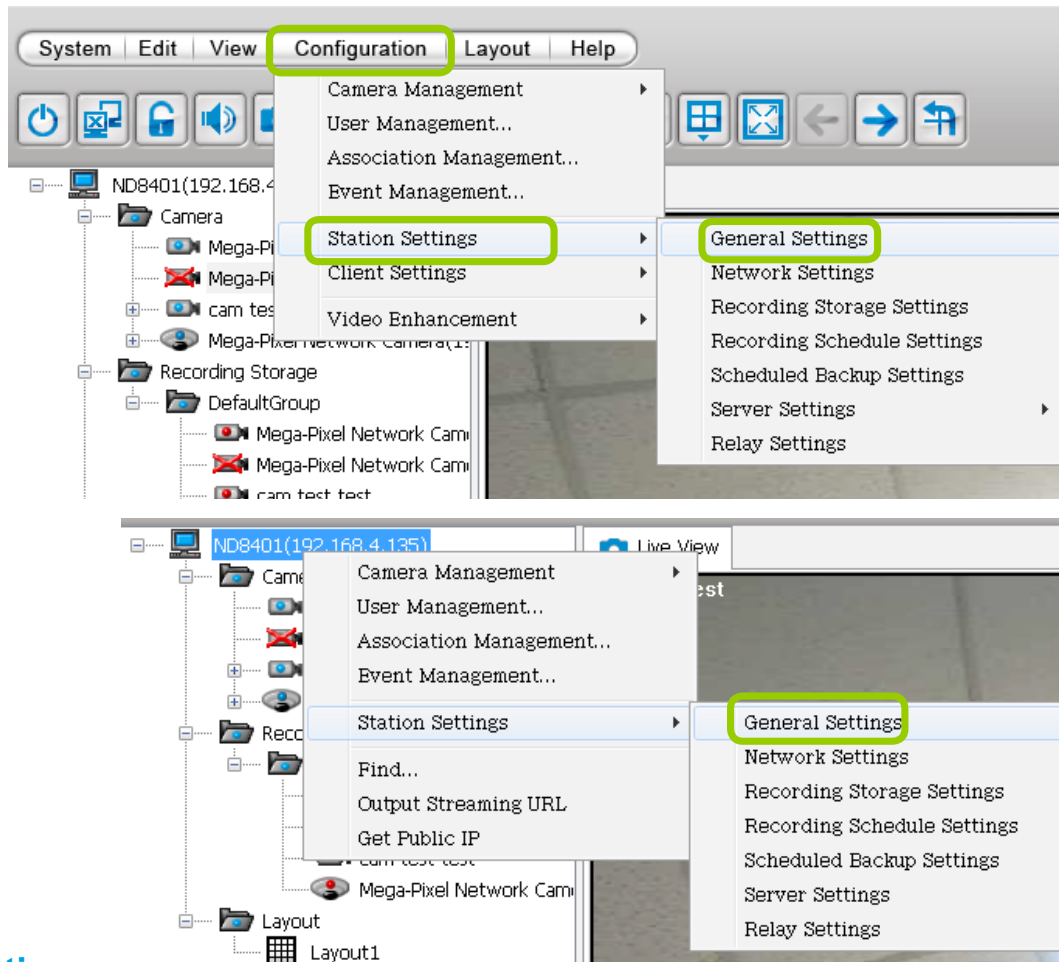

Server Settings

In this section, you can modify the name of your NVR Station.

Log Settings

In this section, you can set up **Log Settings** for the station.

The VAST server allows users to search for the recorded log through VAST Playback. For more information, please refer to **How to Search Logs** on page 178.

- Log level: Select **High** (only record high-level logs), **Normal** (record high-level and normal-level logs), **Low** (record all logs). For detailed information about log levels, please refer to page 179.
- Reserve Time: Enter the extension of time that you want to reserve the log record. The maximum value is 365 days.

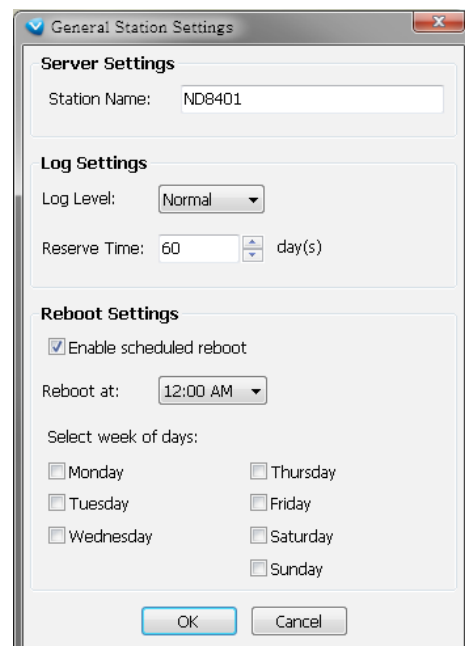

Reboot Settings

You can schedule a system reboot every day at a specific time in a day or in days within a week. Select the checkbox and select a time from the pull-down list.

Click OK when the configuration is done.

How to Configure Station Network Settings

Select the target station from the hierarchical management tree, then click **Configuration > Station Settings > Network Settings** on the menu bar (or **right-click** the station on the hierarchical management tree and select **Station Settings > Network Settings**). The **Network Settings** window will pop up.

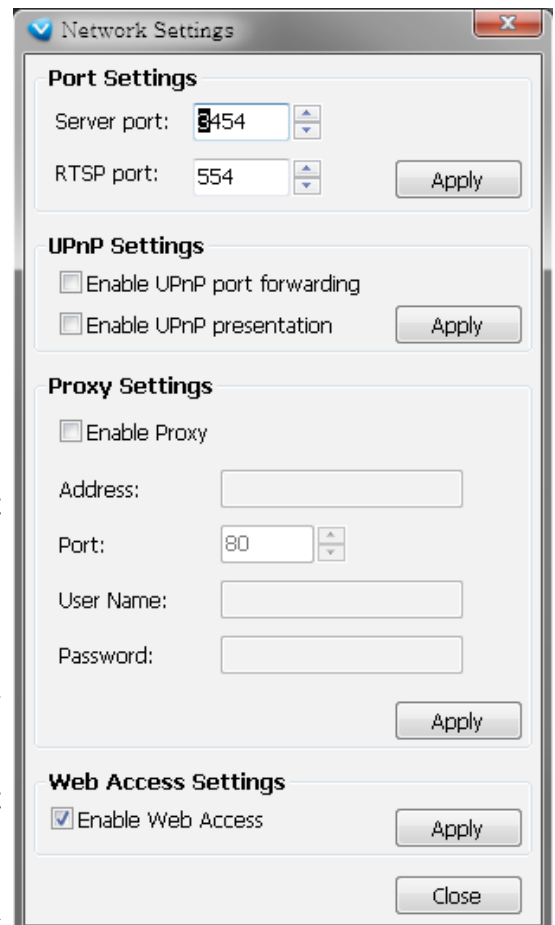
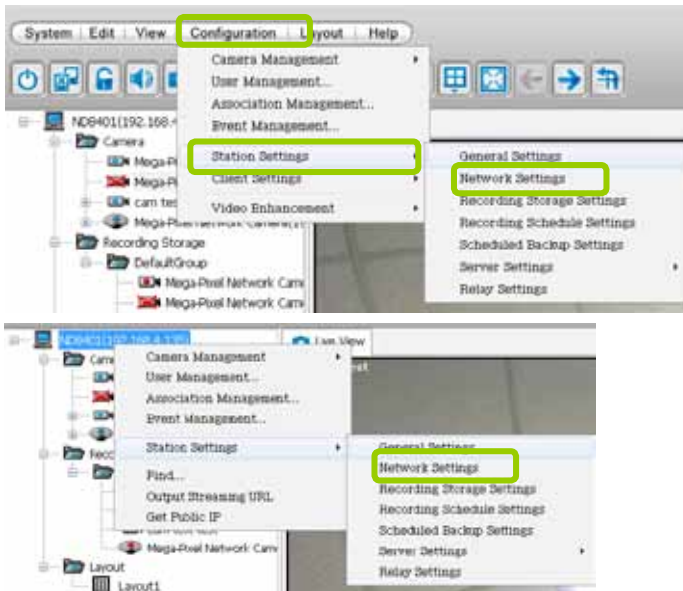

Port Settings

- **Server port:** The default server port is set to 3454. If you change the server port, please enter the new value while logging the LiveClient next time.
- **RTSP port:** The RTSP (Real-Time Streaming Protocol) controls the delivery of streaming media. By default, the port number is set to 554.

UPnP Settings

- **Enable UPnP port forwarding:** For client to access the VAST Server from the Internet, select this option to allow the server to open ports on the router automatically so the video streams can be sent out from a LAN. To utilize of this feature, make sure that your router supports UPnP™ and it is activated.
- **Enable UPnP presentation:** If you select this option, shortcuts to VAST Server will be listed in My Network Places.

Proxy Settings

In this section, you can enable, modify, or cancel **Proxy Settings** for VAST Server if your network devices are set up under a proxy.

Web Access Settings

User can access LiveClient and Playback via Internet web browser (<http://IP address:3454>).

For local host --> <http://127.0.0.1:3454>.

How to Edit Recording Storage

By default, all devices (cameras) are assigned to the default recording storage. You can manually remove a device from the default recording storage. However, only those devices which belong to a recording storage can produce recorded media files.

Another purpose of setting the recording storage is that you can divide all the managed devices into several recording storages, and for each storage group, you can assign several hard-disks or disk volumes (with its unique recording paths) to store media data. The live media data will be stored in the first assigned hard-disk initially, and when the available space of the first hard disk reaches the preset threshold for a reserved space, the media data will be stored in the following disk and so on. If the available space of the last disk reaches the threshold of reserved space, the recorded files in the first disk will be overwritten with the new media data. This procedure is called "Cyclic Recording".

Recording Storage Settings

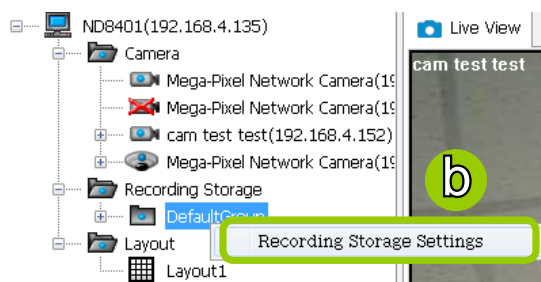
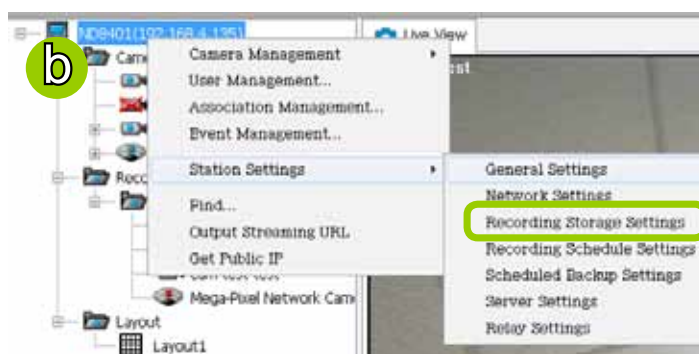
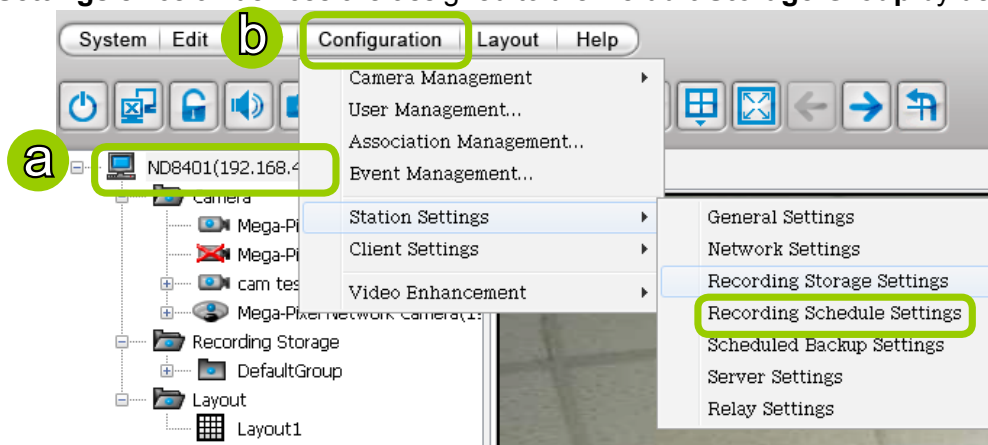

Please follow the steps below to set up recording storages for a station:

- a. Select the target station from the hierarchical management tree.
- b. Click **Configuration > Station Settings > Recording Storage Settings** on the menu bar (or **right-click** the station on the hierarchical management tree and select **Station Settings > Recording Storage Settings**). You can also **right-click DefaultGroup** under the station and click **Recording Storage Settings** since all devices are assigned to the **Default Storage Group** by default settings.



- c. The **Recording Storage Settings** window will pop up.

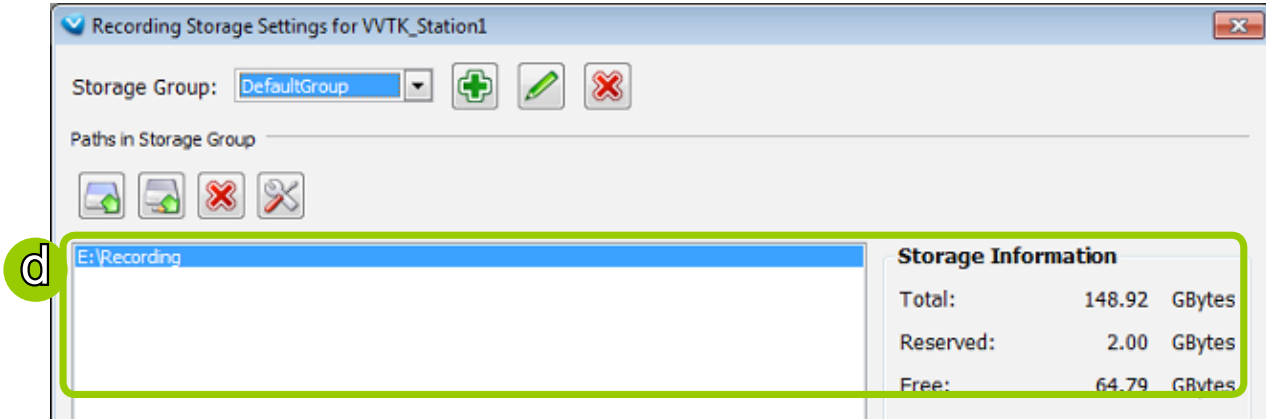

Default Storage Group Settings

The following example shows the default storage group settings. You can click  **Rename** to modify the group name or click  **Delete** to remove the default settings.



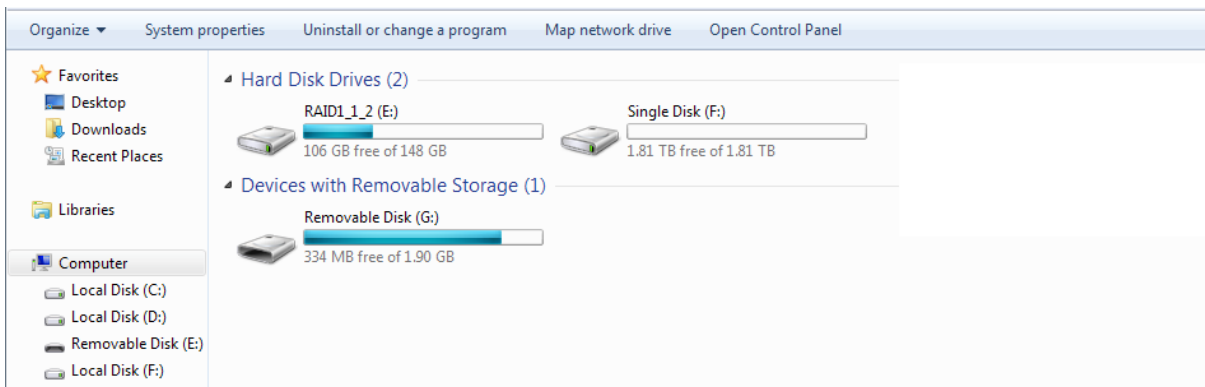

d. The default recording path is **E:\Recording**. The total space and free space of the disk is shown on the right for reference. On the NVR system, the boot disk (IDE flash) is segregated into two logical partitions as C: and D: drives. C: and D: are not used for storing user data. The E: partition, the disk volume you created from the SATA drives is used for recording video data.

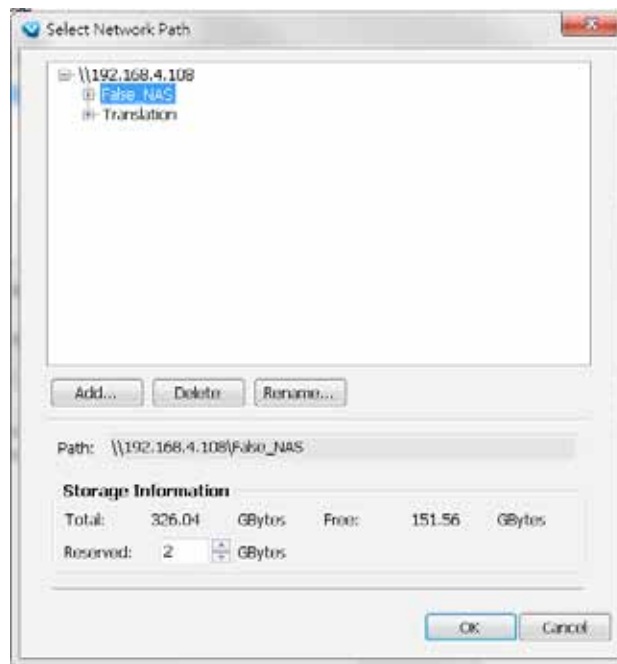
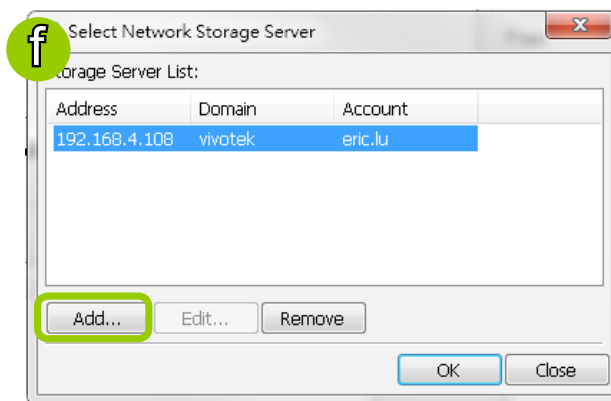
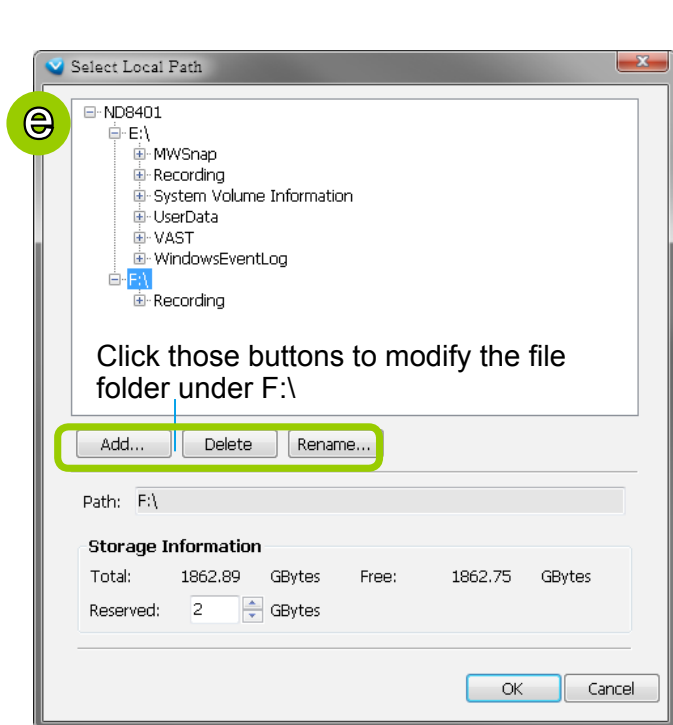

- e. Add Local Path: Click  to add another recording path on your local computer. A Select Path dialog will pop up as shown below. When all settings are complete, click **OK** to enable the settings, or click **Cancel** to discard the settings.
- f. Add Network Path: Click  to add a network storage for recorded data. Please refer to page 110 for detailed information about how to add a new network storage server. Then double-click the **Path** to assign a specific folder as a new recording path.



- g. To modify the settings of a path, select the path from the list, then click  **Change settings** to modify.
- h. To delete a path, select the path from the list and click  **Delete path**. A warning dialog box will pop up as shown below.



- i. By default, all devices are assigned to the **Default Storage Group** in the window to the right. You can select device(s) from the list and click **<-** to delete device(s) (or **right-click** the device under DefaultGroup tree to delete it). Note that a **Delete Camera** dialog box will pop up. Click **Yes** to delete the device along with the recorded data; click **No** to delete the device but retain the recorded data; click **Cancel** to cancel the delete action. Please note that only those designated devices can record videos.
- j. Click **>>** to add devices to the **DefaultGroup**.

k Delete recorded data older than day(s)



Cameras in Storage Group

Available Cameras:

Name	Address	Group
Mega-Pixel Network Camera	192.168.4.140	DefaultGroup
Mega-Pixel Network Camera	192.168.4.142	DefaultGroup
Mega-Pixel Network Camera	192.168.4.141	DefaultGroup
Mega-Pixel Network Camera	192.168.4.138	DefaultGroup
Mega-Pixel Network Camera	192.168.4.140	DefaultGroup

Added Cameras (5/256):

Mega-Pixel Network Camera
Mega-Pixel Network Camera
Mega-Pixel Network Camera
Mega-Pixel Network Camera
Mega-Pixel Network Camera

Recording Group

- DefaultGroup
 - 1_FD8161
 - 2_IP8330 
- Layout

Start Manual Recording

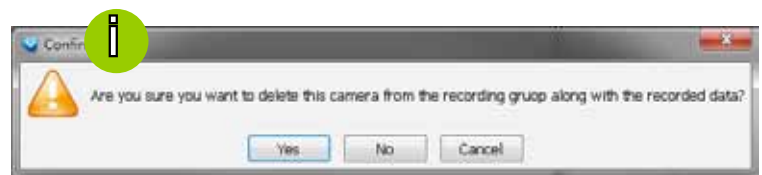

- k. Delete recorded data older than the duration: If you only want to retain recorded data for a period of time, select this item and enter a number of day(s). In addition, since VAST Server will do "cyclic recording" automatically, the oldest file will be overwritten by the latest one when the capacity is full.
- l. When completed, click **Apply** to confirm and save your settings. If you want to cancel all of your editing, click **Restore** to return to the previous settings or click **close** to discard the settings.

Add New Storage Group(s)

If you want to add a new storage group, click  **Add** to give a name to the new storage group, which will be displayed on the drop-down list.

The following is an example of storage group list.

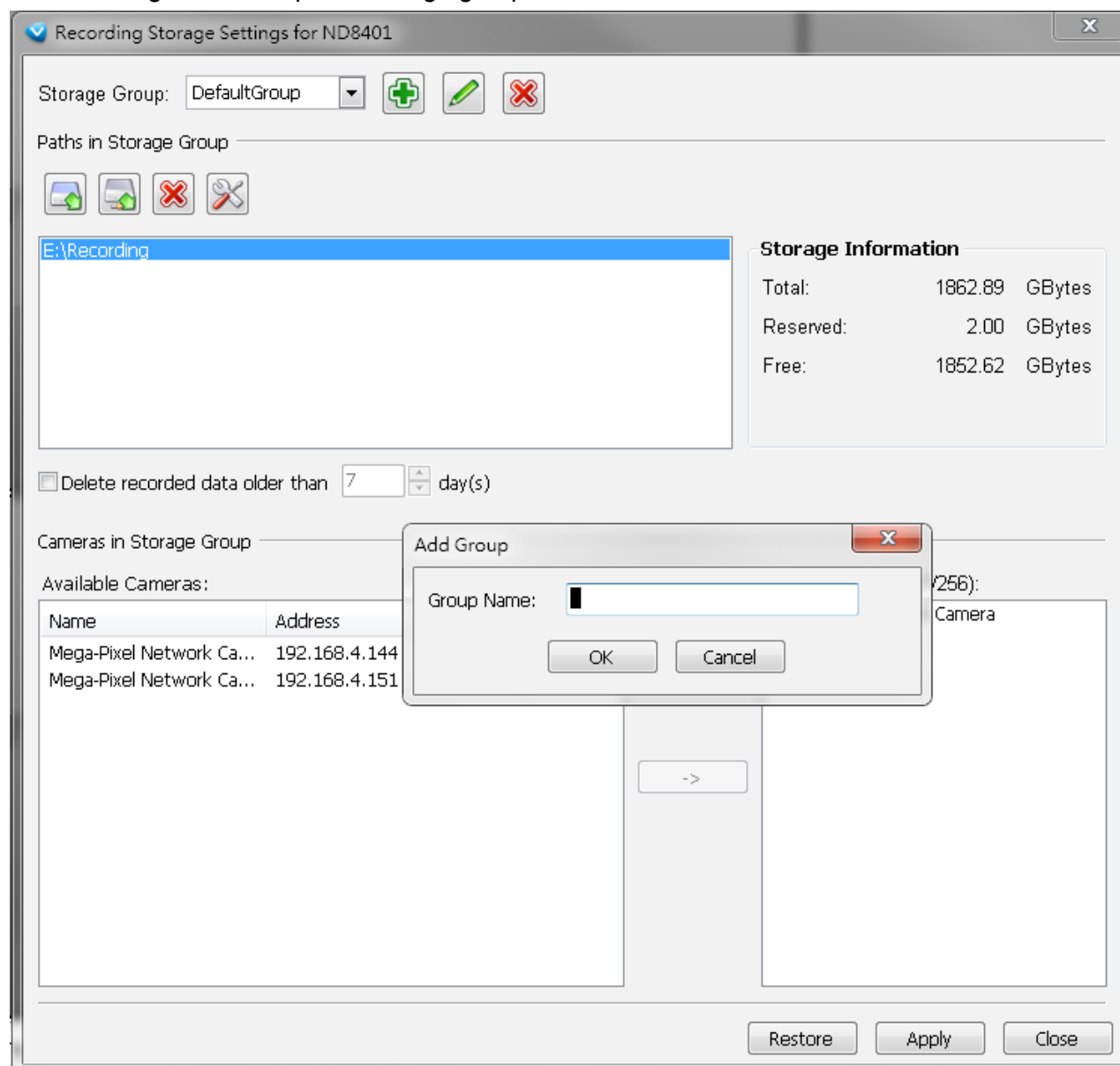

NOTE:

Please refer to the following limitations when you set up storage group(s):

- One storage group can be assigned with several recording paths with the associated cyclic recording function; while one recording path should only be assigned to one storage group.

How to Edit Recording Schedules

After editing recording storage settings, you can begin to edit recording schedules for the devices in a storage group. By default, all devices are assigned to the default recording schedule (Please refer to the default time frame settings on page 92). Therefore, once you insert a device to the station, the VAST Server will begin to record live video according to the default recording schedule. You can also manually remove a device from the default recording schedule. Please note that **you cannot assign recording schedules to those devices which have been deleted from a Storage Group.**

The following is an illustration of a set of recording schedules, which are composed of several time frames. Each time frame has its own time segments, period of time, repeat interval, and recording mode. You can create different recording schedules with simple or complex time frames based on your needs.

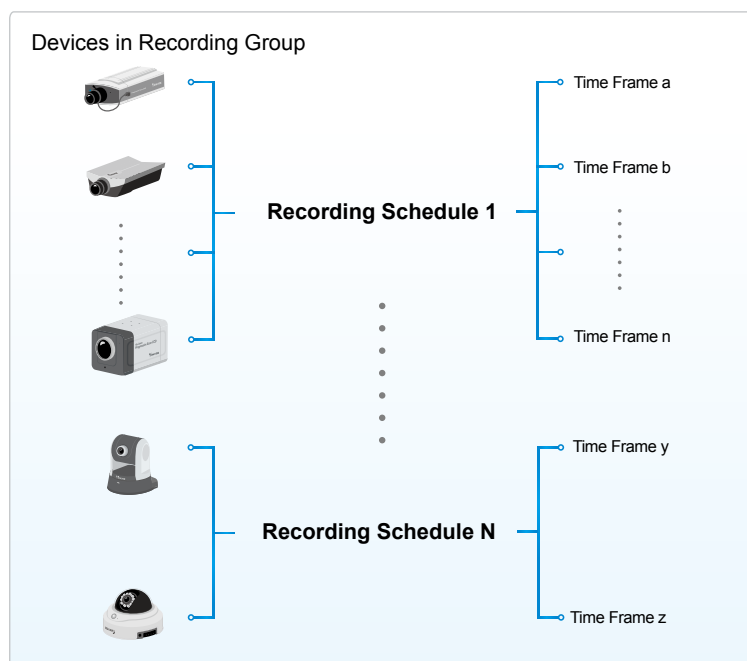

In addition, you can arrange the priority of each time frame according to its importance. The recording schedule with the highest priority will be applied first. This capability is very useful because you can specify a new time frame with the highest priority temporarily without modifying the other time frames.

Features of the recording schedules:

- Each device can be assigned to only one recording schedule.
- Each recording schedule may contain many time frames.
- Each time frame has its own repetition frequency and recording mode.

To save time editing recording schedules and time-frames, we also provide a useful **template** function to save your time on schedules/time-frames settings. That is, you can save a specified schedule and download it as a template for future use or upload a well-arranged schedule template designed by others.

Please note that after you save the recording settings in the server, the recording schedule will automatically begin according to your settings.

Edit Schedule List

Please follow the steps below to set up the recording schedules:

- Select the VAST station from the hierarchical device tree.
- Click **Configuration > Station Settings > Recording Schedule Settings** on the menu bar (or **right-click** the station and select **Station Settings > Recording Schedule Settings**).

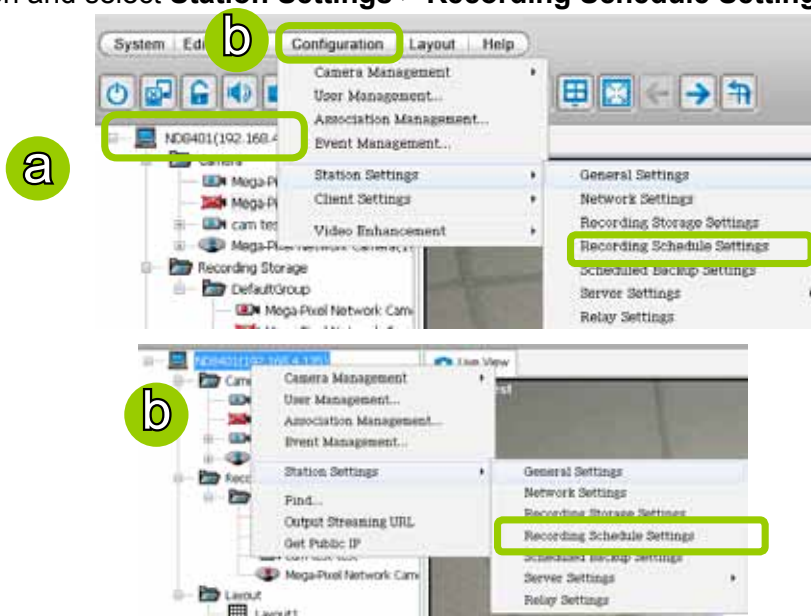

- The **Recording Schedule Settings** window will prompt. By default, all cameras managed by the station will be assigned to **Default Schedule**, **Default Time Frame**, and **Default Camera List**.

Add Schedules

- To add a new recording schedule, click **Add** to enter a name in the Schedule Name dialog box for the new schedule. Click **OK** to confirm the settings or **Cancel** to discard the settings. The new recording schedule will be displayed on the schedule drop-down list.

Rename Schedules

- To rename an existing schedule, select the schedule from the schedule drop-down list and click **Rename**. A Schedule Name dialog will pop up for you to fill in a name for the new schedule. Click **OK** to confirm the settings or **Cancel** to discard the settings. The new recording schedule will be displayed on the schedule drop-down list.

Delete Schedules

- To delete an existing schedule, select the schedule from the schedule drop-down list and click **Delete**. A Remove Schedule dialog box will pop up. Click **OK** to confirm or **Cancel** to discard the settings.

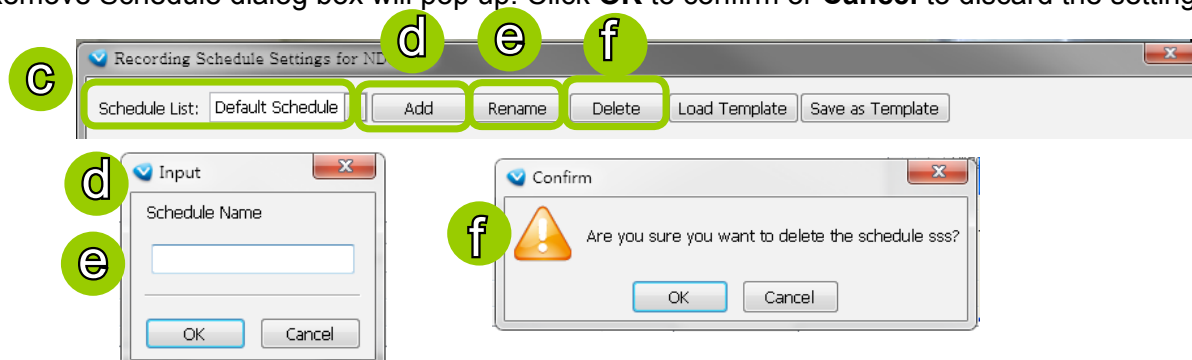

Load/Save Schedule Templates

- g. If you have a schedule template with time frame settings, you can upload it to facilitate the scheduling process. Click **Load Template**, and a **Load File** dialog box will pop up. Select the template file and click **Open** to load.
- h. If you want to save a schedule as a template for future use, select the schedule from the schedule drop-down list and click **Save as Template**. A **Save File** dialog box will pop up for you to save the template file.

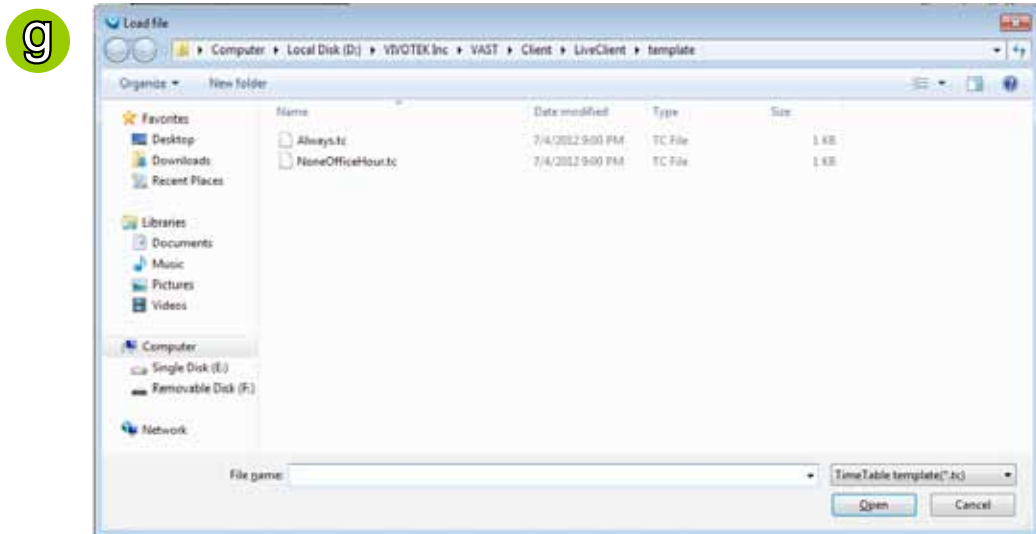
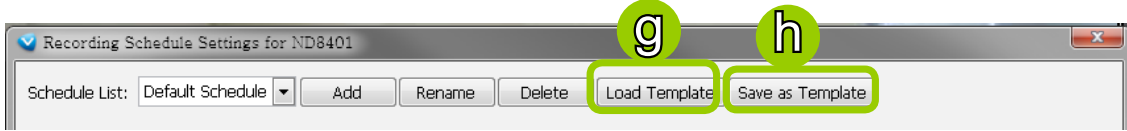

LiveClient provides two templates, Always and NoneOfficeHour. You can load and edit the time frame details.

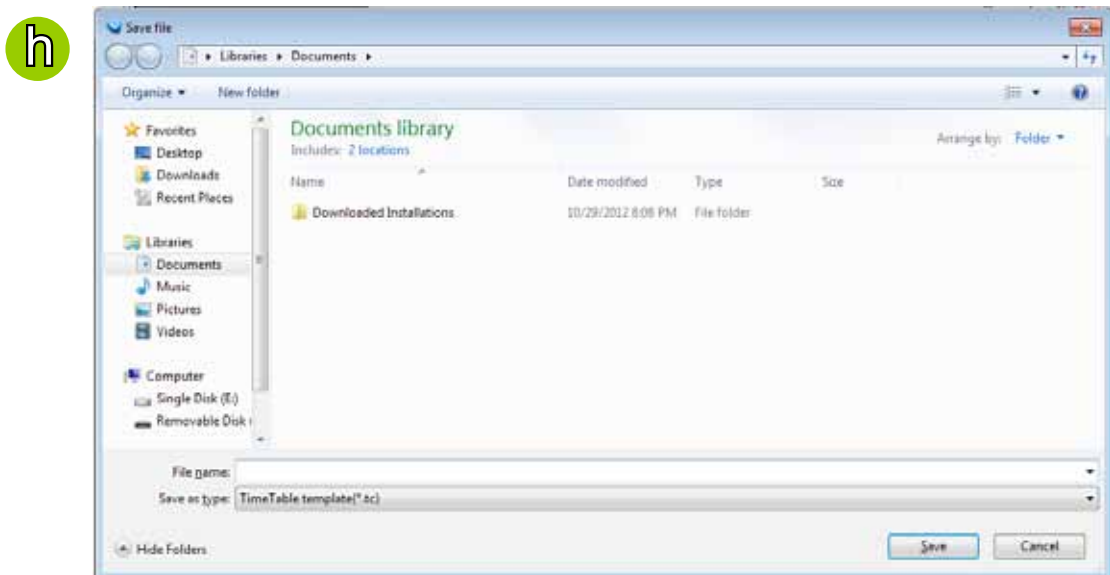

Edit Camera List

Please follow the steps below to assign a device to a recording schedule:

- Select a recording schedule on the schedule drop-down list.
- By default, all devices under the station are assigned to the **Default Schedule**.
- Click << to remove devices from the **Default Schedule**. Click -> to add devices to the **Default Schedule**.
- Click **Apply** to confirm or **Close** to discard the settings.

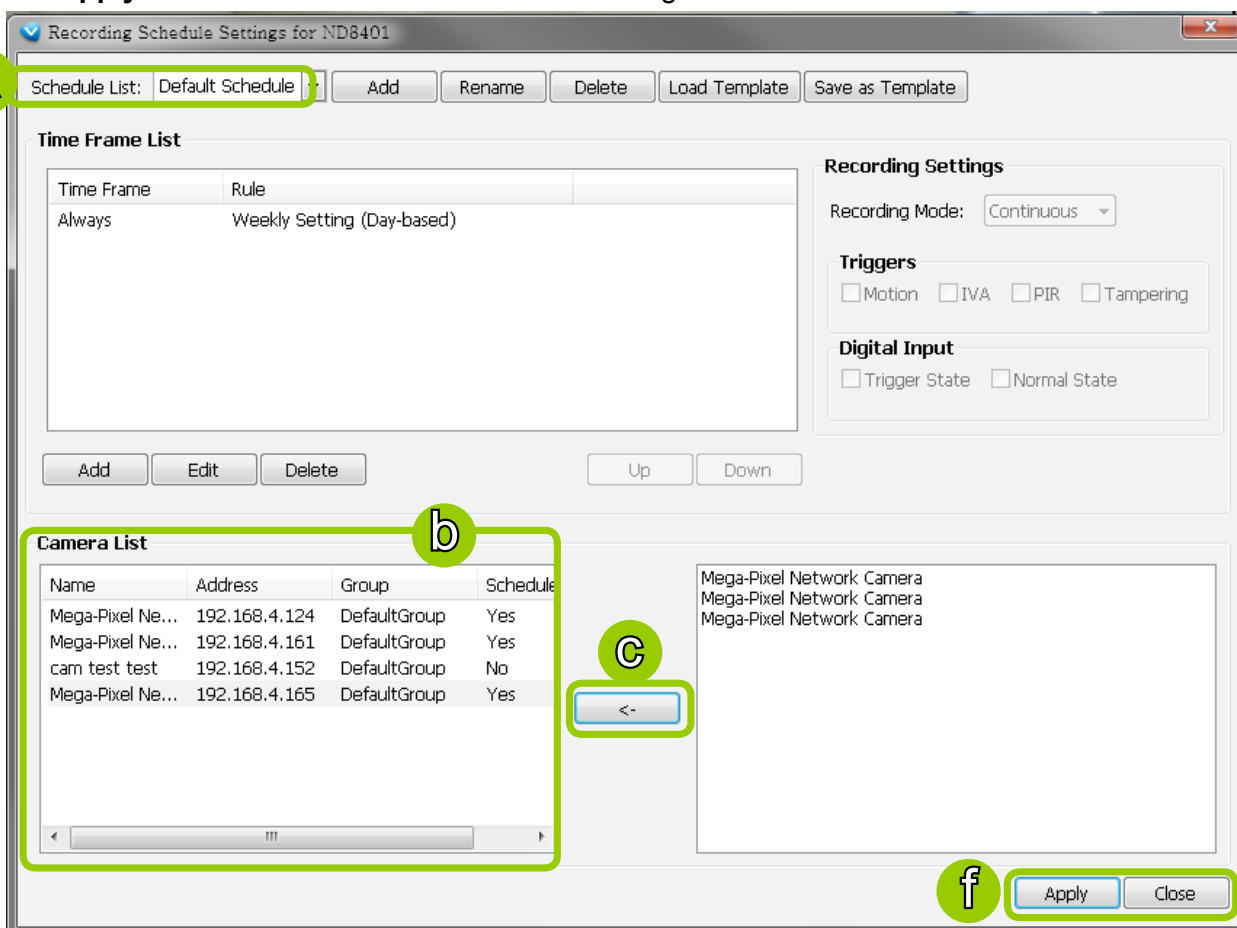

Edit Time Frame List

Default Time Frame: Weekly (Day-based), Mon.~Sun., 24-hour, continuous recording

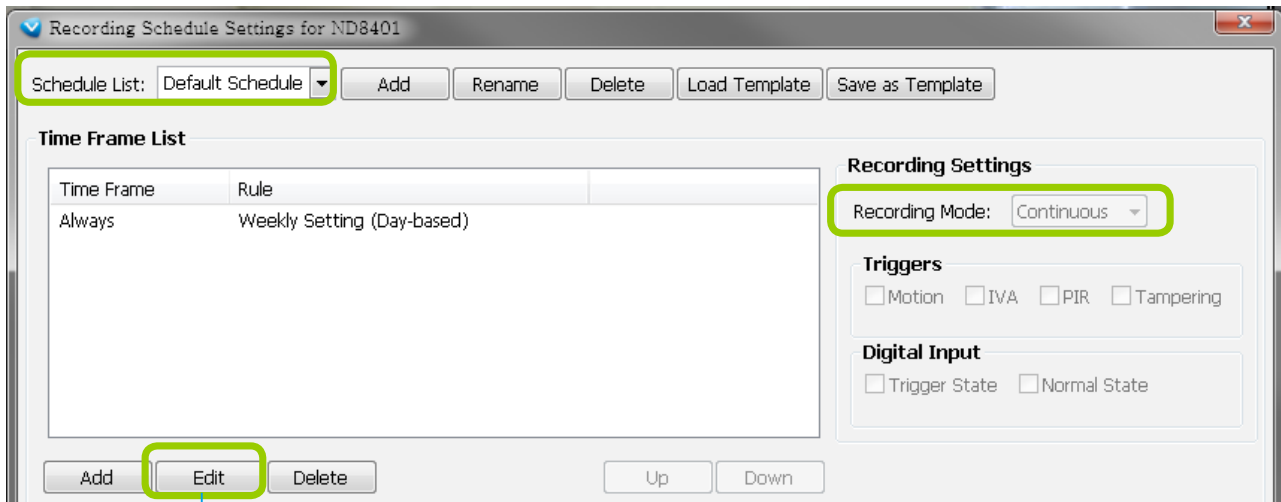

Click **Edit** to open the Default Time Frame settings page as shown below.

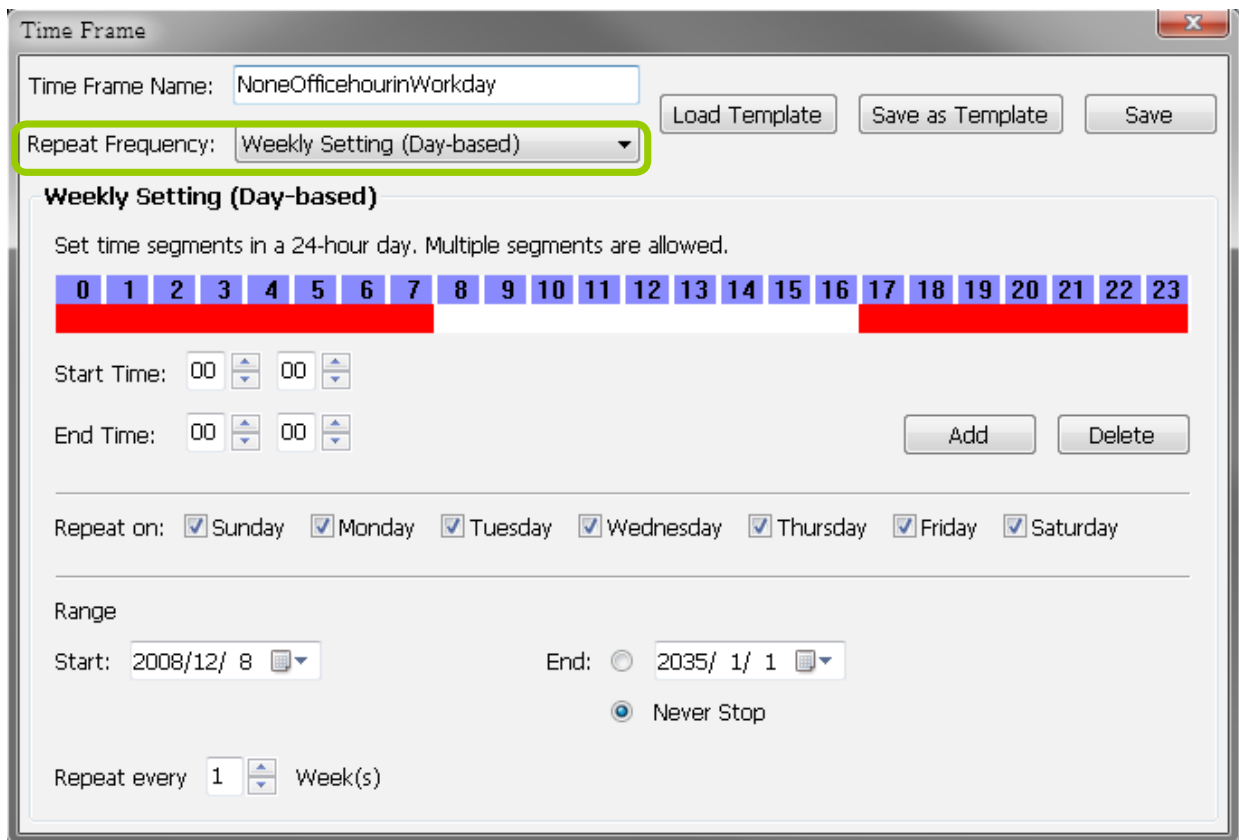

Add New Time Frames

Please follow the steps below to add new time frames to a schedule:

- a. Select a recording schedule from the drop-down list.
- b. Click **Add** to open the **Time Frame Settings** window.

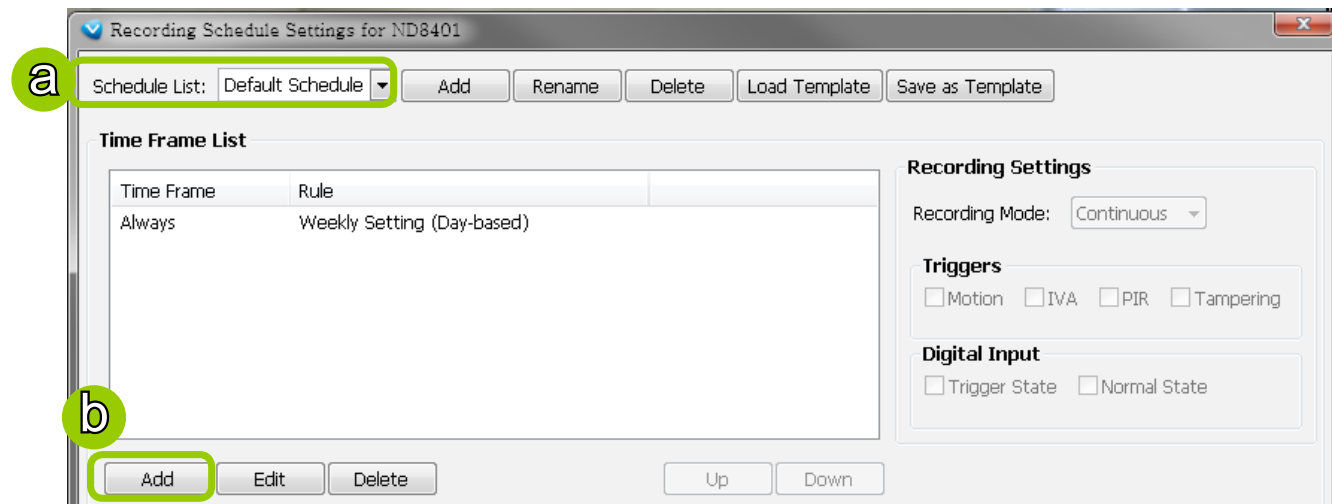

- c. Enter a name for the new time frame.
- d. If you have a time-frame template, you can upload it to simplify the editing of the schedule. Click **Load Template** and the **Load File** dialog box will pop up. Select the template file to load.
- e. To edit the new time frame, select a **Repeat Frequency** from the drop-down list and edit the time segments, applicable days, applicable period of time, and repeat time interval. For the detailed settings of each repeat frequency, please refer to **The Concept of Repeat Frequency** on page 95.
- f. When completed, click **Save** to enable the settings.
- g. If you want to save this time frame as a template for future use, click **Save as Template**. A **Save file** dialog will pop up for you to save the template.

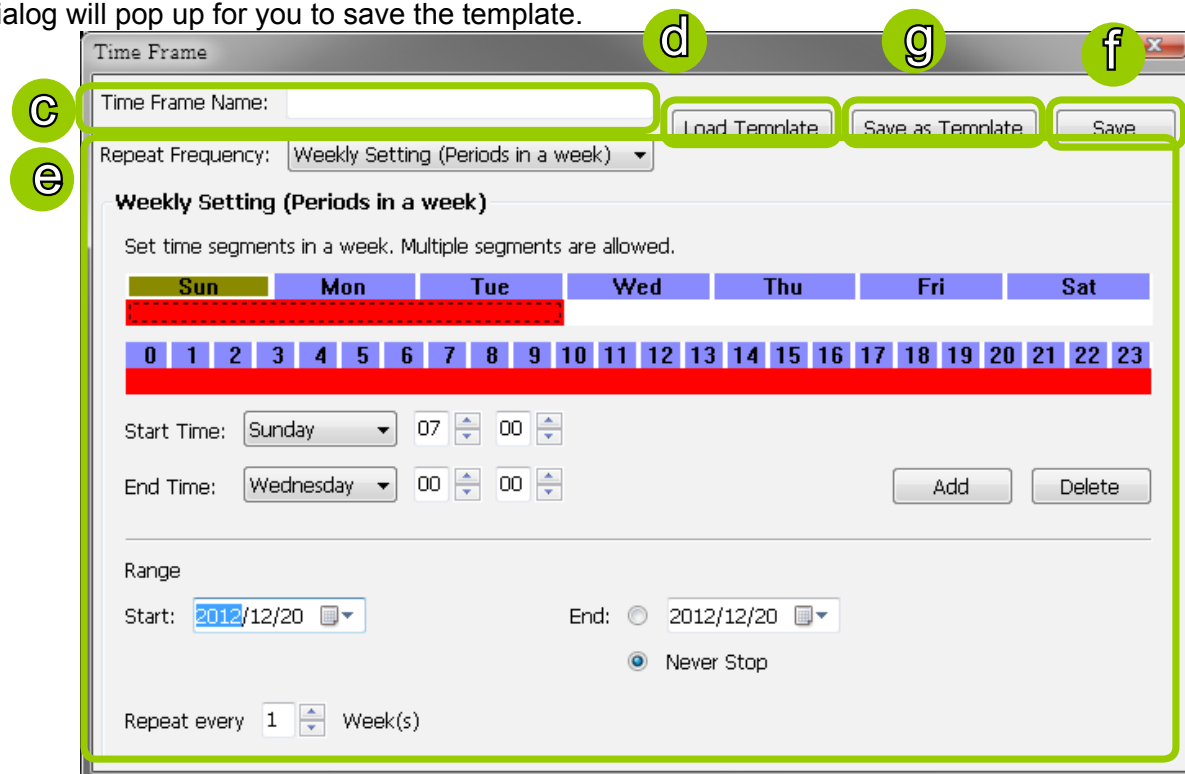

- h. If you want to add additional time frames to the schedule, repeat the steps above.
- i. Close the window when you finish the time frame settings.
- j. Back to the Recording Schedule Settings window, the new time frame will be displayed on the Time Frame List.
- k. If you want to edit an existing time frame, select it from the Time Frame List and click **Edit** to set up.
- l. If you want to delete an existing time frame, select it from the Time Frame List and click **Delete**.
- m. If you want to change the priority of a time frame, select it from the Time Frame List and click **Up** or **Down** to shift its position. The time frame on the top of the list has the highest priority.

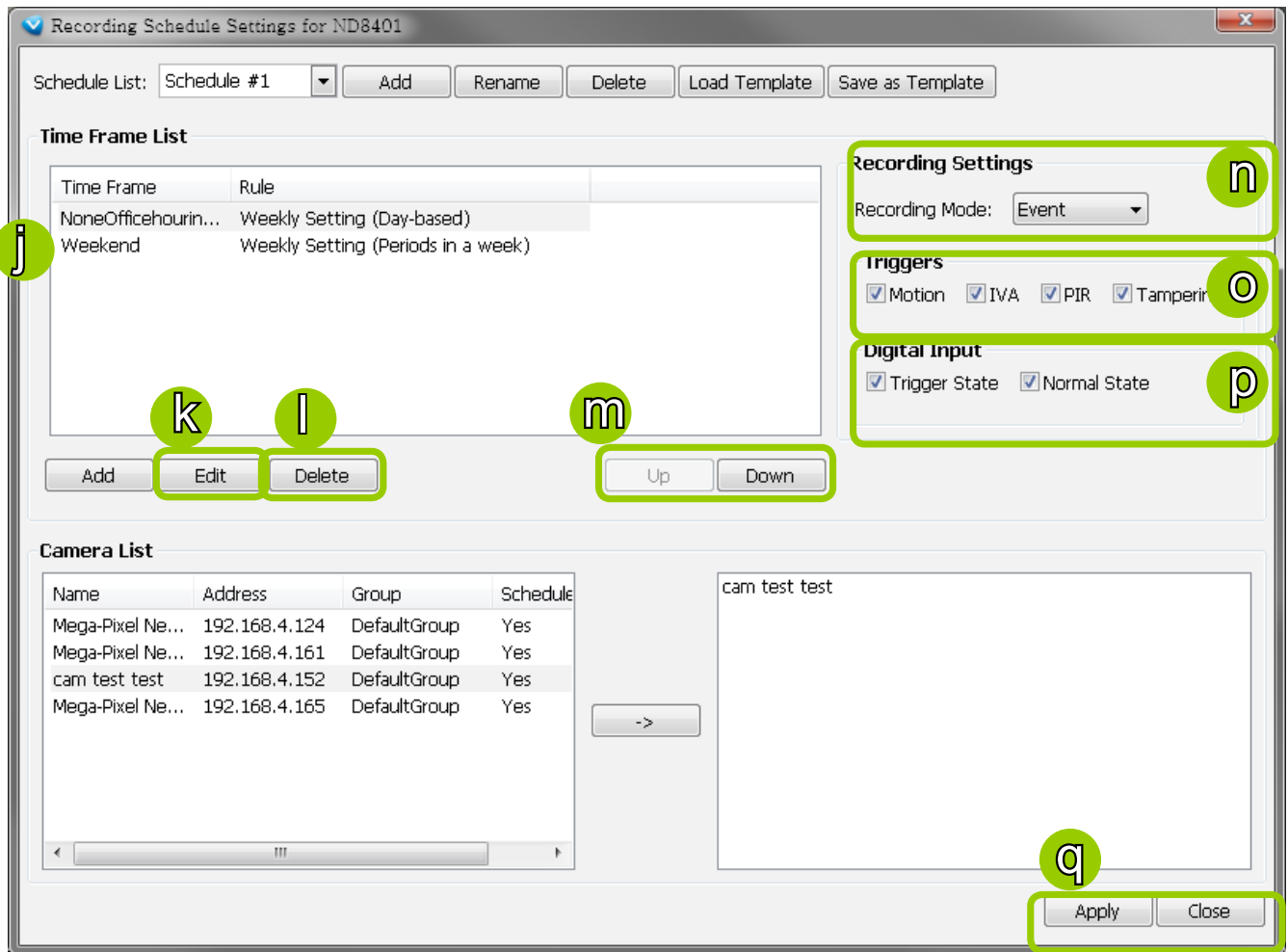

Recording Settings

- n. Select one of the following Recording Modes for the time frame:
 - **None:** No recording action.
 - **Continuous:** 24-hours continuous recording. If you want to enable Activity Adaptive Streaming, please refer to page 87 for detailed illustration.
 - **Event:** The server will start to record only when an event is triggered. The recording time length depends on the settings in Recording Storage Settings. The default time length is 20 seconds (10s pre-event time plus 10s post-event time). Please refer to page 86 for more information. For more information about event categories, please refer to page 172 for detailed illustration.
- o. Select Trigger Source(s): Motion Detection, IVA (Intelligent Video Analysis), PIR, and Tamper Detection
- p. Select the status of Digital Input(s): Trigger State or Normal State
- q. Click **Apply** to confirm the settings. Then close the window when you finish the recording schedule settings.

NOTE:

The following diagrams show the frame rate variations using two different recording modes:
 1. Continuous recording + Activity adaptive recording (helps save bandwidth and storage)

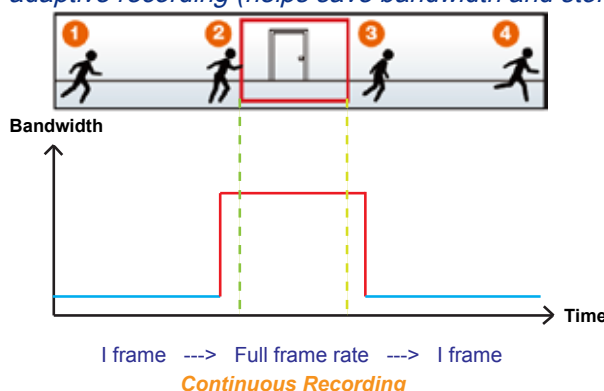

2. Event recording

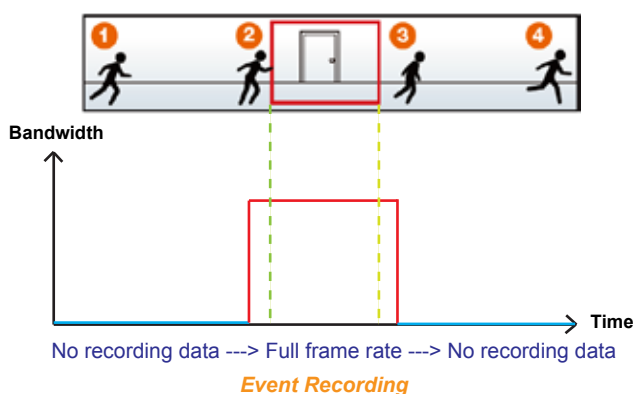

The Concept of Repeat Frequency

VAST offers the following types of repeat frequency. The definition of each type is listed in the following table:

Repeat Frequency	Discription
Daily Setting	<ul style="list-style-type: none"> Specify arbitrary time segments within a day, Repeat the segments every N days in the specified period of time.
Weekly Setting (Day-based) (Default Time Frame)	<ul style="list-style-type: none"> Specify arbitrary time segments within a day, Apply only on selected days of a week, Repeat the segments every N weeks during the specified period of time.
Weekly Setting (Periods in a week)	<ul style="list-style-type: none"> Specify arbitrary time segments within a week, Repeat the segments every N weeks during the specified period of time.
Monthly Setting (Day-based)	<ul style="list-style-type: none"> Specify arbitrary time segments within a day, Apply only on selected days of a month, Repeat the segments every N months during the specified period of time.
Yearly Setting (Day-based)	<ul style="list-style-type: none"> Specify arbitrary time segments within a day, Apply only on selected days of a year, Repeat the segments every N years during the specified period of time.

Repeat Frequency: Daily Setting

To set up daily repeat frequency, please configure the following items: Daily time segments, applicable period of time, and repeat time interval.

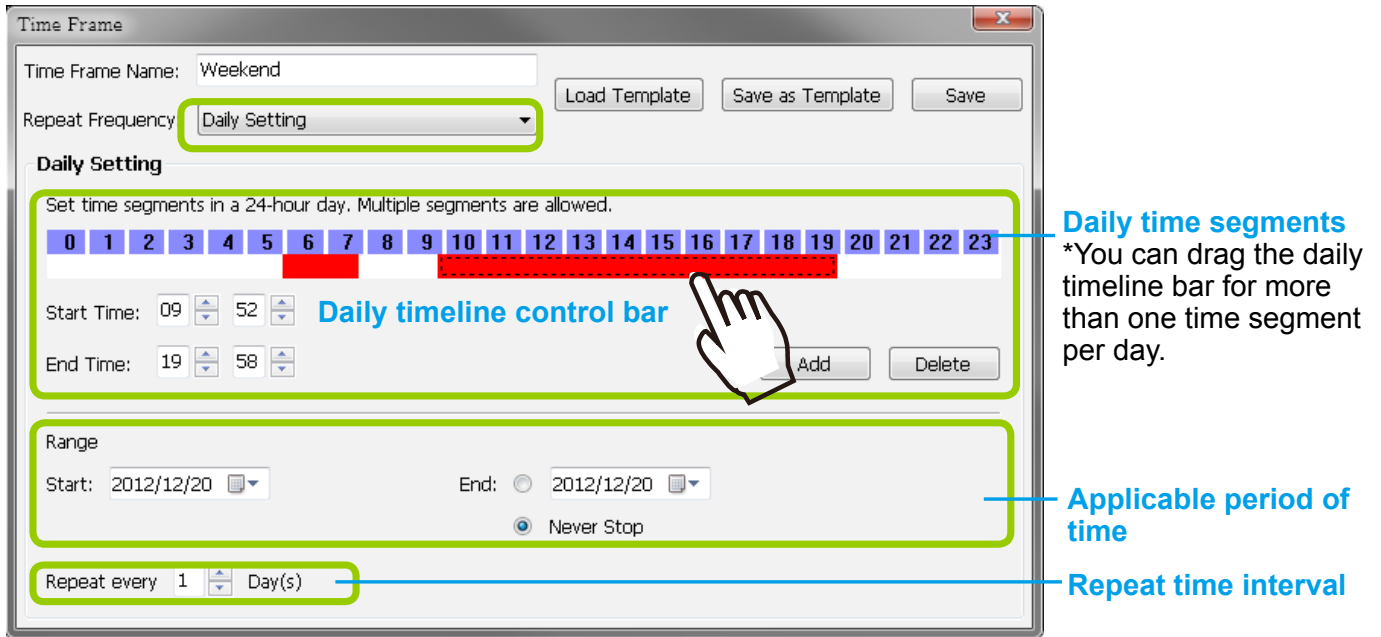

Set up daily time segments

You can specify several time segments within a day. The numbers 0~23 on the **hourly timeline control bar** (the purple rectangles) represent the 24 hours in a day.

There are two ways to define time segments: one is to use the computer mouse to manipulate the timeline control bars; the other is to fill in the precise start and end time values in the corresponding fields.

Add time segments: Choose either step 1 or step 2 to set up

1. Use the mouse to drag the timeline bars:
 - a. **Left-click** the **daily timeline control bar** (the purple rectangles) and drag the mouse.
 - b. The corresponding time segment will also appear in the Start Time and End Time fields. Click **Add**, then the red timeline bars representing new time segments will appear as shown below. You can drag multiple time segments within a day.

In the following illustration, the yellow arrows show the dragging direction of the mouse. You can drag from left to right or the opposite.

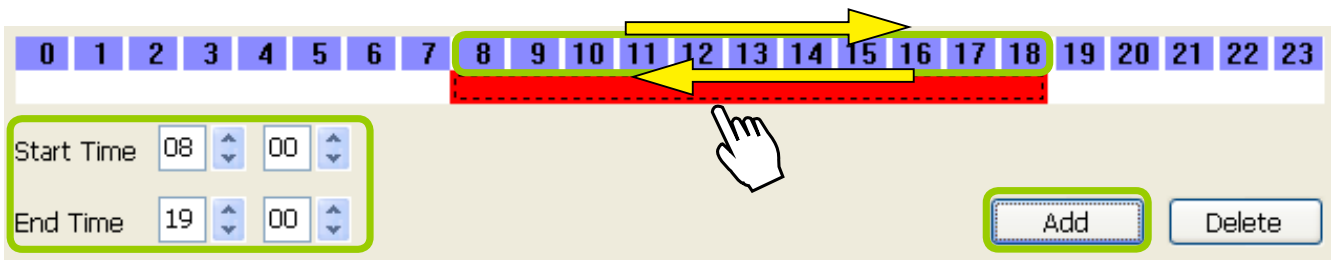

2. Fill in the precise Start Time and End Time:

- a. Directly enter the value in the Start Time and End Time fields, then click **Add**.
- b. The corresponding red timeline bar will automatically appear as shown below.

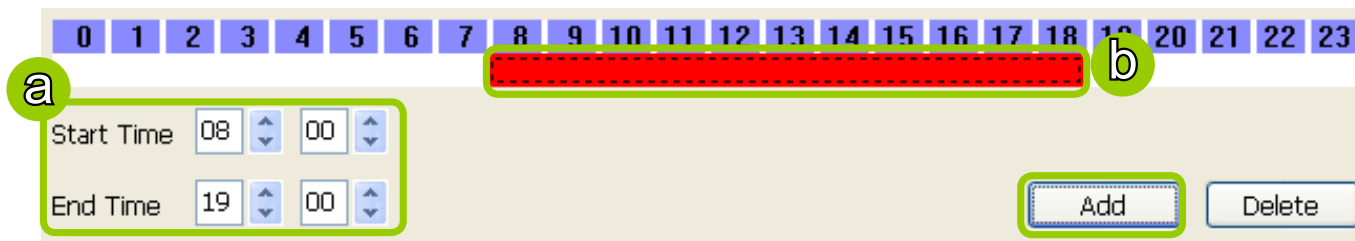

Delete time segments: Choose either step 1 or step 2 to set up

1. Use the mouse to erase the timeline bar: **Right-click** on an existing red timeline bar and drag the mouse. A green timeline bar representing the deleted part of the time segment will erase the red bar as shown below.

In the following illustration, the green arrows show the dragging direction of the mouse. You can drag it from left to right or the opposite.

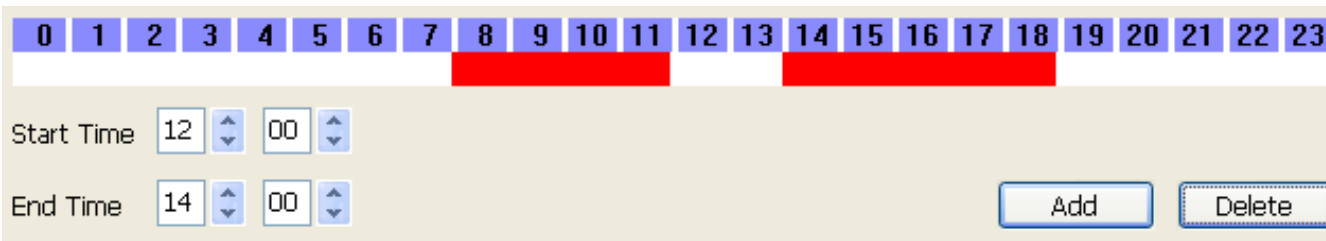
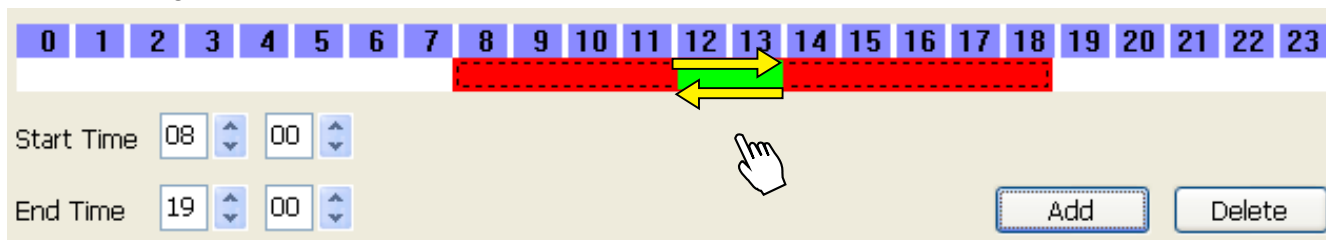

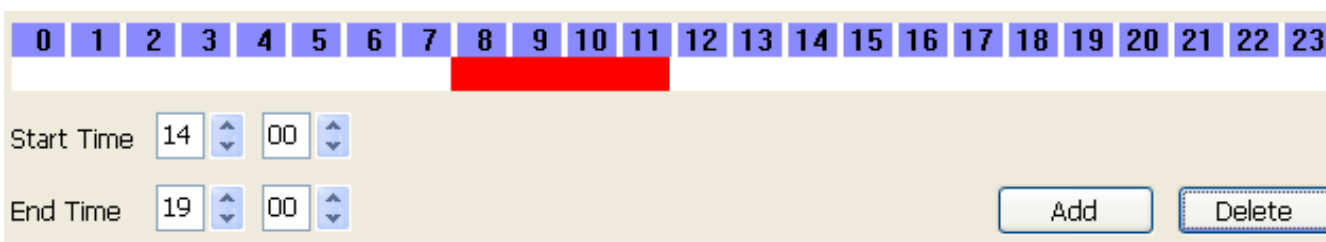
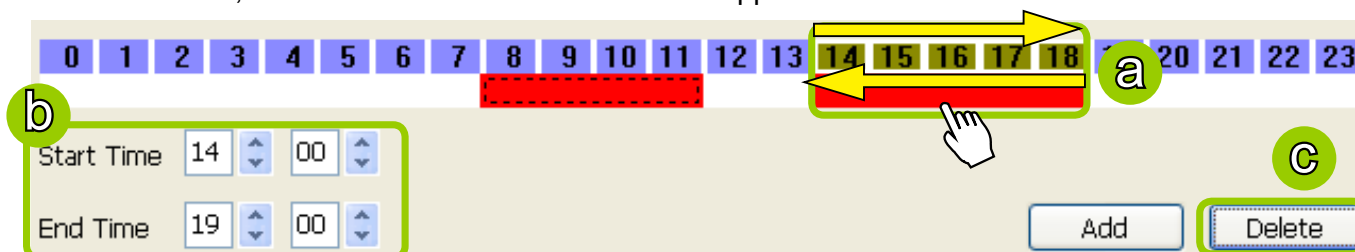

2. Use the delete button to remove the entire timeline bar:

- a. Click an existing red timeline bar or **left-click** the **daily timeline control bar** (the purple rectangles) and drag the mouse.
- b. The corresponding time segment will appear in the Start Time and End Time fields.
- c. Click **Delete**, and the selected timeline bar will disappear.



Set up applicable period of time

For repeat frequencies, you can set up the applicable date and period of time for the time frame.

- a. Specify the start date and time in the **Start** field. A calendar date selector will appear when you click on the drop-down list of **date**. Click  or  to select the month, then pick a desired day in the calendar.
- b. Specify the end date and time in the **End** field if you have an end time for applying this time frame. If you do not have a terminating time for this time frame, select **Never Stop**.

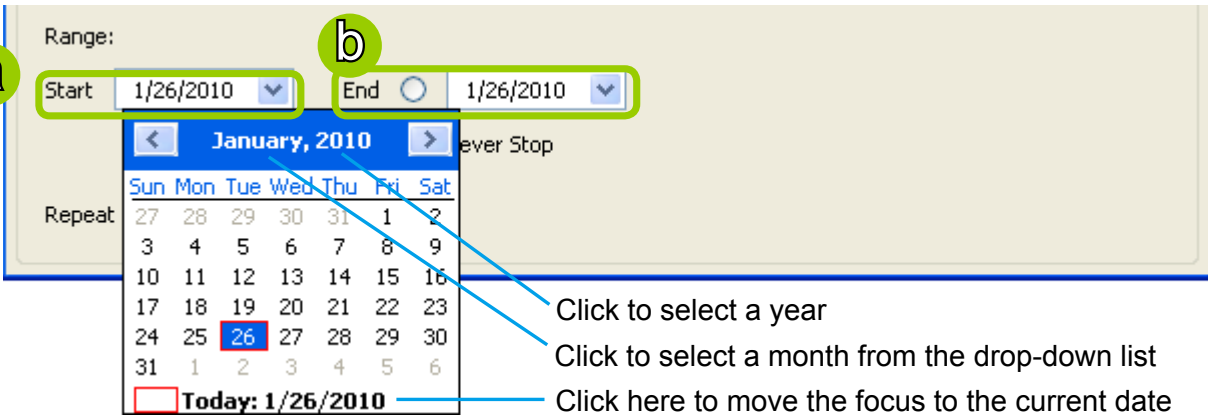

Range:

Start End Never Stop

Repeat

Sun	Mon	Tue	Wed	Thu	Fri	Sat
27	28	29	30	31	1	2
3	4	5	6	7	8	9
10	11	12	13	14	15	16
17	18	19	20	21	22	23
24	25	26	27	28	29	30
31	1	2	3	4	5	6

Today: 1/26/2010

Click to select a year

Click to select a month from the drop-down list

Click here to move the focus to the current date

Set up repeat time interval

The repeat time intervals is "every N day(s)" as shown below. Repeat every 1 day means the time frame would apply for every day within the period of time.

Repeat every Day(s)

Repeat Frequency: Weekly Setting (Day-based)

To set up Weekly (Day-based) repeat frequency, please configure the following items: Daily time segments, applicable days within a week, applicable period of time, and repeat time interval.

Time Frame

Time Frame Name: Weekend

Repeat Frequency: Weekly Setting (Day-based)

Weekly Setting (Day-based)

Set time segments in a 24-hour day. Multiple segments are allowed.

Daily timeline control bar (24h)

Start Time: 00:00

End Time: 00:00

Repeat on: Sunday Monday Tuesday Wednesday Thursday Friday Saturday

Range

Start: 2012/12/20

End: 2012/12/20 Never Stop

Repeat every 1 Week(s)

Daily Time segments
*You can drag more than one time segment per day.

Applicable days within a week

Applicable period of time

Repeat time interval

Set up daily time segments

Please refer to page 96 for detailed instructions.

Set up applicable days within a week

For repeat frequency--"Weekly (day based)", you can apply the time segments only on selected days of the week.

Repeat on Sunday Monday Tuesday Wednesday Thursday Friday Saturday

Set up applicable period of time

Please refer to page 98 for detailed instructions.

Set up repeat time interval

The repeat time intervals is "every N week(s)" as shown below. Repeat every 1 week means the time frame would apply for every week within the period of time.

Repeat every 1 Week(s)

Repeat Frequency: Weekly Setting (Periods in a week)

To set up Weekly (Periods in a week) repeat frequency, please configure the following items: Time segments within a week, applicable period of time, and repeat time interval.

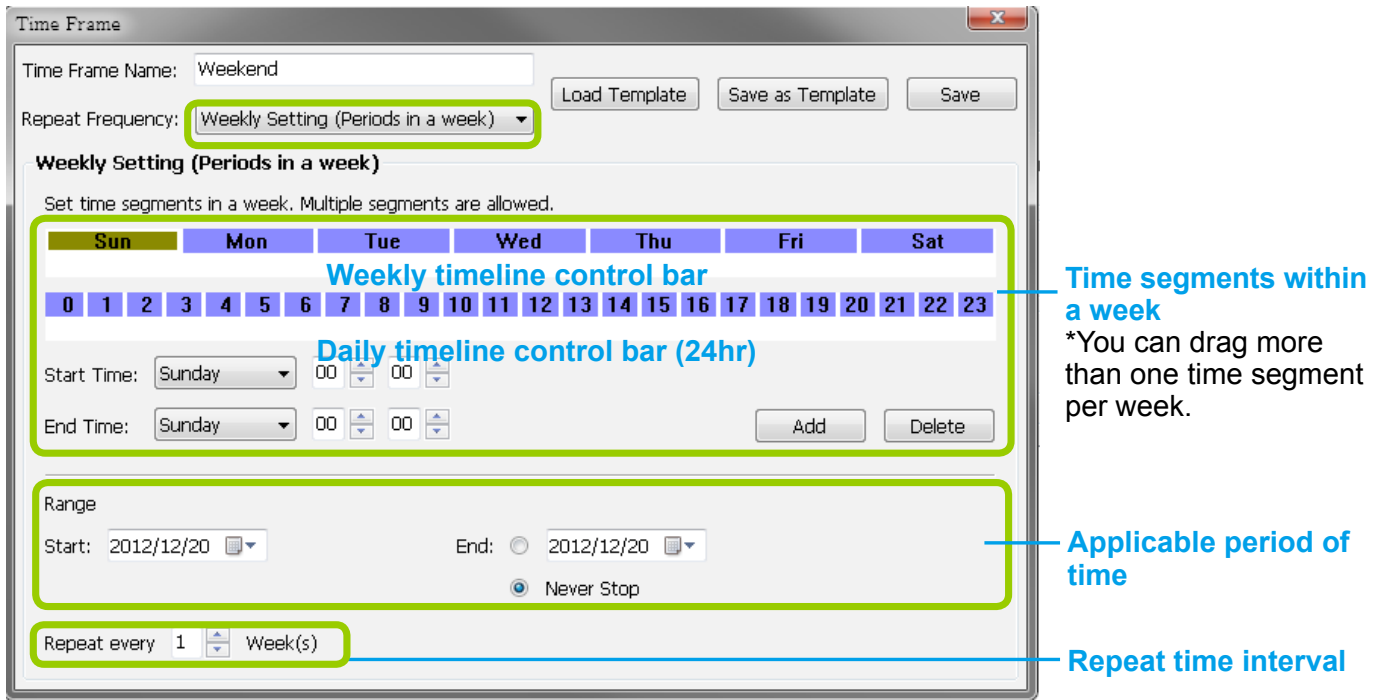

Set up time segments within a week

You can specify several time segments within a week. The **weekly timeline control bar** represents the 7 days of a week, and the **daily timeline control bar** represents the 24 hours in a day. The daily timeline control bar is only valid when one of the days on the weekly timeline control bar has been selected.

There are two ways to set up time segments: one is to clicking and holding down the left mouse button to draw the timeline control bars; the other is to fill in the precise start and end time value in the corresponding fields.

Add time segments: Choose either step 1 or step 2 to set up

1. Use the mouse to drag the timeline bars:
 - a. Click on a day on the **weekly timeline control bar**. The selected bar will turn green.
 - b. **Left-click** the **daily timeline control bar** and drag the mouse.
 - c. The corresponding time segment will also appear in the Start Time and End Time fields. Click **Add**, then the red timeline bars representing new time segments will appear as shown below. You can drag multiple time segments within a day and a week.

In the following illustration, the yellow arrows show the dragging direction of the mouse. You can drag from left to right or the opposite.

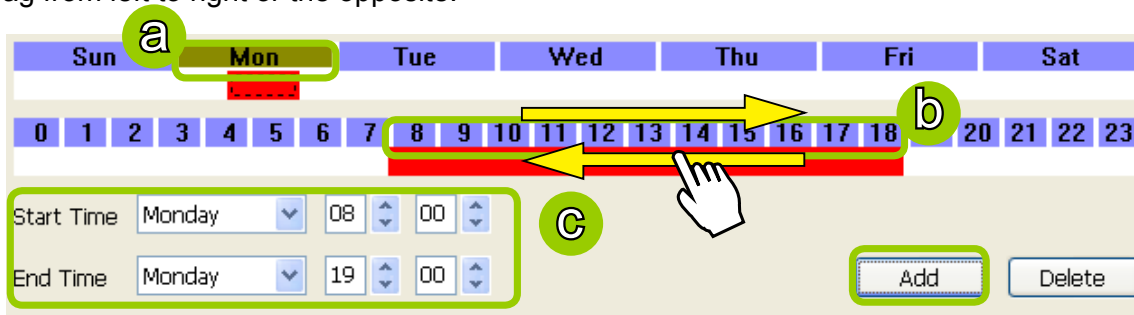

2. Fill in a precise Start Time and End Time:

- a. Directly select a day and enter the value in the Start Time and End Time fields, then click **Add**.
- b. The corresponding red timeline bars will automatically appear as shown below.

The following is an example of an extended time segment from Mon. 8:00 to Fri. 19:00.

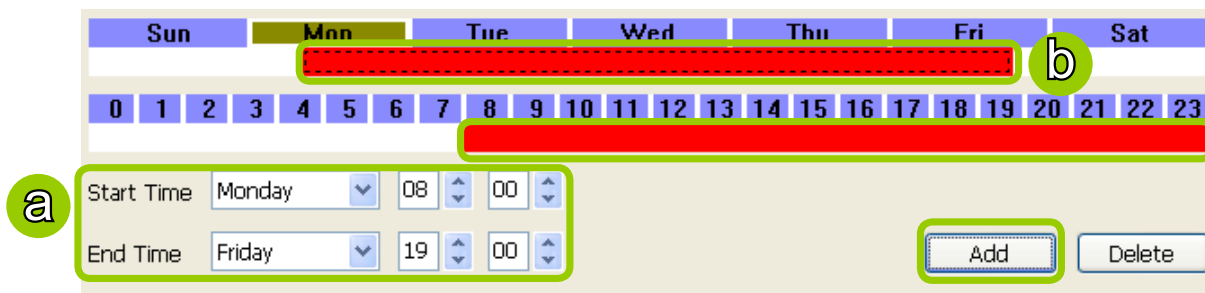

Delete time segments: Please refer to page 97 for detailed instructions.

Set up applicable period of time

Please refer to page 98 for detailed instructions.

Set up repeat time interval

Please refer to page 99 for detailed instructions.

Repeat Frequency: Monthly Setting (Day-based)

To set up Monthly (Day-based) repeat frequency, please configure the following items: Daily time segments, applicable date(s) of a month/ day(s) of a week, applicable period of time, and repeat time interval.

Time Frame

Time Frame Name: Weekend

Repeat Frequency: Yearly Setting (Day-based)

Yearly Setting (Day-based)

Set time segments in a 24-hour day. Multiple segments are allowed.

Timeline control bar (24hr)

Start Time: 00:00

End Time: 00:00

Repeat on: Date (of a year)

December 2012

Sun	Mon	Tue	Wed	Thu	Fri	Sat
						1
2	3	4	5	6	7	8
9	10	11	12	13	14	15
16	17	18	19	20	21	22
23	24	25	26	27	28	29
30	31					

Range

Start: 2012/12/20

End: 2012/12/20

Never Stop

Repeat every 1 Year(s)

Daily time segments
*You can drag more than one time segment per day.

Applicable date(s) of a month/ day(s) of a week

Applicable period of time

Repeat time interval

Set up daily time segments

Please refer to page 96 for detailed instructions.

Set up applicable date(s) of a month/ day(s) of a week

For repeat frequency--"monthly (day-based)", you can apply the time segments only on selected days of a month. There are two types of repeat frequencies: Date(s) of a month and Day(s) of a week.

Repeat by date(s) of a month:

Select date(s) from the calendar, and it will be displayed on the right blank as shown below. The following example refers to the 1st ~ 5th day of a month.

Repeat on **Date (of a month)**

January 2010 Repeat on the following date(s) of a month:

Sun	Mon	Tue	Wed	Thu	Fri	Sat
					1	2
3	4	5	6	7	8	9
10	11	12	13	14	15	16
17	18	19	20	21	22	23
24	25	26	27	28	29	30
31						

01
02
03
04
05

Delete

Repeat by day(s) of a week:

Select day(s) from the calendar, and it will be displayed on the right blank as shown below. The following example refers to the 1st ~ 5th Friday of a month.

Repeat on **Day (of a week)**

January 2010 Repeat on the following day(s) of a month:

Sun	Mon	Tue	Wed	Thu	Fri	Sat
					1	2
3	4	5	6	7	8	9
10	11	12	13	14	15	16
17	18	19	20	21	22	23
24	25	26	27	28	29	30
31						

1st Friday
2nd Friday
3rd Friday
4th Friday
5th Friday

Delete

Set up applicable period of time

Please refer to page 98 for detailed instructions.

Set up repeat time interval

The repeat time intervals is "every N month(s)" as shown below. Repeat every 1 month means the time frame would apply for every month within the period of time.

Repeat every Month(s)

Repeat Frequency: Yearly Setting (Day-based)

To set up Yearly (Day-based) repeat frequency, please configure the following items: Daily time segments, applicable date(s) of a year/ day(s) of a week, applicable period of time, and repeat time interval.

The screenshot shows the 'Time Frame' configuration window with the following components and callouts:

- Time Frame Name:** NoneOfficehourinWorkday
- Repeat Frequency:** Yearly Setting (Day-based)
- Yearly Setting (Day-based):**
 - Timeline control bar (24hr): A bar with 24 segments (0-23) for setting daily time segments.
 - Start Time: 00:00, End Time: 00:00
 - Buttons: Add, Delete
- Repeat on:** Date (of a year)
 - Month: December, Year: 2012
 - Calendar: Shows dates from 1 to 31, with 12/06 and 12/27 selected.
 - Text: Repeat on the following date(s) of a year:
 - Buttons: Delete
- Range:**
 - Start: 2012/12/20
 - End: 2012/12/20 (radio button selected)
 - Never Stop (radio button selected)
- Repeat every:** 1 Year(s)

Callouts on the right side of the window:

- Daily time segments** *You can drag more than one time segment per day.
- Applicable date(s) of a year/ day(s) of a week**
- Applicable period of time**
- Repeat time interval**

Set up daily time segments

Please refer to page 96 for detailed instructions.

Set up applicable date(s) of a year/ day(s) of a week

For repeat frequency--"yearly (day-based)", you can apply the time segments only on selected days of a year. There are two types of repeat frequencies: Date(s) of a year and Day(s) of a week.

Repeat by date(s) of a year:

Select date(s) from the calendar, and it will be displayed on the right blank as shown below. The following example refers to the 1st ~ 5th day of a year.

Repeat on Date (of a year)

January 2010

Sun	Mon	Tue	Wed	Thu	Fri	Sat
					1	2
3	4	5	6	7	8	9
10	11	12	13	14	15	16
17	18	19	20	21	22	23
24	25	26	27	28	29	30
31						

Repeat on the following date(s) of a year:

01/01
01/02
01/03
01/04
01/05

Delete

Repeat by day(s) of a week:

Select day(s) from the calendar, and it will be displayed on the right blank as shown below. The following example refers to the January 1st ~ 5th Friday of a year.

Repeat on Day (of a week)

January 2010

Sun	Mon	Tue	Wed	Thu	Fri	Sat
					1	2
3	4	5	6	7	8	9
10	11	12	13	14	15	16
17	18	19	20	21	22	23
24	25	26	27	28	29	30
31						

Repeat on the following day(s) of a year:

January 1st Friday
January 2nd Friday
January 3rd Friday
January 4th Friday
January 5th Friday

Delete

Set up applicable period of time

Please refer to page 98 for detailed instructions.

Set up repeat time interval

The repeat time intervals is "every N year(s)" as shown below. Repeat every 1 year means the time frame would apply for every year within the period of time.

Repeat every Year(s)

How to Manually Begin /Stop Recording

By default, all devices are assigned to the default recording storage and default recording schedule. Therefore, once you included a camera into the NVR's configuration, the VAST Server will begin to record live video according to the default recording schedule. Please refer to **How to Edit Recording Schedules** on page 88.

However, if you have changed the default schedule, you can manually click **Manually Begin Recording** to enable a device without setting up a recording schedule. Please follow the instructions below to manually begin recording.

Select the device from the hierarchical device tree under the Default Group, then click **Edit > Manually Begin Recording** on the menu bar (or **right-click** the device and select **Manually Begin Recording**). The text on the menu bar will turn into **Manually Stop Recording** as shown below and the VAST Server will start to record video from the target camera. Please note that its priority will be higher than the recording schedule, and the recording task will continue unless you click on **Manually Stop Recording**. After you click **Manually Stop Recording**, the device will then follow the preset recording schedule.

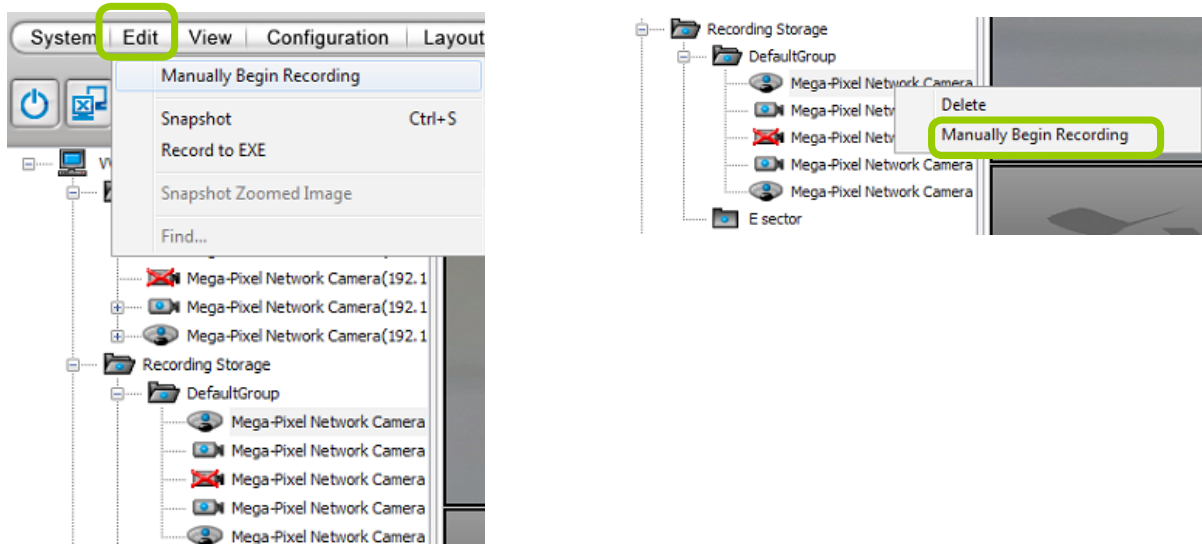

How to Edit Scheduled Backup Settings

VAST LiveClient supports scheduled backup which allows the user to back up the recorded data in another disk.

Please follow the steps below to enable scheduled backup settings:

- Select the target station from the device tree.
- Click **Configuration > Station Settings > Scheduled Backup Settings** on the menu bar (or **right-click** the station and select **Station Settings > Scheduled Backup Settings**).

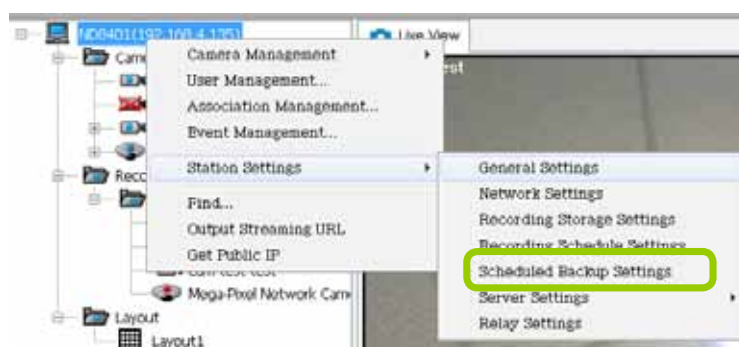
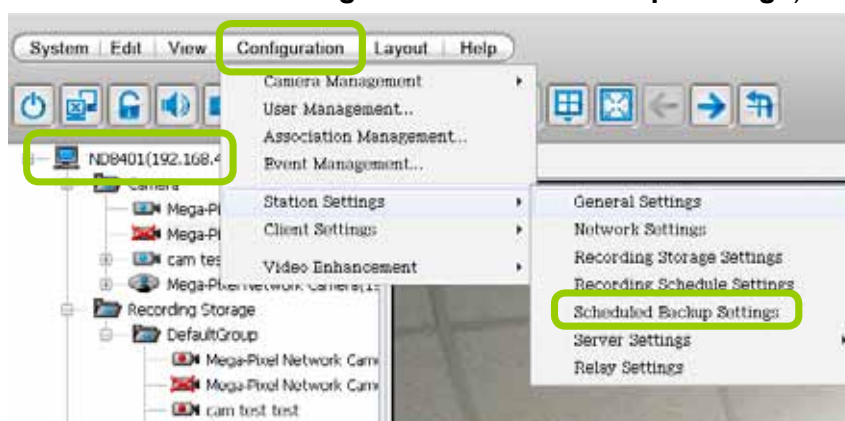

- The **Scheduled backup settings** window will prompt.

Select Backup Source

- Check Enable schedule backup.
- Select the data source you want to backup. If you check **Selected cameras**, you can click >> or << to choose the data source that you want to backup.

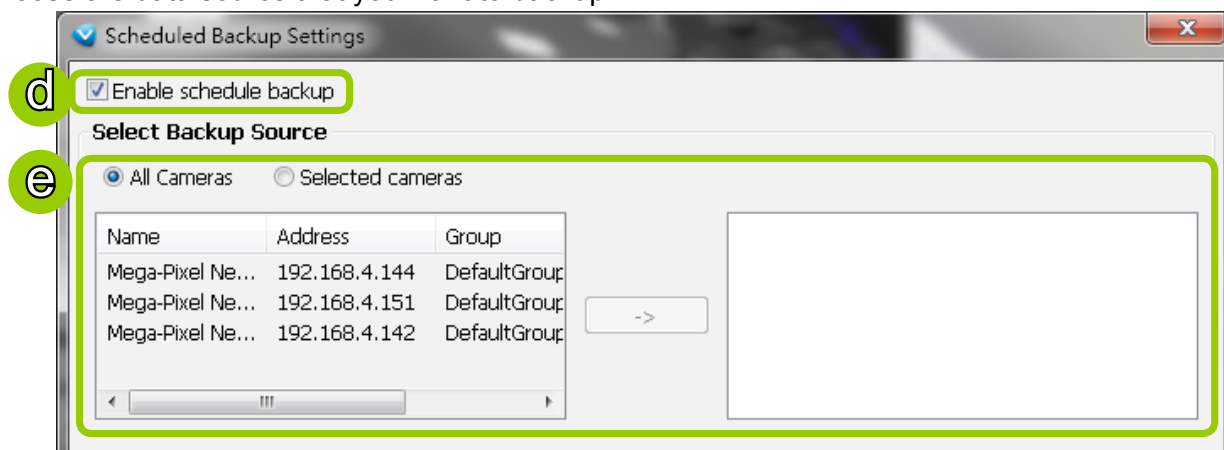

Setup Backup Schedule

- f. Fill in a desired time and click >> to add the backup time. Please note that the backup time interval must not be shorter than 1 hour. For example, 23:40 and 00:15 are not allowed to exist simultaneously. In the sample below, the server will backup the recorded data at 12:00 PM and 23:00 PM everyday once you save the settings.

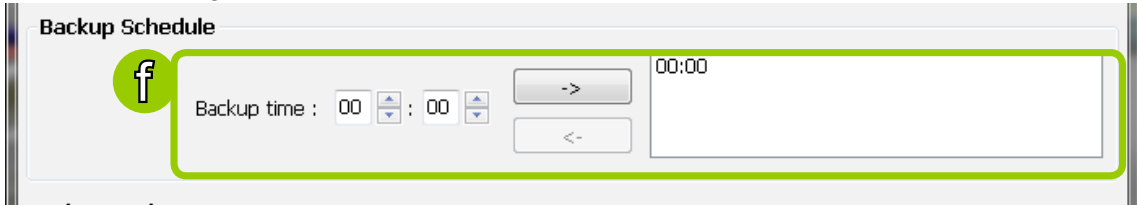

NOTE:

The following diagram shows the backup schedule and backup data:

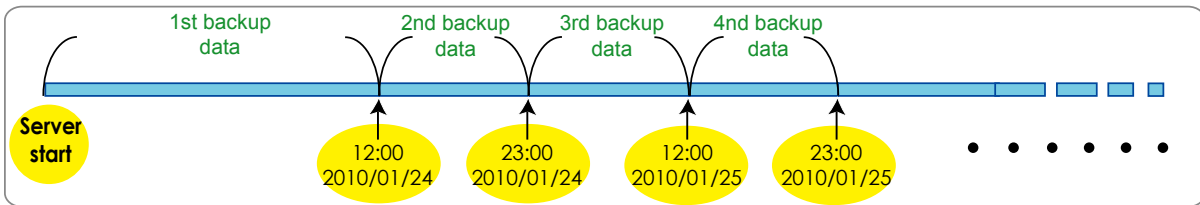

Select Backup Target

- g. Click **Browse...** to select a path (local path or network storage) to store the backup data. Please note that the disk for backup data should be different from the original recording path, or a warning message will pop up as shown below. For more information about how to set up recording path, please refer to page 84. Note that you should not select disk C:\ or D:\ as the backup target. C:\ and D:\ are for system programs and database.

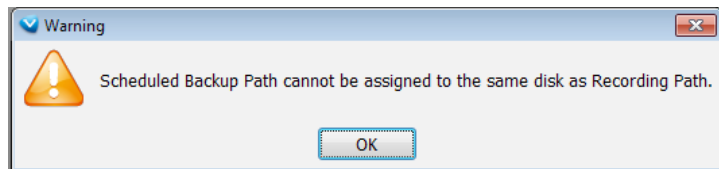

- h. Select a maximum size for backup folder. The server will divide backup data into the following size: VCD (650M), DVD (4.7G), Customize, or Unlimited size according to your choice.
- i. Select **Delete old backups if space is insufficient** if you want to do cyclic backup due to the limited size of the hard disk.

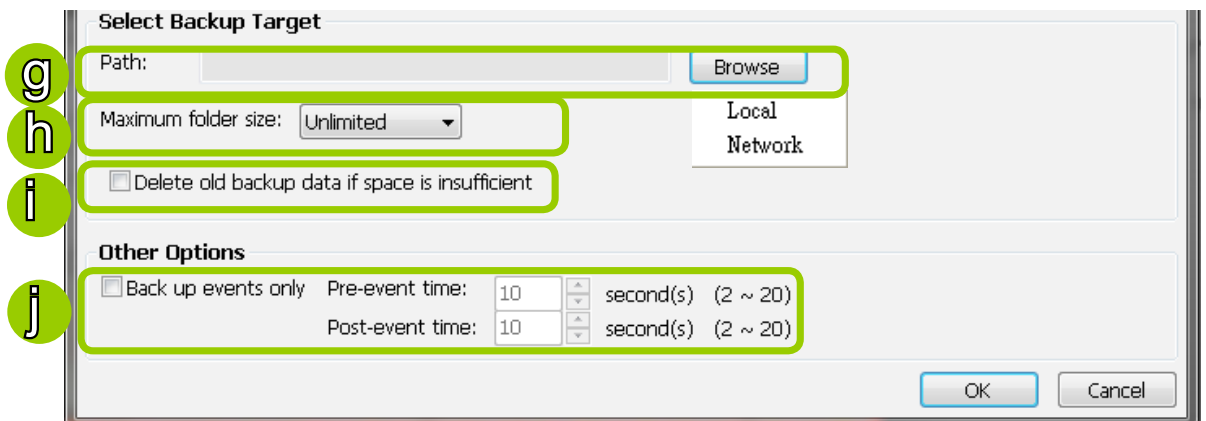

Other Options

- j. If you only want to backup the recorded data of events, select **Backup only events** and fill in the pre- and post-event time.

How to Configure Station Server Settings

VAST LiveClient supports Server Settings including DDNS Settings, Network Storage Settings, and SMTP Settings.

Select the station from the hierarchical management tree and click **Configuration > Station Settings > Server Settings** to open the page (or **right-click** the station and select **Station Settings > Server Settings**).

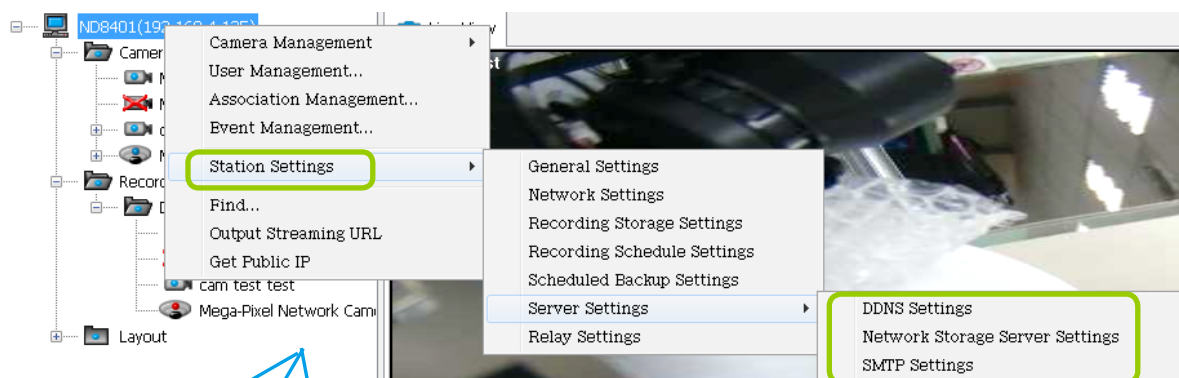
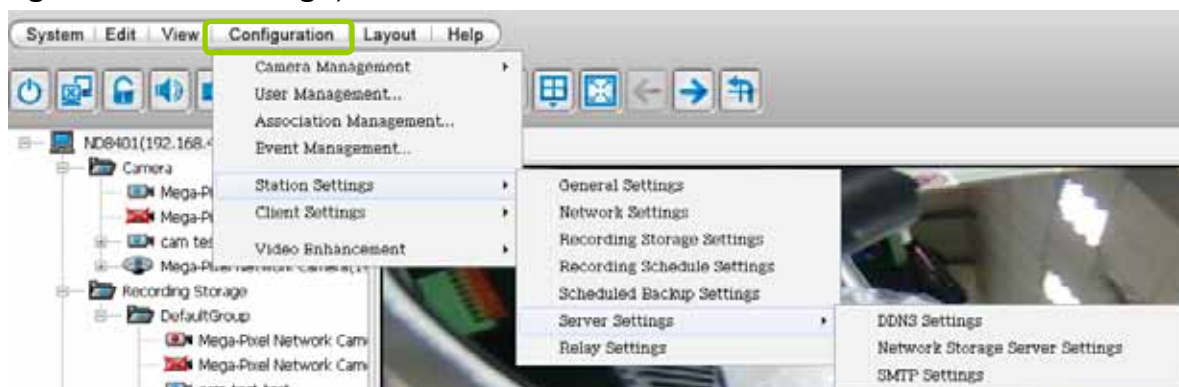

DDNS Settings

Since a public IP assigned to the NVR WAN port may be a dynamic IP address, using DDNS service for it will benefit from a fixed domain name.

Select a DDNS provider from the provider drop-down list. VIVOTEK offers 2bthere.net (Safe100.net), a free dynamic domain name service, to VIVOTEK customers. Please refer to the user's manual of VIVOTEK's network camera for detailed DDNS settings.

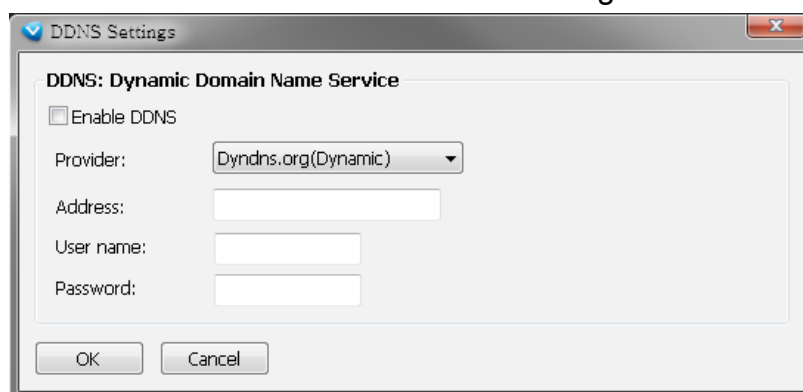

Network Storage Server Settings

The VAST Server allows user to set up network storage path(s) for recorded files. Please follow the steps below to add a new network storage path.

a. Click **Add** to open the Network Host Window.

b. Fill in the related information for the network host. Then click **OK** to save the new settings.

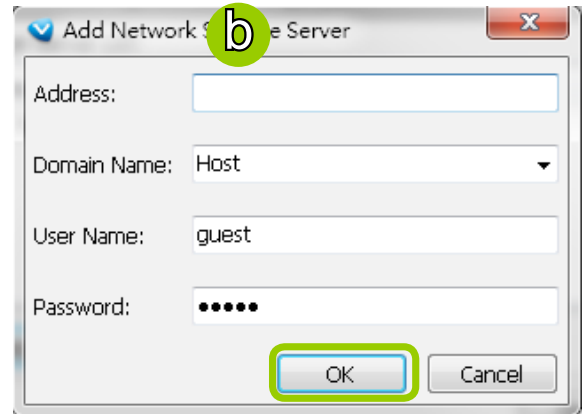
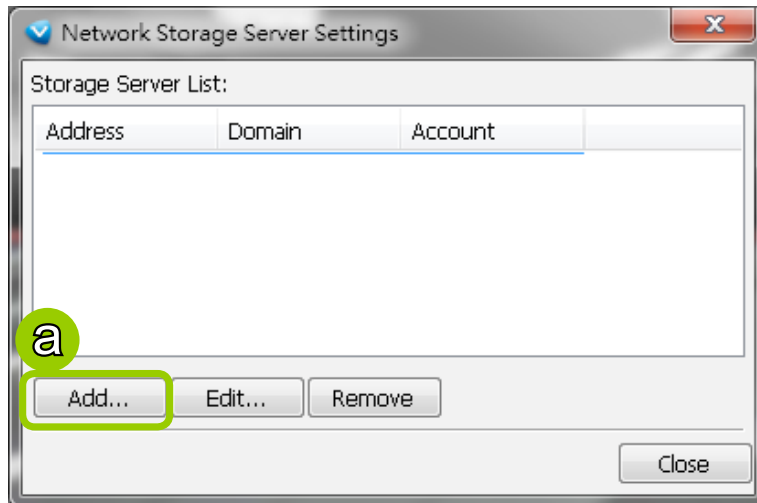

c. If you want to add more network host(s), please repeat step a. b.

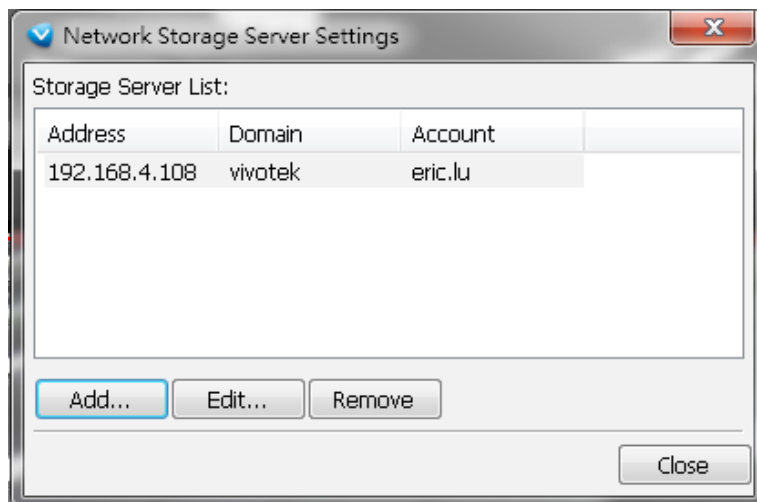

SMTP Settings

VAST Server allows user to set up SMTP Server to send mail alert when event triggers. For more information about how to set up event management, please refer to page 72.

Please follow the steps below to configure the SMTP Server:

- Click **Add** to open the SMTP Settings page.
- Enter the related information of your mail server. If your SMTP server requires a secure connection (SSL), check **Use SSL**.
- Click **OK** to enable the settings.
- Then the new information will appear on the SMTP Settings window as shown below.

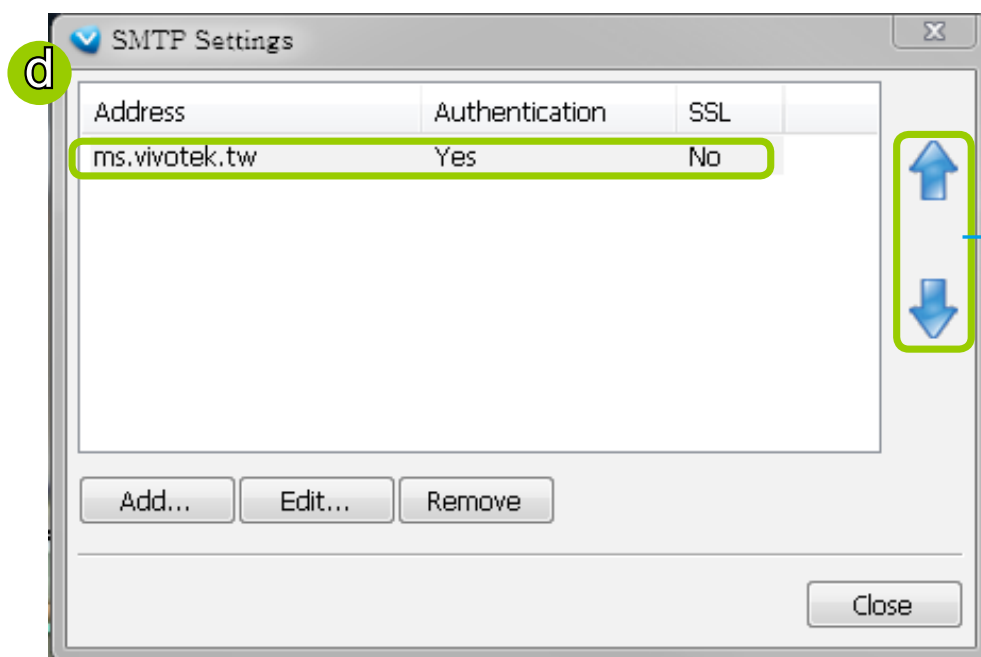
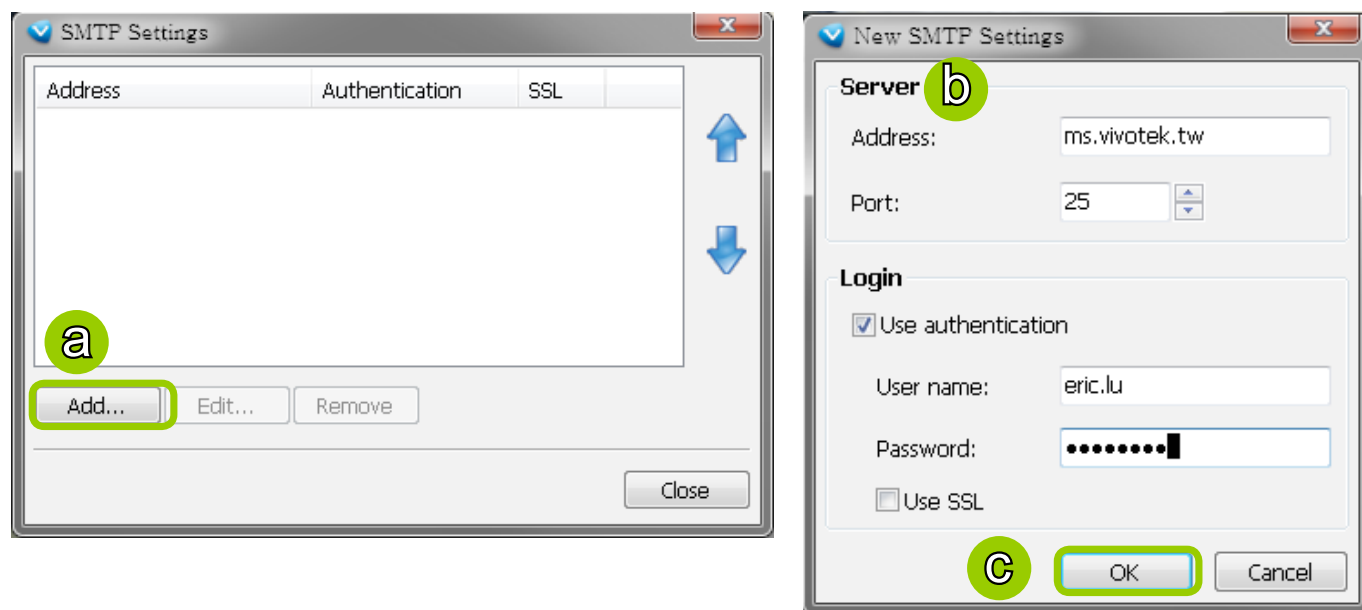

If you have more than one SMTP server, you can click to arrange the priority.

How to Use the Talk Panel

VAST LiveClient supports the two way audio function which allows the user to communicate with people around the network camera. Please enable the two way audio function on the camera side. Below is a conceptual drawing of the two way audio function:

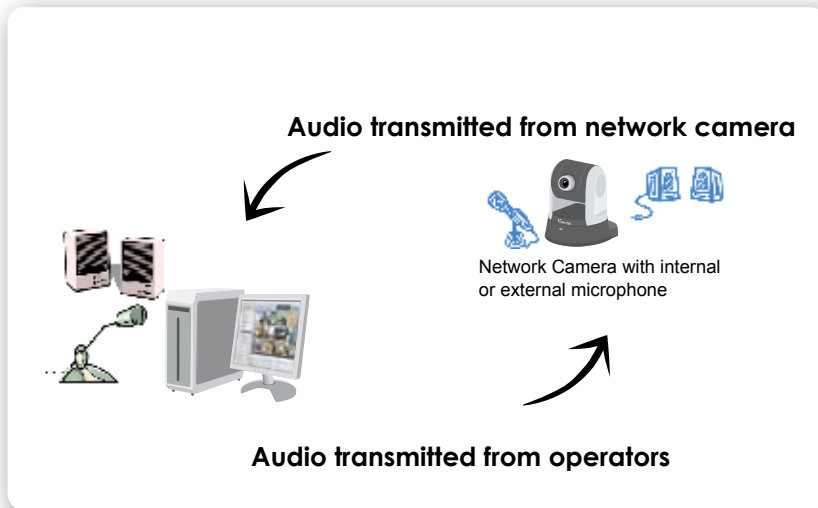

Add a Camera to the Talk Panel

■ There are several ways to add a Network Camera to the Talk Panel:

Drag-and-drop a camera from the video cell or from the hierarchical device tree to the talk panel as shown below. You can also **right-click** the target camera or the video cell, then click **Send to Talk Panel** on the popup menu.

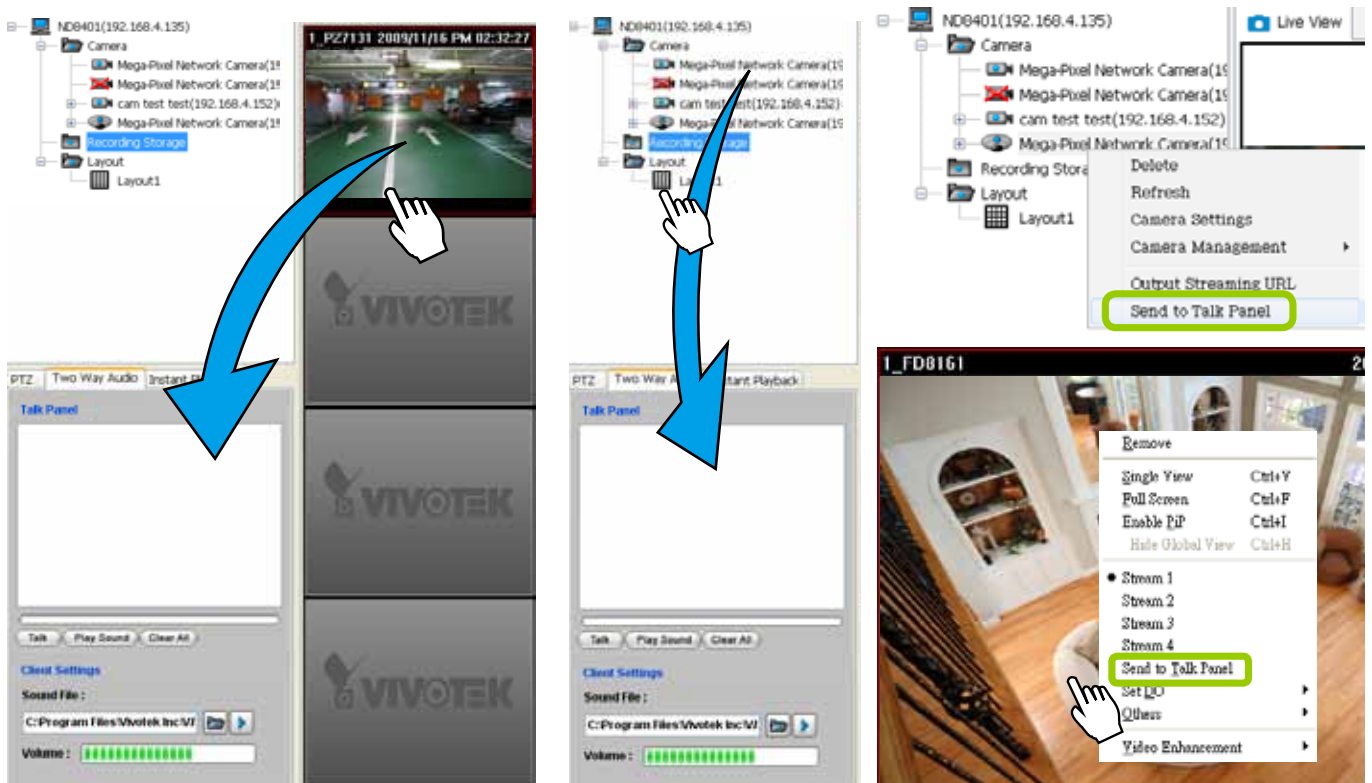

- An icon with the camera name will be displayed in the Talk Panel.

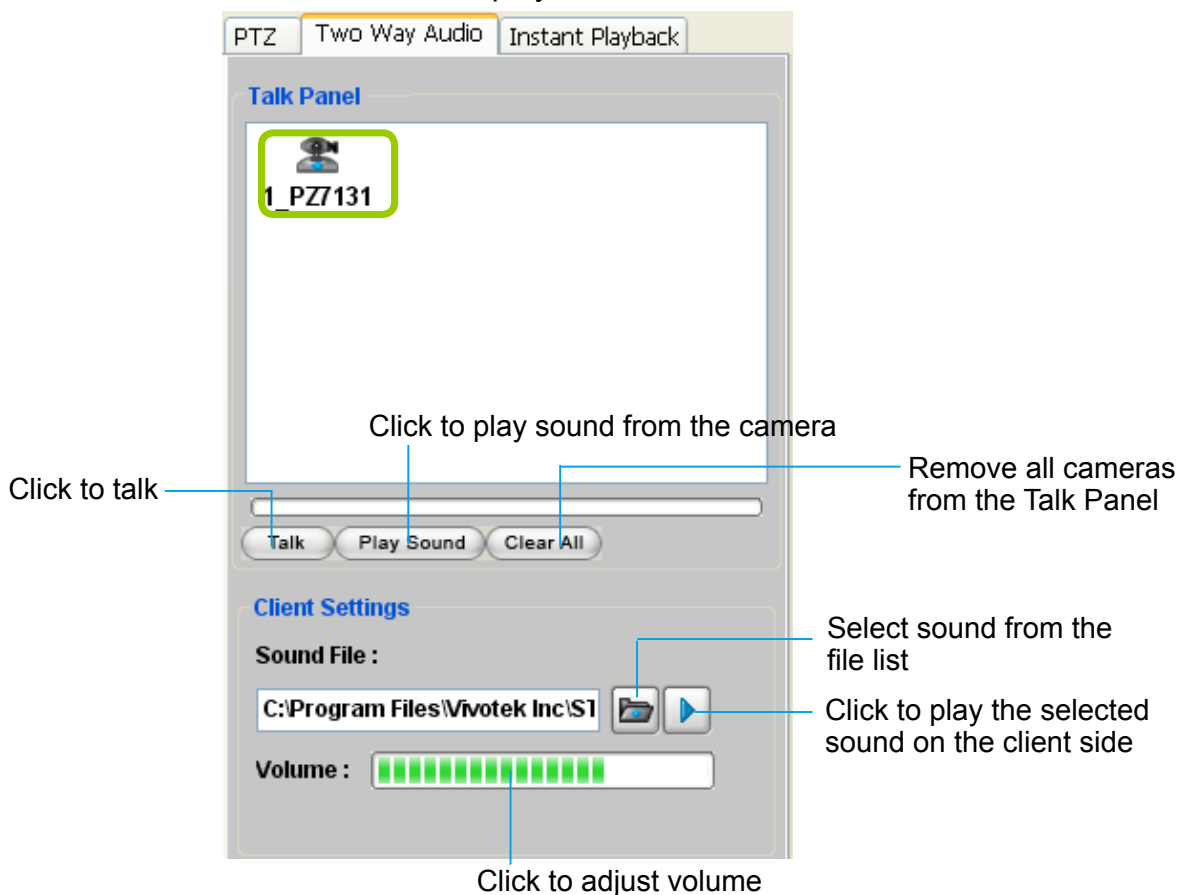

NOTE:

- Please note that you cannot **Talk** and **Play Sound** at the same time.
- When you are talking or playing sound, you cannot add other cameras to the Talk Panel. If you want to add more cameras to the Talk Panel, please **Stop Talking** and **Stop Playing** first.

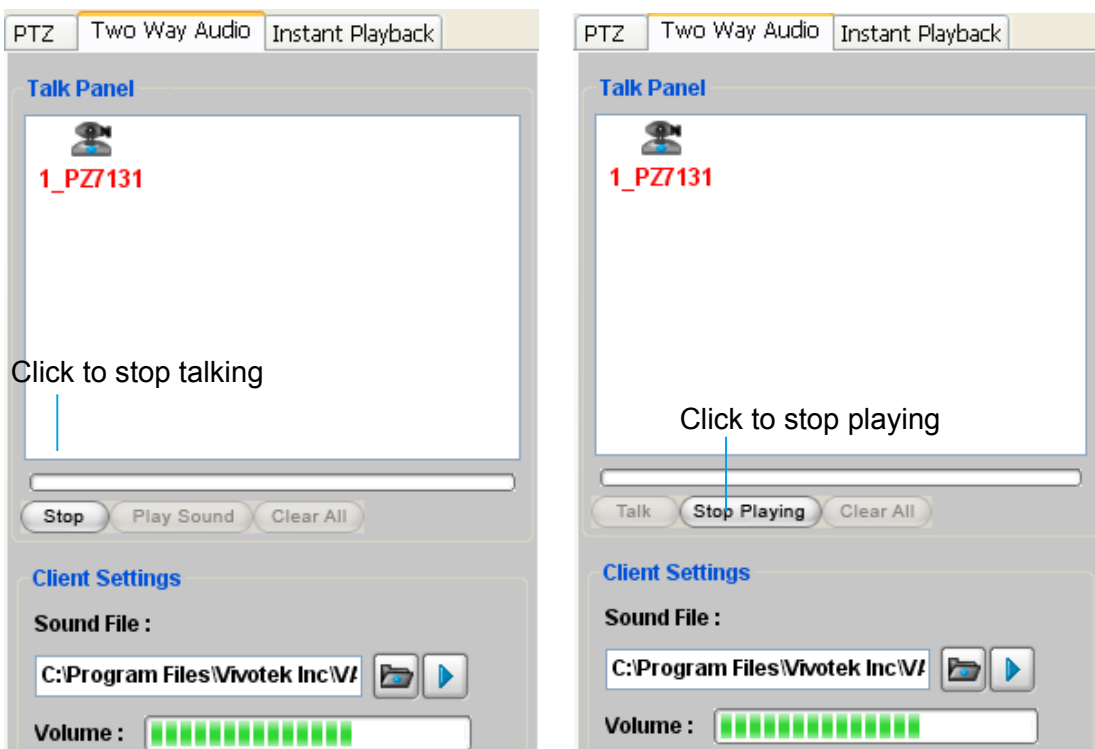

Remove a Camera from the Talk Panel

■ Remove a camera

Drag a camera from the Talk Panel and drop to the hierarchical management tree window as shown below. The camera icon will disappear.

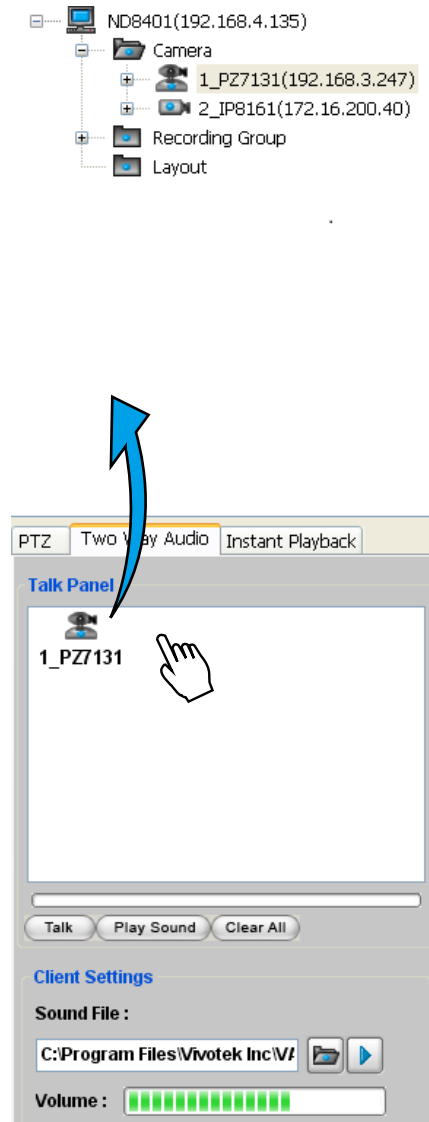

■ Remove all cameras

Click **Clear All**, all cameras in the Talk Panel will be removed.

How to Configure E-map Settings

VAST LiveClient supports intuitive E-map function which allows users to upload E-maps for overall devices management.

Click **System > E-map** to open E-map Settings Page:

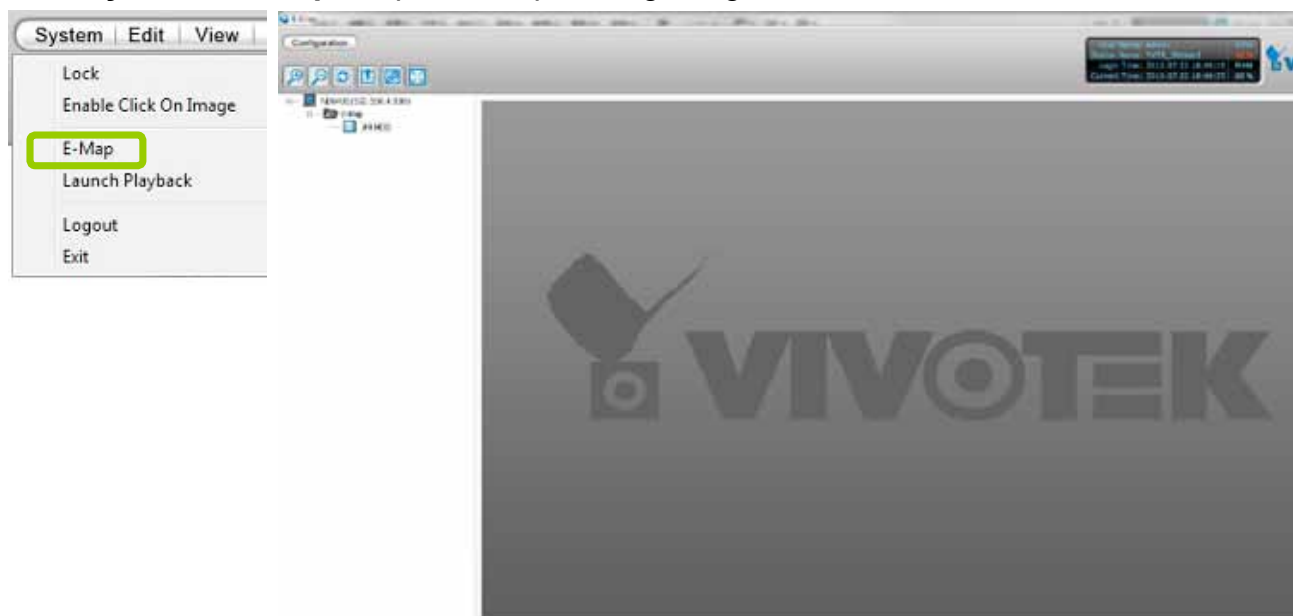

Upload an E-map

Click  to search for E-map(s) to upload.

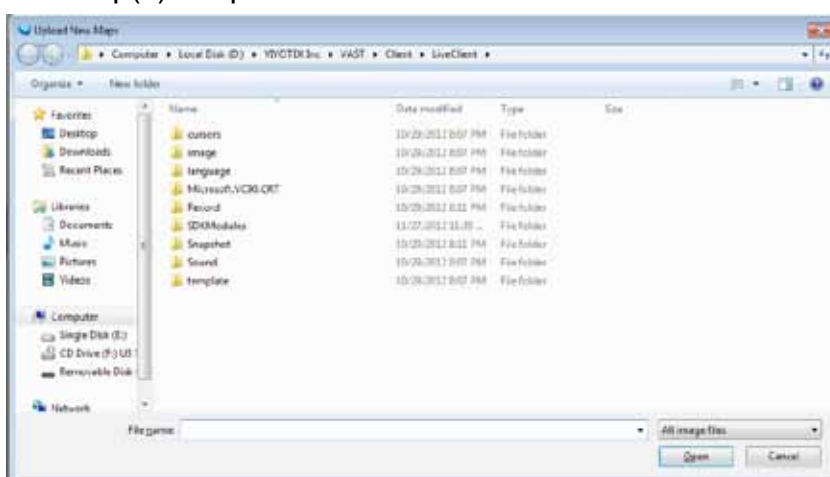

The uploaded E-maps will be listed under the E-map list tree.

NOTE:

If the uploading procedure fails, please compress the image size of your map (equal or smaller than 2MB) and try again.

E-map Settings Page (View Mode)

- Double-click** an E-map on the tree, it will be displayed on the E-map window as shown below. There are two operation modes of E-map settings page: "View Mode" and "Edit Mode". The following is the "View Mode" illustration.

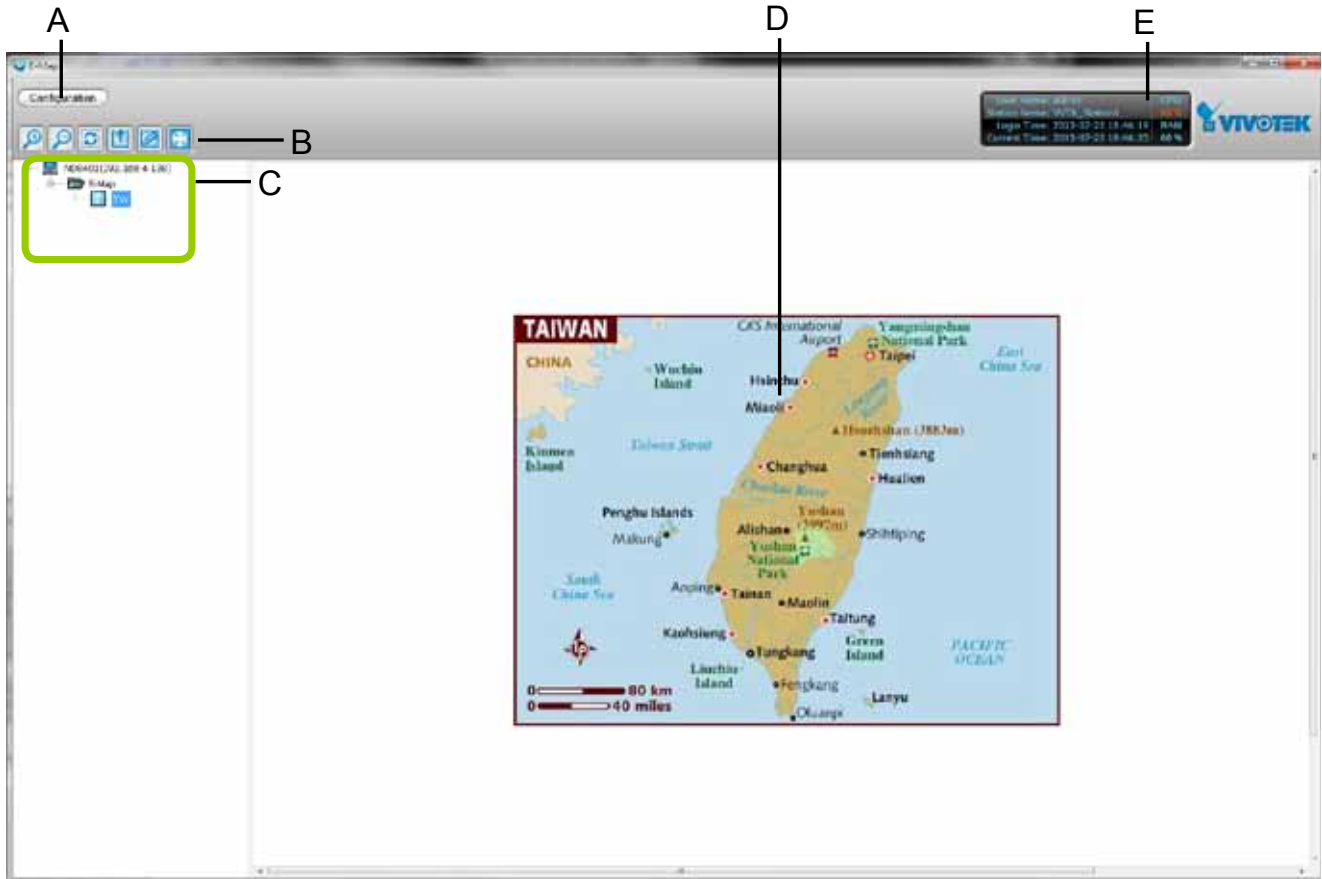

A. Menu bar B. Quick access bar C. E-map list tree D. E-map window E. Status panel

- Right-click** the E-map, then you can **edit**, **rename**, or **delete** the E-map.

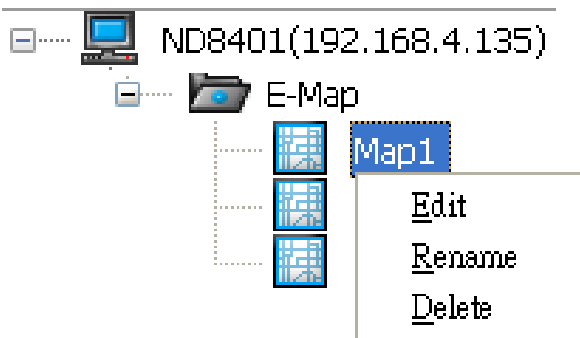

Quick Access Bar



Icon	Function	Description
	Zoom in	Zoom in the E-map
	Zoom out	Zoom out the E-map
	Default size	Adjust the E-map to default size
	Upload	Upload E-map to the login station
	View Mode	Click to switch to view mode
	Full Screen	Extend the E-map settings page to full screen
	Save	Save E-map settings

Status Panel

User Name: admin	CPU
Station Name: VVTK_Station1	90 %
Login Time: 2013-07-22 18:46:19	RAM
Current Time: 2013-07-22 18:46:25	60 %

User Name	CPU
Station Name (IP Address)	usage
Login Time (yyyy-mm-dd hh:mm:ss)	RAM
Current Time (yyyy-mm-dd hh:mm:ss)	usage

E-map Settings Page (Edit Mode)

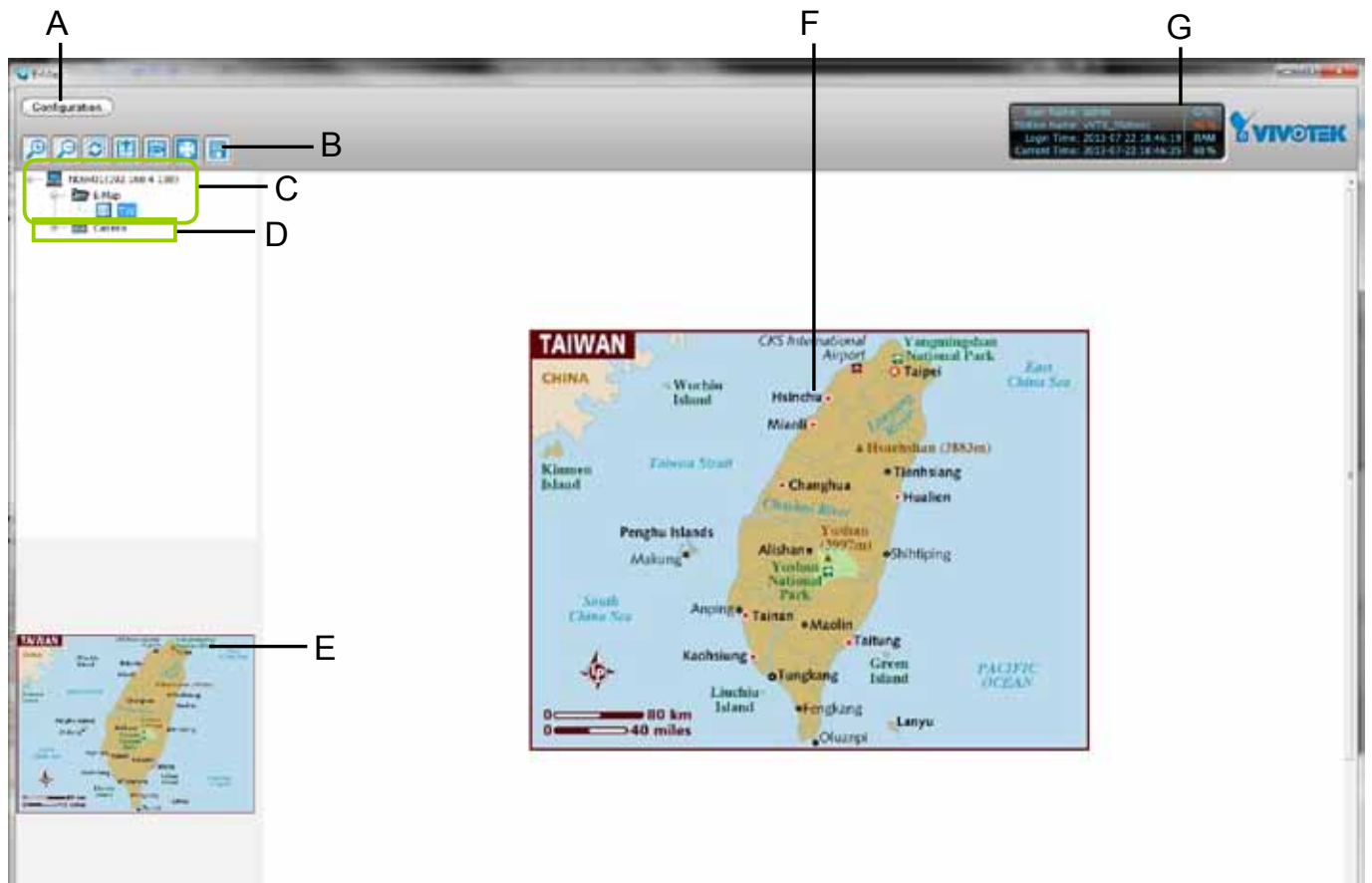

- A. Menu bar
- B. Quick access bar
- C. E-map list tree
- D. Device tree
- E. Map preview
- F. E-map window
- G. Status panel

■ **Right-click** the E-map, you can **delete** an existing E-map.

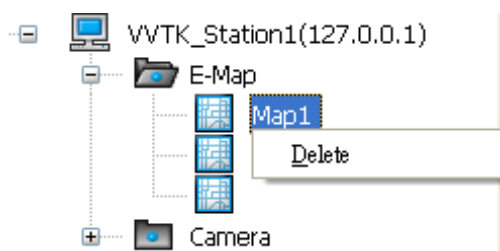

Device Management

Please follow the steps below to edit an uploaded E-map.

- Double-click** the E-map you want to edit, it will be displayed on the E-map window.
- Use Quick Access Bar to adjust the size of the E-map. In edit mode, you can also use your mouse to drag the position of the E-map and zoom in or zoom out the E-map.
- Drag-and-drop** the connected devices to the E-map according to your deployment.

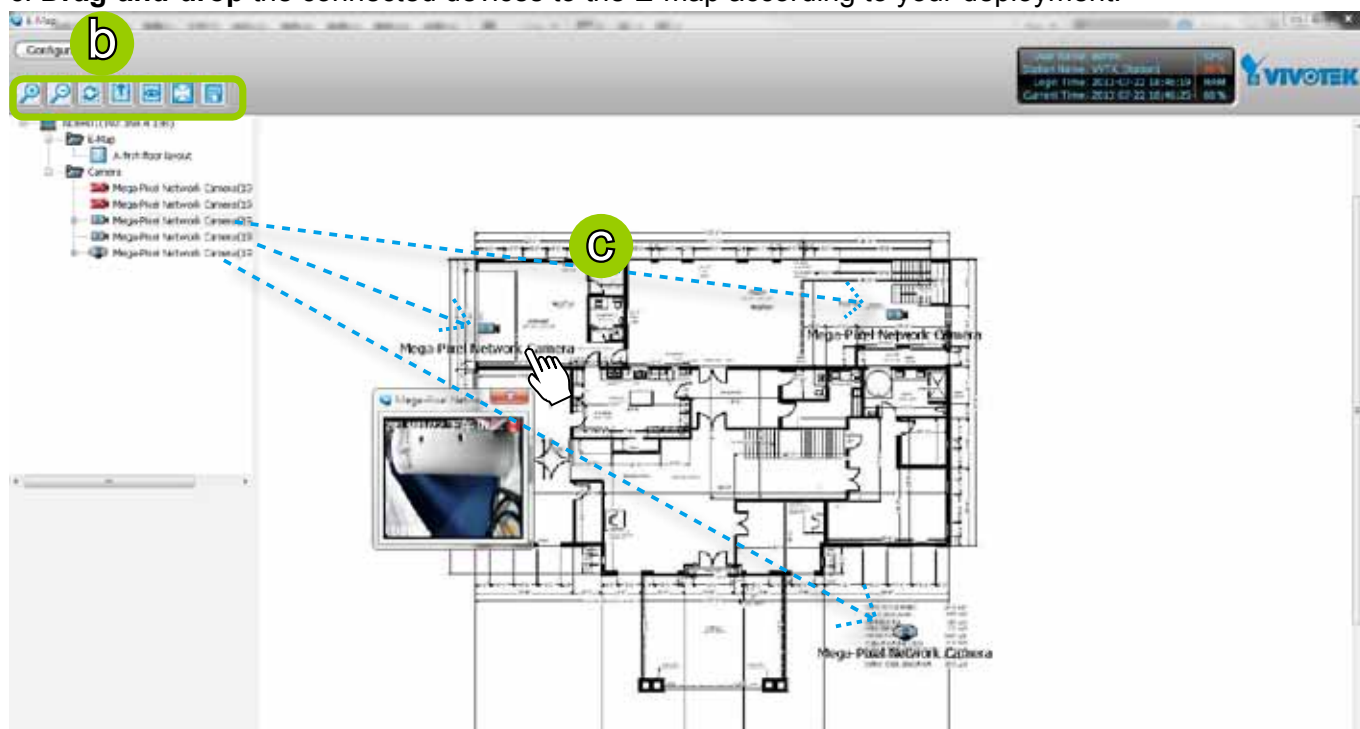

- Right-click** the device icon on E-map, you can **rotate** the direction or **delete** the device. The device can be rotated in 8 directions as shown below.



- You can also drag the DI/DO device under the connected device onto the E-map. If you want to change the status of the **DO** device, **double click** the DO icon on E-map.

For more information about DI/DO settings, please refer to Association Management on page 70.



- Click  on the Quick Access Bar to save the new settings.

NOTE:

The red frame twinkling around the device means there is event trigger(s) going on. Meanwhile, a live view dialog will pop up beside the model.



Live View Dialog Settings

Click **System > E-map Settings** to open the E-map Settings dialog, then you can choose to **Open Live View Dialog** or to **Send to Single View** when you double-click the device deployed on the E-map.

Open Live View Dialog

Select **Open Live View Dialog**: When you **double-click** the device icon on the E-map or when an event triggers, a live view dialog will pop up beside it. It is the default setting in E-map Settings window.

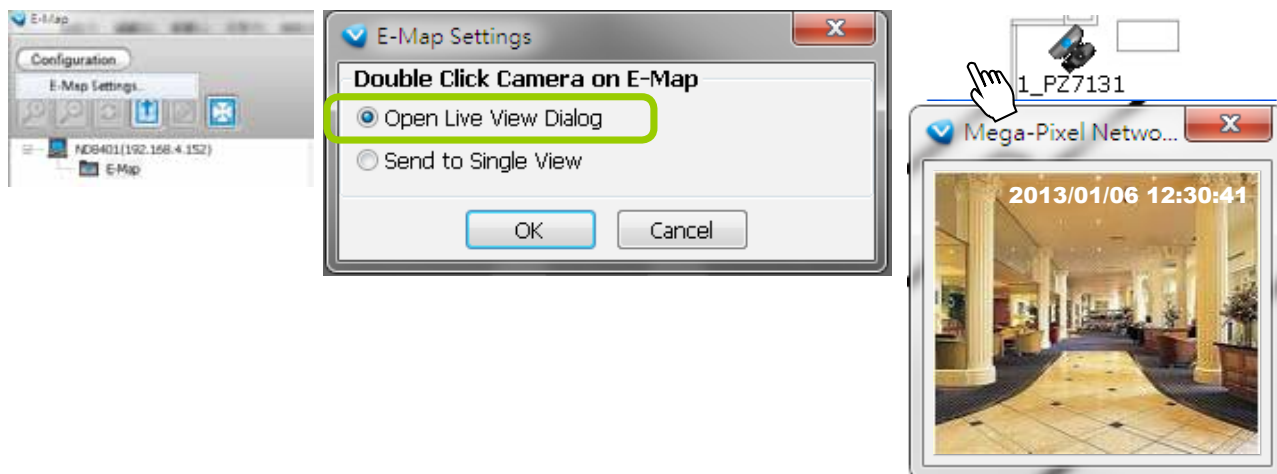

Send to Single View

Select **Send to Single View**: When you **double-click** the device icon on the E-map, it will open a single view on the VAST LiveClient.

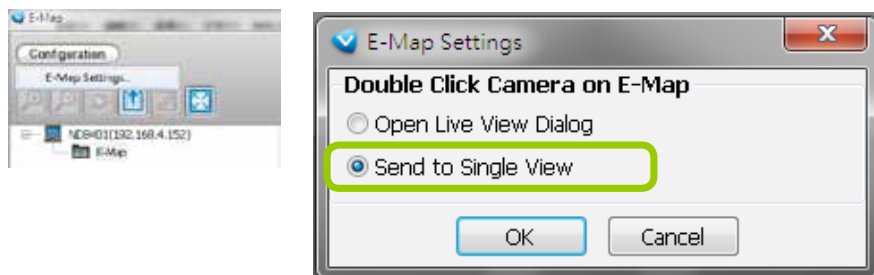

NOTE:

The live view dialog also supports **click on image**, **PTZ**, and **e-PTZ** as long as the connected camera also supports and has enabled these functions. To enable those function on E-map, please check the item "Enable click on image" on the menu bar of LiveClient as shown below. Then an icon  will appear in the live view dialog for you to control the cameras.

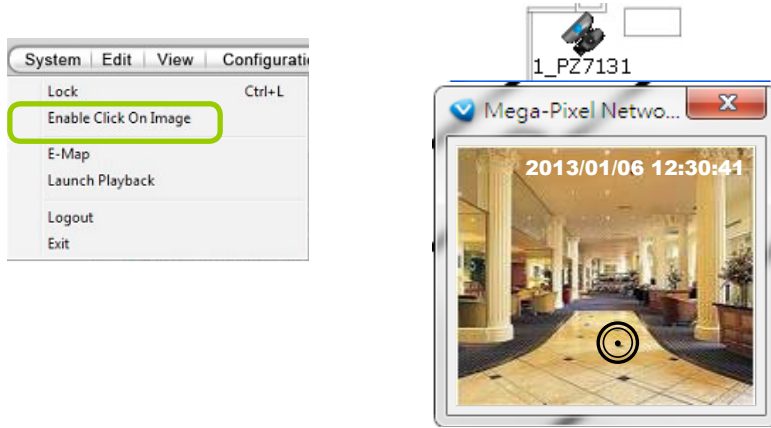

E-map Link

After completing device deployment on your E-map, you can link an E-map to another E-map. Please follow the steps below to configure E-map link:

a. Select a map you want to edit and enter **Edit Mode**.

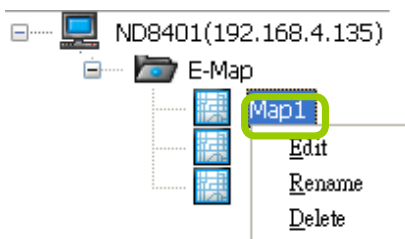

b. **Drag-and-drop** another E-map onto current E-map. A blue frame will appear as shown below. For example: Link Map1 to Map2 by dargging Map2 onto Map1



c. Use  to move the position of the blue frame.

d. **Right-click** the blue frame to **Resize** or **Delete** it.



Click **Resize**, some nodes will appear around the blue frame. Then You can drag the nodes to move the position, rotate the direction, adjust the size, and change the shape.

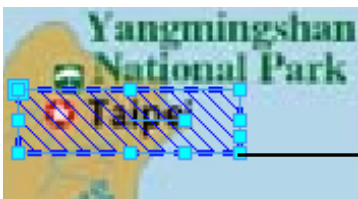

resize

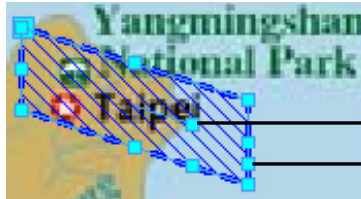

rotate the direction
change the shape

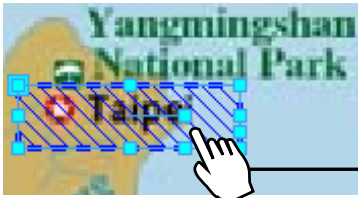



move the position

e. Click  on the Quick Access Bar to save the new settings.

f. If you want to set additional map links, please repeat steps a. ~ e.
For example: Link Map2 to Map3 by dargging Map3 onto Map2



g. Click  on the Quick Access Bar to save the new settings.

h. Test the web links. Click  on the Quick Access Bar to switch to view mode. **Double-click** the blue frame on Map1, it will automatically switch to map2. Then **double-click** the blue frame on Map2, it will automatically switch to map3.

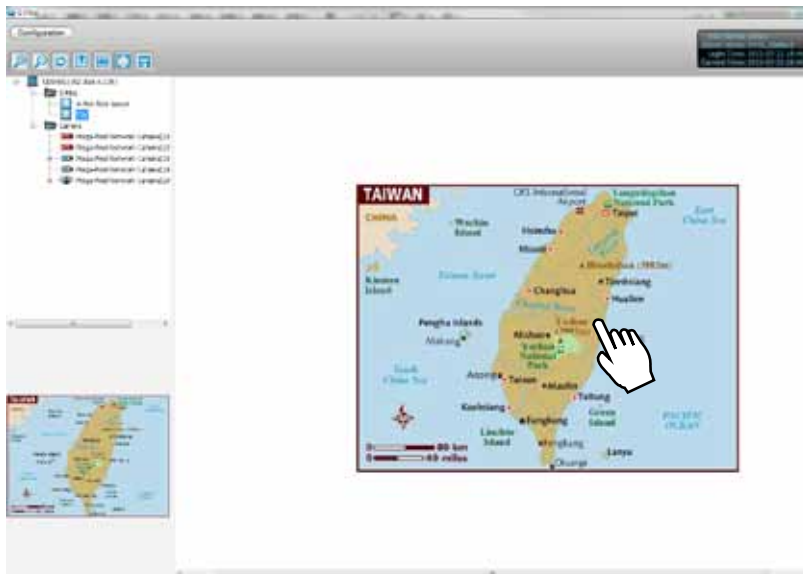

Map 1

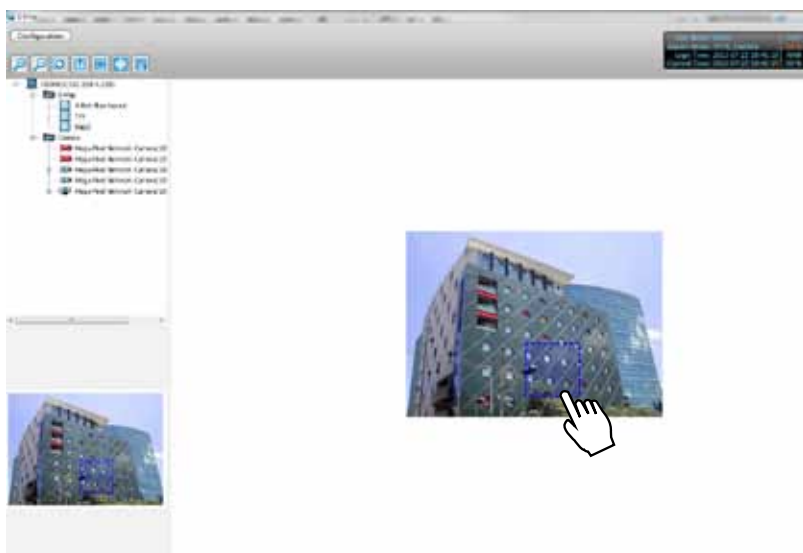

Map 2

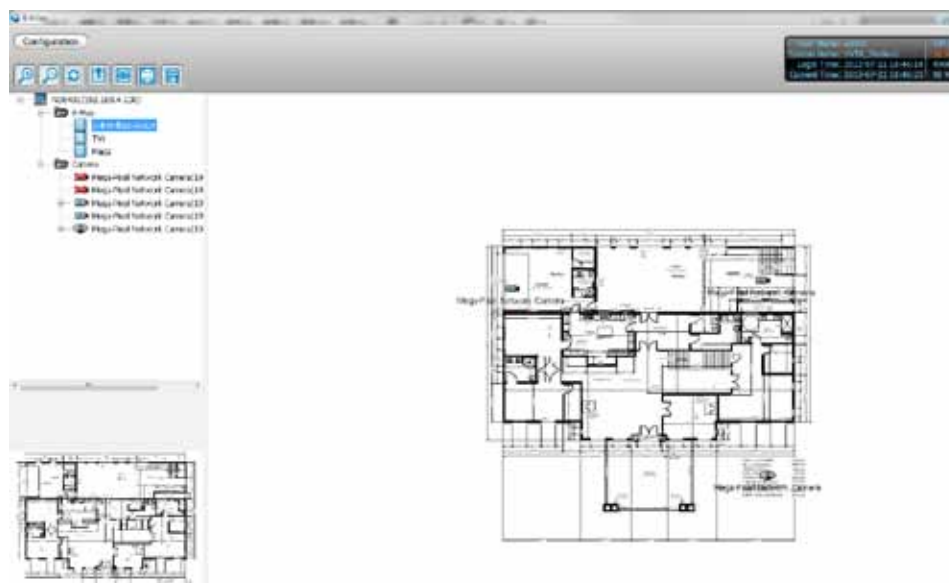

Map 3

How to Configure Client Settings

In Client Settings, you can configure Snapshot Settings, Recording Settings, View Settings, General Settings, Joystick Settings, Proxy Settings, and PiP Settings.

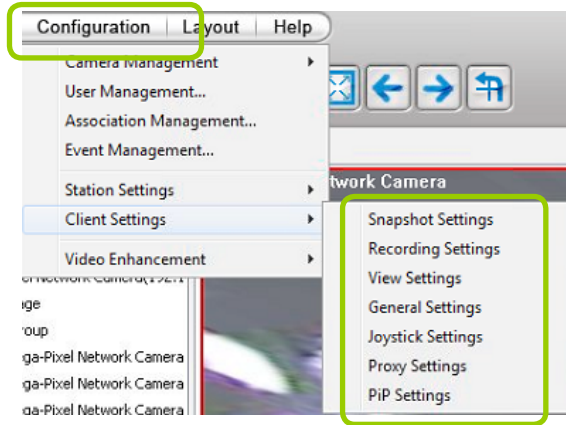

Snapshot Settings

Please follow the steps below to configure snapshot settings:

- Click **Configuration > Client Settings > Snapshot Settings** on the menu bar to open the **Snapshot Settings** window.
- Select a picture format for snapshots (**BMP** or **JPEG**). If you select **JPEG** format, you can adjust the recompression quality (from 1 to 100). Note that a higher value would generate higher picture quality but lower compression rate.
- Fill in a filename prefix for the snapshots.
- The default storage path for snapshots is E:\UserData\Snapshot. You can not change target directory.

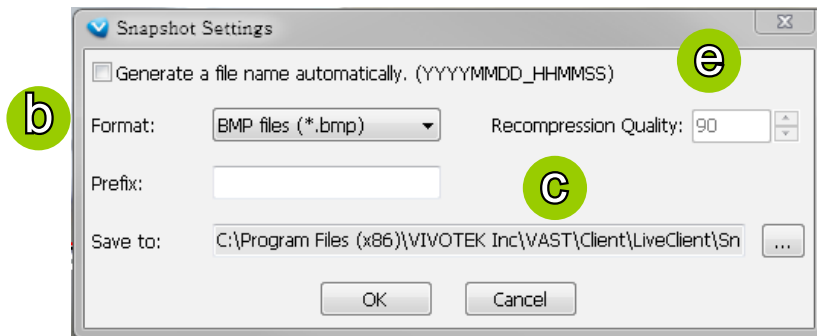

NOTE:

The recompression quality is only enabled in H.264 streaming. If your stream source is MJPEG, the system will directly save the JPEG image without recompression.

- If you check **Generate a file name automatically**, NVR will directly save snapshots with the following filename format to the storage folder.

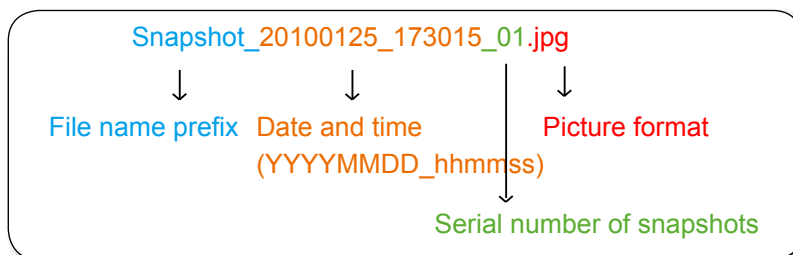

If you uncheck **Generate a file name automatically**, the **Save file** dialog box will pop up when you take a snapshot. The file name prefix will automatically be displayed in the Save File dialog box.

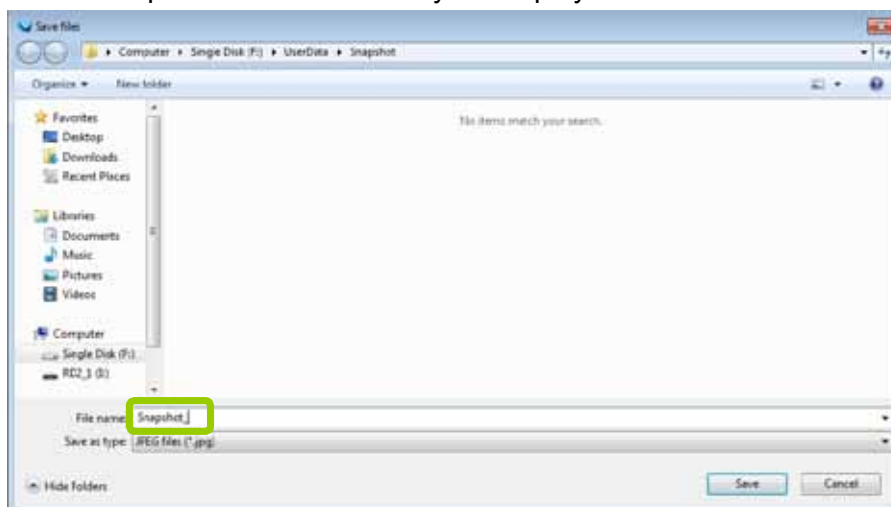

Taking a Snapshot

Please follow the steps below to take a snapshot of the live video stream:

- a. Select a video cell from which you want to take a snapshot.
- b. Click **Snapshot**  on the quick access bar, or **right-click** the video cell and select **Others > Snapshot** from the popup menu. You also can click **Edit > Snapshot** to take a snapshot.

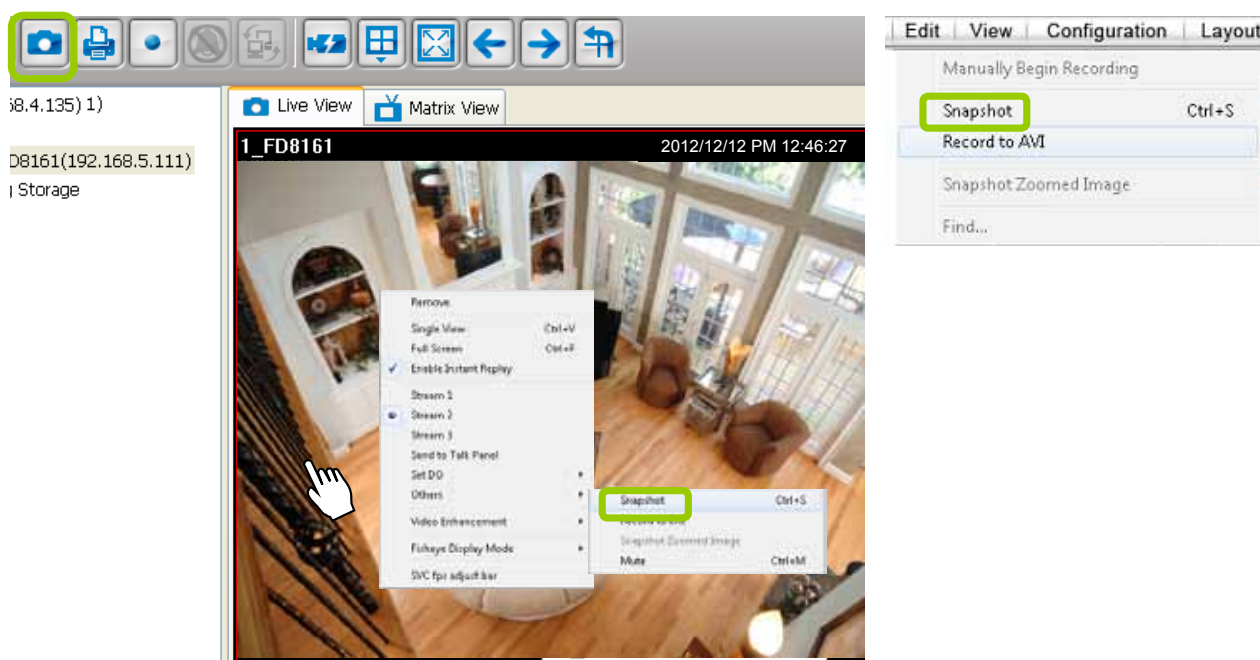

- c. The snapshots will be found in the preset storage folder on your local computer.

Recording Settings

The VAST Server allows you to record the live video in EXE, 3GP, or AVI format to your storage folder.

Type 1: Record to EXE

Record video as an EXE file. The EXE is not only a media file but also a built-in media player. When user execute the EXE, the media file will be played automatically. There is no need to install any other program. For more information about how to use the EXE player, please refer to page 130.

Please follow the steps below to configure EXE record settings:

- Click **Configuration > Client Settings > Recording Settings** on the menu bar to open the **Recording Settings** window.
- Select **EXE** as the Record Type. The default storage path is E:\UserData\Record.
- Select the Length of each file-- **Maximum Size** (10~2000MB) or **Maximum Time Interval** (1~150 min).

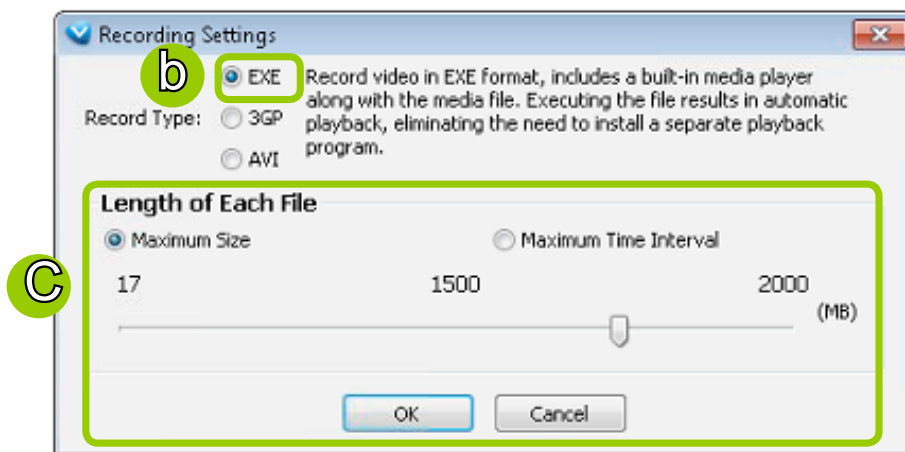

- Click **OK** to enable the settings.

Type 2: Record to 3GP

Record video as a 3GP file. 3GP file is a standard MP4 format compatible with players such as VLC, QuickTime, or Real players. Choose this type if you have already installed one of these players.

Please follow the steps below to configure 3GP record settings:

- Click **Configuration > Client Settings > Recording Settings** on the menu bar to open the **Recording Settings** window.
- Select **3GP** as the Record Type.
- Select the Length of each file-- **Maximum Size** (1~2000MB) or **Maximum Time Interval** (1~150 min).

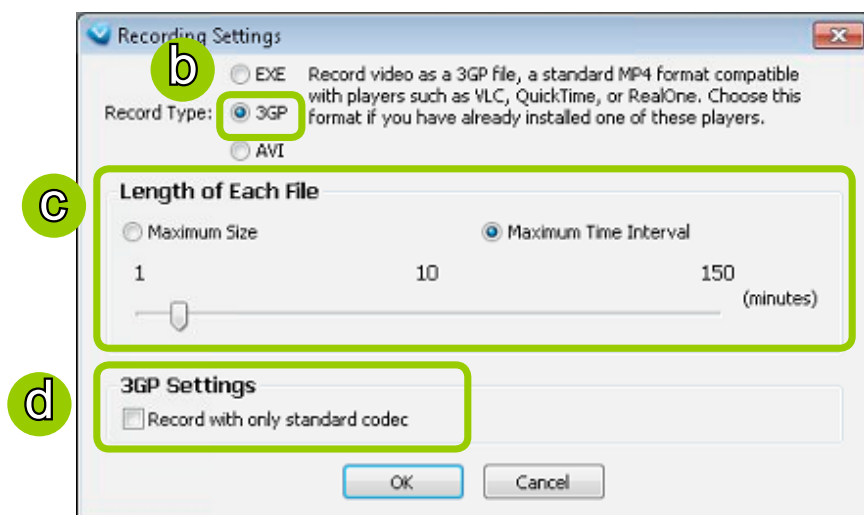

d. If you check "Record with only standard codec", the video from old models (VIVOTEK 6000-series products) using H.263 codec will not be recorded.

f. Click **OK** to enable the settings.

Type 3: Record to AVI

Record video as an AVI file, which uses the popular codecs pre-installed in the Windows OS. Please note that the speed may be slower due to the need of decoding the video/audio and re-encoding both into a compatible codec.

Please follow the steps below to configure AVI record settings:

- Click **Configuration > Client Settings > Recording Settings** on the menu bar to open the **Recording Settings** window.
- Select **AVI** as the Record Type.
- Select the Length of each file-- **Maximum Size** (1~2000MB) or **Maximum Time Interval** (1~150 min).

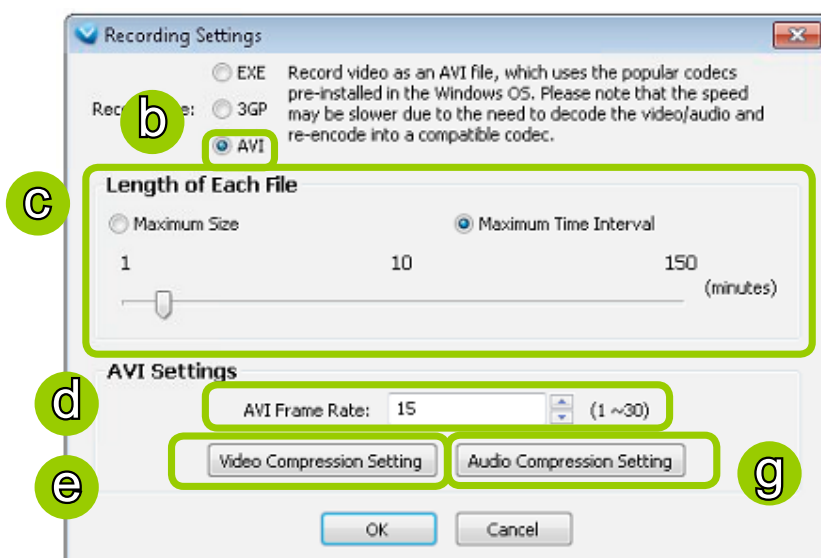

NOTE:

Because the AVI file has a limitation on the maximum file size of 2GigaBytes, if the setting "time length" generates data larger than 2G bytes, several files will be created.

- d. Select the frame rate/ per second.
- e. To modify the video compression settings, click **Video Compression Setting** to open the AVI Video Compression Setting window. Select the desired **video compression algorithm, compression quality, key frame intervals, and data rate** in the corresponding fields.

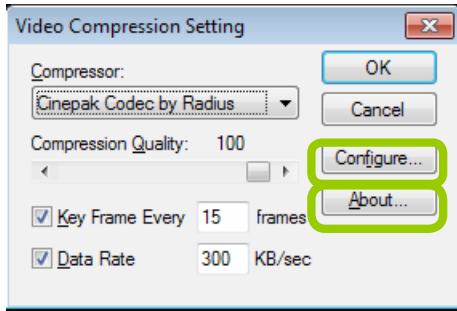

IMPORTANT:
If you do not choose to compress the video, the generated AVI file will be very large.

- To modify the settings of the compression algorithm: Click **Configure**, then a dialog box will pop up for you to modify the settings. The dialog box will be different according to the compressor you select.

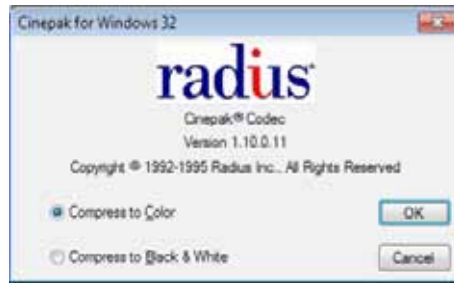

- To read the information of a compression algorithm (its version for instance): Click **About**, and a dialog box will pop up showing the related information. The dialog box will be different according to the compressor you select.

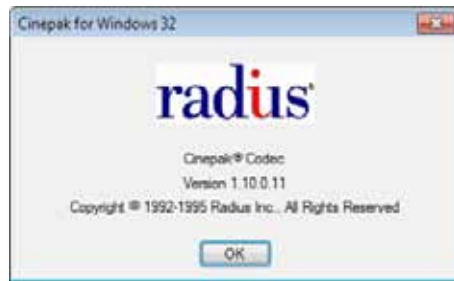

- f. To modify the audio compression settings, click **Audio Compression Setting** to open the AVI Audio Compression Setting window. Select the desired **audio quality, format, and attributes** in the corresponding fields.

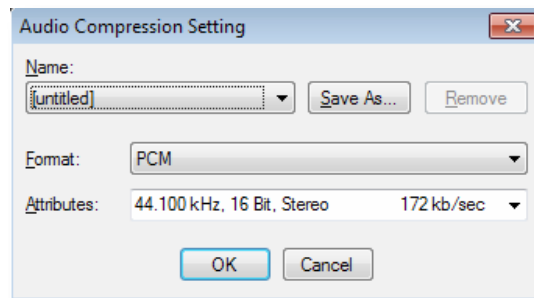

Record an EXE/3GP/AVI File

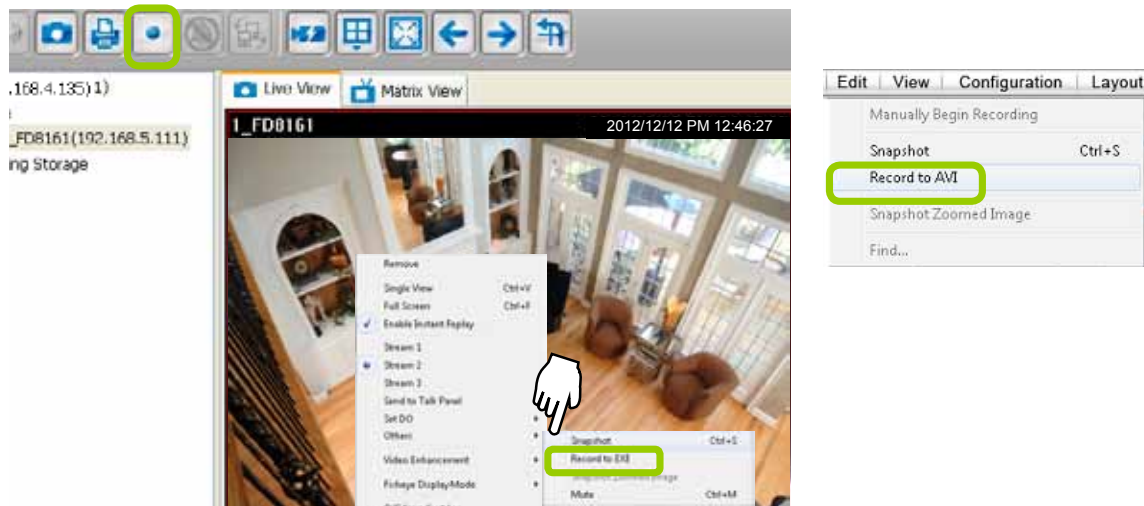

Please follow the steps below to record an EXE/3GP/AVI file of a live video stream:

- Select a video cell or a device from the hierarchical management tree which you want to record to media file.
- Click **Record to EXE/3GP/AVI**  on the quick access bar, or **right-click** the video cell and click **Record to EXE/3GP/AVI**. You can also click **Edit > Record to EXE/3GP/AVI** on the menu bar. (The UI string will change according to your Recording Settings.)

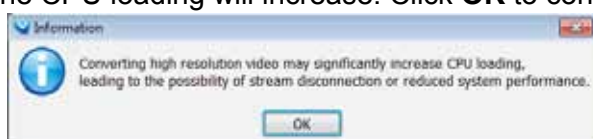

- For recording a high-resolution video (1600 x 1200) in AVI type, a dialog box will pop up as shown below to remind you that the CPU loading will increase. Click **OK** to continue the process.



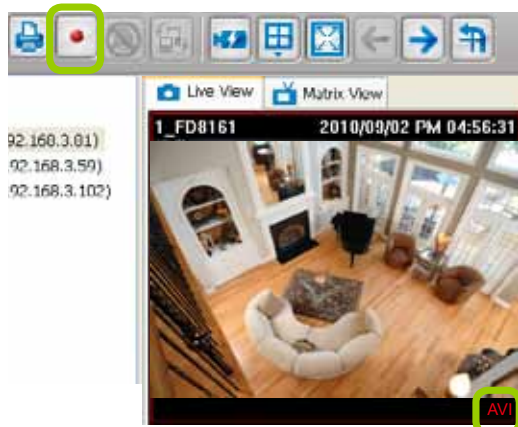

- The icon  will then change to **Recording EXE/3GP/AVI** , and a red text string (**EXE/3GP/AVI**) will appear at the bottom right of the video cell. Note that only one video channel can be recorded at a time.



NOTE:

If you save your video via a LiveClient installed on another computer, the videos will be placed in where you installed the LiveClient utility: e.g., C:\IVASTIClient\LiveClient\Record.

- When you want to terminate the AVI Recording, click the icon  on the Quick Access Bar. The export process will then terminate and the button will change from  to . The recorded media files will be found in the preset storage folder on your local computer as shown below.

Below is the file name format for AVI files:

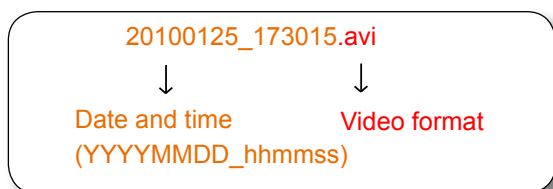

Built-in Media Player--EXE

Below is the icon of footages saved as EXE files. Double-click on it, the recorded video will be played automatically as shown below. If you installed LiveClient on your PC, you may also open the built-in Media Player (VMSMediaPlayer.exe) in the default location: C:\Program Files (x86)\VIVOTEK Inc\VAST\LiveClient\LiveClient.

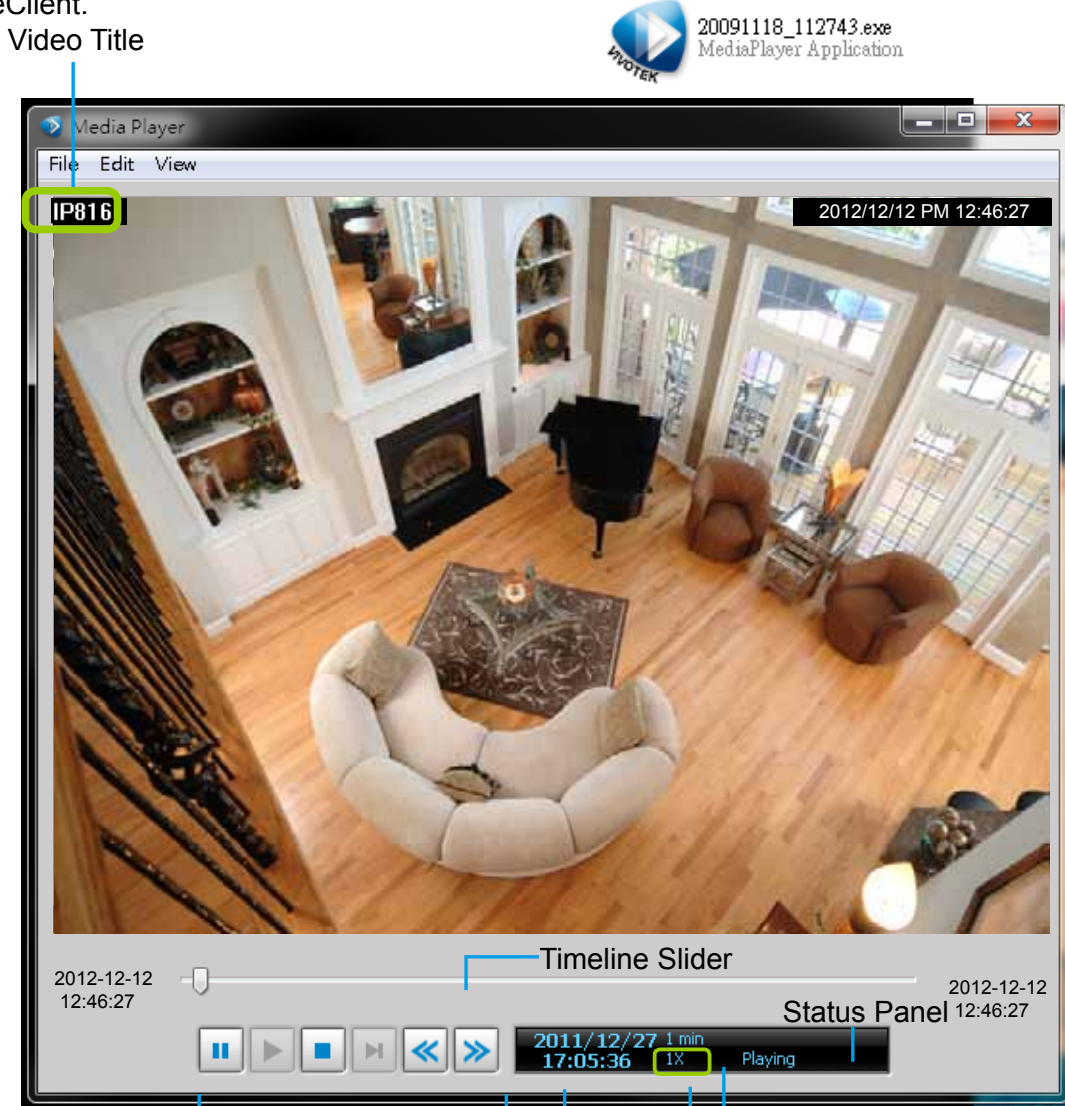

Control Buttons

Current time of the video clip

Total length of the histogram

The playing rate can be 1/8, 1/4, 1/2, 1X, 2X, 4X, 8X, 16X, 32X, and 64X.

Icon	Function	Description
	Pause	Pause playback of the focused video clip
	Play	Start playback of the focused video clip
	Stop	Stop playback of the focused video clip
	Next Frame	Go to the next video frame of the focused video clip
	Slow Down	Slow down the playback rate
	Speed Up	Speed up the playback rate

The function menu of the built-in media player are displayed as shown below:

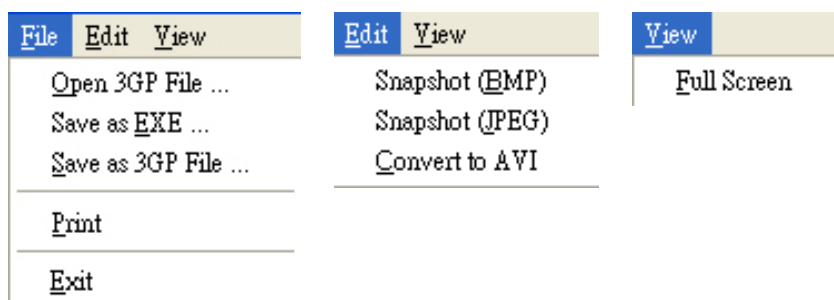

- The built-in player is able to playback 3GP files.
- The built-in player is able to save 3GP files as EXE files.
- The built-in player is able to save EXE files as 3GP files.
- The built-in player is able to convert EXE and 3GP files into AVI files.
- The built-in player also supports snapshot and print functions.



Tips

Below are special notices related to video recording with the fisheye cameras:

- For recorded videos from the fisheye cameras, only the built-in Media Player can playback the Regional or Panoramic views. If you access the recorded videos using other playback software, you will end up with the circular-shape Original view.
- When recording videos from fisheye cameras, the Regional and Panoramic views can only be preserved in the EXE and 3GP format. If you save the dewarped views, i.e., Regional and Panoramic, as AVIs, only the circular-shape Original view will be preserved.
- Currently the video playback on the E-map window displays the Original view only.
- To display a Regional or Panoramic view, right-click on the embedded Media Player window.

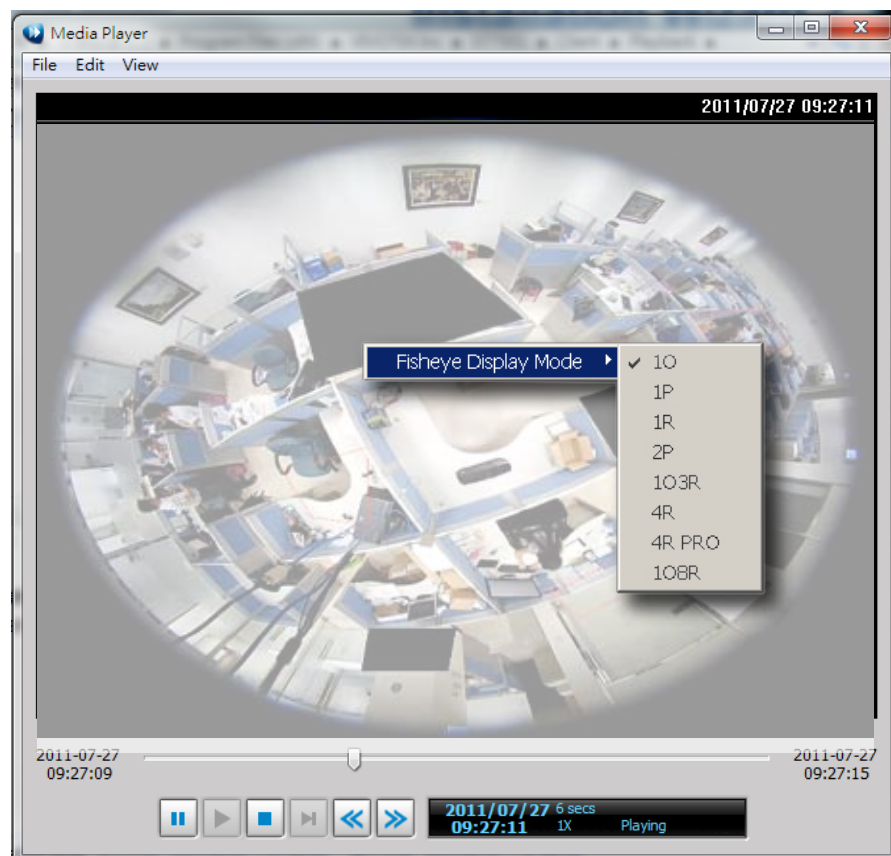

View Settings

This section allows you to set the display mode of a video cell, including **Display Location**, **Date and time Format**, **Video Display Mode**, and **Font Settings**. When you change the settings, the sample window will change accordingly for you to preview the settings.

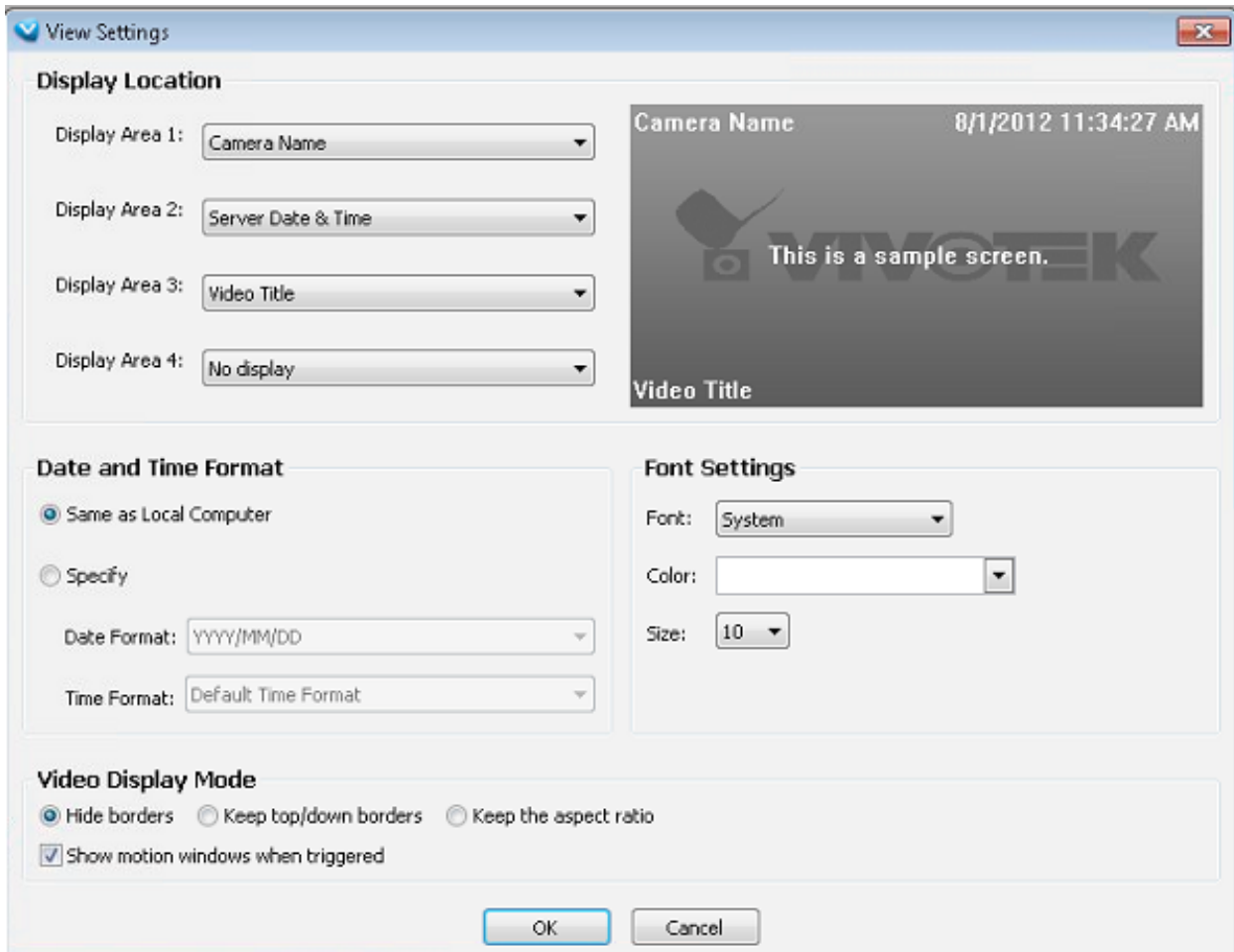

Display Location

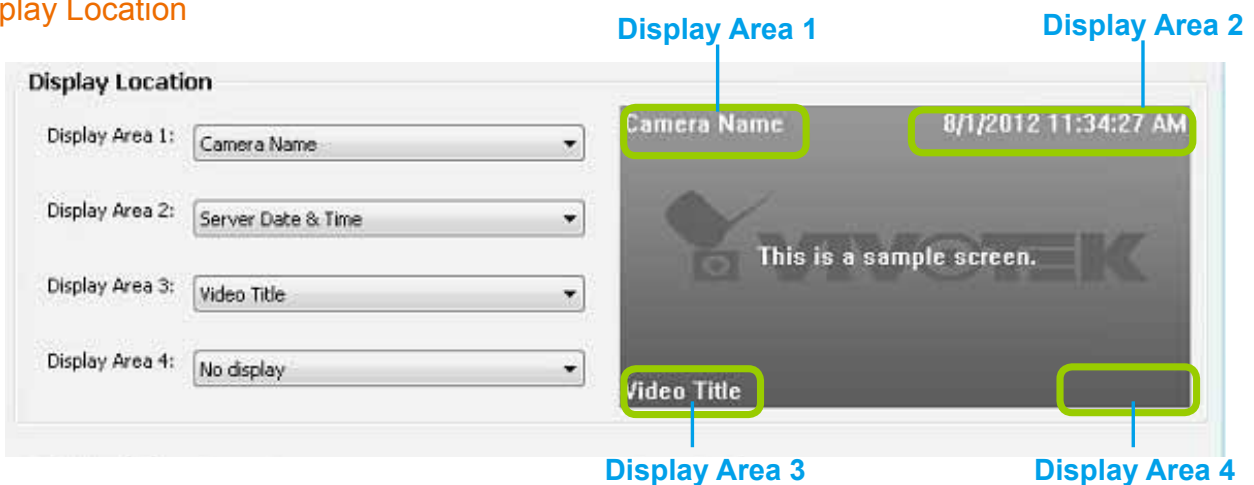

As the illustration shows, there are 4 display areas for you to input information about the live video. Each drop-down list includes 6 options for you to select: **No display**, **Camera Name**, **Video Title**, **Camera Date**, **Camera Time**, and **Camera DateTime**.

Date and Time Format

- Same as local computer: Select this option and then the date and time format will synchronize with the local computer.
- Specify: Select a desired format for the date and time from the drop-down list.
Date format: Select YYYY/MM/DD or MM/DD/YY.
Time format: Select the default time format (synchronize with the local computer), 12h AM/PM, or 24h.

Video Display Mode

- Keep the aspect ratio: In the default settings, the size of the video window will change according to the layout of the live view window you choose. However, the frame size may be distorted. If you select **Keep the aspect ratio**, the video window will be adjusted to the same frame size as the preview window. This function is disabled as default.
- Hide borders / Keep top/down borders: Select if you want to change the view cell borders. Black information banners will appear if you keep the top/down borders.
- Show motion window when triggered: If you select this option, the red frame of the motion detection window will appear in the video window when motion is triggered. This function is enabled as default.

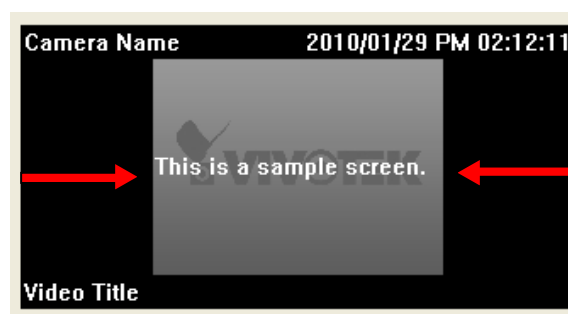

For detailed information about how to set up the layout of the live view window, please refer to **How to Change Video Viewing Mode** on page 59.

Font Settings

This function allows you to change the font on the video cell.

- Font: Automatically lists all fonts installed on your operating system. Select the desired type.
- Color: Select a desired font color (white, red, green, blue).
- Size: Select a desired font size (8, 10, 12, 14).

General Settings

This section allows you to configure the **System Settings** and **Rotation Settings**.

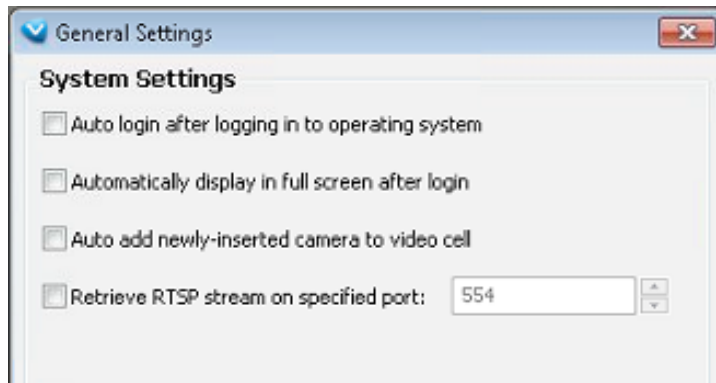

System Settings

- **Auto login after logging in to operating system:** If you check this option, VAST LiveClient will automatically login after you login to Windows without filling in the user name and password. This function is disabled as default.
- **Automatically display in full screen after login:** If you check this option, the video cells will be displayed in full screen without showing the menu bar or the control panels.
- **Auto add newly-inserted camera to video cell:** If you check this option, VAST LiveClient will automatically add the newly-inserted device to a video cell. This function is enabled as default.
- **Retrieve RTSP streaming on specific port:** The default port for RTSP streaming is 554. If you want to change this port, please check this item and fill in a desired port.

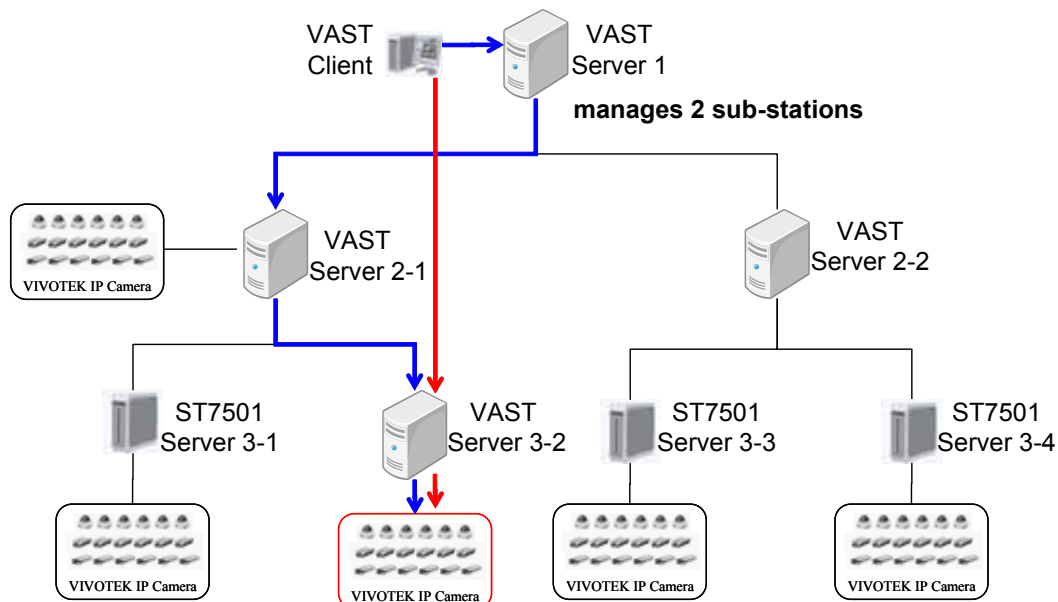

NOTE:

- *If the VAST Server 3-2 is set up behind a firewall, the VAST Client will not be able to access the VAST Server 3-2 directly. You have to get the connection by relaying.*

Event Settings

Enable live event notification

Enable alert sound(s)

Event window mode : Fixed
 Popup

Rotation Settings

Enable rotation after login

Rotate the page every second(s) (3 ~ 999)

Display Settings

Enable auto stream size

Enable de-interlace function

Enable Instant Replay on video cell

Default replay length:

OK Cancel

Event Settings

- **Enable live event notification:** Select this option to activate real-time event notification. For example: the event notification of DI/O status on the hierarchical management tree, the event list in the event window, motion detection windows in video window, or the event notification on E-map settings page, etc. This function is enabled as default.
- **Enable alert sound(s):** If you enable this option, you will hear alert sound on the client side when the event is triggered..
- **Event window mode:** Select **Fixed** or **Popup** mode for the event window. For more information about event window, please refer to page 32.

Rotation Settings

- **Enable rotation after login:** If you check this option, the video cells will start to rotate after you login to the VAST LiveClient. The default setting of this function is disabled.
- **Rotate the page every** **second(s):** Fill in a desire interval time for video page rotation. The maximum value is 99 seconds. The default value is set at 6 seconds.

For detailed information about how to set up the layout of the monitoring window and rotation functions, please refer to **How to Change Video Viewing Mode** on page 59.

Display Settings

WARNING:

Please do not disable the Auto stream size option. Disabling Auto stream size can cause a performance problem with the system. Today's megapixel cameras produce high resolution videos that, if not properly processed, can overstress the system.

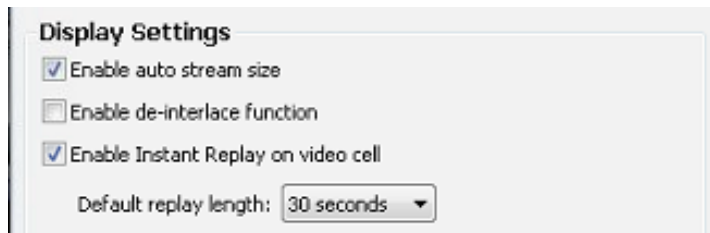

- Enable **auto stream size**: The Auto Stream Size feature dynamically adjusts the stream sizes of video feeds from network cameras in order to reduce CPU load and bandwidth consumption.

It is often the case that in surveillance deployments the physical dimensions of monitors, the effectiveness of visual stimulus, and the operators' regions of interest can all be very limited. Streaming large-size videos at all times will be a waste of bandwidth and system computing power. CIF and VGA size videos are usually sufficient for the operators of a surveillance software.

When enabled, your LiveClient station automatically requests smaller-size streams as video feeds from the network cameras.

When the size of view cells is manually expanded, a VAST server requests a different larger stream.

Facts about Auto Stream Size:

- The LiveClient utility automatically adjusts stream selection according to the size of view cells, no user's configuration is required.
 - The frame size of stream #1 is user-configurable.
 - Under no circumstances should you disable the Auto Stream Size function.
 - Stream jump takes place on the display of all connected cameras once the function is enabled.
 - If users configured a region of interest before the Auto Stream Size function is applied, e.g., via the ePTZ control, the view cell might display a different live view.
- Enable de-interlace function: Select this option if your connected device does not support de-interlace function. For example: VS7100.

- Enable **Instant Replay** on video cell (on a LiveClient installed to a PC): When enabled, a small Replay icon will be available on each view cell. One pre-condition is that the video stream must be currently being recorded to the NVR system.

Default replay length: Default is 30 seconds, use the pull-down menu to select a different length for video playback.

**NOTE:**

Instant Playback should be performed on one view cell only. If you playback multiple 1080P recording streams simultaneously, you may encounter system faults.



Instant Playback



Return to Live

To initiate an instant playback, move your mouse cursor to the lower left corner of a live cell. The Instant Playback icon will appear. Click on it, and a progress bar will appear. Click on the Play button to playback a configurable length of video that was recorded just before you started the Playback function (default is 30 seconds).



Joystick Settings

This section explains how to remotely control the network cameras using a USB joystick.

Enable Joystick

Connect to the USB plug of the joystick to a USB port on your computer. Supported by the plug-in in the main page (Microsoft's DirectX), once the plug-in in the main page is loaded, it will automatically detect if there is any joystick on the computer. The joystick should work properly without installing any other driver or software.

Then you can begin to configure the joystick settings of connected devices. Please follow the instruction below to enable joystick settings.

- Select the target device from the hierarchical management tree.
- Click **Configuration > Client Settings > Joystick Settings** on the menu bar to open the **Joystick Settings** window. If your joystick is working properly, it will be displayed on the drop-down list.
- Select the joystick you want to configure. Check **Enable Joystick**, then click **Configure Buttons** to open Buttons configuration window.

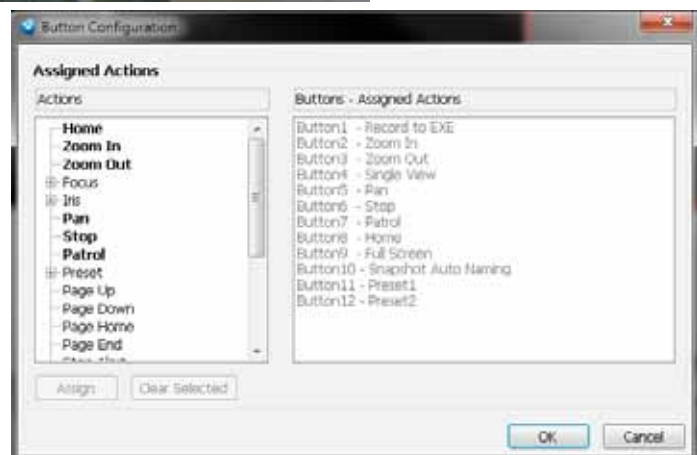
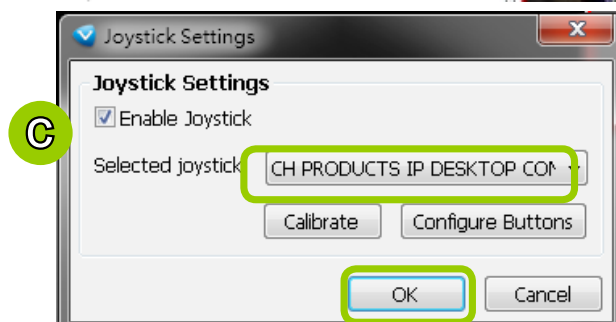
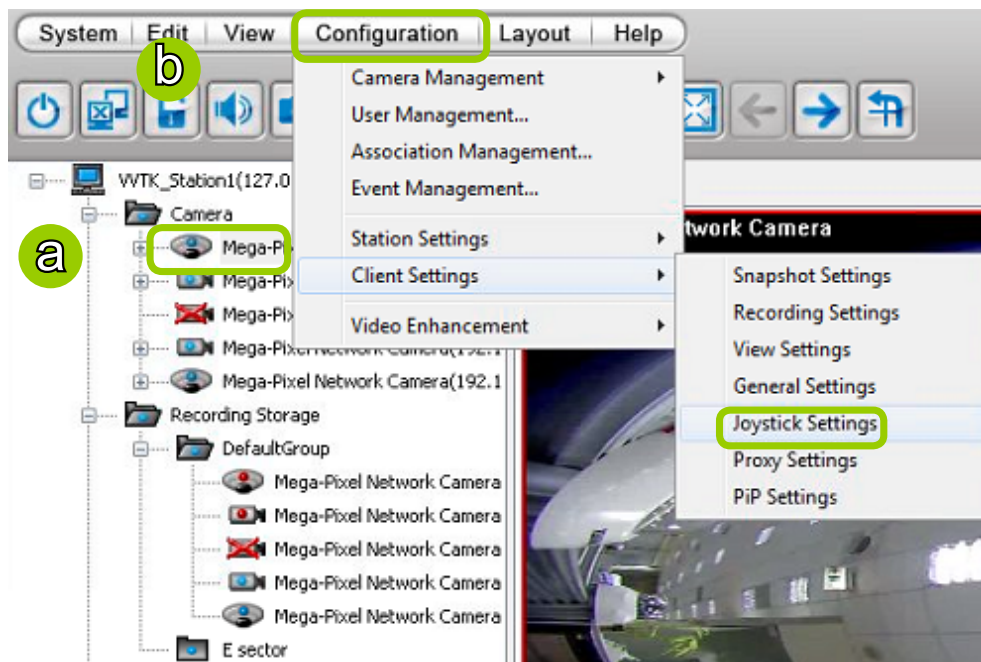

Buttons Configuration

In Button Configuration window, the left column shows the actions you can assign, and the right column shows the functional buttons and assigned actions. The number of buttons may differ from different joysticks.

Please follow the steps below to configure your joystick buttons:

- a. Choosing one of the actions and click **Assign** will pop up a dialog. Then you can assign this action to a button by pressing the joystick button or select it from the drop-down list.

For example: Assign **Home** (move to home position) to Button 1.

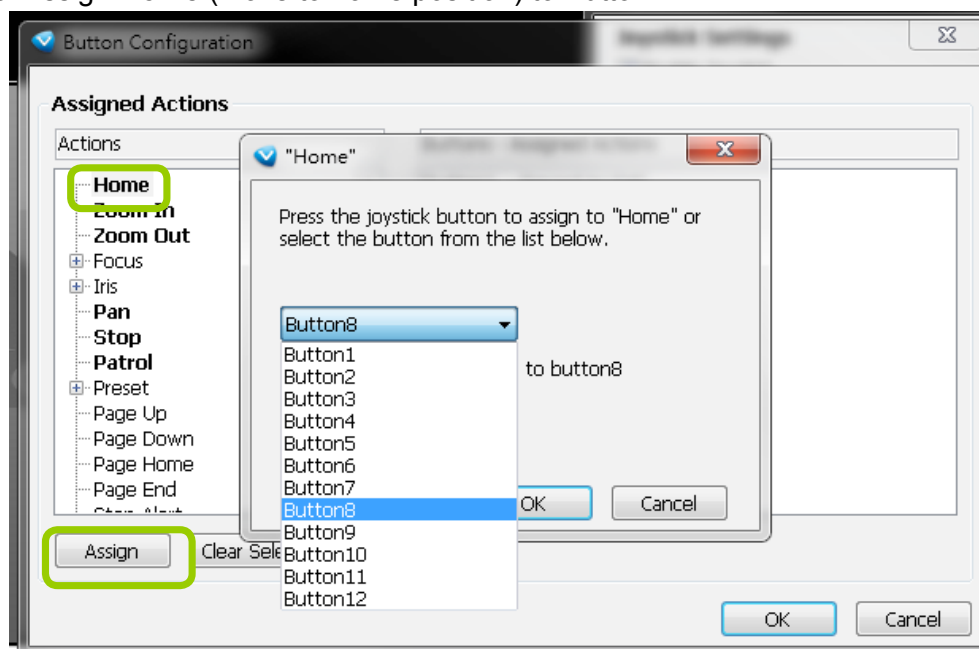

- b. Click **OK** to confirm the configuration.

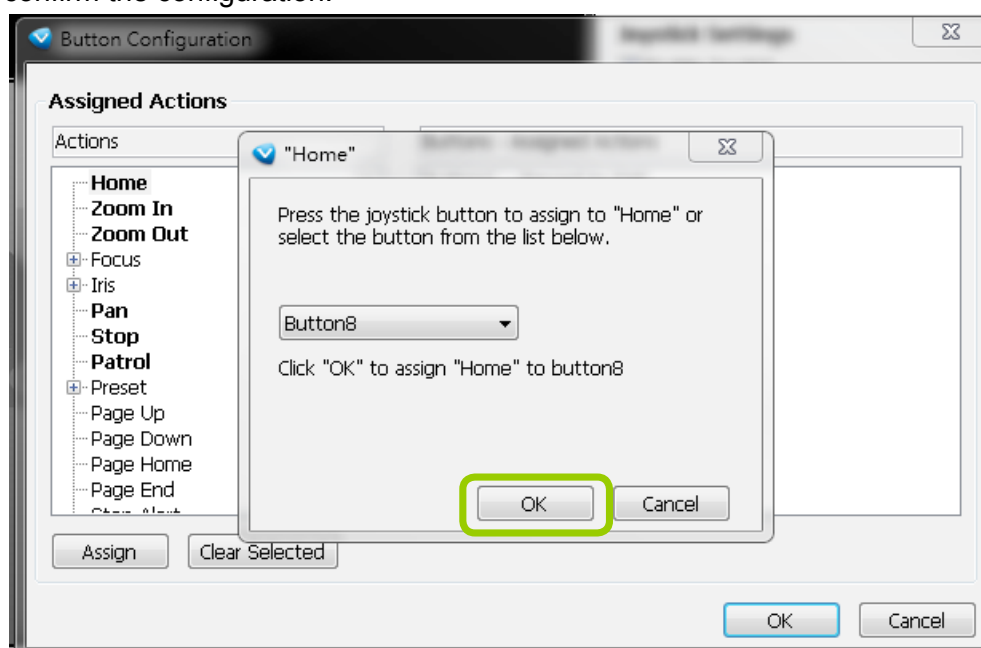

c. The Assigned Action will appear beside Button 1 in the right column as shown in the following diagram. Note that a button can only be assigned with an action. If you want to modify the settings, select the action on the list and click **Clear Selected**.

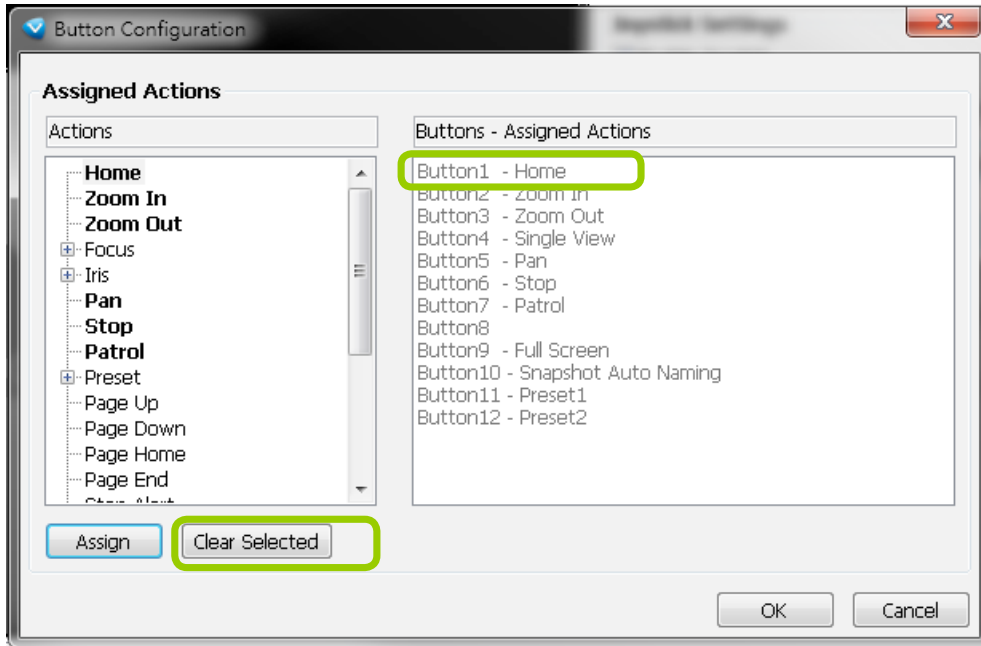

d. If you want to assign additional actions, repeat step a.~c. When all settings are complete, click **OK** to save the settings or click **Cancel** to discard the settings.

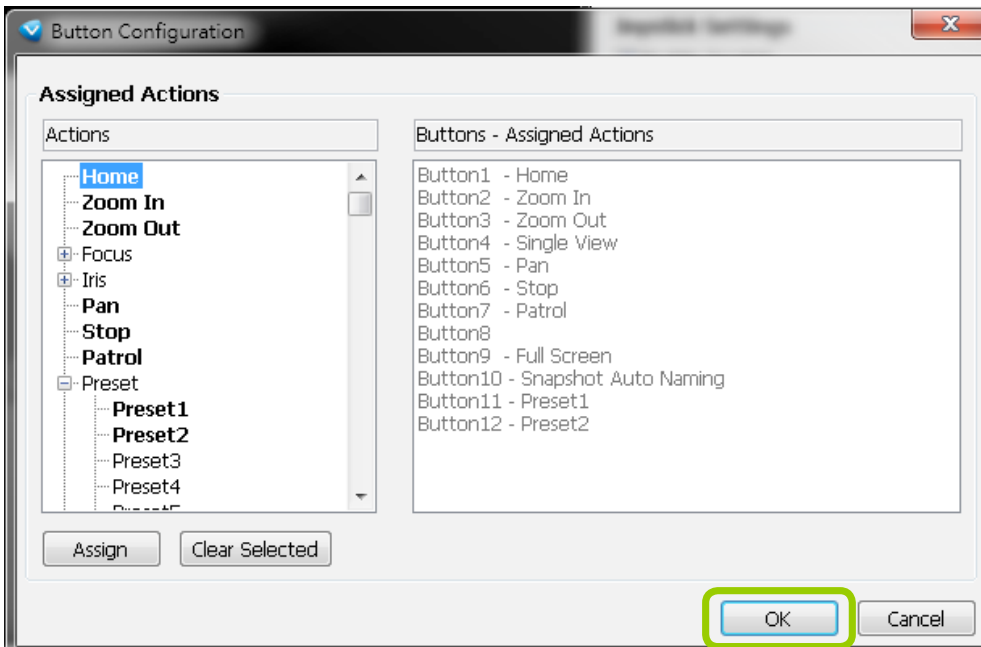

e. Click **OK** to save the settings or click **Cancel** to discard the settings.

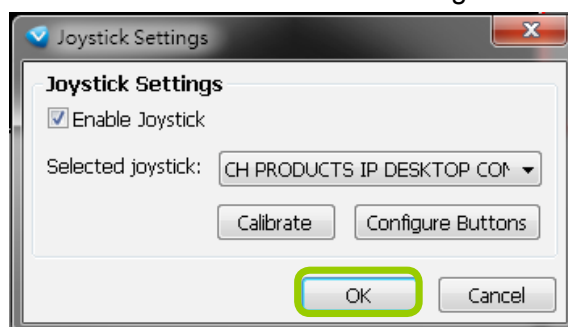

NOTE:

- If you want to assign Preset actions to your joystick, the preset locations should be set up in advance.
- If your joystick is not working properly, it may need to be calibrated. Click **Calibrate** to open the Game Controllers window located in the MS Windows control panel and follow the instructions for trouble shooting. For more information, please refer to the MS Windows help files for details.

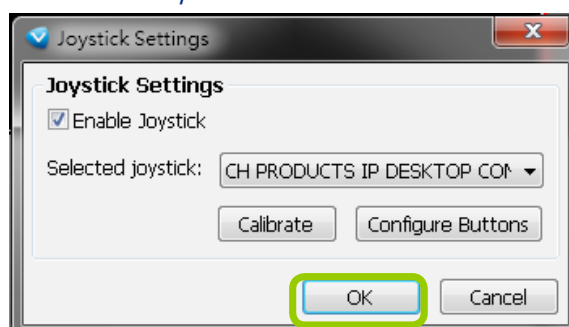

- The joystick will appear in the Game Controllers list in the Windows Control Panel on your computer. If you want to check out your device, go to the following page: Open Start > Control Panel > Game Controllers.

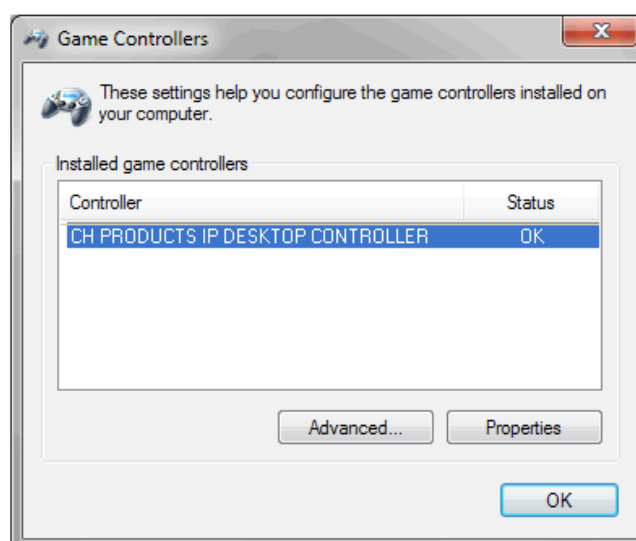

PTZ/ E-PTZ Function

In addition to using the PTZ control panel, you may also control the rotation handle on the joystick with ease.

Pan/Tilt: Move the rotation handle of the joystick; you can pan the camera to the desire position. There will be blue line displaying the moving direction in the center of the video image as the diagram 1 below.

Zoom in/Zoom out: Shift the rotation handle clockwise to zoom in the camera on an image or go counterclockwise to zoom out the camera on an image. There will be a circle and four vectors in the center of the video image as the diagram 2, 3 below.



Pan/Tilt
(Move the rotating handle back and forth)

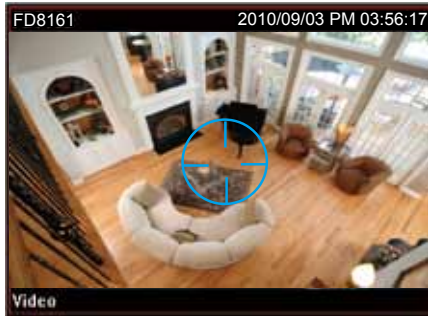

Zoom in
(Turn the rotating handle clockwise)

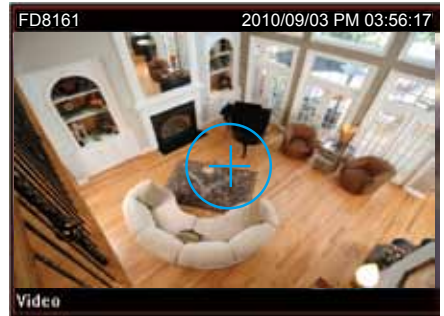

Zoom out
(Turn the rotating handle counter-clockwise)

Proxy Settings

If you are not running the LiveClient on a remote computer, skip the below description. In this section, you can enable, modify, or cancel **Proxy Settings** for client if your VAST Server is under a proxy. If you change the proxy settings, please fill in the new value next time you login the LiveClient next time.

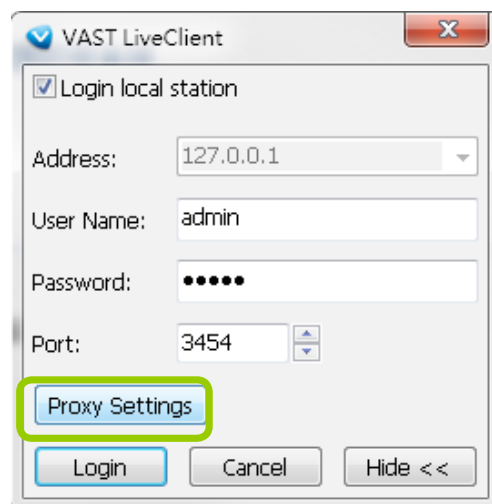
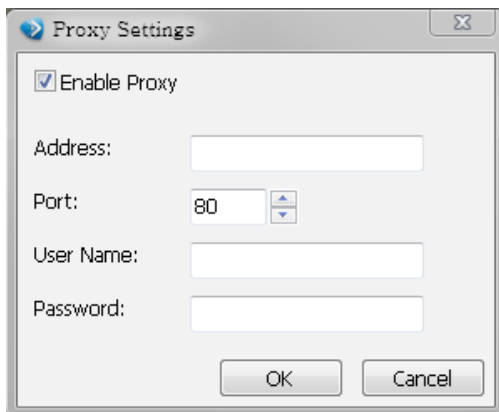

How to Use PiP (Picture-in-Picture)

PiP (Picture-in-Picture) is an intuitive function for user to simultaneously view a Global View and ROI (Region of Interest) for live monitoring. The digital zoom in function can only focus on the interested area and represent the details of megapixel video. Moreover, the multi-touch mode is a very user-friendly interface for digital zoom in.

Enable PiP

Right-click the video cell and select **Enable PiP**. If you want to disable PiP, click the option again to uncheck it. After you enable the PiP function, a movable global view window and a ROI frame will be displayed as shown below.

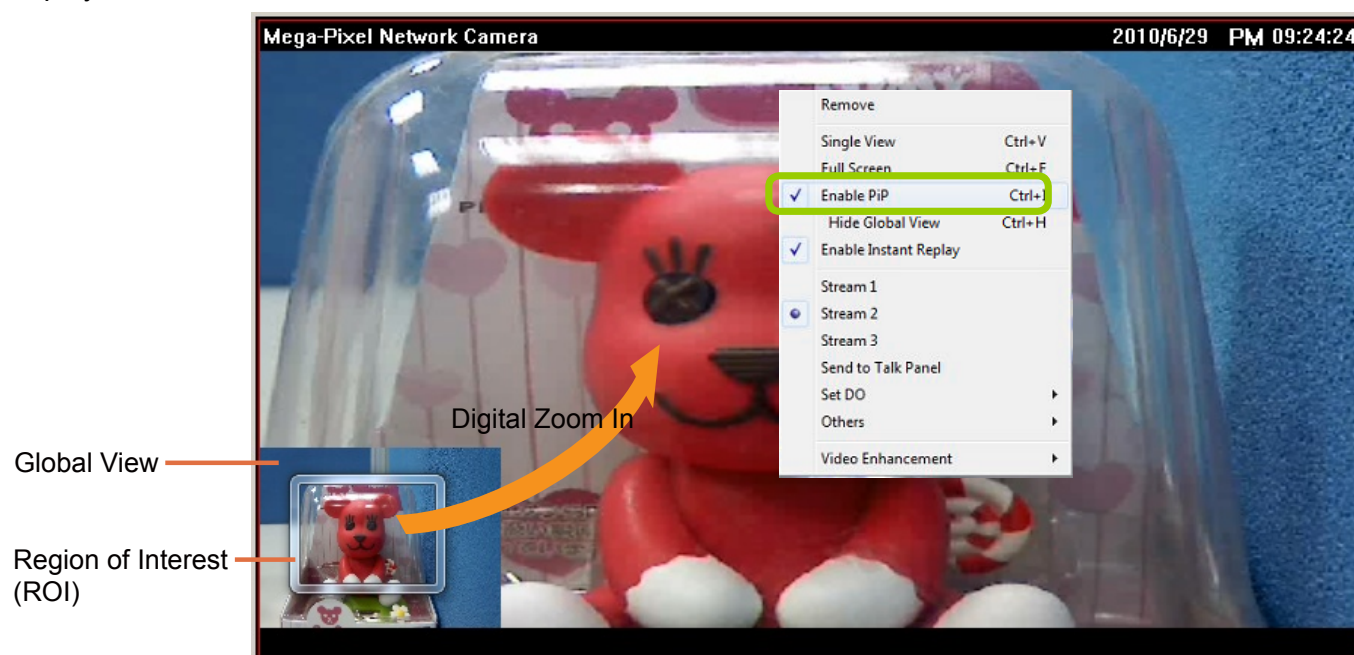

Global View

The global view is the original view with the size scaled down to 160x120. It is movable and you can drag it anywhere across the live view window. If you want to hide the global view, **right-click** the video cell and select **Hide Global View** from the menu. A magnifier icon will appear on top of the live view window.

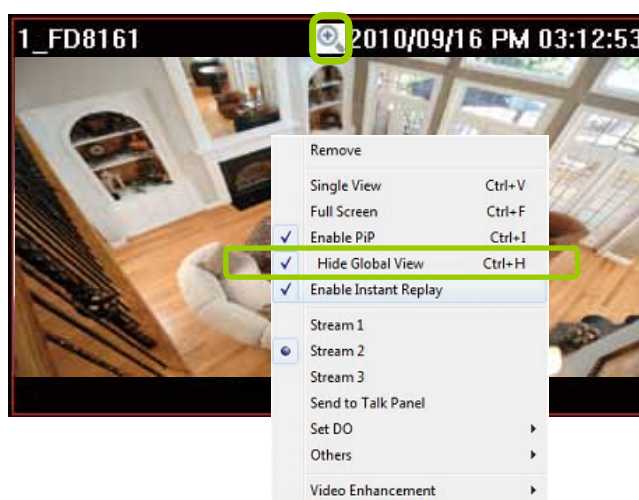

ROI (Region of Interest)

The ROI frame can be resized and moved in any direction across the global view window. The working theory is similar to the e-PTZ function.

Digital Zoom In

Through digital zoom in, the live view window will be filled with the zoomed in ROI image. The maximum magnification of the ROI frame is 16x zooming. The zoomed in area will change as the ROI frame is dragged and resized. You can also easily zoom in and zoom out the ROI frame by rolling the mouse back and forth.

Snapshot Zoomed In Image

You can snapshot a zoomed-in image.

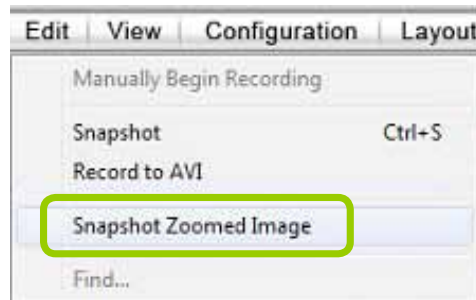

PiP Settings

The PiP Settings is for you to adjust the initial position of the global view window.

Click **Configuration > Client Settings > PiP Settings** to open the window. On top of it, you may choose the horizontal position with left / middle / right side of the live view window, or you can customize the percentage of space distance from the border of the live view window as an option. It is also fully applied for vertical position with top / middle / bottom side of the live view window. When it's done, you may click on **Apply to existing windows** to enable the settings.

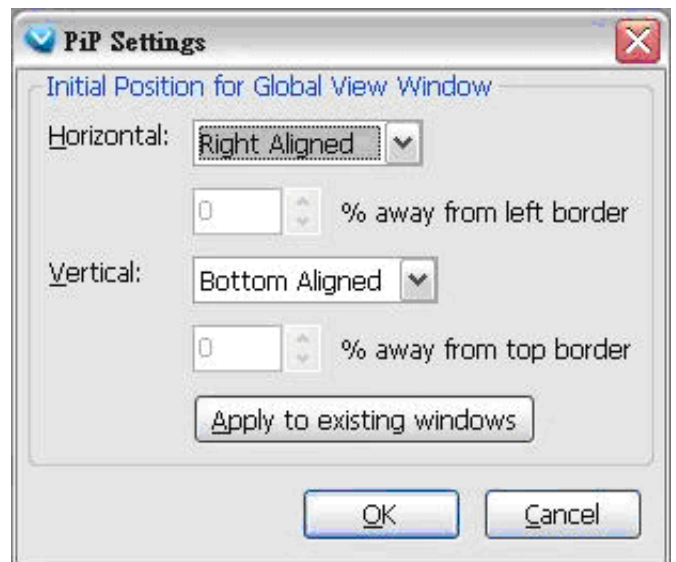
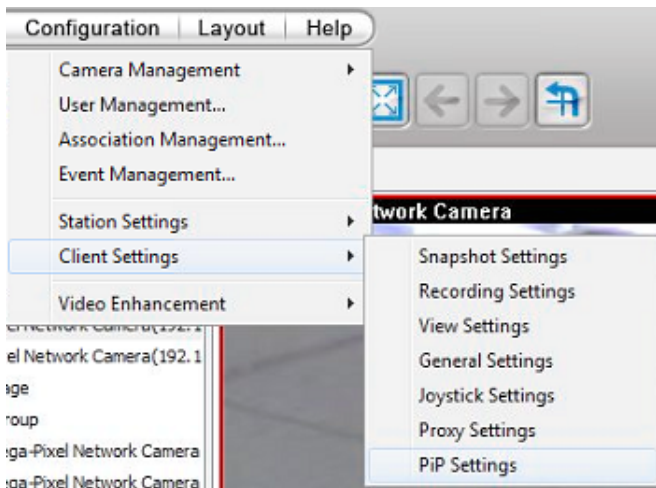

NOTE:

- The ROI and global view position will be removed when the live view cell is removed from the main screen.
- The PiP function also applies in the Playback utility.

How to Configure Video Enhancement

IMPORTANT:

The Video Enhancement function consumes considerable system resources. It is not recommended to exert this function on multiple view cells.

The LiveClient allows you to enable post-image enhancement and defog for video live view.

Basic Image Adjustment

This function allows you to configure basic image adjustment including Brightness, Contrast, Saturation, and Hue.

Please follow the steps below to set a profile for post-image adjustment settings:

- Select the target video cell.
- Click **Configuration > Video Enhancement > Basic Image Adjustment > Settings** on the menu bar to open the **Profile Settings** window. (Or you can **right-click** the video cell and select **Video Enhancement > Basic Image Adjustment > Settings** from the popup menu.)

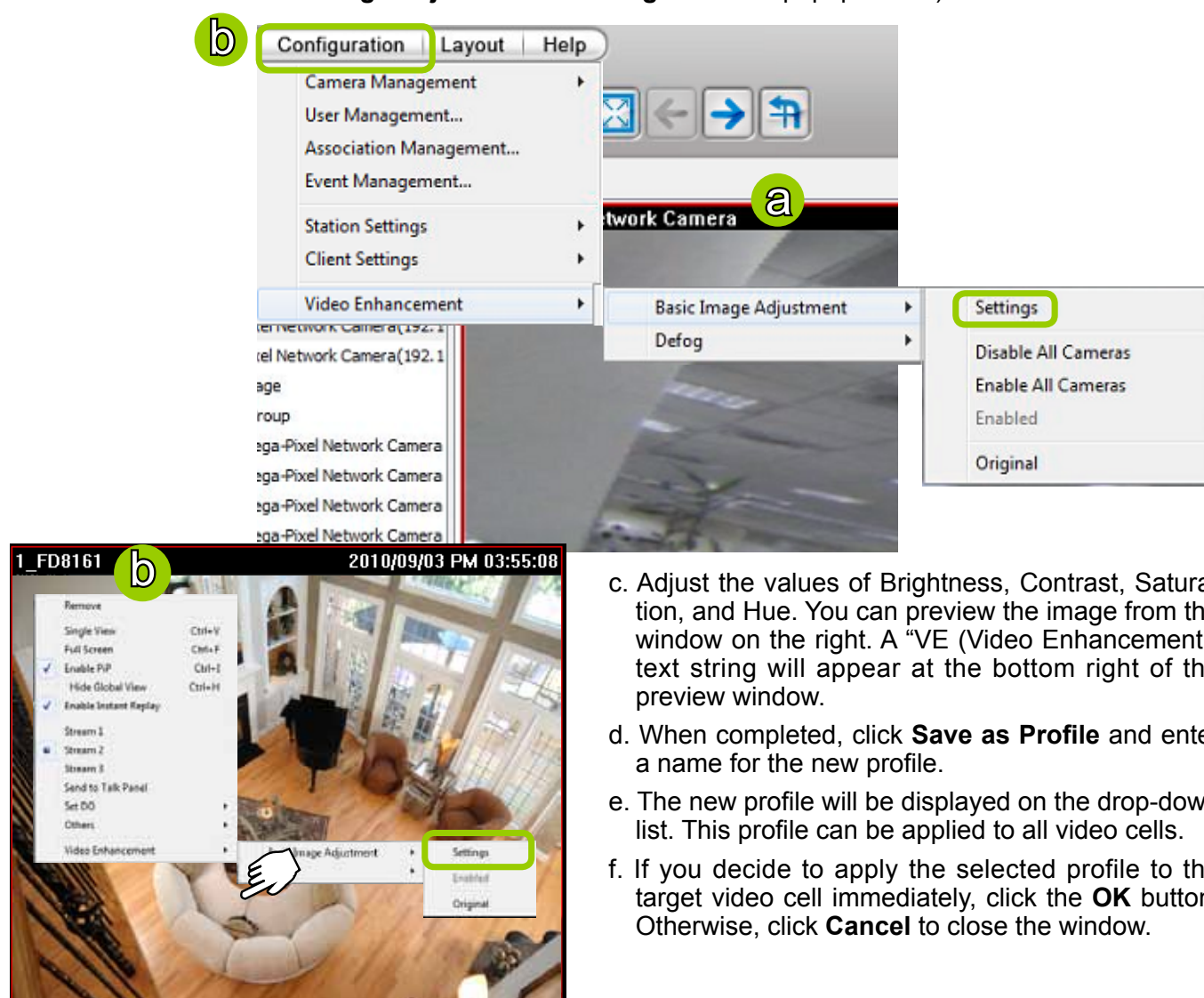

- Adjust the values of Brightness, Contrast, Saturation, and Hue. You can preview the image from the window on the right. A "VE (Video Enhancement)" text string will appear at the bottom right of the preview window.
- When completed, click **Save as Profile** and enter a name for the new profile.
- The new profile will be displayed on the drop-down list. This profile can be applied to all video cells.
- If you decide to apply the selected profile to the target video cell immediately, click the **OK** button. Otherwise, click **Cancel** to close the window.

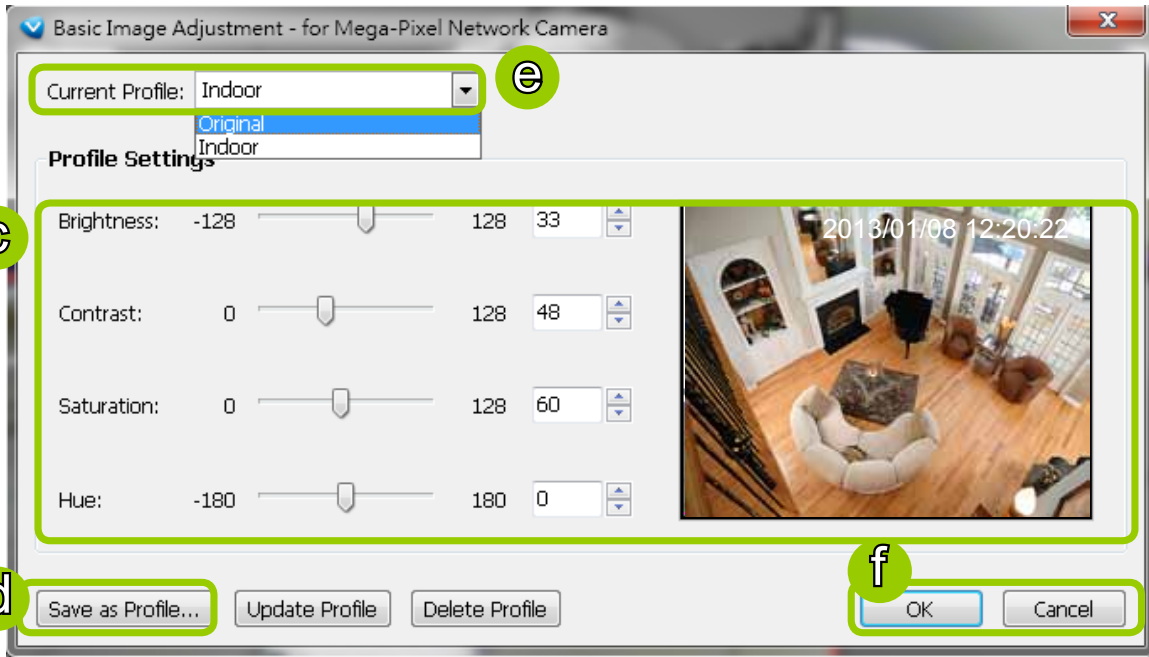

g. Back to the main page, a “VE” text string will also appear at the bottom right of the video cell and the new profile will also appear and be selected on the popup menu as shown below.

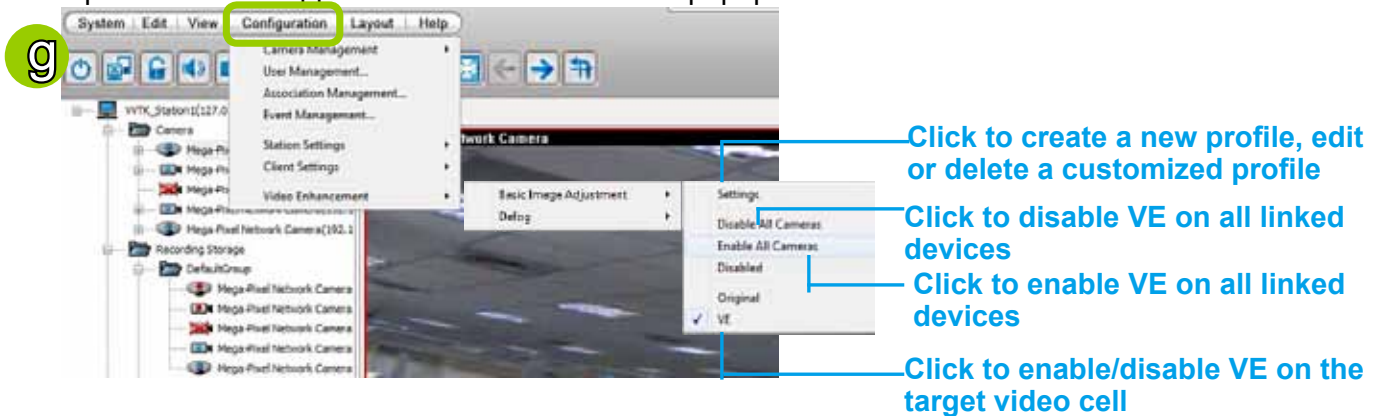

Click to create a new profile, edit or delete a profile

Click to enable/disable VE on the target video cell

Defog

This function allows you to configure post-image defog.

Apply a Preset Defog Profile

Please follow the steps below to set post-image defog settings:

- Select the target video cell.
- Click **Configuration > Video Enhancement > Defog** or right-click the video cell and select **Video Enhancement > Defog**.
- There are some preset profiles for you to apply to the target video cell. You can select one from the list according to the environment.

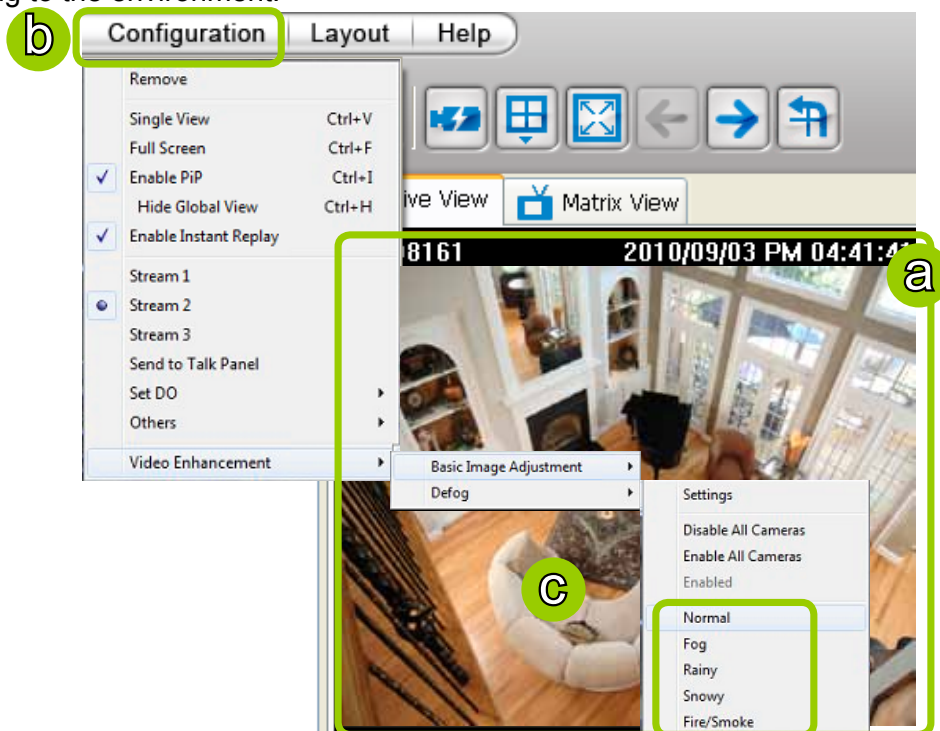

d. The string of the selected profile will be selected as shown below. A “VE” text string will also appear at the bottom right of the video cell.

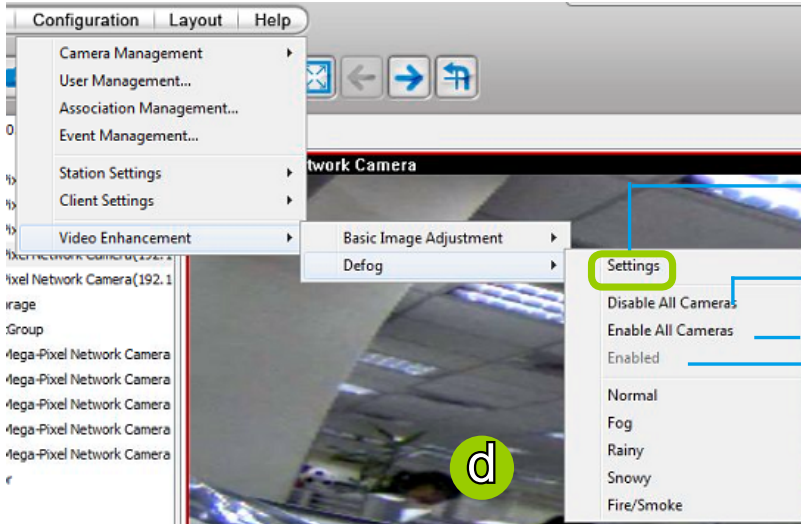

e

Click to create a new profile, edit or delete a customized profile

Click to disable VE on all linked devices

Click to enable VE on all linked devices

Click to enable/disable VE on the target video cell

d

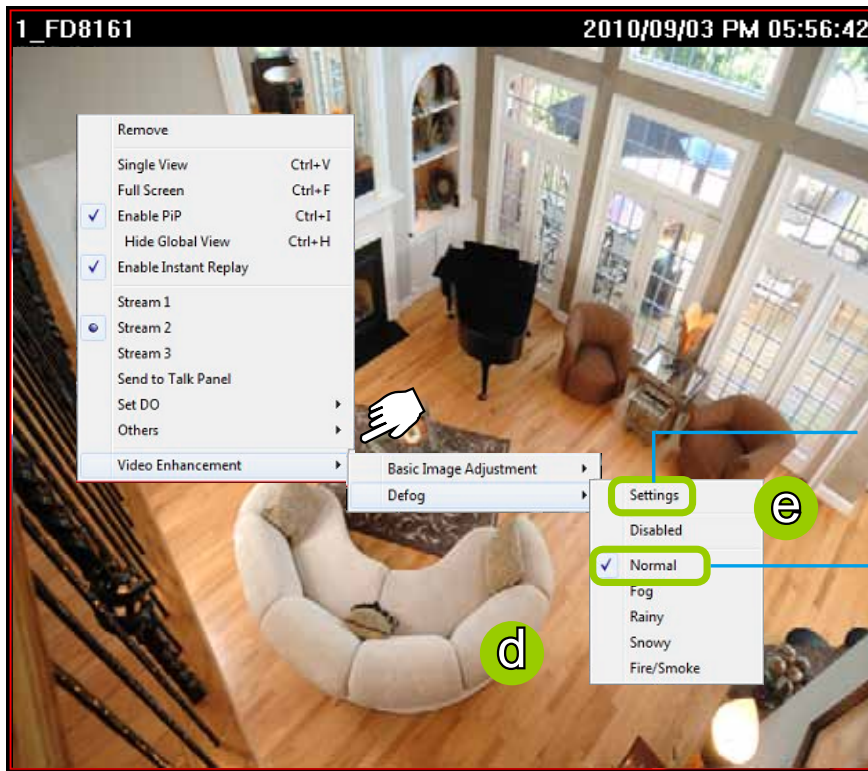

Click to create a new profile, edit or delete a profile

Click to enable/disable VE on the target video cell

d

e

Create a New Defog Profile

e. Click **Settings** on the popup menu to open the **Profile Settings** window.

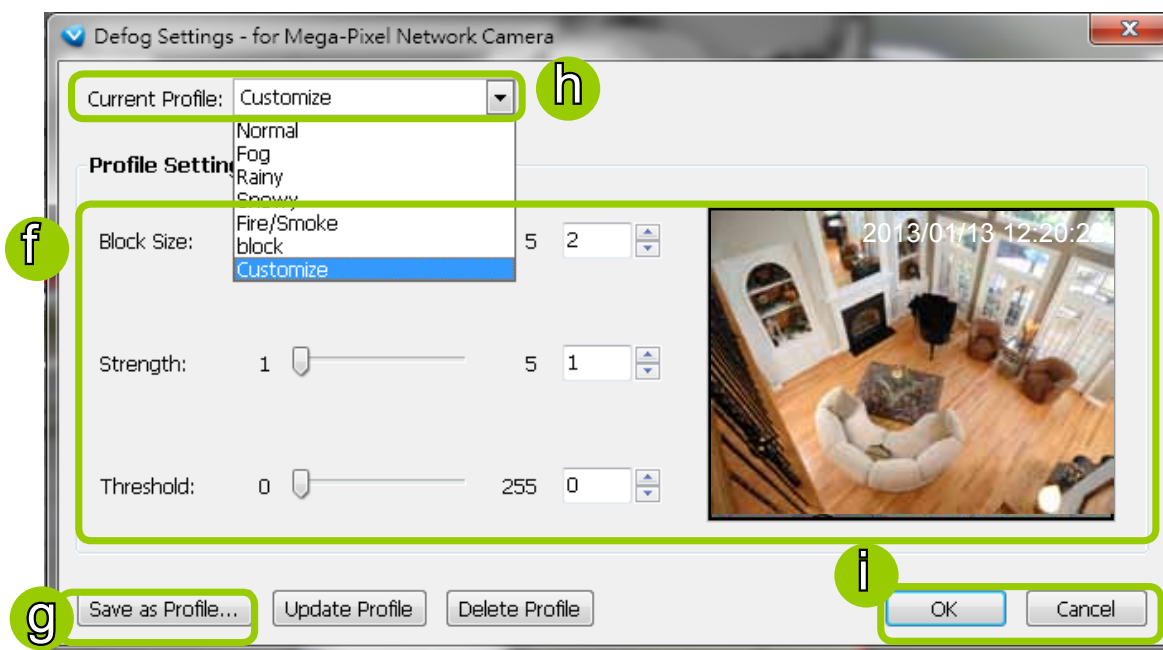

f. Adjust the values of Block Size, Strength, and Threshold. You can preview the image from the right window. A “VE (Video Enhancement)” text string will also appear at the bottom right of the preview window.

Block Size: Brush diameter from thick to thin (Value 1~5)

Strength: Brush stroke from soft to strong (Value 1~5)

Threshold: Brush pixel from loose to dense (Value 0~225)

g. When completed, click **Save as Profile** and enter a name for the new profile.

h. The new profile will be displayed on the drop-down list. This profile can be applied to all video cells.

i. If you decide to apply the selected profile to the target video cell immediately, click the **OK** button. Otherwise, click **Cancel** to close the window.

How to Search for a Device on the Hierarchical Device Tree

This function allows you to conveniently search for an inserted device, which is useful when many devices have been inserted.

Please follow the steps below to find a device on the camera list:

- a. Click the station on the hierarchical management tree.
- b. Click **Edit > Find** on the menu bar (or **right-click** the station and click **Find**).

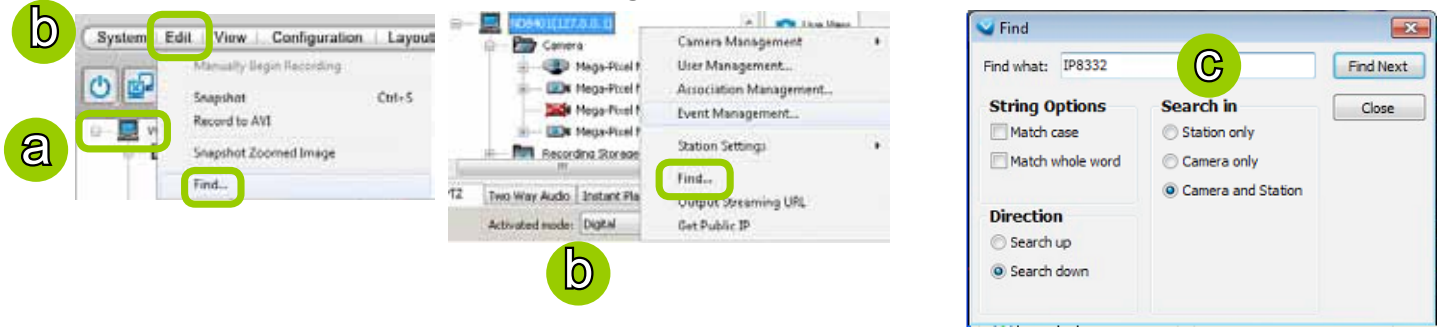

- c. The **Find** window will pop up for you to set your search criteria.
 - Find what: Enter a string in the blank. The string can be the full or partial name of the device you want to search for.
 - String Options: **Match case** represents that the search results should be identical to the string in lower-case or upper-case letters, the string can be part of a word. **Match whole word** means that the search results should be identical to the string for every character, and that the string should be a complete word or phrase. If you select both options, the search results should conform to all criteria listed above.
 - Direction: Select **search up** or **search down**.
 - Search in: Select **search in station or camera**.

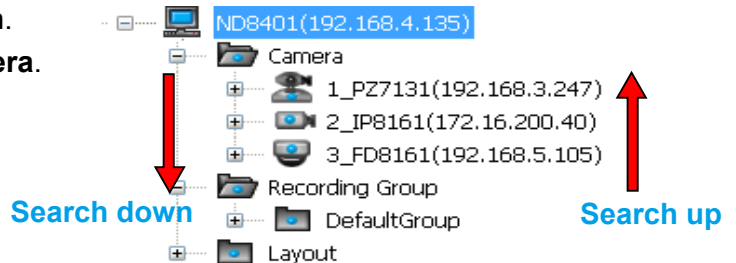

- d. Click **Find Next**, the searching result will be marked as shown below.

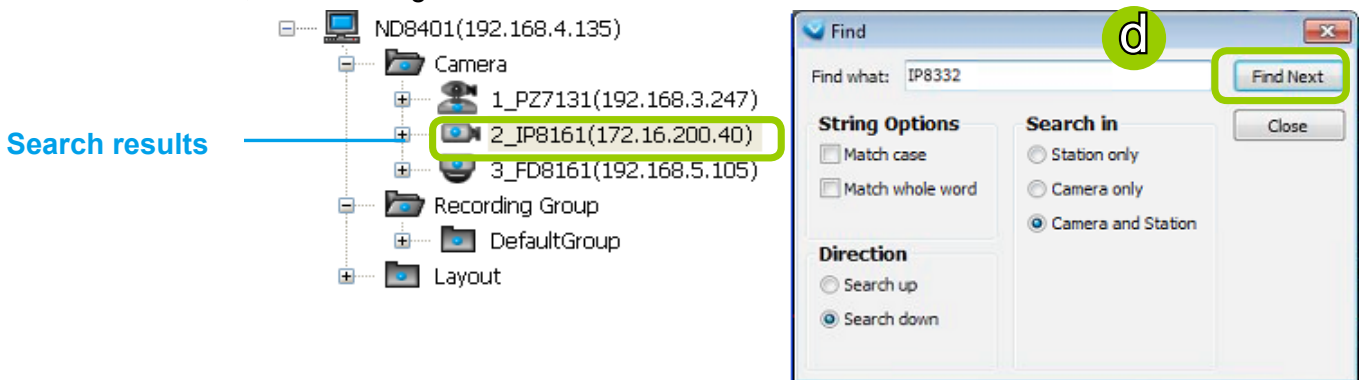

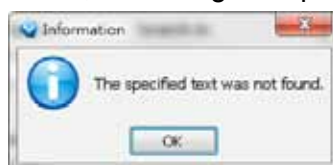

- e. If there is nothing found in the camera list, a message will pop up as shown below:



How to Lock LiveClient for Security Concerns

If you are away from your computer, for security reasons, we suggest you lock the program. When LiveClient is locked, the user must fill in the correct password to unlock and access the program again.

- To lock LiveClient, click **Unlock**  on the quick access bar or click **System > Lock** on the system menu. The **Unlock**  icon will then turn into **Lock** .
- To unlock LiveClient, fill in the correct password in the popup window.

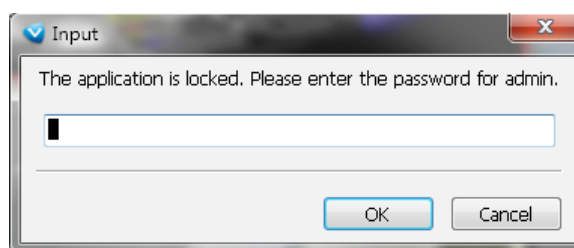
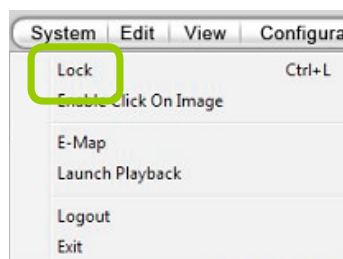

How to Log out from the VAST Server

To logout from the current server, click **Logout**  on the quick access bar or click **System > Logout** on the menu bar. A confirmation window will pop up. Click **OK** to confirm or **Cancel** to return to the VAST LiveClient window.

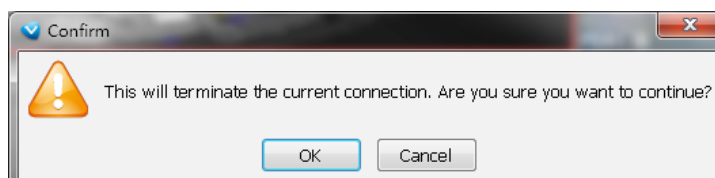
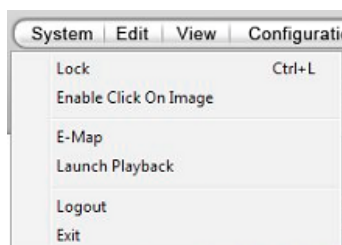

How to Exit VAST LiveClient

To exit VAST LiveClient, click **Exit**  on the quick access bar or click **System > Exit** on the menu bar. A confirmation window will pop up. Click **OK** to confirm or **Cancel** to return to the VAST LiveClient window. When you exit the program, your user account will be automatically logged out from the current server.

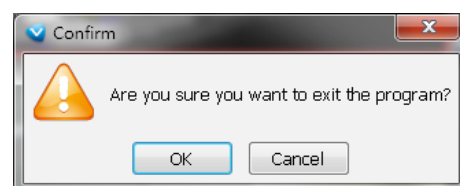
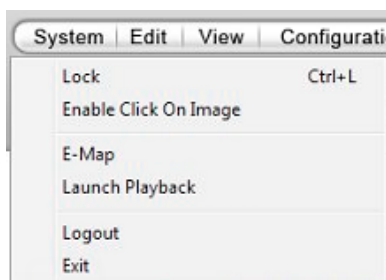

Launch Playback

Click on **Launch Playback** to directly open the Playback utility.

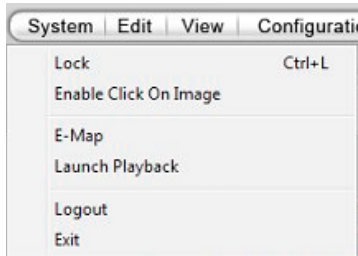

Note that the LiveClient utility is still running in the background when you return to the Control Center.

Second View

This function is only available on a LiveClient running a PC that has 2 monitors. Clicking the button opens the second live view window enabling the display of more camera views.

Chapter Three NVR Playback Configuration

Activating VAST Playback and Logging in to a Server

VAST Playback allows you to search and playback recorded media data from the NVR system. Once you insert a device into the hierarchical device tree on the LiveClient, it is automatically listed on the device tree on the Playback utility. You can then begin to use Playback to view, retrieve, and search for recorded or backed-up video clips.

Please follow the steps below to activate the Playback utility:

1. Run the **Playback** program. If you have already run the LiveClient, you can click on **System > Launch Playback** to open a Playback console.
2. A **Login** window will prompt. Fill in the information as shown below:
 - By default, the Playback console automatically log in to the VAST Server running on the NVR system. Enter the **User Name**, **Password**, and **Communication Port** of the local server to log in. Click **Login** to log in to the target server or **Cancel** to exit the system.

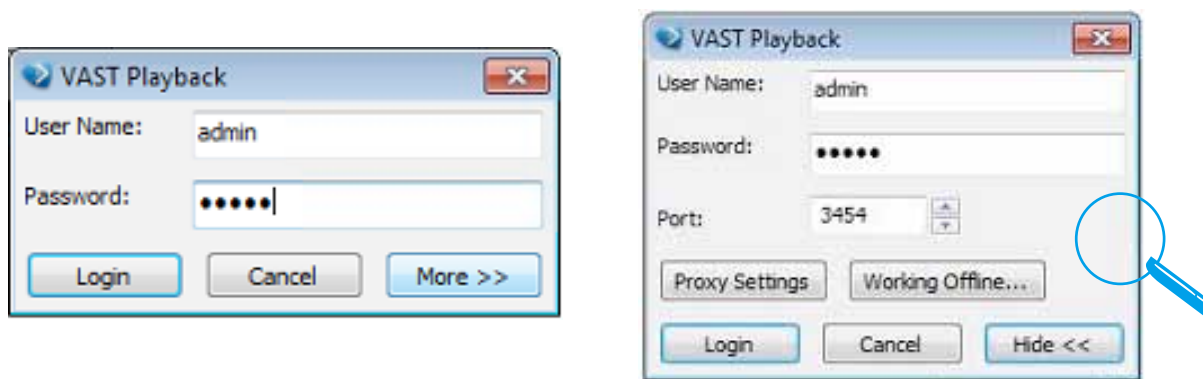

3. The VAST Playback main window will be displayed.

 **NOTE:**

- If your network environment need to set up proxy, click **More >>** to extend the login window, then click **Proxy Setting** to open the dialog. Then enter related information to link to your proxy server.

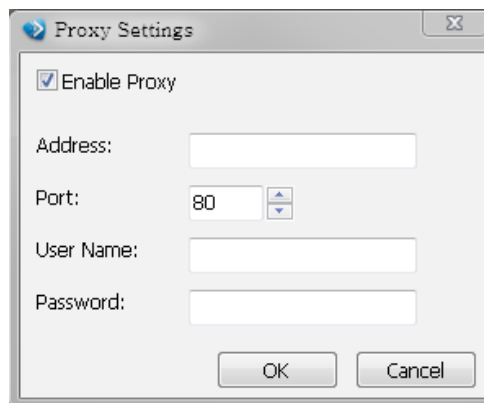

- Available functions of the VAST Playback program will be enabled according to the role of your login account. For more details about the privileges of the user account, please refer to **How to Manage User Accounts** on page 57.
- You may want to open the LiveClient and the Playback utilities simultaneously, use the **Launch LiveClient** command on the menu bar.

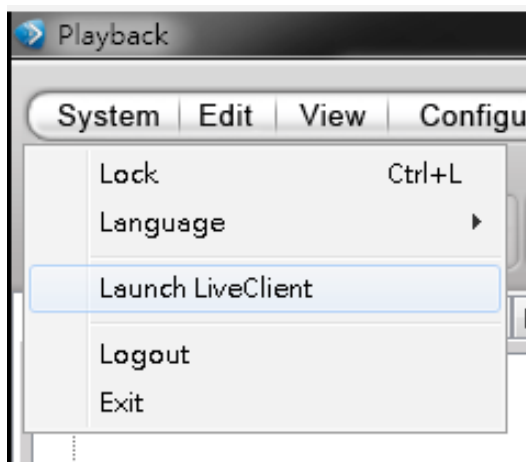

VAST Playback User Interface

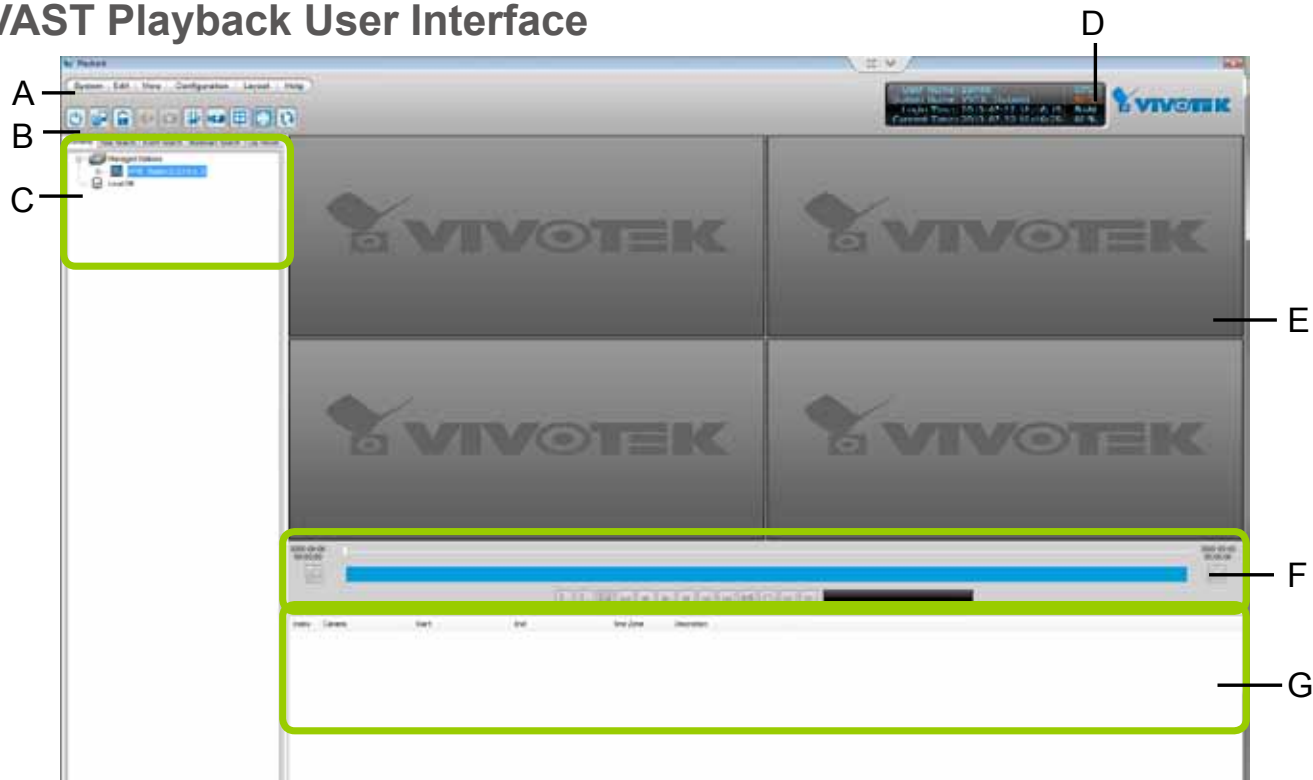

- A. Menu bar
- B. Quick access bar
- C. Query panel (Browsing / Time search /Event search / Log viewer)
- D. Status panel
- E. Recorded video playback window
- F. Playback control panel
- G. Video clips list

Menu Bar

Menu Item	Drop-down Options
System	Lock / Language / Launch LiveClient / Logout / Exit
Edit	Snapshot / Snapshot Zoomed Image / Print Zoomed Image / Find
View	Backup Status /Exporting Status / Time Search / Event Search / Bookmark Search / Log Viewer / Full Screen
Configuration	Client Settings (Snapshot Settings / Export Settings / View Settings / Proxy Settings / General Settings) /PIP Settings
Layout	Change Layout
Help	About

Status Panel

User Name: admin	CPU
Station Name: VTK_Station1	90 %
Login Time: 2013-07-22 18:46:19	RAM
Current Time: 2013-07-22 18:46:25	60 %

User Name	CPU
Station Name (IP Address)	usage
Login Time (yyyy-mm-dd hh:mm:ss)	RAM
Current Time (yyyy-mm-dd hh:mm:ss)	usage

Quick Access Bar



Icon	Function	Description
	Exit	Exit the system
	Logout	Logout from the current station
	Lock	Click to Lock the system for security concerns (Unlock the system)
	Volume	Adjust the audio volume of the target video (Mute)
	Snapshot	Capture the picture of the target video
	Print	Print the current cell or the view of all cells
	SVC Level	Exert SVC control of video playback frame rate
	Remove All Connection	Remove all live videos from the live video monitoring window
	Layout	Change the layout of video monitoring window
	Full Screen	Maximize the live video monitoring window



NOTE:

Some buttons will be disabled if the selected device does not support those functions.

Recorded Video Playback Window

The "VIVOTEK" wallpaper is in place if no camera has been assigned to the video cell.

The red frame () represents the focused cell.

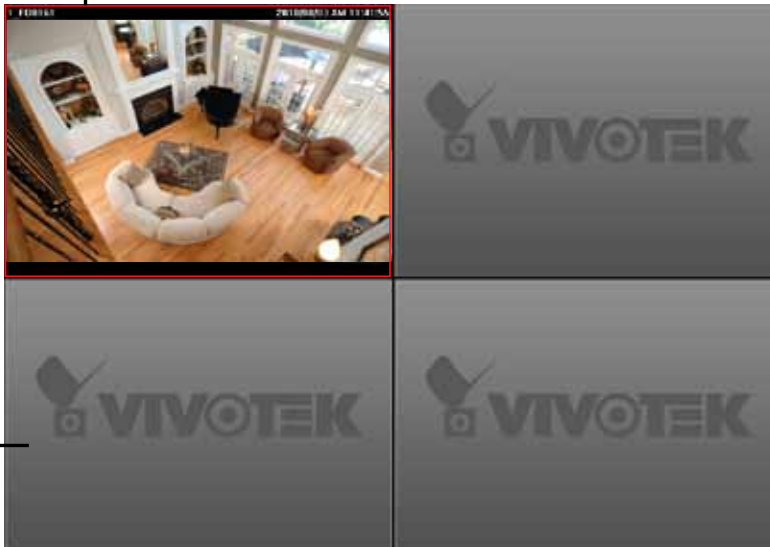





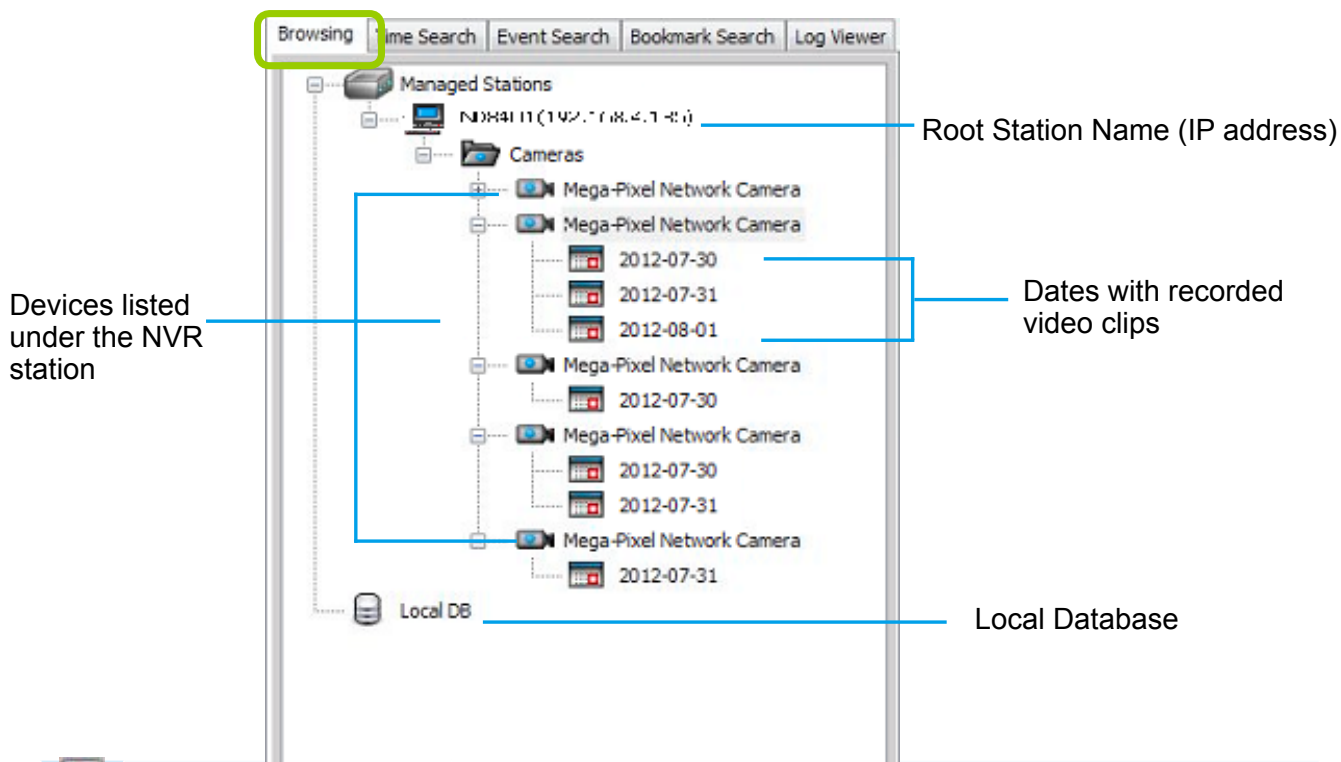

Video Cell

Query Panel-- Browsing Page



 **Synchronous Playback** Click to enable synchronous playback for multiple channels

Icon	Description
	NVR Station list including server and local database
	A station (NVR that has a running VAST Server)
	The camera that exists on the hierarchical device tree of LiveClient.
	The camera that has been removed from the hierarchical device tree of LiveClient (off-line). However, its recorded video (if any) is still accessible from the server.
	Dates with recorded video clips.
	Local database for backup data. For more information about how to upload backup data to the list, please refer to page 165.

Query Panel--Time Search Page

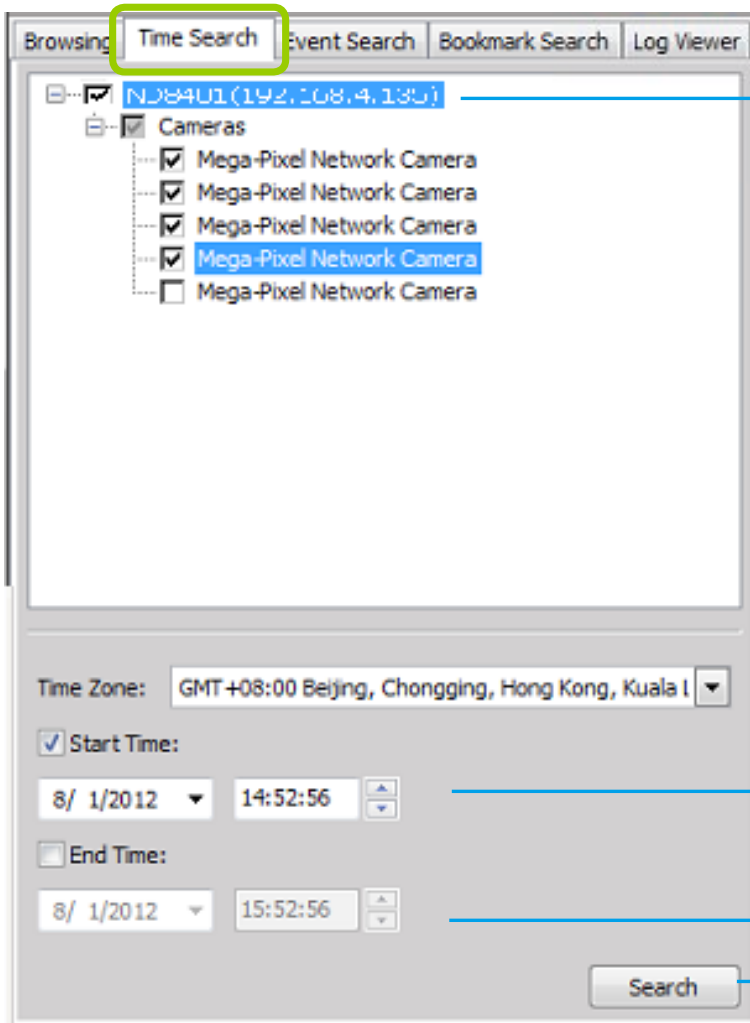

Select station(s)/ device(s) that you want to search for recorded files

Specify search period of time

Click to start to search, the results will be shown on the video clips list



 **NOTE:**

The **Time Zone** setting is automatically synchronized with that on the NVR station.

Audio Control



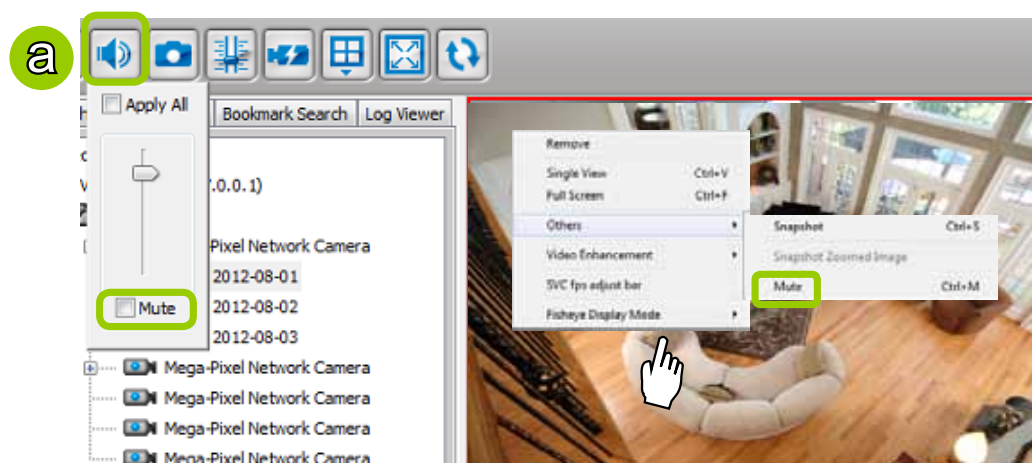

The audio function will be enabled if the device is equipped with an internal or external microphone. Please follow the steps below to adjust the volume or turn the audio on/off for a video stream:

- To turn off the audio (Mute Mode)
 - a. Click **Audio On**  on the quick access bar and check **Mute**. Or you can **right-click** on the video cell to open the popup menu, then click **Others > Mute**. The mute option in the popup menu will then be selected.
 - b. If you want to turn off the audio of all live video, select **Apply all**.
 - c. The Audio icon will then change from  to .



- To adjust the audio volume
 - a. Click **Audio On**  on the quick access bar.
 - b. Drag-and-drop the slider bar. Slide to a higher position for louder volume.

- To turn on the audio
 - a. Click **Mute**  on the quick access bar and uncheck **Mute**. Or you can **right-click** on the video cell to open the popup menu, then click **Others > Mute**. The mute option in the popup menu will then be unchecked.
 - b. If you want to turn on the audio of all live video, select **Apply all**.
 - c. The Audio icon will then change from  to .

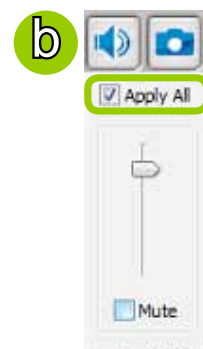
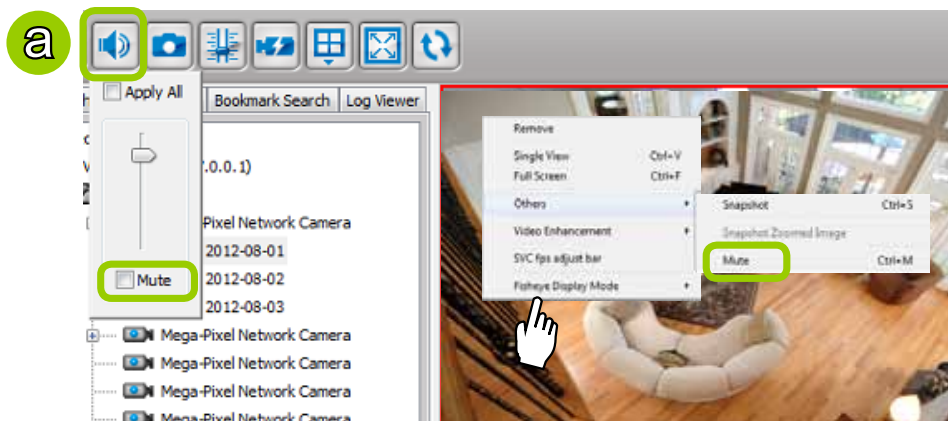

How to Change the Playback Layout

Changing the Layout of the Recorded Video Playback Window

VIVOTEK VAST Playback supports up to 16-CH simultaneous recorded video playback on a single monitor and allows you to change the layout of the recorded live video playback window based on the number of inserted devices.

Switch Video Channels

Drag-and-drop a video channel to another empty video window.



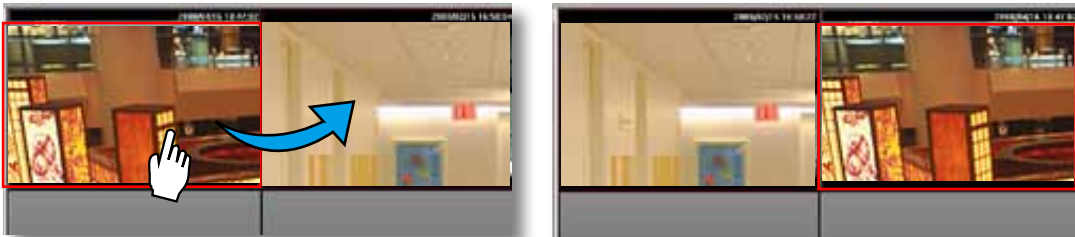

To switch two channels, **drag-and-drop** one view to the other, then the two channels will switch positions.

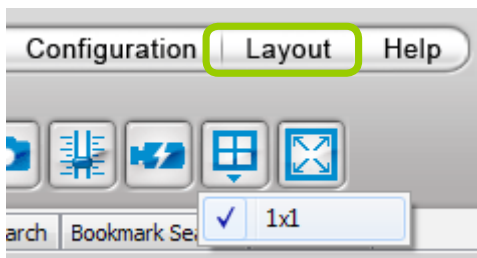

Layout Mode

Currently, a local display for the **Layout**  has only one, 1x1, display option. If you access the NVR via a LiveClient on a remote PC, another 2x2 layout will be available.



Layout mode	Description
1 x 1	
2 x 2	

Maximize the Recorded Video Playback Window

- Single View: to maximize a video cell to the entire video playback window

Double-click the video cell, or **right-click** the video cell and select **Single View**. The selected video will expand to fill the entire Playback window as shown below.

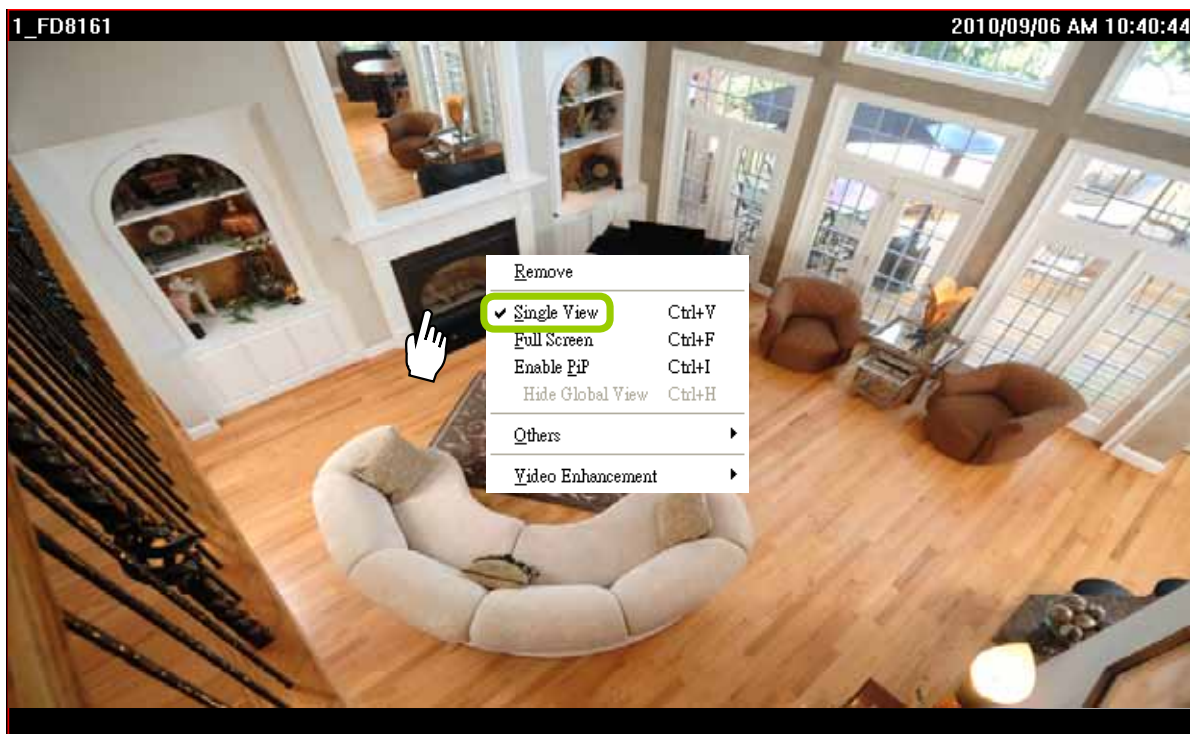
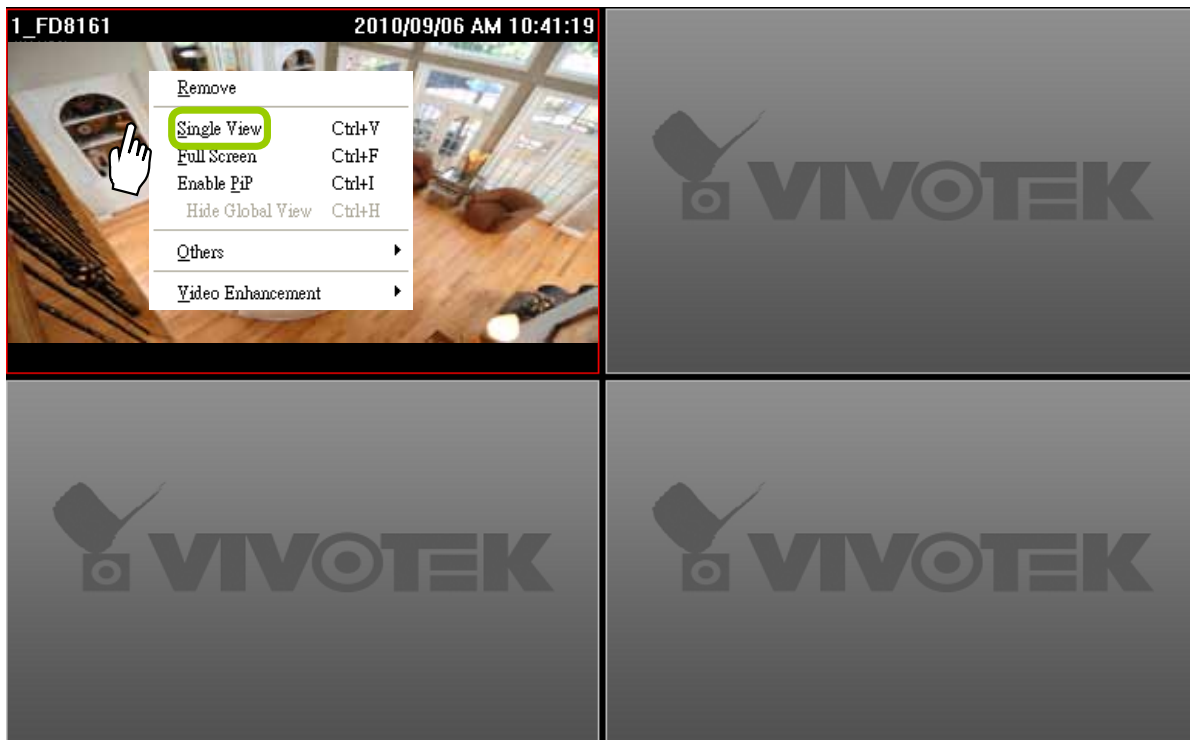

To restore to the original layout, **double-click** the video cell or **right-click** the video cell and uncheck **Single View**.

- Full Screen: to maximize the video playback window to the entire screen

Click **Full Screen**  on the quick access bar or **right-click** the video cell and select **Full Screen**. In addition, you can also click **View > Full Screen** on the menu bar to maximize the recorded video playback window.

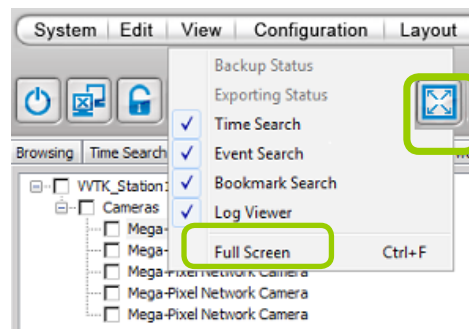

To restore to the original layout, **right-click** the video cell and uncheck **Full Screen**. You also can press the **Esc** button on the keyboard to leave the full screen mode.

How to Backup Recorded Video

In addition to the Schedule Backup function of VAST LiveClient introduced on page 61, the Playback utility can back up recorded video clips from the **local database**. Please open the **Browsing** page and follow the steps below to backup recorded video:

- a. Select the target files.
 - To backup all recorded video of a selected device: **Right-click** the device and click **Backup**.

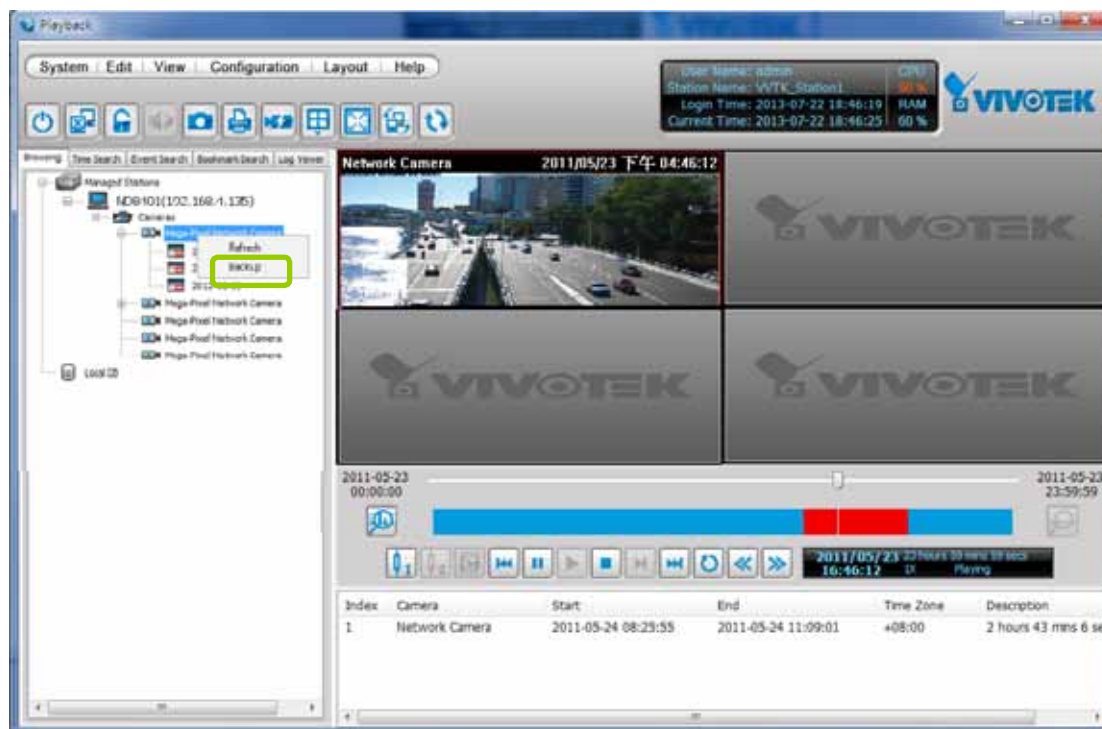

- To backup all recorded video of the day: **Right-click** the option “date” and click **Backup** (or select the date and click the **Backup** button below).



- To backup part of the recorded video of the day: Select the date and choose the video clip(s) from video clip window. Then **right-click** the selected option(s) and click **Backup**. Note: Use the combination of the **Shift** key and left mouse click to select multiple video clips.

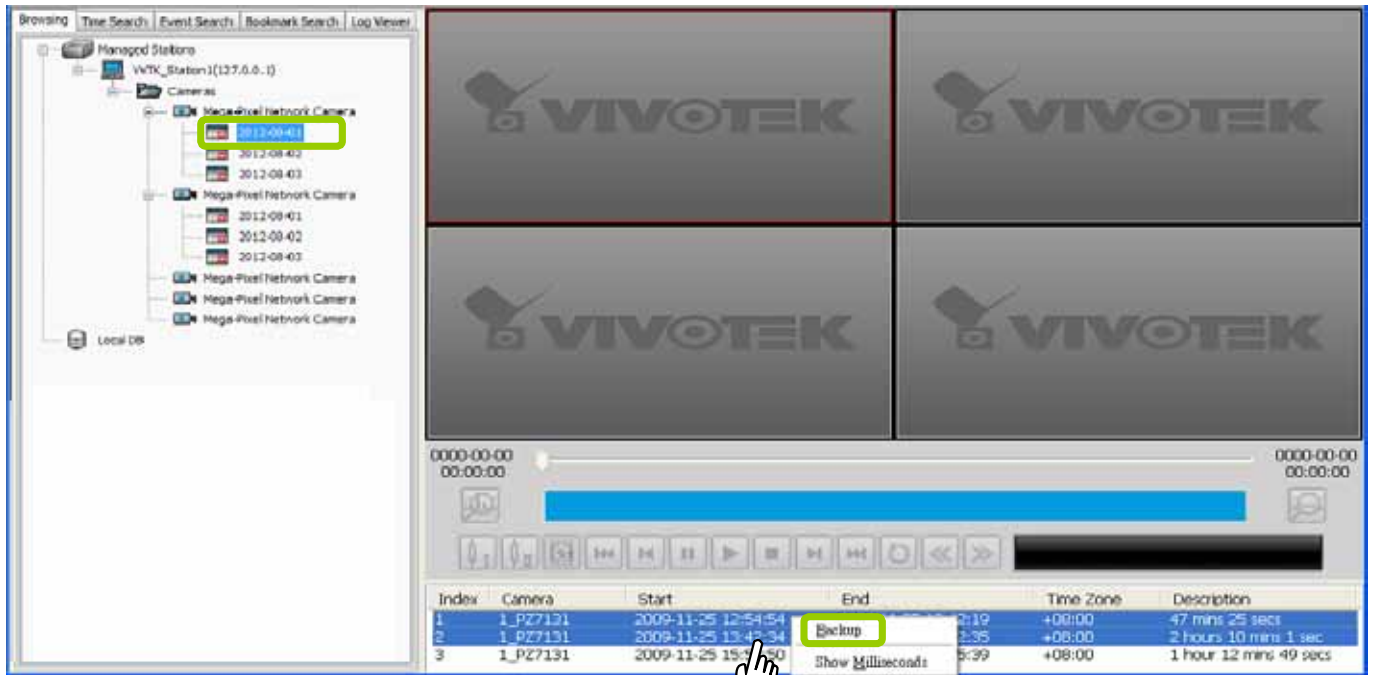

- b. A **Backup Settings** window will pop up. Specify the time span and select a storage path (if you have a NAS or eSATA storage attached), then click **Backup**. The system will start to backup and popup a window showing the backup status.

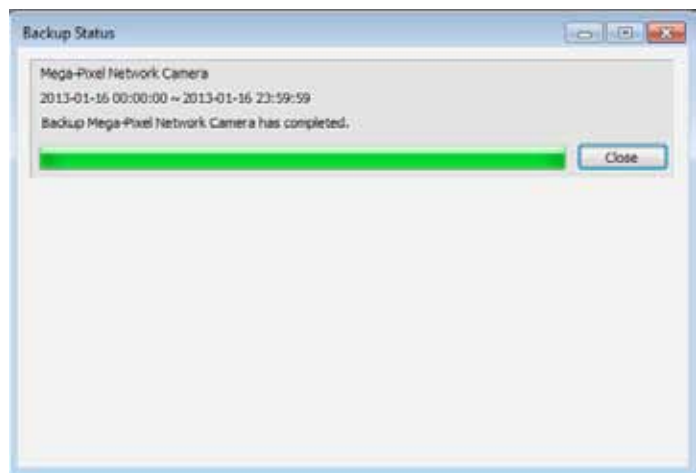
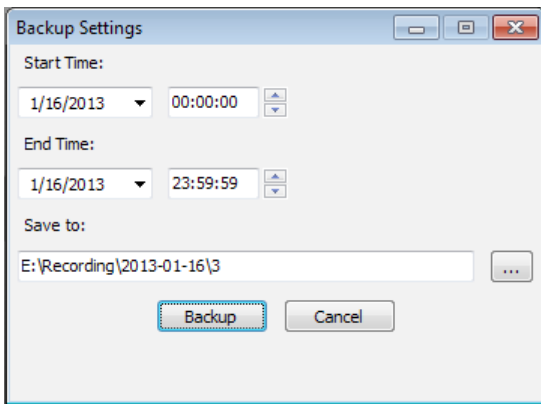

If you close the status window, you can also open it again by clicking **View > Backup Status**.

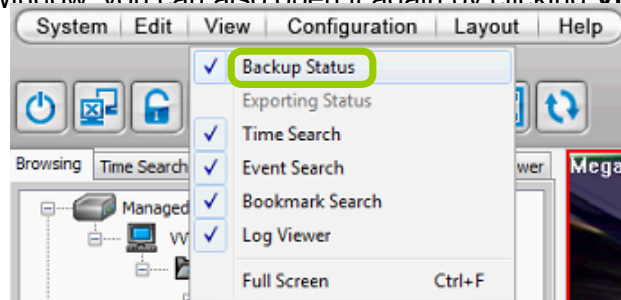

- d. When the backup is complete, you will see an information dialog. The recorded data will be restored in the specific folder.

How to View Backup Files

The VAST Playback also allows users to playback backup files, including **Schedule Backup** by VAST LiveClient and **Recorded Data Backup** by VAST Playback.

Please follow the steps below to view backup files:

- a. **Right-click** Local DB and click **Add**.
- b. A **Load Backup File** window will pop up as shown below. Select the ***.dif** file to upload.

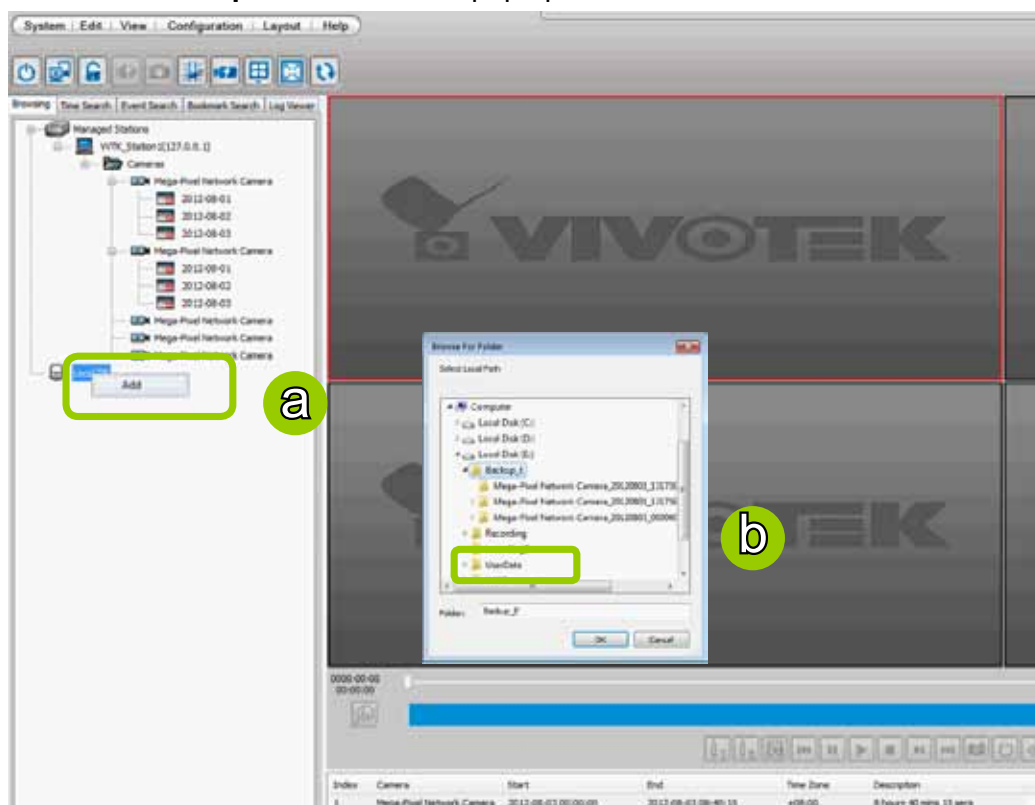

- c. The following is an example of uploaded file, and you can **double-click** it or **drag-and-drop** it to a video cell to playback.

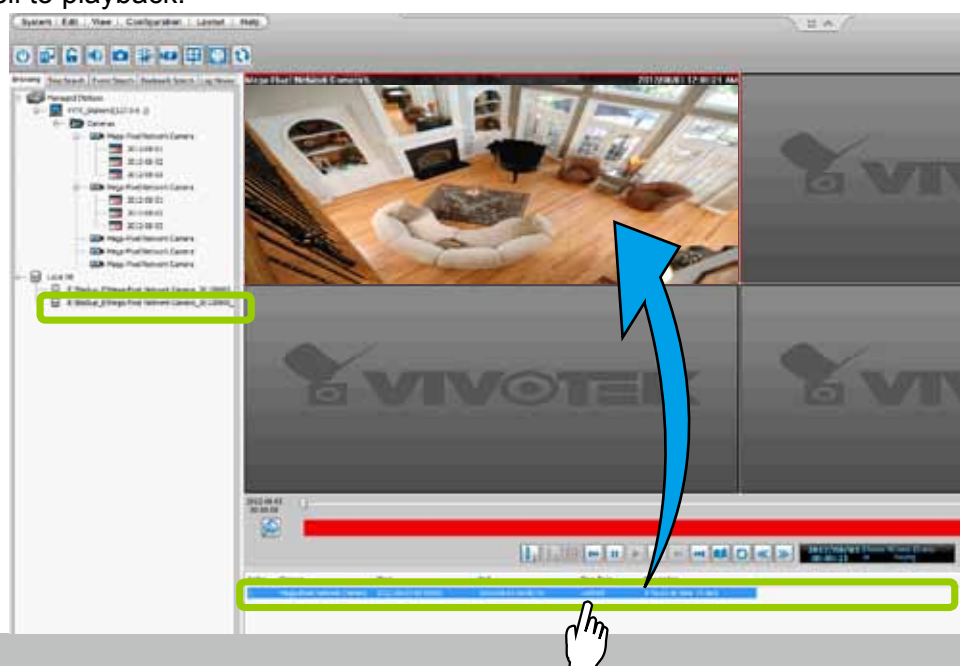

 **NOTE:**

1. The Backup function **does not** take place between the NVR system and a PC running the Playback utility.
2. If you want to playback the backup files from the local database, you can also click **Working Offline** in the Login Window without the account information. The VAST Playback will launch as shown below.

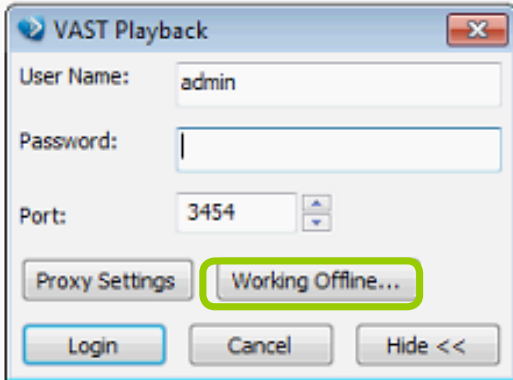

No user account information required



You can upload backup files

Model-specific Functions (FE Series Fisheye)

The VAST Playback program offers model-specific functions through a right-click menu. For example, if you playback a video clip made from an FE8171V or FE8172 series fisheye camera, a right-click on the playback screen will bring up the Display mode options. You can even exert mouse control while playing a recorded video. You can zoom in, zoom out, and change the view angle as if you are investigating a 3D scenario kept in a recorded point in time.

Note that ePTZ functions via the mouse control only takes place in a Regional view, e.g., the 1R or 1O3R mode.

The **Display mode** options and **mouse control** methodologies are identical to those described on page 53 and the following pages.

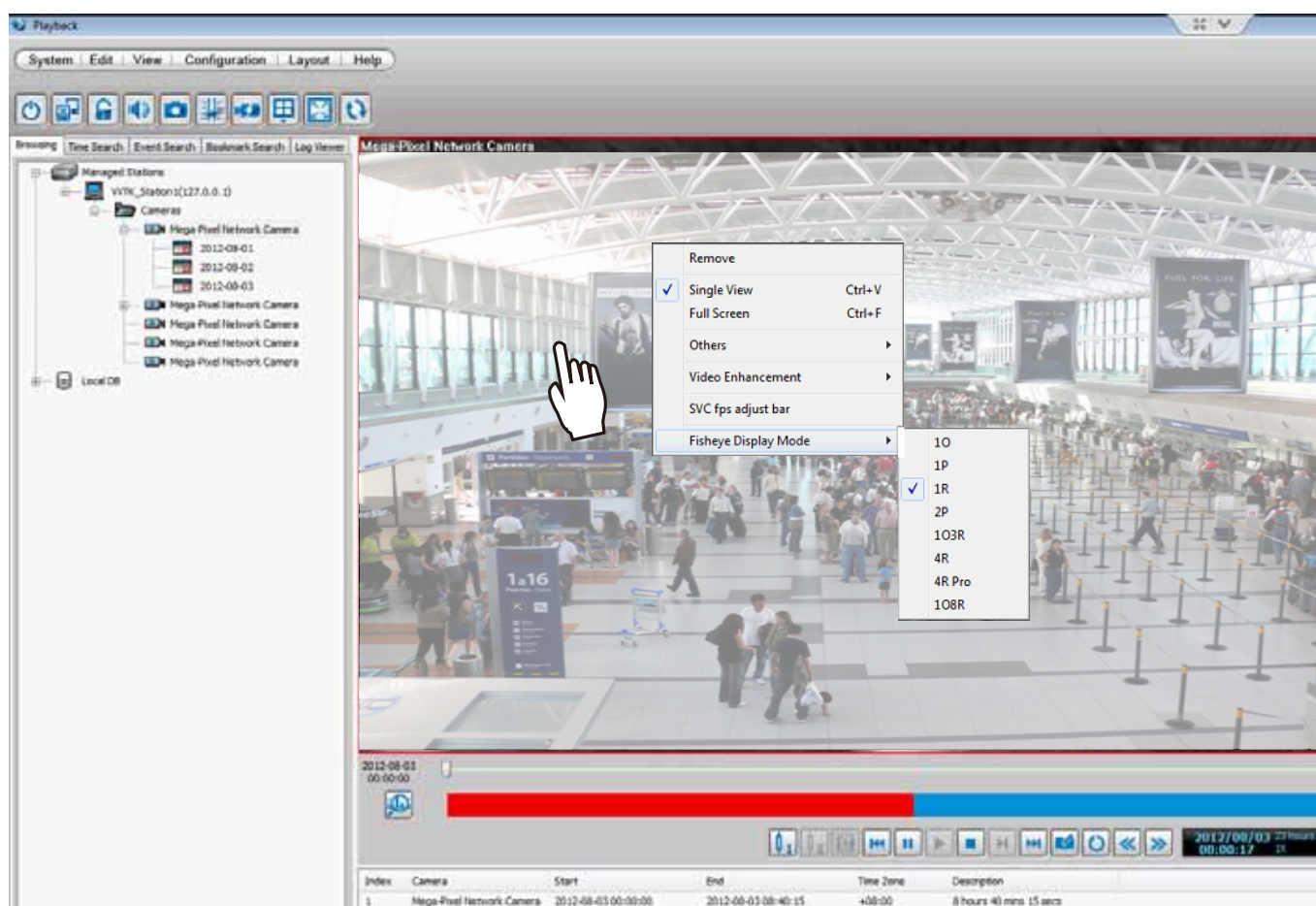

To configure the SVC-related feature:

1. Right-click on the playback window of an SVC-enabled camera. Select **SVC fps adjust bar**.

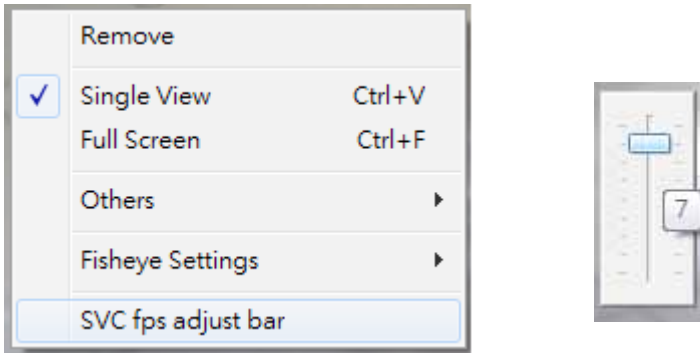

2. A slide bar will appear above the view cell. Click and drag the slide bar. A numeric indicator will display the current selection. See below for the frame rates represented by the numeric indicator. Please refer to page 40 for the introduction of this feature. Changing the SVC value takes immediate effect on the number of frames per second shown with the video being played.

Indicator	Frame rate per second (fps)
Maximum	30
7	26
6	22
5	18
4	12
3	8
2	4
1	1
Minimum	1/4

How to Search for a Video Clip Taken at a Specific Time

Please follow the steps below to use **Time Search** function:

a. Open the **Time Search** page.

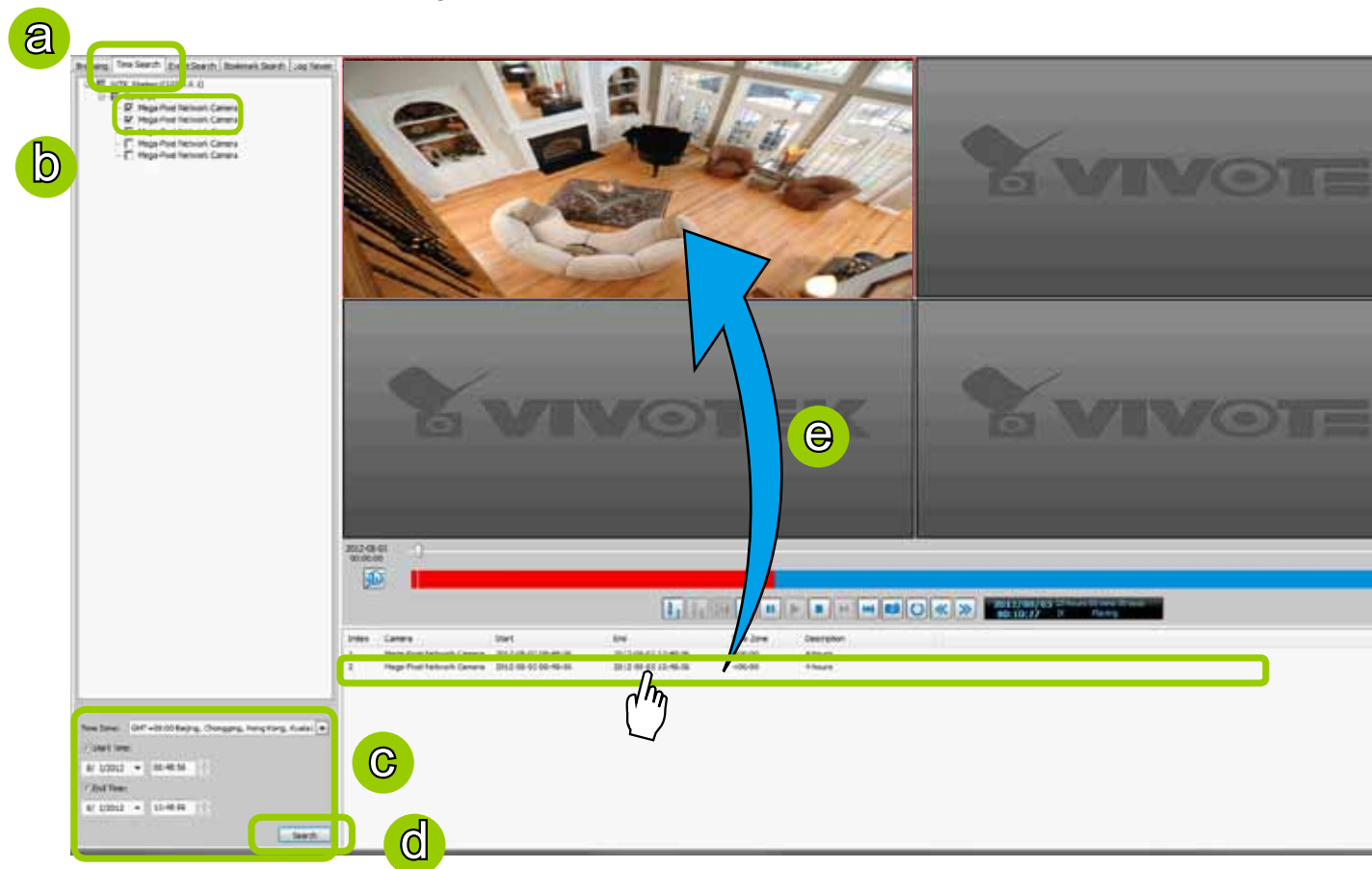

b. Select the target station(s)/device(s) that you want to search for video clips.

c. Specify the time span. You can choose to set up the start time only, the end time only, or both the start time and end time. The search results will only include the video clips within the time span. If you uncheck both the start time and end time, the search results will include all video clips recorded by the selected device(s).

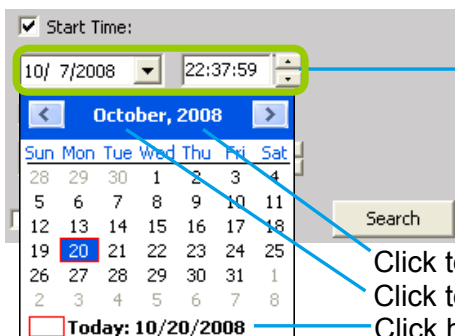

You can manually enter a specific time.

Click to select a year

Click to select a month from the drop-down list

Click here to move the focus to the current date

d. Click **Search** to start time search.

e. View the retrieved video clips.

How to Add a Bookmark

Bookmark is a convenient tagging function that allow your to pinpoint and extract a 20-second video clip from out of a video recording. When you see something of your interest while browsing through a recorded video,

1. Click on the  Bookmark button,
2. Enter a name for the bookmark, such as "thief spotted."
3. You may enter a short description in the Description field. You may also search for the bookmarks you created later on.

A bookmark comprises a video clip starting from 10 seconds of before and ends at 10 seconds after the point in time you selected.

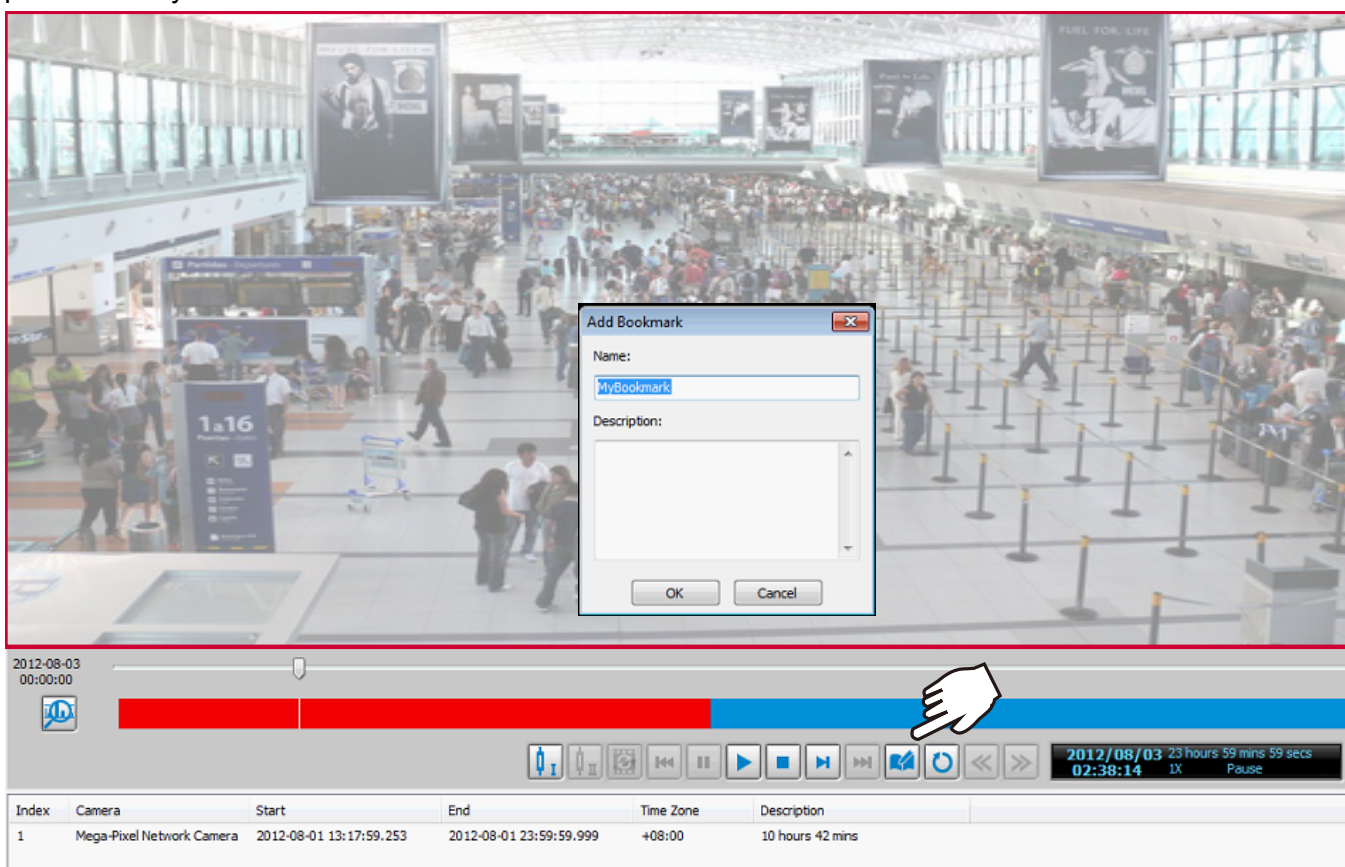

Index	Camera	Start	End	Time Zone	Description
1	Mega-Pixel Network Camera	2012-08-01 13:17:59.253	2012-08-01 23:59:59.999	+08:00	10 hours 42 mins

Please refer to page 177 for how to search for bookmarks.

How to Search for Events

The VAST Playback program offers users an intuitive event search engine for retrieving video clips from the database of recorded videos based on different search criteria such as motion, IVA, or DI events.

Please follow the steps below to search for recorded events:

a. Open the **Event Search** page.

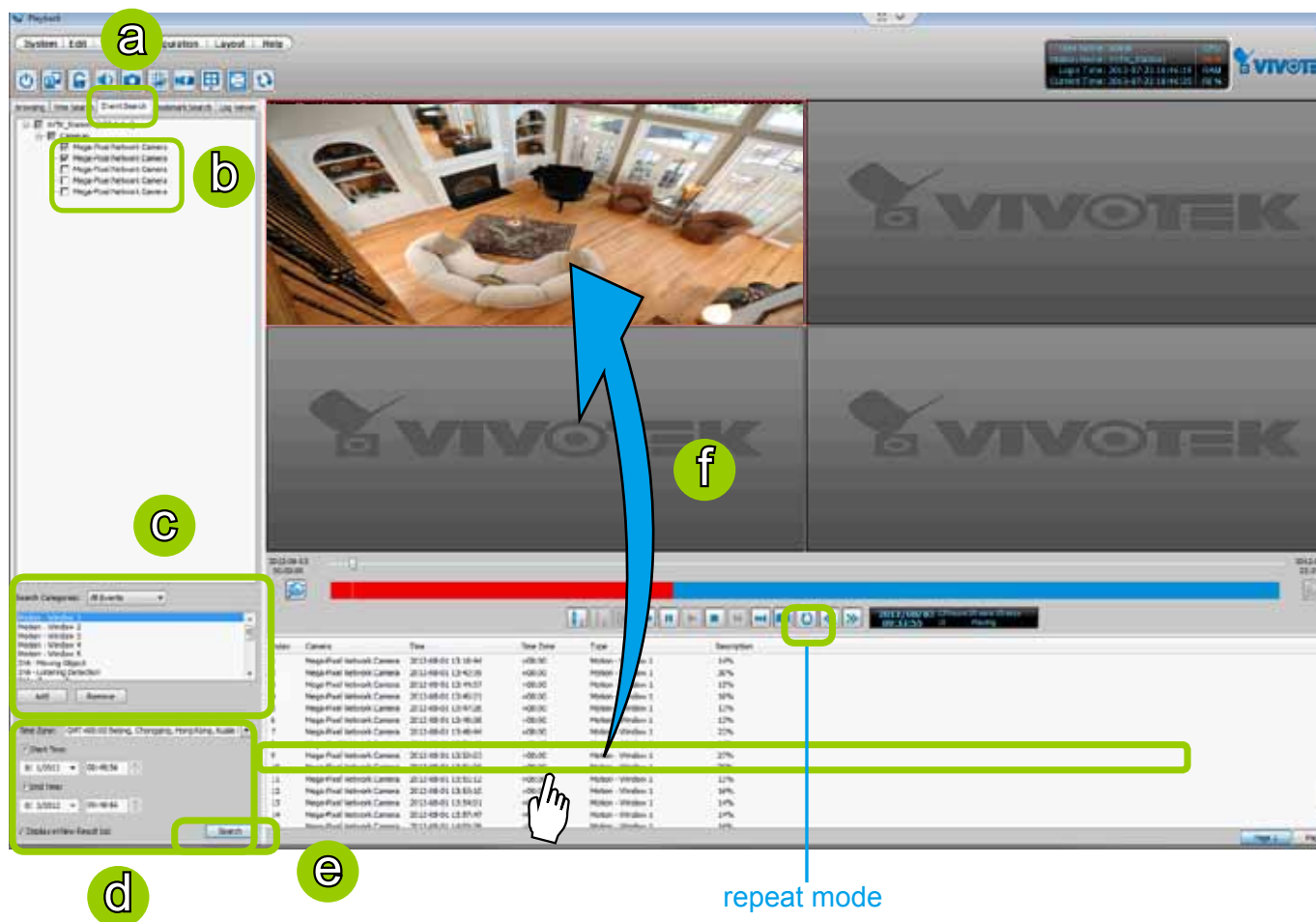

b. Select the target station(s)/device(s) that you want to search for events.

c. Specify the **Event Category**. For detailed information, please refer to **Select Event Category** on the following page.

d. Specify the time span for event search. You can choose to set up the start time only, the end time only, or both the start time and end time. The search results will only include the events within the time span. If you uncheck both the start time and end time, the search results will include all events from the selected device(s). Please refer to step c. on the previous page for detailed information.

e. Start event search. Please refer to page 175 for detailed information.

f. View the retrieved video clips. **Double-click** it or **drag-and-drop** it to the video cell. It will playback in repeat mode.

Note: The length of each video clip will depend on your settings of pre-event time & post-event time for the recording storage. The default setting is **20 seconds**. For more information, please refer to page 86 for detailed illustration.

Select Event Category

The following introduces the event search categories: **All Events**, **All Motion Events**, **All IVA events**, **All DI Events**, **Named DI Events**, **PIR**, **Tampering**, and **Temperature**. You can also add or remove customized events from the list.

Event Category- All Events

If you select the **All Events** category, all of the events including motion detection, digital input, and intelligent video analysis, PIR, tamper detection, and temperature alarm will be listed in the search results. You can click **Add** or **Remove** to change the search criteria options.

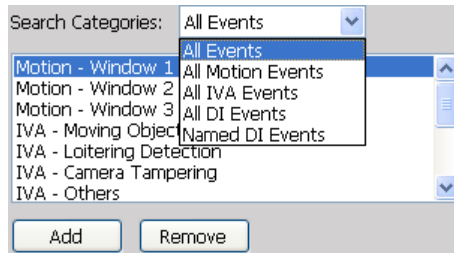

Event Category- All Motion Events

If you select the **All Motion Events** category, all detected motion events will be included in the search. You can click **Add** or **Remove** to change the search criteria options.

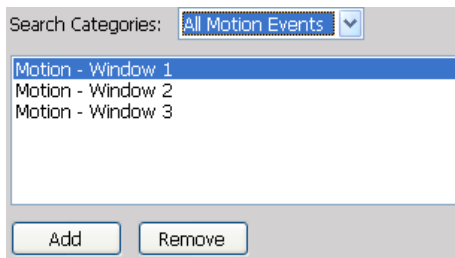

The parameters of the motion detection windows, such as motion percentage and the time of occurrence are also recorded in the database of the server. If you wish to change the parameters of the motion detection windows such as the position, size, detection sensibility, and motion percentage, please open a web console with the camera and make configuration change in the camera's Configuration page.

Enable motion detection



Event Category- All IVA events

If you select the **All IVA events** category, all detected IVA events will be included in the search. Cameras with embedded intelligent video content analysis are capable of detecting IVA events such as moving objects, loitering, and tamper detection.

The embedded video content analysis, superior to the conventional motion detection function, is capable of distinguishing between creature's motions, static backgrounds or natural movements such as swaying trees, waves or sunsets to prevent false alarms from environmental noises.

With camera tamper detection, it can detect incidents such as camera redirection, blocking or defocusing of cameras, or even spray-paint. Additionally, a suspicious object in the pre-defined detection region will trigger alarms once the dwell time of the object is longer than the given time.

You can click **Add** or **Remove** to change the search criteria items.

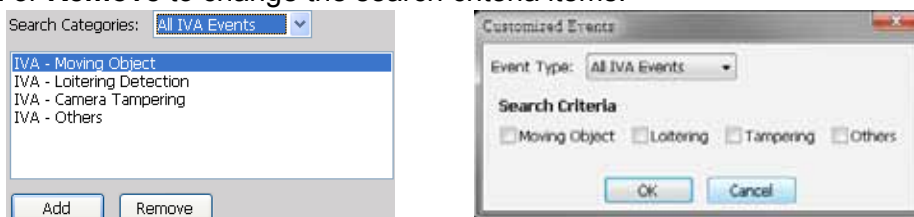

If you want to change the parameters of IVA, such as the detection region, loitering duration, etc, please link to the camera's Configuration page to modify the values.

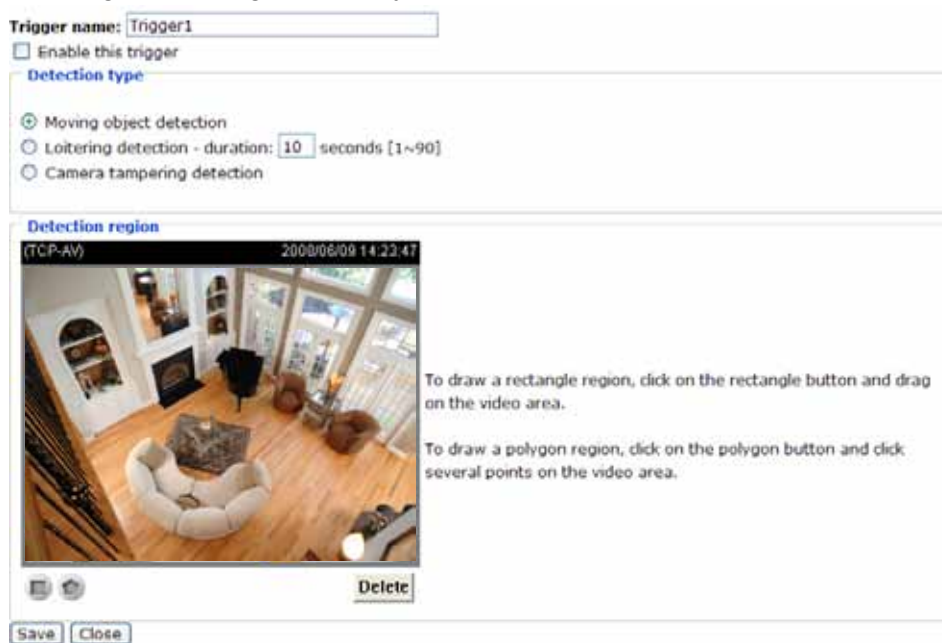

Event Category- All DI Events

If you select **All DI Events** category, all triggered DI signals will be included in the search. The DI events signify that there is a Digital-Input signal detected by the camera; its corresponding information such as DI-Trigger or DI-Normal signal and the time of occurrence are also transmitted and recorded in the database of the server.

You can click **Add** or **Remove** to change the search criteria options.

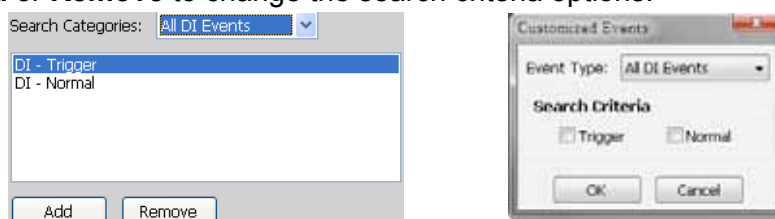

For more information about DI/DO settings on the connected devices, please refer to page 70 for detailed illustration.

Event Category- Named DI Events

This category allows you to select only **Named DI Events**--the DI device which you have renamed in the LiveClient. Please refer to Association Management on page 70 for more information about how to rename DI device.

Click **OK** and fill in the name you want to search on the left window.

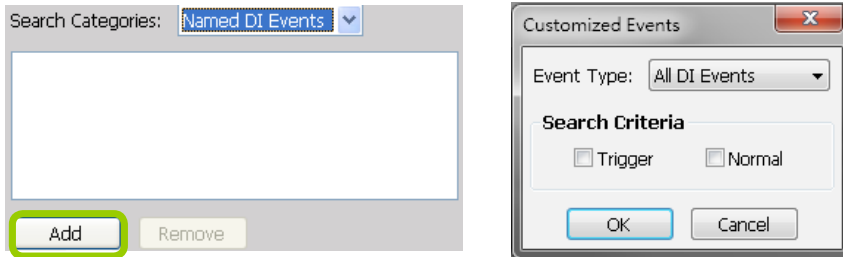

The new search criteria will be displayed in the search categories column as shown below. You can click **Add** or **Remove** to change the search criteria options.

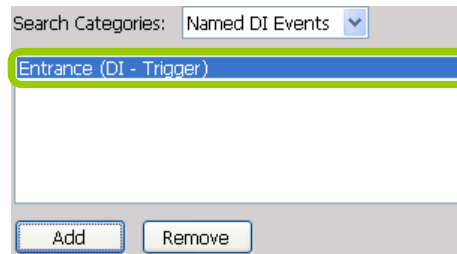

Start Event Search

After you specify all of the search criteria mentioned above, select or deselect the **Display in new result list** checkbox and click **Search** to begin event search.

- If **Display in new result list** is unchecked, all search results will be displayed on the original event list window as shown below.

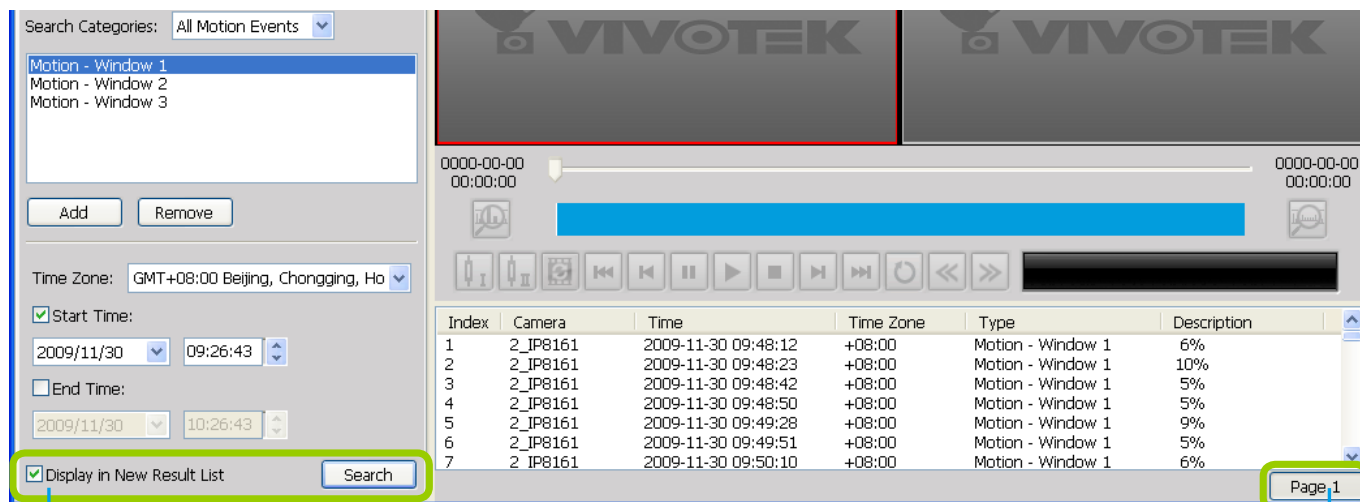

Deselected

Only one page

- In the above screen, The **Type** column in the search result page shows the event category, and the **Description** field displays the motion **percentage** of the detection window. Please refer to page 164 for more information about Motion Events.

- If you select **Display in new result list** and click **Search**, the search results will be displayed on a new page as shown below. This allows you to place the search results of each search category on an individual page. You can set up to 5 pages in the event list window.

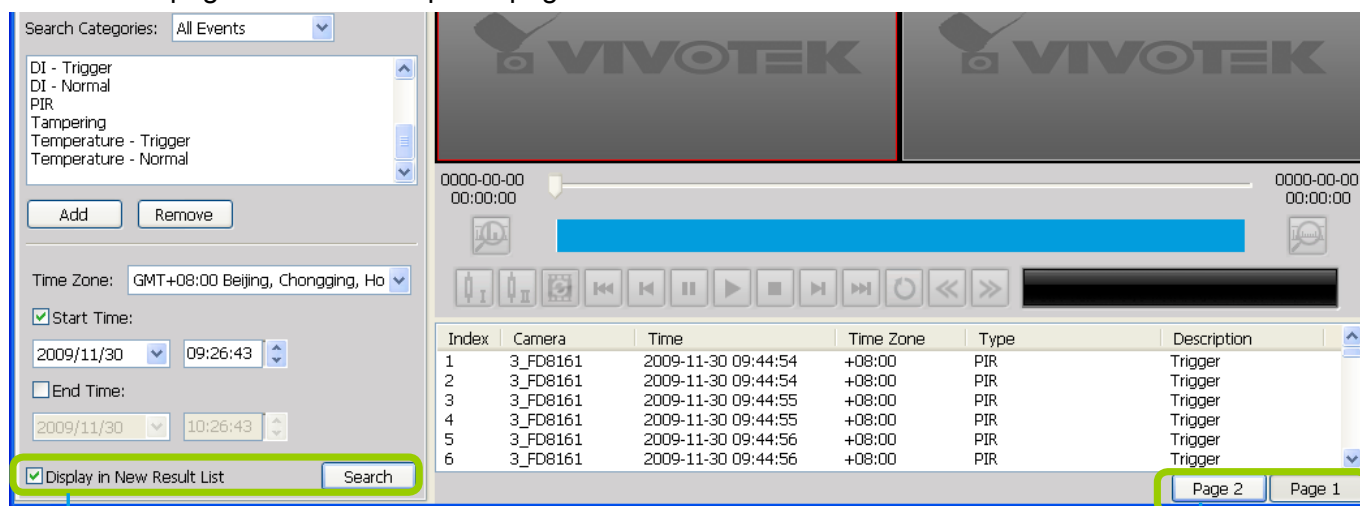

Selected

You can set up to 5 pages.

Backup the Event Videos

Please follow the steps below to backup the event videos on the results list:

- a. Select the video clips you want to backup. You can select more than one video clip using the Shift key.
- b. **Right-click** the selected video clips and click **Backup**.

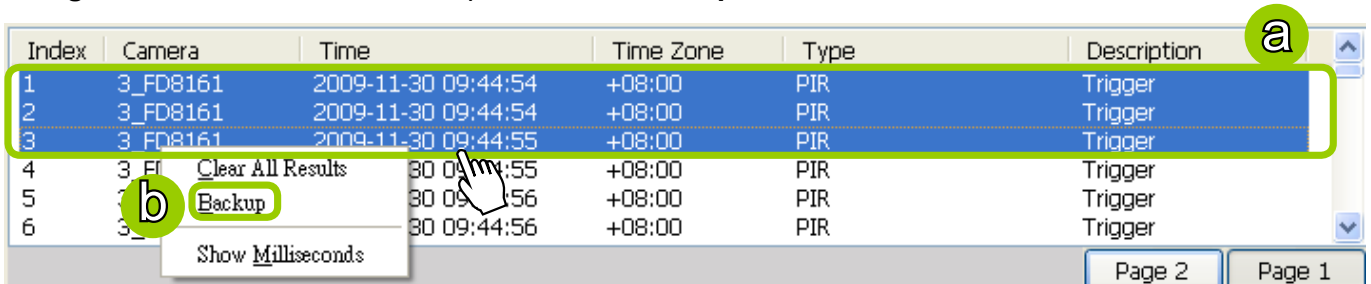

Index	Camera	Time	Time Zone	Type	Description
1	3_FD8161	2009-11-30 09:44:54	+08:00	PIR	Trigger
2	3_FD8161	2009-11-30 09:44:54	+08:00	PIR	Trigger
3	3_FD8161	2009-11-30 09:44:55	+08:00	PIR	Trigger
4	3_FD8161	2009-11-30 09:44:55	+08:00	PIR	Trigger
5	3_FD8161	2009-11-30 09:44:56	+08:00	PIR	Trigger
6	3_FD8161	2009-11-30 09:44:56	+08:00	PIR	Trigger

Context Menu:

- Clear All Results
- Backup
- Show Milliseconds

Page 2 Page 1

- c. A **Backup Settings** window will pop up. For more information about how to set up the Backup Settings, please refer to page 163. For more information about how to view backup files, please refer to page 165 for detailed illustration.



NOTE:

The backup function does not take effect on a Playback separately installed on a client PC. Namely, you can not backup videos on an NVR to a client PC.

How to Search for a Bookmark

Please follow the steps below to use **Bookmark Search** function:

- Click on the tabbed menu to open the **Bookmark Search** page.
- Select the cameras which have video clips you have placed bookmarks on.

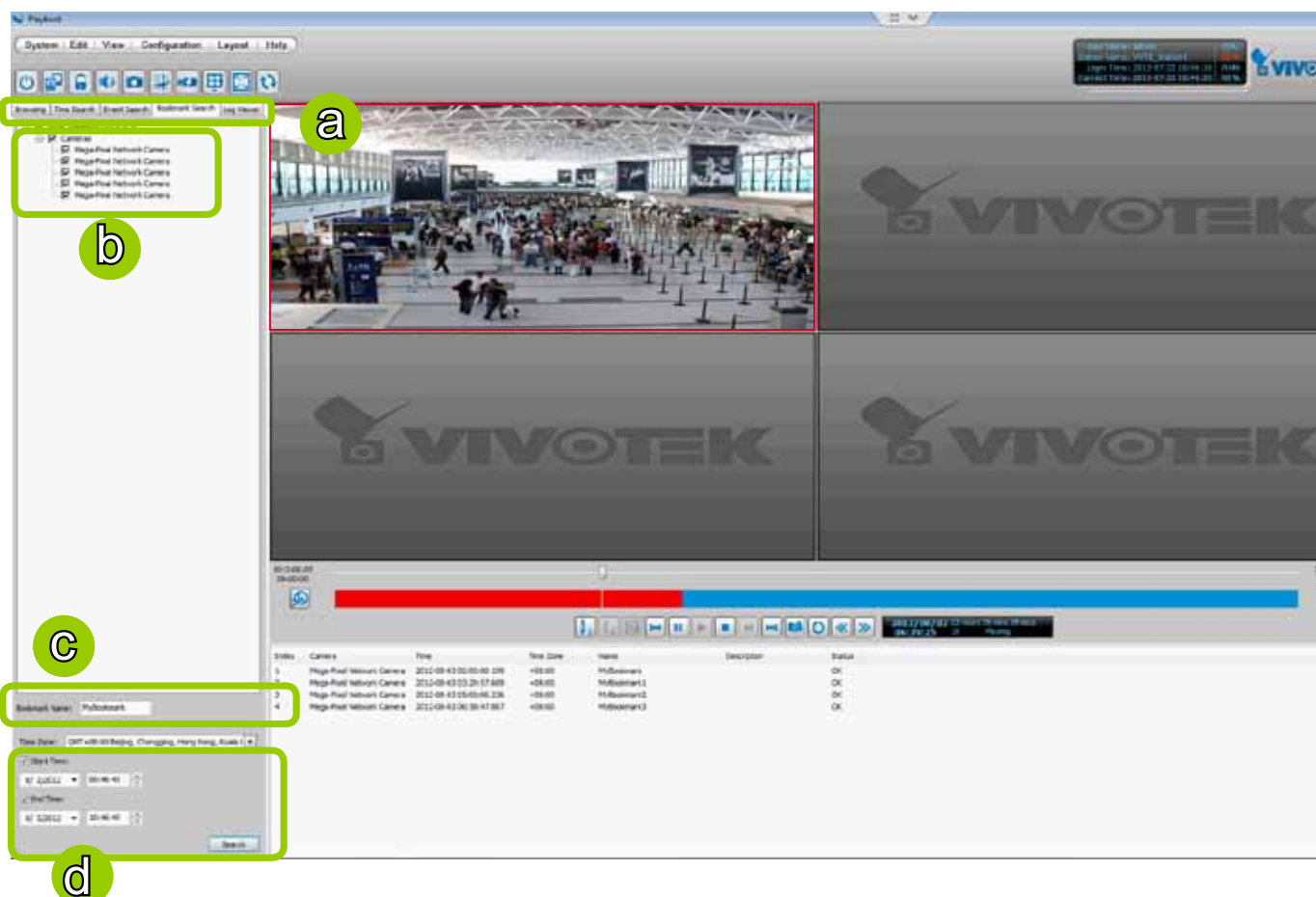

- Enter the name of bookmark.
- Specify a range of time during which the video streams were recorded and its points in time were bookmarked.

Click **search**. You can then click on a bookmark to display the short video clip extracted from within the recorded video.

To remove an existing bookmark, left-click to select an entry, and then right-click to display the Delete button. Bookmarks will be indicated as "Invalid" if the videos where the bookmarks were appended were erased, e.g., when the original recording was erased by cyclic recording.

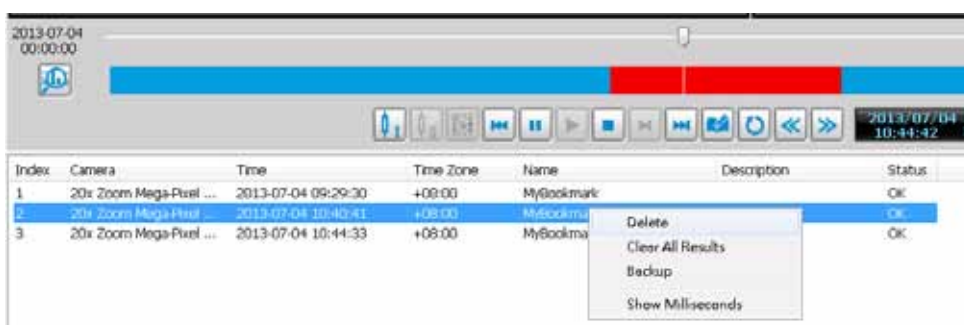

How to Search Logs

The VAST Playback program offers a convenient log engine for searching all local logs based on different search criteria such as log category, log type, and log level. The search results will be displayed in the log viewer window along with the detailed log history.

Please follow the steps below to search logs:

- Open the **Log Viewer** page.
- Select the target station where you want to search logs.
- Specify the **Log Category**. For detailed information, please refer to **Select Log Category** on page 179.
- Specify the **User Account**. If you have added other user accounts to the station, you can select one to search its login history. For detailed information about user account, please refer to **How to Manage User Accounts** on page 65.
- Specify the **Search Result**. Select **All** to display all search results; select **Success** to display successful log activities only; select **Fail** to display failed log activities only.
- Specify the **Log Type**. For detailed information, please refer to **Select Log Type** on page 179.
- Specify the **Log Level**. For detailed information, please refer to **Select Log Level** on page 179.
- Specify the search time span. You can check the start time only, the end time only, or both the start time and end time. The search will only include the events within the time span. If you uncheck both the start time and end time, the search will include all events saved by the server. Please refer to page 169 for detailed information.
- Start the log search and the results will be displayed on the log list window.

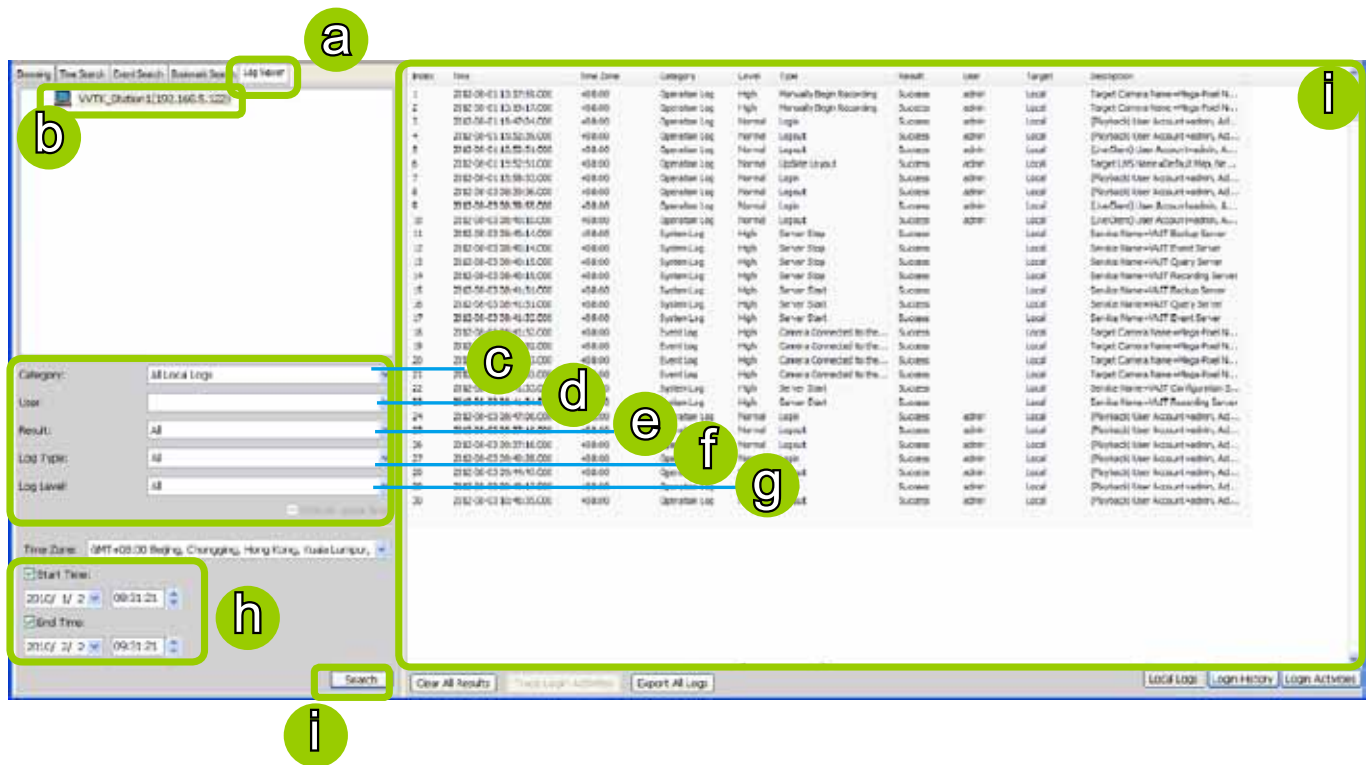

Select Log Category/Log Type/Log Level

The following table shows the breakdown of log category, level, and type. The search results will be different according to your selections.

Log Categories	Log Levels	Log Types
Operation Log	Normal	Login / Logout Insert User Update User Name Update User Password Update User Privilege Delete User Insert Camera Update Camera Information Delete Camera Set Storage Group Insert Recording Schedule / Update Recording Schedule / Delete Recording Schedule Insert Event Management / Update Event Management / Delete Event Management Insert Storage Group / Update Storage Group / Delete Storage Group Insert Recording Path / Update Recording Path / Delete Recording Path Insert Camera to the Storage Group Update Camera information in the Storage Group Delete Camera from the Storage Group Move Recording Path Move Camera to another Storage Group Insert Layout / Update Layout / Delete Layout Set Digital Output Update Scheduled Backup Update Server Port Set Proxy Server Set UPNP Set DDNS Server Create Directory / Rename Directory / Delete Directory Insert SMTP Server / Update SMTP Server / Delete SMTP Server Insert Network Storage Device / Update Network Storage Device / Delete Network Storage Device Set GSM Modem Set DI/DO Rename Set Relay Settings Update Web Access Information
	High	Manually Begin Recording Manually Stop Recording
System Log	High	Server Start / Server Stop Virtual Memory Low Network Lost

Log Categories	Log Levels	Log Types
Event Log	High	Camera Disconnected from the Server / Camera Connected to the Server Camera Recording Start / Camera Recording Stop Start Scheduled Backup / Stop Scheduled Backup Event Trigger

Search All Local Logs

Log Category
Log Level
Log Type

Index	Time	Time Zone	Category	Level	Type	Result	User	Target	Description
1	2012-08-01 13:17:59.000	+08:00	Operator Log	High	Manually Begin Recording	Success	admin	local	Target Camera Name=Hoge-Food N...
2	2012-08-01 13:19:17.000	+08:00	Operator Log	High	Manually Begin Recording	Success	admin	local	Target Camera Name=Hoge-Food N...
3	2012-08-01 13:47:04.000	+08:00	Operator Log	Normal	Login	Success	admin	local	(Playback) User Account=admin, Ad...
4	2012-08-01 13:52:38.000	+08:00	Operator Log	Normal	Logout	Success	admin	local	(Playback) User Account=admin, Ad...
5	2012-08-01 13:52:51.000	+08:00	Operator Log	Normal	Logout	Success	admin	local	(LiveClient) User Account=admin, A...
6	2012-08-01 13:53:31.000	+08:00	Operator Log	Normal	Update Lensset	Success	admin	local	Target URL Name=LiveAuth Map, In...
7	2012-08-01 13:56:33.000	+08:00	Operator Log	Normal	Login	Success	admin	local	(Playback) User Account=admin, Ad...
8	2012-08-01 13:56:36.000	+08:00	Operator Log	Normal	Logout	Success	admin	local	(Playback) User Account=admin, Ad...
9	2012-08-01 13:56:55.000	+08:00	Operator Log	Normal	Login	Success	admin	local	(LiveClient) User Account=admin, A...
10	2012-08-01 13:56:30.000	+08:00	Operator Log	Normal	Logout	Success	admin	local	(LiveClient) User Account=admin, A...
11	2012-08-01 13:56:40:14.000	+08:00	System Log	High	Server Stop	Success		local	Service Name=VAST Backup Server
12	2012-08-01 13:56:40:14.000	+08:00	System Log	High	Server Stop	Success		local	Service Name=VAST Event Server
13	2012-08-01 13:56:40:13.000	+08:00	System Log	High	Server Stop	Success		local	Service Name=VAST Query Server
14	2012-08-01 13:56:40:13.000	+08:00	System Log	High	Server Stop	Success		local	Service Name=VAST Recording Server
15	2012-08-01 13:56:40:31.000	+08:00	System Log	High	Server Start	Success		local	Service Name=VAST Backup Server
16	2012-08-01 13:56:40:31.000	+08:00	System Log	High	Server Start	Success		local	Service Name=VAST Query Server
17	2012-08-01 13:56:40:32.000	+08:00	System Log	High	Server Start	Success		local	Service Name=VAST Event Server
18	2012-08-01 13:56:40:32.000	+08:00	System Log	High	Server Start	Success		local	Service Name=VAST Recording Server
19	2012-08-01 13:56:40:32.000	+08:00	Event Log	High	Camera Connected to the...	Success		local	Target Camera Name=Hoge-Food N...
20	2012-08-01 13:56:40:33.000	+08:00	Event Log	High	Camera Connected to the...	Success		local	Target Camera Name=Hoge-Food N...
21	2012-08-01 13:56:40:33.000	+08:00	Event Log	High	Camera Connected to the...	Success		local	Target Camera Name=Hoge-Food N...
22	2012-08-01 13:56:40:32.000	+08:00	System Log	High	Server Start	Success		local	Service Name=VAST Configuration S...
23	2012-08-01 13:56:40:34.000	+08:00	System Log	High	Server Start	Success		local	Service Name=VAST Recording Server
24	2012-08-01 13:57:08.000	+08:00	Operator Log	Normal	Login	Success	admin	local	(Playback) User Account=admin, Ad...
25	2012-08-01 13:57:33.000	+08:00	Operator Log	Normal	Logout	Success	admin	local	(Playback) User Account=admin, Ad...
26	2012-08-01 13:57:36.000	+08:00	Operator Log	Normal	Logout	Success	admin	local	(Playback) User Account=admin, Ad...
27	2012-08-01 13:56:40:38.000	+08:00	Operator Log	Normal	Login	Success	admin	local	(Playback) User Account=admin, Ad...
28	2012-08-01 13:56:47.000	+08:00	Operator Log	Normal	Logout	Success	admin	local	(Playback) User Account=admin, Ad...
29	2012-08-01 13:56:47.000	+08:00	Operator Log	Normal	Login	Success	admin	local	(Playback) User Account=admin, Ad...
30	2012-08-01 13:56:35.000	+08:00	Operator Log	Normal	Logout	Success	admin	local	(Playback) User Account=admin, Ad...

Clear All Results Export All Logs Local Logs Login History Login Activities

Click to export all search results from the list
Click to remove all search results from the list

Search Login History

Select **Login History** from the log category field and click the **Search** button below, the search results, including all login logs, will be displayed on the Login History page.

Browsing Time Search Event Search Bookmark Search Log View

VVTK_Station1(192.168.5.122)

Category: Login History

User: []

Result: All

Log Type: []

Log Level: []

Time Zone: GMT+08:00 Beijing, Chongqing, Hong Kong

Start Time: 2010/ 2/ 1 09:31:21

End Time: 2010/ 2/ 2 09:31:21

Search Clear All Results Trace Login Activities Export All Logs Local Logs Login History Login Activities

Index	User	Login Time	Login Result	Logout Time	Logout Result	Time Zone	Description
1	STAdmin	2010-02-01 09:41:30	Success	2010-02-01 11:48:52	Success	+08:00	Playback
2	STAdmin	2010-02-01 11:05:53	Success	2010-02-01 20:16:21	Success	+08:00	LiveClient
3	STAdmin	2010-02-01 11:48:55	Success	2010-02-01 20:16:15	Success	+08:00	Playback
4	STAdmin	2010-02-02 09:31:04	Success			+08:00	LiveClient

Search Login Activities

This function allows you to search the operations the user performed during the login period of time. You can search for login activities on the Local Logs or Login History page.

- Search Login Activities on the Local Logs page:
 - a. Click on the **Local Logs** page.
 - b. Select a login/logout option from the list.
 - c. Click **Trace Login Activities** (or you can **right-click** the selected login/logout option on the list, then click **Trace Login Activities**).

Index	Time	Time Zone	Category	Level	Type	Result	User	Target	Description
1	2012-07-18 10:56:05	+08:00	System Log	High	Server Start	Success		Local	Service Name=VAST Recording ...
2	2012-07-18 10:56:05	+08:00	System Log	High	Server Start	Success		Local	Service Name=VAST Query Ser...
3	2012-07-18 10:56:16	+08:00	System Log	High	Server Start	Success		Local	Service Name=VAST Backup Se...
4	2012-07-18 10:56:18	+08:00	System Log	High	Server Start	Success		Local	Service Name=VAST Event Ser...
5	2012-07-18 10:56:21	+08:00	System Log	High	Server Start	Success		Local	Service Name=VAST Configurati...
6	2010-01-18 11:26:30	+08:00	Operation Log	Normal	Login	Success		Local	(LiveClient) User Account=STA...
7	2012-07-18 13:11:22	+08:00	Operation Log	Normal	Clear All Results	Success		Local	(Playback) User Account=STAd...
8	2012-07-18 16:14:24	+08:00	Event Log	Normal	Camera	Success		Local	Target Camera Name=1_IP6330
9	2012-07-18 16:14:25	+08:00	Operation Log	Normal	Insert	Success		Local	New Camera Name=1_IP6330, ...
10	2012-07-18 16:14:25	+08:00	Event Log	Normal	Camera	Success		Local	Target Camera Name=1_IP6330
11	2012-07-18 16:14:27	+08:00	Event Log	High	Camera	Success		Local	Target Camera Name=1_IP633...
12	2012-07-18 19:58:22	+08:00	Operation Log	Normal	Logout	Success		Local	(Playback) User Account=STAd...
13	2012-07-18 19:58:41	+08:00	Operation Log	Normal	Update Layout	Success		Local	Target LMS Name=Default Map,...
14	2012-07-18 19:58:41	+08:00	Operation Log	Normal	Logout	Success		Local	(LiveClient) User Account=STA...
15	2012-07-18 19:59:12	+08:00	Operation Log	Normal	Login	Success		Local	(LiveClient) User Account=STA...
16	2012-07-18 20:07:24	+08:00	Operation Log	Normal	Logout	Success		Local	(LiveClient) User Account=STA...
17	2012-07-19 09:33:42	+08:00	System Log	High	Server Start	Success		Local	Service Name=VAST Query Ser...

- d. The search results of the login activities will be displayed on the Login Activities page as shown below.

Index	Time	Time Zone	Category	Level	Type	Result	User	Target	Description
1	2012-07-18 11:26:30	+08:00	Operation Log	Normal	Login	Success	Admin	Local	(LiveClient) User Account=STA...
2	2012-07-18 16:14:25	+08:00	Operation Log	Normal	Insert Camera	Success	Admin	Local	New Camera Name=1_IP6330, ...
3	2012-07-18 19:58:41	+08:00	Operation Log	Normal	Update Layout	Success	Admin	Local	Target LMS Name=Default Map,...
4	2012-07-18 19:58:41	+08:00	Operation Log	Normal	Logout	Success	Admin	Local	(LiveClient) User Account=STA...

- Search Login Activities on the Login History page:
 - a. Click on the **Login History** page.
 - b. Select a login/logout option from the list.
 - c. Click **Trace Login Activities** (or you can **right-click** the selected login/logout item on the list and click **Trace Login Activities**).

Index	User	Login Time	Login Result	Logout Time	Logout Result	Time Zone	Description
1	Admin	2012-02-01 09:41:38	Success	2012-08-01 11:48:52	Success	+08:00	Playback
2	Admin	2012-07-01 11:05:53	Success	2012-07-01 11:16:21	Success	+08:00	LiveClient
3	Admin	2012-07-01 11:48:55	Success	2012-07-01 11:48:55	Success	+08:00	Playback
4	Admin	2012-07-02 09:31:04	Success			+08:00	LiveClient

d. The search results of the login activities will be displayed on the Login Activities page as shown below.

Index	Time	Time Zone	Category	Level	Type	Result	User	Target	Description
1	2012-08-01 11:05:53	+08:00	Operation Log	Normal	Login	Success	Admin	Local	(LiveClient) User Account=STA...
2	2012-08-01 20:16:21	+08:00	Operation Log	Normal	Logout	Success	Admin	Local	(LiveClient) User Account=STA...

 **NOTE:**

When you select **All** in the **Log Level** field, the search results will include all log levels. If you select **Low** in the **Log Level** field and select **Including above level** as shown in the picture below, the search results will include all levels of logs. However, if you select **Normal** in the **Log Level** field and select **Including above level** as shown in the picture on the right below, the search results will only include **Normal-level** and **High-level** logs.

Log Level: Including above level

Log Level: Including above level

How to Configure Client Settings

On Client Settings, you can configure Snapshot Settings, Export Settings, View Settings, Proxy Settings, and General Settings. It allows you to save snapshots and media files on the local computer.

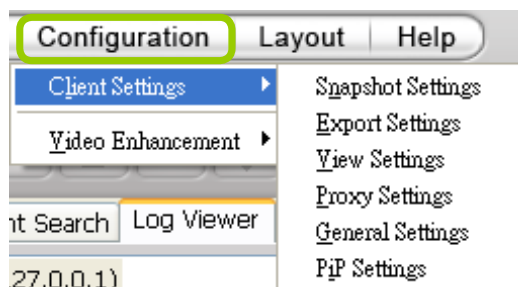

Snapshot Settings



When you play a recorded video, VAST Playback also allows you to take snapshots. For detailed information about **Snapshot Settings**, please refer to page 124.

Export Settings

When you playback a recorded video, the VAST server allows you to export part of the recorded video in EXE, 3GP, or AVI format to your local computer. Before exporting a media file, please set up Export Settings first. For detailed information about how to set up EXE, 3GP, and AVI **Export Settings**, please refer to Record Settings on page 126.

Export an EXE/3GP/AVI File

Please follow the steps below to convert part of an EXE/3GP/AVI file of recorded video:

- Playback a video clip from which you want to export a media file.
- Set a period of time. Move the timeline slider bar to the desired start time and click Marker I . Move the timeline slider bar to the desired end time and click Marker II .

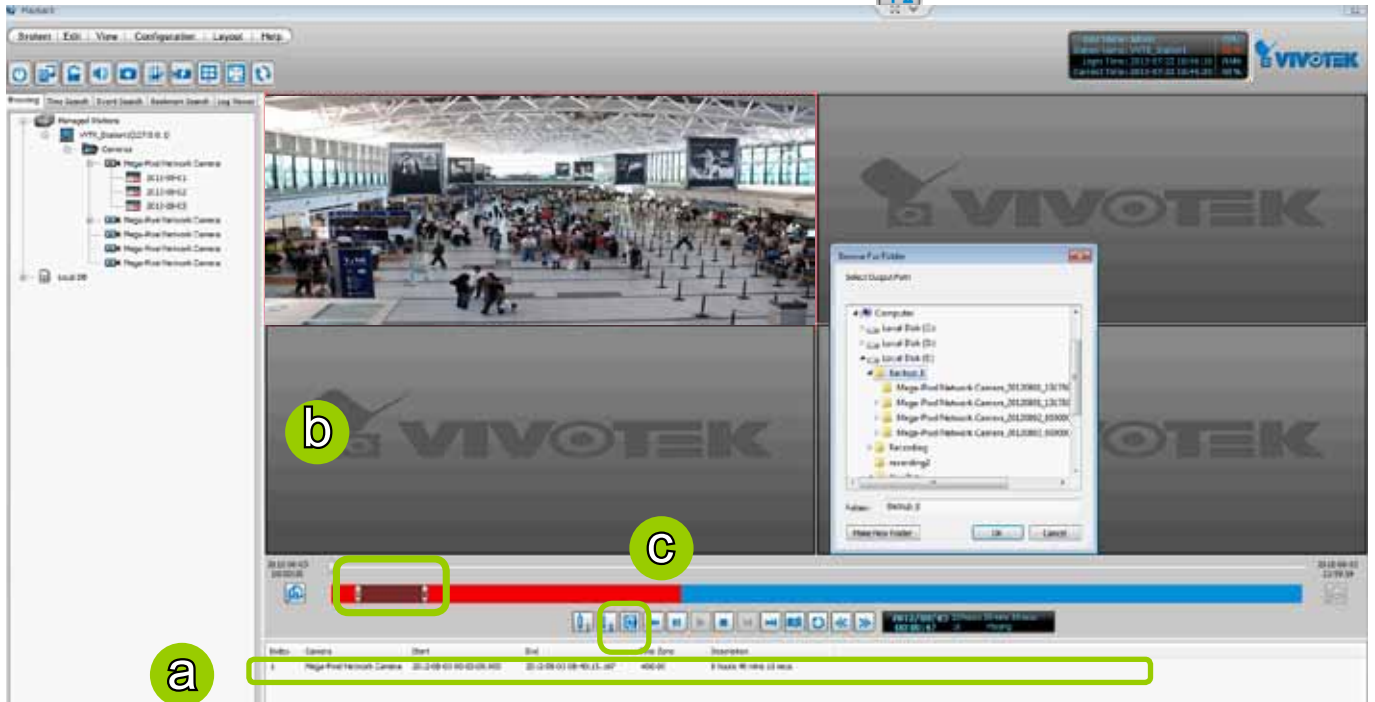

- Click Export EXE/3GP/AVI , the server will start to export the data and popup a window showing the exporting status. If you close the status window, you can also open it again by clicking **View > Exporting Status**.
- When the backup is complete, you will see an information dialog. The exported data will be restored in the preset storage folder on your local computer (C:\Program Files\VIVOTEK Inc\VAST\Client\Playback\Export).

Note that the local computer has a Playback instance that is separately installed. If you are running Playback on the NVR, you can backup to the local disks or USB devices.

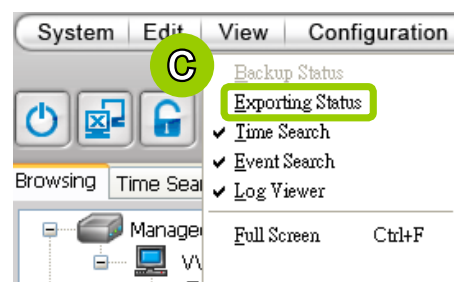
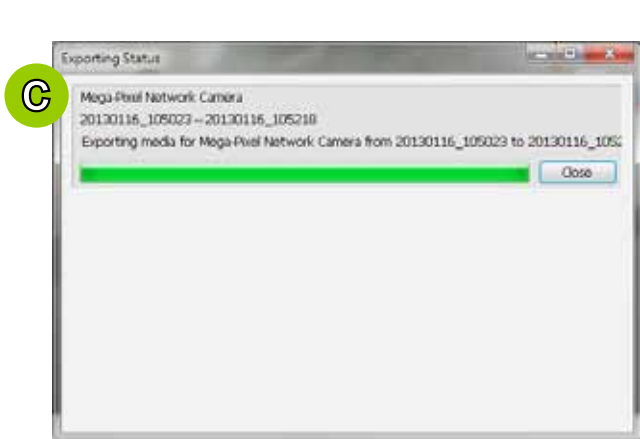

View Settings

This section allows you to set up the display mode of video cell. For detailed information about **View Settings**, please refer to page 132.

Proxy Settings

Please refer to page 142 for detailed illustration.

General Settings

System Settings

Please refer to page 134 for detailed information.

Display Settings

- Enable de-interlace function: Select this option if your connected device does not support de-interlace function. For example: VS7100.

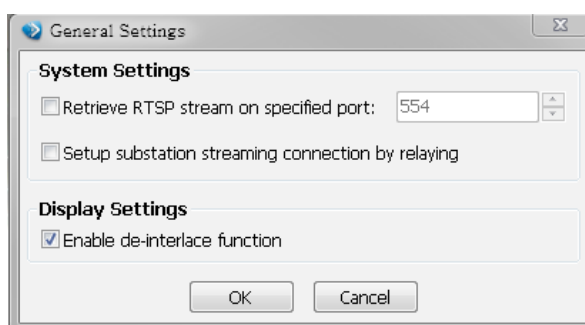

How to Configure Video Enhancement





The Playback also allows you to enable post-image enhancement and defog for video viewing. Please refer to page 145 for detailed information.

How to Search for a Device on the Hierarchical Management Tree

The Playback also allows you to conveniently search for an inserted device. Please refer to page 150 for detailed information.

How to Lock VAST Playback for Security Concerns

If you happen to be away from your computer, for security reasons, we suggest you lock the program. When VAST Playback is locked, the user must enter the correct password to unlock and access the program again.

- To lock Playback, click **Unlock**  on the quick access bar or click **System > Lock** on the system menu. The **Unlock**  icon will then turn into **Lock** .
- To unlock Playback, click  and enter the correct password in the popup window.

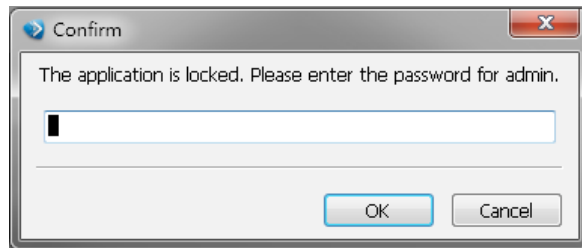
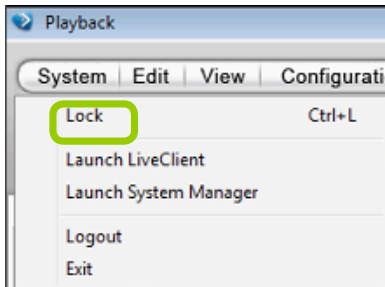

How to Log out from the VAST Server

To log out from the current server, click the station and click **Logout**  on the quick access bar or click **System > Logout** on the menu bar. You can also **right-click** the station and click **Logout**. A confirmation window will pop up. Click **OK** to confirm or **Cancel** to return to the VAST Playback window.

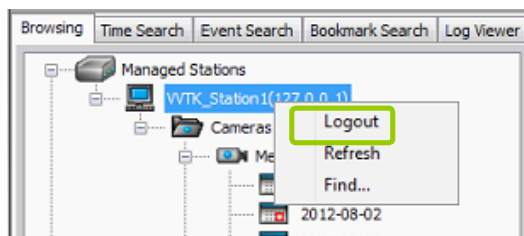
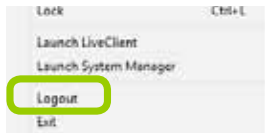





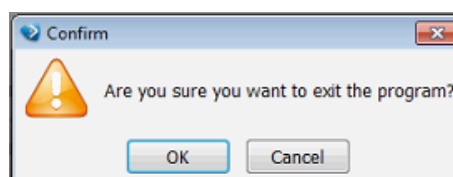
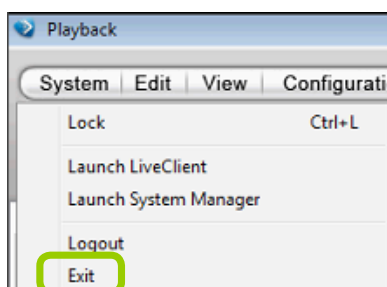



How to Exit VAST Playback

To exit VAST Playback, click **Exit**  on the quick access bar or click **System > Exit** on the menu bar. A confirmation window will pop up. Click **OK** to confirm or **Cancel** to return to the VAST Playback window. When you exit the program, your user account will be automatically logged out from the current server.



Chapter Four Auxiliary Utilities

In addition to LiveClient and Playback, the NVR system comes with a variety of auxiliary utilities including:

	Utility	Description
	Setup Wizard	The Setup Wizard has been described in Chapter One
	Service	Services enables you to restart or stop the embedded NVR server (VAST server).
	Import/ Export	The Import/ Export utility helps preserve current system configuration or reload a previously-saved configuration.
	Installation Wizard 2	The IW2 utility offers a glimpse of VIVOTEK cameras and the access to them in a local area network.
	Shepherd	You can use shepherd to quickly duplicate individual camera configuration (system, video streams, network, security, etc.) to multiple cameras. Please refer to page xxx for more about this utility.
	Upgrade	The Upgrade provides access to NVR system updates.
	File Manager	The File Manager helps locate particular system or video data when the need arises, say, for retrieving forensic evidences.
	Keyboard	If a keyboard is not available, use this virtual keyboard for entering data.

Below are the functions available through the menu bar:

Menu	Description
Disk Status	Disk Status provides a glimpse of Logical Volumes, Physical disk statuses, HDD status reported through S.M.A.R.T. (Self-Monitoring, Analysis and Reporting Technology), and a test tool to check the integrity of individual disk drives.
Network Status	Displays the network statuses of the NVR's two GbE Ethernet ports, including network type, IP address, subnet, and gateway information.
System Status	Reports system overall working status.

Service

Chances are you may need to stop and restart the embedded VAST server. On occasions such as stopping a recording task, server reported errors, or after you update the software components of the VAST server, you can manually stop and then restart the service.



Import and Export Utility

VAST supports import and export utility for user to keep record of all server settings. You can use the export file to copy the configuration on another host.

Please follow the steps below to export the server settings:

a. Double-click on the Import /Export Utility shortcut.



b. The **Import/Export Utility** window will prompt. Click **Export** and select a location. Enter a file name. The system will start to export a .bin file. This helps preserve your system configuration.

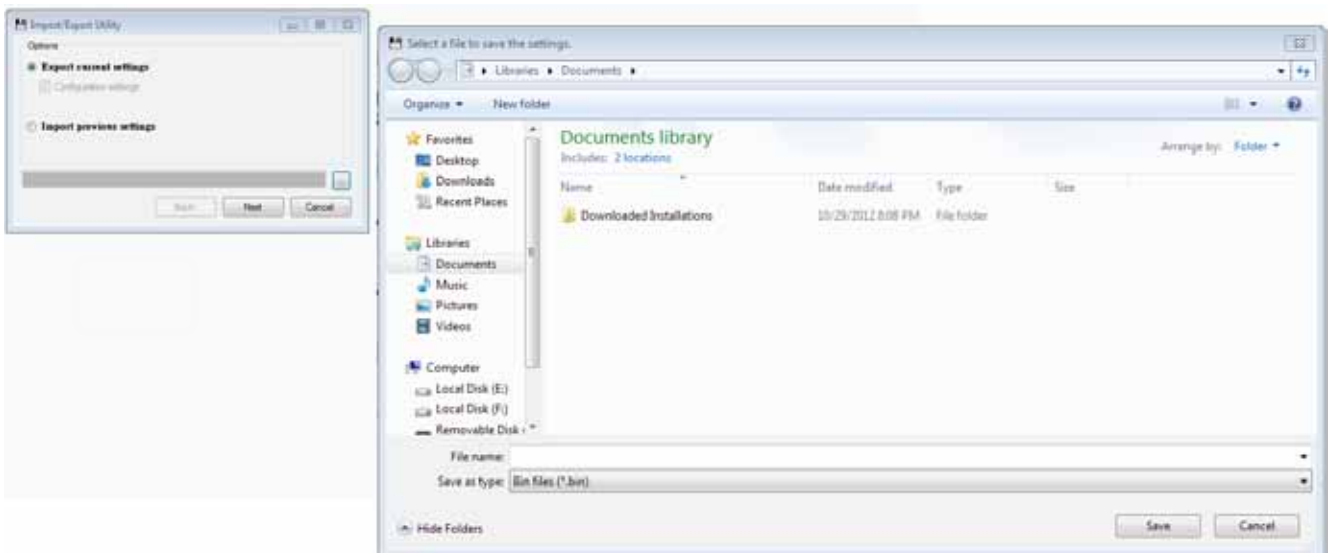

The exporting process may take several minutes. Click Close when the process is completed.



To import a previously saved configuration:

- Click Import previous settings.
- Use the browse button to locate a configuration bin file.
- Click **open**. A message prompt will appear warning you about the replacement of current settings.

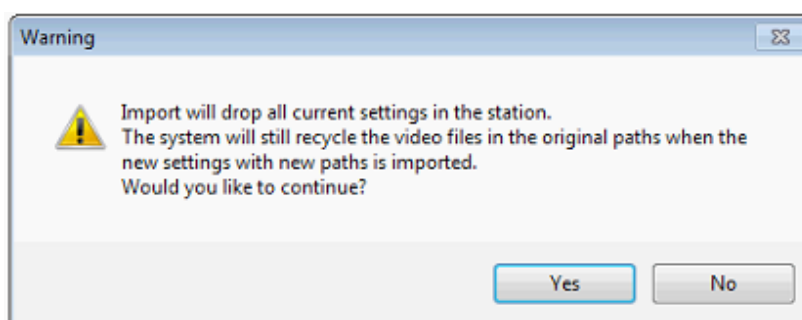
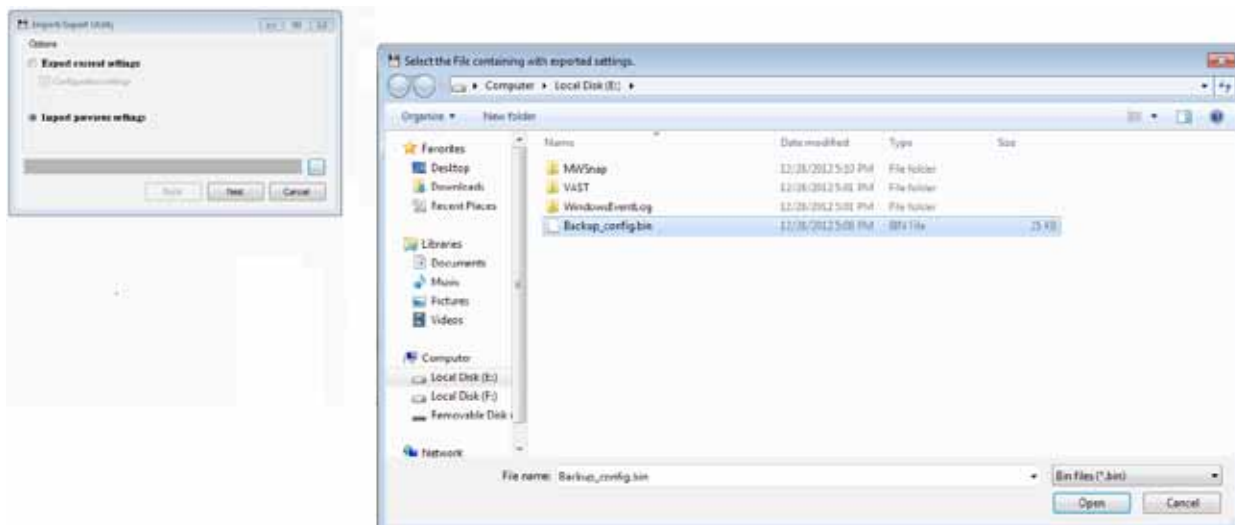

The process may take several minutes to complete. Click Close to finish the process. Your system should now be in sync with the imported configuration.

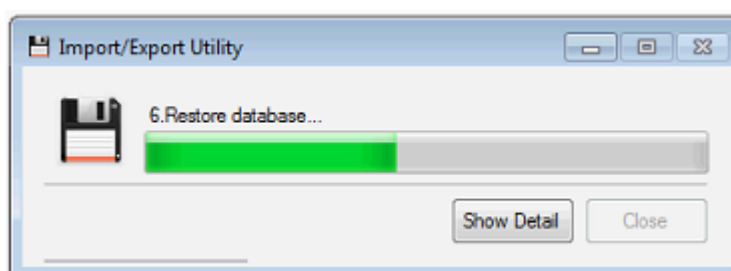

NOTE:

Currently you can use this function to back up or restore your configuration on one machine. You can not use it to duplicate one configuration profile to multiple NVR systems.

Installation Wizard 2

This is the same utility that comes with every VIVOTEK's network camera. You can use it to scan the local network for all VIVOTEK's network cameras, NVR systems, and video servers. Please refer to cameras' software CD for its operation manual.

In addition to opening a direct web console with a camera, you can also use the Camera Configuration function for an immediate access to the streaming, Audio, Remote Focus, and NTP settings.

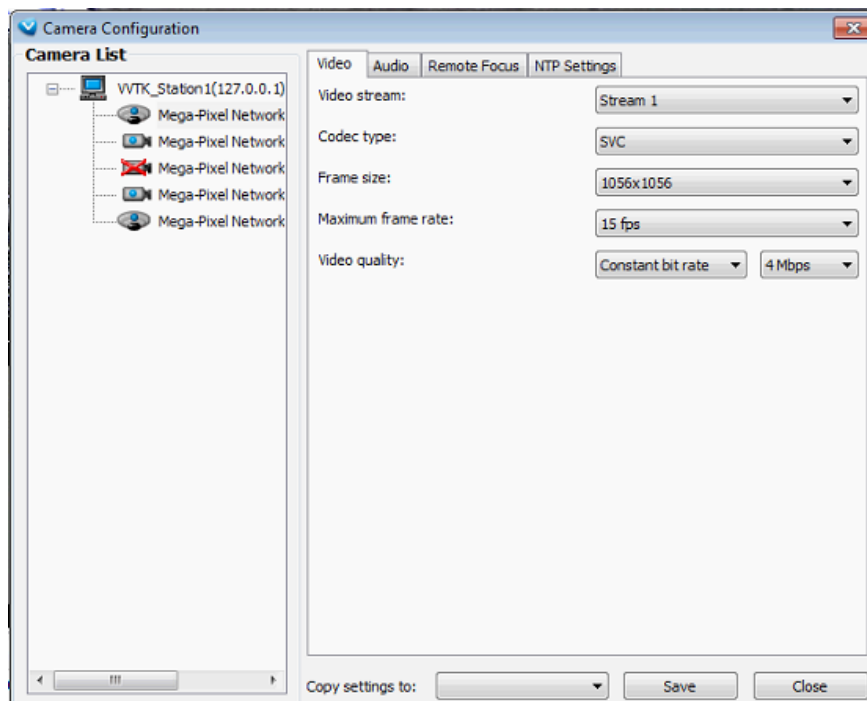
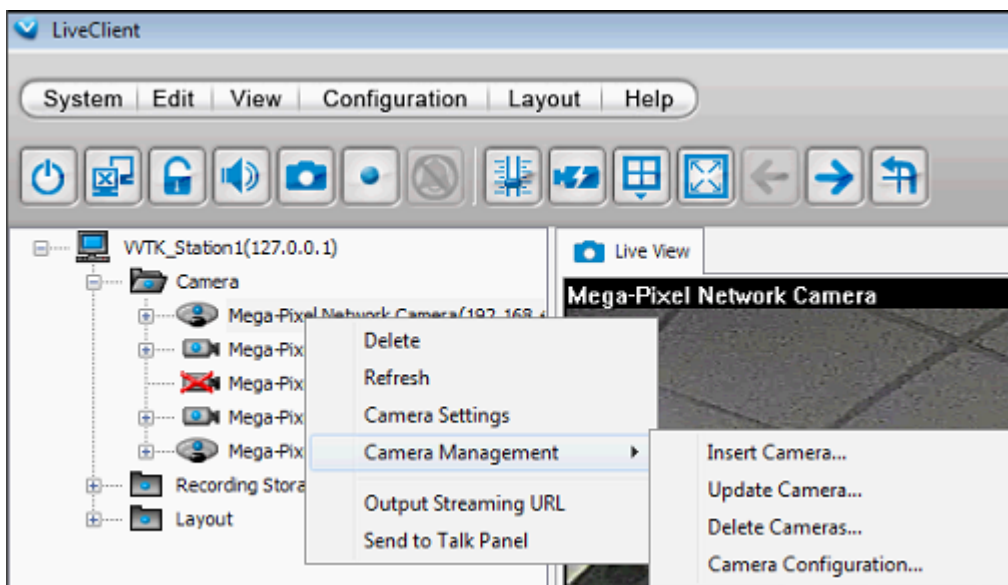

Shepherd



The Shepherd is handy in duplicating one single camera's configuration to multiple cameras. In this way, you do not need to open web consoles with individual cameras for a multiple times. Before using this function, you may open a web console with one of the camera, and configure all aspects of camera settings including network, general settings, security protocols, and media-related settings.

- Double-click on the **Shepherd** shortcut. Note that the target cameras must reside in the same network segment as your NVR's LAN port.
- The **Shepherd** window will prompt. Select a camera (supposedly the one that you have configured satisfactory System, Network, and Media settings) by a left click.
- Click **Get Camera Settings**. An Export Camera Settings window will prompt.

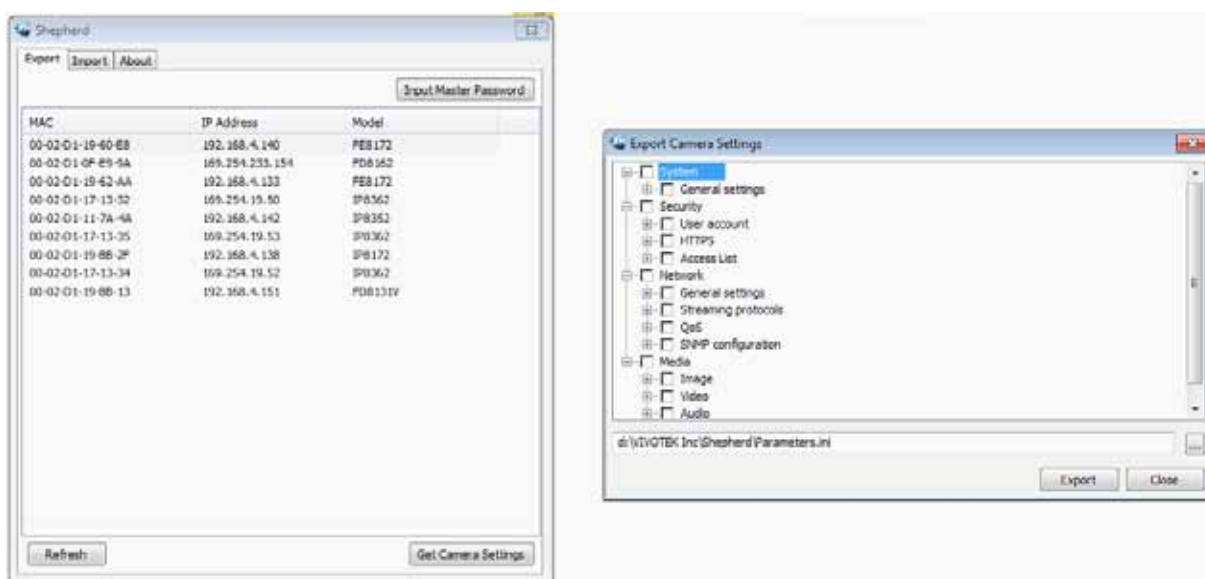

- Unfold menu items and select the items you wish to duplicate to other cameras.
- Click **Export**. A Parameters ini file will be created into the D:\VIVOTEK Inc\Shepherd folder.
- Click to open the **Import** tabbed menu. Use the Browse button to open the Parameters file.

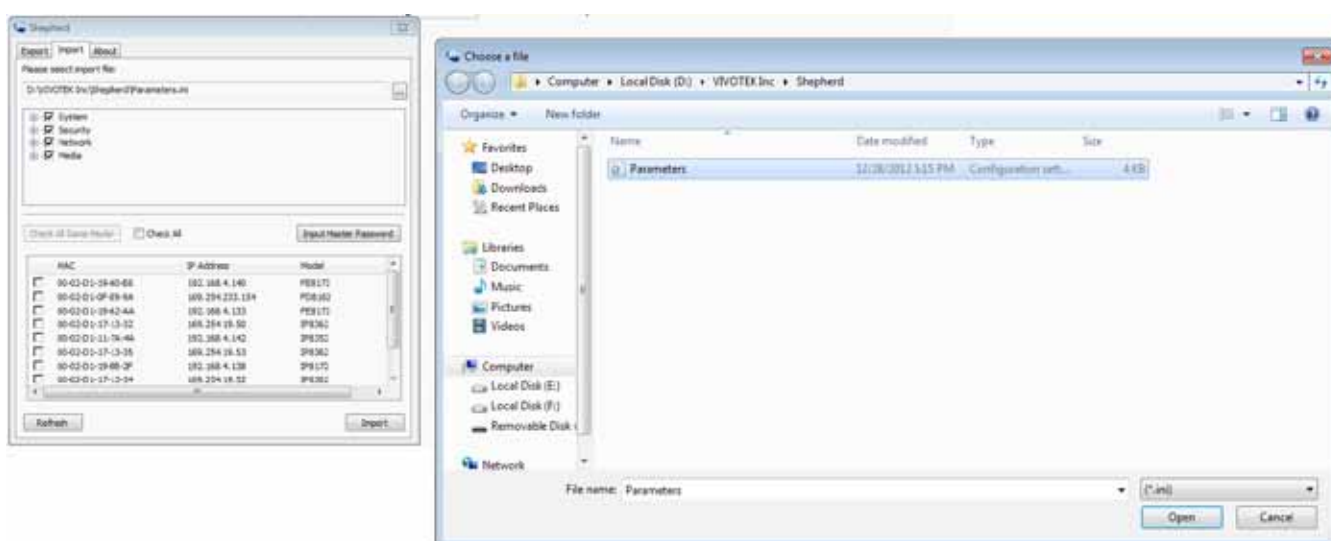

- Parameters will be listed, select the parameters you want to duplicate. Please unfold the menu and check carefully on each configuration detail.
- Select the cameras which will receive the duplicate parameters.

- i. A warning message will remind you of the IP address. If you configured a static IP on the source camera, it is recommended to change it to the automatic IP address setting.
- j. A progress bar will appear on the screen.

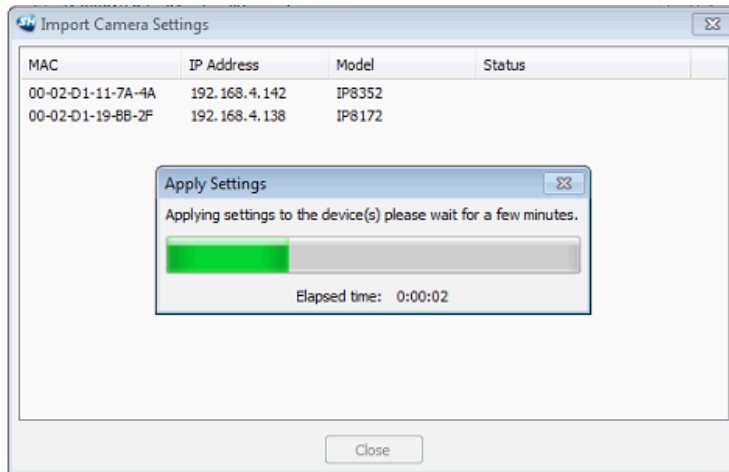
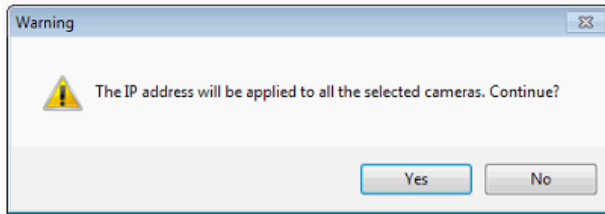

- k. Another message will prompt indicating the completion of the process.

Upgrade

Software upgrade packages will be released on VIVOTEK's support website. You can download these files, and double-click the Upgrade shortcut to open the utility. Please consult VIVOTEK's technical support and the release note before applying upgrades.

Locate the upgrade package and click open. The upgrade process should be completed within minutes. Please note that during the upgrade, the VAST server service will be stopped and restarted. During the time, recording tasks will be temporarily interrupted.

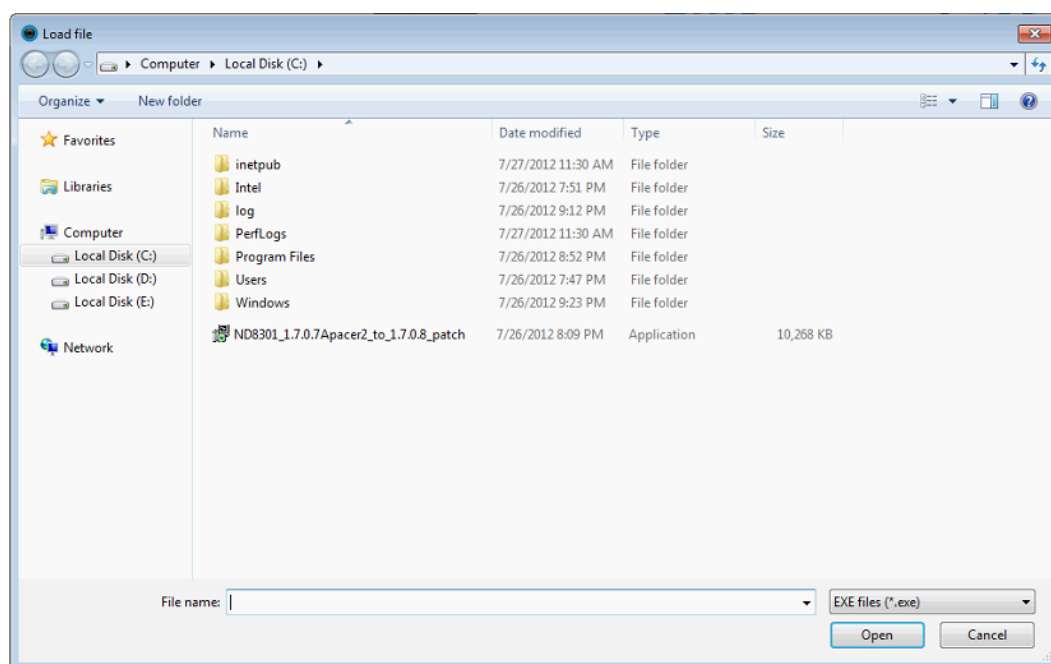

File Manager

The File Manager provides access to the file browser window of the embedded operating system.

By default, the recorded video files should be recorded to the E: volume, and you can use the Export EXE and other similar functions in the Playback utility to extract video clips to the E: volume. You can then retrieve the video clips using a USB drive.

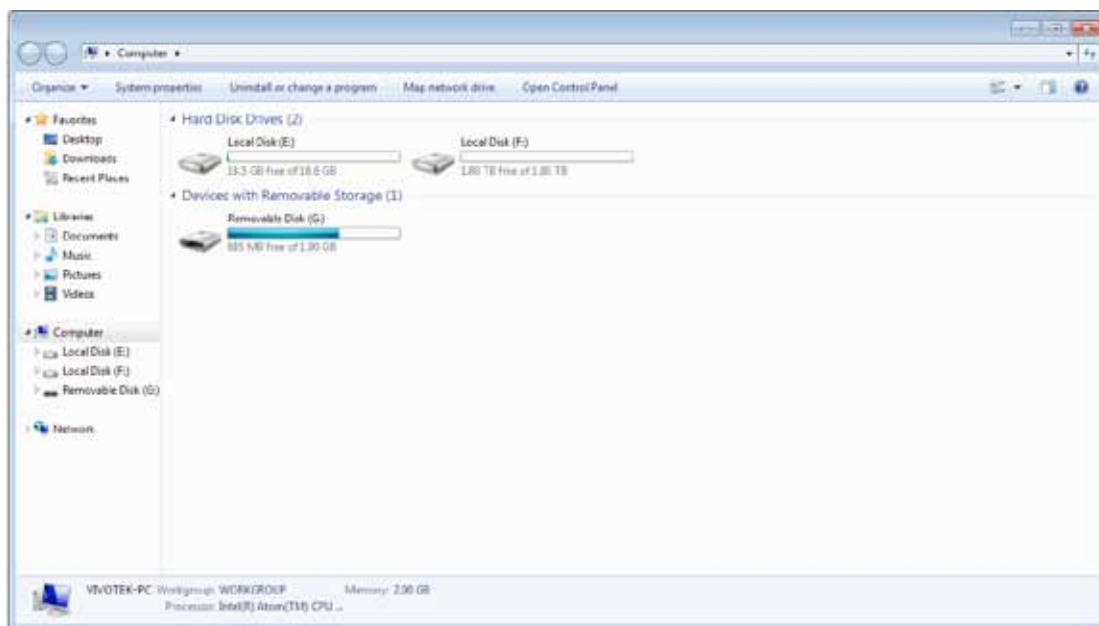

Keyboard

Use the virtual keyboard if you do not have a keyboard attached to the USB port.

Disk Status

Click on the tabbed menu on the desktop to enter the Disk Status window. The first information is the Logical volume working status.

Name	Total size	Free size	State	File system
(E:) [Disk: 1]	149 GB	40 GB	Ready	NTFS

The second window displays the working status of individual disk drives, including model name, capacity, S.M.A.R.T., state, and temperature. Note that if a hard drive is stated as an ArrayMember, the physical drive has already been included into a logical, multi-drive configuration such as RAID0 or RAID1.

Click the tabbed menu below to see more information such as the current working status reported through SMART.

	Model	Capacity	SMART	State	Temperature
1	ST3160811AS	160 GB	PASSED	ArrayMember	44°C (111.2°F)
2	ST3160811AS	160 GB	PASSED	ArrayMember	43°C (109.4°F)

Disk information | SMART | Test

Model family: Seagate Barracuda 7200.9
Model number: ST3160811AS
Serial number: 6PT0QSZ7
Firmware version: 3.AAE
Capacity: 160,041,885,696 bytes [160 GB]
ATA version: 7
ATA standard: Exact ATA specification draft version not indicated

S.M.A.R.T. is short for Self-Monitoring, Analysis, and Reporting Technology. S.M.A.R.T. provides near-term failure prediction that monitors predetermined disk drive attributes that are susceptible to degradation over time. Predictions are limited to the attributes implemented by the HDD manufacturers.

Although attributes are drive specific, a variety of typical characteristics can be identified, for example:

Head flying height, Data throughput performance, Spin-up time, re-allocated sector count, seek error rate, seek time, spin try recount, and drive calibration retry count, etc.

You may perform **Quick Test** or **Complete Test** to acquire the current integrity status. The test utility then polls the hard drives for statuses of the key attributes of its working conditions. The Quick test checks the electrical and mechanical performance as well as the read performance of the disk. Electrical tests might include a test of buffer RAM, a read/write circuitry test, or a test of the read/write head elements. Mechanical test includes seeking and servo on data tracks. Scans small parts of the drive's surface (area is vendor-specific and there is a time limit on the test). The test checks the list of Pending sectors that may have read errors.

Note that a Complete test will scan through the HDD's disk sectors and will take a long time to complete. A Complete test will take around 3 hours on a 1TB HDD.

It is recommended to stop the current recording tasks before performing the test on HDDs.

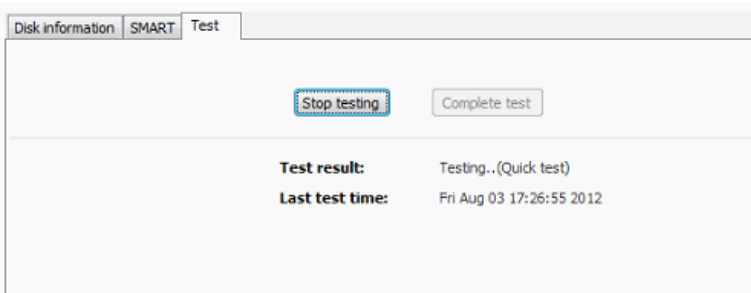

Network Status

This window provides a glimpse of the system two GbE ports including the network type, IP address, subnet, and gateway values.

The screenshot shows the 'Network Status' page in the Vivotek Control Center. The page has a navigation bar with 'Control Center', 'Disk Status', 'Network Status' (highlighted in blue), and 'System Status'. Below the navigation bar, there are two network configuration sections: 'LAN' and 'WAN'. Each section includes a globe icon and a list of network parameters.

Network Type	Type	IP address	Subnet mask	Default gateway
LAN	DHCP	192.168.4.143	255.255.255.0	192.168.4.1
WAN	DHCP	192.168.4.140	255.255.255.0	192.168.4.1

System Status

System Status states the current working status and system time.

Network Status	System Status
Model:	ND8401
Service:	running
Date/Time:	2012/12/28 17:19:38
License:	16
Version:	1.7.1.4

Appendix A Rebuilding a RAID Volume

If a drive fails, the failure will be indicated by the system fault LED or the Disk Status panel. If a disk drive fails in a RAID5 volume, first locate the faulty drive in the Disk Status panel, remove the faulty drive with a drive of the same capacity and rotation speed.

You should be prompted by the message if a hard drive fails or was removed. An incorrect or abrupt shutdown of the system may also force the system to rebuild a RAID volume. Data may not have all been properly distributed to hard drives when inappropriately shut down.



Note that you must carefully identify the faulty drive. Replacing the wrong drive from a RAID5 volume will result in losing 2 member drives. If a RAID5 volume loses 2 members, all data will be lost on that volume.

VIVOTEK Control Center **Disk Status** Network Status System Status

Logical volume: Physical disk ▶

Model	Capacity	SMART	State	Temperature
1 ST3160811AS	160 GB	PASSED	ArrayMember	40°C (104.0°F)
2 ST3160811AS	160 GB	PASSED	ArrayMember	42°C (107.6°F)
3 ST3160811AS	160 GB	FAILED	ArrayMember	33°C (91.4°F)

Disk information SMART Test

Model family: Seagate Barracuda 7200.9
Model number: ST3160811AS
Serial number: 9P10360E
Firmware version: 3.AAE
Capacity: 160,041,885,696 bytes [160 GB]
ATA version: 7
ATA standard: Exact ATA specification draft version not indicated

Once you replace the faulty drive with a new one, an automatic rebuild will begin, and its progress will be indicated by a status bar as shown below. The process will take hours depending on the sizes of your disk drives, e.g., 8 hours if using 2TB drives in a RAID5 volume.

If using a RAID5 volume, the recording task will be halted during the rebuild process. Recording will continue if using storage volumes in other RAID levels.



Appendix B ONVIF Support

Prerequisites:

1. You may connect cameras made by other manufacturers to the system as long as their firmware supports the ONVIF. You may upgrade their firmware if the newer firmware supports ONVIF.
2. The supported ONVIF revision is 2.2.
3. Currently, the system supports ONVIF-compatible cameras by Sony, Panasonic, Bosch, and Axis.

Limitations & Not-supported Features:

1. The system will not display the status of cameras* (ONVIF-compatible cameras by other manufacturers) on the device tree, e.g., as online or off-line.



* All "cameras" mentioned henceforth will refer to the ONVIF-compatible cameras by other manufacturers.

2. The system does not support HTTPS encrypted connection to the cameras.
3. The Focus, Iris, Pan, Patrol, and Preset location buttons will not be supported via the PTZ panel.
4. Does not support the Batch Insert Camera function.
5. Does not support the Camera Configuration function (opening a web session with the camera).
6. Does not support the Search function.
7. Does not support the Active Adaptive Stream (AAS) function.
8. Does not support the event-related functions: event recording, event management, instant playback, event search).
9. Does not support the Two way Audio function (may be supported by later releases of software).
10. Does not support Auto Stream Size function.
11. The ONVIF-related account and password may not be identical to those set for a management console. For example, an ONVIF-compatible Axis camera can not be configured via a web console. A configuration tool is applied instead. Users need to consult the instructions by their vendors.
12. The maximum number of multiple profiles from each camera is 4.
13. The Click on Image function is not supported.

Supported Features:

1. Supports the display of icons for ONVIF cameras*
* All "cameras" mentioned henceforth will refer to the ONVIF-compatible cameras by other manufacturers.
2. Supports Insert/Update/Delete cameras:
 - 2-1. Camera model.
 - 2-2. Connection test.
 - 2-3. Camera password authentication.
 - 2-4. HTTP streaming protocol.
 - 2-5. Multiple streaming
3. Live view/recording/playback
4. Audio G.711 codec.
5. Mechanical PTZ: not including Focus, Iris, Pan, Patrol, and Preset locations.

6. Visual indication on user interface:

	A camera on the device tree
	A camera recording to the system

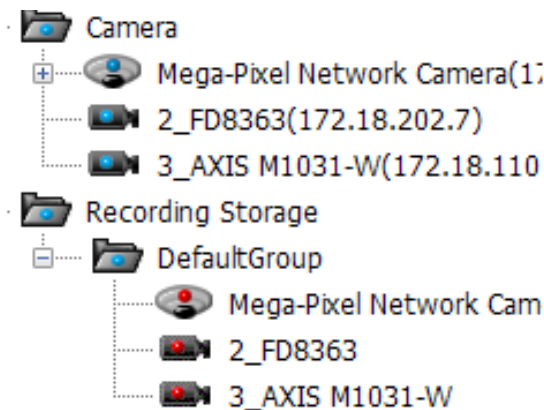

On the insert camera window, an ONVIF brand option is added.

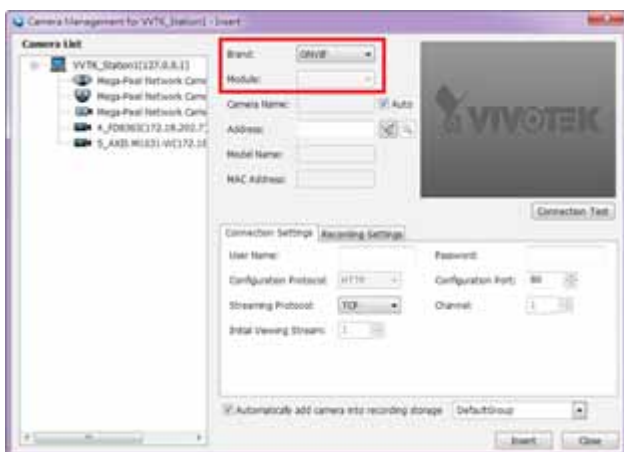

Technical Specifications

Technical Specifications

System CPU: Dual-core Intel® processor RAM: 4GB DDRIII OS: Windows 7 embedded Power Restoration: System restart automatically after Power Recovery System Recovery: Recover operating system after restart every time	Local Playback Display layout: 1X1 Playback mode: play, pause, stop, next/frame, next/previous, speed control Search mode: browsing, time, event, bookmark Graphical timeline Snapshot Bookmark design PIP video control Video enhancement Log viewer
Channels 16-CH selectable	Remote Liveview Display layout: 1X1, 2X2, 3X3, 4X4, 1+5, 1+12 Snapshot Pan/Tilt/Zoom control of VIVOTEK cameras Simple camera and recording settings
Storage 4 x 3.5" HDD, up to 16TB 4 x hot-swappable & lockable hard disk tray HDD S.M.A.R.T. (Self-Monitoring Analysis and Reporting Technology) RAID 0, 1, 5, 10 External eSATA storage	Remote Playback Display layout: 1X1 Playback mode: play, pause, stop, speed control Search mode: browsing, event Graphical timeline
Connectors 1 x VGA for Full HD local display 2 x Gigabit RJ45 Ethernet port 6 x USB 2.0 port 1 x RS232 1 x eSATA 1 x MIC in and line in 1 x line out	Event/Action Management Trigger source: motion, temperature, tampering, DIO, IR, PIR, IVA, video lost, recording error, recording status, substation connection status, storage connection status, storage capacity status, license status, network status & memory status Actions: email, start recording, move to the preset position, set DO, GSM short message & send CGI command
Camera Compatibility Full integration with most VIVOTEK network cameras Integration with ONVIF network cameras (ONVIF version 2.2 compatible)	Security 5 levels of user roles Multi-level user access with password protection Device buzzer notification (HDD/network)
Easy Setup Setup Wizard for network/HDD/camera easy setup IW2 for search internal camera Shepherd for duplicating the camera's configuration to multiple cameras	Backup Manual/scheduled backup
Networking IPv4, TCP/IP, HTTP, RTSP/RTMP/RTCP, IGMP, SMTP, DHCP, NTP, DNS, DDNS	Mobile APP Support VIVOTEK iViewer (iOS/Android)
Recording Throughput: max. 96 Mbps Recording policy: scheduled (event/continuous modes) and manual recording Video compression: H.264/MJPEG/MPEG-4 Audio compression: AMR/G.711/G.726/AAC Resolution: Up to 5-Megapixel recording Format: 3GP Auto recycling: buffer size setting, time setting Activity adaptive recording	Dimension 204 mm (W) x 330 mm (D) x 215 mm (H)
Export Format: AVI/3GPP/EXE	Weight Net: 5.24 kg (without HDD)
Local LiveClient Display layout: 1X1, 2X2, 3X3, 4X4, 1+5, 1+12 Rotate Snapshot Two way audio control PIP video control Stream selectable Set DO control Video enhancement Pan/Tilt/Zoom control of VIVOTEK cameras Preset location Auto pan/patrol Event popup windows Instant event notification Display performance: MJPEG: 16-CH, 30 fps @ CIF MPEG4: 16-CH, 30 fps @ CIF or 2-CH, 30 fps @ 1080P H.264: 7-CH, 30 fps @ CIF or 1-CH, 30 fps @ 1080P Auto stream size	LED Indicator 1 x Power status 1 x HDD status
	Power Input: AC 100-240 V, 50-60 Hz Power consumption: max. 58 W
	Approvals CE, FCC Class B, VCCI, C-Tick
	Operating Environments Temperature: 0°C ~ 40°C Humidity: 20%~95% RH
	Warranty 24 months
	Language English, French, German, Italian, Spanish, Traditional Chinese, Simplified Chinese, Japanese, Portuguese, Czech
	Included Accessories CD content: user's manual, quick installation guide, installation wizard 2, LiveClient (remote), Playback (remote) Others: quick installation guide, warranty card, power cord

Application

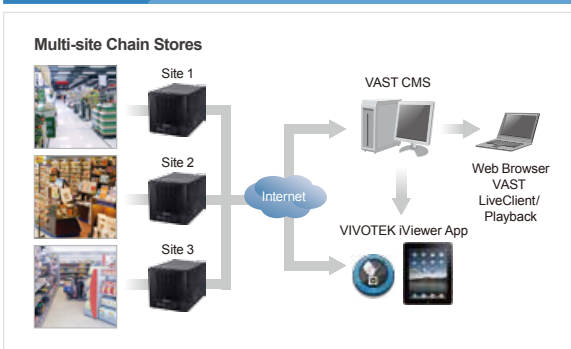

Dimensions

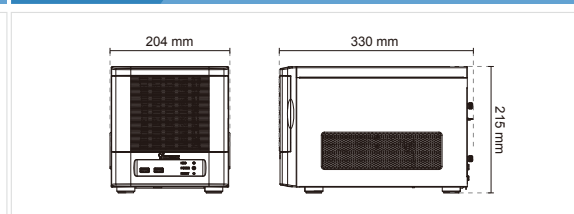

Part No.

ND8401, USA	100091100G	ND8401, UKB	100091130G
ND8401, AUN	100091110G	ND8401, Mexico	100091200G
ND8401, EU	100091120G		

All specifications are subject to change without notice. Copyright © VIVOTEK INC. All rights reserved.

Distributed by:



VIVOTEK INC.
 6F, No.192, Lien-Cheng Rd., Chung-Ho,
 New Taipei City, 235, Taiwan, R.O.C.
 T: +886-2-82455282 F: +886-2-82455532
 E: sales@vivotek.com

VIVOTEK USA
 2050 Ringwood Avenue,
 San Jose, CA 95131
 T: 408-773-8686 F: 408-773-8298
 E: salesusa@vivotek.com

VIVOTEK Europe
 Randstad 22-133, 1316BW Almere,
 The Netherlands
 E: saleseurope@vivotek.com

Ver 1.3