

ADSTAR Distributed Storage Manager



Using the DOS Backup-Archive Client

Version 2

Note!

Before using this information and the product it supports, be sure to read the general information under "Notices" on page ix.

This book is also available in a softcopy form that can be viewed with the IBM BookManager READ licensed program.

First Edition (November 1996)

This edition applies to Version 2 Release 1 of the ADSTAR Distributed Storage Manager, 5648-020, 5622-112, 5697-078, 5763-SV1, 5733-197, 5686-073, 5655-119, 5765-564, 28H2250, 28H2180, 89G1342, and to any subsequent releases until otherwise indicated in new editions or technical newsletters. Make sure you are using the correct edition for the level of the product.

Order publications through your IBM representative or the IBM branch office serving your locality.

You can send us comments about this book electronically:

- IBMLink from U.S.: STARPUBS at SJSVM28
- IBMLink from Canada: STARPUBS at TORIBM
- IBM Mail Exchange: USIB3VVD at IBMMAIL
- Internet: starpubs@sjsvm28.vnet.ibm.com (or starpubs@sjsvm28.vnet.ibm.com)
- Fax (U.S.): 1-800-426-6209

When you send information to IBM, you grant IBM a nonexclusive right to use or distribute the information in any way it believes appropriate without incurring any obligation to you.

© **Copyright International Business Machines Corporation 1993, 1996. All rights reserved.**

Note to U.S. Government Users — Documentation related to restricted rights — Use, duplication or disclosure is subject to restrictions set forth in GSA ADP Schedule Contract with IBM Corp.

Contents

Notices	ix
Trademarks	ix
Preface	xi
What You Should Know Before Reading This Publication	xi
Style Conventions	xii
Referenced Publications	xii
Translations	xiii
Summary of Changes	xiii
Version 2, Release 1, July 1995	xiii
Version 2, Release 1, March 1996	xiv
Version 2, Release 1, November 1996	xv
Reading Syntax Diagrams	xvii
Chapter 1. Introducing the ADSM Backup-Archive Clients	1
Backing Up and Restoring Files	2
Archiving and Retrieving Files	2
Automating ADSM Tasks	3
Setting Processing Options	3
Chapter 2. Getting Started	5
Starting an ADSM Full-Screen (GUI) Session	5
Starting an ADSM Command-Line Session	5
Starting ADSM the First Time	6
Starting ADSM: Advanced Considerations	6
Using the Keyboard	6
Displaying Online Help	7
Changing Your Password	8
Ending a Session	8
Chapter 3. Backing Up and Restoring Files	9
Do You Want to Back Up or Archive Files?	9
Backing Up Files and Directories	9
Backing Up New and Changed Files	10
Backing Up Specific Files or Directories	18
Restoring Files or Directories	23
Do You Want To Restore an Active or Inactive Backup?	23
Restoring Files Using a File Specification	24
Restoring Files Using a Directory Tree	26
Restoring Files Using a Subdirectory Path	26
Restoring Files: Advanced Considerations	27

Chapter 4. Archiving and Retrieving Files	35
Archiving Files	35
Archiving Files Using a File Specification	35
Archiving Files Using a Directory Tree	37
Archiving Files: Advanced Considerations	38
Retrieving Archived Files	41
Retrieving Files	41
Retrieving Files: Advanced Considerations	42
Chapter 5. Automating ADSM Tasks	45
Using Central Scheduling	45
Starting the Client Scheduler	45
Displaying Information About Scheduled Work	46
Displaying Information About Completed Work	47
Specifying Scheduling Options	48
Using Storage Management Policies	51
Understanding Storage Management Policies	51
Displaying Information About Management Classes	53
Choosing a Management Class for Files	57
Choosing a Management Class for Directories	59
Binding and Rebinding Management Classes to Files	59
Chapter 6. Setting Processing Options	61
Understanding Processing Options	61
Communication Options	62
Backup and Archive Processing Options	65
Restore and Retrieve Processing Options	65
Scheduling Options	66
Format and Language Options	67
Command Processing Options	67
Error Processing Option	67
Transaction Processing Option	67
Setting Options in a File	68
Using Options With Commands	68
Creating an Include-Exclude List	69
Excluding System Files	70
Including and Excluding Groups of Files	71
Examples Using Wildcards in EXCLUDE and INCLUDE Patterns	72
Processing INCLUDE and EXCLUDE Options	72
Using Management Classes with INCLUDE	74
Client Options Reference	75
CHANGINGRETRIES	76
COMMMETHOD	77
COMPRESSALWAYS	78
COMPRESSION	79
CPICBUFFERSIZE	80
CPICMODENAME	81
DATEFORMAT	82

DIRMC	83
DOMAIN	84
ERRORLOGRETENTION	85
EXCLUDE	86
FSTYPES	87
INCLUDE	88
IPXBUFFERSIZE	90
IPXSERVERADDRESS	91
IPXSOCKET	92
LANADAPTER	93
LANGUAGE	94
MAXCMDRETRIES	95
NETBIOSBUFFERSIZE	96
NETBIOSNAME	97
NETBIOSSERVERNAME	98
NETBIOSTIMEOUT	99
NODENAME	100
NUMBERFORMAT	101
PARTNERLUNAME	102
POSTSCHEDULECMD	103
PRESCHEDULECMD	104
QUERYSCHEDPERIOD	105
QUIET	106
REPLACE	107
RETRYPERIOD	108
SCHEDLOGNAME	109
SCHEDLOGRETENTION	110
SCHEDMODE	111
SCROLLLINES	112
SCROLLPROMPT	113
SLOWINCREMENTAL	114
SUBDIR	115
SYMBOLICDESTINATION	116
TAPEPROMPT	117
TCPBUFFSIZE	118
TCPCLIENTADDRESS	119
TCPCLIENTPORT	120
TCPPORT	121
TCPSERVERADDRESS	122
TCPWINDOWSIZE	123
TIMEFORMAT	124
TPNAME	125
TXNBYTELIMIT	126
VERBOSE	127
3270BUFFERSIZE	128
3270CHECKSUM	129
3270HOSTCMDPAUSE	130
3270HOSTCOMMAND	131

3270HOSTENDCOMMAND	132
3270HOSTTIMEOUT	133
3270LOGICALTERMINALID	134
400COMMBUFFERBYTES	135
400PARTNERLUNAME	136
400SENDERBUFFERBYTES	137
400TPNAME	138
Chapter 7. Using Commands	139
Starting and Ending a Client Command Session	139
Using Batch Mode	139
Using Interactive Mode	140
Entering Client Commands	140
Command Name	140
Parameters	141
Options	141
Using Wildcard Characters	143
Command Entry Rules	144
Command Reference	145
ARCHIVE—Archiving Files	146
DELETE ACCESS—Deleting Access to Files	149
DELETE ARCHIVE—Deleting Archived Files	151
DELETE FILESPACE—Deleting File Spaces	154
HELP—Displaying Online Help	156
INCREMENTAL—Backing Up New and Changed Files	157
LOOP—Starting an Interactive Command Line Session	160
MACRO—Using Commands Within a Macro File	162
QUERY ACCESS—Displaying File Access Information	163
QUERY ARCHIVE—Displaying a List of Archived Files	165
QUERY BACKUP—Displaying a List of Backup Versions	170
QUERY FILESPACE—Displaying a List of File Spaces	175
QUERY MGMTCLASS—Displaying Management Classes	177
QUERY SCHEDULE—Displaying Scheduled Events	179
RESTORE—Restoring Backup Versions	181
RETRIEVE—Retrieving Files from Archive	189
SCHEDULE—Running Scheduled Events	194
SELECTIVE—Backing Up Selected Files	197
SET ACCESS—Granting Access to Files	200
SET PASSWORD—Changing Your Password	202
Appendix A. Diagnosing Memory and Sharing Problems	203
Fixing Problems with Expanded, Extended, and Conventional Memory	203
Controlling the Use of Expanded Memory	203
Controlling the Use of Extended Memory	204
Controlling the Use of Conventional Memory	204
Fixing Memory Problems with Specific Communication Methods	204
Networking Services/DOS (NS/DOS)	204
PC Support/400 or Client Access/400 BASE Option	205

PC Support/400 or Client Access/400 EXTENDED Option 205
Fixing Sharing Problems 206
Index 215

Notices

References in this publication to IBM products, programs, or services do not imply that IBM intends to make these available in all countries in which IBM operates. Any reference to an IBM product, program, or service is not intended to state or imply that only that IBM product, program, or service may be used. Any functionally equivalent product, program, or service that does not infringe upon any of the intellectual property rights of IBM may be used instead of the IBM product, program, or service. The evaluation and verification of operation in conjunction with other products, except those expressly designated by IBM, are the responsibility of the user.

IBM may have patents or pending patent applications covering subject matter in this document. The furnishing of this document does not give one any license to these patents. Send license inquiries, in writing, to the IBM Director of Licensing, IBM Corporation, 500 Columbus Avenue, Thornwood NY 10594-1907, USA.

Licensees of this program who wish to have information about it for the purpose of enabling: (i) the exchange of information between independently created programs and other programs (including this one) and (ii) the mutual use of the information that has been exchanged, should contact IBM Corporation, Information Enabling Requests, Dept. M13, 5600 Cottle Road, San Jose CA 95193-0001, USA. Such information may be available, subject to appropriate terms and conditions, including in some cases, payment of a fee.

Trademarks

The following terms, denoted by an asterisk (*) in this publication, are trademarks of the IBM Corporation in the United States, other countries, or both:

Advanced Peer-to-Peer Networking	MVS/ESA
ADSTAR	OpenEdition MVS
AIX	Operating System/2
AIXwindows	Operating System/400
AIX/6000	OS/2
Application System/400	OS/2 Warp
APPN	OS/400
AS/400	RISC System/6000
BookManager	Scalable POWERparallel
Database 2	SP2
IBM	VSE/ESA

The following terms, denoted by a double asterisk (**) in this publication, are trademarks of other companies:

AFS	Transarc Corporation
Apple	Apple Computer, Inc.
Attachmate	Attachmate Corp.
Borland	Borland International, Inc.
CompuServe	CompuServe, Inc.
DECstation	Digital Equipment Corp.
DynaText	Electronic Book Technologies, Inc.
EWS-UX/V	NEC Corporation
Extra!	Attachmate Corp.
Hewlett-Packard	Hewlett-Packard Company
HP-UX	Hewlett-Packard Company
Intel	Intel Corp.
IPX/SPX	Novell, Inc.
IRIX	Silicon Graphics, Inc.
Lotus	Lotus Development Corporation
Lotus Notes	Lotus Development Corporation
Macintosh	Apple Computer, Inc.
MacTCP	Apple Computer, Inc.
Microsoft	Microsoft Corp.
Motif	Open Software Foundation, Inc.
NDS	Novell, Inc.
NetWare	Novell, Inc.
NetWare Directory Services	Novell, Inc.
NetWare Loadable Module	Novell, Inc.
NFS	Sun Microsystems, Inc.
NLM	Novell, Inc.
Novell	Novell, Inc.
Open Desktop	The Santa Cruz Operation, Inc.
OpenWindows	Sun Microsystems, Inc.
PC/TCP	FTP Software, Inc.
SCO	The Santa Cruz Operation, Inc.
SINIX	Siemens Nixdorf Information Systems, Inc.
Solaris	Sun Microsystems, Inc.
SPARC	SPARC International, Inc.
Sun	Sun Microsystems, Inc.
Sun Microsystems	Sun Microsystems, Inc.
SunOS	Sun Microsystems, Inc.
Sun-3	Sun Microsystems, Inc.
Sun-4	Sun Microsystems, Inc.
ULTRIX	Digital Equipment Corp.
WATCOM	WATCOM Systems, Inc.
Windows	Microsoft Corp.
Windows NT	Microsoft Corp.
X Windows	Massachusetts Institute of Technology
X/Open	X/Open Company Limited

UNIX is a registered trademark in the United States and other countries licensed exclusively through X/Open Company Limited.

Preface

ADSTAR Distributed Storage Manager (ADSM) is a client/server program product that provides storage management services to customers in a multivendor computer environment. It includes the following programs, which are available on a variety of platforms:

- A *server program* that allows systems to act as a backup and archive server and a migration server for distributed workstations and file servers. The server program provides hierarchical storage management.
- An *administrative client program* that allows an ADSM administrator to control and monitor server activities, define storage management policies for backup, archive, and space management services, and set up schedules to perform those services at regular intervals.
- A *backup-archive client program* that allows users to back up and archive files from their workstations or file servers to ADSM storage, and restore and retrieve backup versions of files and archived copies of files to their local file systems.
- A *hierarchical storage management (HSM) client program* that provides space management services. The HSM client program migrates eligible files to ADSM storage to maintain specific levels of free space on local file systems, and automatically recalls migrated files when they are accessed. It also allows users to migrate and recall specific files. This client is not available on all ADSM-supported platforms.
- An *application programming interface (API)* that allows you to enhance an existing application with storage management services. When an application is registered as a client node with an ADSM server, users can use the application to back up and archive objects, such as databases, to ADSM storage, and restore and retrieve objects from ADSM storage.

This publication provides information about the ADSM DOS backup-archive client. ADSM runs on DOS 5.0 or later.

What You Should Know Before Reading This Publication

This publication is intended for users who need to back up and archive their workstation files.

We assume that you know how to use your workstation, and that you understand the general operation of the operating system. We also assume that the ADSM client is installed and working on your system. See the *Installing the Clients* manual for information on installing your client.

There are two versions of the backup-archive client: a graphical user interface (GUI) client and a command-line client. You might have both, or just one, of these clients installed. This book covers both clients, but the command-line client is treated as an advanced topic.

Style Conventions

Throughout the book, we use these style conventions:

Figure 1. Style Conventions

Convention	Indicates
bold	A part of a window, or a file name.
UPPER CASE	An ADSM command or option.
<i>italics</i>	A new term.
monospace text	An example in the text.
semicolon (;)	Separates a sequence of actions. You should do these actions one after the other. For example, "select the Backup menu; Incremental backup item" means to select the Backup menu from the action bar, then select the Incremental backup item from that menu.
plus sign (+)	Used between two keys to indicate that the two keys it separates should be pressed simultaneously.

Referenced Publications

The publications referenced in this book are listed in Figure 2.

Figure 2. Referenced Publications

Short Title	Publication Title	Order Number
Installing the Clients	<i>ADSTAR Distributed Storage Manager Installing the Clients</i>	SH26-4049
ADSM Messages	<i>ADSTAR Distributed Storage Manager Mes- sages</i>	SH35-0133

All of the ADSM publications are available in online readable format on the *ADSM Online Product Library* CD-ROM, order number SK2T-1878. The ADSM library is also available in softcopy on the following CD-ROMs:

<i>AIX Base Collection Kit</i>	(order number SK2T-2066)
<i>AS/400 Base Collection Kit</i>	(order number SK2T-2171)
<i>MVS Base Collection Kit</i>	(order number SK2T-0710)
<i>OS/2 Base Collection Kit</i>	(order number SK2T-2176)
<i>VM Base Collection Kit</i>	(order number SK2T-2067)
<i>VSE Base Collection Kit</i>	(order number SK2T-0060)
<i>IBM SystemView for AIX</i>	(order number SK2T-1451)

Translations

Selected ADSM publications have been translated into languages other than American English. The *ADSTAR Distributed Storage Manager: General Information*, GH35-0114, has a complete list of the available translations and their order numbers. Contact your IBM representative for more information about the translated publications and whether these translations are available in your country.

Summary of Changes

Major technical changes in this book are indicated by a vertical bar (|) in the margin. Previous editions of this book were called *ADSM User's Guide and Reference for DOS*, order number SH35-0123.

Version 2, Release 1, July 1995

These are the changes made for ADSM Version 2 Release 1.

Functional Enhancements

- An ADSM hierarchical storage management (HSM) client, which manages storage space on local file systems, is now available on AIX 3.2.3, 3.2.4, and 3.2.5. HSM ensures that sufficient storage space is available on your workstation for new data, by migrating less frequently used files to ADSM storage.
- You can use a quicker form of incremental backup, *partial incremental*. A partial incremental does not capture all the changes to your workstation since the last back up, and so is not a replacement for the standard full incremental.
- ADSM backup-archive clients are now available for the following workstations:
 - Siemens Nixdorf Information Systems, Inc., SINIX
 - AT&T Global Information Solutions UNIX
 - Silicon Graphics IRIX
 - NEC Corporation EWS-UX/V
 - IBM OpenEdition MVS
 - Microsoft Windows NT workstation and Advanced Server on Intel-compatible machines
- These options have been added:
 - ERRORLOGRETENTION
 - FSTYPES
 - POSTSCHEDULECMD
 - PRESCHEDULECMD
 - SCHEDLOGRETENTION
 - TXNBYTELIMIT

- These command-line-only options have been added:
 - DELETEFILES (for ARCHIVE)
 - FROMDATE (for QUERY ARCHIVE, QUERY BACKUP, RESTORE, RETRIEVE)
 - FROMTIME (for QUERY ARCHIVE, QUERY BACKUP, RESTORE, RETRIEVE)
 - IFNEWER (for RESTORE)
 - INCRBYDATE (for INCREMENTAL)
 - TODATE (for QUERY ARCHIVE, QUERY BACKUP, RESTORE, RETRIEVE)
 - TOTIME (for QUERY ARCHIVE, QUERY BACKUP, RESTORE, RETRIEVE)
- A new command, MACRO, that allows you to run a macro that contains ADSM commands.
- Because the Version 2 clients store files in a different format than the Version 1 clients, ADSM updates the attributes for each active file on the ADSM server during the first incremental backup after you install the Version 2 client.

Changes to this Book

- We have moved installation information from this book to a common installation guide, *ADSTAR Distributed Storage Manager Installing the Clients*.
- We have moved the messages from this book to a common message guide, *ADSM Messages*.
- This book has been reorganized and rewritten to make it easier to use.

Version 2, Release 1, March 1996

These are additional changes made for ADSM Version 2 Release 1.

Functional Enhancements

- The NOPROMPT option has been added to the DELETE ARCHIVE command.
- The following options have new default values:
 - CPICBUFFERSIZE
 - IPXBUFFERSIZE
 - NETBIOSBUFFERSIZE
 - TAPEPROMPT
 - TCPBUFFSIZE
 - TCPWINDOWSIZE
 - TXNBYTELIMIT
 - 400COMMBUFFERBYTES
 - 400SENDBUFFERBYTES

| **Version 2, Release 1, November 1996**

| These are additional changes made for ADSM Version 2 Release 1.

| **Functional Enhancements**

- |
 - The COMPRESSALWAYS option has been added.

Reading Syntax Diagrams

This section describes how to read the syntax diagrams used in this book.

To read a syntax diagram, follow the path of the line. Read from left to right and top to bottom.

- The \blacktriangleright — symbol indicates the beginning of a syntax diagram.
- The — \blacktriangleright symbol at the end of a line indicates the syntax diagram continues on the next line.
- The \blacktriangleright — symbol at the beginning of a line indicates a syntax diagram continues from the previous line.
- The — \blacktriangleleft symbol indicates the end of a syntax diagram.

Syntax items, such as a keyword or variable, can be:

- On the line (required element)
- Above the line (default element)
- Below the line (optional element).

Syntax Diagram Description	Example
<p>Abbreviations:</p> <p>Uppercase letters denote the shortest acceptable truncation. If an item appears entirely in uppercase letters, it cannot be truncated.</p> <p>You can type the item in any combination of uppercase or lowercase letters.</p> <p>In this example, you can enter KEYWO, KEYWORD, or KEYWOrd.</p>	<p>\blacktriangleright—KEYWOrd—\blacktriangleleft</p>
<p>Symbols:</p> <p>Enter these symbols exactly as they appear in the syntax diagram.</p>	<ul style="list-style-type: none"> * Asterisk { } Braces : , = Equal Sign - Hyphen () Parentheses . Space
<p>Variables:</p> <p>Italicized lowercase items (<i>var_name</i>) denote variables.</p> <p>In this example, you can specify a <i>var_name</i> when you enter the KEYWORD command.</p>	<p>\blacktriangleright—KEYWOrd—<i>var_name</i>—\blacktriangleleft</p>

Syntax Diagram Description

Example

Repetition:

An arrow returning to the left means you can repeat the item.

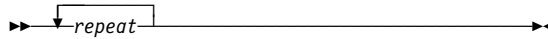

A character within the arrow means you must separate repeated items with that character.

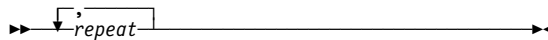

A footnote by the arrow references the number of times you can repeat the item.

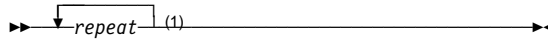

Note:

¹ Specify *repeat* as many as 5 times.

Required Choices:

When two or more items are in a stack and one of them is on the line, you *must* specify one item.



In this example, you *must* choose A, B, or C.

Optional Choice:

When an item is below the line, that item is optional. In the first example, you can choose A or nothing at all.



When two or more items are in a stack below the line, all of them are optional. In the second example, you can choose A, B, C, or nothing at all.



Defaults:

Defaults are above the line. The default is selected unless you override it. You can override the default by including an option from the stack below the line.

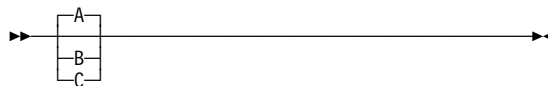

In this example, A is the default. You can override A by choosing B or C. You can also specify the default explicitly.

Repeatable Choices:

A stack of items followed by an arrow returning to the left means you can select more than one item or, in some cases, repeat a single item.



In this example, you can choose any combination of A, B, or C.

Syntax Fragments:

Some diagrams, because of their length, must fragment the syntax. The fragment name appears between vertical bars in the diagram. The expanded fragment appears between vertical bars in the diagram after a heading with the same fragment name.



The fragment name:

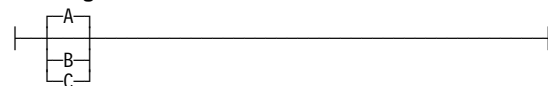

Chapter 1. Introducing the ADSM Backup-Archive Clients

The ADSTAR Distributed Storage Manager (ADSM) is a client/server program that helps you protect information on your workstation. Using ADSM, you can maintain backup versions of your workstation files that you can restore quickly and easily if the original files are damaged or lost. You can also archive files that you do not currently need on your workstation or that you want to preserve in their current state, and retrieve them when necessary.

The portion of ADSM that provides these services is the *backup-archive client*, a program that allows you to request backup and archive services from an ADSM server.

From the main window you use the menus in the action bar to do your ADSM backup and archive tasks (Figure 3).

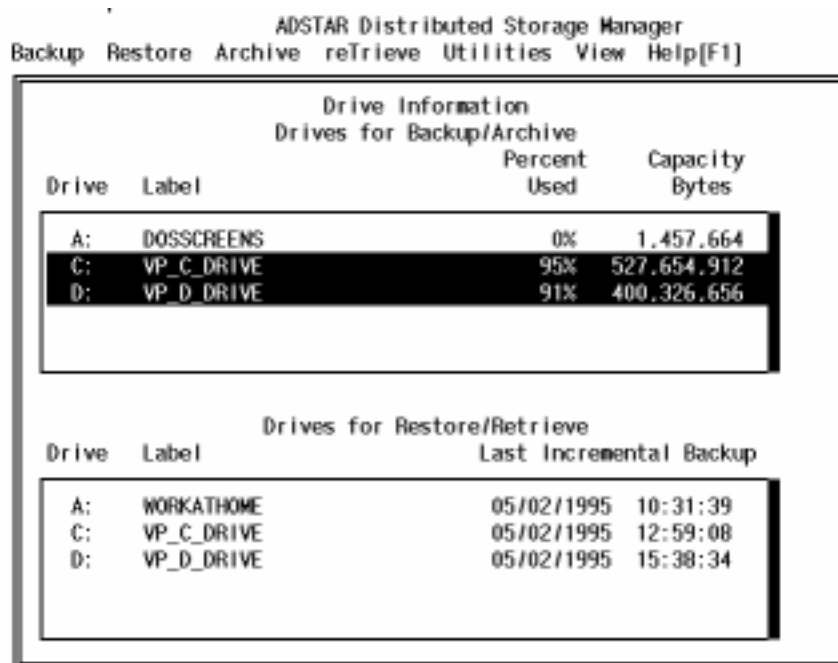

Figure 3. The ADSM Main Window

The main window is divided into two parts: **Drives for Backup/Archive** and **Drives for Restore/Retrieve**. To perform an action, you must select the drives you want to use from one of these lists, and then select the action from the action bar.

You can use the graphical user interface, or you can use ADSM commands. You can do most tasks with the graphical user interface. For tasks such as scheduling, you use commands. The commands are also useful if you run them in batch.

Backing Up and Restoring Files

You request *backup* services when you want ADSM to save copies of files that you can restore if your original files are damaged or lost. These copies are called *backup versions* or *backups*.

To back up files, you can choose one of the following:

- *Incremental backup*—Backs up all files and directories on the drives you specify that meet certain criteria.
- *Selective backup*—Backs up only those files you specify.

Running incremental backups on a regular basis can ensure that you have recent backup versions of your current files available at all times. Selective backup is useful when you want to back up only a specific subset of your files.

If you accidentally erase a file that you need, or if a file on your workstation is damaged or lost, you can *restore* a backup version of the file from the server.

You can restore a single file, a group of files, or all the files in a directory. You can also choose to restore files to the same directory from which you backed them up or to a different directory. You can restore any files you back up and any other files to which another user grants you access.

For more information about backing up and restoring, see Chapter 3, “Backing Up and Restoring Files” on page 9.

Archiving and Retrieving Files

You request *archive* services when you want to save files at a specific point, or when you want to place copies of files on long-term ADSM storage and erase them from your workstation disk. These copies are called *archive copies* or *archives*.

Archives are never replaced with more current versions, but are preserved exactly as you store them.

You can archive a single file, a group of files, or all the files in a directory. When you archive a file, you can enter a description of the file that you can use later to retrieve it. You can return archive copies to the same directory from which you archived them or to a different directory.

If you find you need a copy of an archived file back on your workstation, you can *retrieve* the file from the server.

You can retrieve any files you archive and any other files to which another user grants you access.

For more information about archiving and retrieving, see Chapter 4, “Archiving and Retrieving Files” on page 35.

Automating ADSM Tasks

ADSM provides *central scheduling* to automatically perform ADSM tasks. Your ADSM administrator defines schedules. For example, you might have files that you want backed up daily, weekly, or monthly. After defining appropriate schedules, your administrator associates your client node with those schedules.

You need to decide what schedule you want to use, and then run the *client scheduler*, which tells the server to include your node when it runs the schedule.

For more information about scheduling, see “Using Central Scheduling” on page 45.

Storage management policies are a set of rules that govern how and when your data is backed up and archived. Your ADSM administrator defines these policies, and you associate your data with them.

Your administrator can coordinate scheduled services with the storage management policies you use for your files. For example, if the storage management policy you use for a group of files specifies that they can be backed up only once a week, your ADSM administrator can schedule automatic backup services to occur for those files on a particular day each week.

For more information about storage management policies, see “Using Storage Management Policies” on page 51.

Setting Processing Options

ADSM includes options that control processing for user sessions. For example, you can use the options to tell ADSM which communication method to use, or what format to use for dates.

ADSM uses an options file named **dsm.opt** to specify certain information related to your ADSM session. These options are in effect for an entire ADSM session, but can be overridden by setting a different value for them when processing an ADSM command or starting ADSM.

To view the options that are already set for your client, select the **Utilities** menu; **Display Options** item (Figure 4 on page 4).

Utilities

Change password...	
Set authorization...	
Display drives for node...	Ctrl+Q
Display options...	Ctrl+O
Display policy information...	Ctrl+Z
<hr/>	
Delete archive files...	Ctrl+W
Delete restore/retrieve drives...	Ctrl+F

Figure 4. The Utilities Menu

For more information about ADSM options, see Chapter 6, “Setting Processing Options” on page 61.

Chapter 2. Getting Started

This chapter contains instructions for starting and ending an ADSM session.

Starting an ADSM Full-Screen (GUI) Session

Start ADSM by entering one of the DSM commands listed in Figure 5 after the prompt. Or, you can double-click on the file in the DOS shell.

Use the command associated with the communication method that you are using.

Figure 5. DSM Commands for Starting the ADSM DOS Clients (GUI)

Command	Communication method
DSMATM	Attachmate Extra!
DSMCPIC	PWSCS (Programmable Workstation Communication Services)
DSMFTP	FTP TCP/IP
DSMIBM	IBM TCP/IP Version 2.1
DSMIBM20	IBM TCP/IP Version 2.0
DSMIPX	IPX/SPX
DSMNET	NETBIOS
DSMNSD	NS/DOS (SNA LU6.2)
DSM3270	PC3270 Version 3.0 or above
DSM400	PC Support/400 or Client Access/400

Your ADSM administrator has the option to force you to use a password to connect to the ADSM server. ADSM prompts you for the password if one is required. Contact your administrator if you do not know your password.

Starting an ADSM Command-Line Session

Use one of the DSMC commands to start an ADSM command-line session. These commands are listed in Figure 51 on page 139. They differ based on the communication software you are using.

If you only need to run one command, you can use *batch mode*. In this case, include the ADSM command on DSMC:

```
dsmcibm incremental
```

If you intend to issue several ADSM commands, use *interactive mode*. First issue the LOOP command to get into interactive mode:

```
dsmcibm loop
```

Thereafter you need only enter the ADSM command after the `dsmc>` prompt.

See Chapter 7, “Using Commands” on page 139 for complete information on how to start and use the command-line client. The guidance sections of this book treat the command-line client as an advanced topic.

Starting ADSM the First Time

Before you can use ADSM, your client must be registered with the ADSM server.

Your ADSM administrator decides how you register your client with the server. If your site is using open registration, ADSM prompts you for your ADSM node name, password, and contact information. If your site is using closed registration, your administrator must register you to use ADSM.

Starting ADSM: Advanced Considerations

You can include ADSM options on the DSM commands. For example, you can modify the format used to display dates, times, and numbers, or you can include your password so that ADSM does not prompt for it. (However, if you include the `PASSWORD` option, your password can be seen by someone who sees you enter the command).

For example, you might have two machines that back up to ADSM under separate node names. If you wanted to recover a file from one machine (JONES1) while at the other machine (JONES2), you could start ADSM using the `NODENAME` option specifying JONES1:

```
dsmibm -nodename=jones1
```

Be careful if you use ADSM in this way. Do not attempt to do an incremental backup from the JONES2 machine while connected to ADSM as JONES1. If the drive labels are the same on the JONES1 and JONES2 machines, the incremental backup expires any files that are not on the JONES2 machine, even if they still exist on JONES1. You could lose some valuable backup versions.

(*Expiring* a file means that old backup versions of the file are deleted from ADSM storage. ADSM does not delete files from your workstation.)

Using the Keyboard

You can only use the keyboard with ADSM—your mouse does not work with the program.

Throughout this publication, the term *select* can mean:

- Highlight the menu or other item and press enter.

For example, to “select the **Backup** menu” you can move the cursor highlight to the **Backup** menu by pressing F10 and positioning the cursor with the Tab or arrow key, and then press Enter. The menu opens to let you select an item from it.

- Use the keys associated with the action.

For example, to “select the **Backup** menu” you can press Alt+B. In general, use Alt plus the capitalized letter of the menu to open the menu. Then, position your cursor on the item you want and press Enter.

Other actions have function keys assigned to them. These key assignments are listed on each ADSM window.

- Highlight the item and press the space bar, if selecting from a list of files or choices.

For example, to “select the drives you want to back up,” move the cursor to the drive and press the space bar. The item remains highlighted to show you have selected it. Pressing the space bar on a selected item deselects the item.

Figure 6 lists some other important keys.

Figure 6. Important Keys for Using the ADSM DOS GUI

Key	Action
Alt	Use with capitalized letter of menu name to open menu on action bar.
F3	Exits ADSM.
F10	Moves cursor between windows and action bar.
Tab or arrow	Moves cursor between input fields and menus, for example, between the Drives for Backup/Archive and Drives for Restore/Retrieve .
Space bar	Selects and deselects items from lists
Esc	Clears messages, cancels from windows, moves cursor from action bar.

Displaying Online Help

You can display online help by selecting the **Help** menu on the action bar (shown in Figure 7). Do this by pressing F1.

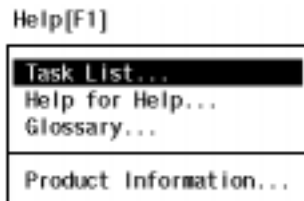

Figure 7. ADSM Help Menu

The **Task list** contains a list of tasks you can do with ADSM, each topic describing the required steps. The **Glossary** contains a glossary of terms used in ADSM.

To get help for menu items and windows:

- For a menu item, highlight the item and then press F1.

- For a window, press F1 while the window is displayed and active.

Changing Your Password

If you are using passwords, you should change them regularly to protect access to your data.

To change your password, select the **Utilities** menu; **Change password** item. Fill in your old and new passwords and select **OK**.

An ADSM password can be up to 64 characters. Valid characters are:

Characters	Description
A–Z	any letter, A through Z, upper or lower case
0–9	any number, 0 through 9
+	plus
.	period
_	underscore
-	hyphen
&	ampersand

A password is not case sensitive.

You can also use the SET PASSWORD command to change the ADSM password. (See “SET PASSWORD—Changing Your Password” on page 202.)

Ending a Session

Stop ADSM by selecting the **Backup** menu; **Exit** item, or by pressing F3.

If you are using the command-line client in interactive mode, exit the client with **quit**.

Chapter 3. Backing Up and Restoring Files

One of ADSM's main uses is to maintain a set of backup versions of the files on your workstation. This allows you to recover older versions of your files if those files are lost or damaged.

This chapter covers the various ways you can back up your files using ADSM, and how you can restore them when necessary. It also covers the difference between backing up and archiving files.

Do You Want to Back Up or Archive Files?

When ADSM backs up or archives a file, it sends a copy of the file and its associated attributes to the ADSM server. Backups and archives, though, have different purposes.

Backups are used to protect against file damage. A sequence of backup versions are kept for each file on your workstation (the number of backup versions is set by your ADSM administrator), and older versions are deleted as newer versions are made.

Archive copies, however, are permanent. They are used to maintain a file in a particular state indefinitely (although your administrator also sets a limit on how long archives are kept). They are useful if you think you might need to go back to a particular version of your files, or if you want to delete a file from your workstation and still be able to retrieve it if necessary. For example, you might need to save some spreadsheets for tax purposes, but because you are not using them, you do not want them left on your workstation. See Chapter 4, "Archiving and Retrieving Files" on page 35 for more information on archive.

Use backups to protect against unforeseen damage to your files, and archives for maintaining a more permanent version of your files.

Backing Up Files and Directories

There are two types of backup using ADSM: incremental and selective.

An *incremental backup* backs up all files that are new or that have changed since the last incremental backup.

A *selective backup* backs up the specific files you indicate.

Your administrator might have set up schedules to back up files on your workstation automatically. See Chapter 5, "Automating ADSM Tasks" on page 45 for information on checking and running the schedules available to you. The following sections cover how to back up files without using a schedule.

Backing Up New and Changed Files

The most effective way to maintain a complete set of backup versions for your most important files is to run incremental backups regularly. An incremental backup backs up the new or changed files on your workstation.

There are two types of incremental backup: *full* and *partial*. A full incremental is also referred to simply as an *incremental* backup.

Do You Want a Full or Partial Incremental?

If you are a casual user of ADSM, and you do not want to worry about the details, skip this section and perform only full incremental backups of your machine. See “Running a Full Incremental Backup” on page 11 for how to perform full incremental backups.

There are two main differences between full and partial incremental backup:

- A full incremental ensures that the backups kept on the ADSM server are managed according to your installation's storage management policies (see “Understanding Storage Management Policies” on page 51). It ensures that your backup storage accurately reflects the state of your workstation storage.

A partial incremental does not ensure that the server reflects the exact state of your workstation. For example, files that would normally be backed up during a full incremental might not be backed up during a partial incremental. Also, old files that should be deleted from the server might not be deleted. See “Understanding Partial Incrementals” on page 11 for an explanation of how ADSM determines what happens during a partial incremental.

- A partial incremental should complete more quickly than a full incremental and require less memory. Thus, if you are constrained for time or machine memory, you might want to perform a partial incremental.

Use partial incremental only if you must meet a limited backup time window, and a full incremental takes longer than the allotted time. Periodically perform full incremental backups to bring the ADSM server in line with your workstation's status. For example, if you have only a limited time during the week to perform backups, but extra time on the weekend, you can use partial backups on the weekdays, and then use full incremental backups on the weekends.

Understanding Full Incrementals: In a full incremental, the client queries the ADSM server so that it knows the exact state of your storage as of your last incremental. During a full incremental, ADSM uses this information to:

- Back up new files
- Back up files whose contents have changed
- Back up files whose directory contents have changed
- Expire backup versions on the server for files that have been deleted from the workstation.
- Rebind backup versions to management classes if you have changed management class assignments, even if the associated file is not backed up.

All of this processing is required to maintain your backups according to the policies defined in the management classes.

Understanding Partial Incrementals: In a partial incremental, however, only certain information is considered when deciding whether to back up a file. This is the available type of partial incremental:

- *Incremental by date.* The client only asks the server for the date and time of the last incremental backup. This is the only information used to determine which files get backed up, so any changes that do not change the date and time are not recognized. If a file's last changed date and time is after that of the last backup, the file is backed up. Otherwise, it is not, even if the file is new to the workstation.

Also, in a partial incremental, files are not expired or rebound on the server, and the copy group's frequency attribute of the management classes is ignored.

Running a Full Incremental Backup

To run a full incremental backup:

- 1** Choose which drives you want to back up from the **Drives for Backup/Archive** section of the Drive Information window by moving the cursor to the drive and pressing the space bar. Some drives are already selected. You can deselect these drives using the space bar.
- 2** Select the **Backup** menu; **Incremental backup** item (Figure 8).



Figure 8. Selecting Incremental Backup from the Backup Menu

ADSM starts the incremental backup, and displays the status of the backup in the Backup Status window (see "Understanding the Backup Status Window" on page 12). ADSM tells you when the backup is complete. The first time you do an incremental backup, ADSM has to back up all your files, which can take a long time. Subsequent backups usually do not take as long.

Running an Incremental Backup by Date

To run an incremental by date:

- 1** Choose which drives you want to back up from the **Drives for Backup/Archive** section of the Drive Information window by moving the cursor to the drive and

pressing the space bar. Some drives are already selected. You can deselect these drives using the space bar.

2 Select the **Backup** menu; **Incremental by Date** item (Figure 9).



Figure 9. Selecting Incremental by Date from the Backup Menu

ADSM starts the incremental by date, and displays the status of the backup in the Backup Status window (see “Understanding the Backup Status Window”).

Understanding the Backup Status Window

During any type of backup, ADSM uses the Backup Status window (Figure 10) to show you what it is doing, and to provide you with statistics on various items.

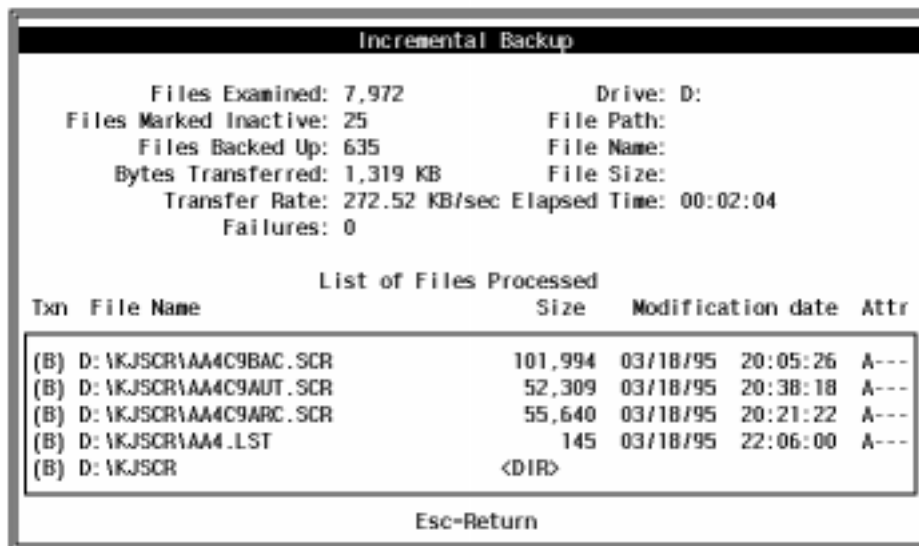

Figure 10. Backup Status Window

The fields in the window are:

Files Examined

The number of files on your workstation that ADSM considered backing up.

Files Marked Inactive

The number of backup versions of files on ADSM storage that were marked inactive because the original files were deleted from your workstation since your last backup.

Files Backed Up

The number of files backed up. This includes directories, which count as two files each.

Bytes Transferred

The number of kilobytes of data sent to the ADSM server.

Transfer Rate

The speed at which bytes were transferred to the ADSM server.

Failures

The number of files ADSM could not back up.

Drive

The drive being backed up.

File Path

The directory being backed up.

File Name

The name of the file being backed up.

File Size

The size of the file being backed up.

Elapsed Time

The amount of time it took to back up all the files.

The lower half of the window, **List of Files Processed**, contains a list of the files ADSM processed, including the file's modification date and time, management class, and operating system attributes (see the operating system manuals for an explanation of these attributes.) The transaction (**Txn**) column indicates the results of ADSM processing:

(B) Backup

The file was successfully backed up.

(F) Failure

The file was not backed up. If ADSM failed to back up a file, the reason for the failure is shown to the right of the file name. Select **List Failures** to see a list of the files that ADSM failed to back up.

(I) Inactive

The file was marked inactive on the server because it no longer exists on the workstation.

(R) Rebound

The file was successfully rebound to another management class.

(U) Update

The file's attributes were updated on the server.

Using the Include-Exclude List to Control Processing

Usually, there are files on your disk that you do not want to back up. These files might be operating system or application files that could be easily recovered by reinstalling the program, or any other file that you could easily rebuild.

You can use the INCLUDE and EXCLUDE options in the ADSM options file to tell ADSM which files to exclude from backup processing. ADSM honors the include-exclude list whether you are doing an incremental or selective backup. ADSM backs up any file that is not explicitly excluded. You do not need to use an INCLUDE option to include specific files unless those files are in a directory you are trying to exclude.

For more information on setting up an include-exclude list, see "Creating an Include-Exclude List" on page 69.

Incremental Backup: Advanced Considerations

This section discusses some advanced considerations for using incremental backup. You do not need to understand this information in order to use ADSM for basic work.

Starting an Incremental Backup with a Command: You can perform an incremental backup from the command line by using the INCREMENTAL command. For example, to back up the C: drive using IBM TCP/IP 2.1, issue:

```
dsmcibm incremental c:
```

If you do not indicate the drives you want backed up, ADSM uses your default domain (see "Setting Your Default Domain" on page 16). You can add drives to the default domain with the DOMAIN option. For example, if your default domain contains hard drives C: and D:, you can back up those drives plus the diskette in drive A: using:

```
dsmcibm incremental -domain="A:"
```

To start an incremental by date, add the INCRBYDATE option:

```
dsmcibm incremental -incrbydate
```

When the INCREMENTAL command completes, ADSM provides you with statistics similar to those shown in the GUI's Backup Status window. (Similar statistics are produced by the SELECTIVE and ARCHIVE commands. These also show up in the schedule log for scheduled commands.)

```
Total number of objects inspected: 4,048
Total number of objects backed up: 710
Total number of objects updated: 0
Total number of objects rebound: 0
Total number of objects deleted: 138
Total number of objects failed: 0
Total number of bytes transferred: 59.8 MB
Data transfer time: 258.56 sec
Data transfer rate: 237.05 KB/sec
Average file size: 86.3 KB
Compression percent reduction: 46.89%
Elapsed processing time: 0:09:40
```

Where:

Total number of objects inspected

The number of files and directories ADSM considered processing.

Total number of objects backed up

The number of files and directories backed up.

Total number of objects updated

The number of files or directories whose attributes were updated on the server, but were not backed up.

Total number of objects rebound

The number of files or directories whose management class changed.

Total number of objects deleted

The number of files or directories that were expired on the server because they no longer exist on the workstation.

Total number of objects failed

The number of files or directories that could not be backed up.

Total number of bytes transferred

The number of bytes sent to the server (after any compression processing).

Data transfer time

The time it took to transfer data, from the first byte sent to the last.

Data transfer rate

The average number of kilobytes sent per second.

Average file size

The average uncompressed size of the files sent to the server.

Compression percent reduction

The percentage ADSM was able to reduce the size of your files using compression.

Elapsed processing time

The time between starting and ending the command.

The specific DSMC command you use depends on the communication software that connects your client to the server. See Figure 51 on page 139 for a list of these commands. See “INCREMENTAL—Backing Up New and Changed Files” on page 157 for more information about the INCREMENTAL command.

Understanding How ADSM Uses Drive Labels: ADSM backs up drives based on the drive label, not the drive letter. If a drive has no label, ADSM cannot back it up. This use of drive labels allows you to do things like back up different diskettes from the A: drive.

Each drive label results in ADSM maintaining a separate drive for restore or retrieve in the Drive Information window. These labels become the names of *file spaces* on the ADSM server.

If you change the label of a drive you have already backed up, ADSM sees it as a new drive and does not relate it to your previous drive.

ADSM cannot back up drives that have drive aliases created with the DOS SUBST command. This applies to both the drive alias and the underlying physical drive, because the alias name and the physical drive label are the same. If you want to back up these drives, delete the aliases.

Because ADSM uses the labels to manage your backups and archives, you occasionally need to use those labels to find your data when using ADSM commands. For example, if you try to restore a file using `d:\projx\file.exe` as a file specification, ADSM substitutes the current label of your D: drive for the `d:`. For example, if your D: drive's label is `d-disk`, `d:\projx\file.exe` becomes `{d-disk}\projx\file.exe`, the label being enclosed in braces.

If the label of the D: drive does not match a file space name on the ADSM server, ADSM cannot find your files. A mismatch between a label and file space name might happen if you relabel your drives, or if you access ADSM from a different workstation than the one from which you backed up the files. If you have not relabeled the drive, and you are at the same workstation where the file was backed up, then you can use the drive letter as a short-hand version of the file space name (drive label).

Setting Your Default Domain: When you start ADSM, or use the INCREMENTAL command without indicating drives, ADSM automatically selects your default domain as the drives you want to process. This domain is set with the DOMAIN option in the options file (see "DOMAIN" on page 84). If you do not have the DOMAIN option set, the default domain is all local hard drives (the drives in your workstation) that have a drive label.

Understanding What ADSM Considers a Changed File: For full incrementals, ADSM considers a file to be changed if any of these items are different from the last backup taken:

- File size.
- Date or time of last modification.
- File attributes, except for the A attribute (the archive attribute). ADSM does not use the archive attribute because other programs change the attribute during file copying, even if the file has not changed. When you restore a file, ADSM restores the attributes to what they were when you backed up the file.

Understanding Which Files Are Backed Up: When you request an incremental backup, ADSM backs up a file if all of the following requirements are met:

- The file is not specified on an exclude statement in your include-exclude list. If you do not have an include-exclude list, all files are considered eligible for backup.
- The selected management class contains a backup copy group. See Chapter 5, "Automating ADSM Tasks" on page 45 for more information on management classes and backup copy groups.

- The file meets the serialization requirements defined in the backup copy group. If serialization is *static* or *shared static*, and the file is in use each time ADSM attempts to back it up, the file is not backed up.
- The file meets the mode requirements defined in the backup copy group. If the mode is *modified*, the file must have changed since the last backup. If the mode is *absolute*, the file can be backed up even if it has not changed.
- The file meets the frequency requirements defined in the backup copy group. The minimum number of days since the last backup must elapse before a file is backed up. (Frequency is ignored for partial incrementals.)

When you run an incremental backup, ADSM also backs up all directory information, except for empty directories, which are not backed up. You can exclude the files within a directory, but you cannot exclude a directory from being backed up. Directories are counted in the number of files backed up.

Understanding How Your Files Are Managed: ADSM uses *management classes* to determine how to manage your backups on the ADSM server. Every time you back up a file, the file is assigned a management class. The management class used is either a default chosen for you, or one you assigned to the file using the INCLUDE option in the include-exclude list. The chosen management class must contain a backup copy group in order for the file to be backed up. See Chapter 5, “Automating ADSM Tasks” on page 45 for more information on management classes and how to assign them to files.

Backing Up Opened Files: Some files on your system may be in use when you try backing them up (these are called *open files*, because they are opened by an application for its use). Because an open file may change, it is likely that any backup of an open file will not correctly reflect the contents of the file at a given time. (There is no problem, however, if the file is not changed during backup, even if it is open.)

If you find that certain files are not getting backed up because they are open and get changed when you try backing them up (or when the backup schedule starts), you need to consider your options:

- If the file is unimportant, or can be easily rebuilt (for example, a temporary file), you might not care that the file is not backed up.
- If the file is important:
 - You can ensure the file is closed before ADSM tries to back it up. If backups are run according to a schedule, use the PRESCHEDULECMD option to issue a command that closes the file. For example, if the open file is a database, use the database’s quiesce command to shut down the database. You can use the POSTSCHEDULECMD option to restart the application that uses the file after the backup completes. (See “POSTSCHEDULECMD” on page 103 and “PRESCHEDULECMD” on page 104 for more information.)

If you are not using a schedule for the backup, ensure that you close the application that uses the file before you start the backup.

- You can have ADSM back up the file even if it is open and gets changed during the backup. This is only useful if the file will be usable even if it changes during backup. To have ADSM back up these files, assign the files a management class with the serialization **dynamic** or **shared dynamic**. See “Choosing a Management Class for Files” on page 57 for information on assigning management classes, and “Displaying Information About Management Classes” on page 53 for information on determining which management classes are available to you.

Backing Up Specific Files or Directories

You can use ADSM to back up specific files, a group of files with similar names, or entire directories. This is called a *selective backup*.

You can choose the files you want to back up either by using a file specification (the path, name, and extension of the file) or by choosing the files or directories from a directory list.

Backing Up Specific Files Using File Specifications

To back up selected files using file specifications:

- 1** Choose which drives you want to back up from the **Drives for Backup/Archive** section of the Drive Information window by moving the cursor to the drive and pressing the space bar.
- 2** Select the **Backup** menu; **Backup by file specification** item (Figure 11).



Figure 11. Selecting Backup by File Specification from the Backup Menu

- 3** Fill in the path, name, and extension of the file you want to back up. You can use the standard wildcard characters to back up a set of similarly named files (wildcard characters are explained in “Using Wildcard Characters” on page 22). For example, Figure 12 on page 19 shows how to list all files with the **exe** extension.

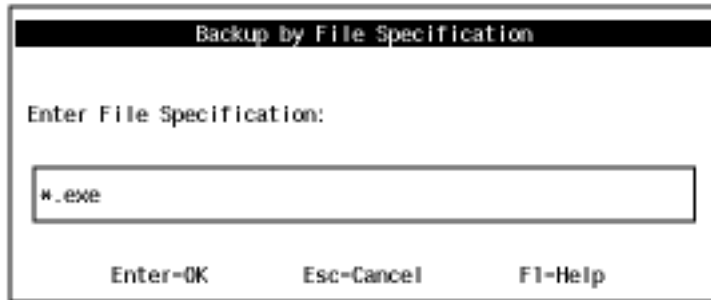

Figure 12. Entering a File Specification for Backup

- 4 Select **OK** to see the list of files that match your specification (Figure 13). Use the space bar to select the files you want from this list. (Press F4 to select all the files).

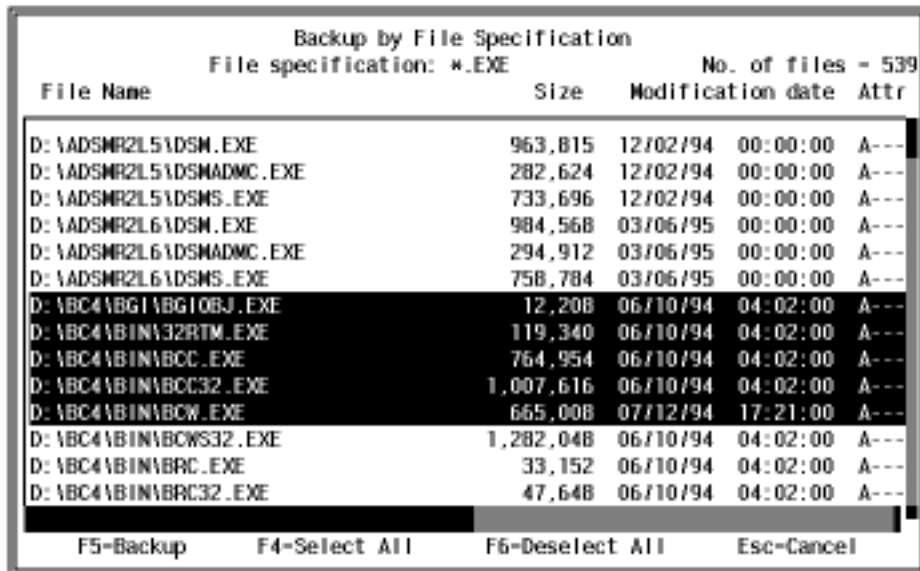

Figure 13. Choosing from the File Specification for Backup List

- 5 Press F5 to back up the selected files. The Backup Status window displays ADSM's processing. (See "Understanding the Backup Status Window" on page 12 for details.)

Backing Up Specific Files Using Directory Trees

To back up specific files or entire directories using directory trees:

1 Choose which drives you want to back up from the **Drives for Backup/Archive** section of the Drive Information window by using the space bar.

2 Select the **Backup** menu; **Backup by directory tree** item (Figure 14).

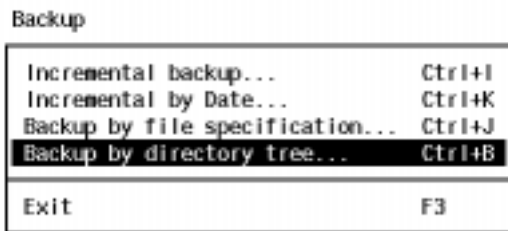

Figure 14. Selecting Backup by Directory Tree from the Backup Menu

3 Select the files and directories you want to back up:

- To select or deselect all the files in a directory, position the cursor on the directory and press Ctrl+Enter. When all the files in a directory are selected, the letter **F** is displayed to the left of the directory name. Selecting a directory does not select the directory's subdirectories.
- To select or deselect some of the files in a directory, position the cursor on the directory and press Enter. Then select or deselect files from the list that displays on the right side of the window using the space bar on the file name. When some of the files in a directory are selected, the letter **P** is displayed to the left of the directory name.

If ADSM does not let you select a file or directory, it is because your include-exclude list excludes them from backup.

To see a list of the files you selected, press F4. (You can deselect files from this list.)

Figure 15 on page 21 shows an example of full and partial directory selections.

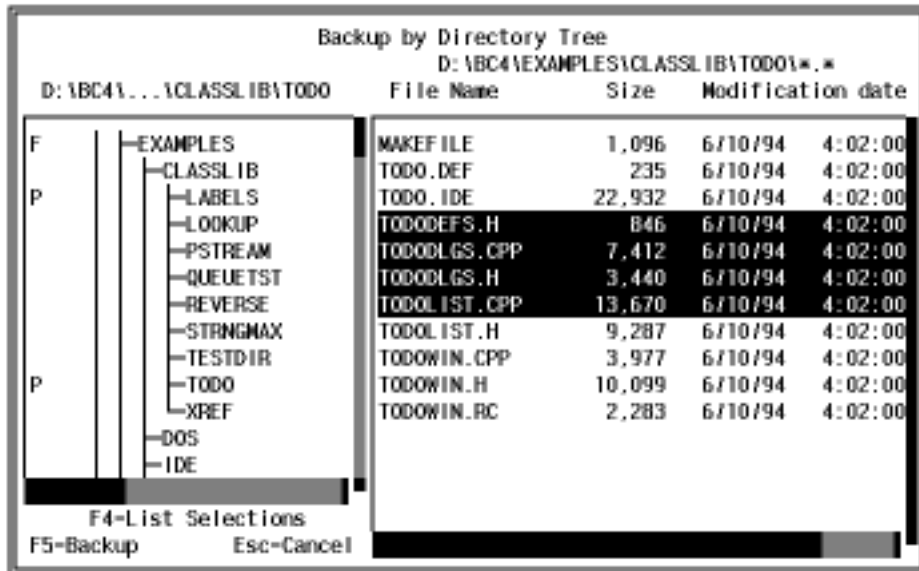

Figure 15. Selecting Files and Directories

- 4 Press F5 to back up the selected files and directories. The Backup Status window displays ADSM's processing. (See "Understanding the Backup Status Window" on page 12 for details.)

Selective Backup: Advanced Considerations

This section discusses some advanced considerations for using selective backup. You do not need to understand this information in order to use ADSM for basic work.

Backing Up Specific Files Using Commands: You can use the **SELECTIVE** command to back up specific files. Use wildcards to back up more than one file at a time. If you back up a directory, you can use the **SUBDIR=YES** option to include all the subdirectories under that directory in the backup.

For example, to back up the **d:\proj** directory and its subdirectories, use:

```
selective d:\proj -subdir=yes
```

You can use more than one file specification on the **SELECTIVE** command. For example, to back up the **a:\h1.doc** and **a:\test.doc** files, use:

```
selective a:\h1.doc a:\test.doc
```

See "Starting an Incremental Backup with a Command" on page 14 for an explanation of the statistics that ADSM provides after processing an **INCREMENTAL**, **SELECTIVE**, or **ARCHIVE** command.

For more information, see "SELECTIVE—Backing Up Selected Files" on page 197.

Using Wildcard Characters: You can use the operating system's wildcard characters in file specifications with ADSM, including on ADSM commands, for most ADSM tasks. These characters allow you to select groups of files that have similar names.

In a command, wildcard characters can only be used in the file name or extension. They cannot be used to specify destination files, drives, or directories.

The DOS wildcard characters are:

- * Asterisk. This stands for zero or more characters. If you include any other characters after the asterisk, these characters are ignored. For example:
 - *.exe matches all files that have the extension **exe**
 - hm*. * matches all files that start with **hm**, regardless of extension
 - *h*. * matches all files with an **h** somewhere in the file name, regardless of extension
- ? Question mark. This stands for one character. For example:
 - ?**exe** matches all files with the extension **exe** that have one, and only one, character in their file name
 - hm?**exe** matches all files that have three-character names beginning with **hm** and that have an **exe** extension

You can combine the asterisk and question mark in a file specification. For example, **??hm.*** matches all four-character file names ending in **hm**, no matter what extension they have.

Sorting File Lists: You can sort lists of files in ADSM using the **Sort by** items in the **View** menu (Figure 16). You can sort any list of files, whether you are backing up, restoring, archiving, or retrieving them.



Figure 16. View Menu, Sorting Items

You can sort files by directory name, file name, file type (extension), file size, and last modification date.

Sorting files by last modification date is especially useful if you are trying to recover files to their state as of a particular date.

Understanding Which Files Are Backed Up: When you request a selective backup, ADSM backs up a file if all of the following requirements are met:

- The file is not specified on an exclude statement in your include-exclude list. If you do not have an include-exclude list, all files are considered for backup.
- The selected management class contains a backup copy group.
- The file meets the serialization requirements defined in the backup copy group. If serialization is *static* or *shared static*, and the file is in use each time ADSM attempts to back it up, the file is not backed up.

When you run a selective backup, ADSM also backs up all directory information. You can exclude the files within a directory, but you cannot exclude a directory from being backed up. Directories are counted in the number of files backed up.

Restoring Files or Directories

You can use ADSM to restore backup versions of specific files or a group of files with similar names, or entire directories.

You can choose the files you want to restore by any of the following methods:

- Use a file specification (the path, name, and extension of the file)
- Choose the files or directories from a directory list
- Use a subdirectory path to restore a directory and its subdirectories

Do You Want To Restore an Active or Inactive Backup?

Your administrator determines how many backup versions ADSM maintains for each file on your workstation. Frequently, the administrator has ADSM maintain more than one version of each file. Having multiple versions of a file allows you to restore older versions in case the most recent backup is damaged.

ADSM considers the most recent backup version to be the *active* version. Any other backup version is considered an *inactive* version.

Every time ADSM backs up your files, it marks the new backup version as the active backup, and it changes what used to be the active backup to an inactive backup. When the maximum number of inactive versions is reached, ADSM deletes the oldest inactive version.

If you want to restore a backup version that is inactive, you need to tell ADSM to show both active and inactive versions. Do this by selecting the **View** menu; **Show active and inactive files** item. You can change back to showing only active versions by selecting **Show active files only** from the same menu.

If you try to restore both an active and inactive version of a file at the same time, only the active version is restored.

Restoring Files Using a File Specification

If you know the name of the file you want to restore, or you know at least part of the name, you can use the name to restore the file. Restoring a file using a file specification is much like backing one up. The windows are similar, except you are choosing files to restore rather than to back up. To restore a file by its file specification:

- 1** Choose the drives that contain the backups from the **Drives for Restore/Retrieve** section of the Drive Information window using the space bar.
- 2** Select the **Restore** menu; **Restore by file specification** item (Figure 17).

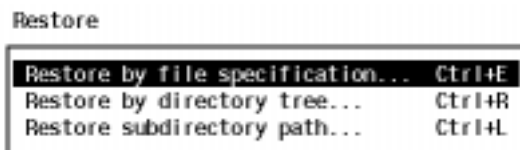

Figure 17. Selecting Restore by File Specification from the Restore Menu

- 3** Fill in the name of the file you are restoring. You can use the standard wildcard characters to restore a set of similarly named files (wildcard characters are explained in "Using Wildcard Characters" on page 22). The Restore by File Specification window is similar to the one for backup shown in Figure 12 on page 19.
- 4** Select **OK** to see the list of files that match your specification (this list is similar to the one for backup shown in Figure 13 on page 19). Use the space bar to select the files you want from this list. (Press F4 to select all the files).
- 5** Press F5 and fill in the Restore Parameters window (Figure 18 on page 25).

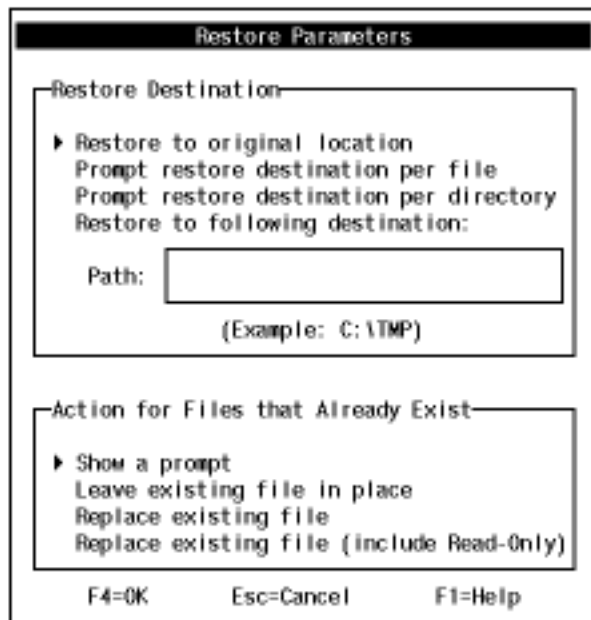

Figure 18. Choosing Restore Parameters

The restore parameters are:

- **Restore destination.** You can choose where you want to restore each file:
 - **Restore to original location** restores each file to the drive and directory from which they were backed up.
 - **Prompt restore destination per file** lets you choose a location for each file as it is restored.
 - **Prompt restore destination per directory** lets you choose a location for each directory of files as the directories are restored.
 - **Restore to following destination** lets you indicate the path to which all files are to be restored.
- **Action for files that already exist.** If you are restoring files that still reside on your disks, you need to tell ADSM how to handle them. You can choose:
 - **Show a prompt:** Have ADSM ask you if you want to overwrite the existing file as each file is restored.
 - **Leave existing file in place:** Have ADSM bypass any files that are already on your disk.
 - **Replace existing file:** Have ADSM overwrite existing files without first asking your permission, unless the existing file is read-only.

- **Replace existing file (include Read-Only):** Have ADSM overwrite existing files, including read-only files, without first asking your permission.

6 Press F4 to restore the files. The Restore Status window (similar to the one for backup; see “Understanding the Backup Status Window” on page 12 for details) displays ADSM’s processing. The transaction field (**Txn**) contains **(R)** if the file is restored, **(F)** if the restore fails.

Restoring Files Using a Directory Tree

You can use a directory tree to choose the files you want to restore. Restoring a file using a directory tree is much like backing one up. The windows are the same, except you are choosing files to restore rather than to back up. To restore a file using a directory tree:

- 1** Choose the drives that contain the backups from the **Drives for Restore/Retrieve** section of the Drive Information window using the space bar.
- 2** Select the **Restore** menu; **Restore by directory tree** item (Figure 19).

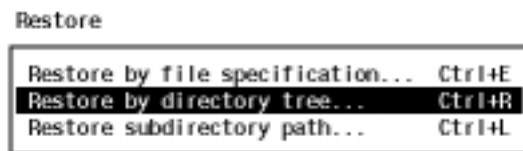

Figure 19. Selecting Restore by Directory Tree from the Restore Menu

- 3** Select the directories and files you want to restore from the Restore by Directory Tree window.
- 4** Press F5 and fill in the Restore Parameters window (Figure 18 on page 25).
- 5** Press F4 to restore the files.

Restoring Files Using a Subdirectory Path

If you want to restore a directory and all of its subdirectories and files, and you know the name of the directory you want to restore, you can use restore by subdirectory path.

To restore a directory and its subdirectories:

- 1** Choose the drives that contain the backups from the **Drives for Restore/Retrieve** section of the Drive Information window using the space bar.

- 2 Select the **Restore** menu; **Restore subdirectory path** item (Figure 20 on page 27).

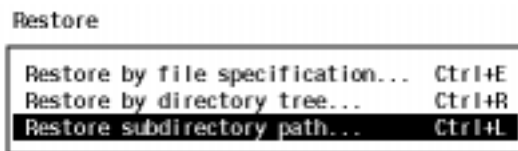

Figure 20. Selecting Restore Subdirectory Path from the Restore Menu

- 3 Fill in the Restore Subdirectory Path window:
 - a. **Enter source path to fully restore:** This is the directory you are trying to restore. Do not include the drive letter. For example, to restore the **work** directory on your C: drive, only specify **work**. To restore the entire drive, use ****.
 - b. **Enter destination path to fully restore to:** This is the drive and directory to which you want the restored files written. You must fill in this field, and it must indicate the target drive. For example, to restore to the **work** directory on your C: drive, specify **c:\work**. To restore to the root directory of the C: drive (for example, when restoring the entire drive), use **c:**.
You can restore the directory to a directory of a different name.
 - c. **Action for files that already exist:** If you are restoring files that still reside on your disks, you need to tell ADSM how to handle them.

- 4 Select **OK** to restore the files in the directory and its subdirectories.

Restoring Files: Advanced Considerations

This section discusses some advanced considerations for restoring data. You do not need to understand this information in order to use ADSM for basic work.

Restoring Files Using Commands

You can use the RESTORE command to restore files. Indicate the file you want restored and where you want to restore it. If you do not indicate a destination, the files are restored to their original location.

For example, to restore the **c:\doc\h1.doc** file to its original directory, use:

```
restore c:\doc\h1.doc
```

To restore it under a new name, use:

```
restore c:\doc\h1.doc c:\doc\h2.doc
```

If the file you are restoring no longer resides on your workstation, and you have run an incremental backup since deleting the file, there is no active backup of the file on the server. In this case, you need to use the LATEST option to tell the server to restore the most recent backup version. If you do not want the most recent version, use the PICK and INACTIVE options to get a list of backups from which you can pick.

For example, if you want to restore the latest version of the deleted file **c:\doc\h1.doc**, use:

```
restore c:\doc\h1.doc -latest
```

If you are restoring a file to a disk that has a different label than the disk from which the file was backed up, you must use the file space name (label) of the backup disk instead of the drive letter. For example, if you backed up a file from the A: drive from the diskette **workathome**, and you are restoring it to a diskette in the A: drive labeled **extra**, use:

```
restore {workathome}\doc\h1.doc a:\doc\h1.doc
```

Add the **-SUBDIR=YES** option to the command if you need to restore the files in a directory and all of its subdirectories. For example, if you are recovering an entire disk (the E: disk, in this example), you can restore all the files using:

```
restore e:\*.* -subdir=yes
```

See “RESTORE—Restoring Backup Versions” on page 181 for more information.

Authorizing Another User to Restore or Retrieve Your Files

You can authorize a user on another node to restore your backup versions or retrieve your archive copies. This allows you to share files with other people or with other workstations that you use with a different ADSM node name.

To authorize another node to restore or retrieve your files:

- 1** Select the **Utilities** menu; **Set authorization** item. ADSM shows you a list of nodes that you have authorized. The list might be empty. (See Figure 21 on page 29).

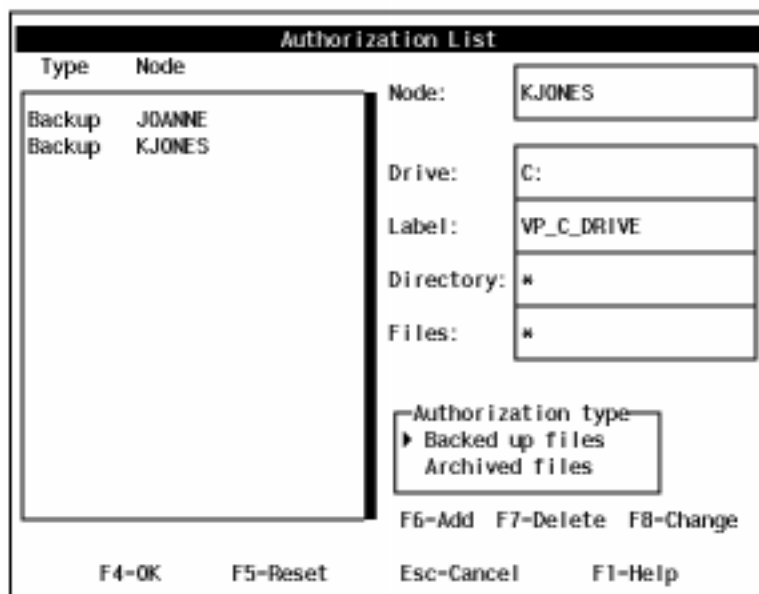

Figure 21. The Authorization List Window

- 2 Fill in the Authorization List window with the name of the node, the directory and file specification you want the user to have access to, and either the drive letter or drive label on which the files reside. You can give the node access to backups or archives. You must add separate authorizations for backup and archive access, even if you want to give the same node access to the same files for both.

You can authorize all users by using an asterisk (*) for the node name.

- 3 Press F6 in the Authorization List window to add the user.
- 4 Press F4 to add the node to the authorization list. The node is not added until you do this. While you are in the Authorization List window, you can add several nodes at once, delete nodes, or change your existing authorizations. All additions, deletions, and changes are processed when you select **OK**. If you make a mistake, select **Reset** (F5) to leave the authorization list and start again.

You can also work with your authorization list using the SET ACCESS command. Use the QUERY ACCESS command to see your current list, and DELETE ACCESS to delete users from the list.

For more information on the commands, see:

- “SET ACCESS—Granting Access to Files” on page 200
- “QUERY ACCESS—Displaying File Access Information” on page 163

- “DELETE ACCESS—Deleting Access to Files” on page 149

Restoring or Retrieving Another User's Files

After users grant you access to their files on the server, you can restore or retrieve those files by selecting the **Utilities** menu; **Display drives for node** item. Enter the name of the node you want to access and select **OK**.

The other node's file spaces are then displayed in the **Drives for Restore/Retrieve** section of the Drive Information window, and you can restore or retrieve files from them the same way you would your own files.

If you are using commands, use the FROMNODE option to indicate the node. You must also use the file space name, rather than the drive letter, to select the restore-retrieve drive you want access to. Enclose the file space name in braces and use it like a drive letter.

For example, to restore Cougar's files from the **projx** directory on the **d-disk** file space, to your own **projx** directory, enter:

```
restore -FROMNode=cougar {d-disk}\projx\* d:\projx\
```

Use the QUERY FILESPACE command to get a list of file spaces (see “QUERY FILESPACE—Displaying a List of File Spaces” on page 175). For example, to get a list of Cougar's file spaces, use:

```
query filespace -FROMNode=cougar
```

For more information about using the FROMNODE option with the RESTORE command, see “RESTORE—Restoring Backup Versions” on page 181. See “RETRIEVE—Retrieving Files from Archive” on page 189 for the RETRIEVE command.

Restoring or Retrieving Your Files to Another Workstation

ADSM lets you restore or retrieve files you back up from your own workstation when you are using a different workstation. You just need to tell ADSM your node name, because your backups and archives are stored according to your node, not your specific machine. Your ADSM password protects your data.

To restore or retrieve files to another workstation, use the NODENAME option to specify the node name of the workstation from which you backed up the files. You can either use the NODENAME option when starting ADSM or update the options file on the machine. (Use the NODENAME option when starting ADSM if you are borrowing someone else's machine so you do not change their configuration).

For example, if your node name is cougar, and you are using IBM TCP/IP 2.1 use:

```
dsmibm -nodename=cougar
```

You can then restore or retrieve files as if you were working on your original workstation.

You can use NODENAME on ADSM commands too. For example, you can restore your **projx** files using:

```
restore -nodename=cougar {d-disk}\projx\*.*
```

If you do not want to restore or retrieve the files to the same directory name on the alternate workstation, enter a different destination.

Restoring or Retrieving Files to Another Type of Workstation

Because the file formats used on DOS, Windows 3.1, Windows NT, and OS/2 are compatible, you can restore or retrieve files from one type of system to one of the other types of system. This is called *cross-client restore*.

For example, if you archive a file from an OS/2 workstation, you can retrieve that file to a DOS, Windows 3.1, Windows NT, or OS/2 workstation. (You must have the appropriate permissions to access the file spaces of the other workstation, as explained in “Authorizing Another User to Restore or Retrieve Your Files” on page 28 and “Restoring or Retrieving Another User’s Files” on page 30)

Because OS/2 and Windows NT support file names and file systems not available on DOS and Windows 3.1, there are some restrictions to cross-client restore:

Viewing other file system types

DOS and Windows 3.1 only support the FAT file system. By default, a DOS user only sees FAT drives when looking at another node’s restore/retrieve drives, whereas a Windows 3.1 user will see all types of drives.

You can see non-FAT drives if you include this option in the options file:

```
FSTYPES *
```

You can also use FSTYPES to choose which types of drives you want to see. For example, on Windows 3.1, you can limit your list to only FAT drives by including this in the options file:

```
FSTYPES FAT RMT-FAT
```

Windows NT and OS/2 clients automatically show all other file system types (FSTYPES cannot be used on these systems).

Restoring or retrieving from unsupported file systems

These clients support the following file systems:

- DOS and Windows 3.1: FAT
- OS/2: FAT, HPFS
- Windows NT: FAT, HPFS, NTFS

Although each client can recover data from each of these file systems, some restrictions apply when recovering files that were backed up or archived from a drive that the client does not support:

NTFS drives

DOS, Windows 3.1, and OS/2 clients can recover the files, but special NT attributes are not recovered, such as security and ACL attributes.

Windows NT clients can recover NTFS files with no restrictions.

HPFS drives

DOS, Windows 3.1, and Windows NT clients can recover the files, but HPFS extended attributes (EA data) are not recovered.

OS/2 clients can recover HPFS files with no restrictions.

FAT drives

DOS, Windows 3.1, Windows NT, and OS/2 clients can recover the files with no restrictions.

Long file names

HPFS and NTFS drives allow file and directory names that are longer than those allowed on FAT drives. If you are recovering files with long file names to a FAT drive, you should always specify a destination file specification for each file. This ensures you get the name you want.

On Windows NT, if you do not specify a name, ADSM truncates the name to fit the FAT restrictions. Errors might occur if the source directory name is long. On OS/2, you cannot restore a file with a long name to a FAT drive unless you specify an appropriate FAT file name.

When you use the OS/2 or Windows NT client to recover files with long names to an HPFS or NTFS disk, the long names are preserved, even if you are recovering the file to a different type of drive than the source drive (for example, NTFS to HPFS).

The considerations for retrieving files are the same as for restoring them.

Restoring a Disk In Case of Disk Loss

ADSM can only recover your files if you can run the ADSM client. If the disk that contains the client is lost (from theft or hardware failure, for example), you must reinstall the client before you can recover your files. If you also lose the disk that contains the operating system and communication software, you must recover them before you can connect to the ADSM server.

To protect yourself against these kinds of losses, you need to put together a set of diskettes that you can use to restore your system to a state that permits you to contact the ADSM server and begin recovering data. These diskettes should contain:

1. A bootable operating system that will allow you to perform basic functions.
2. A correctly configured communication program that will allow you to establish communications with the ADSM server.
3. An ADSM client with an appropriately customized options file. The ADSM command-line client is sufficient for this.

The exact files you need differ depending on the communication package you use. Consult your operating system and communication software manuals for help in setting up these diskettes.

Deleting File Spaces

If your ADSM administrator gives you backdelete authority, you can delete entire file spaces from the server. When you delete a file space, you delete all the files, both backup versions and archive copies, that are contained within the file space. For example, if you delete the file space for your C: drive, you are deleting every backup for every file on that disk, and every file you archived from that disk.

Carefully consider what you are doing before you attempt to delete a file space.

You cannot delete individual backup versions kept on the ADSM server.

If you decide you do not need the file space, delete it by selecting the **Utilities** menu; **Delete restore/retrieve drives** item (Figure 22).

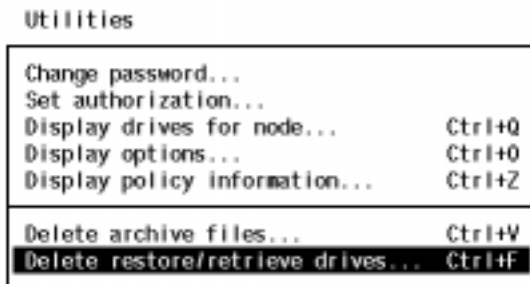

Figure 22. Deleting a File Space

You can also delete a file space using the DELETE FILESPACE command.

Chapter 4. Archiving and Retrieving Files

Archiving and retrieving files is similar to backing up and restoring files. Many of the windows and concepts are similar. In this chapter, we cover the main archive and retrieve tasks, but where windows and concepts are the same as for backup and restore, we direct you to sections within Chapter 3, "Backing Up and Restoring Files" on page 9.

See "Do You Want to Back Up or Archive Files?" on page 9 for a discussion of the difference between backups and archives.

Archiving Files

To archive files, you need to specifically select the files to archive. You can select the files by using a file specification or by choosing them from a directory tree.

Your administrator might have set up schedules to automatically archive certain files on your workstation. See Chapter 5, "Automating ADSM Tasks" on page 45 for information on checking and running the schedules available to you. The following sections cover how to archive files without using a schedule.

Archiving Files Using a File Specification

To archive a file using file specifications:

- 1 Choose which drives contain the files to be archived from the **Drives for Backup/Archive** section of the Drive Information window using the space bar.
- 2 Select the **Archive** menu; **Archive by file specification** item (Figure 23).

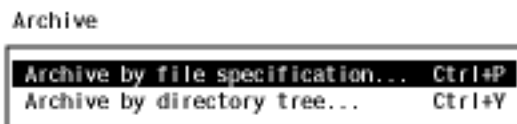

Figure 23. Selecting Archive by File Specification from the Archive Menu

- 3 Fill in the path, name, and extension of the file you want to archive, just as you would do when backing up a file. You can use the standard wildcard characters to archive a set of similarly named files (wildcard characters are explained in "Using Wildcard Characters" on page 22).
- 4 Select **OK** to see the list of files that match your specification. Use the space bar to select the files you want from this list. (Press F4 to select all the files).

5 Press F5 to start archiving the selected files.

6 Fill in the Archive Options window (Figure 24).

Management Class	
STANDARD	365 day(s)
STANDARD	365 day(s)

Figure 24. Archive Options Window

The archive options are:

File to be archived:

This is the name of the file ADSM is archiving. The options you set apply to this file.

Enter description

This is the description you want to keep with the archive copy.

Management class

This section allows you to choose the management class you want assigned to the file (see “Using Storage Management Policies” on page 51 for more information about management classes). Choose a management class using the space bar. ADSM shows how long archives are kept according to the policy defined for each management class.

Prompt

With **Prompt**, you can choose to display the Archive Options window for each file before it is archived, or you can use the current options you have set for all the files remaining to be archived.

You might want to use the same description for a group of files if you are archiving them for the same purpose.

7 Select **OK** to archive the files.

The Archive Status window that is shown is similar to the Backup Status window (see “Understanding the Backup Status Window” on page 12 for details). The transaction field (**Txn**) contains **(A)** for successfully archived files, **(A/D)** for successfully archived files that were deleted from your workstation, and **(F)** for failures. If there are any failures, you can select **List Failures** to see a list of them.

Archiving Files Using a Directory Tree

To archive files using a directory tree:

- 1** Choose which drives contain the files to be archived from the **Drives for Backup/Archive** section of the Drive Information window using the space bar.
- 2** Select the **Archive** menu; **Archive by directory tree** item (Figure 25).

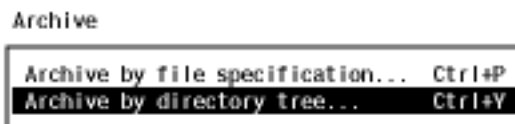

Figure 25. Selecting Archive by Directory Tree from the Archive Menu

- 3** Select the files and directories you want to archive in the same way you would choose them for backup:
 - To select or deselect all the files in a directory, position your cursor on the directory name and press Ctrl+Enter. When all the files in a directory are selected, the letter **F** is displayed to the left of the directory name. Selecting a directory does not select the directory's subdirectories.
 - To select or deselect some of the files in a directory, position the cursor on the directory and press Enter. Then select or deselect files from the list that displays on the right side of the window using the space bar on the file name. When some of the files in a directory are selected, the letter **P** is displayed to the left of the directory name.

To see a list of the files you selected, press F4. (You can deselect files from this list.)

4 Press F5 to start archiving the selected files.

5 Fill in the Archive Options window (see Figure 24 on page 36).

6 Select **OK** to archive the files.

The Archive Status window that is shown is similar to the Backup Status window (see “Understanding the Backup Status Window” on page 12 for details).

Archiving Files: Advanced Considerations

This section discusses some advanced considerations for archiving files. You do not need to understand this information in order to use ADSM for basic work.

Archiving Files Using Commands

You can use the ARCHIVE command to archive files. Use wildcards to archive more than one file at a time. If you archive a directory of files, you can use the SUBDIR=YES option to include all the subdirectories under that directory in the archive.

For example, to archive the files in the **d:\proj** directory and the files in its subdirectories, use:

```
archive d:\proj -subdir=yes
```

You can use more than one file specification on the ARCHIVE command. For example, to archive the **a:\h1.doc** and **a:\test.doc** files, use:

```
archive a:\h1.doc a:\test.doc
```

Use the description option to assign a description to the archive:

```
archive a:\h1.doc -description="Chapter 1, first version"
```

See “Starting an Incremental Backup with a Command” on page 14 for an explanation of the statistics that ADSM provides after processing an INCREMENTAL, SELECTIVE, or ARCHIVE command.

See “ARCHIVE—Archiving Files” on page 146 for more information.

Deleting Archived Files

You can delete archives if you decide you no longer need them. Unlike backup versions, you can delete individual archives without deleting the entire file space.

To delete an archive copy:

- 1 Choose which drives contain the files to be deleted from the **Drives for Restore/Retrieve** section of the Drive Information window using the space bar.
- 2 Select the **Utilities** menu; **Delete archive files** item (Figure 26 on page 39).

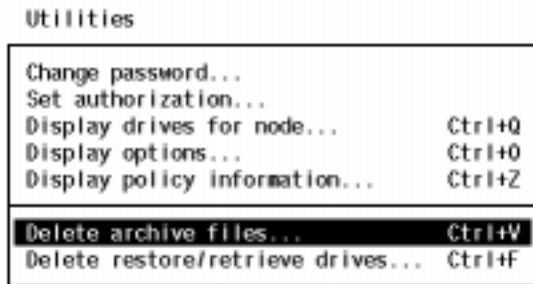

Figure 26. Selecting Delete Archive Files from the Utilities Menu

3 Fill in the Archive Delete Scope window (Figure 27).

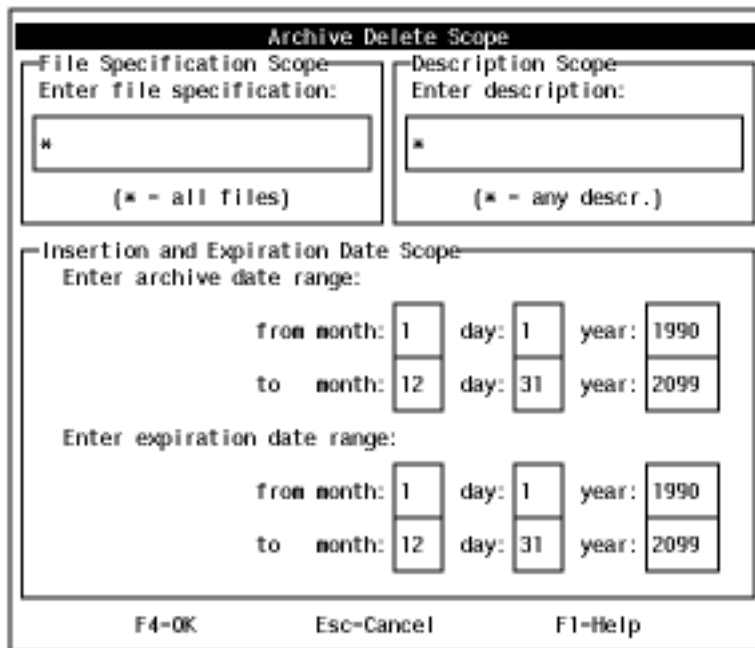

Figure 27. Archive Delete Scope Window

The Archive Delete Scope window allows you to build a list of archive copies. You can list all of your archives, or limit the list as much as you want, even to listing the exact file you want to delete, if you know the file's name.

The fields in this window are:

File Specification Scope

This is the path, name, and extension of the file you want to delete. You can use wildcard characters to list similarly named files.

Description Scope

This is the description you gave the file when you archived it. You can use wildcard characters to list files with similar descriptions. The description is case-sensitive.

Insertion and Expiration Date Scope

These are the date ranges for when you archived the file and when the archive copy is set to expire (set to be deleted automatically on the server).

You can limit the list of files by using short date ranges, or, if you cannot remember when you archived the files, you can set a long range to ensure you find the archives you are looking for.

4 Press F4 to get a list of the files that meet the parameters you set in the Archive Delete Scope window.

5 Use the space bar to select the files you want to delete in the Delete by File Specification window (Figure 28).

File Name	Size	Modification date	Attr
A:\DOS01.CLP	3,894	05/03/95 10:26:14	A---
A:\DOS01.TXT	1,859	05/05/95 16:52:24	A---
A:\DOS03.CLP	1,014	05/03/95 10:29:54	A---
A:\DOS04.CLP	694	05/03/95 10:59:50	A---
A:\DOS05.CLP	3,510	05/03/95 11:10:48	A---
A:\DOS06.CLP	1,718	05/03/95 11:14:06	A---
A:\DOS09.CLP	1,078	05/08/95 13:44:08	A---
A:\DOS10.CLP	758	05/08/95 13:45:18	A---

Figure 28. Delete by File Specification Window

6 Select **Delete** (F5) to delete the files. The Archive Delete Status window shows the results of your action. An **(I)** in the transaction field (**Txn**) indicates that the file is deleted; and **(F)** indicates failure.

If you are using commands, you can delete archive copies with the DELETE ARCHIVE command. You might need to use the file space name (drive label) to delete the

correct file rather than the drive letter, if you archived the file from a drive whose label has changed.

For example, to delete the file **a:\edit*.exe** when the A: drive does not contain the diskette from which the file was archived, use:

```
delete archive {edita}\edit\*.exe
```

In this example, **edita** is the drive label from the diskette.

Retrieving Archived Files

You *retrieve* a file when you want to return an archive copy from the ADSM server to your workstation.

Retrieving Files

To retrieve an archived file:

- 1** Choose the drives that contain the archives from the **Drives for Restore/Retrieve** section of the Drive Information window using the space bar.
- 2** Select the **Retrieve** menu; **Retrieve by file specification** item (Figure 29).

reTrieve

A screenshot of a menu titled "reTrieve". The menu item "Retrieve by file specification..." is highlighted with a black rectangular box. To the right of the menu item, the keyboard shortcut "Ctrl+G" is visible.

Figure 29. Selecting Retrieve by File Specification from the Retrieve Menu

- 3** Fill in the Retrieve Scope window. This window is similar to the Archive Delete Scope window shown in “Deleting Archived Files” on page 38. You can get a list of archived files using the file name, description, archive date, and expiration date for the file.
- 4** Select **OK** to get a list of files.
- 5** Use the space bar to select the files you want to retrieve in the Retrieve by File Specification window (similar to Figure 28 on page 40).
- 6** Press F5 to retrieve the files.
- 7** Fill in the Retrieve Parameters window. This is similar to the Restore Parameters window shown in Figure 18 on page 25. You select where to retrieve the files and what to do if a file is already at the destination.

- 8 Press F5 to retrieve the files. The Retrieve Status window shows the results of your action. An **(R)** in the transaction field (**Txn**) indicates that the file is retrieved; and **(F)** indicates failure.

Retrieving Files: Advanced Considerations

This section discusses some advanced considerations for retrieving files. You do not need to understand this information in order to use ADSM for basic work.

Retrieving Files Using Commands

You can use the RETRIEVE command to retrieve files. Indicate the file you want retrieved and a destination. If you do not indicate a destination, the files are retrieved to their original location.

For example, to retrieve the **c:\doc\h1.doc** file to its original directory, use:

```
retrieve c:\doc\h1.doc
```

To retrieve it under a new name, use:

```
retrieve c:\doc\h1.doc c:\doc\h2.doc
```

You can use the PICK option to get a list of archives from which you can pick files.

If you are retrieving a file to a disk that has a different label than the disk from which the file was archived, you must use the file space name (label) of the archive disk instead of the drive letter. For example, if you archived a file from the A: drive from the diskette **workathome**, and you are retrieving it to a diskette in the A: drive labeled **extra**, use:

```
retrieve {workathome}\doc\h1.doc a:\doc\h1.doc
```

See “RETRIEVE—Retrieving Files from Archive” on page 189 for more information.

Understanding the Similarities between Retrieve and Restore

Many of the advanced considerations for retrieving files are the same as they are for restoring files. See these sections for more information:

- “Authorizing Another User to Restore or Retrieve Your Files” on page 28
- “Restoring or Retrieving Another User’s Files” on page 30
- “Restoring or Retrieving Your Files to Another Workstation” on page 30
- “Restoring or Retrieving Files to Another Type of Workstation” on page 31

Understanding How Your Archives Are Managed

As with backing up files, ADSM checks the INCLUDE options in your include-exclude list to determine which management class to assign to your archived files. If you do not specifically assign a management class to a file with an INCLUDE option, ADSM assigns the file the default management class.

ADSM can only archive a file if the selected management class contains an archive copy group.

For information on the various management class attributes used to manage your archives, see “Displaying Information About Management Classes” on page 53. For information on assigning management classes, see “Using Management Classes with INCLUDE” on page 74.

Chapter 5. Automating ADSM Tasks

One of the best ways to use ADSM is to automate the tasks you want done on a regular basis. Your ADSM administrator has probably set up some ADSM processes that you can use to do this. For example, ADSM can back up files at the end of each day automatically. Or, it can archive some of your files every Friday.

Central scheduling is a procedure your administrator defines to automatically process ADSM tasks. You start the *client scheduler* on your workstation, which connects you to the server's schedule.

Whereas you can use central scheduling to actually perform your tasks automatically, you can use *storage management policies* to tell ADSM how to manage your backups and archives on the ADSM server. Your ADSM administrator defines these policies, and you associate your data with them. Then, when your data is backed up or archived, it is managed according to the criteria set by the policy.

Using Central Scheduling

An ADSM administrator can set up schedules to perform ADSM tasks automatically. Central scheduling is a cooperative effort between the server and your client node. An ADSM administrator sets up central scheduling on the server, and you are responsible for starting the client scheduler on your node. After you start the client scheduler, no further intervention is necessary.

You must have the ADSM command-line client installed in order to use the central scheduler. You cannot start the scheduler from the ADSM graphical user interface.

You can also:

- Display information about available schedules
- Display information about work that the schedule has completed
- Modify scheduling options in the client options file, if necessary

Starting the Client Scheduler

You must start the client scheduler on your client node to use the server's schedule. To start the client scheduler, issue the SCHEDULE command as follows (if you are using IBM TCP/IP 2.1):

```
dsmcibm schedule
```

When you start the client scheduler, it runs continuously until you stop the process by pressing Ctrl+Break, reboot, or turn off your machine. (Ctrl+Break does not work with all combinations of schedule mode and communication software, however. If it does not work for you, you must reboot or turn off your machine.)

Displaying Information About Scheduled Work

To see what schedules are defined for your client node, use the QUERY SCHEDULE command:

```
query schedule
```

ADSM displays detailed information about all scheduled work for your client node.

Figure 30 shows sample QUERY SCHEDULE output.

```
Schedule Name: DAILY_INC
Description: Daily System-wide backup
Action: Incremental
Options: QUIET
Objects:
Priority: 1
Next Execution: 30 minutes
Duration: 4 Hours
Period: 1 Day
Day of Week: Any
Expire: Never

Schedule Name: WEEKLY_INC
Description: Weekly backup for project files
Action: Incremental
Options: QUIET
Objects: e: f:
Priority: 1
Next Execution: 60 minutes
Duration: 8 Hours
Period: 7 Days
Day of Week: Friday
Expire: Never
```

Figure 30. Sample QUERY SCHEDULE output

The schedule named DAILY_INC starts an incremental backup every day. The next incremental backup is due to start in 30 minutes. Because no objects are listed, ADSM runs the incremental backup on your default domain. The schedule has no expiration date.

The schedule named WEEKLY_INC starts an incremental backup on the E: and F: drives every Friday.

The QUERY SCHEDULE output shows the following details about schedules:

Schedule Name

The name the administrator has given to the schedule.

Description

A description of the schedule.

Action

The type of task to perform:

- Incremental—The schedule performs an incremental backup of the drives listed in the **Objects** field or those listed on the DOMAIN option in the options file.
- Selective—The schedule backs up the files listed in the **Objects** field.

- Archive—The schedule archives the files listed in the **Objects** field.
- Restore—The schedule restores the files listed in the **Objects** field.
- Retrieve—The schedule retrieves the files listed in the **Objects** field.
- Command—The schedule runs the command shown in the **Objects** field.
- Macro—The schedule runs the macro listed in the **Objects** field.

Options

Override options that you have set in the client options file for scheduling. See “Specifying Scheduling Options” on page 48 for more information about scheduling options.

Objects

The drives or files to be processed, or the command to be executed. If drives are not listed for an incremental backup, then ADSM uses the default domain.

Priority

The priority of the schedule if there is more than one schedule for the same client node starting at the same period of time. The server runs the schedule with the highest priority first. For example, a schedule with a priority of 1 is started before a priority 3 schedule.

Next Execution

When the schedule runs next.

Duration

The maximum amount of time after the server has started the schedule that you can begin your client scheduler. For example, if the duration is 4 hours, then you can start your client scheduler up to 4 hours after the server starts the schedule.

Period

How often the schedule runs. A period of 12 hours indicates that the schedule runs every 12 hours.

Day of Week

The day of the week on which the schedule begins. *Any* means that the schedule can start on any day.

Expire

The date on which the schedule is no longer used. *Never* means that the schedule never expires.

Displaying Information About Completed Work

When you run the SCHEDULE command in the foreground, output from scheduled commands appears on your screen. It is also directed to a file called **dsmsched.log** in the current directory unless you change the path and file name using the SCHEDLOGNAME option.

After scheduled work is performed, you can check the schedule log to find out whether all work completed successfully. Figure 31 on page 48 shows sample output directed to the schedule log. The output shows the successful completion of a scheduled, selective backup.

See “Starting an Incremental Backup with a Command” on page 14 for an explanation of the statistics that ADSM provides after processing an INCREMENTAL, SELECTIVE, or ARCHIVE command.

The schedule log continues to grow unless you prune it using the SCHEDLOGRETENTION option. See “Specifying Scheduling Options” for more information.

```
06/18/1995 12:50:18 Session established with server GANDALF: OS2_77.77.77
06/18/1995 12:50:18   Server Version 2, Release 1, Level 0.1
06/18/1995 12:50:18   Server date/time: 06/18/1995 12:50:33   Last access: 06/18/1995 12:35:56

06/18/1995 12:50:18 Querying server for next scheduled event.
06/18/1995 12:50:18 Next operation scheduled:
06/18/1995 12:50:18 -----
06/18/1995 12:50:18 ScheduleName:   BONZTEST
06/18/1995 12:50:18 Action:         Selective
06/18/1995 12:50:19 Objects:        c:\devel\sched\*.tst
06/18/1995 12:50:19 Options:
06/18/1995 12:50:19 Server Window Start: 13:00:00 on 06/18/1995
06/18/1995 12:50:19 -----
06/18/1995 12:50:19 Command will be executed in 13 minutes.
06/18/1995 13:03:19 Executing scheduled command now.
06/18/1995 13:03:19 Session established with server GANDALF: OS2_77.77.77
06/18/1995 13:03:19   Server Version 2, Release 1, Level 0.1
06/18/1995 13:03:19   Server date/time: 06/18/1995 13:03:34   Last access: 06/18/1995 12:50:33

06/18/1995 13:03:19 Selective Backup function invoked.

06/18/1995 13:03:33 Normal File-->          1,327 c:\devel\sched\bonz1.tst Sent
06/18/1995 13:03:33 Normal File-->          1,379 c:\devel\sched\bonz2.tst Sent
06/18/1995 13:03:33 Normal File-->          2,656 c:\devel\sched\bonz3.tst Sent
06/18/1995 13:03:33 Normal File-->          2,705 c:\devel\sched\bonz4.tst Sent
06/18/1995 13:03:34 Normal File-->          1,327 c:\devel\sched\bonz5.tst Sent
06/18/1995 13:03:34 Normal File-->          1,327 c:\devel\sched\bonz6.tst Sent
06/18/1995 13:03:34 Normal File-->          1,327 c:\devel\sched\bonz7.tst Sent
06/18/1995 13:03:35 Normal File-->          1,327 c:\devel\sched\bonz8.tst Sent
06/18/1995 13:03:35 Normal File-->          1,327 c:\devel\sched\bonz9.tst Sent
06/18/1995 13:03:37 Selective Backup of 'C:\DEVEL\SCHED\*.TST' complete.

06/18/1995 13:03:37 Scheduled event 'BONZTEST' completed successfully.
06/18/1995 13:03:37 Sending results for scheduled event 'BONZTEST'.
06/18/1995 13:03:38 Results sent to server for scheduled event 'BONZTEST'.
```

Figure 31. Sample Schedule Log

Specifying Scheduling Options

You can modify scheduling options in the client options file if you do not like the current values.

For more detailed information about each scheduling option, see Chapter 6, “Setting Processing Options” on page 61.

Changing How the Scheduler Runs

The following options determine how the scheduler runs on your workstation.

If your administrator specifies a value for these options, it overrides what you have in the client options file.

QUERYSCHEDPERIOD: If you are using the client-polling mode, you can set the maximum number of hours the client scheduler waits between attempts to contact the server for scheduled work.

In the following example, the client scheduler waits for 5 hours:

```
querschedperiod=5
```

MAXCMDRETRIES: Use this option to indicate the maximum number of times the client scheduler can retry a scheduled command that fails.

In the following example, the client scheduler tries 3 times:

```
maxcmdretries=3
```

RETRYPERIOD: Use this option to set the number of minutes the client scheduler must wait between retry attempts for a scheduled command that fails or between unsuccessful attempts to contact the server.

In the following example, the client scheduler waits for 15 minutes:

```
retryperiod=15
```

SCHEDLOGNAME: Use this option to specify where you want ADSM to store the schedule log. The default is the current directory with a file name of **dsmsched.log**.

In the following example, ADSM puts the schedule log in the **c:\error** directory with a file name **schedlog.dec**:

```
schedlogname c:\error\schedlog.dec
```

SCHEDLOGRETENTION: Use this option to set the number of days to keep log file entries in the schedule log before pruning it, and whether to save pruned entries.

In the following example, ADSM keeps entries for 7 days and then prunes them. It discards the pruned entries:

```
schedlogretention 7,D
```

Changing the Scheduling Mode and TCP/IP Addresses

The following options change the scheduling mode, TCP/IP address, or TCP/IP port number.

SCHEDMODE: Use this option to indicate whether you want to use the client-polling mode or the server-prompted mode.

In the *client-polling mode*, the client scheduler queries the server for scheduled work at prescribed time intervals. This is the default schedule mode.

In the *server-prompted mode*, the client scheduler waits for the server to contact your client node when scheduled work needs to be done. This mode provides an ADSM administrator with more control and flexibility in processing scheduled work. For example, if you normally run a scheduled, system-wide incremental backup in the evening, but your host system is scheduled to be down for maintenance work, your ADSM administrator can choose to initiate a backup at an earlier time.

Your administrator can specify that either mode is supported by the server, or only one mode is supported. If your administrator specifies only one mode, you must specify that same mode in your client options file. Otherwise, scheduled work is not processed.

In the following example, the mode is polling:

```
schedmode polling
```

TCPCLIENTADDRESS: Use this option to specify a TCP/IP address if your client node has more than one address, and you want the server to contact a different address than the one used to make initial contact with the server. You can only use this if you are using the server-prompted schedule mode.

In the following example, the address is **dscInt.sanjose.ibm.com**:

```
tcpclientaddress dscInt.sanjose.ibm.com
```

TCPCLIENTPORT: Use this option to specify a TCP/IP port number if you want the server to use a different port than the one used to make initial contact with the server. You can only use this if you are using the server-prompted schedule mode.

If the default or specified port is busy, ADSM attempts to use any other available port.

In the following example, the port number is **1503**:

```
tcpclientport 1503
```

Issuing Commands Before and After a Schedule Runs

The following options let you run commands before and after a schedule.

PRESCCHEDULECMD: Use this option to run a command before the schedule runs. For example, use PRESCCHEDULECMD to quiesce a database. The schedule that runs incrementally backs up the database. Then, use POSTSCHEDULECMD to restart the database.

POSTSCHEDULECMD: Use this option to run a command after running a schedule. For example, after the schedule runs, use a post-schedule command that runs an exec to scan the schedule log and send the results to your administrator.

Using Storage Management Policies

Storage management policies are rules that your ADSM policy administrator defines to tell ADSM how to manage backups and archives, based on the needs of users and the business. For example, policies determine:

- Whether a file is eligible for backup or archive services
- How many backup versions to keep
- How long to keep backup versions and archive copies
- Where to place the copies in storage

This section first explains more about storage management policies. Then, it shows you how to display what policies are available to you. Next, you can read about how to choose the best policies for your files and directories. Finally, this section explains some concepts about how ADSM associates your data with policies.

Understanding Storage Management Policies

Storage management policies have several components, as described by the following terms:

Copy group

The specific storage management attributes that describe how the server is to manage backed up or archived data. There are two kinds of copy groups: *backup copy groups* and *archive copy groups*.

Management class

A collection of backup and archive copy groups that establishes similar storage management requirements for backing up and archiving data. Most of the work you do with storage management policies is with management classes.

Policy set

A group of one or more management classes. The ADSM administrator uses a policy set to implement different management classes based on business and user needs.

Policy domain

A group of clients that have similar needs for backup and archive. Policy domains contain one or more policy sets.

Understanding Policy Domains and Sets

An ADSM administrator uses *policy domains* to manage a group of client nodes in a logical way. For example, a domain could consist of the following clients:

- An organization, such as payroll, technical writers, or the marketing team
- A physical location, such as a particular building or floor
- Local area networks, such as all clients associated with a particular file server

ADSM includes a policy domain named STANDARD. Initially, your client node is probably associated with that policy domain. However, your ADSM administrator can define additional policy domains if there are groups of users that have unique backup and archive requirements.

Each policy domain can hold numerous *policy sets*. Only one of these policy sets can be active at a time, called the *active policy set*. Each policy set contains a *default management class* and any number of additional management classes.

Understanding Management Classes and Copy Groups

A *management class* contains the specific requirements for backing up and archiving data. An ADSM administrator can establish separate management classes to meet the backup and archive requirements for different kinds of data, such as:

- System data critical for the business
- Application data that changes frequently
- Report data that management reviews monthly
- Legal information that needs to be retained for a long time and requires a lot of disk space

Each file and directory that you back up and each file that you archive must be associated with a management class. You are responsible for associating files and directories with appropriate management classes. If you do not associate a file with a management class, ADSM uses the default management class in the active policy set. If you do not specify a management class for directories, ADSM uses the management class in the active policy set that specifies the longest retention period.

You associate files with management classes by using an include-exclude list. See “Choosing a Management Class for Files” on page 57 for more information. To associate directories with a management class, you use the DIRMC option. See “Choosing a Management Class for Directories” on page 59 for more information.

Within a management class, the specific backup and archive requirements are in *copy groups*. There are two kinds of copy groups: backup copy groups and archive copy groups. A management class can have one backup copy group, one archive copy group, both, or neither.

Backup Copy Groups: A *backup copy group* contains attributes that ADSM uses during the backup process to determine the following:

- Whether a file is backed up only if it has changed since the last time it was backed up
- How many days must elapse before a file can be backed up again
- How a file is processed during backup if it is in use

It also contains attributes that ADSM uses to manage the backup versions of your files on the server. Those attributes control the following:

- Where the server stores backup versions of your files and directories
- How many backup versions the server keeps of your files and directories
- How long the server keeps backup versions of your files and directories

Archive Copy Groups: An *archive copy group* contains attributes that control the following:

- Whether a file is archived if it is in use
- Where the server stores archived copies of your files
- How long the server keeps archived copies of your files

Displaying Information About Management Classes

Before you choose the management classes you want to use, you need to see which ones are available by selecting the **Utilities** menu; **Display policy information** item. The information is displayed in the Display Policy Information window (Figure 32).

Or, you can use the QUERY MGMTCLASS command with the DETAIL option to see the available management classes.

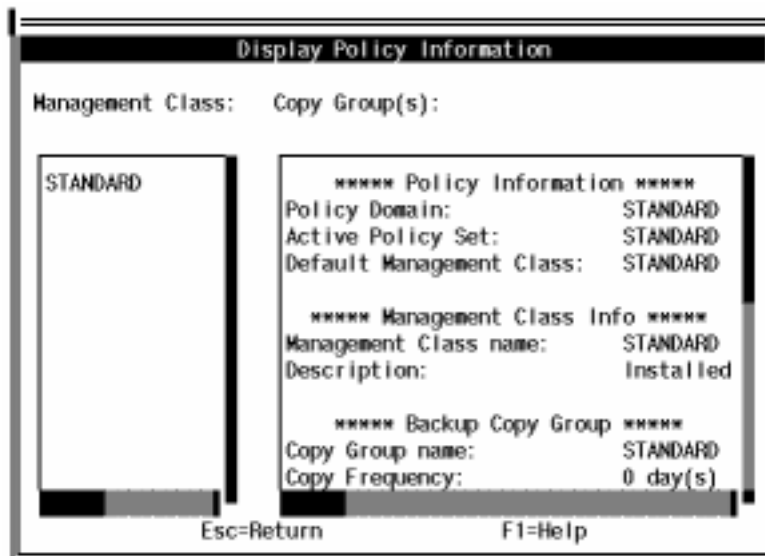

Figure 32. The Display Policy Information Window

ADSM displays the following information in this window:

Policy Information

For policy information, you see this information:

Policy Domain

The name of the policy domain to which this management class belongs.

Active Policy Set

The policy set that is active at the time.

Activation Date/Time

The date and time that this policy set became the active one.

Default Management Class

The name of the default management class for this policy set.

Grace Period Backup Retention

The number of days to retain a backup version when the server is unable to rebind the file to an appropriate management class.

Grace Period Archive Retention

The number of days to retain an archived copy when the server is unable to rebind the file to an appropriate management class. For more information on grace periods, see "Using a Retention Grace Period" on page 60.

Management Class Information

For management class information, you see this information:

Management Class Name

The name of the management class.

Description

A description of the management class.

Copy Groups

You will see information for both backup and archive copy groups:

Copy Group Name

For backup and archive copy groups, the copy group name is always STANDARD.

Copy Type

For backup copy groups, the type is always BACKUP. For archive copy groups, the type is always ARCHIVE.

Copy Frequency

For backup copy groups, copy frequency is the minimum number of days that must elapse between successive incremental backups.

Copy frequency works with the mode parameter that is described later. For example, if frequency is 0, and mode is modified, a file or directory is backed up only if it has been changed since the last incremental backup.

If frequency is 0, and mode is absolute, a file is backed up every time you run an incremental backup against it.

ADSM does not check this attribute for selective backups.

For archive copy groups, the frequency is always CMD (command), that is, there is no restriction on how often you archive a file.

Versions Data Exists

For backup copy groups, the maximum number of different backup versions ADSM retains for files and directories currently on your drive.

If you select a management class that allows more than one backup version, the most current version is called the *active* version. All other versions are called *inactive* versions.

If the maximum number of versions allowed is 5, and you run a backup that creates a sixth version, ADSM deletes the oldest version from server storage.

Versions Data Deleted

For backup copy groups, the maximum number of different backup versions ADSM retains for files and directories that you have erased from your drive. ADSM ignores this parameter as long as the file or directory remains on your drive.

If you erase the file or directory, the next time you run an incremental backup, ADSM changes the active backup version to inactive and erases the oldest versions that are in excess of the number specified by this parameter.

The expiration date for the remaining versions is based on the Retain Extra Versions and Retain Only Version parameters described later.

Retain Extra Versions

For backup copy groups, how many days ADSM retains all but the most recent backup version. The most recent version is the active version, and active versions are never erased.

If Nolimit is specified, extra backup versions are deleted based on the Versions Data Exists or Versions Data Deleted parameters.

Retain Only Version

For backup copy groups, the number of days ADSM retains the last remaining inactive version of a file or directory.

If Nolimit is specified, the last version is retained indefinitely.

Copy Serialization

For backup and archive copy groups, whether a file can be in use during a backup or archive, and what to do if it is. The value for this parameter can be one of the following:

Static

A file or directory must not be modified during backup or archive. If the object is changed during the backup or archive attempt, it is not backed up or archived.

Shared Static

A file or directory must not be modified during backup or archive. ADSM attempts to perform a backup or archive as many as four additional times, depending on the value specified for CHANGINGRETRIES in your client options file. If the object is changed during every backup or archive attempt, it is not backed up or archived.

Dynamic

A file or directory is backed up or archived on the first attempt regardless of whether it changes during backup or archive.

Shared Dynamic

A file or directory is backed up or archived regardless of whether it changes during backup or archive. However, ADSM tries as many as four additional times, depending on the value specified for CHANGINGRETRIES in your client options file, to back up or archive the file without the file changing during the attempt. The file is backed up or archived on the last try even if it has changed.

Attention

Be careful about choosing a management class that contains a copy group that specifies shared dynamic or dynamic for serialization.

If you choose a management class that allows a file to be backed up or archived while it is in use, the backup or archive stored on the server might be a fuzzy copy. A fuzzy copy is a backup or archive that does not accurately reflect what is currently in the file. It might contain some, but not all, of the changes. If that is not acceptable, be sure to choose a management class that allows ADSM to create a backup or archive only if the file does not change during backup or archive.

If you restore or retrieve a file that contains a fuzzy copy, the file might not be usable, depending on the file's application.

Copy Mode

For backup copy groups, whether a file or directory is considered for incremental backup only if it has changed since the last backup or regardless of whether it has changed. ADSM does not check the mode for selective backups. The value for this parameter can be one of the following:

Modified

Indicates that the file is considered for incremental backup only if it has changed since the last backup. A file is considered changed if any of the following are true:

- The date or time of the last modification is different
- The file size is different
- The file attributes, except for the archive attribute, are different

Absolute

Indicates that the file is considered for incremental backup regardless of whether it has changed since the last backup.

For archive copy groups, the mode is always absolute, which indicates that a file is archived regardless of whether it has changed since the last archive request.

Copy Destination

For backup and archive copy groups, the name of the destination where ADSM stores the backup or archive. The destination can be either a storage pool of disk devices or a storage pool of devices that support removable media such as tape.

Retain Versions

For archive copy groups, the number of days an archived file remains in ADSM storage.

When the specified number of days elapse for an archived copy of a file, ADSM deletes it from ADSM storage.

Default Values for Management Class STANDARD

ADSM includes a default management class named STANDARD. Figure 33 shows the default values for the backup and archive copy groups in this management class.

Figure 33. Default Values in the STANDARD Management Class

Attribute	Backup Default	Archive Default
Copy Group Name	STANDARD	STANDARD
Copy Type	BACKUP	ARCHIVE
Copy Frequency	0 days	CMD
Versions Data Exists	2 versions	N/A
Versions Data Deleted	1 version	N/A
Retain Extra Versions	30 days	N/A
Retain Only Version	60 days	N/A
Copy Serialization	shared static	shared static
Copy Mode	modified	absolute
Copy Destination	BACKUPPOOL	ARCHIVEPOOL
Retain Versions	N/A	365 days

Choosing a Management Class for Files

If the default management class meets the backup and archive requirements for all the files on your workstation, you do not need to take any action to associate your files with that management class. ADSM does that automatically when you back up or archive your files.

Using the Include-Exclude List to Assign a Management Class

To assign a management class other than the default to a file or group of files, you use an INCLUDE statement in the include-exclude list. You create the include-exclude list in your client options file. For example, to associate all the files in the **costs** directory with a management class named BUDGET use the following include statement:

```
INCLUDE c:\adsm\proj2\costs\*. * budget
```

Management class names are not case sensitive.

To specify a management class to be used for all files to which you do not explicitly assign a management class, use the following include statement:

```
INCLUDE * managall
```

where managall is the name of an available management class. For more information about using the include-exclude list, see “Using Management Classes with INCLUDE” on page 74.

Overriding the Management Class for Archived Files

When you archive a file, you can choose to override the assigned management class. When using the graphical user interface, ADSM presents a window that allows you to select a different management class.

When using the ARCHIVE command, you can use the ARCHMC option to specify a different management class. For example, to associate the file **budget.jan** with the management class RET2YRS, you specify the following:

```
archive -archmc=ret2yrs c:\plan\proj1\budget.jan
```

For more information about ARCHMC, see “ARCHIVE—Archiving Files” on page 146.

Questions to Consider When Choosing a Management Class

If you need to choose a different management class for some of your files, consider the following questions.

- Does the management class contain a backup copy group?
If you attempt to back up a file that is associated with a management class that does not contain a backup copy group, the file is not backed up.
- Does the management class contain an archive copy group?
If you attempt to archive a file that is associated with a management class that does not contain an archive copy group, the file is not archived.
- Does the backup copy group contain attributes that allow your files to be backed up often enough?
Mode and frequency work together to control how often a file is backed up when you use incremental backup. ADSM does not check those attributes for selective backup.
- Do the copy groups specify either static or shared static for serialization?
If serialization is shared dynamic or dynamic, you might get fuzzy backups or archive copies. Be sure you understand whether that is acceptable.
For example, you might want to use shared dynamic or dynamic for a file to which log records are continuously added. If you used static or shared static, the file might not be backed up at all because it is constantly in use. With shared dynamic or dynamic, the file would be backed up, but the backup version of the file might contain a truncated message.
However, you would not want to use shared dynamic or dynamic for a file if it is critical that the backup version or archive copy contain all changes. That is probably the case for most of your files.
- Does the backup copy group specify an adequate number of backup versions to keep and an adequate length of time to keep them?
- Does the archive copy group specify an adequate length of time to keep archived copies of files?

Choosing a Management Class for Directories

If the management class in your active policy set that contains the longest retention period meets your backup requirements for directories, you do not need to take any action to associate directories with that management class. ADSM does it automatically when it backs up your directories.

If that default management class does not meet your requirements, be sure to choose a management class with an adequate retention period specified for Retain Only Version. You want to be sure that ADSM keeps directories at least as long as it keeps the files associated with those directories.

To assign a management class other than the default to directories, you use the DIRMC option in your client options file. For example, to assign a management class named DIRECT1 to your directories, you would enter:

```
DIRMC DIRECT1
```

For more information about using DIRMC, see “DIRMC” on page 83.

Binding and Rebinding Management Classes to Files

When you back up a file for the first time, ADSM binds it to either the default management class or the management class specified for the file in your include-exclude list. *Binding* is the term for associating a file with a management class.

If the backup copy group for the management class instructs ADSM to keep multiple backup versions of the file, and you request multiple backups, the server always has one active backup version (the most current version) and one or more inactive backup versions of the file. All the backup versions of a file are bound to the same management class and are managed based on the attributes in the backup copy group.

When you archive a file, ADSM binds it to the default management class, to the management class specified for the file in your include-exclude list, or to a management class you specify.

There are several instances in which backup versions of a file can be rebound to a different management class. Archived files are never rebound to a different management class. If you change the management class for a file, any previous copies of the file that you have archived remain bound to the management class specified when you archived them.

Rebinding Backup Versions of Files

Backups of files are rebound to a different management class in the following cases. In each case, the files (active and inactive) are not rebound until the next backup.

- You change the management class for the file by specifying a different management class in an INCLUDE statement.

ADSM continues to manage the backups based on the old management class until you run another backup.

- Your ADSM administrator deletes the management class from your active policy set.
ADSM uses the default management class to manage the backup versions when you back up the file again.
- Your ADSM administrator assigns your client node to a different policy domain and the active policy set in that domain does not have a management class with the same name.
ADSM uses the default management class for the new policy domain to manage the backup versions.

Using a Retention Grace Period

ADSM also provides a *backup retention grace period* and an *archive retention grace period* that it uses to help protect your backup and archive data when it is unable to rebind a file to an appropriate management class.

For example, ADSM uses the backup retention grace period in these cases:

- You change the management class for a file, but the new management class does not contain a backup copy group, nor does the default management class.
- The management class to which a file is bound no longer exists, and the default management class does not contain a backup copy group.

ADSM begins using the backup retention grace period when you run an incremental backup.

The backup retention grace period is defined in your policy domain. The default is 30 days. However, your ADSM administrator can choose to change that value to a longer or shorter period.

After ADSM begins managing a file using the backup retention grace period, it does not create any new backup versions of the file. All existing backup versions of the file expire 30 days (or the number of days specified in your policy domain) from the day they are marked inactive.

For archived files, if the management class to which a file is bound no longer exists, and the default management class does not contain an archive copy group, ADSM uses the archive retention grace period defined in your policy domain. The default retention period is 60 days. Your ADSM administrator can choose to change that value to a longer or shorter period.

Chapter 6. Setting Processing Options

You can use defaults for processing options or you can tailor the processing options to meet specific needs. This chapter:

- Provides an overview of processing options
- Explains how to set options in a file
- Explains how to use options with commands

Understanding Processing Options

ADSM processing options reside in the client options file. This file, usually called **dsm.opt**, contains the following:

- Required communication options and scheduling options
- Options that relate to backup and archive processing
- Options that control processing for sessions with ADSM

If you want to use different options than those specified in the default client options file, you can create your own options file.

During the initial installation and setup of ADSM, you are provided with a sample client options file called **dsm.smp**. Copy **dsm.smp** to **dsm.opt** and modify the required options in the new copy. Required options are those that provide information that the backup-archive client program needs to establish communication with an ADSM server (including the NODENAME option).

The default location for the client options file is the installation directory **c:\adsm**. During installation, you can choose a different name and location for your client options file. The environment variable **DSM_CONFIG** points to the directory where your options file resides.

This section provides an overview of the options you can enter in your client options file. The options are arranged in groups by these categories:

- Communication options
- Backup and archive processing options
- Restore and retrieve processing options
- Scheduling options
- Format and language options
- Command processing options
- Error processing options

You can use this information to help you decide whether to make any further changes to suit your needs.

You can use many of the options discussed in the following sections with applicable ADSM commands. If you enter an option with a command, it overrides what is specified for the option in your client options file, with the exception of the DOMAIN option.

When you use the DOMAIN option with a command, it adds to what is specified in your client options file, rather than overriding what is specified.

There are also options that are used *only* with ADSM commands. For more information about these options, see Figure 52 on page 142.

Communication Options

You use communication options to specify how your client node communicates with an ADSM server. The particular options you specify depend on your choice of communication protocol.

ADSM for DOS can use any of these communication methods: 3270, TCP/IP, PWSCS, SNA LU6.2, IPX/SPX, NETBIOS, PC Support/400, and Client Access/400. You specify which of these protocols you want to use with the COMMMETHOD option. The default is 3270. For more information, see “COMMMETHOD” on page 77.

Ask your ADSM administrator for assistance in setting your communication options.

3270 Options

To use the 3270 protocol, you must include the 3270HOSTCOMMAND option in your client options file. The other 3270 options have default values. You need to modify these other options only if you want to change the default value.

Figure 34. 3270 Options

Option	Description	Reference
3270BUFFERSIZE	Specifies the size, in bytes, of the ADSM internal 3270 communication buffer.	Page 128
3270CHECKSUM	Specifies whether ADSM should check the validity of the data being sent between a 3270 client session and the server.	Page 129
3270HOSTCMDPAUSE	Specifies the number of seconds to pause between sending AID (attention) keys to the host.	Page 130
3270HOSTCOMMAND	Specifies a sequence of commands to start a 3270 client/server session.	Page 131
3270HOSTENDCOMMAND	Specifies a sequence of commands to send to the server at the end of an ADSM client session.	Page 132
3270HOSTTIMEOUT	Specifies the number of seconds the client node waits to receive a data packet from the server before timing out.	Page 133
3270LOGICALTERMINALID	Specifies a 3270 logical terminal session for use by a client.	Page 134

TCP/IP Options

To use the TCP/IP protocol, you must include the TCPSERVERADDRESS option in your client options file. The other TCP/IP options have default values. You need to modify these other options only if you want to change the default value.

Figure 35. TCP/IP Options

Option	Description	Reference
TCPBUFFSIZE	Specifies the size, in kilobytes, of the ADSM internal TCP/IP communication buffer.	Page 118
TCPPORT	Specifies the TCP/IP port address for an ADSM server.	Page 121
TCPSERVERADDRESS	Specifies the TCP/IP address for an ADSM server.	Page 122
TCPWINDOWSIZE	Specifies the size, in kilobytes, of the TCP/IP sliding window for your client node.	Page 123

PWSCS and SNA LU6.2 Options

PWSCS and SNA LU6.2 use the same communication options. To use one of these protocols, you must include either the SYMBOLICDESTINATION option or all three of the following options: CPICMODENAME, PARTNERLUNAME, and TPNAME.

Figure 36. PWSCS and SNA LU6.2 Options

Option	Description	Reference
CPICBUFFERSIZE	Specifies the buffer size for SNA LU6.2 or VM PWSCS communication.	Page 80
CPICMODENAME	Specifies the mode name for SNA LU6.2 or PWSCS communication.	Page 81
PARTNERLUNAME	Specifies a logical unit name used by the transaction program to identify the ADSM server in the SNA network.	Page 102
SYMBOLICDESTINATION	Specifies a symbolic ADSM server name.	Page 116
TPNAME	Specifies a symbolic name for a transaction program in an SNA network. The transaction program identifies the target logical unit (LU), which is the ADSM server.	Page 125

IPX/SPX Options

The communication options for IPX/SPX, all of which have default values, are:

Figure 37. IPX/SPX Options

Option	Description	Reference
IPXBUFFERSIZE	Specifies the size, in kilobytes, of the IPX/SPX communication buffer.	Page 90
IPXSERVERADDRESS	Specifies the IPX/SPX address for an ADSM server.	Page 91
IPXSOCKET	Specifies the IPX/SPX socket number for an ADSM server.	Page 92

NETBIOS Options

The communication options for NETBIOS, all of which have default values, are:

Figure 38. NETBIOS Options

Option	Description	Reference
LANADAPTER	Specifies a communication adapter number for NETBIOS.	Page 93
NETBIOSBUFFERSIZE	Specifies the size, in kilobytes, of the NETBIOS communication buffer.	Page 96
NETBIOSNAME	Specifies a NETBIOS name for your workstation.	Page 97
NETBIOSSERVERNAME	Specifies the NETBIOS name for an ADSM server.	Page 98
NETBIOSTIMEOUT	Specifies the number of seconds that must elapse before a timeout occurs for a NETBIOS send or receive operation.	Page 99

PC Support/400 and Client Access/400 Options

To use the PC Support/400 and Client Access/400 communication method, you must include the 400PARTNERLUNAME and 400TPNAME options in your client options file. The other options have default values. You need to modify these other options only if you want to change the default value.

Figure 39. PC Support/400 and Client Access/400 Options

Option	Description	Reference
400COMMBUFFERBYTES	Specifies the size, in bytes, of the PC Support/400 or Client Access/400 router communication buffer.	Page 135
400PARTNERLUNAME	Specifies the name of the AS/400 system running the ADSM/400 server.	Page 136
400SENDERBUFFERBYTES	Specifies the size, in bytes, of the client communication buffer.	Page 137
400TPNAME	Specifies the name of the ADSM/400 server.	Page 138

Node Option

Use the following option to specify the client node for which you want to request services.

Figure 40. Node Option

Option	Description	Reference
NODENAME	Specifies one of the following: <ul style="list-style-type: none">The name of your workstation so that you can establish communications with the ADSM server.The name of another workstation. Use this if you want to restore or retrieve your files from an ADSM server to a different workstation than the one from which you stored the files.	Page 100

Backup and Archive Processing Options

You can use the following options to control some aspects of backup and archive processing:

Figure 41. Backup and Archive Processing Options

Option	Description	Reference
CHANGINGRETRIES	Specifies the number of retries for attempting to back up or archive a file that is in use.	Page 76
COMPRESSALWAYS	Whether to compress files or send them if compression causes them to grow.	Page 78
COMPRESSION	Specifies whether to compress files before sending them to the ADSM server.	Page 79
DIRMC	Specifies the management class to use for directories. If not specified, ADSM uses the management class with the longest retention period.	Page 83
DOMAIN	Specifies the volumes included in your default client domain for incremental backup.	Page 84
EXCLUDE	Specifies a file or group of files you want to exclude from backup services. Any file in your client domain that is not specifically excluded with this option is considered for backup.	Page 86
INCLUDE	Specifies one of the following: <ul style="list-style-type: none">Files within a broad group of excluded files that you want to specifically include for backup services.Files to which you want to assign a specific management class and the management class name.A management class to assign to all files to which you do not explicitly assign a management class.	Page 88
SLOWINCREMENTAL	Specifies a memory-saving backup algorithm for incremental backups for use with the INCREMENTAL command.	Page 114
SUBDIR	Specifies whether to include subdirectories of a specified directory.	Page 115
TAPEPROMPT	Specifies whether you want ADSM to wait for a tape required for a backup or archive to be mounted, or to prompt you for your choice.	Page 117

Restore and Retrieve Processing Options

The following options relate to restore and retrieve processing and apply most often when you issue a RESTORE or RETRIEVE command.

Figure 42 (Page 1 of 2). Restore and Retrieve Processing Options

Option	Description	Reference
FSTYPES	Specifies the types of file spaces to show when looking at another node's restore/retrieve drives.	Page 87

Figure 42 (Page 2 of 2). Restore and Retrieve Processing Options

Option	Description	Reference
REPLACE	Specifies whether to overwrite an existing file or prompt you for your choice when restoring or retrieving files.	Page 107
SUBDIR	Specifies whether to include subdirectories of a specified directory.	Page 115
TAPEPROMPT	Specifies whether you want ADSM to wait for a tape required for a restore or retrieve to be mounted, or to prompt you for your choice.	Page 117

Scheduling Options

Some of the options in the client options file regulate central scheduling. You can use these options to provide information that ADSM needs when performing scheduled work. ADSM uses scheduling options only when the SCHEDULE command is running.

Most of the options discussed in this section can be overridden by ADSM server settings after the backup-archive client program on your workstation makes contact with the ADSM server.

Figure 43. Scheduling Options

Option	Description	Reference
MAXCMDRETRIES	Specifies the maximum number of times the client scheduler attempts to process a scheduled command that fails.	Page 95
POSTSCHEDULECMD	Specifies a command to process after running a schedule.	Page 103
PRESCHEDULECMD	Specifies a command to process before running a schedule.	Page 104
QUERYSCHEDPERIOD	Specifies the number of hours the client scheduler waits between unsuccessful attempts to contact the ADSM server for scheduled work.	Page 105
RETRYPERIOD	Specifies the number of minutes the client scheduler waits between attempts to process a scheduled command that fails or between unsuccessful attempts to report results to the server.	Page 108
SCHEDLOGNAME	Specifies the name of the file where schedule log information is stored.	Page 109
SCHEDLOGRETENTION	Specifies the number of days to keep log file entries in the schedule log, and whether to save pruned entries.	Page 110
SCHEDMODE	Specifies the schedule mode to use, POLLING or PROMPTED.	Page 111
TCPCLIENTADDRESS	Specifies the TCP/IP address of your client node. Used only with the SCHEDULE command when SCHEDMODE is PROMPTED.	Page 119
TCPCLIENTPORT	Specifies the TCP/IP port number of your client node. Used only with the SCHEDULE command when SCHEDMODE is PROMPTED.	Page 120

Format and Language Options

You can use options to choose different formats for date, time, numbers, and different languages if you have the appropriate client installed for that language.

Figure 44. Format and Language Options

Option	Description	Reference
DATEFORMAT	Specifies the format for displaying dates.	Page 82
LANGUAGE	Specifies the language used to display messages.	Page 94
NUMBERFORMAT	Specifies the format for displaying numbers.	Page 101
TIMEFORMAT	Specifies the format for displaying times.	Page 124

Command Processing Options

The following options apply only when you use certain ADSM commands.

Figure 45. Command Processing Options

Option	Description	Reference
QUIET	Specifies that you do not want processing information to appear on your screen.	Page 106
SCROLLLINES	Specifies the number of lines to display at one time when displaying a list of items. Used only when SCROLLPROMPT is YES.	Page 112
SCROLLPROMPT	Specifies whether you want ADSM to stop after displaying the number of lines specified by SCROLLLINES or to scroll to end of list.	Page 113
VERBOSE	Specifies that you want processing information to appear on your screen. The alternative is QUIET.	Page 127

Error Processing Option

This option controls how ADSM should treat the entries in the log file.

Figure 46. Error Processing Option

Option	Description	Reference
ERRORLOGRETENTION	Specifies the number of days to keep log file entries in the error log, and whether to save pruned entries.	Page 85

Transaction Processing Option

This option controls how ADSM processes transactions between the client and server.

Figure 47. Transaction Processing Option

Option	Description	Reference
TXNBYTELIMIT	Control transaction processing	Page 126

Setting Options in a File

This section provides instructions for setting options in your client options file.

It also contains instructions for using options with ADSM commands and detailed information about each option.

You can set options in your options file so that you do not need to enter the options when you issue commands. The options file is usually called **dsm.opt**.

To set an option in your client options file, type the option name, followed by one or more blank spaces, followed by the option parameters. For example:

```
compression on
nodename     client_a
```

Some options consist of only the option name. For example:

```
verbose
quiet
```

You can write the entire option name or an abbreviation for the option name. For example, for the INCLUDE option, you can write either of the following:

```
include
in
```

The following are additional general rules for entering options in a file:

- You can begin an option in any column of the line.
- You can leave blank lines between options.
- You can enter comments in an options file by entering an asterisk (*) as the first character in a line.
- Put each option on a separate line, and enter all parameters for an option on the same line.

For example, to specify a group of five different drives as your default client domain, you could enter the following:

```
domain C: D: E: F: G:
```

- Put one or more blank spaces between each parameter.

Using Options With Commands

You can override some of the options set in your client options file by entering them with appropriate ADSM commands.

ADSM also includes a group of client command options that you can enter only on the command line with specific commands. For information about that group of options, see "Options" on page 141.

To use an option with an ADSM command, enter a dash (–) or a slash (/), followed by the option name, followed by an equal sign (=), followed by the option parameters. For example:

```
incremental -domain=c:
```

For options that do not include parameters, enter a dash (–) or a slash (/), followed by the option name. For example:

```
incremental -quiet
```

You can enter the entire option name or an abbreviation for the option name. For example, for the QUIET option, enter either of the following:

```
-quiet  
-q
```

The shortest acceptable abbreviations are shown in the syntax diagrams for each option. For information about how to read the syntax diagrams, see “Reading Syntax Diagrams” on page xvii.

The following are additional general rules for entering options with a command:

- You can enter options in any order before or after command parameters.

For example, you can enter the SUBDIR option before or after a file specification:

```
selective -subdir=yes c:\devel\proj1\  
selective c:\devel\proj1\  
-subdir=yes
```

- When you enter more than one option in a command, separate each option with a blank space.

For example:

```
selective -subdir=yes -quiet c:\devel\proj1\  
*
```

- If the value you enter for an option contains a blank space, you must enclose the value in quotes (" ").

For example:

```
archive -description="Project A" c:\devel\proja.lst
```

When you enter an option on the command line, the value you specify overrides what is set in the client options file, except for the DOMAIN option. When you use the DOMAIN option with a command, it adds to the domain specified in your client options file instead of overriding it.

Creating an Include-Exclude List

Figure 48 provides brief descriptions of the INCLUDE and EXCLUDE options that you can specify in your client options file and references to more detailed information about each option.

Figure 48. Include-Exclude Options in the Client Options File

Option	Description	Reference
EXCLUDE	Specifies a file or group of files you want to exclude from backup services. Any file in your client domain that is not specifically excluded with this option is considered for backup.	Page 86
INCLUDE	Specifies one of the following: <ul style="list-style-type: none">Files within a broad group of excluded files that you want to specifically include for backup services.Files to which you want to assign a specific management class and the management class name.A management class to assign to all files to which you do not explicitly assign a management class.	Page 88

Excluding System Files

For DOS, we recommend at least the following include-exclude list (assuming you boot from the C: drive). You can delete the lines that do not apply to your version of DOS.

```
exclude c:\ibmbio.com
exclude c:\ibmdos.com
exclude c:\msbio.com
exclude c:\msdos.com
exclude c:\msdos.sys
exclude c:\io.sys
exclude c:\...\*.dll
exclude ?:\...\dblSPACE.*
```

These files are system files that cannot be recovered without possibly corrupting the operating system. The **dll** files are for communication protocols.

The **dblSPACE.*** files are typical names of the hidden files created by a popular disk compression program. ADSM backs up the files in the file spaces used by these kinds of programs. Therefore, it is not necessary to back up these hidden files. (Because these files are large, if you do back them up, your communication session might time out before ADSM can send the files.) Consult your disk compression documentation for the file names, or use this command to look for hidden files:

```
dir /a:h
```

Of course, you can exclude other files according to your needs.

Including and Excluding Groups of Files

To specify groups of files that you want to include or exclude, you can use the wildcard characters listed in Figure 49.

Note that this table only applies to include and exclude statements. For information on using wildcard characters in ADSM commands, see “Using Wildcard Characters” on page 143.

Figure 49. Wildcard and Other Special Characters

Character	Function
?	The match-one character matches any single character except the directory separator; it does not match the end of the string. It can only be used in the drive name and file name, not in a directory name.
*	The match-all character matches zero or more characters, but it does not cross a directory boundary. It can only be used in the drive name and file name, not in a directory name.
\..	The match <i>n</i> character matches zero or more directories.
\	The directory separator character limits the scope of the search for the matching <i>n</i> characters and directories. If a pattern does not begin with a directory separator (or one does not follow the drive specification), a match all directories is appended to the pattern. For example, these patterns are equivalent: <code>c:*</code> <code>c:\..*</code>
[The open character-class character is used to begin the enumeration of a character class. For example: <code>xxx[abc]</code> matches <code>xxxa</code> , <code>xxxb</code> , or <code>xxxc</code> .
–	The character-class range includes characters from the first character specified up to and including the last character specified. For example: <code>xxx[a-z]</code> matches <code>xxxa</code> , <code>xxxb</code> , <code>xxxc</code> , ... <code>xxxz</code> .
]	The close character-class character ends the enumeration of a character class.
\	The literal escape character, when used within a character class, causes the next character to be treated literally. When used outside a character class, it is not specially treated.
:	The drive separator character separates a file specification. The characters before the colon identify a drive name. The characters after the colon identify either a directory name or file name. For example: <code>d:\direct\file.nam</code>

Examples Using Wildcards in EXCLUDE and INCLUDE Patterns

Example 1

Exclude all files with a **bak** extension, except those found on the **d:** drive in the **dev** directory.

```
exclude ?:*.*bak
include d:\dev\*.*bak
```

Example 2

Exclude all files and directories under any **tmp** directory that may exist, *except* for the one file **d:\tmp\save.fil**. Include this file.

```
exclude ?:\...\tmp\...\*
include d:\tmp\save.fil
```

Example 3

Evaluate the following EXCLUDE statements:

```
exclude [ce-g]:\...\*.obj
exclude d:\*.obj
exclude ?:tmp\...\*
```

This example is a bit more complex.

1. **[ce-g]:\...*.obj** matches any **.obj** file in any directory on the **c:**, **e:**, **f:**, and **g:** drives.
2. **d:*.obj** only matches the **.obj** files found in the root directory in the **d:** drive.
3. **?:\tmp\...*** matches any file found on any drive that resides under the **tmp** directory.

Processing INCLUDE and EXCLUDE Options

ADSM processes the EXCLUDE and INCLUDE options as follows:

- Directories are *not* checked, only files are. Therefore, if you have a drive (such as **C:**) defined in the DOMAIN option, all directories of that drive are backed up regardless of what you defined for your EXCLUDE and INCLUDE options, even if the files in those directories are not backed up.
- **The order that these options are checked is from the bottom up until a match is found.** If a match is found, the processing stops and looks at whether the option is INCLUDE or EXCLUDE. If the option is INCLUDE, the file is backed up. If the option is EXCLUDE, the file is *not* backed up.
- If a match is *not* found, files listed are implicitly included and therefore backed up.
- If policy administration is in effect, files are backed up according to the default management class or the management class you specify.

Here are some other examples of *bottom up* processing.

Example 1

Assume that **C:** is defined as the domain in the DOMAIN option, and you have this defined for the EXCLUDE and INCLUDE options.

```
exclude ?:\*.obj
include c:\foo\...\*.obj
exclude c:\foo\junk\*.obj
```

The current file being processed is **c:\foo\dev\test.obj**.

The processing follows these steps:

1. Rule 3 (the last INCLUDE or EXCLUDE defined) is checked first because of *bottom up* processing.
c:\foo\junk*.obj does not match the current file name being processed.
2. Processing moves to Rule 2 and checks.
This time, **c:\foo\...*.obj** matches the current file name being processed.
3. Processing stops, the option is checked, and it is INCLUDE.
4. **c:\foo\dev\test.obj** is backed up.

Example 2

Assume that **C:** is defined as the domain in the DOMAIN option, and you have this defined for the EXCLUDE and INCLUDE options.

```
exclude ?:\*.obj
include c:\foo\...\*.obj
exclude c:\foo\junk\*.obj
```

The current file being processed is **c:\widg\copyit.bat**.

The processing follows these steps:

1. Rule 3 is checked and finds no match.
2. Rule 2 is checked and finds no match.
3. Rule 1 is checked and finds no match.
4. Because no match is found, **c:\widg\copyit.bat** falls into the implicit INCLUDE option and is backed up.

Example 3

Assume that **C:** is defined as the domain in the DOMAIN option and you have this defined for the EXCLUDE and INCLUDE options.

```
exclude ?:\...\*.obj
include c:\foo\...\*.obj
exclude c:\foo\junk\*.obj
```

The current file being processed is **c:\lib\objs\printf.obj**.

The processing follows these steps:

1. Rule 3 is checked and finds no match.
2. Rule 2 is checked and finds no match.
3. Rule 1 is checked and a match is found.
4. Processing stops, the option is checked, and it is EXCLUDE.
5. **c:\lib\objs\printf.obj** is not backed up.

Using Management Classes with INCLUDE

A management class defines when your files are included in a backup or archive, how long they are kept on the ADSM server, and how many versions of the file the ADSM server should keep.

The ADSM server administrator chooses a default management class. You can override the default management class by specifying your own management class.

This is an example of using a management class:

```
exclude ?:\...\*.sno
include c:\winter\...\*.ice      mcweekly
include c:\winter\december\*.ice mcdaily
include c:\winter\january\*.ice mcmonthly
include c:\winter\winter\white.sno
```

The processing follows these steps:

1. The file named **white.sno** is backed up because of *bottom up* processing. Because you did not specify a management class, the file is bound to the default management class.
2. Any file with an **ice** extension in the directory **c:\winter\january** is bound to the management class MCMONTHLY.
3. Any file with an **ice** extension in the directory **c:\winter\december** is bound to the management class MCDAILY.
4. Any other files with an **ice** extension in any directory under **\winter** are bound to MCWEEKLY.
5. Any file with a **sno** extension (except **c:\winter\winter\white.sno**) in any directory is excluded from the backup.

To specify your own default management class for files that are not explicitly included, specify:

```
INCLUDE ?:* mgmt_class_name
```

as the first INCLUDE or EXCLUDE defined.

If archiving files with the ARCHIVE command, you can override the INCLUDE management class or choose the default management class using the ARCHMC option. For an example of its usage, see the ARCHIVE command on page 146.

To specifically define a management class for directories, use the DIRMC option. For details, see "DIRMC" on page 83.

Client Options Reference

The following sections contain detailed information about each of the ADSM processing options. These options are arranged in alphabetical order. Information for each option includes:

- A description of the option
- A diagram that shows the syntax of the option

The option name is shown in a combination of uppercase and lowercase characters. The uppercase characters indicate the minimum abbreviation you can use for the option name.

See “Reading Syntax Diagrams” on page xvii for an explanation of these diagrams.

- Detailed descriptions of the option parameters. If the parameter is a constant, its minimum abbreviation is shown in uppercase letters.
- Example of using the option in the client options file (if applicable)
- Example of using the option on the command line (if applicable)

CHANGINGRETRIES

CHANGINGRETRIES

Use the CHANGINGRETRIES option to specify how many additional times you want ADSM to attempt to back up or archive a file that is in use during the first attempt.

This option relates to serialization, which is an attribute in a management class copy group. ADSM uses this option only when serialization is shared static or shared dynamic.

With shared static, if a file is in use during the first backup or archive attempt, ADSM retries the operation the number of times specified with this option. If the file is in use during each attempt, the operation is not completed.

With shared dynamic, if a file is in use during the first backup or archive attempt, ADSM retries the operation the number of times specified with this option. The backup or archive occurs during the last attempt regardless of whether the file is currently in use.

Syntax

```
▶▶—CHangingretries numberretries—————▶▶
```

Parameters

numberretries

The number of times ADSM retries a backup or archive operation if the file is in use during the first attempt.

The range of values is 0 to 4.

The default is 4.

Examples

Options file example: `changingretries 3`

Command line example: `-ch=0`

COMMMETHOD

COMMMETHOD

Use the COMMMETHOD option to specify the communication method you are using to provide connectivity for client-server communication.

Syntax

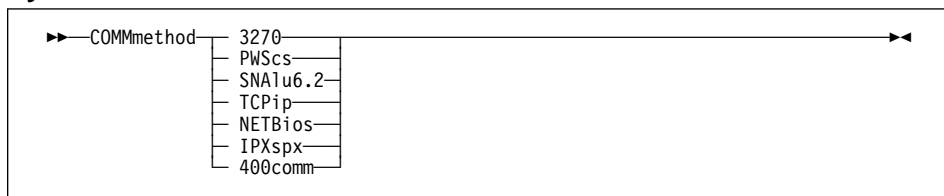

Parameters

3270

The 3270 communication method.

This protocol is the default.

PWScs

The Programmable Workstation Communication Services (PWSCS) communication method. You can only use this method with a VM server.

SNA1u6.2

The Systems Network Architecture (SNA) logical unit 6.2 (LU6.2) communication method. You can only use this method with an OS/400 server.

TCPip

The Transmission Control Protocol/Internet Protocol (TCP/IP) communication method.

NETBios

The Network Basic Input/Output System (NETBIOS) communication method.

IPXspx

The Internetwork Packet Exchange/Sequenced Packet Exchange (IPX/SPX) communication method. You can only use this communication method with OS/2 and AIX servers.

400comm

The PC Support/400 Advanced Program-to-Program or Client Access/400 communication method.

Examples

Options file example: COMM sna

Command line example: -COMMMETHOD=IPX

COMPRESSALWAYS

COMPRESSALWAYS

Use the COMPRESSALWAYS option to control what ADSM does when a file grows during compression. You can cause ADSM to either continue compressing or not to send the object if it grows during compression. This option has no effect unless the COMPRESSION option is set to Yes.

Syntax

<code>COMPRESSALWAYS</code> <input type="checkbox"/> No <input type="checkbox"/> Yes
--

Parameters

No

Object is not sent if it grows during compression.

This is the default.

Yes

File compression continues even if the file grows as a result of compression.

Examples

Options file example: COMPRESSALWAYS Yes

Command line example: -COMPRESSA=No

COMPRESSION

COMPRESSION

Use the **COMPRESSION** option to specify whether ADSM should compress files before sending them to the ADSM server. Compressing your files decreases the amount of data storage required to store backup versions and archived copies of your files. However, it can affect ADSM throughput. Typically, a fast processor on a slow line benefits from compression, but a slow processor on a fast line does not.

This option controls compression only if your ADSM administrator specifies that the choice is determined by your client node.

ADSM does not compress a file if it determines that the compression process is increasing the size of the file. This might happen if a file has already been compressed by another program. These files are sent to the server without being compressed by ADSM.

Syntax

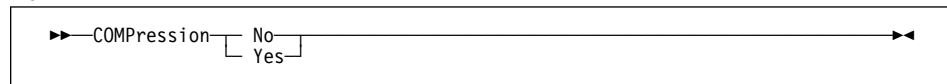

Parameters

No

Files are not compressed before being sent to the server. You can also specify No as OFF, False, or 0.

This is the default.

Yes

Files are compressed before being sent to the server. You can also specify Yes as ON, True, or 1.

Examples

Options file example: **COMPRESSION Yes**

Command line example: **-COMP=No**

CPICBUFFERSIZE

CPICBUFFERSIZE

Use the CPICBUFFERSIZE option to specify the size of the CPIC buffer for SNA LU6.2 or PWSCS communication. A larger buffer can improve communication performance, but uses more memory.

Syntax

```
▶▶—CPicbuffersize size————▶▶
```

Parameters

size

The size of an SNA LU6.2 or PWSCS communication buffer, in kilobytes.

The range of values is 1 to 31.

The default is 16.

Examples

Options file example: CPICBUFFERSIZE 31

Command line example: -CP=20

CPICMODENAME

CPICMODENAME

Use the CPICMODENAME option to define the mode name for the SNA LU6.2 or PWSCS communication methods. For CPIC, this option identifies the SNA connection to the gateway and target logical unit. The CPIC mode name is used if the symbolic destination is not provided and the partner LU is located on another system. The mode name must be known on both the local and remote systems.

If you use this option, you must also use the TPNAME and the PARTNERLUNAME options.

Syntax

▶—CPICModename *name*————▶

Parameters

name

The mode name for SNA LU6.2 or PWSCS communication.

There is no default.

Examples

Options file example: cpicmodename vmmode

Command line example: -cpicmo=vmmode

DATEFORMAT

DATEFORMAT

Use the DATEFORMAT option to select the format you want ADSM to use for displaying dates.

Syntax

```
▶▶—DATEformat format_number————▶▶
```

Parameters

format_number

One of the following date formats:

- 1 Displays the date in this format: MM/DD/YYYY
This is the default.
- 2 Displays the date in this format: DD-MM-YYYY
- 3 Displays the date in this format: YYYY-MM-DD
- 4 Displays the date in this format: DD.MM.YYYY
- 5 Displays the date in this format: YYYY.MM.DD

Examples

Options file example: DATEFORM 3

Command line example: -DATE=4

DIRMC

Use the DIRMC option to specify the management class you want ADSM to use for directories. If you do not use this option to associate a management class with directories, ADSM uses the management class in the active policy set of your policy domain that has the longest retention period.

When choosing a management class for directories, be sure to choose one that allows ADSM to retain directories at least as long as it retains the files associated with them.

Syntax

```
▶—DIRMc mgmtclassname—▶
```

Parameters

mgmtclassname

The name of the management class you want to associate with directories.

ADSM uses the management class you specify for all directories it backs up. If you do not use this option, the management class with the longest retention period is associated with directories.

Examples

Options file example: DIRM managdir

Command line example: Not applicable

DOMAIN

DOMAIN

Use the DOMAIN option to specify the drives you want to include in your client domain for incremental backup. When you use this option in your client options file, it defines your *default client domain*. ADSM uses your default client domain to determine which local drives to process during an incremental backup in these situations:

- You run an incremental backup using the INCREMENTAL command without specifying which local drives to process.
- Your ADSM administrator defines a schedule to run an incremental backup for you, but does not specify which local drives to process.

If you do not specify local drives with the DOMAIN option in your client options file, the default is all local drives.

When you use this option with the INCREMENTAL command, it adds the local drives you specify to what is defined in your client options file. For example, if you enter DOMAIN c: d: e: in the client options file and you enter incremental -domain="g: h:" on the command line, ADSM performs an incremental backup for your **c:**, **d:**, **e:**, **g:**, and **h:** local drives.

If you use both the *drives* parameter and the DOMAIN option on the INCREMENTAL command, ADSM ignores the DOMAIN option and processes only those drives in the *drives* parameter. For example, if you enter the following, ADSM performs an incremental backup only for the **e:** and **f:**.

```
incremental e: f: -domain="g: h:"
```

Syntax

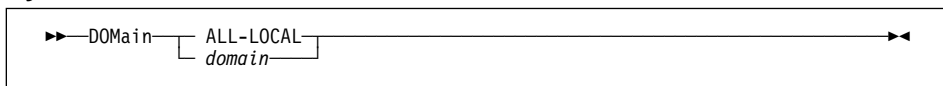

Parameters

domain

In your client options file, it is the drives to include in your default client domain.

When used with the INCREMENTAL command, it is the drives to process in addition to those specified in your default client domain.

The default value for this option is **ALL-LOCAL**, which specifies that all local hard drives are to be backed up.

Examples

Options file example: domain c: d: e:

Command line example: -domain="c: d:"

ERRORLOGRETENTION

ERRORLOGRETENTION

Use the ERRORLOGRETENTION option to specify:

- The number of days to keep entries in the error log
- Whether to save the pruned entries

The error log is pruned when the first error is written to the log after an ADSM session is started. If the only ADSM session you run is the scheduler, and you run it 24 hours a day, the error log might not be pruned according to your expectations. You must stop the session and restart it to allow the log to be pruned when the next error is written.

Syntax

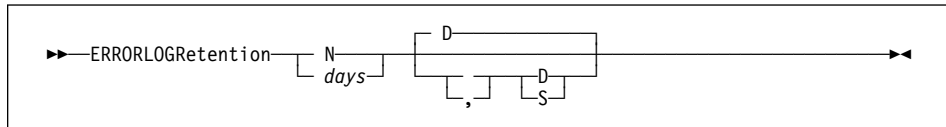

Parameters

N or *days*

How long to wait before pruning the error log.

N

Do not prune the error log. This allows the error log to grow indefinitely.

This is the default.

days

The number of days to keep log file entries before pruning the log.

The range of values is 0 to 9999.

D or S

Whether to save the pruned entries.

If you specify anything but D or S, ADSM uses the default D. You must use a space or comma to separate this parameter from the previous one.

D

Discard the log entries when pruning the log.

This is the default.

S

Save the log entries when pruning the log.

ADSM copies the entries pruned from the error log to **dsmerlog.pru**.

Examples

Options file example: ERRORLOGRETENTION 400 S

Command line example: -ERRORLOGRETENTION=400,S

EXCLUDE

EXCLUDE

Use the EXCLUDE option to exclude a file or group of files from ADSM backup services. When you back up files, any files you exclude with this option are not considered for backup.

For example, you might want to exclude all temporary files, any local caches of network files, all files that contain compiled object code that you can easily reproduce using other methods, and operating system files.

You can use wildcard characters to exclude a broad range of files. See “Including and Excluding Groups of Files” on page 71 for a list of wildcards you can use. Then, if necessary, you can use the INCLUDE option to make exceptions.

See “Creating an Include-Exclude List” on page 69 for more information. See also the list of files that should always be excluded in “Excluding System Files” on page 70.

Syntax

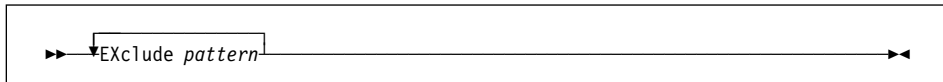

Parameters

pattern

The file or group of files that you want to exclude from backup services. The pattern must end with a file specification.

If the pattern contains a blank space, you must enclose the pattern in quotation marks.

Examples

Options file example:

```
exclude c:\ibmbio.com
exclude ?:\msdos.com
exclude ?:\ibmdos.com
exclude ?:\msdos.sys
exclude ?:\io.sys
exclude c:\*\budget.fin
exclude c:\devel\*
```

Command line example: Not applicable

FSTYPES

FSTYPES

Use the FSTYPES option to specify which types of file systems you want to see when looking at another node's file spaces on the ADSM server. This is only used when you are querying, restoring, or retrieving files from another node, allowing you to see non-FAT drives.

Syntax

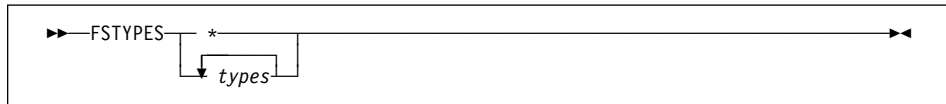

Parameters

- * Show all types of file spaces for the selected node. You can restore or retrieve files from the file spaces listed under *types*. (Although other types of file spaces might be listed, the results of restoring or retrieving files from those file spaces is unpredictable.)

types

Show these specific types of file spaces for the selected node:

FAT File Allocation Table drives.

RMT-FAT Remote FAT drives.

HPFS High-Performance File System drives (OS/2 and Windows NT).

RMT-HPFS Remote HPFS drives

NTFS NT File System drives (Windows NT).

RMT-NTFS Remote NTFS drives.

If you do not use the FSTYPES option, the default is to show only FAT and RMT-FAT drives.

Examples

Options file example: `fstypes fat rmt-fat`

Command line example: `-fstypes=*`

INCLUDE

INCLUDE

Use the INCLUDE option to specify one of the following:

- Files within a broad group of excluded files that you want to specifically include for backup services.
- Files to which you want to assign a specific management class and the management class name.
- A management class to assign to all files to which you do not explicitly assign a management class.

If you do not assign a specific management class to files, ADSM uses the default management class in the active policy set of your policy domain.

See “Creating an Include-Exclude List” on page 69 for more information.

Syntax

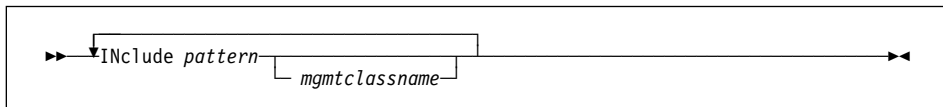

Parameters

pattern

The specific files you want to include for backup services, or the file or group of files to which you want to assign a specific management class.

You must end this variable with a file specification.

If the pattern contains a blank, you must enclose the pattern in quotation marks.

mgmtclassname

The name of the management class you want to assign to the files. If you do not specify a management class, ADSM uses the default management class.

Examples

Options file example:

Example 1

Explicitly include a subset of files that are excluded:

```
exclude c:\proj\text\*
include c:\proj\text\devel.*
```

Example 2

Assign a management class to a group of files:

```
include c:\proj\text\* textfiles
```

INCLUDE

Example 3

Specify a management class to assign to all files to which you have not assigned a specific management class:

```
include ?:* managall
```

This must be the *first* statement in your include-exclude list.

Use this method to assign a management class to all files to which you have not already assigned a specific management class and for which you do not want ADSM to use the default management class.

Command line example: Not applicable

IPXBUFFERSIZE

IPXBUFFERSIZE

Use the IPXBUFFERSIZE option to specify the size you want to use for the IPX buffer used to transfer data between the client node and the server.

A larger buffer can improve communication performance, but uses more memory.

Syntax

```
▶▶—IPXBufferSize size————▶▶
```

Parameters

size

The size you want to use, in kilobytes, for the IPX/SPX communication buffer.

The range of values is 1 to 16.

The default is 16.

Examples

Option file example: ipxb 8

Command line example: -ipxbuffersize=12

IPXSERVERADDRESS

IPXSERVERADDRESS

Use the IPXSERVERADDRESS option to specify the IPX/SPX address of an ADSM server on an OS/2 or AIX host that is not in the same network as the client node.

If the IPX/SPX address is not specified, the ADSM server must reside in the same network as the client node.

Syntax

```
▶—IPXServeraddress server_address—▶
```

Parameters

server_address

An IPX/SPX address for an ADSM server. It must consist of exactly 20 hexadecimal digits.

An IPX/SPX address is a concatenation of the following:

- The first 8 hexadecimal digits identify the ADSM server network address.
- The last 12 digits identify the ADSM server node address.

Each field must be padded with leading zeros if the value is shorter than the specified length.

If an IPX/SPX address is not specified, the default address for the server is the same as the address for the client workstation.

Examples

Option file example: `ipxse 0000000210005af6e7cc`

Command line example: `-ipxserveraddress=0000000210005af6e7cc`

IPXSOCKET

IPXSOCKET

Use the IPXSOCKET option to specify the socket number for an ADSM server on an OS/2 or AIX host.

Syntax

```
▶▶—IPXSocket socketnumber————▶▶
```

Parameters

socketnumber

A 4 digit ADSM server socket number. The socket number is assigned by Novell.

The default is 8522.

Examples

Option file example: ipxso 8524

Command line example: -ipxsocket=8524

LANADAPTER

LANADAPTER

Use the LANADAPTER option to specify a communication adapter number when using the NETBIOS communication method.

Syntax

```
▶—LANAdapter adapter_number—▶◀
```

Parameters

adapter_number

An adapter number for a communication adapter. It is used by NETBIOS.

The number must be 0 or 1.

The default is 0.

Examples

Options file example: `lan 0`

Command line example: `-lanadapter=1`

LANGUAGE

LANGUAGE

Use the LANGUAGE option to specify the national language for presenting client messages.

Syntax

```
▶▶—LANGUage language————▶▶
```

Parameters

language

The language you want to use. You can use American English (AMENG) with all clients. To use a different language, you must order the client in that language. Not all clients are available in all languages.

The languages available are:

AMENG	American English. This is the default.
FRENCH	French.
GERMAN	German.
ITALIAN	Italian.
JAPAN	Japanese.
SPANISH	Spanish.
SWEDISH	Swedish.

Examples

Option file example: LANGUAGE AMENG

Command line example: Not applicable.

MAXCMDRETRIES

MAXCMDRETRIES

Use the MAXCMDRETRIES option to specify the maximum number of times you want the client scheduler on your workstation to attempt to process a scheduled command that fails.

ADSM uses this option only when the SCHEDULE command is running.

Your ADSM administrator can also set this option. If your ADSM administrator specifies a value for this option, that value overrides what you specify in the client options file after your client node successfully contacts the ADSM server.

Syntax

```
▶▶—MAXCMDRetries maxcmdretries————▶▶
```

Parameters

maxcmdretries

The number of times the client scheduler can attempt to process a scheduled command that fails.

The range of values is 0 to 9999.

The default value is 2.

Examples

Options file example: MAXCMDR 4

Command line example: -MAXCMDRETRIES=3

NETBIOSBUFFERSIZE

NETBIOSBUFFERSIZE

Use the NETBIOSBUFFERSIZE option to specify the size you want to use, in kilobytes, for the NETBIOS communication buffer.

Syntax

```
▶▶—NETBIOSbuffersize size————▶▶
```

Parameters

size

The size you want to use for the NETBIOS communication buffer.

The range of values is 1 to 31.

The default is 16.

Examples

Options file example: netbiosb 1

Command line example: -netbiosbuffersize=1

NETBIOSNAME

NETBIOSNAME

Use the NETBIOSNAME option to specify a NETBIOS name for your workstation.

Syntax

```
▶—NETbiosname name—▶◀
```

Parameters

name

A NETBIOS name for your workstation.

The name can be a maximum of 16 characters and is case sensitive. The first character cannot be an asterisk (*), and the first three characters cannot be the letters IBM.

The default is ADSM concatenated with a time of day value.

Examples

Options file example: netbiosname adsmjohn

Command line example: -netbiosname=adsmwkst1

NETBIOSERVERNAME

NETBIOSERVERNAME

Use the NETBIOSERVERNAME option to specify a NETBIOS name for an ADSM server.

Syntax

```
▶▶—NETBIOSServername name————▶▶
```

Parameters

name

A NETBIOS name for an ADSM server.

The name can be a maximum of 16 characters and is case sensitive. The first character cannot be an asterisk (*), and the first three characters cannot be the letters IBM.

The default is ADSMSERV1.

Examples

Options file example: netbioss admserv2

Command line example: -netbiosservername=admserv2

NETBIOSTIMEOUT

NETBIOSTIMEOUT

Use the NETBIOSTIMEOUT option to specify the number of seconds that must elapse before a timeout occurs for a NETBIOS send or receive. If your LAN environment has slow response times or you are backing up directly to tape, it is recommended that you use a value of 0.

Syntax

```
▶▶—NETBIOSTimeout seconds————▶▶
```

Parameters

seconds

The number of seconds that must elapse before a timeout occurs for a NETBIOS send or receive.

The range of values is 1 to 120. A value of 0 results in no timeout.

The default is 60.

Examples

Options file example: `netbiostimeout 30`

Command line example: `-netbiostimeout=30`

NODENAME

NODENAME

Use the NODENAME option to identify your workstation to the server. You can use different node names to identify multiple systems on your workstation. For example, if your machine is running both DOS and OS/2, you can specify *dosuser* for the first client system and *os2user* for the second client system.

You can also use the NODENAME option if you want to restore or retrieve files from the server while you are working from a different workstation. When you use the NODENAME option, ADSM prompts you for the ADSM password assigned to the node you specify if a password is required.

Syntax

```
▶▶—NODename nodename————▶▶
```

Parameters

nodename

A 1 to 64 character name to identify the node for which you want to request ADSM services.

Examples

Option file example: NODENAME cougar

Command line example: -NOD=banshee

NUMBERFORMAT

NUMBERFORMAT

Use the NUMBERFORMAT option to specify the format you want ADSM to use for displaying numbers.

Syntax

```
▶—NUMBERformat number————▶◀
```

Parameters

number

One of the following number formats:

- 1 Displays numbers in this format: 1,000.00
This is the default.
- 2 Displays numbers in this format: 1,000,00
- 3 Displays numbers in this format: 1 000,00
- 4 Displays numbers in this format: 1 000.00
- 5 Displays numbers in this format: 1.000,00
- 6 Displays numbers in this format: 1'000,00

Examples

Options file example: num 4

Command line example: -numberformat=4

PARTNERLUNAME

PARTNERLUNAME

Use the PARTNERLUNAME option to specify a logical unit name used by the transaction program to identify the ADSM server in the SNA network.

The partner logical unit name is used if the symbolic destination name is not provided for either SNA LU6.2 or PWSCS communications.

If you use this option, you must also define the CPICMODENAME and TPNAME options.

Syntax

```
▶▶—PARTnerluname logical_unit_name————▶▶
```

Parameters

logical_unit_name

A 1 to 64 character LU name used to identify the remote target in a SNA network. Contact your system administrator for this name.

There is no default.

Examples

Options file example: partnerlu ALMVMA

Command line example: -par=SANJOSEVM

POSTSCHEDULECMD

POSTSCHEDULECMD

Use the POSTSCHEDULECMD option to specify a command that ADSM should process after running a schedule.

ADSM waits for the command to complete before continuing with other processing.

Syntax

```
▶—POSTschedulecmd "cmdstring"————▶
```

Parameters

"cmdstring"

The command to process.

You can use only one POSTSCHEDULECMD option. You can also issue a command before a schedule using the PRESCHEDULECMD option.

Use a blank or null string for *cmdstring* if you want to prevent any commands that the ADSM administrator uses for POSTSCHEDULECMD and PRESCHEDULECMD from running. If you specify a blank or null string on *either* option, it prevents the administrator from using a command on *both* options.

However, if your administrator uses a blank or null string on the POSTSCHEDULECMD option, that prevents you from running a post-schedule command.

If the command string contains blanks, you must enclose it in double quotes. If you have double quotes within the command string, use single quotes to enclose them.

Examples

Options file example: postschedulecmd "restart database"
 where the command string is a valid command for
 restarting your database.

Command line example: Not applicable

QUERYSCHEDPERIOD

QUERYSCHEDPERIOD

Use the QUERYSCHEDPERIOD option to specify the number of hours you want the client scheduler to wait between attempts to contact the ADSM server for scheduled work.

This option applies only when the SCHEDMODE option is set to POLLING. ADSM uses this option only when the SCHEDULE command is running.

Your ADSM administrator can also set this option. If your ADSM administrator specifies a value for this option, that value overrides what you specify in the client options file after your client node successfully contacts the ADSM server.

Syntax

```
▶▶—QUERYSCHedperiod hours—————▶▶
```

Parameters

hours

The number of hours the client scheduler waits between attempts to contact the ADSM server for scheduled work.

The range of values is 1 to 9999.

The default is 12.

Examples

Options file example: QUERYSCH 6

Command line example: -QUERYSCHEDPERIOD=8

QUIET

QUIET

Use the QUIET option to keep messages from being displayed on your screen during ADSM processing.

For example, when you run the INCREMENTAL or SELECTIVE command, ADSM displays information about each file it backs up. You can use the QUIET option if you do not wish to view that information.

When you use the QUIET option, certain error information still appears on your screen, and messages are written to log files.

If you do not specify QUIET, ADSM uses the VERBOSE option by default.

Syntax

```
▶▶—Quiet—◀◀
```

Examples

Options file example: quiet

Command line example: -q

REPLACE

REPLACE

Use the REPLACE option to specify what you want ADSM to do when restoring files that already exist on your workstation. This applies only to the RESTORE and RETRIEVE commands.

Syntax

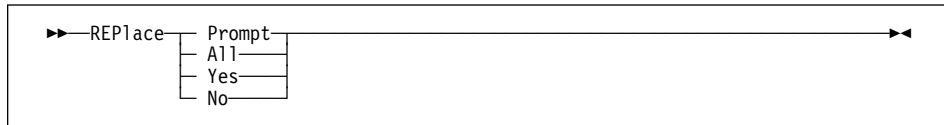

Parameters

Prompt

ADSM prompts you for your choice for overwriting a file when it encounters an existing file during a restore or retrieve process. If the existing file is a read-only file, you cannot overwrite it.

This is the default.

All

ADSM overwrites any existing files, including read-only files.

Yes

ADSM overwrites any existing files, except read-only files. You can also specify Yes as True, 1, or ON.

No

ADSM does not overwrite any existing files. You can also specify No as False, 0, or OFF.

Examples

Options file example: `replace all`

Command line example: `-replace=off`

RETRYPERIOD

RETRYPERIOD

Use the RETRYPERIOD option to specify the number of minutes you want the client scheduler to wait between attempts to process a scheduled command that fails or between unsuccessful attempts to report results to the server.

ADSM uses this option only when the SCHEDULE command is running.

Your ADSM administrator can also set this option. If your ADSM administrator specifies a value for this option, that value overrides what you specify in the client options file after your client node successfully contacts the ADSM server.

Syntax

```
▶▶—RETRYPeriod minutes—————▶▶
```

Parameters

minutes

The number of minutes the client scheduler waits between attempts to contact the ADSM server or attempts to process a scheduled command that fails.

The range of values is 1 to 9999.

The default is 20.

Examples

Options file example: RETRYP 10

Command line example: -RETRYPERIOD=15

SCHEDLOGNAME

SCHEDLOGNAME

Use the SCHEDLOGNAME option to specify the name and location of a file where you want ADSM to store the schedule log.

When you run the SCHEDULE command, output from scheduled commands appears on your screen. It is also directed to the file you specify with this option.

ADSM uses this option only when the SCHEDULE command is running.

Syntax

```
▶—SCHEDLOGname filespec—————▶◀
```

Parameters

filespec

The path and file name where you want ADSM to store schedule log information when processing scheduled work. If you specify only a file name, ADSM stores the file in your current directory.

The default is the installation directory and a file name of **dsmsched.log**.

Examples

Options file example: schedlogname c:\mydir\schedlog.jan

Command line example: -schedlog=c:\mydir\schedlog.jan

SCHEDLOGRETENTION

SCHEDLOGRETENTION

Use the SCHEDLOGRETENTION option to specify:

- The number of days to keep entries in the schedule log
- Whether to save the pruned entries

The schedule log is pruned after a scheduled event completes.

Syntax

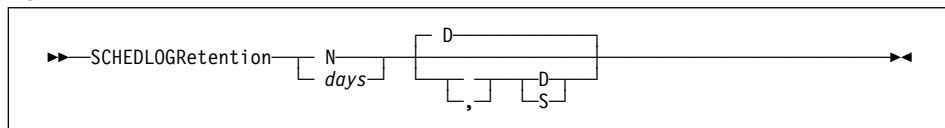

Parameters

N or *days*

How long to wait before pruning the schedule log.

N

Do not prune the log. This allows the log to grow indefinitely.

This is the default.

days

The number of days to keep log file entries before pruning the log.

The range of values is 0 to 9999.

D or S

Whether to save the pruned entries.

If you specify anything but D or S, ADSM uses the default D. You must use a space or comma to separate this parameter from the previous one.

D

Discard the log entries when pruning the log.

This is the default.

S

Save the log entries when pruning the log.

ADSM copies the entries pruned from the log to **dsmsched.pru**.

Examples

Options file example: SCHEDLOGRETENTION 30 S

Command line example: -SCHEDLOGRETENTION=30,S

SCHEDMODE

SCHEDMODE

This option only applies if you are using the TCP/IP communication method and the SCHEDULE command is running.

Use the SCHEDMODE option to specify which ADSM schedule mode to use. The schedule mode determines whether your client node periodically asks the ADSM server for scheduled work (POLLING), or whether the ADSM server contacts your client node when it is time to start a scheduled operation (PROMPTED).

All communication methods can use POLLING, but only TCP/IP can use PROMPTED.

Your ADSM administrator can specify that either mode is supported by the ADSM server, or only one mode is supported. If your ADSM administrator specifies either, you can choose the schedule mode. If your ADSM administrator specifies only one mode, you must specify that same mode in your client options file. Otherwise, scheduled work is not processed.

If the scheduling mode is PROMPTED, you can supply values for the TCPCLIENTADDRESS and TCPCLIENTPORT on the SCHEDULE command. This allows you to be contacted at an address or port other than the one that made initial contact with the server.

Syntax

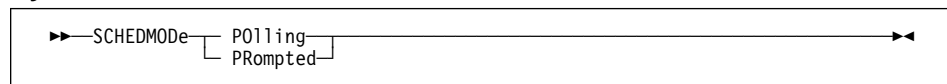

Parameters

POLLING

The client scheduler should query the ADSM server for scheduled work at pre-scribed time intervals set with the QUERYSCHEDPERIOD option.

This is the default.

PROMPTED

The client scheduler should wait for the ADSM server to contact your client node when scheduled work needs to be done.

Examples

Options file example: SCHEDMODE PROMPTED

Command line example: -SCHEDMOD=PO

SCROLLINES

SCROLLINES

Use the SCROLLINES option to specify the number of lines you want to appear at one time when ADSM displays lists of information on your screen.

ADSM uses this option only when you set the SCROLLPROMPT option to Yes and you are using ADSM commands.

Syntax

```
▶▶—SCROLLlines number————▶▶
```

Parameters

number

The number of lines you want ADSM to display at one time when displaying lists of information on your screen.

The range of values is 1 to 80.

The default is 20.

Examples

Options file example: SCROLLINES 25

Command line example: -SCROLL=25

SCROLLPROMPT

SCROLLPROMPT

Use the SCROLLPROMPT option to specify whether you want ADSM to stop and wait after displaying the number of lines you specify with the SCROLLLINES option, or scroll through all lines and stop at the end of the list.

Syntax

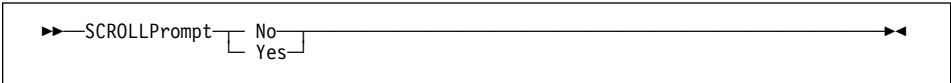

Parameters

No

ADSM scrolls to the end of the list and stops. You can also specify No as OFF, False, or 0.

This is the default.

Yes

ADSM stops and waits after displaying the number of lines indicated with the SCROLLLINES option. ADSM displays the following prompt at the bottom of the screen:

Press 'Q' to quit, 'C' to continuous scroll, or 'Enter' to continue.

You can also specify Yes as On, True, or 1.

Examples

Options file example: SCROLLPRO Yes

Command line example: -SCROLLP=Yes

SLOWINCREMENTAL

SLOWINCREMENTAL

Use the SLOWINCREMENTAL option to specify a slower algorithm for processing incremental backups. With the SLOWINCREMENTAL option, ADSM backs up one directory at a time, and so uses less memory. However, the backup operation takes longer to complete.

Use this option with the INCREMENTAL command when your machine is running low on memory.

Syntax

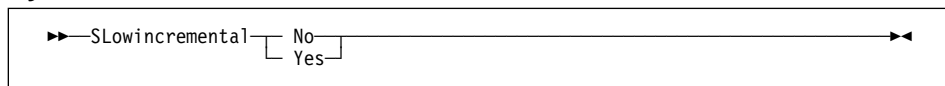

Parameters

No

Your client node uses the fastest, most memory-intensive method when processing incremental backups. You can also specify No as OFF, False, or 0.

This is the default.

Yes

Your client node uses the method that uses less memory when processing incremental backups. You can also specify Yes as ON, True, or 1.

Examples

Options file example: slowincremental yes

Command line example: -s1=no

SUBDIR

SUBDIR

Use the SUBDIR option to specify whether you want ADSM to include subdirectories of specified directories on the following commands:

ARCHIVE
DELETE ARCHIVE
QUERY ARCHIVE
QUERY BACKUP
RESTORE
RETRIEVE
SELECTIVE

Syntax

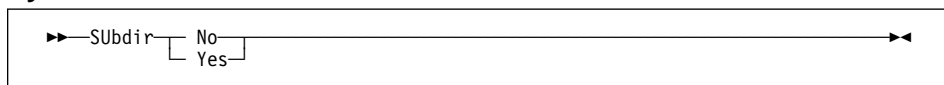

Parameters

No

ADSM does not process subdirectories. You can also specify No as OFF, False, or 0.

This is the default.

Yes

ADSM processes subdirectories. You can also specify Yes as ON, True, or 1.

Because ADSM searches all the subdirectories of a directory being processed, it can take longer for ADSM to complete the requested task than if SUBDIR were **No**. Therefore, you should only use **Yes** when necessary.

Examples

Options file example: SUBDIR Yes

Command line example: -SU=Yes

SYMBOLICDESTINATION

SYMBOLICDESTINATION

Use the SYMBOLICDESTINATION option to specify a symbolic ADSM server name. Contact your ADSM administrator to get the correct name. The symbolic destination name indexes SNA routing and security parameters that are stored in communication directory files.

When a symbolic destination is used with the COMMMETHOD option for SNA LU6.2 or PWSCS communication, you do not have to specify the TPNAME, PARTNERLUNAME, or CPICMODENAME options.

This option is required if your communication protocol is SNA LU6.2 or PWSCS and a transaction program name or partner logical unit name is not provided.

Syntax

```
▶▶—SYMBOLICDESTINATION sym_dest_name————▶▶
```

Parameters

sym_dest_name

A 1 to 8 character symbolic destination name for the ADSM server. Contact your ADSM administrator to get this name.

There is no default.

Examples

Options file example: symbolicdestination adsm

Command line example: -sym=anrserv

TAPEPROMPT

TAPEPROMPT

Use the TAPEPROMPT option to specify whether you want ADSM to wait for a tape to be mounted if required for a backup, archive, restore, or retrieve process, or prompt you for your choice.

Syntax

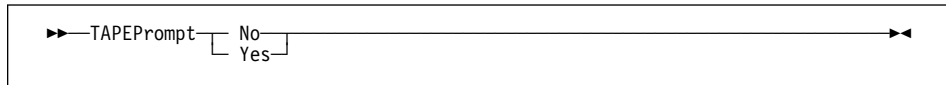

Parameters

No

You are not prompted for your choice. ADSM waits for the appropriate tape to be mounted. You can also specify No as OFF, False, or 0.

This is the default.

Yes

ADSM prompts you when a tape is required when you issue a command that backs up, archives, restores, or retrieves data. At the prompt, you can choose whether to wait for the appropriate tape to be mounted. If you choose not to wait, the file is not processed. You can also specify Yes as ON, True, or 1.

Examples

Options file example: TAPEPROMPT NO

Command line example: -TAPEP=NO

TCPBUFFSIZE

TCPBUFFSIZE

Use the TCPBUFFSIZE option to specify the size you want to use for the ADSM internal TCP/IP communication buffer.

A larger buffer can improve communication performance, but uses more memory.

Syntax

```
▶▶—TCPBuffsize size————▶▶
```

Parameters

size

The size you want to use, in kilobytes, for the ADSM internal TCP/IP communication buffer.

This should be the same size as TCPWINDOWSIZE for the most efficient operation.

The range of values is 1 to 32.

The default is 8.

Examples

Options file example: `tcpb 2`

Command line example: `-tcpbuffsize=31`

TCPCLIENTADDRESS

TCPCLIENTADDRESS

Use the TCPCLIENTADDRESS option to specify a TCP/IP address if your client node has more than one address, and you want the server to contact a different address than the one used to make initial contact with the server.

You can use this option only if you are using PROMPTED for SCHEDMODE.

ADSM uses this option only when the SCHEDULE command is running.

Syntax

```
▶—TCPCLIENTAddress client_address—————▶◀
```

Parameters

client_address

The TCP/IP address you want the ADSM server to use to contact your client node.

The value you specify for this parameter can be a TCP/IP Internet domain name or a dot address.

Examples

Options file example: `tcpclienta dsmcInt.sanjose.ibm.com`

Command line example: `-tcpclientaddress=128.33.10.249`

TCPCLIENTPORT

TCPCLIENTPORT

Use the TCPCLIENTPORT option to specify a TCP/IP port number if you want the ADSM server to contact a different port than the one used to make initial contact with the server.

You can use this option only if you are using PROMPTED for SCHEDMODE.

ADSM uses this option only when the SCHEDULE command is running.

If the default or specified port is busy, ADSM attempts to use any other available port.

Syntax

```
▶▶—TCPCLIENTPort client_port_address————▶▶
```

Parameters

client_port_address

The TCP/IP port address you want the ADSM server to use to contact your client node.

The range of values is 1000 to 32767.

The default is 1501.

Examples

Options file example: tcpclientp 1502

Command line example: -tcpclientport=1492

TCPPOINT

TCPPOINT

Use the TCPPOINT option to specify a server's TCP/IP port address.

Obtain this port address from your ADSM administrator.

Syntax

```
▶—TCPPOINT port_address—▶
```

Parameters

port_address

The TCP/IP port address used to communicate with an ADSM server.

The range of values is 1000 to 32767.

The default is 1500.

Examples

Options file example: `tcpport 1501`

Command line example: `-tcpport=1492`

TCPSERVERADDRESS

TCPSERVERADDRESS

Use the TCPSERVERADDRESS option to specify the TCP/IP address for an ADSM server.

Obtain this server address from your ADSM administrator.

Syntax

```
▶▶—TCPServeraddress server_address————▶▶
```

Parameters

server_address

A 1 to 64 character TCP/IP address for an ADSM server.

The value you specify for this parameter can be a TCP/IP Internet domain name or a dot address.

Examples

Options file example: `tcps dsmchost.endicott.ibm.com`

Command line example: `-tcpserveraddress=129.33.249`

TCPWINDOWSIZE

TCPWINDOWSIZE

Use the TCPWINDOWSIZE option to specify the size of the TCP/IP sliding window you want to use for your client node. This is the size of the buffer used when sending or receiving data.

A larger size can improve communication performance, but uses more memory.

Syntax

```
▶—TCPWindowsize window_size—▶
```

Parameters

window_size

The size you want to use, in kilobytes, for the TCP/IP sliding window for your client node.

This should be the same size as TCPBUFSIZE for the most efficient operation. It should be no smaller than the packet size for your network hardware. To calculate the ideal size, multiply the packet size by 1 less than the number of packets that are transferred at once (the large packet size number).

For example, if the number of packets is 5, and the packet size is 2KB, multiply 4 by 2. The result is an 8KB TCP/IP sliding window size.

The range of values is 1 to 24.

The default is 16.

Examples

Options file example: `tcpwindowsize 1`

Command line example: `-tcpw=24`

TIMEFORMAT

TIMEFORMAT

Use the TIMEFORMAT option to select the format you want ADSM to use for displaying the system time.

Syntax

```
▶▶—TIMEformat format_number————▶▶
```

Parameters

format_number

One of the following time formats:

- 1 Displays time in this format: 23:00:00
This is the default.
- 2 Displays time in this format: 23,00,00
- 3 Displays time in this format: 23.00.00
- 4 Displays time in this format: 12:00:00A/P

Examples

Options file example: TIMEFORMAT 4

Command line example: -TIME=3

TPNAME

TPNAME

Use the TPNAME option to specify a symbolic name for the transaction program name. The transaction program name is required if the symbolic destination name is not provided for either SNA LU6.2 or PWSCS communication.

If you use this option, you must also define the CPICMODENAME and PARTNERLUNAME options.

Syntax

```
▶▶TPname symbolic_name▶▶
```

Parameters

symbolic_name

The 1 to 64 character transaction program name of the target logical unit (the ADSM server).

Contact your ADSM administrator for this name.

There is no default.

Note: To communicate with an AIX ADSM server, the *symbolic_name* must be **dsmserv** in all lower-case letters.

Examples

Options file example: tpname adsm

Command line example: -tp=adsm

TXNBYTELIMIT

TXNBYTELIMIT

Use the TXNBYTELIMIT option to select the number of kilobytes ADSM should buffer before sending a transaction to the server.

A *transaction* for ADSM can have two meanings:

1. The action taken for each file or directory processed due to client request. This result is displayed in the GUI clients on the Status window, and in the command-line clients in the output associated with a command. These kinds of transactions can include successful backing up, archiving, deleting, and so forth, of a file or directory.
2. The action taken between ADSM server data commitments. Because ADSM can transfer more than one file or directory between the client and server before committing the data to server storage, a transaction in this sense can contain more than one file or directory. This is sometimes referred to as a *transaction group*.

The transaction processing option relates to the second meaning of *transaction*. This option allows you to control the amount of data sent between the client and server before the server commits the data and changes to the server's database, thus altering the speed with which your client performs work. This limit applies when files are batched together during backup. It is also used when receiving files from the server during restore.

The server can limit the number of files or directories contained within a group transaction (with the TXNGROUPMAX option), however, so the actual size of a transaction can be less than your limit. TXNGROUPMAX determines the number of files or directories that can be sent in a single transaction. Once this number is reached, the client sends the files to the server even if the transaction byte limit is not reached.

Syntax

▶▶—TXNByteLimit *number*————▶▶

Parameters

number

The number of kilobytes ADSM can buffer together in a transaction before sending data to the server.

The range of values is 1 to 25600 (25 MB).

The default is 1024.

Examples

Options file example: txnb 1024

Command line example: -txnb=1024

VERBOSE

VERBOSE

Use the VERBOSE option to specify that you want processing information to appear on your screen.

For example, when you run the INCREMENTAL command, ADSM generates information about each file it backs up. You can use the VERBOSE option if you want ADSM to display that information on your screen.

The alternative is the QUIET option. If you do not specify either option, VERBOSE is the default.

Syntax

```
▶▶—Verbose—————▶▶
```

Examples

Options file example: VERBOSE

Command line example: -V

3270BUFFERSIZE

3270BUFFERSIZE

Use the 3270BUFFERSIZE option to specify the size of the 3270 communication buffer, which is used to transfer data between the client node and the server. A large buffer size may increase the data transfer rate, but it also requires more memory and may cause the termination of a 3270 terminal session. Set a buffer size of at least 4000 bytes unless memory constraints or line conditions dictate otherwise.

Attention: Raising the value too high may cause your 3270 terminal session to fail.

Syntax

▶▶—3270Buffersize <i>size</i> ————▶▶

Parameters

size

The size of the buffer in bytes. Contact your system administrator for the recommended size.

The range of values is 512 to 65508.

The default is obtained from the emulator file transfer buffer size.

Examples

Options file example: 3270buffersize 4000

Command line example: -3270buffersize=4000

3270CHECKSUM

3270CHECKSUM

Use the 3270CHECKSUM option to specify whether ADSM should check the validity of the data being sent between a 3270 client session and the server. To ensure data integrity, ADSM checks to see if the data contains a trailing two-byte checksum.

Syntax

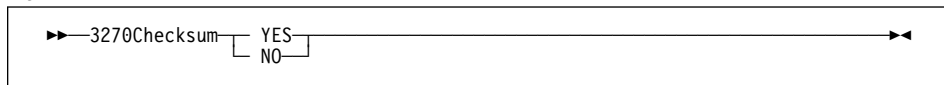

Parameters

YES

Turns validity checking on.

This is the default.

NO

Turns validity checking off.

Examples

Options file example: 3270checksum no

Command line example: -3270checksum=no

3270HOSTCMDPAUSE

3270HOSTCMDPAUSE

Use the 3270HOSTCMDPAUSE option to specify the number of seconds to pause between sending AID (attention) keys to the host, as specified by the 3270 host command option.

Use this option when the host response time is slow. If the value of the seconds parameter is too small and the host response time is slow, errors may occur when sending keystrokes to the host session. When system response time is slow, a value of 3 to 5 seconds may be appropriate.

Syntax

```
▶▶—3270HOSTCMDPause seconds————▶▶
```

Parameters

seconds

The number of seconds to pause between sending interrupts.

The default is 1.

Examples

Options file example: 3270hostcmdpause 3

Command line example: -3270hostcmdpause=3

3270HOSTCOMMAND

3270HOSTCOMMAND

Use the 3270HOSTCOMMAND option to specify a sequence of commands to start a 3270 client/server session. Because the connection to the server uses the 3270 datastream dialup interface, the terminal session should not have an active user at the time the session is started. You can embed special control characters in the command string. Any character not preceded by the control character @ is read as text.

The control characters and their associated function are listed below. Control characters are case sensitive.

Figure 50. Control Characters for the 3270 host command. Control characters are case sensitive.

@B (Left Tab)	@C (Clear)	@D (Delete)	@E (Enter)
@F (Erase EOF)	@I (Insert)	@L (Cursor Left)	@N (New Line)
@R (Reset)	@T (Right Tab)	@U (Cursor Up)	@V (Cursor Down)
@Z (Cursor Right)	@O (Home)	@1 (PF1)	@2 (PF2)
@3 (PF3)	@4 (PF4)	@5 (PF5)	@6 (PF6)
@7 (PF7)	@8 (PF8)	@9 (PF9)	@a (PF10)
@b (PF11)	@c (PF12)	@d (PF13)	@e (PF14)
@f (PF15)	@g (PF16)	@h (PF17)	@i (PF18)
@j (PF19)	@k (PF20)	@l (PF21)	@m (PF22)
@n (PF23)	@o (PF24)	@x (PA1)	@y (PA2)
@z (PA3)	@@ (@)	@\$ (Alternate Cursor)	@< (Backspace Erase)
@AF (Erase Input)	@AH (System Request)	@AJ (Cursor Select)	@AQ (Attention)

Syntax

```
▶—3270HOSTCOMMAND cmd_string—▶▶
```

Parameters

cmd_string

A sequence of commands used to start a 3270 client/server session. This command string is limited to 255 characters. Up to 20 control characters are allowed in the string.

Examples

Options file example: 3270hostcommand @Cdial anrserv@E

Command line example: -3270hostcommand="@Cdial anrserv@E"

3270HOSTENDCOMMAND

3270HOSTENDCOMMAND

Use the 3270HOSTENDCOMMAND option to issue a command to your server at the end of an ADSM client session to bring the host to the desired state. This parameter specifies what character stream is sent to the server when a 3270 client session ends.

Syntax

```
▶▶—3270HOSTEndcommand cmd_string————▶▶
```

Parameters

cmd_string

A command string to be sent to the server when a 3270 client/server session ends. The command string is limited to 255 characters. No more than 20 control characters are permitted in the string. See Figure 50 on page 131 for more information.

Examples

Options file example: 3270hoste @3

Command line example: -3270hostendcommand="@3"

3270HOSTTIMEOUT

3270HOSTTIMEOUT

Use the 3270HOSTTIMEOUT option to specify the number of seconds the client node waits to receive a data packet from the server before timing out. You may need a larger value than 10 seconds when host response time is extremely slow or when you restore large files.

Syntax

```
▶▶—3270HOSTTImeout seconds————▶▶
```

Parameters

seconds

The number of seconds a client node waits to receive data from the server before timing out.

The minimum value is 1.

The default is 10.

Examples

Options file example: 3270hosttimeout 20

Command line example: -3270hostti=20

3270LOGICALTERMINALID

3270LOGICALTERMINALID

Use the 3270LOGICALTERMINALID option to specify a 3270 logical terminal session the ADSM client should use.

Syntax

```
▶▶—3270Logicalterminalid id————▶▶
```

Parameters

id

A logical terminal session.

The default is A.

Examples

Options file example: 3270logicalterminalid c

Command line example: -3270l=c

400COMMBUFFERBYTES

400COMMBUFFERBYTES

Use the 400COMMBUFFERBYTES option to specify the size of the router communication buffer. A larger buffer can improve communication performance but requires more memory.

This option is used with the PC Support/400 or Client Access/400 APPC communication methods.

Syntax

```
▶—400Commbufferbytes bytes————▶◀
```

Parameters

bytes

The size of the buffer in bytes.

The range of values is 271 to 32767.

The default is 16,382 (16 KB).

Examples

Options file example: 400Commbufferbytes 4096

Command line example: -400C=2048

400PARTNERLUNAME

400PARTNERLUNAME

Use the 400PARTNERLUNAME option to specify the name of the AS/400 system running the ADSM server.

Syntax

```
▶▶—400Partnerluname name————▶▶
```

Parameters

name

The name of the AS/400 system running the ADSM server.

The name may be up to 17 characters in length.

There is no default name.

Examples

Option file example: 400Partnerluname AS400

Command line example: -400P=AS400

400SENDBUFFERBYTES

400SENDBUFFERBYTES

Use the 400SENDBUFFERBYTES option to specify the size of the client communication buffer, which is used to transfer data between the client node and the server.

A larger buffer can improve communication performance but requires more memory.

This option is used with the PC Support/400 or Client Access/400 APPC communication methods.

Syntax

```
▶—400Sendbufferbytes bytes————▶◀
```

Parameters

bytes

The size of the buffer in bytes.

The range of values is 271 to 32767.

The default is 16,384 (16 KB).

Examples

Options file example: 400Sendbufferbytes 16384

Command line example: -400S=12288

400TPNAME

400TPNAME

Use the 400TPNAME option to specify the name of the ADSM server on OS/400.

Syntax

```
▶▶—400Tpname tpname————▶▶
```

Parameters

tpname

The 1 to 64 character transaction program name of the ADSM server for OS/400.
Contact your system administrator for this name.

Examples

Option file example: 400Tpname QANRTP.QADSM

Command line example: -400T=QANRTP.QADSM

Chapter 7. Using Commands

ADSM provides a command line interface that you can use as an alternative to the graphical user interface.

This chapter provides information about starting and ending a client command session and instructions for entering commands. It also contains a command reference section that provides detailed information about each ADSM command.

Starting and Ending a Client Command Session

You can start a client command session in either batch or interactive mode.

Using Batch Mode

Use *batch* mode when you want to issue a single client command. ADSM processes the command and returns to the command prompt.

When you enter an ADSM command in batch mode, you must precede it with one of the commands listed in Figure 51, based on the communication software you are using.

Figure 51. Command Line Interface Commands (DSMC Commands)

Command	Communication Software
DSMCATM	Attachmate Extra! (3270)
DSMCCPIC	PWSCS
DSMCFTP	FTP Software TCP/IP
DSMCIBM	IBM TCP/IP 2.1
DSMCIPX	IPX/SPX
DSMCI20	IBM TCP/IP 2.0
DSMCNET	NETBIOS
DSMCNSD	Networking Services/DOS (SNA LU6.2)
DSMC3270	PC3270
DSMC400	PC Support/400 or Client Access/400

For example, to issue the INCREMENTAL command in batch using IBM TCP/IP 2.1, enter:

```
dsmcibm incremental
```

If a password is required, ADSM prompts you for your password. Type your password, then press Enter. When you type your password, it does not appear on the screen.

ADSM processes the command and returns to the command prompt.

You can also enter your password on the command using the `PASSWORD` option. However, ADSM cannot hide the password if you use the `PASSWORD` option.

For example, if your password is **secret**, you can enter:

```
dsmcibm incremental -password=secret
```

Using Interactive Mode

Use *interactive* mode, or *loop* mode, when you want to issue a series of commands. Because ADSM only needs to establish the connection to the server once for interactive mode, ADSM can process a series of commands more quickly in interactive mode than it can in batch mode.

Use the `LOOP` command to start a client command session in interactive mode. Because `LOOP` is the default for the `DSMC` commands, you do not need to include `LOOP`:

```
dsmcibm
```

When you are in interactive mode, the command prompt is:

```
dsmc>
```

When in interactive mode, do not precede ADSM commands with any of the `DSMC` commands. After processing a command, ADSM returns to the `dsmc>` prompt.

When you enter the first command in interactive mode, ADSM prompts you for your password if it is required. Type your password, then press Enter. When you type your password, it does not appear on the screen.

You can also enter your password on the `LOOP` command using the `PASSWORD` option.

To end an interactive session, enter **quit** at the prompt.

Entering Client Commands

A client command can include one or more of these components:

- Command name
- Parameters
- Options

Command Name

The first component of a command is the command name. The command name is the unique identifier for the command. It can consist of a single action word, such as `HELP` or `SCHEDULE`, or it can consist of an action word and an object for the action, such as `QUERY ARCHIVE`.

You can enter the entire command name or its abbreviation. In a syntax diagram, uppercase letters indicate the shortest acceptable abbreviation. Here is an example of how a command name appears in a syntax diagram:

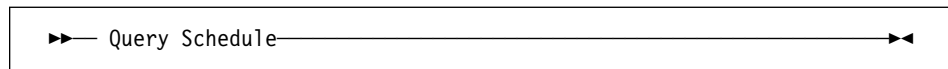

To issue the QUERY SCHEDULE command, you can enter the full command name, the minimum abbreviation, or an abbreviation that at least contains the minimum abbreviation. For example, any of the following are correct versions of QUERY SCHEDULE:

```
query schedule
q s
q sched
query s
```

Parameters

Some commands have required parameters, optional parameters, or both. You must enter parameters in the order indicated in the syntax diagram for a command.

Required Parameters

Required parameters supply ADSM with information it needs to perform a task. The most common required parameter is a file specification. For example, when you use the ARCHIVE command, you must specify the file or files you want to archive.

For example, to archive a file named **budget.fin** from the **c:\project** directory, you can enter:

```
archive c:\project\budget.fin
```

Optional Parameters

Some commands have optional parameters. If you do not enter a value for an optional parameter, ADSM uses a default value.

For example, the RESTORE command has a required parameter, *sourcefilespec*, that specifies the files you want to restore, and an optional parameter, *destinationfilespec*, that specifies where you want to place the restored files. If you do not use *destinationfilespec*, ADSM restores the file to the original source path by default.

If you want to restore the file to a different directory, enter a value for *destinationfilespec*. For example, to restore **c:\project\budget.fin** to **c:\newproj\newbudg.fin**, enter:

```
restore c:\project\budget.fin c:\newproj\newbudg.fin
```

Options

You can use options with all commands. There are two groups of options from which you can choose:

- Client options—The group of options set in your client options file. You can override any option in that file by entering the option with an appropriate command.
Client user options specific to particular commands are discussed with those commands in the command reference. You can also find detailed information about each option in “Client Options Reference” on page 75.
- Client command options—The group of options you can use with specific commands on the command line only. Figure 52 provides an alphabetical listing of those options.

For detailed information about entering options with commands see “Using Options With Commands” on page 68.

Figure 52 (Page 1 of 2). Options Used on Command Line Only

Option	Use with these commands:	Description
ARCHMC	ARCHIVE	Overrides the assigned management class for a file or group of files.
DELETEFILES	ARCHIVE	Deletes archived files from your workstation after the archives are committed to server storage.
DESCRIPTION	ARCHIVE DELETE ARCHIVE QUERY ARCHIVE RETRIEVE	Specifies a description for a file you are archiving, deleting, or retrieving.
DETAIL	QUERY MGMTCLASS	Displays management class attributes for available management classes.
DIRONLY	QUERY BACKUP	Displays directory names for files you have backed up.
FROMDATE	QUERY ARCHIVE QUERY BACKUP RESTORE RETRIEVE	Sets a date limit for files. ADSM does not include files processed before this date when processing the command, although older directories might be included.
FROMNODE	QUERY ARCHIVE QUERY BACKUP QUERY FILESPACE QUERY MGMTCLASS RESTORE RETRIEVE	Displays file spaces on an alternate node. Also specifies an alternate node from which to restore or retrieve files.
FROMTIME	QUERY ARCHIVE QUERY BACKUP RESTORE RETRIEVE	Used in conjunction with the FROMDATE option to specify a beginning time on the specified date.
IFNEWER	RESTORE	Replaces existing files with the latest backup version if the backup version is newer than the existing version.

Figure 52 (Page 2 of 2). Options Used on Command Line Only

Option	Use with these commands:	Description
INACTIVE	QUERY BACKUP RESTORE	Displays inactive backup versions of files.
INCRBYDATE	INCREMENTAL	Performs a partial incremental.
LATEST	RESTORE	Restores the most recent backup version of a file whether it is active or inactive.
NOPROMPT	DELETE ARCHIVE	Suppresses the confirmation prompt when deleting an archived file.
PASSWORD	Any command	Entered with a DSMC command when required.
PICK	DELETE ARCHIVE RESTORE RETRIEVE	Displays a list of files from which you can choose the ones to delete, restore, or retrieve.
TODATE	QUERY ARCHIVE QUERY BACKUP RESTORE RETRIEVE	Sets a date limit for files. ADSM does not include files processed after this date when processing the command.
TOTIME	QUERY ARCHIVE QUERY BACKUP RESTORE RETRIEVE	Used in conjunction with the TODATE option to specify an ending time on the specified date.

Using Wildcard Characters

Use wildcard characters when you want to specify multiple files with similar names in *one* command. Without wildcards, you would have to repeat the command for each file.

In a command, wildcard characters can only be used in the file name or extension. They cannot be used to specify destination files, drives, or directories.

The wildcard characters you can use are:

- * Asterisk. Matches zero or more characters. If you include any other characters in the file name or extension after the asterisk, those characters are ignored.
- ? Question mark. Matches any single character at the current position. If the question mark is the last character in the file name or extension, it matches zero or one characters.

Figure 53 shows examples of each wildcard.

Figure 53. Wildcard Characters

Pattern	Matches	Does Not Match
Asterisk (*)		
a*.*	abc.exe, abcd, a.h	bcd.c, bacd
a*b (note 1)	abc, acc, addh	bccd, abc.exe
abc.*	abc.exe, abc, abc.c	abcd.exe, abce
abc.h*	abc.hlp, abc.h	abc.exe, abcd.h
* (note 2)	(Matches all files)	
Question Mark (?)		
ab?.c	abc.c, ab.c (note 3)	abcd.c, abc
ab?c	abcc, abdc	abc, abcc.exe
ab.??	ab, ab.h, ab.hg (note 3)	ab.exe, abc.h
??bd.h	abbd.h, ddbd.h	bd.h, accbd.h
Note:		
1. DOS treats a*b as a* .		
2. ADSM converts the single asterisk to *.* , whereas DOS normally treats the single asterisk as * . (no matching files would have extensions).		
3. When the question mark comes at the end of a file name or extension, it can match zero or one characters.		

Command Entry Rules

The following are general rules for entering commands:

- The command line allows up to 127 characters. You must enter the characters in a continuous string without using the return key.
- When you enter options with a command, always precede the option with a dash (–) or slash (/).
- You can enter more than one option in a command in any order before or after the file specification. You must separate each option with a blank space.

Command Reference

Figure 54 provides an alphabetical listing of the commands. For each command, the table provides a brief description and a reference for more detailed information.

Figure 54. Commands

Command	Description	Reference
ARCHIVE	Archive files from workstation	Page 146
DELETE ACCESS	Revoke authorization for a user to restore or retrieve files.	Page 149
DELETE ARCHIVE	Delete archived files from ADSM storage.	Page 151
DELETE FILESPACE	Delete file spaces on ADSM storage.	Page 154
HELP	Display online command help.	Page 156
INCREMENTAL	Back up new and changed files.	Page 157
LOOP	Start an interactive command session.	Page 160
MACRO	Use DSMC commands within a macro file.	Page 162
QUERY ACCESS	Display a list of current authorization rules.	Page 163
QUERY ARCHIVE	Display a list of archived files.	Page 165
QUERY BACKUP	Display a list of backup versions.	Page 170
QUERY FILESPACE	Display a list of file spaces on ADSM storage.	Page 175
QUERY MGMTCLASS	Display information about available management classes.	Page 177
QUERY SCHEDULE	Display information about scheduled events.	Page 179
RESTORE	Restore backup versions from ADSM storage.	Page 181
RETRIEVE	Retrieve archived files from ADSM storage.	Page 189
SCHEDULE	Start the client scheduler on the workstation.	Page 194
SELECTIVE	Back up selected files.	Page 197
SET ACCESS	Authorize another user to access your backup or archive copies.	Page 200
SET PASSWORD	Change the ADSM password for the workstation.	Page 202

ARCHIVE

ARCHIVE—Archiving Files

Use the ARCHIVE command to archive copies of files on an ADSM server. You can archive a single file, selected files, or all files in a directory (and optionally its subdirectories). Directories are not archived.

Archive files that you want to preserve in their current state, either for later use or for historical or legal purposes. Examples might be financial files from previous years that could be needed for tax audit purposes, down-level versions of programs, or personnel records of former employees.

If you need to free up storage space on your workstation, you can delete the files as you archive them. You can retrieve the archived files whenever you need them back on your workstation.

Syntax

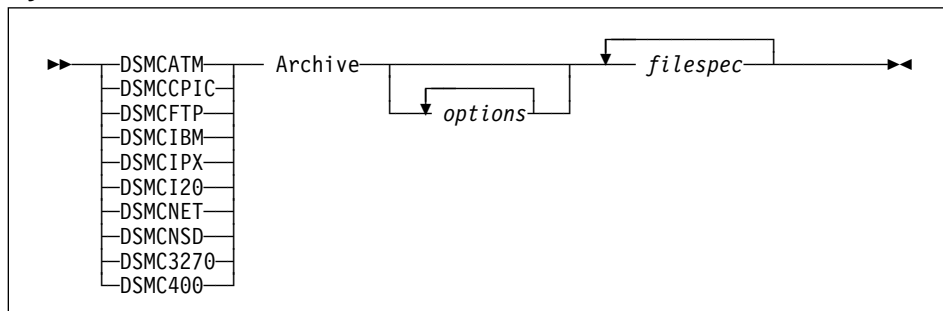

Parameters

options

Any of the following options:

-ARCHMc=managementclass

The name of an available management class in the active policy set of your policy domain. This management class overrides the assigned management class for the files you are archiving.

For example, to archive a file named **budget.jan** and use a management class named RET2YRS, enter the following:

```
Archive -ARCHMc=RET2YRS c:\plan\proj1\budget.jan
```

-CHangingretries=numberretries

The number of additional times you want ADSM to attempt to archive a file that is in use during the first attempt. This option relates to serialization, which is an attribute in a management class copy group. ADSM uses this option only when serialization is shared static or shared dynamic.

The range of values is 0 to 4.

ARCHIVE

-DELETEFILES

Deletes the archived files from your workstation after ADSM commits the files to server storage.

-DEscription=*description*

Assigns a description to the file you are archiving.

For example, to archive a file named **budget.jan** and assign the description *1994 Budget for Proj 1* to it, enter the following:

```
Archive -DE="1994 Budget for Proj 1" c:\plan\proj1\budget.jan
```

If you do not remember the name of a file you archived, you can use the description to retrieve the file.

If you use the ARCHIVE command to archive more than one file, the description you enter is assigned to each of the files. For example, to archive a group of files and assign the same description, *Project X*, to each file, enter:

```
Archive -DEscription="Project X" c:\allproj\*.x
```

You can use the description to retrieve all of the files.

-SUBdir=*value*

Whether ADSM should archive files in the subdirectories of the specified directory. The *value* is either **Yes** or **No**.

The default is No.

For example, to archive only the files in the **c:\proj** directory, enter:

```
Archive -Subdir=no c:\proj\*.*
```

To archive the files in the **c:\proj** directory and all of its subdirectories, enter:

```
Archive -Subdir=yes c:\proj\*.*
```

-TAPEPrompt=*value*

Determines whether ADSM prompts you when a tape is required, so that you can choose whether to wait (**Yes**), or whether ADSM should automatically wait for a tape to be mounted (**No**).

The default is No.

For example, to have ADSM prompt you for a tape mount, use:

```
archive d:\script\* -tapeprompt=yes
```

You can also use these options:

DATEFORMAT
NODENAME
NUMBERFORMAT
PASSWORD
QUIET
TIMEFORMAT
VERBOSE
All communication options

ARCHIVE

filespec

The drive, path, and name of the file you want to archive. You can use wildcards to specify a group of files or all the files in a directory.

You can enter multiple file specifications in one command.

Examples

Task: Archive a single file named **c:\plan\proj1\budget.jan**.

Command: Archive c:\plan\proj1\budget.jan

Task: Archive all files in the **c:\plan\proj1** directory with the file extension *txt*.

Command: Archive c:\plan\proj1*.txt

Task: Archive a single file named **c:\plan\proj1\budget.jan** and also all files with the file extension *txt*.

Command: Archive c:\plan\proj1\budget.jan c:\plan\proj1*.txt

Task: Archive all files on the C: drive.

Command: Archive -subdir=yes c:*.*

Related Commands

Figure 55. Commands Related to ARCHIVE

Command	Description	Reference
QUERY ARCHIVE	Display a list of archived files.	Page 165
DELETE ARCHIVE	Delete archived files from ADSM storage.	Page 151
RETRIEVE	Retrieve archived files from ADSM storage.	Page 189

DELETE ACCESS

DELETE ACCESS—Deleting Access to Files

Use the DELETE ACCESS command to delete current authorization rules for backups or archives of your files. When you delete an authorization rule, you revoke the access a user has to any files specified by that rule.

Syntax

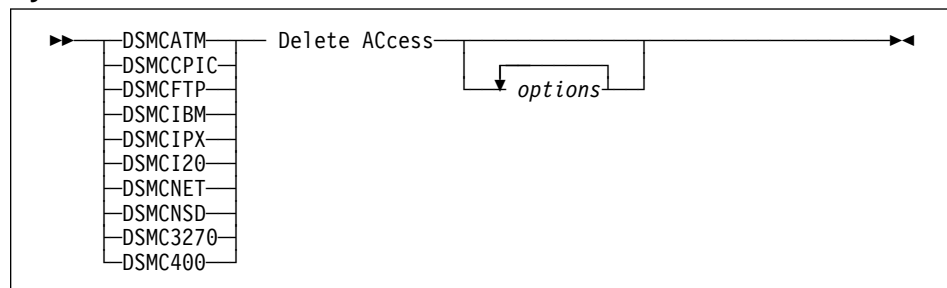

Parameters

options

Any of the following options:

-SCROLLPrompt=value

ADSM either stops after displaying the number of lines specified with the SCROLLLINES option and waits for you to scroll to the next group of lines (**Yes**), or ADSM scrolls through all lines and stops at the end of the list (**No**).

The default value is No.

To display the authorization rules one screen at a time, enter:

```
Delete Access -SCROLLPrompt=Yes
```

When prompted for an action at each screen, you can either press Enter to continue to the next screen, or type your selections, then press Enter.

-SCROLLLines=number

The number of lines you want to appear at one time when ADSM displays a list of items. For example, if you are using the SCROLLPROMPT=YES option, and you want 10 lines displayed per screen, enter:

```
Delete Access -SCROLLPrompt=Yes -SCROLLLines=10
```

You can also use these options:

DATEFORMAT
NODENAME
NUMBERFORMAT
PASSWORD
QUIET
TIMEFORMAT
VERBOSE
All communication options

DELETE ACCESS

Examples

Task: Display a list of current authorization rules and select the rules you want to delete.

Command: Delete ACcess

Output:

Index	Type	Node	Owner	Path
1	Backup	NODE1	usera	c:\dev\proja\list.c
2	Archive	NODE3	userb	c:\fin\budg\depta.jan
3	Backup	NODE4	userd	c:\plan\exp\deptc.feb
4	Archive	NODE5	usere	c:\mfg\invn\parta.wip

Enter Index of rule(s) to delete, or quit to cancel:

To delete the authorization rules that allow *userb* and *usere* to have access to your files, type **2 4** (or **2,4**), then press Enter.

You can quit without making a selection by entering **quit**.

Related Commands

Figure 56. Commands Related to DELETE ACCESS

Command	Description	Reference
SET ACCESS	Grant another user access to your backups and archives.	Page 200
QUERY ACCESS	Display a list of current authorization rules.	Page 163

DELETE ARCHIVE

DELETE ARCHIVE—Deleting Archived Files

Use the DELETE ARCHIVE command to delete archived files from ADSM storage.

Whether you are allowed to delete archived files depends on whether your ADSM administrator has granted you that authority.

Attention: After you delete archived files, you cannot retrieve them. Verify that the files are obsolete before you delete them.

Syntax

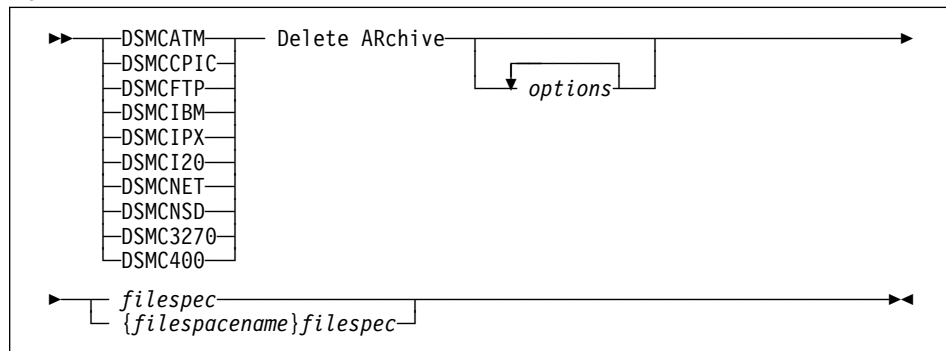

Parameters

options

Any of the following options:

-Description=description

A description you assigned the file when it was archived.

For example, to delete a file that you archived from the **c:\plan\project** directory with a description of *project x*, enter:

```
Delete ARchive -description="project x" c:\plan\project\*.*
```

-NOPrompt

Suppresses the "delete archive ... ?" confirmation prompt that normally appears before an archived file is deleted. Using this option can speed up the delete operation. However, it also increases the danger of accidentally deleting an archived file you wanted to save. Use this option with caution.

For example, to suppress the confirmation prompt while deleting all files with a **.tmp** extension that you archived from the **c:\proj** directory, type:

```
Delete ARchive -nopr c:\proj\*.tmp
```

-Pick

Display a list of archived files that match the file specification. You can select the archived files you want to delete from this list. See the RESTORE command for information on using the PICK window.

DELETE ARCHIVE

-Subdir=value

Whether ADSM should delete archive copies in the subdirectories of the specified directory. The *value* is either **Yes** or **No**.

The default is No.

For example, to delete only the files archived from the **c:\proj** directory, enter:

```
Delete ARchive -Subdir=no c:\proj\*.*
```

To delete the files archived from the **c:\proj** directory and all of its subdirectories, enter:

```
Delete ARchive -Subdir=yes c:\proj\*.*
```

You can also use these options:

DATEFORMAT
NODENAME
NUMBERFORMAT
PASSWORD
QUIET
TIMEFORMAT
VERBOSE
All communication options

filespec

The path and name of the file in ADSM storage you want to delete. You can use wildcards to specify a group of files or all the files in a directory.

For example:

```
c:\proj\*.*
```

If you include *filespace*, do not include a drive letter in the file specification.

{filespace}

The name of the file space on the server that contains the file you want to delete, enclosed in braces. This name is the name of the drive label on the workstation drive from which the file was archived.

You must use the file space name if the drive label has changed or if you are deleting files archived from another node whose drive labels are different from yours.

For example, to delete files from the **abc** file space's **proj** directory, use:

```
{abc}\proj\*.*
```

Examples

Task: Delete a file archived from **c:\plan\proj1** named **budget.jan**.

Command: Delete ARchive c:\plan\proj1\budget.jan

Task: Delete all files archived from the **c:\plan\proj1** directory with the file extension **txt**.

DELETE ARCHIVE

Command: Delete ARchive c:\plan\proj1*.txt

Task: Delete files archived from the **c:\project** directory. Use the PICK option.

Command: D AR c:\project*. * -pick

Output: See the RESTORE command for information on using the PICK window.

Related Commands

Figure 57. Commands Related to DELETE ARCHIVE

Command	Description	Reference
ARCHIVE	Archive files on ADSM storage.	Page 146
QUERY ARCHIVE	Display a list of archived files.	Page 165
QUERY FILESPACE	Display a list of file spaces.	Page 175
QUERY FILESPACE	Displays a list of file spaces.	Page 175
RETRIEVE	Retrieve archived files from ADSM storage.	Page 189

DELETE FILESPACE

DELETE FILESPACE—Deleting File Spaces

Use the DELETE FILESPACE command to delete file spaces on ADSM server storage. A file space is a logical space on the server that contains the files you have backed up or archived. ADSM assigns a separate file space on the server for each drive at your workstation from which you have backed up or archived files. The file space name is the same as the drive label.

Essentially, a file space represents a drive at your workstation. When you enter the DELETE FILESPACE command, ADSM displays a list of your file spaces from which you can select those you want to delete.

To delete a file space, your ADSM administrator must grant you the appropriate authorizations. If the file space you want to delete contains backups, you must have BACKDEL authority. If the file space contains archived files, you must have ARCHDEL authority. If the file space contains both backups and archives, you must have both types of authority.

Attention: When you delete a file space, you delete *all* backups and archives within the file space. After you delete a file space, you cannot recover the files. Be certain that the files are no longer needed before you delete them.

Syntax

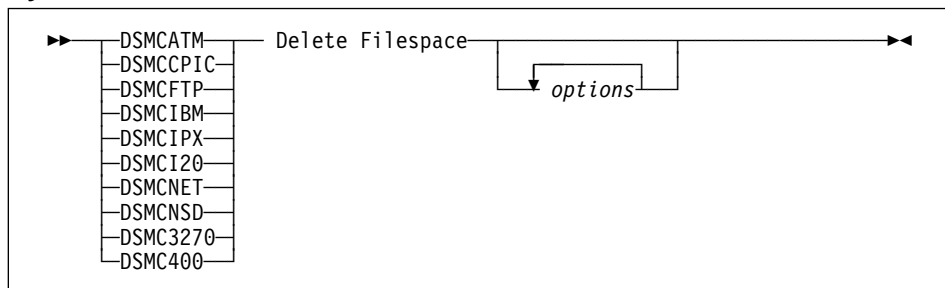

Parameters

options

You can use these options:

- DATEFORMAT
- NODENAME
- NUMBERFORMAT
- PASSWORD
- QUIET
- TIMEFORMAT
- VERBOSE
- All communication options

DELETE FILESPACE

Examples

Task: Delete a file space.

Command: Delete Filespace

Output:

```
Num      Last Incr Date      Type      File Space Name
----      -
1      05/13/1995 13:36:38  FAT       D-DISK
2      05/13/1995 13:32:57  FAT       DOS-DISK

Which file space number to remove? (1 - 2 or Quit):
```

Last Incr Date indicates the date of the last incremental backup for the file space.

To delete **d-disk**, type 1, then press Enter. ADSM asks you to confirm the action before deleting the file space.

Task: Delete a file space. Use the DATEFORMAT and TIMEFORMAT options to reformat the dates and times:

Command: Delete Filespace -DATEformat=4 -TIMEformat=4

Output:

```
Num      Last Incr Date      Type      File Space Name
----      -
1      13.05.1993 01:36:38P  FAT       D-DISK
2      13.05.1993 01:32:57P  FAT       DOS-DISK
3      13.05.1993 03:58:56P  FAT       FLOPPY-A001

Which file space number to remove? (1 - 3 or Quit):
```

Related Commands

Figure 58. Commands Related to DELETE FILESPACE

Command	Description	Reference
QUERY FILESPACE	Displays a list of file spaces.	Page 175

HELP

HELP—Displaying Online Help

Use the HELP command to display help information for the command-line client.

Syntax

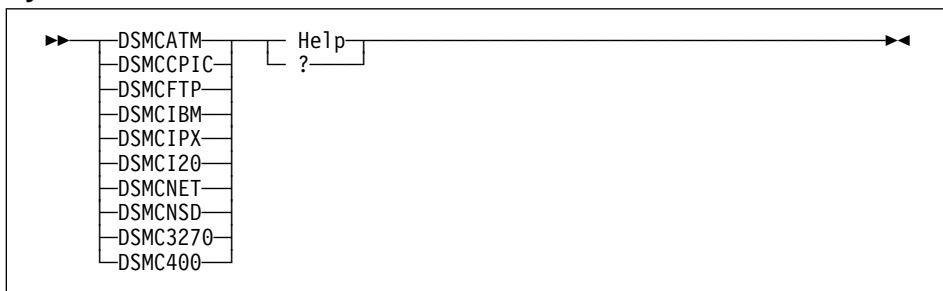

Examples

Task: Display a list of help topics.

Command: Help

From the list of topics displayed, enter the number of the topic you want to view. If there is more than one screen of topics, you can scroll back and forth through the table of contents.

To exit, type **q**, then press Enter.

INCREMENTAL

INCREMENTAL—Backing Up New and Changed Files

Use the INCREMENTAL command to back up all files in your default client domain or in the drives you specify that are not excluded from backup services (with the EXCLUDE option).

In addition, the following attributes in the management class assigned to a file affect whether the file is actually backed up.

- Frequency—The number of days that must elapse between successive backups for the file (only used during a full incremental).
- Mode—Whether a file is backed up only if it has changed since the last backup.
- Serialization—Whether a file is backed up if it changes during the backup process.

The management class assigned to a file can be the default management class or one specifically assigned to the file with an INCLUDE option in an include-exclude list.

Syntax

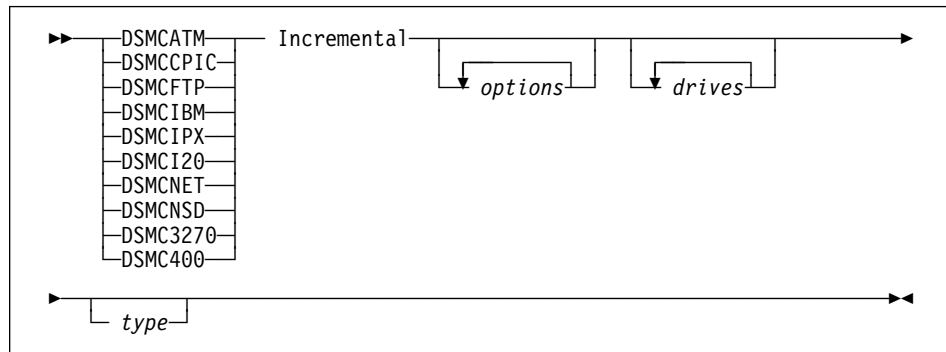

Parameters

options

Any of the following options:

-CHangingretries=numberretries

The number of times you want ADSM to attempt to back up a file that changes during the first attempt. This option relates to serialization, which is an attribute in a management class copy group. ADSM uses this option only when serialization is shared static or shared dynamic.

The range of values is 0 to 4.

-DOMain=domain

The drives you want ADSM to back up in *addition* to the drives specified with the DOMAIN option in the client options file.

For example, add the **e:** and **f:** drives to your domain, enter:

```
Incremental -DOMain="e: f:"
```

INCREMENTAL

ADSM ignores all DOMAIN options (on the command or in the client options file) if you also use the *drives* parameter on the command. For example, ADSM only backs up the **c:** drive if you enter:

```
Incremental -DOMain="e: f:" c:
```

-Quiet

Prevents messages from being displayed on your screen during processing. However, certain error information is still displayed and all messages are written to log files (error log and schedule log, as appropriate).

-TAPEPrompt=*value*

Determines whether ADSM prompts you when a tape is required, so that you can choose whether to wait (**Yes**), or whether ADSM should automatically wait for a tape to be mounted (**No**).

The default is No.

For example, to have ADSM prompt you for a tape mount, use:

```
incremental -tapeprompt=yes
```

You can also use these options:

DATEFORMAT
NODENAME
NUMBERFORMAT
PASSWORD
SLOWINCREMENTAL
TIMEFORMAT
VERBOSE
All communication options

drives

The drives you want backed up. You can enter more than one drive. Drives must be separated by a blank space.

If you do not specify any drives, the drives backed up are those listed on your DOMAIN options. If you are not using DOMAIN, all hard drives on your workstation are backed up.

type

The type of incremental backup.

The default is a full incremental backup.

In a *full* incremental, the client queries the ADSM server so that it knows the exact state of your storage as of your last incremental. During a full incremental, ADSM uses this information to:

- Back up new files
- Back up files whose contents have changed
- Back up files whose directory contents have changed, including changes to access control lists

INCREMENTAL

- Expire backup versions on the server for files that have been deleted from the workstation.
- Rebind backup versions to management classes if you have changed management class assignments, even if the associated file is not backed up.

All of this processing is required to maintain your backups according to the policies defined in the management classes.

If you use any of the following *types*, you are requesting a partial incremental as described.

Only use partial incrementals if you must meet a limited backup time window, and a full incremental takes longer than the allotted time. Periodically perform full incremental backups to bring the ADSM server in line with your workstation's status. For example, if you have only a limited time during the week to perform backups, but extra time on the weekend, you can use partial incrementals on the weekdays and then full incremental backups on the weekends.

-INCRBYDate

Requests an incremental by date.

In an *incremental by date*, the client only asks the server for the date and time of the last incremental backup. This is the only information used to determine which files get backed up, so any changes that do not change the date and time are not recognized. If a file's last changed date and time is after that of the last backup, the file is backed up. Otherwise, it is not, even if the file is new to the workstation.

Also, in an incremental by date, files are not expired or re-bound on the server, and the copy mode frequency attribute of the management classes is ignored.

Examples

Task: Run an incremental backup for your default client domain as indicated the client options file.

Command: Incremental

Task: Run an incremental backup for the **c:**, **d:**, and **e:** drives.

Command: Incremental c: d: e:

Related Commands

Figure 59. Commands Related to INCREMENTAL

Command	Description	Reference
QUERY BACKUP	Display a list of backup versions of your files.	Page 170
RESTORE	Restore backup versions of files from ADSM storage.	Page 181
SELECTIVE	Back up selected files.	Page 197

LOOP

LOOP—Starting an Interactive Command Line Session

Use the LOOP command to start an interactive command line session that is maintained until you enter **quit**. Using an interactive command line session eliminates the need for you to precede each command name with one of the DSMC commands. It also eliminates the need to enter your password with each command if you are required to enter a password.

After you start an interactive session, most options you enter with subsequent commands **remain in effect** throughout the session unless you reenter them with a different setting. The following options, however, are the exceptions. You must enter them in each command for which you want them to take effect:

DESCRIPTION
DETAIL
DIRSONLY
FROMNODE
INACTIVE
LATEST
PICK

You can enter all commands in interactive mode except the SCHEDULE and LOOP commands.

Syntax

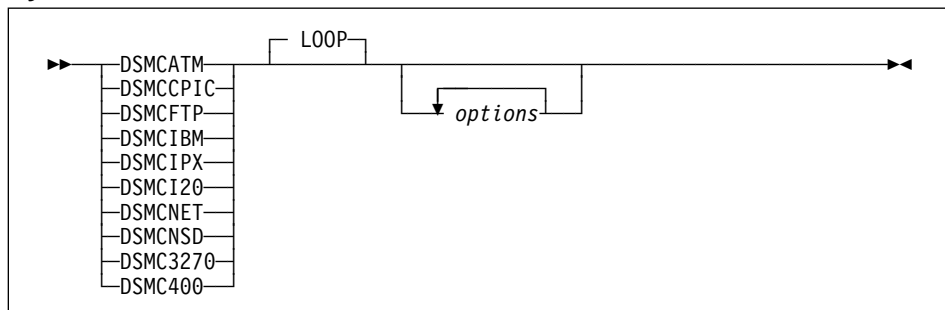

Parameters

options

Any of the following options:

-PASsword=password

The ADSM password. If your password is **notell** and you are using IBM TCP/IP 2.1, you can start an interactive session with:

```
dsmcibm -PASsword=notell
```

If you do not use this option, ADSM prompts you if a password is required. Because ADSM cannot hide your password when you use this option, we recommend that you do not use it.

LOOP

You can also use these options:

DATEFORMAT
NODENAME
NUMBERFORMAT
QUIET
TIMEFORMAT
VERBOSE
All communication options

Examples

Task: Start an ADSM interactive command line session using IBM TCP/IP 2.1.

Command: `dsmcibm`

Output: ADSM provides you with a command prompt:

```
dsmc>
```

Enter ADSM commands at this prompt, for example:

```
dsmc> query archive C:\budget\*.*
```

When you are finished, enter QUIT to end the session.

MACRO

MACRO—Using Commands Within a Macro File

Use the MACRO command to issue a series of ADSM commands as specified in a macro file.

You can nest commands to a maximum of 10 levels by including the MACRO command within a macro file.

Syntax

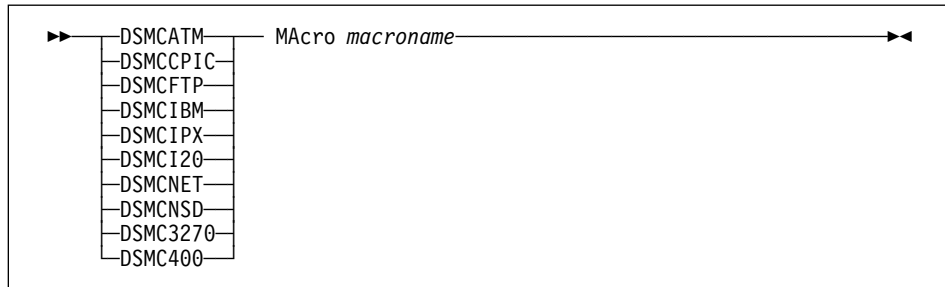

Parameters

macroname

The name of a file containing ADSM client commands.

Examples

Task: Selectively back up files in the `\devel\project\proja`, `\devel\project\projb`, and `\devel\project\projc` directories.

Command: `MACRO backabc.mac`

where **backabc.mac** is a macro file containing the statements:

```
Selective c:\devel\project\proja\*.*
Selective c:\devel\project\projb\*.*
Selective c:\devel\project\projc\*.*
```

QUERY ACCESS

QUERY ACCESS—Displaying File Access Information

Use the QUERY ACCESS command to display a list of users to whom you have granted access to backup versions or archived copies of specific files.

ADSM displays a list of authorization rules you defined using the SET ACCESS command, or the **Utilities** menu; **Set Authorization** item on the graphical user interface.

The information includes:

- Whether you granted a user authority to restore backup versions or to retrieve archived copies.
- The node name of the user to whom you granted authorization.
- The files to which the user has access.

Syntax

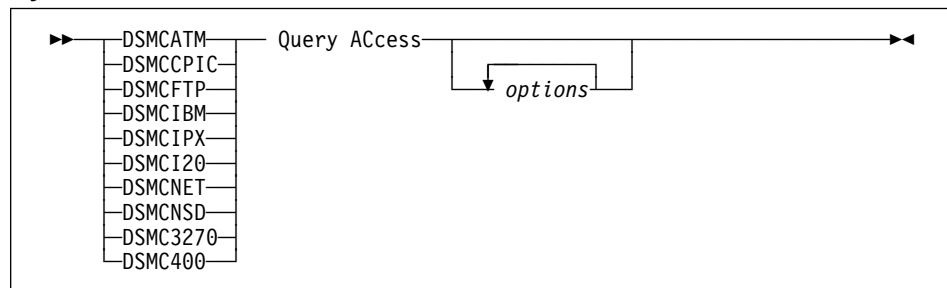

Parameters

options

Any of the following options:

-SCROLLPrompt=*value*

ADSM either stops after displaying the number of lines specified with the SCROLLLINES option and waits for you to scroll to the next group of lines (**Yes**), or ADSM scrolls through all lines and stops at the end of the list (**No**).

The default value is No.

To display the authorization rules one screen at a time, enter:

```
Query Access -SCROLLPrompt=Yes
```

-SCROLLLines=*number*

The number of lines you want to appear at one time when ADSM displays a list of items. For example, if you are using the SCROLLPROMPT=YES option, and you want 10 lines displayed per screen, enter:

```
Query Access -SCROLLPrompt=Yes -SCROLLLines=10
```

QUERY ACCESS

You can also use these options:

DATEFORMAT
NODENAME
NUMBERFORMAT
PASSWORD
TIMEFORMAT
All communication options

Examples

Task: Display a list of users who have access to your files.

Command: Query ACcess

Output:

Type	Node	Owner	Path
Backup	DAISY	D_CAT	c:\dev\proja\list.c
Archive	MARM	M_CAT	c:\fin\budg\depta.jan
Backup	KJONES	KRJ	c:\plan\exp\deptc.feb
Archive	SUSIE	S_CAT	c:\mfg\invn\parta.wip

Related Commands

Figure 60. Commands Related to QUERY ACCESS

Command	Description	Reference
SET ACCESS	Authorize another user to access backup versions or archived copies of your files.	Page 200
DELETE ACCESS	Revoke authorization for a user to restore or retrieve your files.	Page 149
QUERY FILESPACE	Display a list of file spaces.	Page 175

QUERY ARCHIVE

QUERY ARCHIVE—Displaying a List of Archived Files

Use the QUERY ARCHIVE command to display a list of your archived files. For each archived file, ADSM displays the file size, archive date, file specification, expiration date, and file description.

Syntax

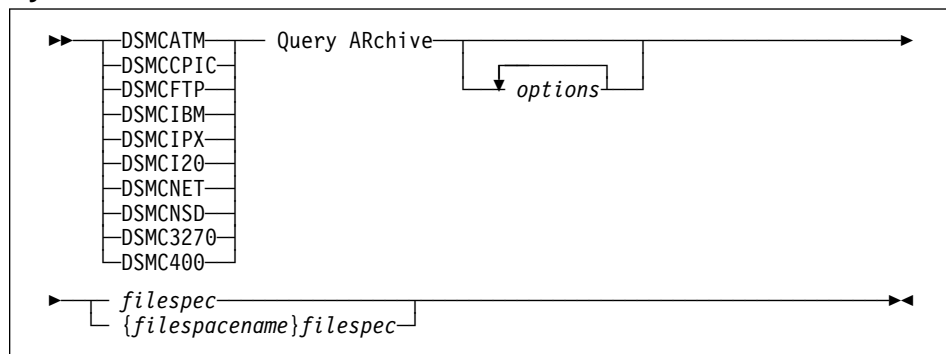

Parameters

options

Any of the following options:

-Description=*description*

Specifies a description you assigned to the file when you archived it. For example, to search files that were archived with a description that starts with the word *valid* you enter:

```
Query ARchive d:\script\* -Description="valid"
```

-FROMDate=*date*

The date from which you want ADSM to look for archives. ADSM does not list files that were archived before this date.

You can use this option in conjunction with the TODATE option to create a time window for archives. This can help you list files that were archived between two dates.

The *date* must be in the format you select with the DATEFORMAT option. For example, the date for date format 1 is *mm/dd/yyyy*, which is the American English standard. If you include DATEFORMAT on the command, it must precede FROMDATE and TODATE.

-FROMNode=*node*

An alternate node whose archived files you want to list. To list files, you must specify the file space on the server where the files reside. You can determine another node's file space names using the QUERY FILESPACE command with the FROMNODE option.

QUERY ARCHIVE

For example, to get a list of files from the **floppy-a002** file space for the BOB node, enter:

```
Query ARchive -FROMNode=bob -Subdir=Yes {floppy-a002}*
```

-FROMTime=*time*

Used in conjunction with the FROMDATE option to specify a beginning time on the specified date. For example, with FROMTIME and FROMDATE, you can request that ADSM list files beginning with those that were archived on or after 6:00 AM on June 1, 1995.

You can also use FROMTIME and FROMDATE with TOTIME and TODATE to request that ADSM list only files that were archived within a particular window of time. For example, you can request that ADSM list only files that were archived between 6:00 AM on June 1, 1995 and 11:59 PM on June 15, 1995.

The *time* must be in the format you select with the TIMEFORMAT option. For example, if TIMEFORMAT is set to the default of 1, the time must be in the format 23:00:00. If you include the TIMEFORMAT option with the command, it must precede the FROMTIME and TOTIME options.

The default for FROMTIME is 00:00:00.

Note: If you want ADSM to use a value you specify for FROMTIME, you must also include FROMDATE with the command. Otherwise, ADSM ignores FROMTIME.

-SCROLLPrompt=*value*

ADSM either stops after displaying the number of lines specified with the SCROLLLINES option and waits for you to scroll to the next group of lines (**Yes**), or ADSM scrolls through all lines and stops at the end of the list (**No**).

The default value is No.

To display the archives one screen at a time, enter:

```
Query ARchive -SCROLLPrompt=Yes c:\project\*.*
```

-SCROLLLines=*number*

The number of lines you want to appear at one time when ADSM displays a list of items. For example, if you are using the SCROLLPROMPT=YES option, and you want 10 lines displayed per screen, enter:

```
Query ARchive -SCROLLP=Yes -SCROLLL=10 c:\proj\*.*
```

-Subdir=*value*

Whether ADSM should display files in the subdirectories of the specified directory. The *value* is either **Yes** or **No**.

The default is No.

For example, to display only the archives in the **c:\proj** directory, enter:

```
Query ARchive -Subdir=no c:\proj\*.*
```

To display the archives in the **c:\proj** directory and all of its subdirectories, enter:

QUERY ARCHIVE

```
Query ARchive -Subdir=yes c:\proj\*.*
```

-TODate=*date*

The date to which you want ADSM to look for archives. ADSM does not list files that were archived on or after this date.

You can use this option in conjunction with the FROMDATE option to create a time window for archives. See the discussion of FROMDATE for more information on using TODATE.

-TOTime=*time*

Used in conjunction with the TODATE option to specify an ending time on the specified date. For example, with TOTIME and TODATE, you can request that ADSM list only files that were archived on or before 11:59 PM on June 15, 1995.

You can also use TOTIME and TODATE with FROMTIME and FROMDATE to request that ADSM list only files that were archived within a particular window of time. For example, you could request that ADSM list only files that were archived between 6:00 AM on June 1, 1995 and 11:59 PM on June 15, 1995.

The *time* must be in the format you select with the TIMEFORMAT option. For example, if TIMEFORMAT is set to the default of 1, the time must be in the format 23:00:00. If you include the TIMEFORMAT option with the command, it must precede the FROMTIME and TOTIME options.

The default for TOTIME is 23:59:59.

Note: If you want ADSM to use a value you specify for TOTIME, you must also include TODATE with the command. Otherwise, ADSM ignores TOTIME.

You can also use these options:

- DATEFORMAT
- NODENAME
- NUMBERFORMAT
- PASSWORD
- TIMEFORMAT
- All communication options

filespec

The path and name of the file in ADSM storage you want to query. You can use wildcards to specify a group of files or all the files in a directory.

For example:

```
c:\proj\*.*
```

If you include *filespace*name, do not include a drive letter in the file specification.

*{filespace*name}

The name of the file space on the server that contains the files you want to query, enclosed in braces. This name is the name of the drive label on the workstation drive from which the file was archived.

QUERY ARCHIVE

You must use the file space name if the drive label has changed or if you are querying files archived from another node whose drive labels are different from yours.

For example, to query files from the **abc** file space's **proj** directory, use:

```
{abc}\proj\*.*
```

Examples

Task: Display a list of all of files archived from the **c:\proj** directory.

Command: Query ARchive c:\proj*

Output:

Size	Archive Date	File - Expires on - Description
1184	03/08/1992 10:01:10	c:\proj\projb.dev 09/24/1993 Project B
311	03/08/1992 16:02:22	c:\proj\exp.fin 03/08/1993 Expense
1722	03/08/1992 10:04:36	c:\proj\sals.fin 09/24/1994 Salaries
1522	04/12/1992 14:44:06	c:\proj\projx.dev 09/24/1994 Project X
344	06/07/1992 18:02:11	c:\proj\rev.fin 03/08/1995 Revenue
2112	07/31/1992 10:11:40	c:\proj\projd.dev 09/24/1994 Project D

Task: Display a list of all of your archived files in the **c:\proj** directory. Use the DATEFORMAT and TIMEFORMAT options to reformat the dates and times.

Command: Query ARchive -DATE=5 -TIME=4 c:\proj*

Output:

Size	Archive Date	File - Expires on - Description
1184	1992.03.08 10:01:10A	c:\proj\projb.dev 1993.09.24 Project B
311	1992.03.08 04:02:22P	c:\proj\exp.fin 1993.03.08 Expense
1722	1992.03.08 10:04:36A	c:\proj\sals.fin 1994.09.24 Salaries
1522	1992.04.12 02:44:06P	c:\proj\projx.dev 1994.09.24 Project X
344	1992.06.07 06:02:11P	c:\proj\rev.fin 1995.03.08 Revenue
2112	1992.07.31 10:11:40P	c:\proj\projd.dev 1994.09.24 Project D

Task: Display the list of files with the file extension **dev** that were archived from the **c:\proj** directory. Use the DATEFORMAT and TIMEFORMAT options.

Command: Query ARchive -DATE=5 -TIME=4 c:\proj*.dev

QUERY ARCHIVE

Output:

Size	Archive Date	File - Expires on - Description
1184	1992.03.08 10:01:10A	c:\proj\projb.dev 1993.09.24 Project B
1522	1992.04.12 02:44:06P	c:\proj\projx.dev 1994.09.24 Project X
2112	1992.07.31 10:11:40A	c:\proj\projd.dev 1994.09.24 Project D

Task: Last week you changed the label of your **c:** drive to **adsm** and archived some files. Yesterday you changed the label to **dev** and archived some more files. Display a list of all files that were archived from the **c:\proj** directory when the label was **adsm**.

Command: Query ARchive {adsm}\proj*

Task: Last week you archived files from a diskette labeled **docs**. Display a list of all files that were archived from it.

Command: Q AR {docs}*

Related Commands

Figure 61. Commands Related to QUERY ARCHIVE

Command	Description	Reference
ARCHIVE	Archive files on ADSM storage.	Page 146
DELETE ARCHIVE	Delete archived files from ADSM storage.	Page 151
QUERY FILESPACE	Display a list of file spaces.	Page 175
RETRIEVE	Retrieve archived files from ADSM storage.	Page 189

QUERY BACKUP

QUERY BACKUP—Displaying a List of Backup Versions

Use the QUERY BACKUP command to display a list of backup versions of your files.

For each backup version, ADSM displays the file size, backup date, the management class to which the file is bound, whether the file is active or inactive, and the file specification.

If the management class name is longer than 10 characters, ADSM displays only the first 10 characters.

Syntax

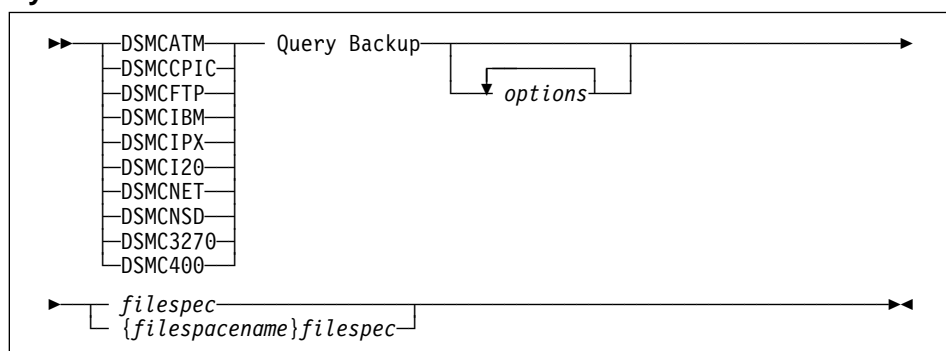

Parameters

options

Any of the following options:

-Dironly

The query displays only directory names for backup versions. For example, to display only directory information, you can enter:

```
Query Backup -Dironly *
```

-FROMDate=*date*

The date from which you want ADSM to look for backups. ADSM does not list files that were backed up before this date.

You can use this option in conjunction with the TODATE option to create a time window for backups. This can help you list files that were backed up between two dates.

The *date* must be in the format you select with the DATEFORMAT option. For example, the date for date format 1 is *mm/dd/yyyy*, which is the American English standard. If you include DATEFORMAT on the command, it must precede FROMDATE and TODATE.

-FROMNode=*node*

An alternate node whose backups you want to list. To list files, you must specify the file space on the server where the files reside. You can determine

QUERY BACKUP

another node's file space names using the QUERY FILESPACE command with the FROMNODE option.

For example, to get a list of files from the **floppy-a002** file space for the BOB node, enter:

```
Query Backup -FROMNode=bob -Subdir=Yes {floppy-a002}*
```

-FROMTime=*time*

Used in conjunction with the FROMDATE option to specify a beginning time on the specified date. For example, with FROMTIME and FROMDATE, you can request that ADSM list files beginning with those that were backed up on or after 6:00 AM on June 1, 1995.

You can also use FROMTIME and FROMDATE with TOTIME and TODATE to request that ADSM list only files that were backed up within a particular window of time. For example, you can request that ADSM list only files that were backed up between 6:00 AM on June 1, 1995 and 11:59 PM on June 15, 1995.

The *time* must be in the format you select with the TIMEFORMAT option. For example, if TIMEFORMAT is set to the default of 1, the time must be in the format 23:00:00. If you include the TIMEFORMAT option with the command, it must precede the FROMTIME and TOTIME options.

The default for FROMTIME is 00:00:00.

Note: If you want ADSM to use a value you specify for FROMTIME, you must also include FROMDATE with the command. Otherwise, ADSM ignores FROMTIME.

-INActive

The query displays information about both active *and* inactive backup versions of files. If you do not use this option, ADSM only displays information about active backup versions.

To display information about both active and inactive versions you have backed up from the **c:\project** directory, enter:

```
Query Backup -INActive c:\project\*
```

-SCROLLPrompt=*value*

ADSM either stops after displaying the number of lines specified with the SCROLLLINES option and waits for you to scroll to the next group of lines (**Yes**), or ADSM scrolls through all lines and stops at the end of the list (**No**).

The default value is No.

To display the backups one screen at a time, enter:

```
Q Backup -SCROLLPrompt=Yes c:\project\*.*
```

-SCROLLLines=*number*

The number of lines you want to appear at one time when ADSM displays a list of items. For example, if you are using the SCROLLPROMPT=YES option, and you want 10 lines displayed per screen, enter:

QUERY BACKUP

```
Query Backup -SCROLLP=Yes -SCROLLL=10 c:\proj\*.*
```

-Subdir=value

Whether ADSM should display files in the subdirectories of the specified directory. The *value* is either **Yes** or **No**.

The default is No.

For example, to display only the backups in the **c:\proj** directory, enter:

```
Query Backup -Subdir=no c:\proj\*.*
```

To display the backups in the **c:\proj** directory and all of its subdirectories, enter:

```
Query Backup -Subdir=yes c:\proj\*.*
```

-TODate=date

The date to which you want ADSM to look for backups. ADSM does not list files that were backed up on or after this date.

You can use this option in conjunction with the FROMDATE option to create a time window for backups. See the discussion of FROMDATE for more information on using TODATE.

-TOTime=time

Used in conjunction with the TODATE option to specify an ending time on the specified date. For example, with TOTIME and TODATE, you can request that ADSM list only files that were backed up on or before 11:59 PM on June 15, 1995.

You can also use TOTIME and TODATE with FROMTIME and FROMDATE to request that ADSM list only files that were backed up within a particular window of time. For example, you could request that ADSM list only files that were backed up between 6:00 AM on June 1, 1995 and 11:59 PM on June 15, 1995.

The *time* must be in the format you select with the TIMEFORMAT option. For example, if TIMEFORMAT is set to the default of 1, the time must be in the format 23:00:00. If you include the TIMEFORMAT option with the command, it must precede the FROMTIME and TOTIME options.

The default for TOTIME is 23:59:59.

Note: If you want ADSM to use a value you specify for TOTIME, you must also include TODATE with the command. Otherwise, ADSM ignores TOTIME.

You can also use these options:

```
DATEFORMAT  
NODENAME  
NUMBERFORMAT  
PASSWORD  
QUIET  
TIMEFORMAT  
VERBOSE
```

QUERY BACKUP

All communication options

filespec

The path and name of the file in ADSM storage you want to query. You can use wildcards to specify a group of files or all the files in a directory.

For example:

```
c:\proj\*.*
```

If you include *filespace*name, do not include a drive letter in the file specification.

{filespace}name

The name of the file space on the server that contains the file you want to query, enclosed in braces. This name is the name of the drive label on the workstation drive from which the file was backed up.

You must use the file space name if the drive label has changed or if you are querying files backed up from another node whose drive labels are different from yours.

For example, to query files from the **abc** file space's **proj** directory, use:

```
{abc}\proj\*.*
```

Examples

Task: Display a list of all active and inactive backup versions that were backed up from the **c:\proj** directory.

Command: Query Backup -INActive c:\proj*

Output:

Size	Backup Date	Mgmt Class	A/I	File
1184	03/08/1992 10:01:08	Proj_Files	A	c:\proj\proja.dev
311	03/08/1992 16:02:11	Acct_Files	A	c:\proj\exp.fin
1722	03/08/1992 10:04:53	Acct_Files	I	c:\proj\sals.fin
1522	04/12/1992 14:44:10	Proj_Files	A	c:\proj\projn.dev
344	06/07/1992 18:02:23	Acct_Files	I	c:\proj\rev.fin
2112	07/31/1992 10:11:55	Proj_Files	A	c:\proj\projz.dev

Task: Display a list of all active and inactive backup versions that were backed up from the **c:\proj** directory. Use the DATEFORMAT and TIMEFORMAT options to reformat the dates and times.

Command: Q B -DATE=5 -TIME=4 -INA c:\proj*

Output:

QUERY BACKUP

Size	Backup Date	Mgmt Class	A/I	File
1184	1992.03.08 10:01:08A	Proj_Files	A	c:\proj\proja.dev
311	1992.03.08 04:02:11P	Acct_Files	A	c:\proj\exp.fin
1722	1992.03.08 10:04:53A	Acct_Files	I	c:\proj\sals.fin
1522	1992.04.12 02:44:10P	Proj_Files	A	c:\proj\projn.dev
344	1992.06.07 06:02:23P	Acct_Files	I	c:\proj\rev.fin
2112	1992.07.31 10:11:55A	Proj_Files	A	c:\proj\projz.dev

Task: Last week you backed up files from a diskette labeled **docs**. Display a list of all files that were backed up from it.

Command: Q B {docs}*

Related Commands

Figure 62. Commands Related to QUERY BACKUP

Command	Description	Reference
ARCHIVE	Archive files on ADSM storage.	Page 146
INCREMENTAL	Back up new and changed files to ADSM storage.	Page 157
QUERY FILESPACE	Display a list of file spaces.	Page 175
RESTORE	Restore backup versions of files from ADSM storage.	Page 181
SELECTIVE	Back up selected files.	Page 197

QUERY FILESPACE

QUERY FILESPACE—Displaying a List of File Spaces

Use the QUERY FILESPACE command to list file spaces on ADSM server storage for a node. A file space is a logical space on the server that contains the files you have backed up or archived. ADSM assigns a separate file space on the server for each drive at your workstation from which you have backed up or archived files. The file space name is the same as the drive label.

Essentially, a file space represents a drive at your workstation. When you enter the QUERY FILESPACE command, ADSM displays a list of your file spaces.

Syntax

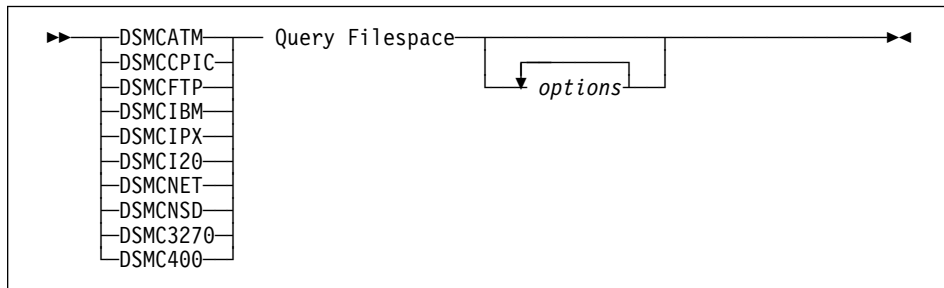

Parameters

options

Any of the following options:

-FROMNode=node

An alternate node whose file spaces you want to list.

For example, to get a list of files from the BOB node, enter:

```
Query Filespace -FROMNode=bob
```

You can also use these options:

DATEFORMAT
NODENAME
NUMBERFORMAT
PASSWORD
SCROLLLINES
SCROLLPROMPT
TIMEFORMAT
All communication options

QUERY FILESPACE

Examples

Task: Display your file spaces.

Command: Query Filespace

Output:

Num	Last Incr Date	Type	File Space Name
1	05/13/1993 13:36:38	FAT	D-DISK
2	05/13/1993 13:32:57	FAT	DOS-DISK
3	05/13/1993 15:58:56	FAT	FLOPPY-A001
4	05/14/1993 10:27:47	FAT	FLOPPY-A002

Task: Display your file spaces. Use the DATEFORMAT and TIMEFORMAT options to reformat the dates and times:

Command: Query Filespace -DATEformat=4 -TIMEformat=4

Output:

Num	Last Incr Date	Type	File Space Name
1	13.05.1993 01:36:38P	FAT	D-DISK
2	13.05.1993 01:32:57P	FAT	DOS-DISK
3	13.05.1993 03:58:56P	FAT	FLOPPY-A001
4	14.05.1993 10:27:47A	FAT	FLOPPY-A002

Related Commands

Figure 63. Commands Related to QUERY FILESPACE

Command	Description	Reference
DELETE FILESPACE	Delete file spaces from ADSM storage.	Page 154

QUERY MGMTCLASS

QUERY MGMTCLASS—Displaying Management Classes

Use the QUERY MGMTCLASS command to display information about the management classes available in your active policy set.

Management classes are defined by your ADSM administrator. They contain attributes that control whether a file is eligible for backup or archive services, and attributes that determine how ADSM manages the backups and archives after they reach the server.

Your active policy set contains a default management class, and can contain any number of additional management classes. You can assign specific management classes to files using INCLUDE options in the client options file. If you do not assign a management class to a file, ADSM uses the default management class.

Syntax

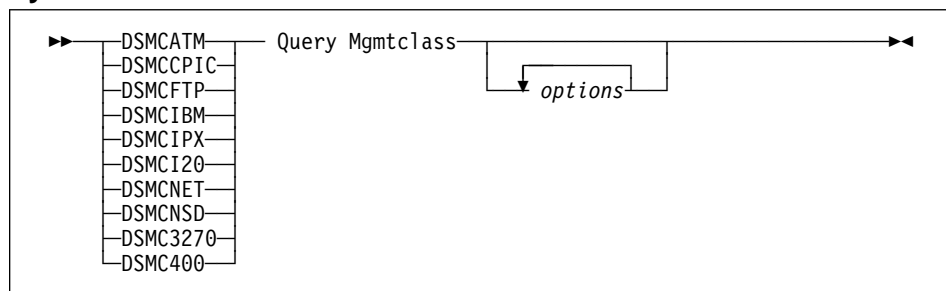

Parameters

options

Any of the following options:

-DETail

Displays detailed information about each management class in your active policy set. If you do not use the DETAIL option, ADSM displays only the management class name and a brief description.

When you specify the DETAIL option, ADSM also displays information about the attributes contained in each copy group contained in each management class. A management class can contain a backup copy group, an archive copy group, both, or neither.

To display detailed information about available management classes in your active policy set, enter:

```
Query Mgmtclass -DETail
```

You can also use these options:

```
DATEFORMAT  
NODENAME  
NUMBERFORMAT  
PASSWORD
```

QUERY MGMTCLASS

TIMEFORMAT
All communication options

Examples

Task: Display available management classes.

Command: Query Mgmtclass

Output:

```
Domain Name           :CALIFORNIA
Activated Policy Set Name :SAN_JOSE
Activation date/time   :08/19/1994 09:09:09
Default Mgmt Class Name :STANDARD
Grace Period Backup Retn. :30 day(s)
Grace Period Archive Retn.:30 day(s)

MgmtClass Name: STANDARD
Description   : Installed default management class.

MgmtClass Name: Project_Files
Description   : Back up and archive project files.

MgmtClass Name: Source_Code
Description   : Back up source code files.

MgmtClass Name: Persnl_Files
Description   : Back up and archive personnel records.
```

QUERY SCHEDULE

QUERY SCHEDULE—Displaying Scheduled Events

Use the QUERY SCHEDULE command to display the events scheduled for your node.

Your ADSM administrator can set up schedules to perform automatic backups and archives for you. To better plan your work, you can use this command to determine when the next of those scheduled events is to occur.

Syntax

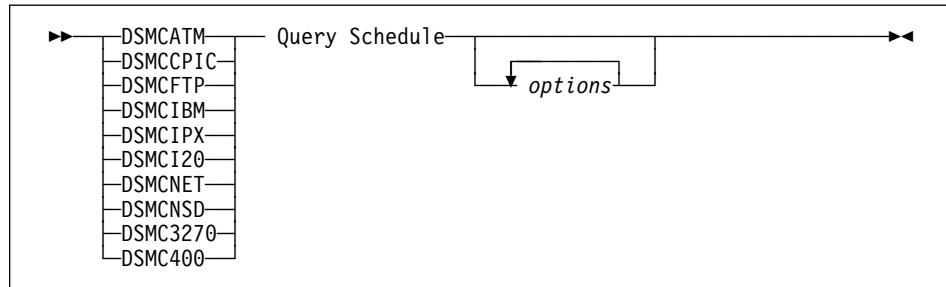

Parameters

options

Any of these options:

- DATEFORMAT
- NODENAME
- NUMBERFORMAT
- PASSWORD
- TIMEFORMAT
- All communication options

Examples

Task: Display your scheduled events.

Command: Query Schedule

Output:

```
Schedule Name: DAILY_INCR  
Description: Daily Backup of c: and d: drives  
Action: Incremental  
Options: -Quiet  
Objects: c: d:  
Priority: 5  
Next Execution: 10 Minutes  
Duration: 4 Hours  
Period: 1 Day  
Day of Week: Any  
Expire: Never
```

QUERY SCHEDULE

Related Commands

Figure 64. Commands Related to QUERY SCHEDULE

Command	Description	Reference
SCHEDULE	Start the client scheduler on your workstation.	Page 194

RESTORE

RESTORE—Restoring Backup Versions

Use the RESTORE command to obtain copies of backup versions of your files from an ADSM server.

You can restore files by specifying directories, by specifying selected files, or by choosing files from a list. You can restore files to the directory from which you backed them up or to a different directory.

Syntax

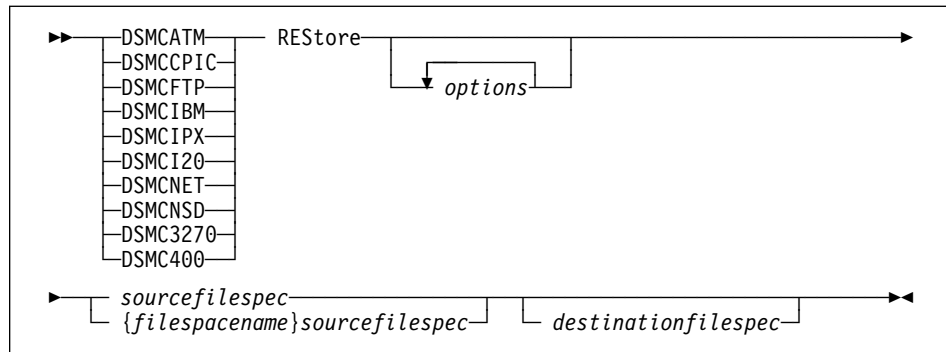

Parameters

options

Any of the following options:

-FROMDate=*date*

The date from which you want ADSM to look for backups. ADSM does not restore files that were backed up before this date, although ADSM might restore directories that are older than this date.

You can use this option in conjunction with the TODATE option to create a time window for backups. This can help you restore a set of files to their state as of that window.

The *date* must be in the format you select with the DATEFORMAT option. For example, the date for date format 1 is *mm/dd/yyyy*, which is the American English standard. If you include DATEFORMAT on the command, it must precede FROMDATE and TODATE.

The file selected for restore depends on the other options you use:

INACTIVE or **LATEST**

Restores the latest backup version in the fromdate-todate window, even if it is an inactive version. If a file does not have a backup within the window, the file is not restored.

Using the INACTIVE or LATEST option with FROMDATE and TODATE is likely to get the results you want.

RESTORE

SUBDIR=YES

Restores the most recent backup of a directory up to the TODATE date. The FROMDATE option is ignored for directories.

If you also use the INACTIVE or LATEST option, then ADSM restores the most recent backup of the directory up to the TODATE date, even if the backup is inactive. If you do not use INACTIVE or LATEST, ADSM only restores active backup versions. If the directory you are restoring does not have an active backup before the TODATE date, ADSM recreates the directory instead of restoring it.

-FROMNode=node

An alternate node whose backup you want to restore. You must have the appropriate authority to restore the files.

To restore files, you must specify the file space on the server where the files reside. You can determine another node's file space names using the QUERY FILESPACE command with the FROMNODE option.

For example, to restore files from the **floppy-a002** file space for the BOB node, enter:

```
REStore -FROMNode=bob -Subdir=Yes {floppy-a002}\*.*
```

To restore files from another node, you must both be using the FAT file system (this can be an OS/2, DOS, or Windows node).

-FROMTime=time

Used in conjunction with the FROMDATE option to specify a beginning time on the specified date. For example, with FROMTIME and FROMDATE, you can request that ADSM restore only files that were backed up on or after 6:00 AM on June 1, 1995.

You can also use FROMTIME and FROMDATE with TOTIME and TODATE to request that ADSM restore only files that were backed up within a particular window of time. For example, you can request that ADSM restore only files that were backed up between 6:00 AM on June 1, 1995 and 11:59 PM on June 15, 1995.

The *time* must be in the format you select with the TIMEFORMAT option. For example, if TIMEFORMAT is set to the default of 1, the time must be in the format 23:00:00. If you include the TIMEFORMAT option with the command, it must precede the FROMTIME and TOTIME options.

The default for FROMTIME is 00:00:00.

Note: If you want ADSM to use a value you specify for FROMTIME, you must also include FROMDATE with the command. Otherwise, ADSM ignores FROMTIME.

The actual files selected for restore are also determined by other options you use with the command. See the discussion on FROMDATE for more information.

RESTORE

-IFNewer

ADSM should replace an existing file with the backup if the backup is newer than the existing file. This option is ignored if the REPLACE option is NO.

Only active backups are considered unless you also use the INACTIVE or LATEST options.

-INActive

ADSM should restore an inactive backup if an active one is not available.

If you use the PICK option, ADSM displays both active and inactive backups. This allows you to pick a backup version that is older than the most recent backup.

Only active versions are considered for restore unless you use INACTIVE or LATEST.

-LATEST

Restores the most recent backup version of a file, even if the backup is inactive. Only active versions are considered for restore unless you use INACTIVE or LATEST.

For example, to restore the latest backup versions from the `c:\devel\projecta` directory, enter:

```
REStore -LATEST c:\devel\projecta
```

-PICK

ADSM displays a list of backup versions that match the file specification you enter. From that list, you can select the backup versions to restore.

Also use the INACTIVE option if you want both active and inactive versions listed. See the last example in this section.

-Quiet

Prevents messages from being displayed on your screen during processing. However, certain error information is still displayed and all messages are written to log files (error log and schedule log, as appropriate).

-REPLACE=*value*

When restoring a file, determines what happens when a file of the same name as the backup already exists in the destination directory. The possible values are:

Prompt

ADSM prompts you for your choice for overwriting an existing file. If the file is read-only, you cannot overwrite it. This is the default unless REPLACE is set in the client options file.

No

ADSM does not overwrite existing files.

Yes

ADSM overwrites existing files, except for read-only files, without prompting you.

RESTORE

All

ADSM overwrites existing files, even if they are read-only, without prompting you.

-Subdir=*value*

Whether ADSM should restore files in the subdirectories of the specified directory. The *value* is either **Yes** or **No**.

The default is No.

For example, to restore only the files in the **c:\proj** directory, enter:

```
REStore -Subdir=no c:\proj\*.*
```

To restore the files in the **c:\proj** directory and all of its subdirectories, enter:

```
REStore -Subdir=yes c:\proj\*.*
```

-TODate=*date*

The date to which you want ADSM to look for backups. ADSM does not restore files that were backed up after this date.

You can use this option in conjunction with the FROMDATE option to create a time window for backups. See the discussion of FROMDATE for more information on using TODATE.

-TOTime=*time*

Used in conjunction with the TODATE option to specify an ending time on the specified date. For example, with TOTIME and TODATE, you can request that ADSM restore only files that were backed up on or before 11:59 PM on June 15, 1995.

You can also use TOTIME and TODATE with FROMTIME and FROMDATE to request that ADSM restore only files that were backed up within a particular window of time. For example, you could request that ADSM restore only files that were backed up between 6:00 AM on June 1, 1995 and 11:59 PM on June 15, 1995.

The *time* must be in the format you select with the TIMEFORMAT option. For example, if TIMEFORMAT is set to the default of 1, the time must be in the format 23:00:00. If you include the TIMEFORMAT option with the command, it must precede the FROMTIME and TOTIME options.

The default for TOTIME is 23:59:59.

Note: If you want ADSM to use a value you specify for TOTIME, you must also include TODATE with the command. Otherwise, ADSM ignores TOTIME.

The actual files selected for restore are also determined by other options you use with the command. See the discussion on FROMDATE for more information.

RESTORE

You can also use these options:

DATEFORMAT
NODENAME
NUMBERFORMAT
PASSWORD
TAPEPROMPT
TIMEFORMAT
VERBOSE
All communication options

sourcefilespec

The path and name of the file in ADSM storage you want to restore. You can use wildcards to specify a group of files or all the files in a directory.

For example:

```
c:\proj\*.*
```

If you include *filespace*name, do not include a drive letter in the file specification.

{filespace}

The name of the file space on the server that contains the file you want to restore, enclosed in braces. This name is the name of the drive label on the workstation drive from which the file was backed up.

You must use the file space name if the drive label has changed or if you are restoring files backed up from another node whose drive labels are different from yours.

For example, to restore files from the **abc** file space's **proj** directory, use:

```
{abc}\proj\*.*
```

destinationfilespec

The path and file name where you want to place the restored file or files. If you do not specify a destination, ADSM restores the files to the original source path.

If the destination drive does not exist, be sure to end the file specification in either a directory delimiter (\) or a file name. Otherwise, ADSM assumes the last name is a file name, and tries to repeatedly overwrite the file as each file is restored.

Examples

Task: Restore a single file named **budget.fin**

Command: REStore c:\devel\projecta\budget.fin

Task: Restore all files from the **c:\devel\projecta** directory with the extension **c**.

Command: REStore c:\devel\projecta*.c

Task: Restore all files from the **\devel\projecta** directory in the **dos** file space with the extension **c**.

Command: REStore {dos}\devel\projecta*.c

RESTORE

Task: Restore all files from the **c:\devel\projecta** directory with the file name extension of **.c** to the **c:\newdevel\projectn** directory.

Command: RESTore c:\devel\projecta*.c c:\newdevel\projectn

Task: Restore files in the **c:\project** directory. Use the PICK and INACTIVE option so you can choose among active and inactive backup versions.

Command: Restore c:\project* -Pick -INActive

Output:

```
ADSM Scrollable PICK Window - Restore

#      Backup Date/Time  File Size A/I  File
-----
1.    01/02/1993 21:17    7362  A  c:\project\projb.dev
2.    02/10/1993 12:19   83442  A  c:\project\exp.fin
3.    03/22/1993 04:07    8117  I  c:\project\projx.dev
4.    04/06/1993 12:12    4392  A  c:\project\saf.fin
5.    04/07/1993 11:27  287009  A  c:\project\projd.dev
6.    04/08/1993 07:21    362   I  c:\project\rev.fin

0-----10-----20-----30-----40-----50-----60--
<U>=Up  <D>=Down  <T>=Top  <B>=Bottom  <R#>=Right  <L#>=Left
<G#>=Goto Line #  <#>=Toggle Entry  <+>=Select All  <->=Deselect All
<#:#+>=Select A Range  <#:#->=Deselect A Range  <O>=Ok  <C>=Cancel
pick>
```

The functions available to manipulate the display and make selections appear at the bottom of the screen. If it takes more than one screen to display the list, you can scroll forward and backward through the screens.

To make selections, at the pick> prompt, type the numbers that correspond to the files you want to process. For example, to select the **projx.dev** and **rev.fin** files, enter:

```
pick> 3 6
```

ADSM marks your selections with an x as shown in the following illustration.

RESTORE

```

ADSM Scrollable PICK Window - Restore

#      Backup Date/Time  File Size A/I  File
-----
1.    01/02/1993 21:17      7362  A  c:\project\projb.dev
2.    02/10/1993 12:19     83442  A  c:\project\exp.fin
x 3.    03/22/1993 04:07      8117  I  c:\project\projx.dev
4.    04/06/1993 12:12      4392  A  c:\project\saf.fin
5.    04/07/1993 11:27    287009  A  c:\project\projd.dev
x 6.    04/08/1993 07:21       362  I  c:\project\rev.fin

0-----10-----20-----30-----40-----50-----60-
<U>=Up   <D>=Down  <T>=Top   <B>=Bottom <R#>=Right <L#>=Left
<G#>=Goto Line #  <#>=Toggle Entry  <+>=Select All  <->=Deselect All
<#:#+>=Select A Range  <#:#->=Deselect A Range  <O>=Ok  <C>=Cancel
pick>

```

To complete the command, enter **o** at the pick> prompt. For example:

```
pick> o
```

Figure 65 provides an explanation of each Pick Window manipulation function.

Figure 65 (Page 1 of 2). Pick Window Manipulation Functions

Legend	Description
<U>=Up	Scrolls the window up one page of files.
<D>=Down	Scrolls the window down one page of files.
<T>=Top	Positions the window to the top of the list.
=Bottom	Positions the window to the bottom of the list.
<R#>=Right	Positions the window # spaces to the right. Default is 20 if only R is entered.
<L#>=Left	Positions the window # spaces to the left. Default is 20 if only L is entered.
<G#>=Goto Line #	Positions the file # entered to top of screen.
<#>=Toggle Entry	Selects the file # entered or deselects it if already selected. More than one file # can be entered by separating each with a blank.
<+>=Select All	Selects all files.
<->=Deselect All	Deselects all files.
<#:#+>=Select a range.	Selects a range of files. First file # entered is beginning of range. Second file # entered is end of range.
<#:#->=Deselect a range.	Deselects a range of files. First file # entered is beginning of range. Second file # entered is end of range.

RESTORE

Figure 65 (Page 2 of 2). Pick Window Manipulation Functions

Legend	Description
<O>=Ok	Deletes the archived files selected.
<C>=Cancel	Cancel the operation and returns to the command prompt.

Related Commands

Figure 66. Commands Related to RESTORE

Command	Description	Reference
INCREMENTAL	Back up new and changed files.	Page 157
QUERY BACKUP	Display a list of backup versions of your files.	Page 170
QUERY FILESPACE	Display a list of file spaces.	Page 175
SELECTIVE	Back up selected files.	Page 197

RETRIEVE

RETRIEVE—Retrieving Files from Archive

Use the RETRIEVE command to obtain copies of archived files from the server.

You can retrieve archived files by specifying selected files or whole directories. To help focus your selection, use the available options such as DESCRIPTION, which allows you to search on the descriptions assigned to the files when they were archived.

You can place the retrieved files in the same directory from which they were archived or in a different directory.

Syntax

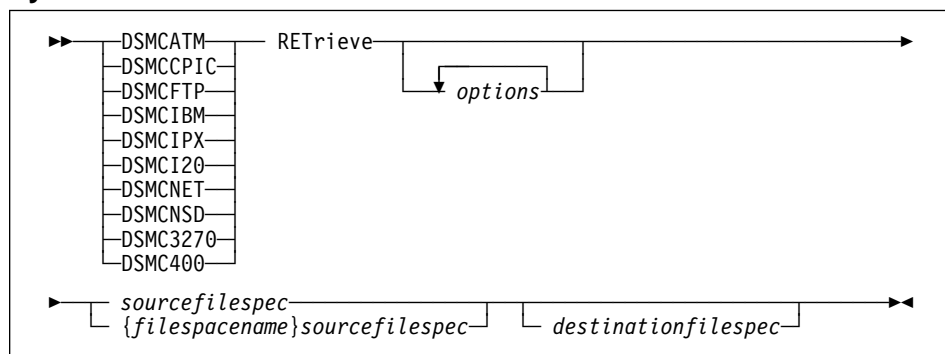

Parameters

options

Any of the following options:

-Description=description

Provides a filter that narrows down the files that meet the *sourcefilespec* parameter to those files that also meet the DESCRIPTION specification. If you do not remember the name of a file you want to retrieve, you can use the description you gave it when it was archived. For example, if you want to retrieve a file that you archived from the **c:\plan\proj1** directory with a description of *1994 Budget for Proj 1*, you can enter:

```
RETRIEVE -Description="1994 Budget for Proj 1" c:\plan\proj1
```

You can also use wildcards to retrieve a group of files you previously archived with the same description. For example, if you want to retrieve all files with the extension **x**, that you archived with the description *Project X* from the **c:\allproj** directory, you can enter:

```
RETRIEVE -Description="Project X" c:\allproj\*.x
```

You can also use wildcard characters to retrieve files with similar descriptions. For example, to retrieve files from the **c:\allproj** directory that you archived with the descriptions *Project X*, *Project XZ*, and *Project YZ*, you can enter:

```
RETRIEVE -Description="Project*" c:\allproj\*
```

RETRIEVE

-FROMDate=*date*

The date from which you want ADSM to look for archives. ADSM does not retrieve files that were archived before this date.

You can use this option in conjunction with the TODATE option to create a time window for archives. This can help you retrieve a set of files to their state as of that window.

The *date* must be in the format you select with the DATEFORMAT option. For example, the date for date format 1 is *mm/dd/yyyy*, which is the American English standard. If you include DATEFORMAT on the command, it must precede FROMDATE and TODATE.

If you use SUBDIR=YES, ADSM retrieves the most recent archive of a directory up to the TODATE date. The FROMDATE option is ignored for directories.

-FROMNode=*node*

An alternate node whose archived files you want to retrieve. You must have the appropriate authorization to retrieve the files.

To retrieve files, you must specify the file space on the server where the files reside. You can determine another node's file space names using the QUERY FILESPACE command with the FROMNODE option.

For example, to retrieve files from the **floppy-a002** file space for the BOB node, enter:

```
RETRieve -FROMNode=bob -Subdir=Yes {floppy-a002}\*.*
```

To retrieve files from another node, you must both be using the FAT file system (this can be an OS/2, DOS, or Windows node).

-FROMTime=*time*

Used in conjunction with the FROMDATE option to specify a beginning time on the specified date. For example, with FROMTIME and FROMDATE, you can request that ADSM retrieve only files that were archived on or after 6:00 AM on June 1, 1995.

You can also use FROMTIME and FROMDATE with TOTIME and TODATE to request that ADSM retrieve only files that were archived within a particular window of time. For example, you can request that ADSM retrieve only files that were archived between 6:00 AM on June 1, 1995 and 11:59 PM on June 15, 1995.

The *time* must be in the format you select with the TIMEFORMAT option. For example, if TIMEFORMAT is set to the default of 1, the time must be in the format 23:00:00. If you include the TIMEFORMAT option with the command, it must precede the FROMTIME and TOTIME options.

The default for FROMTIME is 00:00:00.

Note: If you want ADSM to use a value you specify for FROMTIME, you must also include FROMDATE with the command. Otherwise, ADSM ignores FROMTIME.

RETRIEVE

If you use `SUBDIR=YES`, ADSM retrieves the most recent archive of a directory up to the time specified with `TOTIME` on the date specified with `TODATE`. ADSM ignores `FROMTIME` for directories.

-Pick

ADSM displays a list of archived files that match the file specification. You can select the files you want to retrieve from the list. See the `RESTORE` command for information on using the `PICK` window.

-Quiet

Prevents messages from being displayed on your screen during processing. However, certain error information is still displayed and all messages are written to log files (error log and schedule log, as appropriate).

-REPlace=*value*

When retrieving a file, determines what happens when a file of the same name as the archive already exists in the destination directory. The possible values are:

Prompt

ADSM prompts you for your choice for overwriting an existing file. If the file is read-only, you cannot overwrite it. This is the default unless `REPLACE` is set in the client options file.

No

ADSM does not overwrite existing files.

Yes

ADSM overwrites existing files, except for read-only files, without prompting you.

All

ADSM overwrites existing files, even if they are read-only, without prompting you.

-SUBdir=*value*

Whether ADSM should retrieve files in the subdirectories of the specified directory. The *value* is either **Yes** or **No**.

The default is **No**.

For example, to retrieve only the files in the `c:\proj` directory, enter:

```
RETRieve -Subdir=no c:\proj\*.*
```

To retrieve the files in the `c:\proj` directory and all of its subdirectories, enter:

```
RETRieve -Subdir=yes c:\proj\*.*
```

-TODate=*date*

The date to which you want ADSM to look for archives ADSM does not retrieve files that were archived on or after this date.

RETRIEVE

You can use this option in conjunction with the FROMDATE option to create a time window for archives. See the discussion of FROMDATE for more information on using TODATE.

-TOTime=*time*

Used in conjunction with the TODATE option to specify an ending time on the specified date. For example, with TOTIME and TODATE, you can request that ADSM retrieve only files that were archived on or before 11:59 PM on June 15, 1995.

You can also use TOTIME and TODATE with FROMTIME and FROMDATE to request that ADSM retrieve only files that were archived within a particular window of time. For example, you could request that ADSM retrieve only files that were archived between 6:00 AM on June 1, 1995 and 11:59 PM on June 15, 1995.

The *time* must be in the format you select with the TIMEFORMAT option. For example, if TIMEFORMAT is set to the default of 1, the time must be in the format 23:00:00. If you include the TIMEFORMAT option with the command, it must precede the FROMTIME and TOTIME options.

The default for TOTIME is 23:59:59.

Note: If you want ADSM to use a value you specify for TOTIME, you must also include TODATE with the command. Otherwise, ADSM ignores TOTIME.

If you use SUBDIR=YES, ADSM retrieves the most recent archive of a directory up to the time specified with TOTIME on the date specified with TODATE. ADSM ignores FROMTIME for directories.

You can also use these options:

DATEFORMAT
NODENAME
NUMBERFORMAT
PASSWORD
TAPEPROMPT
TIMEFORMAT
VERBOSE
All communication options

sourcefilespec

The path and name of the file in ADSM storage you want to retrieve. You can use wildcards to specify a group of files or all the files in a directory.

For example:

```
c:\proj\*.*
```

If you include *filespace*, do not include a drive letter in the file specification.

{filespace}

The name of the file space on the server that contains the file you want to retrieve, enclosed in braces. This name is the name of the drive label on the workstation drive from which the file was archived.

RETRIEVE

You must use the file space name if the drive label has changed or if you are retrieving files archived from another node whose drive labels are different from yours.

For example, to retrieve files from the **abc** file space's **proj** directory, use:

```
{abc}\proj\*.*
```

destinationfilespec

The path and file name where you want to place the retrieved files. If you do not specify a destination, ADSM returns the files to the original source path.

If the destination drive does not exist, be sure to end the file specification in either a directory delimiter (\) or a file name. Otherwise, ADSM assumes the last name is a file name, and tries to repeatedly overwrite the file as each file is restored.

Examples

- Task:** Retrieve a single file named **budget.fin**.
- Command:** RETrieve c:\devel\projecta\budget.fin
- Task:** Retrieve all files from the **c:\devel\projecta** directory with the extension **c**.
- Command:** RETrieve c:\devel\projecta*.c
- Task:** Retrieve all files from the **\devel\projecta** directory on the **dos** file space with the extension **c**.
- Command:** RETrieve {dos}\devel\projecta*.c
- Task:** Retrieve all files in the **c:\devel** directory.
- Command:** RET c:\devel*
- Task:** Retrieve all files from the **c:\devel\projecta** directory with the extension **c** to the **c:\newdevel\projectn** directory.
- Command:** RETrieve c:\devel\projecta*.c c:\newdevel\projectn
- Task:** Retrieve files in the **c:\project** directory. Use the PICK option.
- Command:** RETrieve c:\project* -PIck
- Output:** See the RESTORE command for information on using the PICK window.

Related Commands

Figure 67. Commands Related to RETRIEVE

Command	Description	Reference
ARCHIVE	Archive files on ADSM storage.	Page 146
DELETE ARCHIVE	Delete archived files from ADSM storage.	Page 151
QUERY ARCHIVE	Display a list of your archived files.	Page 165
QUERY FILESPACE	Display a list of file spaces.	Page 175

SCHEDULE

SCHEDULE—Running Scheduled Events

Use the SCHEDULE command to start the client scheduler on your workstation. The client scheduler must be running before work scheduled by your ADSM administrator can be initiated.

When you start the client scheduler, it continuously polls the server for scheduled events based on the time period specified with the QUERYSCHEDPERIOD option in your client options file. If your ADSM administrator globally sets the QUERYSCHEDPERIOD option for all nodes, that setting overrides your setting.

If you are using TCP/IP communications, you can have the server prompt your workstation when it is time to run a scheduled event. To do so, set the SCHEDMODE option to PROMPTED in the client options file or on the SCHEDULE command.

After you start the client scheduler, it continues to run and to initiate scheduled events until you stop it by pressing Ctrl+Break, rebooting the machine, or turning off the machine.

You *cannot* issue this command in interactive mode.

Syntax

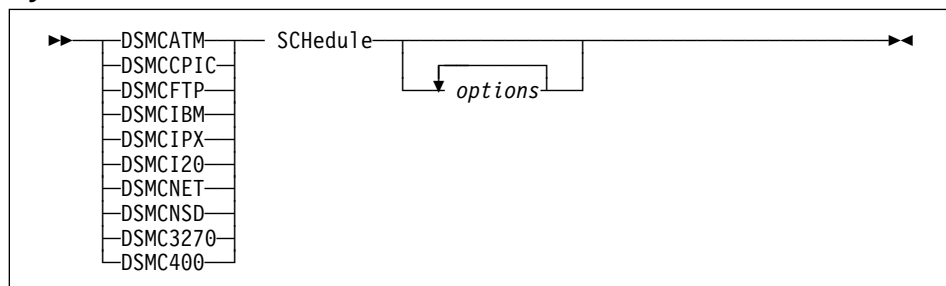

Parameters

options

Any of the following options:

-MAXCMDRetries=*maxcmdretries*

The maximum number of times the client scheduler on your workstation can retry a scheduled command that fails.

The range of values is 0 to 9999.

The default is 2.

MAXCMDRETRIES might also be set in the client options file or on the server. The server value overrides any value you set.

For example, to initiate scheduled events and to set the maximum number of retries to 1, enter:

```
dsmcibm SCHEDULE -MAXCMDRetries=1
```

SCHEDULE

-PASsword=*password*

The ADSM password for your workstation. If an ADSM password is required, and you want to run the SCHEDULE command, you must supply the password with the command.

-QUERYSCHeDperiod=*query_period*

The number of hours you want the client scheduler to wait between attempts to contact the server.

The range of values is 1 to 9999.

The default is 12.

QUERYSCHEDPERIOD might also be set in the client options file or on the server. The server value overrides any value you set.

For example, to initiate scheduled events and to set the number of hours between attempts by the client to contact the server to 8, enter:

```
dsmcibm SCHEDULE -QUERYSCHeDperiod=8
```

-RETRYPeriod=*retry_period*

The number of minutes the client scheduler waits between unsuccessful attempts to contact the server or process a command that failed.

The range of values is 1 to 9999.

The default value is 20.

RETRYPERIOD might also be set in the client options file or on the server. The server value overrides any value you set.

For example, to initiate scheduled events and to set the number of minutes between retry attempts to 15, enter:

```
dsmcibm SCHEDULE -RETRYPeriod=15
```

-SCHEDLOGname=*filespec*

The name of a schedule log. ADSM writes messages that result from the scheduled task to this file. If SCHEDLOGNAME is not defined in the client options file, the default is **dsmsched.log** and it is in the current directory.

-SCHEDMODE=*type*

The schedule mode to use, **POLLing** or **PROMPTed**. If SCHEDMODE is POLLING, your client node periodically asks the server for scheduled work. If SCHEDMODE is PROMPTED, which is only available with TCP/IP communications, the server contacts your client node when it is time to start a scheduled service.

-TCPCLIENTAddress=*client_address*

The TCP/IP address you want the server to use to contact your client node. You can only specify this option when SCHEDMODE is PROMPTED. To use the **128.33.10.49** address, enter:

```
dsmcibm SCHEDULE -TCPCLIENTAddress=128.33.10.49
```

SCHEDULE

-TCPCLIENTPort=client_port

The TCP/IP port number you want the server to use to contact your client node. You can only specify this option when SCHEDMODE is PROMPTED. To use the **1502** port, enter:

```
dsmcibm SCHEDULE -TCPCLIENTPort=1502
```

You can also use these options:

DATEFORMAT
NODENAME
NUMBERFORMAT
QUIET
TIMEFORMAT
VERBOSE
All communication options

Examples

Task: Start the client scheduler using IBM TCP/IP 2.1.

Command: dsmcibm SCHEDULE -password=note11

Related Commands

Figure 68. Commands Related to SCHEDULE

Command	Description	Reference
QUERY SCHEDULE	Display information about scheduled events.	Page 179

SELECTIVE

SELECTIVE—Backing Up Selected Files

Use the SELECTIVE command to selectively back up files that you work with on a day-to-day basis. If any of those files become damaged or lost, you can obtain backup versions from the server to replace them.

When you run a selective backup, ADSM backs up all the files unless they are excluded from backup in your include-exclude list or unless they do not meet management class requirements for serialization.

During a selective backup, ADSM sends copies of the files to the server regardless of whether they have changed since the last backup. As a result, you could have more than one copy of the same file on the server. If that occurs, you may not have as many different down-level versions of the file on the server as you intended. Your version limit could be made up of identical files. You can use the INCREMENTAL command to back up only changed and new files if you want to avoid that possibility.

You can selectively back up single files or directories. You can also use wildcards to back up groups of related files.

Syntax

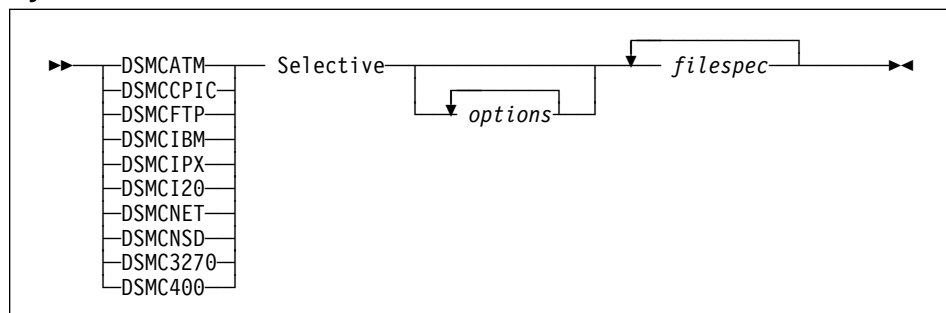

Parameters

options

Any of the following options:

CHangingretries=numberretries

The number of times you want ADSM to attempt to back up a file that changes during the first attempt. This option relates to serialization, which is an attribute in a management class copy group. ADSM uses this option only when serialization is shared static or shared dynamic.

The range of values is 0 to 4.

-Quiet

Prevents messages from being displayed on your screen during processing. However, certain error information is still displayed and all messages are written to log files (error log and schedule log, as appropriate).

SELECTIVE

-Subdir=value

Whether ADSM should back up files in the subdirectories of the specified directory. The *value* is either **Yes** or **No**.

The default is No.

For example, to back up only the files in the **c:\proj** directory, enter:

```
Selective -Subdir=no c:\proj\*.*
```

To back up the files in the **c:\proj** directory and all of its subdirectories, enter:

```
Selective -Subdir=yes c:\proj\*.*
```

-TAPEPrompt=value

Determines whether ADSM prompts you when a tape is required, so that you can choose whether to wait (**Yes**), or whether ADSM should automatically wait for a tape to be mounted (**No**).

The default is No.

For example, to have ADSM prompt you for a tape mount, use:

```
selective d:\script\* -tapeprompt=yes
```

You can also use these options:

DATEFORMAT
NODENAME
NUMBERFORMAT
PASSWORD
VERBOSE
All communication options

filespec

The path and name of the file you want to back up. You can use wildcards to select a group of files or all the files in a directory.

You can enter multiple file specifications in one command.

Examples

Task: Back up the **proja.dev** file in the **c:\devel** directory.

Command: `Selective c:\devel\proja.dev`

Task: Back up all files in the **c:\devel** directory whose file names begin with **proj**.

Command: `Selective c:\devel\proj*.*`

Task: Back up all files in the **c:\devel** directory whose file names begin with **proj**. Also, back up all files in the **c:\planning** directory with the extension **fin**.

Command: `Selective c:\devel\proj* c:\planning*.fin`

SELECTIVE

Related Commands

Figure 69. Commands Related to SELECTIVE

Command	Description	Reference
INCREMENTAL	Back up new and changed files.	Page 157
QUERY BACKUP	Display a list of backup versions of your files.	Page 170
RESTORE	Restore files from ADSM storage.	Page 181

SET ACCESS

SET ACCESS—Granting Access to Files

Use the SET ACCESS command to grant users at other nodes access to your backup versions or archived copies. When you grant access to another user, that user can restore or retrieve your files.

Using the SET ACCESS command, you can grant another user access to a specific file, multiple files, or all files in a directory. However, you must specifically state in the command whether you are granting access to archives *or* backups. You cannot grant access to both types of files with a single command.

Syntax

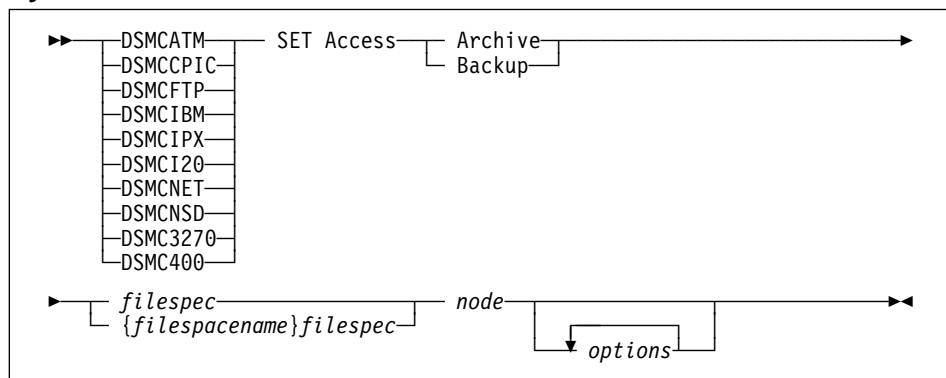

Parameters

Archive

Grants access to archived files.

Backup

Grants access to backup versions of files.

filespec

The path and name of the file in ADSM storage to which you are giving access. You can use wildcards to specify a group of files or all the files in a directory.

For example:

```
c:\proj\*.*
```

If you include *filespace*, do not include a drive letter in the file specification.

If you do not use a full path name, the DOS client adds the current path name to the file specification.

{*filespace*}

The name of the file space on the server that contains the file to which you are giving access, enclosed in braces. This name is the name of the drive label on the workstation drive from which the file was backed up or archived.

You must use the file space name if the drive label has changed.

SET ACCESS

For example, to set access to the **abc** file space's **proj** directory, use:

```
{abc}\proj\*.*
```

node

The ADSM client node of the user to which you are granting access. You can use wildcards to grant access to multiple nodes with similar node names. Use ***** to grant access to all users.

options

You can use these options:

- DATEFORMAT
- NODENAME
- NUMBERFORMAT
- PASSWORD
- TIMEFORMAT
- All communication options

Examples

Task: Give the user at **node_2** the authority to restore all files with the extension **c** from the **c:\devel\proja** directory

Command: SET Access Backup c:\devel\proja*.c node_2

Task: Give the user at **node_3** the authority to retrieve all files in the **c:\devel** directory, but do not allow access to files in subdirectories of **c:\devel**, such as **c:\devel\proj**.

Command: SET Access Archive c:\devel* node_3

Task: Give all users at nodes whose node names end with **bldgb** the authority to restore all the backup versions from all directories on the **d:** drive. The **d:** drive has the file space name **project**.

Command: SET A B {project}** *bldgb

Related Commands

Figure 70. Commands Related to SET ACCESS

Command	Description	Reference
DELETE ACCESS	Revoke authorization for another user to restore or retrieve your files.	Page 149
QUERY ACCESS	Display a list of current authorization rules for backup versions and archived copies of your files.	Page 163
QUERY FILESPACE	Display a list of file spaces.	Page 175

SET PASSWORD

SET PASSWORD—Changing Your Password

Use the SET PASSWORD command to change the ADSM password for your workstation. If you do not enter your old and new passwords, you are prompted for them.

When ADSM prompts you for a password, the password you enter does not appear on your screen. This provides you with better security.

ADSM prompts you for the new password twice to protect you from error.

An ADSM password can be up to 64 characters. Valid characters are:

Characters	Description
A–Z	any letter, A through Z, upper or lower case
0–9	any number, 0 through 9
+	plus
.	period
_	underscore
-	hyphen
&	ampersand

A password is not case sensitive.

Syntax

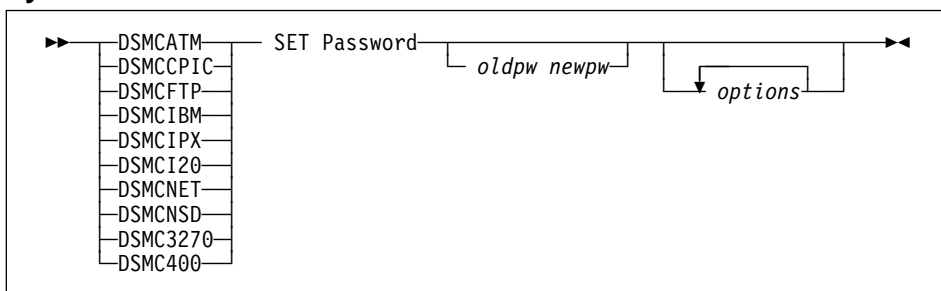

Parameters

oldpw

The current ADSM password for your workstation.

newpw

A new ADSM password for your workstation.

options

Any communication options.

Examples

Task: Change your ADSM password, having ADSM prompt you for the password.

Command: SET Password

Appendix A. Diagnosing Memory and Sharing Problems

Use this appendix to help you resolve problems that prevent ADSM from executing normally because of memory or sharing problems.

Note: You may experience performance or memory problems when attempting to back up, restore, archive, retrieve, or display large numbers (thousands) of files or directories. The exact level at which problems occur depends on your hardware. These problems are caused by memory constraints of the DOS operating system, which ADSM cannot overcome.

Fixing Problems with Expanded, Extended, and Conventional Memory

This program automatically makes use of the expanded, extended, and conventional memory available on your machine, and tailors its use to the actual amounts of each type of memory that you have installed on your system. Make sure your expanded and extended memory is configured properly before running ADSM.

If you have a problem with one of the ADSM programs, try disabling its use of some type of memory in order to determine if that type of memory is not configured correctly. To do so, use the environment variables explained in the following sections. Use the DOS SET command to set these environment variables before running ADSM. You can set these variables in the AUTOEXEC.BAT file.

Controlling the Use of Expanded Memory

Use the RTVMEXP environment variable to control the use of expanded memory by specifying the number of KB of expanded memory the program is allowed to use. Use the following command to disable ADSM's use of expanded memory:

```
SET RTVMEXP=0
```

If ADSM works after you disable expanded memory, the page frame address being used by ADSM is probably also being used by another hardware feature or software program. Expanded memory drivers cannot always detect what other hardware features or software programs on your system are using an address, and so the driver might pick an invalid address.

Portions of ADSM can execute in expanded memory, so when expanded memory is available, it is used in preference to extended memory. ADSM uses a segment address that is a low address threshold for expanded memory, and does not use addresses below this threshold. Normally, the low threshold is set to hexadecimal C000.

Memory below C000 is either conventional DOS memory or video memory. By using C000 as a low threshold, ADSM ensures that video memory is used for its intended purpose.

If you are having problems running ADSM, you might want to change the low threshold address, especially if you are using a machine that places video memory elsewhere. Use the RTVMEXPLOW environment variable to change the threshold to another hexadecimal address. For example, to change the low threshold to A000, specify:

```
SET RTVMEXPLOW=A000
```

Do not set the low threshold to below A000. Even if you do, the memory below A000 is not used as expanded memory.

Controlling the Use of Extended Memory

Use the RTVMEXT environment variable to control the use of extended memory by specifying the number of KB of extended memory the program is allowed to use. Use the following command to disable ADSM's use of extended memory:

```
SET RTVMEXT=0
```

Controlling the Use of Conventional Memory

Use the RTVMCONV environment variable to control the use of conventional memory by specifying the number of KB of conventional memory the program is allowed to use. If the memory available on your machine is limited, and you are getting "out of memory" messages when running ADSM, you might want to set a minimal use of conventional memory. Use the following command to set a minimal use of conventional memory:

```
SET RTVMCONV=0
```

You should have expanded or extended memory available on your workstation before setting RTVMCONV to zero. Otherwise, setting RTVMCONV to zero might cause the ADSM client to perform a lot of disk activity, because it must swap portions of the program into RAM from the disk. If you want to reduce the disk activity, try using numbers larger than zero.

Fixing Memory Problems with Specific Communication Methods

You might experience memory problems while using certain communication methods. Use the methods described below to increase the amount of memory available to ADSM. You must be running DOS 5.0 or above.

Networking Services/DOS (NS/DOS)

If memory problems occur when using the SNA LU6.2 communication method, as implemented by NS/DOS, include the following entries in the appropriate system files. (These examples assume the DOS system files are contained in the C:\DOS directory.)

Place the following entries at the beginning of your CONFIG.SYS file. Use a DEVICEHIGH= statement to load any subsequent device driver into high memory.

```
DEVICE=C:\DOS\HIMEM.SYS
DOS=HIGH,UMB
DEVICE=C:\DOS\EMM386.EXE NOEMS
:
```

Place the following entries at the beginning of your AUTOEXEC.BAT file.

```
C:\DOS\EMM386 ON
:
SET NSDM=C:\NSD
SET NSDL=2924
CD NSD
STARTNSD /S
CD \
:
```

PC Support/400 or Client Access/400 BASE Option

The ADSM client needs about 400 KB to run. Because the BASE option on PC Support/400 and Client Access/400 can only use conventional memory (memory below 640K), there might not be enough space for the ADSM client to run efficiently (or even to run at all). Perform the following steps to free enough memory for the ADSM client. (Although these steps only refer to PC Support/400, Client Access/400 uses similar procedures.)

1. Remove some PC Support/400 functions, either through the PC Support/400 menu or by changing your Startup Options.
 - To temporarily remove some PC Support/400 functions, press F3 (EXIT) in the PC Support/400 Menu. Select **Remove specific PC Support functions** in the pop-up window. The menu **Remove PC Support Functions Menu** appears. You can select any function listed in this menu except **Router**.
 - To prevent PC Support/400 functions from starting up automatically, invoke CFGPCS.EXE in the QIWSFLR directory of the share folder drive and select **Startup Options**. Remove some functions in the "PC Support functions to be started automatically" field in the Startup Options Menu and select **No Menu** for the "Initial PC Support Menu" field. After you have completed your selections, exit the PC Support Configuration menu. Reboot your workstation for the changes to take effect.
2. Remove any device driver statements that you do not need from your CONFIG.SYS file.
3. Remove any TSR (Terminate and Stay Resident) programs that you do not need from your AUTOEXEC.BAT file.

PC Support/400 or Client Access/400 EXTENDED Option

If memory problems occur when using the EXTENDED option on PC Support/400 or Client Access/400, the following steps help to free up some memory for ADSM clients.

1. Use the DEVICEHIGH= statement for loading device drivers into high memory.
2. Use the DOS command LOADHIGH or LH in your AUTOEXEC.BAT file to load any TSR (Terminate and Stay Resident) programs into high memory.
3. If the problem still occurs, follow the steps in "PC Support/400 or Client Access/400 BASE Option" to free up some memory by removing some PC Support/400 or Client Access/400 functions.

Fixing Sharing Problems

If you get sharing violations when running ADSM on networks, try making the ADSM executable files (*.EXE) read-only using the DOS ATTRIB command. For example, to make all ADSM executable files read-only, enter:

```
attrib +r c:\adsm\*.exe
```

Also, be sure to use the DOS SHARE command, so that DOS is aware of sharing violations. This prevents ADSM from overwriting programs, including itself, if you try to restore them while they are running. The results are unpredictable if you restore a running program when you do not use the SHARE command.

The terms in this glossary are defined as they pertain to the ADSM library. If you do not find a term you are looking for, you can refer to the *IBM Dictionary of Computing*, McGraw-Hill, 1994. In the United States and Canada you can order this publication by calling McGraw Hill at 1-800-2MC-GRAW.

This glossary may include terms and definitions from:

- The *American National Standard Dictionary for Information Systems*, ANSI X3.172-1990, copyright (ANSI). Copies may be purchased from the American National Standards Institute, 11 West 42nd Street, New York, New York 10036.
- The *Information Technology Vocabulary*, developed by Subcommittee 1, Joint Technical Committee 1, of the International Organization for Standardization and the International Electrotechnical Commission (ISO/IEC JTC2/SC1).

A

absolute. A copy group mode value that indicates that a file is considered for incremental backup even if it has not changed since the last time it was backed up. See *mode*. Contrast with *modified*.

active policy set. The policy set within a policy domain that contains the most recently activated policy. This policy set is used by all client nodes assigned to the current policy domain. See *policy set*.

active version. The most recent backup copy of a file stored in ADSM storage for a file that currently exists on a file server or workstation. An active version remains active and exempt from deletion until it is replaced by a new backup version, or ADSM detects during an incremental backup that the user has deleted the original file from a file server or workstation.

administrative client. A program that runs on a file server, workstation, or mainframe. This program allows administrators to control and monitor ADSM servers through ADSM administrator commands. Contrast with *backup-archive client*.

administrator. A user who has been registered to the server as an administrator. Administrators can be assigned one or more privilege classes. Administrators can use the administrative client to enter ADSM server commands and queries according to their privileges.

ADSM. ADSTAR Distributed Storage Manager

ADSTAR Distributed Storage Manager (ADSM). A client/server program that provides storage management and data access services to customers in a multivendor computer environment.

Advanced Program-to-Program Communications (APPC). An implementation of the SNA LU6.2 protocol that allows interconnected systems to communicate and share the processing of programs. See *Systems Network Architecture Logical Unit 6.2* and *Common Programming Interface Communications*.

APPC. Advanced program-to-program communications.

archive. A function that allows users to copy one or more files to a long-term storage device. Archive copies may be accompanied by descriptive information, may imply data compression software usage, and may be retrieved by archive date, file name, or description. Contrast with *retrieve*.

archive copy. A file or group of files residing in an archive storage pool in ADSM storage.

archive copy group. A policy object that contains attributes which control the generation, destination, and expiration of archive files. The archive copy group belongs to a management class.

archive retention grace period. The number of days ADSM retains an archive copy when the server is unable to rebind the file to an appropriate management class.

authentication. The process of checking and authorizing a user's password before allowing that user access to the ADSM server. Authentication can be turned on or off by an administrator with system privilege.

authorization rule. A specification that allows another user to either restore or retrieve a user's files from ADSM storage.

B

backup. A function that allows users to copy one or more files to a storage pool to protect against data loss. Contrast with *restore*.

backup-archive client. A program that runs on a file server, PC, or workstation and provides a means for ADSM users to back up, archive, restore, and retrieve files. Contrast with *administrative client*.

backup copy group. A policy object that contains attributes which control the generation, destination, and expiration of backup files. The backup copy group belongs to a management class.

backup retention grace period. The number of days ADSM retains a backup version when the server is unable to rebind the file to an appropriate management class.

backup version. A file, directory, or file space that a user has backed up that resides in a backup storage pool in ADSM storage. Though there may be more than one backup version of a file in ADSM storage, only one is considered the active version. See *active version* and *inactive version*.

bindery. A database that consists of three system files for a NetWare 3.11 or 3.12 server. The files contain user IDs and user restrictions.

binding. The process of associating a file with a management class name.

C

central scheduling. A function that allows an administrator to schedule backup and archive operations from a central location. The operations can be scheduled on a periodic basis or on an explicit date.

client. A program running on a file server, PC, workstation or terminal that requests services of another program called the server. There are two types of ADSM clients: administrative client and backup-archive client. See *administrative client* and *backup-archive client*.

Client Access/400. A software product that supports advanced program-to-program communications (APPC) in the DOS, OS/2, and Microsoft Windows environments and provides a set of end user services.

client domain. The set of drives, file systems, or volumes selected by a user for processing during a backup or archive operation.

client node. A file server or workstation on which the backup-archive client program has been installed that has been registered with the server.

client options file. A user-editable file that contains processing options to identify ADSM servers, select communication methods, specify backup, archive,

restore, and retrieve options, define scheduling options, and to choose formats for date, time, and numbers. Also called the **dsm.opt** file.

client polling. A client/server communication technique where the client node queries the server for scheduled work.

client/server. A communications network architecture in which one or more programs (clients) request computing or data services from another program (the server).

client system options file. A file, used on UNIX clients, that contains a number of processing options which identify the ADSM servers to be contacted for services. This file also specifies communications options, backup and archive processing options, and scheduling options. Also called the **dsm.sys** file. See *client user options file*.

client user options file. A user-editable file, used on UNIX clients, that contains processing options to identify the ADSM server to contact, to specify backup, archive, restore, and retrieve options, and to select formats for date, time, and numbers. Also called the **dsm.opt** file. See the *client systems options* file.

closed registration. A registration process in which an ADSM administrator must register workstations as client nodes with the server. Contrast with *open registration*.

command line interface. A type of user interface where commands are specified on the command line. Contrast with *graphical user interface*.

Common Programming Interface Communications (CPIC). A programming interface that allows program-to-program communication using SNA LU6.2. See *Systems Network Architecture Logical Unit 6.2*.

communication method. The method by which a client and server exchange information. For ADSM backup-archive clients, the method can be 3270, PWSCS, SNA LU6.2, or TCP/IP. See *Programmable Workstation Communication Service*, *Systems Network Architecture Logical Unit 6.2*, and *Transmission Control Protocol/Internet Protocol*.

communication protocol. A set of defined interfaces that allows computers to communicate with each other.

copy group. A policy object that contains attributes which control the generation, destination, and expiration of backup and archive files. There are two kinds of copy

groups: backup copy group and archive copy group. Copy groups belong to management classes. See *frequency*, *destination*, *mode*, *retention*, *serialization*, and *version*.

CPIC. Common Programming Interface Communications.

D

default management class. A management class assigned to a policy set that is used to govern backed up or archived files when a user does not explicitly associate a file with a specific management class through the include-exclude list.

destination. A copy group attribute that specifies the storage pool to which a file will be backed up or archived. At installation, ADSM provides two storage destinations named BACKUPPOOL and ARCHIVEPOOL.

domain. See *policy domain* or *client domain*.

dsm.opt file. See *client options file* and *client user options file*.

dsm.sys file. See *client system options file*.

dynamic. A copy group serialization value that specifies that ADSM accepts the first attempt to back up or archive an object, regardless of any changes made during backup or archive processing. See *serialization*. Contrast with *shared dynamic*, *shared static*, and *static*.

E

error log. A text file written on disk that contains ADSM processing error messages. These errors are detected and saved by the ADSM server.

exclude. The process of identifying files in an include-exclude list to prevent them from being backed up whenever a user or schedule issues an incremental or selective backup operation.

expiration. The process by which files are identified for deletion because their expiration date or retention period has passed. Backed up or archived files are marked for

deletion based on the criteria defined in the backup or archive copy group.

F

file server. A dedicated computer and its peripheral storage devices that are connected to a local area network that stores both programs and files that are shared by users on the network.

file space. A logical space on the ADSM server that contains a group of files. In ADSM, users can restore, retrieve, or delete file spaces from ADSM storage. On systems such as DOS or OS/2, a file space is a logical partition and is identified by a volume label. On UNIX systems, a file space is a logical space that contains a group of files backed up or archived from the same file system (or part of a file system defined with the VIRTUALMOUNTPOINT option in the client system options file).

frequency. A copy group attribute that specifies the minimum interval, in days, between incremental backups.

fuzzy backup. A backup version of a file that might not accurately reflect what is currently in the file because ADSM backed up the file while the file was being modified.

fuzzy copy. An archive copy of a file that might not accurately reflect what is currently in the file because ADSM archived the file while the file was being modified.

G

gigabyte (GB). (1) One billion (10⁹) bytes. (2) When referring to memory capacity, 1 073 741 824 in decimal notation.

graphical user interface (GUI). A type of user interface that takes advantage of a high-resolution monitor, includes a combination of graphics, the object-action paradigm, and the use of pointing devices, menu bars, overlapping windows, and icons. Contrast with *command line interface*. See *windowed interface*.

GUI. Graphical user interface.

H

hierarchical storage management client. A program that runs on a workstation or file server to provide space management services. It automatically migrates eligible files to ADSM storage to maintain specific levels of free space on local file systems, and automatically recalls migrated files when they are accessed. It also allows users to migrate and recall specific files.

hive. On Windows NT, a registry subkey that corresponds to a set of files in the `\system32\config` directory.

HSM. Hierarchical Storage Management.

I

inactive version. A copy of a backup file in ADSM storage that either is not the most recent version or the corresponding original file has been deleted from the client file system. Inactive backup versions are eligible for expiration according to the management class assigned to the file.

include-exclude file. On UNIX clients, a file that contains statements which ADSM uses to determine whether to back up certain files and to determine the associated management classes to use for backup or archive. See *include-exclude list*.

include-exclude list. A list of INCLUDE and EXCLUDE options that include or exclude selected files for backup. An EXCLUDE option identifies files that should not be backed up. An INCLUDE option identifies files that are exempt from the exclusion rules or assigns a management class to a file or a group of files for backup or archive services. The include-exclude list is defined either in the include-exclude file (for UNIX clients) or in the client options file.

incremental backup. A function that allows users to back up files or directories from a client domain that are not excluded in the include-exclude list and that meet the requirements for frequency, mode, and serialization as defined by a backup copy group of the management class assigned to each file. Contrast with *selective backup*.

IPX/SPX. Internetwork Packet Exchange/Sequenced Packet Exchange.

L

Local Area Network (LAN). A variable-sized communications network placed in one location. It connects servers, PCs, workstations, a network operating system, access methods, and communications software and links.

M

management class. A policy object that is a named collection of copy groups. A management class is associated with a file to specify how the server should manage backup versions or archive copies of workstation files. See *binding* and *copy group*.

migration. The process of copying a file from a local file system to ADSM storage and replacing the file with a stub file on the local file system.

mode. A copy group attribute that specifies whether a backup file should be created for a file that was not modified since the last time the file was backed up. See *absolute* and *modified*.

modified. A backup copy group attribute that indicates that a file is considered for backup only if it has been changed since the last backup. A file is considered changed if the date, size, owner, or permissions have changed. See *absolute* and *mode*.

N

Named Pipe. A type of interprocess communication which allows message data streams to be passed between peer processes, such as between a client and a server.

NDS. NetWare Directory Services.

NETBIOS. Network Basic Input/Output System. An operating system interface for application programs used on IBM personal computers that are attached to the IBM Token-Ring Network.

NetWare Directory Services (NDS). A database used by Novell NetWare to organize resources for an entire network of NetWare servers. The database itself can be distributed across the network and accessed by all servers. The NDS is available in NetWare Version 4.0 and higher.

NetWare Loadable Module (NLM). Novell NetWare software that provides extended server capability. Support for various ADSM and NetWare platforms are examples of NLMs.

Networking Services/DOS (NS/DOS). A software product that supports advanced program-to-program communications (APPC) in the DOS and Microsoft Windows 3.1 environments. With NS/DOS, communications applications on your workstation can 'talk to' partner applications on other systems that support APPC.

NLM. NetWare Loadable Module.

node. See *client node*.

node name. A unique name used to identify a workstation, file server, or PC to the server.

NS/DOS. Networking Services/DOS.

NTFS. The NT file system on Windows NT.

O

open registration. A registration process in which users can register their own workstations or PCs as client nodes with the server. Contrast with *closed registration*.

owner. The owner of backup-archive files sent from a multi-user client node, such as AIX.

P

pattern-matching character. See *wildcard character*.

PC Support/400. A software product that supports advanced program-to-program communications (APPC) in the DOS, OS/2, and Microsoft Windows environments and provides a set of end user services.

policy domain. A policy object that contains one or more policy sets. Client nodes are associated with a policy domain. See *policy set*, *management class*, and *copy group*.

policy set. A policy object that contains a group of management class definitions that exist for a policy domain. At any one time, there can be many policy sets within a policy domain, but only one policy set can be active. See *active policy set* and *management class*.

Programmable Workstation Communication Services (PWSCS). A product that provides transparent high performance communications between programs running on workstations or on host systems.

PWSCS. Programmable Workstation Communication Services.

R

registration. The process of identifying a client node or administrator to the server by specifying a user ID, password, and contact information. For client nodes, a policy domain, compression status, and deletion privileges are also specified.

registry. On Windows NT, a central database that contains information about hardware, applications, and operating system settings for each machine on the network. Provides security and control over system, security, and account settings.

restore. A function that allows users to copy a version of a backup file from the storage pool to a workstation or file server. The backup copy in the storage pool is not affected. Contrast with *backup*.

retention. The amount of time, in days, that inactive backed up or archived files are retained in the storage pool before they are deleted. The following copy group attributes define retention: retain extra versions, retain only version, retain version.

retrieve. A function that allows users to copy an archive file from the storage pool to the workstation or file server. The archive copy in the storage pool is not affected. Contrast with *archive*.

S

scheduling mode. The type of scheduling operation for the server and client node. ADSM supports two scheduling modes: client-polling and server-prompted.

selective backup. A function that allows users to back up files from a client domain that are not excluded in the include-exclude list and that meet the requirement for serialization in the backup copy group of the management class assigned to each file. Contrast with *incremental backup*.

serialization. A copy group attribute that specifies whether a file can be modified during a backup or

archive operation and what to do if it is. See *static*, *dynamic*, *shared static*, and *shared dynamic*.

server. A program running on a mainframe, workstation, or file server that provides shared services such as back up and archive to other various (often remote) programs called clients.

server-prompted scheduling. A client/server communication technique where the server contacts the client node when work needs to be done.

session. A period of time in which a user can communicate with a server to perform backup, archive, restore, or retrieve requests.

shared dynamic. An ADSM copy group serialization mode. This mode specifies that if a file changes during backup or archive and continues to be changed after a number of retries, the last retry commits the file to the ADSM server whether or not it changed during backup or archive.

shared static. A copy group serialization value that specifies that a file must not be modified during a backup or archive operation. ADSM attempts to retry the operation a number of times. If the file is in use during each attempt, the file is not backed up or archived. See *serialization*. Contrast with *dynamic*, *shared static*, and *static*.

SNA LU6.2. Systems Network Architecture Logical Unit 6.2.

space management attributes. Attributes contained in a management class that specify whether automatic migration is allowed for a file, whether selective migration is allowed for a file, how many days must elapse since a file was last accessed before it is eligible for automatic migration, whether a backup version of a file must exist before the file can be migrated, and the ADSM storage pool to which files are migrated.

static. A copy group serialization value that specifies that a file must not be modified during a backup or archive operation. If the file is in use during the first attempt, ADSM will not back up or archive the file. See *serialization*. Contrast with *dynamic*, *shared static*, and *static*.

storage pool. A named set of storage volumes that is used as the destination of backup or archive copies.

system drive or partition. On Windows NT, the drive or partition on which Windows NT is installed. The

Windows NT directory is usually called WINNT or WINNT35.

Systems Network Architecture Logical Unit 6.2 (SNA LU6.2). A set of rules for data to be transmitted in a network. Application programs communicate with each other using a layer of SNA called Advanced Program-to-Program Communication (APPC).

T

TCP/IP. Transmission Control Protocol/Internet Protocol.

timeout. (1) An event that occurs at the end of a predetermined period of time that began at the occurrence of another specified event. (2) A time interval allotted for certain operations to occur; for example, response to polling or addressing before system operation is interrupted and must be restarted. (3) A terminal feature that logs off a user if an entry is not made within a specified period of time.

Transmission Control Protocol/Internet Protocol (TCP/IP). A standard set of communication protocols that supports peer-to-peer connectivity of functions for both local and wide-area networks.

V

version. The maximum number of different backup copies of files retained for files. The following backup copy group attributes define version criteria: versions data exists and versions data deleted.

W

wildcard character. An asterisk (*) or question mark (?) character that is used to search for various or certain combinations of alphanumeric and symbolic names. These names can reflect file names or character strings within a file, for example.

windowed interface. A type of user interface that is either a graphical user interface or a text-based interface. The text-based interface maintains a close affinity to the graphical user interface, including action bars and their associated pull-down menus and windows. See *graphical user interface*.

workstation. A programmable high level workstation (usually on a network) with its own processing hardware

such as a high-performance personal computer. In a local area network, a personal computer that acts as a

single user or client. A workstation can also be used as a server.

Index

Numerics

3270BUFFERSIZE option 128
3270CHECKSUM option 129
3270HOSTCMDPAUSE option 130
3270HOSTCOMMAND option 131
3270HOSTENDCOMMAND option 132
3270HOSTTIMEOUT option 133
3270LOGICALTERMINALID option 134
400COMMBUFFERBYTES option 135
400PARTNERLUNAME option 136
400SENDERBUFFERBYTES option 137
400TPNAME option 138

A

absolute mode 56
access
 changing 200
 deleting 149
 querying 163
 setting 200
activation date/time 53
active and inactive files 23
active file
 displaying 170
active files only 23
active policy set 53
active version 23
ADSM
 understanding options 61
ADSTAR Distributed Storage Manager
 ending 8
 introducing xi, 1
 online help 7
 password 5, 8
 publications xii
 using 5
ADSTAR Distributed Storage Manager (ADSM)
 expanded and extended memory 203
 sharing problems 206
 starting 5
Alt key 7
archive
 advanced 38
 command 38
archive (*continued*)
 compared to backup 9
 delete files 151
 deleting 38
 deleting file spaces 33
 description 36
 directory tree 37
 display files 165
 file specification 35
 giving access to files in 200
 mode 56
 options window 36
 retrieve 41
archive (A) attribute 16
ARCHIVE command 146
 overview 38
archive copy group
 attributes, descriptions of 54
 description of 53
Archive Options window 36
archive retention, grace period 54
archiving files
 specifying management class 74
 summary of options 65
ARCHMC option 146
arrow key 7
assigning a management class
 to directories 59
ATTRIB command, DOS 206
attributes
 archive copy group 54
 backup copy group 54
authorization
 deleting 149
 setting 200
authorization rules
 querying 163
authorizations 28
authorizing
 user for restore or retrieve 28
automatic backup and archive services
 description of 3

B

- backing up
 - open file 17
- backing up files
 - specifying management class 74
 - summary of options 65
- backup
 - active version 23
 - compared to archive 9
 - deleting file spaces 33
 - directory, by 19
 - display files 170
 - drive label 15
 - failures 13
 - file specification, by 18
 - giving access to files in 200
 - how managed 17
 - inactive version 23
 - include-exclude list 14
 - incremental
 - advanced 14
 - basic 10
 - by date 11
 - full 11
 - processing 16
 - types of 10
 - mode 56
 - new or changed files 10
 - overview 9
 - restore 23
 - selective 197
 - advanced 21
 - command 21
 - processing 23
 - status 12
- backup by date
 - running 11
- backup copy group
 - attributes, descriptions of 54
 - description of 52
- backup retention, grace period 54
- Backup Status window 12
- Backup versions
 - fuzzy backup 56
- backup-archive client 1
- batch mode 139
- binding management classes to files 59
- bottom up processing 72
- buffer size

- buffer size (*continued*)
 - for 3270 128
 - for Client Access/400 135, 137
 - for PC Support/400 135, 137
- bytes transferred 13

C

- central scheduling
 - description of 3
 - setting up 45
 - summary of options 66
- change
 - access 200
 - ADSM password 202
- changed file 16
- changed files, backing up 10
- changing
 - authorizations 28
- CHANGINGRETRIES option 76
- Client Access/400
 - communication buffer, size of 135, 137
 - memory problems, BASE option 205
 - memory problems, EXTENDED option 205
- client commands
 - overriding client options file 68
- client message language type 94
- client options
 - 3270BUFFERSIZE 128
 - 3270CHECKSUM 129
 - 3270HOSTCMDPAUSE 130
 - 3270HOSTCOMMAND 131
 - 3270HOSTENDCOMMAND 132
 - 3270HOSTTIMEOUT 133
 - 3270LOGICALTERMINALID 134
 - 400COMMBUFFERBYTES 135
 - 400PARTNERLUNAME 136
 - 400SENDERBUFFERBYTES 137
 - 400TPNAME 138
 - CHANGINGRETRIES 76
 - command line, use 68
 - COMMMETHOD 77
 - COMPRESSALWAYS 78
 - COMPRESSION 79
 - CPICBUFFERSIZE 80
 - CPICMODENAME 81
 - DATEFORMAT 82
 - DIRMC 83
 - DOMAIN 84
 - ERRORLOGRETENTION 85

client options (*continued*)

- EXCLUDE 69, 86
- FSTYPES 87
- INCLUDE 69, 88
- IPXBUFFERSIZE 90
- IPXSERVERADDRESS 91
- IPXSOCKET 92
- LANADAPTER 93
- LANGUAGE 94
- MAXCMDRETRIES 95
- NETBIOSBUFFERSIZE 96
- NETBIOSNAME 97
- NETBIOSSERVERNAME 98
- NETBIOSTIMEOUT 99
- NODENAME 100
- NUMBERFORMAT 101
- PARTNERLUNAME 102
- POSTSCHEDULECMD 103
- PRESCHEDULECMD 104
- QUERYSCHEDULEPERIOD 105
- QUIET 106
- RETRYPERIOD 108
- SCHEDLOGNAME 109
- SCHEDLOGRETENTION 110
- SCHEDMODE 111
- SCROLLLINES 112
- SCROLLPROMPT 113
 - setting in a file 68
- SLOWINCREMENTAL 114
- SUBDIR 115
- SYMBOLICDESTINATION 116
- TAPEPROMPT 117
- TCPBUFFSIZE 118
- TCPCLIENTADDRESS 119
- TCPCLIENTPORT 120
- TCPPORT 121
- TCPSERVERADDRESS 122
- TCPWINDOWSIZE 123
- TIMEFORMAT 124
- TPNAME 125
- TXNBYTELIMIT 126
 - understanding 61
- VERBOSE 127

client options file

- customizing the file 62
- dsm.opt file 61
- dsm.smp file 61
- location 61
- REPLACE 107
- understanding options 61

- client scheduler
 - starting 194
- client scheduler, starting 45
- collision management
 - REPLACE option 107
- command
 - batch mode 139
 - help 156
 - interactive or loop mode 140
- command line options 142
- command name 140
- command parameter
 - optional 141
 - required 141
- command processing
 - summary of options 67
- command rules 144
- command syntax xvii
- COMMETHOD option 77
- communication with server
 - summary of options 62
- COMPRESSALWAYS option 78
- COMPRESSION option 79
- conventional memory 204
- Copy Destination attribute 56
- Copy Frequency attribute 54
- copy groups
 - description of 52
- Copy Mode attribute 56
- Copy Serialization attribute 55
- Copy Type attribute 54
- CPICBUFFERSIZE option 80
- CPICMODENAME option 81
- cross-client restore
 - FSTYPES option 87

D

- date
 - incremental by 10
 - sorting by 22
- DATEFORMAT option 82
- default
 - DSMC command 160
- default domain 16
- default management class 52, 54
- delete
 - archived files 151
 - drives 154
 - file space 33, 154

- DELETE ACCESS command 149
- DELETE ARCHIVE command 151
- DELETE FILESPACE command 154
- deleting
 - access 149
 - archives 38
 - authorizations 28
- description
 - archive 36
 - displaying 165
 - management class 54
- DESCRIPTION option 146, 151, 189
- description, in ARCHIVE command 146
- DETAIL option 177
- diagnosing problems 203
- directory
 - archiving 37
 - backup 19
 - management classes 83
 - sorting by 22
- directory tree
 - restore 26
- DIRMC option 83
- DIRSONLY option 170
- disaster recovery 32
- disk
 - recovery 32
- display
 - archive description 165
 - archive expiration date 165
 - archived files 165
 - backed up files 170
 - file spaces 175
 - inactive backups 23
 - management classes 177
 - messages on screen 127
 - messages, stopping 106
- displaying
 - management class 53, 54
 - online help 7
 - policy information 53
 - scheduled events 179
- domain
 - specifying 84
- DOMAIN option 16, 84
- DOS
 - restore or retrieve to OS/2 31
 - restore or retrieve to Windows 31
- DOS (Disk Operating System)
 - memory, use of 203
- drive
 - deleting 154
- DSM command
 - using options with 6
- DSM commands 5
 - starting 5
- dsm.opt file 61
 - See also* client options file
- dsm.smp file 61
- DSM3270 program 5
- DSM400 program 5
- DSMATM program 5
- DSMC commands
 - ARCHIVE command 146
 - default 160
 - DELETE ACCESS command 149
 - DELETE ARCHIVE command 151
 - DELETE FILESPACE command 154
 - HELP command 156
 - INCREMENTAL command 157
 - LOOP command 160
 - MACRO command 162
 - QUERY ACCESS command 163
 - QUERY ARCHIVE command 165
 - QUERY BACKUP command 170
 - QUERY FILESPACE command 175
 - QUERY MGMTCLASS command 177
 - QUERY SCHEDULE command 179
 - RESTORE command 181
 - RETRIEVE command 189
 - SCHEDULE command 194
 - SELECTIVE command 197
 - SET ACCESS command 200
 - SET PASSWORD command 202
- DSMCPCIC program 5
- DSMFTP program 5
- DSMIBM program 5
- DSMIBM20 program 5
- DSMIPX program 5
- DSMNET program 5
- DSMNSD program 5
- dynamic serialization 55
- dynamic, shared serialization 55

E

- elapsed time 13
- end
 - graphical user interface session 8
 - interactive session 160

- enter destination path to fully restore 27
- enter source path to fully restore 27
- entering commands 140
- environment variable
 - RTVMCONV (conventional memory) 204
 - RTVMEXP (expanded memory) 203
 - RTVMEXPLOW (expanded memory threshold) 203
 - RTVMEXT (extended memory) 204
- error log
 - pruning 85
- error processing
 - summary of options 67
- ERRORLOGRETENTION option 85
- Esc key 7
- EXCLUDE option 86
 - processing 72
 - recommended exclude list 70
 - reference 69
 - wildcard characters 72
- expanded memory 203
- extended memory 204

F

- F10 key 7
- F3 key 7
- failures
 - backup 13
- file
 - archive
 - deleting 38
 - directory tree 37
 - file specification 35
 - archive size 165
 - backing up open 17
 - changed 16
 - display archives 165
 - display backed up 170
 - giving access to 200
 - restoring
 - another node's 30
 - to another workstation 30
 - retrieve 41
 - retrieving
 - another node's 30
 - to another workstation 30
- file name
 - sorting by 22
- file space
 - delete 33

- file space (*continued*)
 - deleting 154
 - displaying 175
 - names 15
- file specification
 - backup 18
 - restore 24
 - wildcard characters 22
- file system types 87
- files
 - backed up 13
 - examined 12
 - exclusion list, recommended 70
 - how managed 17
 - marked inactive 13
 - sorting 22
- FROMNODE option 175, 181, 189
 - restoring or retrieving files 30
- FSTYPES option 87
- full incremental
 - overview 10
- fuzzy backup 56

G

- give
 - access to files in storage 200
- grace periods 54
- graphical user interface
 - displaying online help 7
 - ending a session 8
 - starting a session 5
 - using the keyboard 6

H

- help
 - online 156
- HELP command 156

I

- ibmbio.com 70
- ibmdos.com 70
- inactive file
 - displaying 170
- INACTIVE option 170, 181
- inactive version 23
- INCLUDE option
 - defined 88

- INCLUDE option (*continued*)
 - processing 72
 - reference 69
 - specifying management class 74
 - wildcard characters 72
- include-exclude list
 - backup, used during 14
 - recommended minimum 70
- incremental
 - by date 10
 - full 11
 - performance 10
 - types of 10
- incremental backup
 - process 16
- INCREMENTAL command 14, 157
- interactive mode 140
- interactive session
 - ending 160
 - rules for using 160
 - starting 160
 - using options 160
- io.sys 70
- IPXBUFFERSIZE option 90
- IPXSERVERADDRESS option 91
- IPXSOCKET option 92

K

- keyboard, using 6

L

- label, drive 15
- LANADAPTER option 93
- LANGUAGE option 94
- LATEST option 181
- log
 - pruning error 85
 - pruning schedule 110
- LOOP command 160
- loop mode 140

M

- MACRO command 162
- management class
 - ARCHMC option 146
 - backup 17
 - binding to files 59

- management class (*continued*)
 - choosing for directories 59
 - choosing for files 57
 - default 52, 54
 - directory, specify for 83
 - displaying 53, 54, 177
 - name 54
 - overriding default 74
 - overriding on ARCHIVE command 146
 - rebinding files to 59
 - specifying with INCLUDE option 74
- MAXCMDRETRIES option 95
- memory problems
 - Client Access/400, BASE option 205
 - Client Access/400, EXTENDED option 205
 - conventional memory 204
 - expanded memory 203
 - extended memory 204
 - NS/DOS (Networking Services/DOS) 204
 - PC Support/400, BASE option 205
 - PC Support/400, EXTENDED option 205
- memory, computer 203
- message
 - displaying on screen 127
 - stop displaying 106
- messages, clearing 7
- modification date
 - sorting by 22
- modified mode 56
- msdos.sys 70

N

- name
 - command 140
 - copy groups 54
 - management class 54
- NETBIOSBUFFERSIZE option 96
- NETBIOSNAME option 97
- NETBIOSSERVERNAME option 98
- NETBIOSTIMEOUT option 99
- new files, backing up 10
- NODENAME option 30
 - defined 100
- NOPROMPT option 151
- NS/DOS (Networking Services/DOS)
 - memory problems 204
- NUMBERFORMAT option 101

O

- online
 - help, command 156
- online help
 - displaying 7
- open file, backing up 17
- option
 - using in interactive session 160
- optional parameter 141
- options
 - ARCHMC 146
 - DESCRIPTION 146, 151, 189
 - DETAIL 177
 - DIRONLY 170
 - DOMAIN 84
 - EXCLUDE
 - groups of files 71
 - processing 72
 - reference 69
 - wildcard characters 72
 - FROMNODE 175, 181, 189
 - INACTIVE 170, 181
 - INCLUDE
 - groups of files 71
 - management class, specifying 74
 - processing 72
 - reference 69
 - wildcard characters 72
 - LATEST 181
 - NOPROMPT 151
 - PASSWORD 160
 - PICK 151, 181, 189
 - REPLACE 107
 - wildcard characters 72
- Options window
 - archive 36
- OS/2
 - restore or retrieve to DOS 31
 - restore or retrieve to Windows 31
- out-of-memory condition 204

P

- parameter
 - required 141
- parameter, optional 141
- partial incremental
 - overview 10
- PARTNERLUNAME option 102

- password
 - changing 8
 - changing ADSM 202
 - using 5
- PASSWORD option 160
- pattern-matching expressions 143
- PC Support/400
 - communication buffer, size of 135, 137
 - memory problems, BASE option 205
 - memory problems, EXTENDED option 205
- performance
 - incremental backup 10
 - transaction options 67
 - transaction processing 126
- permissions
 - deleting 149
- PICK option 151, 181, 189
- policy
 - displaying 53
- policy domain 51, 53
- policy set 51, 53
- port address
 - specifying 121
- POSTSCHEDULECMD option 103
- PRESCCHEDULECMD option 104
- problems, diagnosing 203
- processing options
 - description of 3
- processing transactions 126
- prompt
 - restore destination 25
- pruning
 - error log 85
 - schedule log 110
- publication translations xiii
- publications
 - order numbers xii
 - softcopy xii

Q

- query
 - access 163
- QUERY ACCESS command 163
- QUERY ARCHIVE command 165
- QUERY BACKUP command 170
- QUERY FILESPACE command 175
- QUERY MGMTCLASS command 177
- QUERY SCHEDULE command 179

QUERYSCHEDPERIOD option 105
QUIET option 106

R

reading syntax diagrams xvii
rebinding files to different management class 59
recover
 disk 32
registering client 6
REPLACE option 107
required parameter 141
restore
 active version 23
 advanced considerations 27
 by command 27
 cross-client 87
 destination 25
 directory tree 26
 file specification 24
 files 181
 from other types of workstation 31
 inactive version 23
 overview 23
 parameters 24
 status 26
 subdirectory path 26
 subdirectory path window 27
 to following location 25
 to original location 25
RESTORE command 181
 overview 27
restoring
 another node's files 30
 authorizing another user 28
 workstation, to another 30
Retain Extra Versions attribute 55
Retain Only Version attribute 55
Retain Versions attribute 56
retention grace period 60
retrieve
 advanced 42
 basic 41
 by command 42
 files 189
 from other types of workstation 31
RETRIEVE command 189
 overview 42
retrieving
 another node's files 30

retrieving (*continued*)
 authorizing another user 28
 workstation, to another 30
retry
 backup 76
RETRYPERIOD option 108
RTVMCONV environment variable 204
RTVMEXP environment variable 203
RTVMEXPLOW environment variable 203
RTVMEXT environment variable 204

S

SCHEDLOGNAME option 109
SCHEDLOGRETENTION option 110
SCHEDMODE option 111
schedule
 displaying 179
 starting 194
SCHEDULE command 194
schedule log
 pruning 110
scheduled services
 displaying 46
 running 45
 setting up 45
SCROLLLINES option 112
SCROLLPROMPT option 113
selective backup
 directory, by 19
 file specification, by 18
 overview 18
 process 23
SELECTIVE command 197
 overview 21
serialization
 description of 55
session, starting 5
set
 file access 200
SET ACCESS command 200
 restore-retrieve authorization 28
SET PASSWORD command 202
setting
 conventional memory use 204
 expanded memory use 203
 extended memory use 204
SHARE command, DOS 206
shared dynamic serialization 55

- shared static serialization 55
- sharing problems, diagnosing 206
- show menu 23
- SLOWINCREMENTAL option 114
- softcopy publications
 - order numbers xii
- sorting lists 22
- space bar 7
- specify
 - node name 100
 - port address 121
 - TCP/IP server address 122
 - TCP/IP window size 123
- start
 - ADSM GUI session 5
 - interactive session 160
 - schedule, central 194
- static serialization 55
- static, shared serialization 55
- status
 - backup 12
- stop displaying messages 106
- storage
 - display archives 165
 - displaying files in 170
 - giving access to files in 200
- storage management policies 3, 51
- SUBDIR option 115
- subdirectory path
 - restore 26
- SYMBOLICDESTINATION option 116
- syntax diagrams xvii

T

- Tab key 7
- TAPEPROMPT option 117
- TCP/IP server address
 - specifying 122
- TCP/IP window size
 - specifying 123
- TCPBUFFSIZE option 118
- TCPCLIENTADDRESS option 119
- TCPCLIENTPORT option 120
- TCPPORT option 121
- TCPSERVERADDRESS option 122
- TCPWINDOWSIZE option 123
- TIMEFORMAT option 124
- TPNAME option 125

- trademarks ix
- transaction 13
 - options 67
- transaction processing 126
- transfer rate 13
- translations, publication xiii
- TXNBYTELIMIT option 126

U

- using the graphical user interface
 - ending a session 8

V

- VERBOSE option 127
- Versions Data Deleted attribute 55
- Versions Data Exists attribute 54

W

- wildcard characters 22, 143
 - examples of using 72
- Windows
 - restore or retrieve to DOS 31
 - restore or retrieve to OS/2 31

Communicating Your Comments to IBM

ADSTAR Distributed Storage Manager
Using the DOS
Backup-Archive Client
Version 2

Publication No. SH26-4054-00

If you especially like or dislike anything about this book, please use one of the methods listed below to send your comments to IBM. Whichever method you choose, make sure you send your name, address, and telephone number if you would like a reply.

Feel free to comment on specific errors or omissions, accuracy, organization, subject matter, or completeness of this book. However, the comments you send should pertain to only the information in this manual and the way in which the information is presented. To request additional publications, or to ask questions or make comments about the functions of IBM products or systems, you should talk to your IBM representative or to your IBM authorized remarketer.

When you send comments to IBM, you grant IBM a nonexclusive right to use or distribute your comments in any way it believes appropriate without incurring any obligation to you.

If you are mailing a readers' comment form (RCF) from a country other than the United States, you can give the RCF to the local IBM branch office or IBM representative for postage-paid mailing.

- If you prefer to send comments by mail, use the RCF at the back of this book.
- If you prefer to send comments by FAX, use this number:
 - United States: 1-800-426-6209
 - Other countries: (+1)+408+256-7896
- If you prefer to send comments electronically, use this network ID:
 - IBMLink from U.S. and IBM Network: STARPUBS at SJEVM5
 - IBMLink from Canada: STARPUBS at TORIBM
 - IBM Mail Exchange: USIB3VVD at IBMMAIL
 - Internet: starpubs@vnet.ibm.com

Make sure to include the following in your note:

- Title and publication number of this book
- Page number or topic to which your comment applies.

Readers' Comments — We'd Like to Hear from You

**ADSTAR Distributed Storage Manager
Using the DOS
Backup-Archive Client
Version 2**

Publication No. SH26-4054-00

Overall, how satisfied are you with the information in this book?

	Very Satisfied	Satisfied	Neutral	Dissatisfied	Very Dissatisfied
Overall satisfaction	<input type="checkbox"/>	<input type="checkbox"/>	<input type="checkbox"/>	<input type="checkbox"/>	<input type="checkbox"/>

How satisfied are you that the information in this book is:

	Very Satisfied	Satisfied	Neutral	Dissatisfied	Very Dissatisfied
Accurate	<input type="checkbox"/>	<input type="checkbox"/>	<input type="checkbox"/>	<input type="checkbox"/>	<input type="checkbox"/>
Complete	<input type="checkbox"/>	<input type="checkbox"/>	<input type="checkbox"/>	<input type="checkbox"/>	<input type="checkbox"/>
Easy to find	<input type="checkbox"/>	<input type="checkbox"/>	<input type="checkbox"/>	<input type="checkbox"/>	<input type="checkbox"/>
Easy to understand	<input type="checkbox"/>	<input type="checkbox"/>	<input type="checkbox"/>	<input type="checkbox"/>	<input type="checkbox"/>
Well organized	<input type="checkbox"/>	<input type="checkbox"/>	<input type="checkbox"/>	<input type="checkbox"/>	<input type="checkbox"/>
Applicable to your tasks	<input type="checkbox"/>	<input type="checkbox"/>	<input type="checkbox"/>	<input type="checkbox"/>	<input type="checkbox"/>

Please tell us how we can improve this book:

Thank you for your responses. May we contact you? Yes No

When you send comments to IBM, you grant IBM a nonexclusive right to use or distribute your comments in any way it believes appropriate without incurring any obligation to you.

Name

Address

Company or Organization

Phone No.

Readers' Comments — We'd Like to Hear from You
SH26-4054-00



Cut or Fold
Along Line

Fold and Tape

Please do not staple

Fold and Tape



NO POSTAGE
NECESSARY
IF MAILED IN THE
UNITED STATES

BUSINESS REPLY MAIL

FIRST-CLASS MAIL PERMIT NO. 40 ARMONK, NEW YORK

POSTAGE WILL BE PAID BY ADDRESSEE

International Business Machines Corporation
RCF Processing Department
G26/050
5600 Cottle Road
SAN JOSE, CA 95193-0001

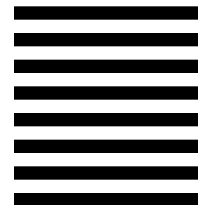

Fold and Tape

Please do not staple

Fold and Tape

SH26-4054-00

Cut or Fold
Along Line



Program Number: 5648-020
5622-112
5697-078
5763-SV1
5733-197
5686-073
5655-119
28H2250
28H2180
89G1342



Printed in the United States of America
on recycled paper containing 10%
recovered post-consumer fiber.

SH26-4054-00

