

የቢሮ እቃዎችና መሳሪያዎች

**OFFICE SUPPLIES
AND EQUIPMENT**

የዕህፈት መሳሪያዎች
stationery

የደብዳቤ ሚዛን
letter scales

የሂሳብ ወረቀት ግስቀመጫ
bill-file

ግጥበቲያ አቀባይ
tape dispenser

የወረቀት መስፈያ
stapler

መለያ ምልክት አዘጋጅ
label maker

ግጥሚያ ባለቃት
glue stick

ግሽጊያ ጥብጣብ
tape

ግረግያ ፈሳሽ
correction fluid

የወረቀት ሽቦ መንቀጥ
staple remover

የወረቀት ሽቦ
staples

ግረግያ ወረቀት
correction paper

አግራፍ
paper clips

ላሊስ
eraser

ወረቀት ግያያዥ
paper fasteners

ደብዳቤ መክፈኛ
letter opener

መቆጣጠሪ
clip

የፅሁፈት መሳሪያዎች
stationery

መፅኅፍ መደገፊያ
book end

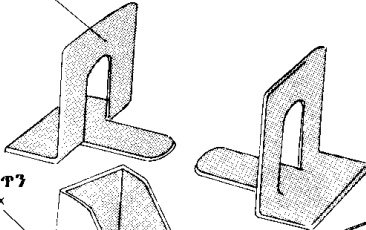

የፋይል ሳፕን
filing box

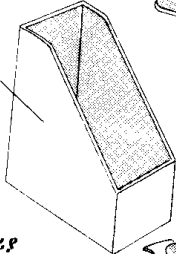

የጠረጴዛ ወረቀት ግስቀመጫ
desk tray

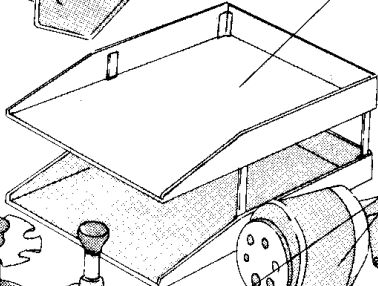

መቅረጫዎች
pencil sharpeners

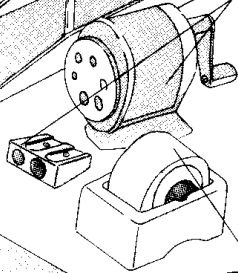

ግሀተኛ መደርደሪያ
stamp rack

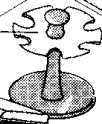

መርገጫ
stamp pad

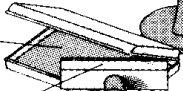

ግሀተኛ
rubber stamp



ቁጥር መሰጫ
numbering machine

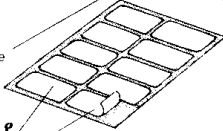

ባለግጣብቂያ መለያ
ፎልደቶች
self-adhesive labels



ቀን ግተግያ
dater



ግርጠሊያ
moistener

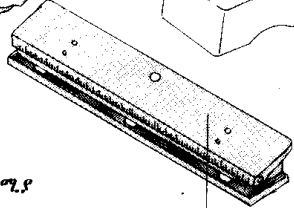

ወረቀት መብኻ
paper punch



የቢሮ እቃዎችና መሳሪያዎች

**OFFICE SUPPLIES
AND EQUIPMENT**

የፅሁፈት መሳሪያዎች
stationery

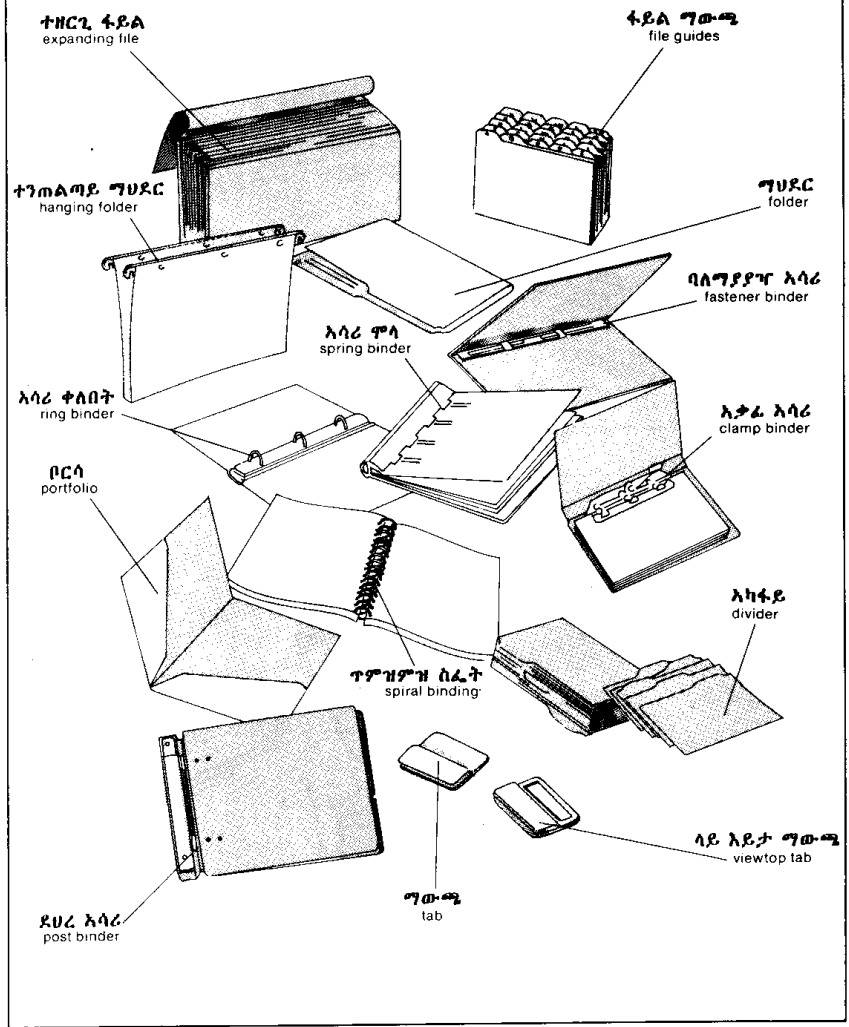

የዕህረት መሳሪያዎች
stationery

ተሽከርካሪ ፋይል
rotary file

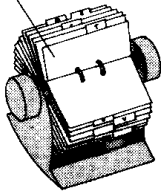

የስልክ ግውጫ
telephone index

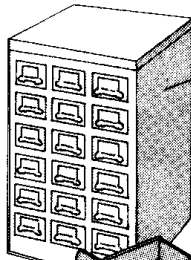
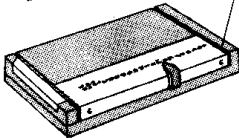

የክርድ ቁምሳየን
card cabinet

መሳቢያ
drawer

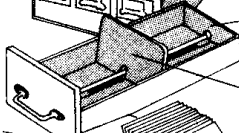

አግቲ
compressor

ክርዶች
cards

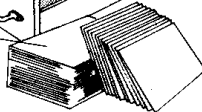

ባለመቆንጠራ ሰሌዳ
clipboard

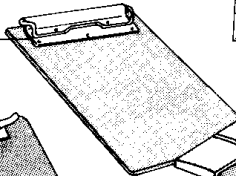

ሱመን
desk pad

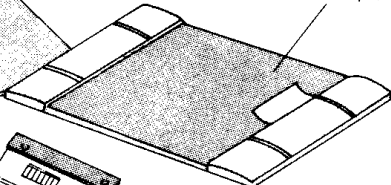

ባለቅስት ሰሌዳ
archboard

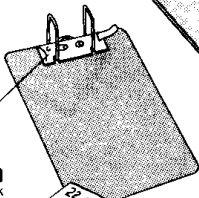

የተጠሮ መዝገብ
appointment book



ተቀዳጅ የቀን መቆጠሪያ
tear-off calendar

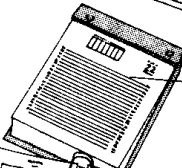

ግርቀቲያ ጥራዝ
scratch pad

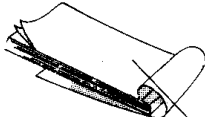

የሂሳብ መዝገብ
account book

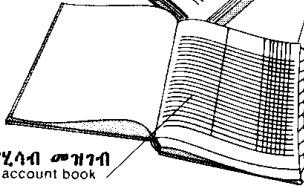

የቀን መቆጠሪያ ጥራዝ
calendar pad

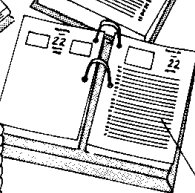

—የቢሮ ቁሳቁስ—
office furniture

ተሽከርካሪ ተለጣጭ ወንበር
swivel-tilter armchair

የጉን ጠረጴዛ
credenza

ቋጧ ኮት መስተያ
coat tree

የሰራ አስኪያጅ ጠረጴዛ
executive desk

ድርድር መስተያ
coat rack

መክፈያ
partition

የፀሃፊ ጠረጴዛ
secretarial desk

መመለሻ
ጠረጴዛ
return

የኮት መስተያ
coat hook

ግሳያ ቁምሳተን
display cabinet

ቁምሳተኒት
locker

የፀሃፊ ወንበር
secretarial chair

የፀሀፊት መሳሪያ ቁምሳተን
stationery cabinet

ጉንፍላ ቁምሳተን
lateral filing cabinet

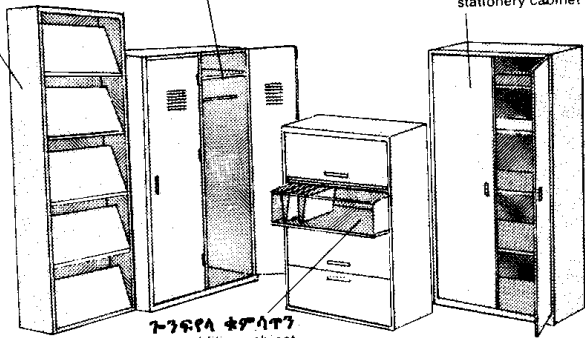
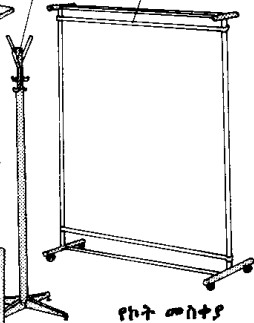
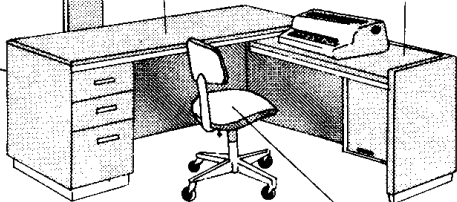
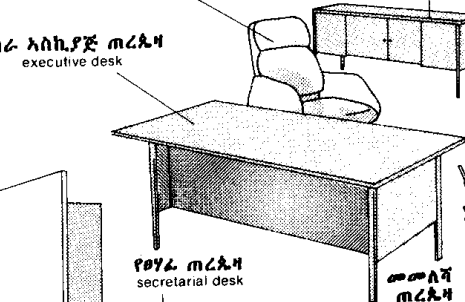
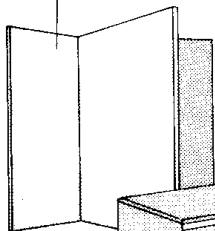

የዕህረት መኪና
typewriter

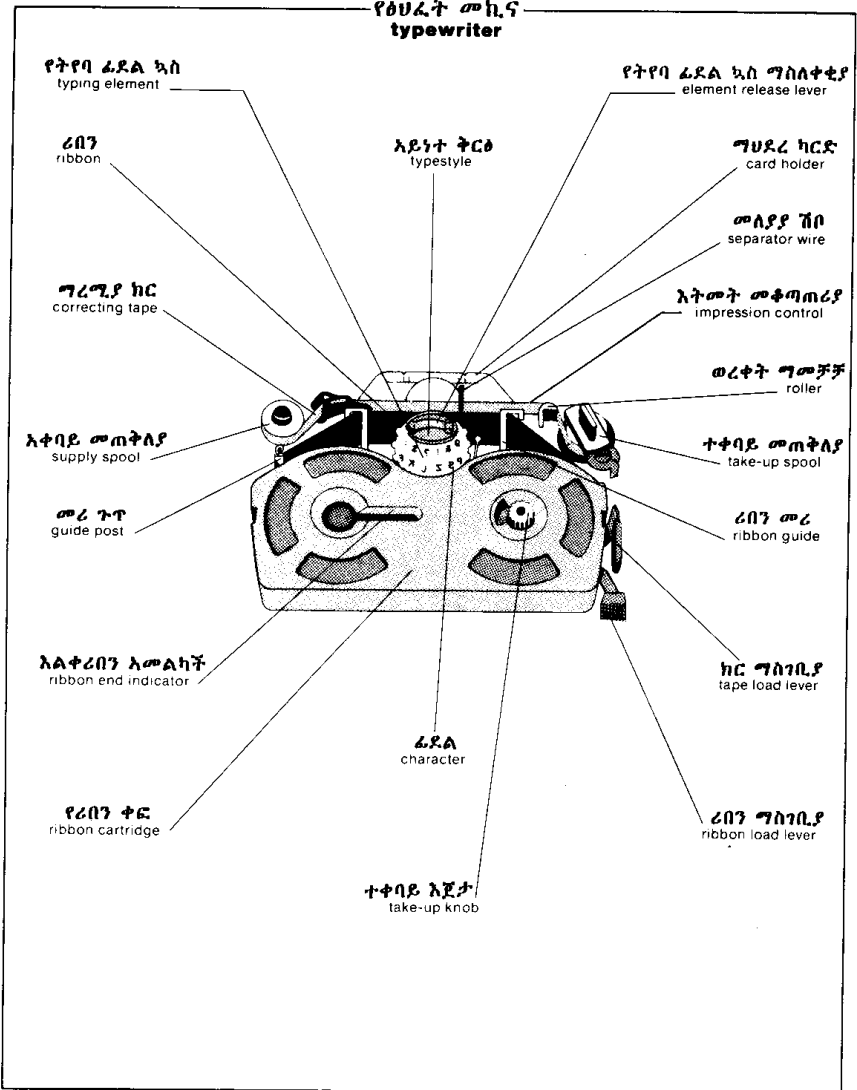

የትየባ ፊደል ኳስ
typing element

የትየባ ፊደል ኳስ ማስለቀቂያ
element release lever

ሪቦን
ribbon

አይነት ትርፅ
typestyle

ግህደረ ካርድ
card holder

ግረግያ ክር
correcting tape

መለያያ ሽቦ
separator wire

እትመት መቆጣጠሪያ
impression control

አቀባይ መጠቅለያ
supply spool

ወረቀት ግመቻቻ
roller

መሪ ጉጥ
guide post

ተቀባይ መጠቅለያ
take-up spool

አልቀሪቦን አመልካች
ribbon end indicator

ሪቦን መሪ
ribbon guide

ፊደል
character

ክር ማስገቢያ
tape load lever

የሪቦን ቀር
ribbon cartridge

ሪቦን ማስገቢያ
ribbon load lever

ተቀባይ እጀታ
take-up knob

የፅሁፈት መኪና
typewriter

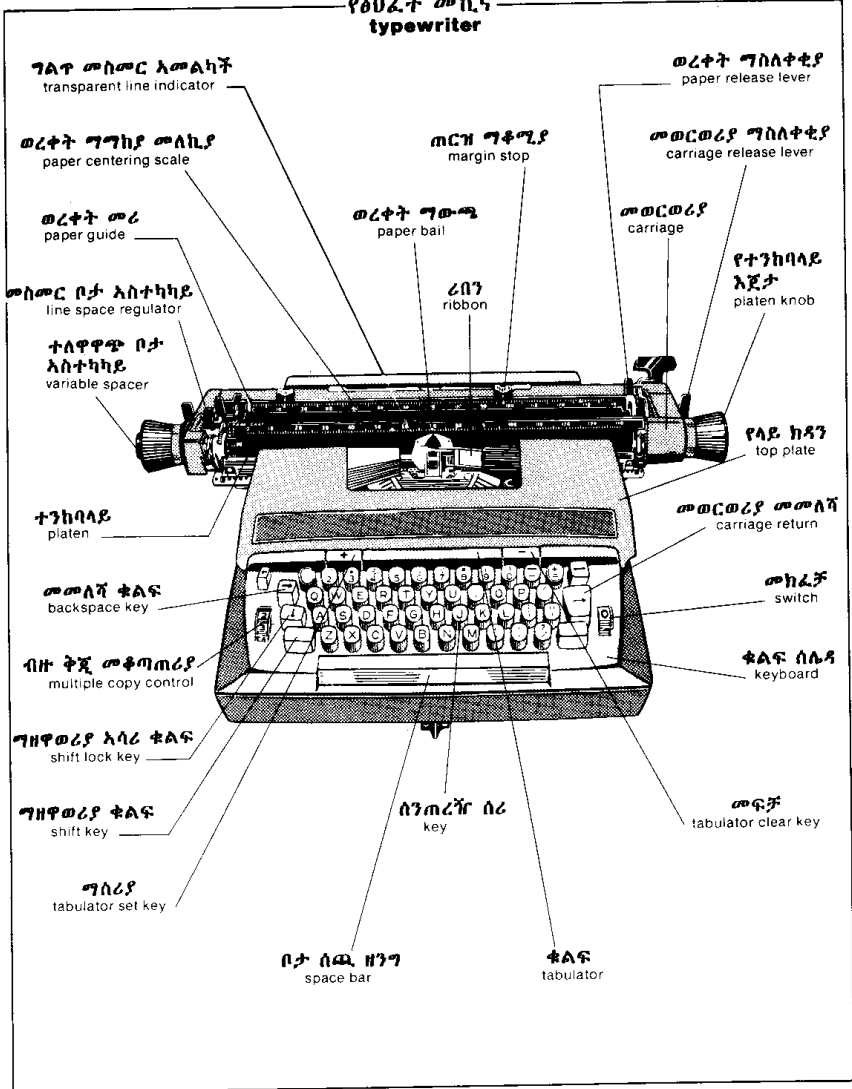

**የንድ ስርአት ውስጠ ተግባር
functions in a system**

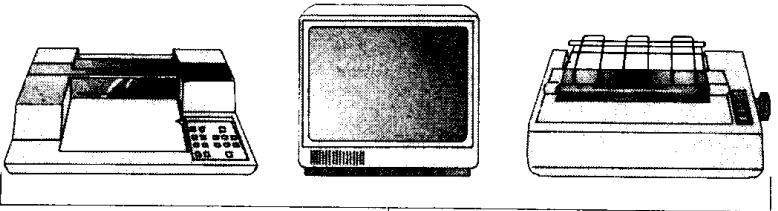

**የውጤት መሳሪያዎች
output devices**

**የመገናኛ መሳሪያ
communication device**

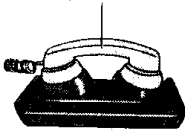

**መረጃ ግሳያ
data display**



**ግለከላዊ ከወና ላሃድ
central processing unit**

**መረጃ ቅንብራ
data processing
Rom* memory
አብላ አስታውሴ**

**መረጃ ቅንብራ ዘዴ
data processing devices**

**የግብአት መሳሪያዎች
input devices**

**ልዩ መረጃ ቅንብራ ፐሮግራም
specific data processing program**
**መረጃ ዘገባ በራም አስታዋሽ
data recording on Ram* memory**
**መረጃ ግጠራተጊያ
data storage**

**መረጃ ግኝታ
data acquisition**

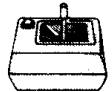
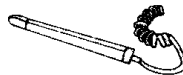
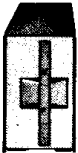
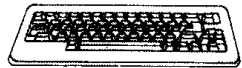

**ቀጥተኛ ግኝት አስታውሴ (ቀግላ)
* RAM Random Access Memory**

**አንብብ ብቻ አስታውሴ (አብላ)
* ROM Read Only Memory**

የአንድ ስርአት ቅንብሮች
configuration of a system

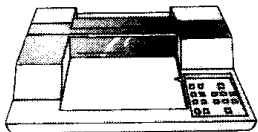

መጠላሰጫ
plotter

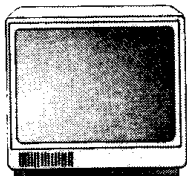

መሳያ
display

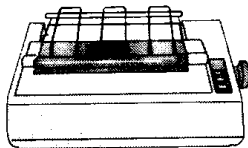

አታሚ
printer



ድምፅ ግብፅጃ
acoustic coupler



ግለካላዊ ክወና አሃድ
central processing unit



ንኡስ ከዋኝ
microprocessor



ዲስኬት
diskette



ዲስኬት ግሰገቢያ
diskette drive



ቱልና ሰሌዳ
keyboard

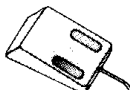

አይጠ
mouse

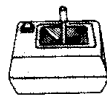

መጫወቻ ዘንግ
joystick



ካሴት
cassette



መቅረፅ ካሴት
cassette recorder



ብላኒ ብርሃን
light pen

ቁልፍ ሰሌዳ
keyboard

ፊደል-አሃዝ ቁልፍ ሰሌዳ
alphanumeric keyboard

አሃዳዊ ቁልፍ ሰሌዳ
numeric keypad

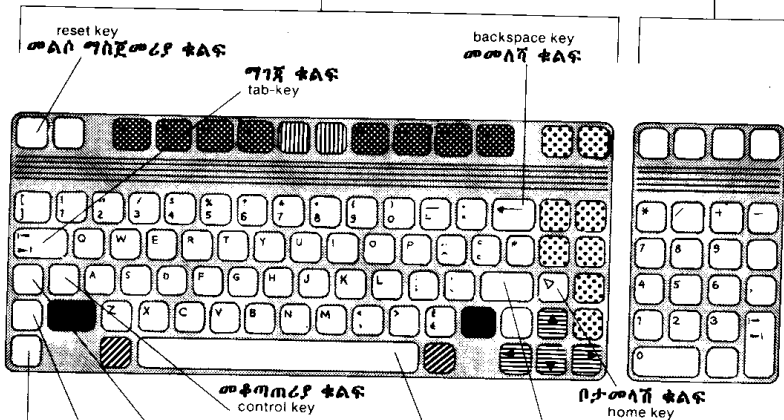

ግንዋዕሪያ አሳሪ ቁልፍ
shift lock key

መላሽ ቁልፍ
return key

ግጥሎች ቁልፍ
escape key

ቦታ ሰጪ ዘንግ
space bar

ግስገሲያ ቁልፍ
enter key

ቃል ከዋሻ ቁልፍ
word processing key

ግንዋዕሪያ ቁልፍ
shift key

ቦታ አደላጃይ ቁልፍ
cursor movement key

ላስልስ ቁልፍ
soft key
function key ገቢር ቁልፍ

ተስፋሪ ፊደል
extended character

ቅንብሮሽ ቁልፍ
configuration key

ድጋፍ ሰጪ መሳሪያ
peripheral equipment

ነጠብጣብ ድርድር አታሚ
dot matrix printer

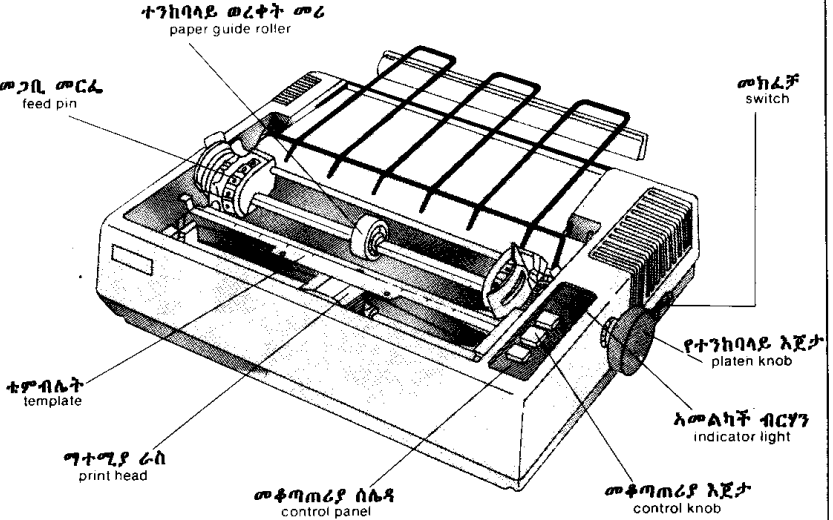

ድምፅ ማቀናጃ
acoustic coupler

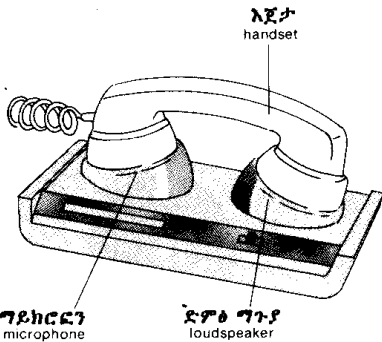

መደሰቻ ዘንግ
joystick

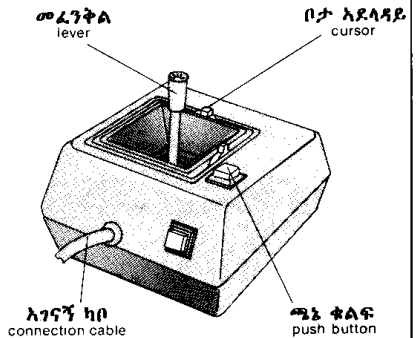

የኮምፒዩተር ክፍል
computer room

መግጠላዊ ክር ተቆጣጣሪ
magnetic tape controller

ክብቃ መቆጣጠሪያ ላሃድ
disk control unit

መግጠላዊ ክር ግሰገቢያ
magnetic tape drive

መቆጣጠሪያ ኮንሶል
control console

ክብቃ ግክግቻ
disk storage

መግጠላዊ ክር ግክግቻ
magnetic tape storage

ግለክላዊ ክወና ላሃድ
central processing unit

ክብቃ ግሰገቢያ
disk drive

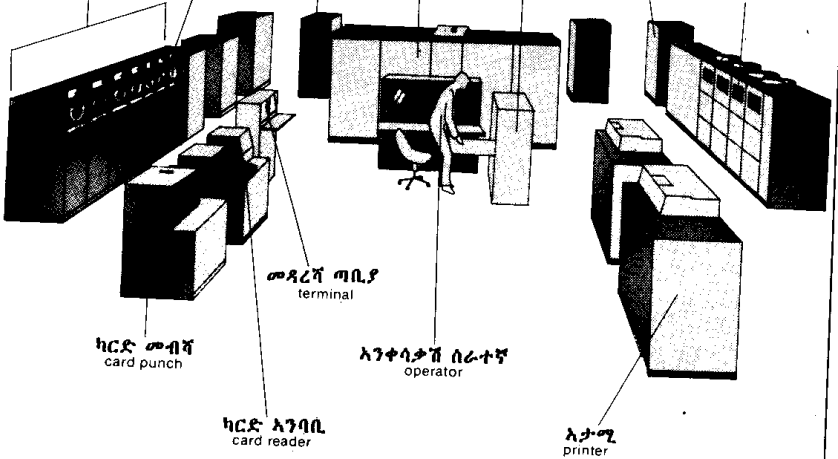

መዳሪሻ ጣቢያ
terminal

ካርድ መብሻ
card punch

አንቀሳቃሽ ሰራተኛ
operator

ካርድ አንባቢ
card reader

አታጫ
printer

ብስሰት ካርድ
punch card

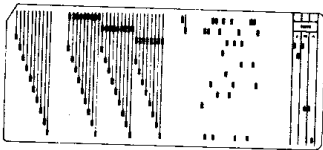

ዲስክ
disk

ክፍል ክብ
sector

ፈለግ
track

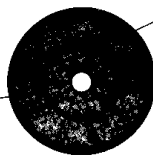

ਸੁ.ਲ.ਫ

MUSIC

የሙዚቃ ናታ
musical notation

የሙዚቃ መግፈያ
staff

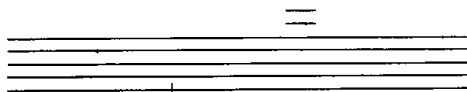

መስመር
line

ክፍት ቦታ
space

ረዳት መስመር
ledger line

ቁልፍ
clef

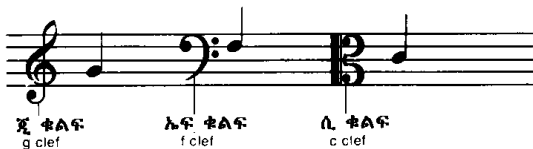

ጂ ቁልፍ
g clef

ኤፍ ቁልፍ
f clef

ሲ ቁልፍ
c clef

እስኪል
scale



ሲ

ዲ

ኤ

ኤፍ

ጂ

ኤ

ቢ

ሲ

የናታ ምልክቶች
note symbols



ግግሽ ናታ
half note

እንደ በምንተኛ ናታ
eighth note

እንደ በላላ ሁለተኛ ናታ
thirty-second note

ሙሉ ናታ
whole note

ፋብ ናታ
quarter note

እንደ አስራ በድስተኛ ናታ
sixteenth note

እንደ በድሳ አራተኛ ናታ
sixty-fourth note

rest symbols

የአረፍት ምልክቶች

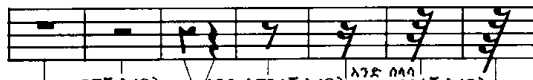

ግግሽ አረፍት
half rest

እንደ በምንተኛ አረፍት
eighth rest

እንደ በላላ ሁለተኛ አረፍት
thirty-second rest

ሙሉ አረፍት
whole rest

እፋብ አረፍት
quarter rest

እንደ አስራ በድስተኛ አረፍት
sixteenth rest

እንደ በድሳ አራተኛ አረፍት
sixty-fourth rest

የሙዚቃ ኖታ
musical notation

ጊዜ አመልካች
time signatures

ሁለት በሁለት
two-two time

ሶስት በአራት
three-four time

አራት በአራት
four-four time

የሙዚቃ ማጠቃለያ
bar line

የድጋፍ ምልክት
repeat mark

ድንገተኛ
accidentals

ከፍታ
sharp

ጭርቶ
flat

ጥንድ ከፍታ
double sharp

ጥንድ ጭርቶ
double flat

ቁልፍ አመልካች
key signature

intervals

የርቀት ስፊቶች

ተመሳሳይ
unison

ሁለተኛ
second

ሶስተኛ
third

አራተኛ
fourth

አምስተኛ
fifth

ሥስተኛ
sixth

ሰባተኛ
seventh

አስተኛ
octave

ጥንቃቄ

ornaments

ጥንቃቄ
appoggiatura

ChCh
trill

ተመሳሳይ ChCh
turn

ተፈራጭ ChCh
mordent

ህብረ ድምፅ
chord

ሌሎች ምልክቶች
other signs

ጥያቄ
tie

የድጋፍ ምልክት
accent mark

ላርፕ
arpeggio

ጥቃቃ
pause

ያውታር መሳሪያዎች
stringed instruments

የቫዮሊን ገርያ
violin family

ቫዮሊን
violin



ቪዮላ
viola

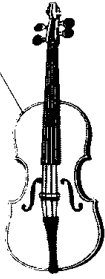

ቫዮሊን ጅሎ
violoncello



ደብላ ባስ
double bass

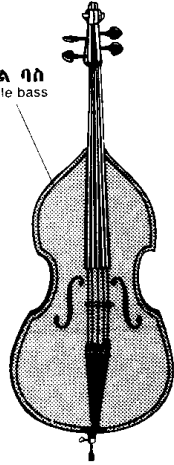

ቫዮሊን
violin

የትኝት ሳጥን
peg box

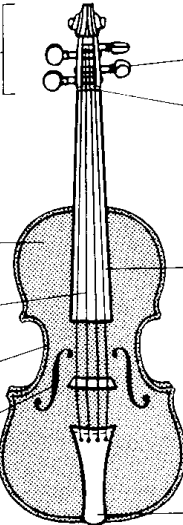

መቃኛ
peg

ለጣፋ ብርኩግ
nut

የጣት ግሳረፊያ
fingerboard

ብርኩግ
bridge

ክፈፍ
purfling

የግርጌ ግእሰረ እውታር
tailpiece

ጥምዝ ራስ
scroll

እንገት
neck

ጎድን
rib

ጀርባ
back

ግርጌ ግሰሪያ
end button

ግንቢያ ሳጥን
sound-board

እውታር
string

ወገብ
waist

የድግፅ መውጫ
sound-hole

ያውታር መሳሪያዎች
stringed instruments

ቫዮሊን
violin

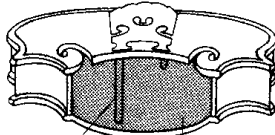

አምድ-ድምፅ
sound-post

የድምፅ ሳጥን
sound box

መምኛ
bow

ራስ
head

ዘንግ
stick

ሽፋና እጅታ
heel

ጫፍ
point

ጥራ
hair

የጥራ ግሰሪያ
frog

ቅርንፉድ
screw

ሀርፕ
harp

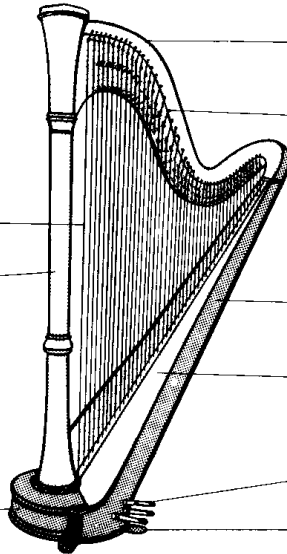

አንገት
neck

መቃኛ
peg

እውታር
string

አምድ
pillar

የድምፅ ሳጥን
sound box

ግንቢያ ሳጥን
sound-board

መርገጫ
pedal

የሀርፕ መቆጣሪያ
pedestal

እገር
feet

ቦርደ ቁልፍ መሳሪያዎች
keyboard instruments

ቁም ፒያኖ
upright piano

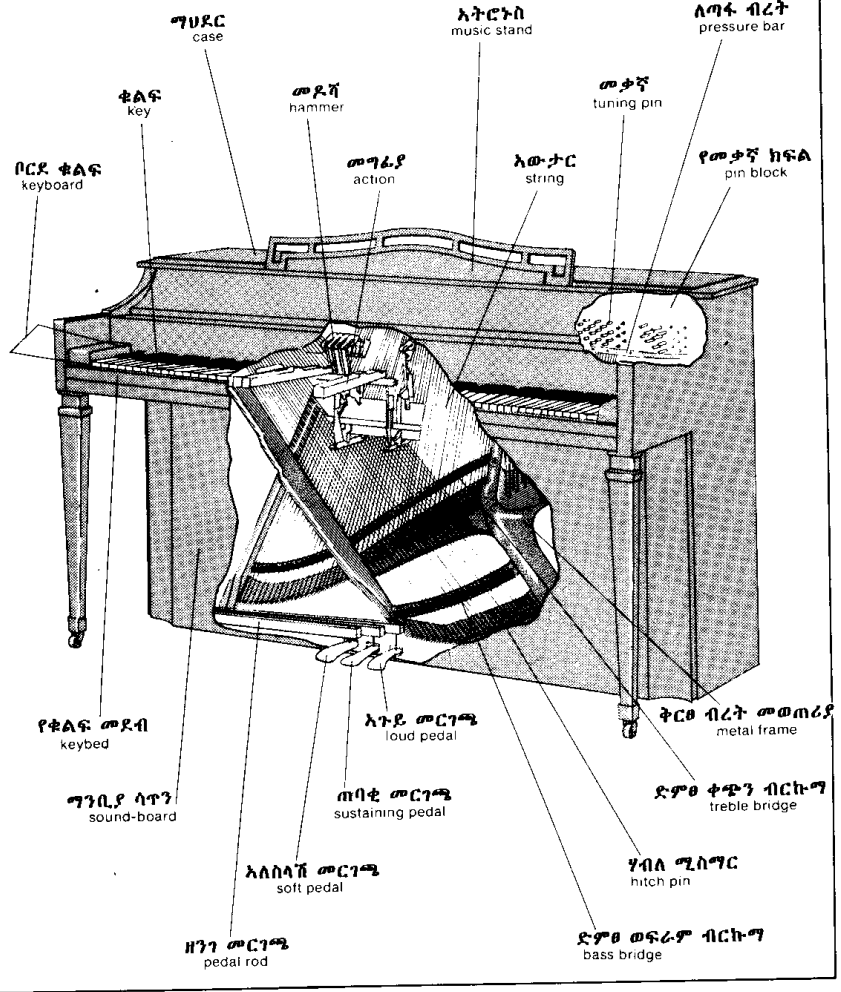

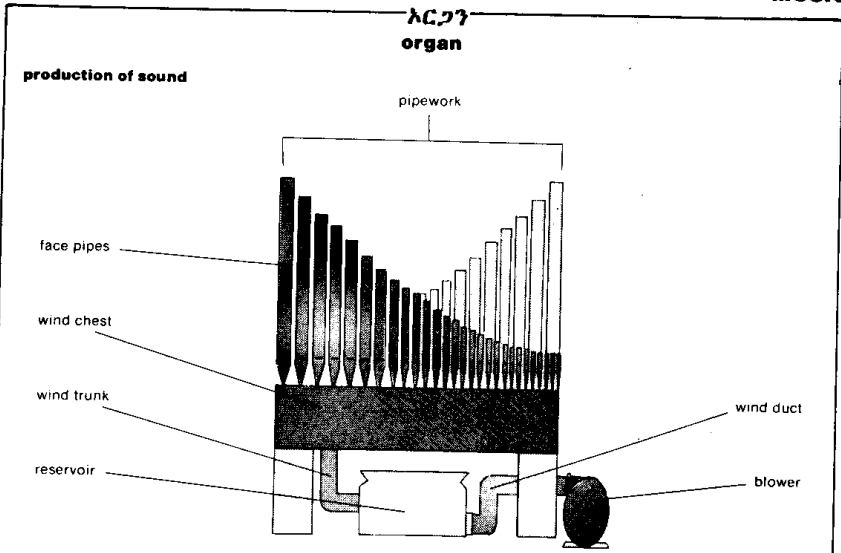

ክፍል አርጋን
console

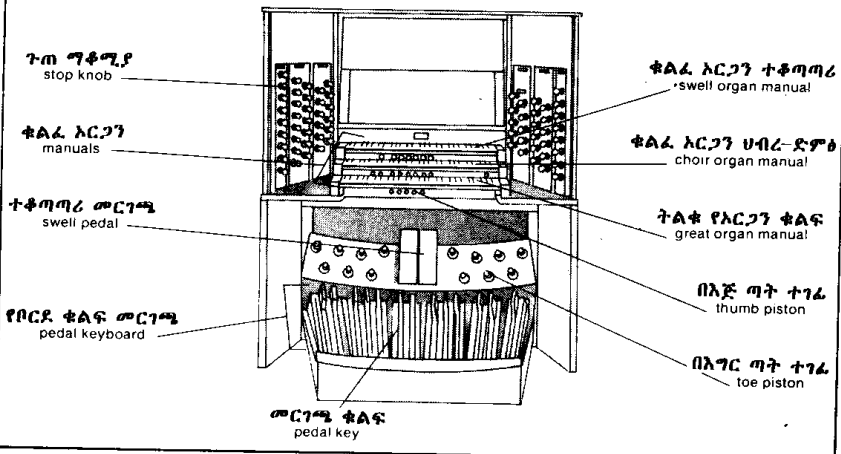

የትንፋሽ መሳሪያዎች
wind instruments

በትንፋሽ የሚሰሩ የእንጨት
መሳሪያዎች
woodwind family



ፍሉት
flute



ፒቦሎ
piccolo



አቦ
oboe



ሆርን
English horn



ክላሪኔት
clarinet

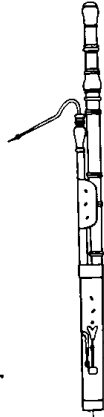

ባዙን
bassoon



ሳክሶፎን
saxophone

ሳክሶፎን
saxophone

በከንፈር ተያዥ
mouthpiece

ግሰሪያ
ligature

የአክታሽ መሜወቻ
octave mechanism

ቅርፅ ደጋጎ
crook

አካል
body

መደገፊያ (በአውራ ጣት)
thumb hook

ቁልፍ
key

የጣት ቁልፍ
key finger button

ግንቢያ
bell

የግንቢያ ግቀፊያ
bell brace

ሪድስ
reeds

ጥንድ ሪድስ
double reed

ነጣላ ሪድስ
single reed

የትንተና መሳሪያዎች

wind instruments

የንጎስ መሳሪያዎች ዝርያ
brass family



ቢዮግል
bugle



ኮርኔት
cornet

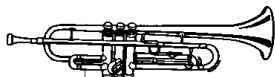

ትራምፕት
trumpet

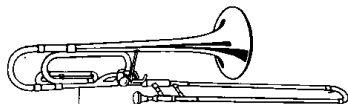

ትሮምቦን
trombone

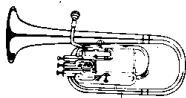

ሳክስ ሆርን
saxhorn

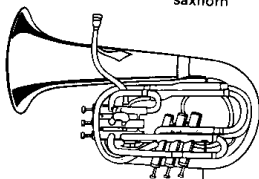

ቲባ
tuba



ሆርን
French horn

ትራምፕት
trumpet

በከንፈር ተያዥ
mouthpiece

መደገፊያ
thumb hook

የጣት ቁልፍ
finger button

የቃቃ መያዣ
valve casing

መደገፊያ(በትንሿ ጣት)
little finger hook

ግንቢያ
bell

በከንፈር ተያዥ ግንባቢያ
mouthpiece receiver

ክፍተ ዘንግ
mouthpipe

የ1ኛ ቃቃ ግመላለሻ
1st valve slide

የ2ኛ ቃቃ ግመላለሻ
2nd valve slide

ቃቃ
valve

የቀለበት ጣት ግንባቢያ
ring

ሶስተኛ ቃቃ ግመላለሻ
3rd valve slide

የድምፅ ግስተካኪያ
tuning slide

ምራት ግውጫያ
water key

የድምፅ ግፊኛ
mute

የምት መሳሪያዎች
percussion instruments

ትሪያንግል
triangle

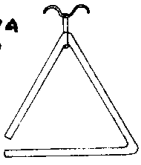

ካስታኔት
castanets

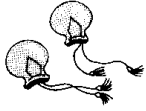

ከብ ደወል
gong

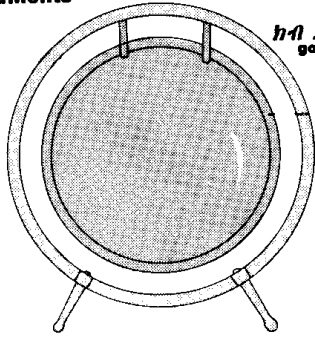

ግንታዊ ሊዳ
metal rod

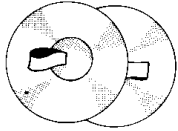
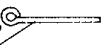

ድምፅ ብረት
cymbals

በትረ ደወል
tubular bells

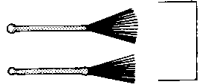
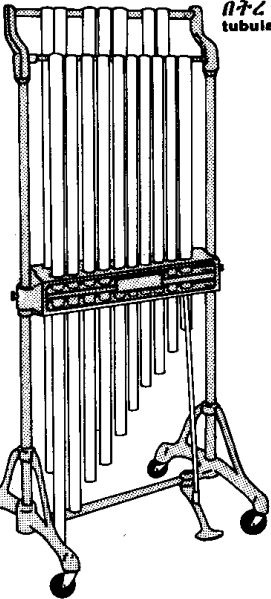

የሽቦ ብሩሾች
wire brushes



የታምቡር መምቻ
sticks



መምቻ
mallets

ካይቡራን
xylophone

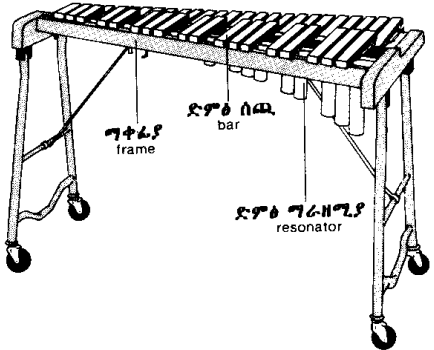

ግብሬያ
frame

ድምፅ ሰጪ
bar

ድምፅ ግራዝግያ
resonator

የምት መሳሪያዎች

percussion instruments

ታምቡሪን
tambourine

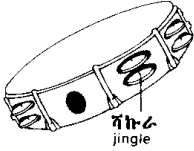

ሽቡራ
jingle

ነዛሪ ታምቡር
snare drum

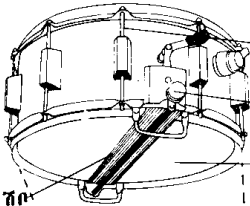

አንዛሪ ሽቡ
snare

የመወጣያ መያዣ
lug

ግቆሚያ
spur

ሰሉሰ ግቆሚያ
tripod stand

ግጥበቂያ ግላሊያ
tension screw

ቅርፅ ነጋሪት ታምቡር
kettledrum

መታኛ
tuning screw

የብረት ክፈፍ
metal counterhoop

ሽከርካሪት
castor

መወጣያ ዘንግ
tension rod

የአንዛሪ መዘወሪያ
snare strainer

ነዛሪ ቆዳ (ግደካ)
snare head

ትልቅ ታምቡር
bass drum

መካከለኛ ታምቡር
tenor drum

ተመቺ ቆዳ (ግደካ)
batter head

pedal መርገሜ

መምቻ
mallet

እግር
leg

ደምፅ ሰጪ ክብ ግደካ (ቆዳ)
head

ክርሰ ታምቡር
shell

መርገሜ (የክርሰ)
pedal

ባህላዊ የሙዚቃ መሳሪያዎች
traditional musical instruments

ግንደሊን
mandolin



መኖች
plectrum



ባላላይካ
balalaika

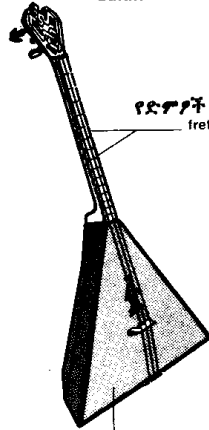

የድኖች መደብ
fret

ባንጆ
banjo

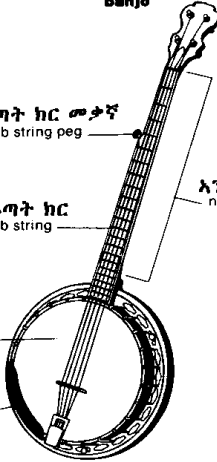

የአውራጣት ክር መቃኛ
thumb string peg

የአውራጣት ክር
thumb string

አንገት
neck

ከበበ ባንጆ
head

አቃፊ
sleeve protector

ትርፅ-ሰሉስ ግእዘን
triangular body

ዚተር
zither

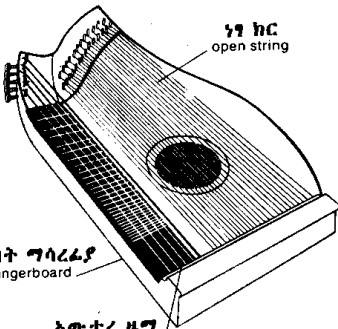

ነፃ ክር
open string

የጣት ግሳረሬያ
fingerboard

አውታረ ዜግ
melody string

ሊዮ
lyre

ተሸጋጋሪ መመገፊያ
crossbar

ከንድ
arm

ግንቢያ ሳፕን
sound-board

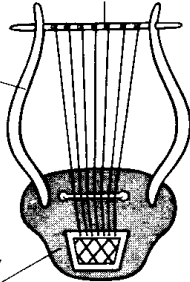

ባህላዊ የሙዚቃ መሳሪያዎች
traditional musical instruments

ፋንፋ
panpipe

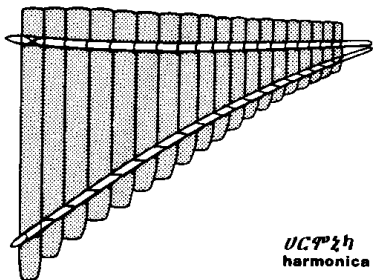

Jew's harp

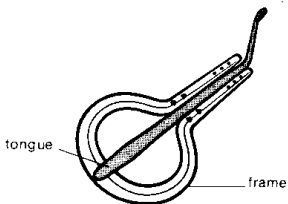

ሀርዎኒካ
harmonica

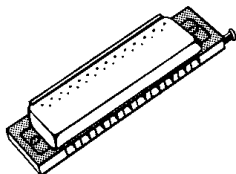

shawm

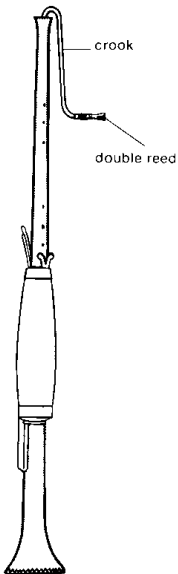

bagpipe

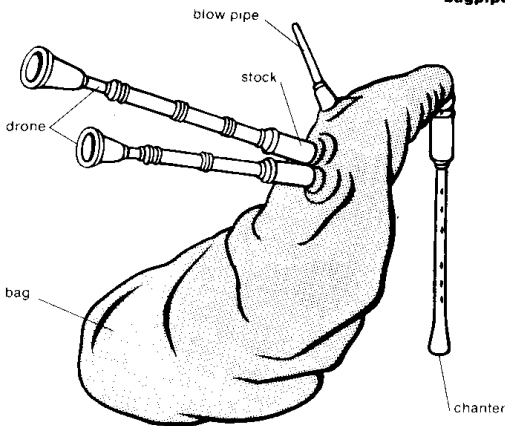

ሙዚቃ

ባህላዊ የሙዚቃ መሳሪያዎች
traditional musical instruments

barrel organ

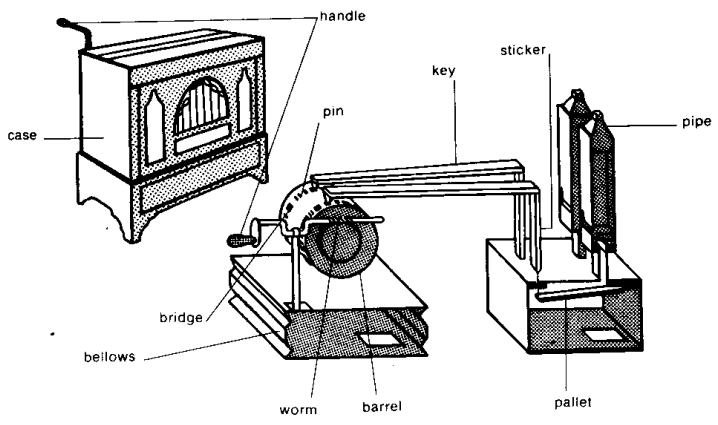

አኮርዲዮን
accordion

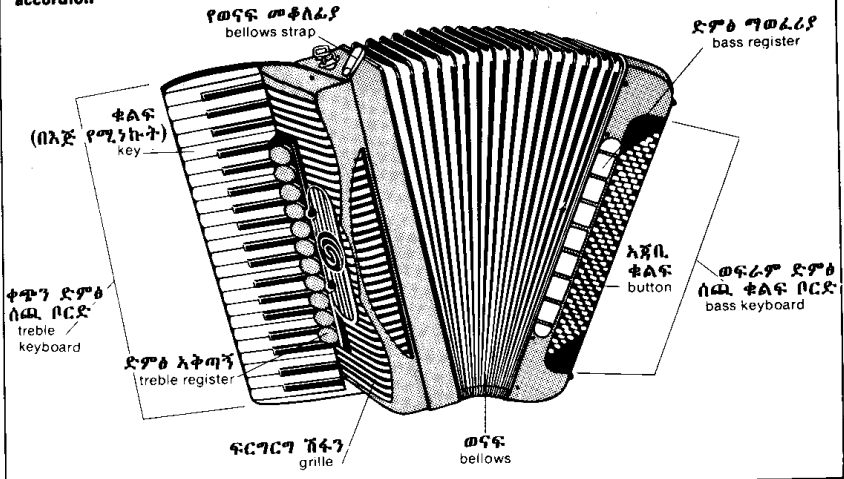

የሙዚቃ መሳሪያዎች ቡድን ምሳሌ
examples of instrumental groups

ሁለትዮሽ
duo



ክላርኔት
clarinet



ፒያኖ
piano

ሶስትዮሽ
trio



ቫዮሊን ፎሎ
violoncello



አቦ
oboe



ሃርቲሳርድ
harpsichord

አራትዮሽ
quartet



ቫዮሊን
violin



ቫዮሊን
violin



ቪዮላ
viola



ቫዮሊን ፎሎ
violoncello

አምስትዮሽ
quintet



ፊርን
French horn



ፍሎት
flute



አቦ
oboe



ክላርኔት
clarinet



ባቡን
bassoon

ውዚቃ

የውዚቃ መሳሪያዎች ቡድን ምሳሌ
examples of instrumental groups

ስድስትዮሽ
sextet



ክላሪኔት
clarinet



ክላሪኔት
clarinet



ሆርን
French horn



ሆርን
French horn

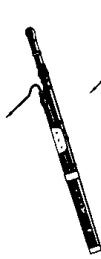

ባዙን
bassoon



ባዙን
bassoon

የጃዝ ባንድ
jazz band

የድረጭ ስብስብ
drum kit



ትላት ታምቡር
bass drum



ጠክላዩ ታምቡር
tenor drum



ነጻሪ ታምቡር
snare drum



ድምብረት
cymbals



ፒያኖ
piano



ደብላ ባስ
double bass



ክላሪኔት
clarinet



ሳክሶፎን
saxophone



ትሮምቦን
trombone



ትራምፕት
trumpet



ኮርኔት
cornet

ድጋፍ ሰጪ የሙዚቃ መሳሪያዎች
musical accessories

የምት መቆጣጠሪያ
metronome

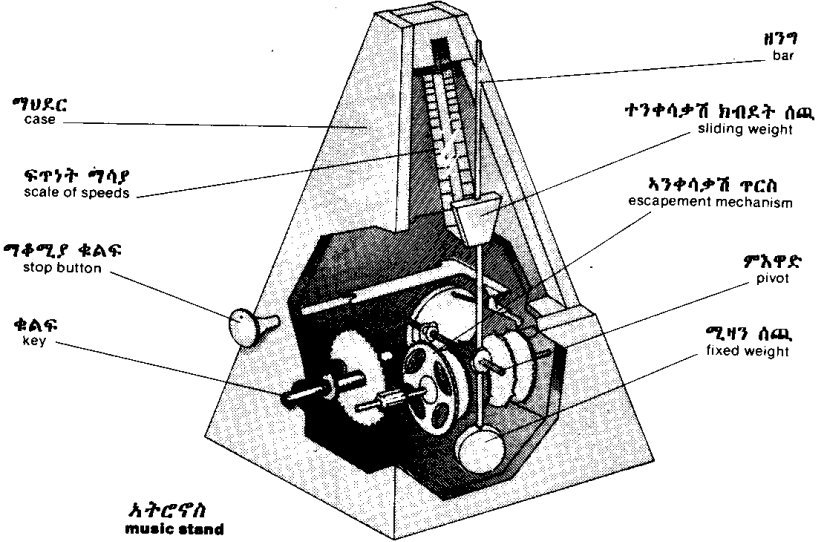

አትሮኖስ
music stand

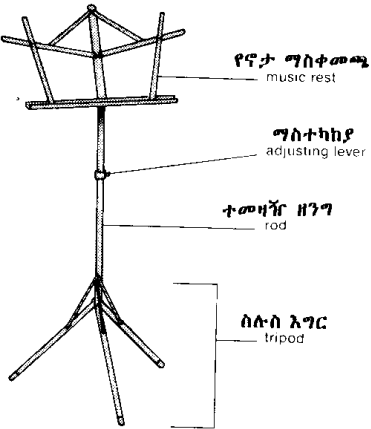

ባለመደሻ መቃኛ
tuning hammer

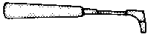

ውስን ድምፅ መቃኛ
tuning fork



የሲምፎኒ እርኬስትራ መሳሪያዎች
symphony orchestra

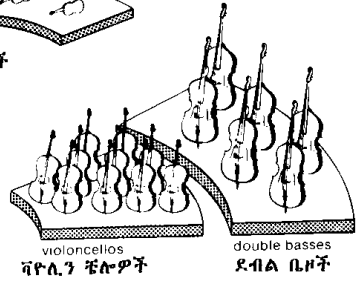
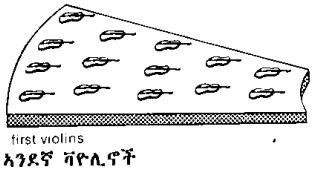
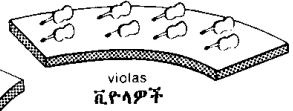
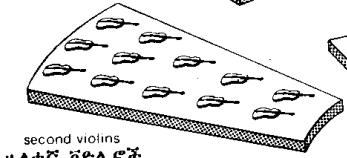
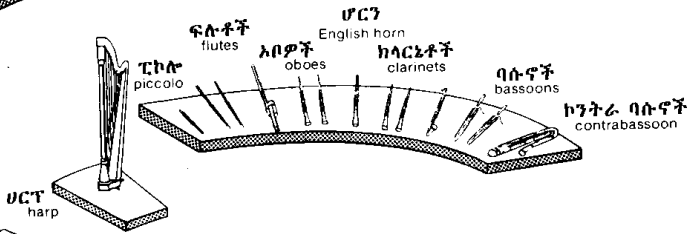
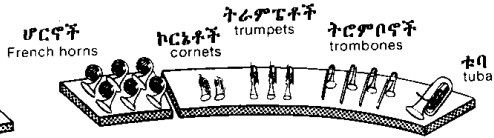
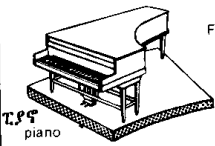
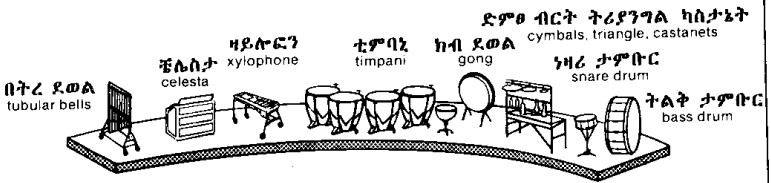

የኤሌክትሪክና የኤሌክትሮኒክ መሳሪያዎች
electric and electronic instruments

(የ)ኤሌክትሪክ ጊታር
electric guitar

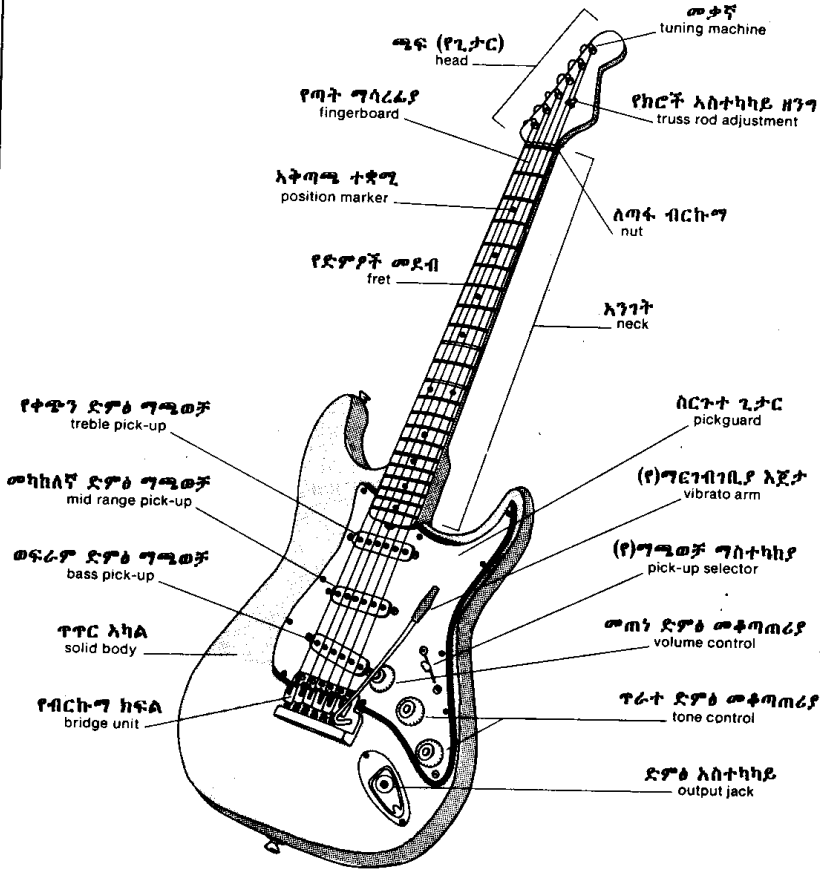

ኤሌክትሮኒክና የኤሌክትሮኒክ መሳሪያዎች
electric and electronic instruments

መራሄ ድምፅ
synthesizer

ድምፅ መለዋወጫ
ring modulator

ድምፅ መመለሻ
reverb unit

የድምፅ ማጥሪያ
output filter

የድምፅ ሂደት ተቆጣጣሪ
sequencer control

የሃይል መቆጣጠሪያ
input level control

ማጣሪያ
filter-oscillator

መሸፈኛ
envelope shaper

የሃይል መለኪያ
VU meter

የሃይል መለኪያ ማጠፊያ ማጥፊያ
VU meter switch

ሃይል ጠቋሚ
power indicator

የሃይል ግብረያ ማጥፊያ
power switch

አደጋ አመልካች
attack knob

ዋናው ድምፅ ሰጪ
joystick

ድምፅ አርገብጋቢዎች
oscillators

የጀኔሬተር ድምፅ ተቆጣጣሪ
noise generator control

መቅረብ ድምፅ
matrix

ፍናተ ድምፅ
interface

በርደ ቁልፍ መቆጣጠሪያ
keyboard control

በርደ ቁልፍ
keyboard

የሚወጣ ድምፅ ተቆጣጣሪ(ዎች)
output controls

ባህላዊ የሙዚቃ መሳሪያ

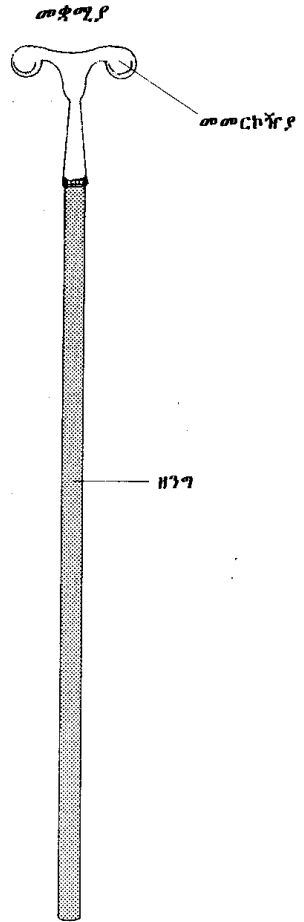
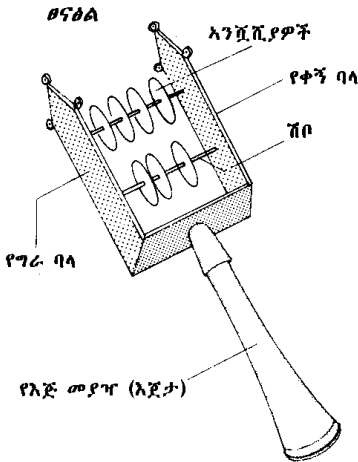
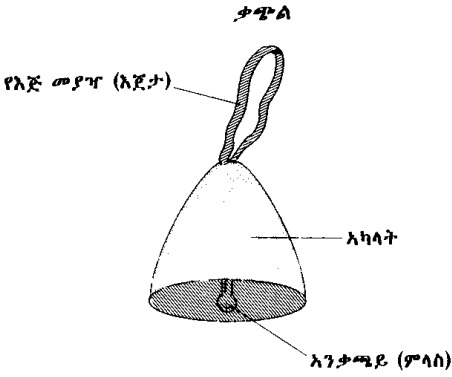

ባህላዊ የሙዚቃ መሳሪያ

ከበሮ

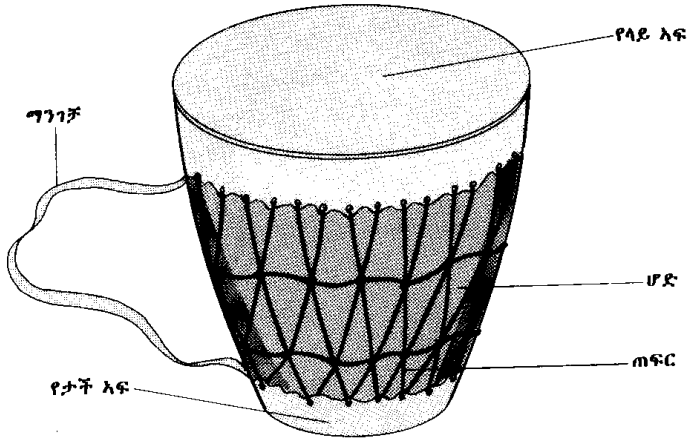

የነጋሪት መምቻዎች

ነጋሪት

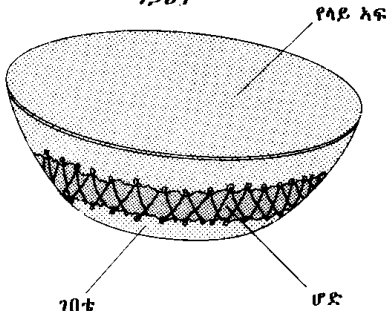

የላይ ላፍ

አታሞ

ግንገቻ

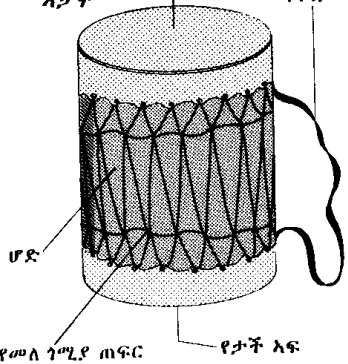

ባህላዊ የሙዚቃ መሳሪያ

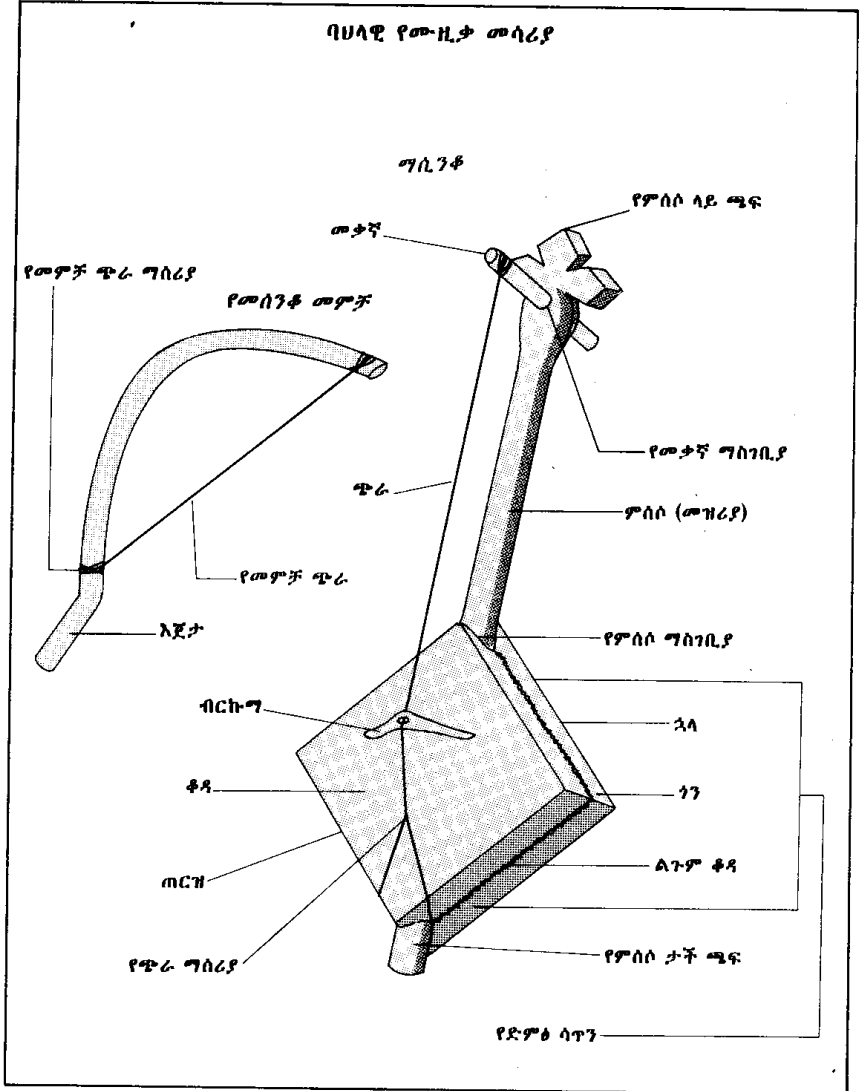

ባህላዊ የሙዚቃ መሳሪያ

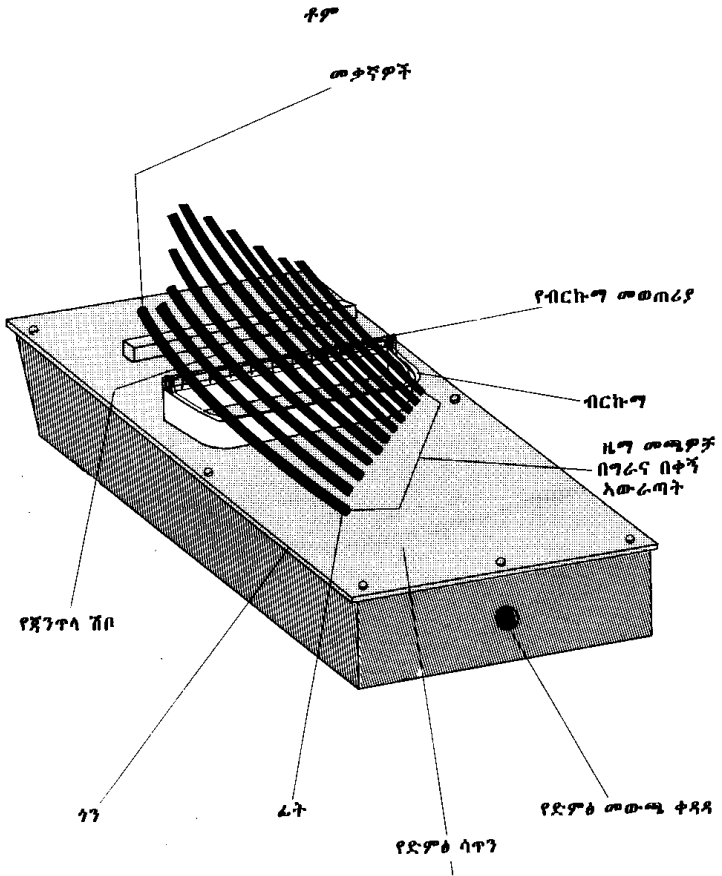

ባህላዊ የሙዚቃ መሳሪያ

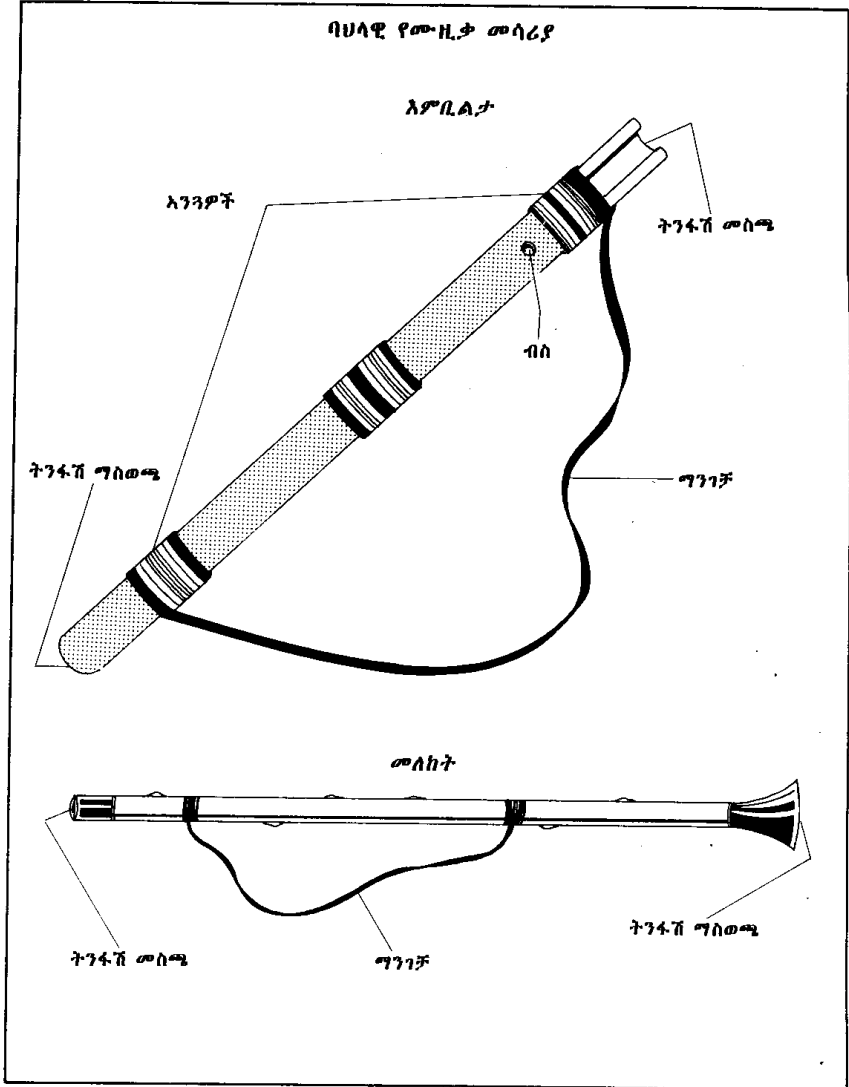

ባህላዊ የሙዚቃ መሳሪያ

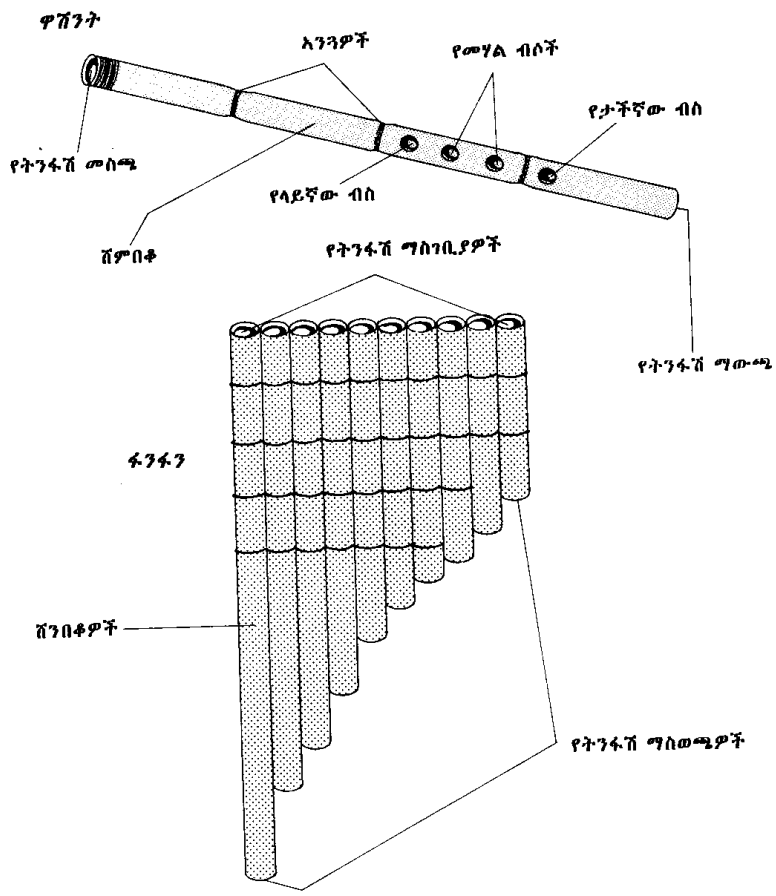

ባህላዊ የሙዚቃ መሳሪያ

በገና

ወፍራዎ መቃኛዎች

ተምበር

የግራ ቋጫ

መጋጠሚያ

የተኝ ቋጫ

የተገመዱ ወፍራዎ ጅግቶች

የቋጫ ግስገቢያ

ገገ

ጸላ

ብርኩግ

የድምፅ ባጥን

ፊት

የጅግቶች መወጠሪያ

ቆዳ

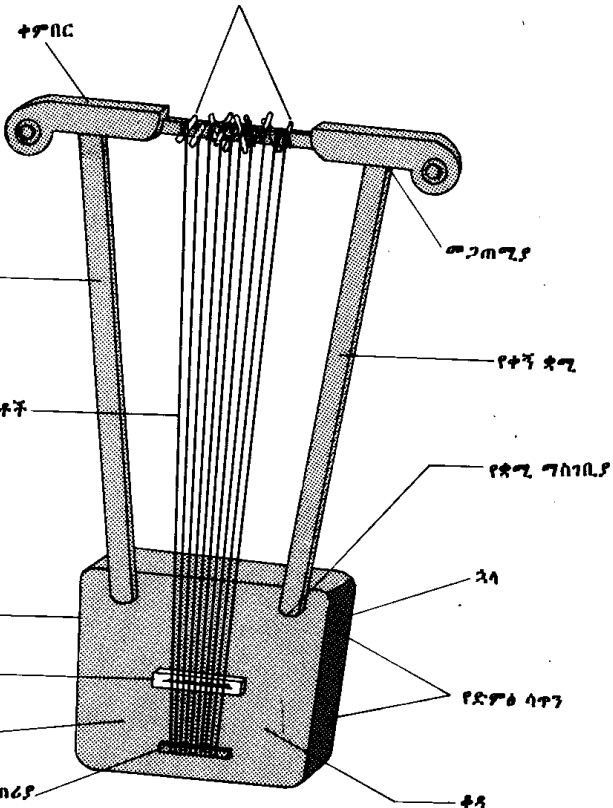

ባህላዊ የሙዚቃ መሰሪያ

