

တၢ်နီု

COMMUNICATIONS

deaf-mute alphabet

letters

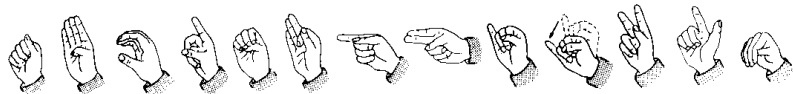

a b c d e f g h i j k l m



n o p q r s t u v w x y z

numbers

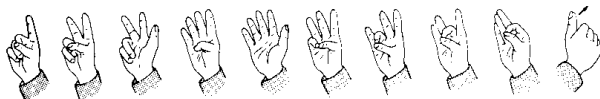

1 2 3 4 5 6 7 8 9 10

ስርአተ ነጥቦች
punctuation marks

•
አራት ነጥብ
period

?
የጥያቄ ምልክት
question mark

!
የቃል አጋና ምልክት
exclamation point

,

ነጠላ ሰረዝ
comma

;

ድርብ ሰረዝ
semicolon

:

ሁለት ነጥብ
colon

...

ሶስት ነጥብ
ellipses

()

ቅንፎች
parentheses

[]

brackets
ግእዝን ቅንፎች

“ ”

ትእምርተ ጥቅስ
quotation marks

‘ ’

ነጠላ ትእምርተ ጥቅስ
single quotation marks

—

ጭረት
dash

*

ኮከባዊ ምልክት
asterisk

/

አዝጋር
slash

diacritic symbols

é

acute accent

à

grave accent

â

circumflex accent

ç

cedilla

’

apostrophe

äi

umlaut

-

hyphen

አሜሪካዊ ሞዴል
American model

አይነተኛ ደብዳቤ
typical letter

አርግ ደብዳቤ
letterhead



መስመረ ቀን
date line

November 13, 1985

የውስጥ አድራሻ
inside address

Mr. Richard Hudson
New Educational Company
28 Third Avenue
New York, N.Y. 10022

ሰላምታ
salutation

Dear Mr. Hudson,

ጉዳይ መስመር
subject line

Subject: Illustrated Thematic Dictionary

In view of our meeting later this week concerning the ILLUSTRATED THEMATIC DICTIONARY that we have discussed in Frankfurt, I enclose for your information a detailed table of contents which gives an idea of the scope of the subjects covered in the book. Also enclosed is a check-list of items we would like to review with you. Please feel free of course to add any question of your own.

አካል
body

አክብሮታዊ መዝጊያ
complimentary close

Sincerely yours,

Jacques Fortin, p.d.g.

ፊርማ
signature

JF/sj

የግእረግ ስም
title

ትይዩ ስም
typed name

Enclosed: The DTV table of contents list of items to be discussed

የአባሪ መገለጫ መስመር
enclosure line

cc for Jean-Claude Corbell

የተጠሪ አህፅርተ ስም
reference initials

P.-S. We will arrive in New York early in the morning.

ድሀረ ክትብ
postscript

ትክክለኛ ቅጂ
carbon copy

ማረጋገጫ ነበባ
proofreading

የእርግጥ ምልክቶች
corrections of errors

በቆሞች አስተካክል
align vertically



በአገድሞች አስተካክል
align horizontally



አዲስ አንቀጽ ጀምር
begin a new paragraph



ወደ መሃል አድርግ
center



ሆሂ አርም
correct a letter



ቃል አርም
correct a word



ቦታ ተው
insert space



መስመር አስተካክል
run in

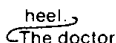

እዚህ አስገባ
insert here



ሆሂ አስገባ
insert a letter



ቃል አስገባ
insert a word



አጠጋጋ
close up



ወደሚቀጥለው መስመር አሸጋግር
take over to next line



ወደ ቀድሞው መስመር መልስ
take back to previous line

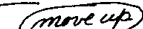

እንዳለ ይቀመጥ
let it stand



ወደ ገፊ ውስድ
move to left



ወደ ቀኝ ውስድ
move to right



የተዘለለ
something omitted

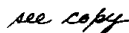

ቦታ ቀንስ
reduce space



አጥፋ
delete



ሁለቱን ቃላት አዘዋውር
transpose two words

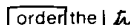

መስመሮች አዘዋውር
transpose lines

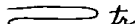

ሁለቱን ሆሂያት አዘዋውር
transpose two letters



የቦርአተ ነጥብ እርግጥ
corrections of punctuation marks

እሬት ነጥብ
period



ነጠላ ሰፈን
comma



አፖስትሮፊ
apostrophe



ድርብ ሰፈን
semicolon



ዋረት
hyphen



ትእምህርተ ጥቅስ
quotation marks



ትንሮች
parentheses



የመከፋፈያ ምልክቶች
corrections of diacritic symbols

ላይኛው ክትብ
superscript



ታሀታይ ክትብ
subscript

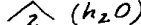

የፊደል አይነት እርግጥ
corrections of type

set in lowercase



set in roman



set in capitals



set in boldface



set in small capitals



set in lightface



በኢታሊክ ፊደላት ይጻፍ
set in italic



የመጻፊያ መሳሪያዎች
writing instruments

ጥንታዊ
ancient



ሚንጎል
steel pen



ላላ ብላር
quill



መርጊ ብላር
stylus

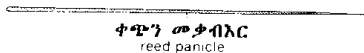

ቀጭን መቃብላር
reed panicle

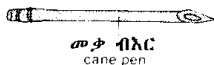

መቃ ብላር
cane pen

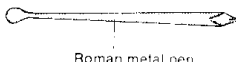

Roman metal pen

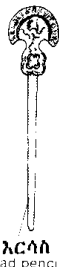

እርሳስ
read pencil

መጻፊያ ብሩሽ
writing brush

ዘመናዊ
modern

እስከረጥቶ
ballpoint pen

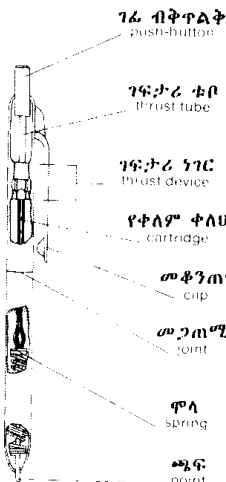

ገፈ ብቅጥልቅ
push-button

ገፍታሪ ቱቦ
frust tube

ገፍታሪ ነገር
frust device

የቀለም ቀለህ
cartridge

መቆንጠኝ
clip

መጋጠሚያ
joint

ጥላ
spring

ሚፍ
point

የቀለም ብላር
fountain pen

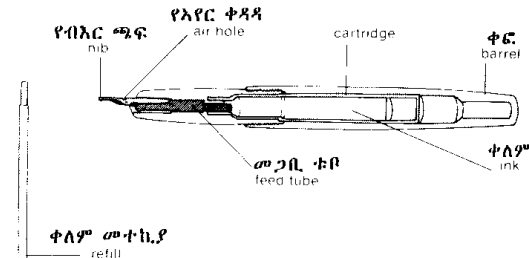

የብላር ሚፍ
nib

የአየር ቀዳዳ
air hole

cartridge

ቀፍ
barrel

መጋቢ ቱቦ
feed tube

ቀለም
ink

ቀለም መተኪያ
refill

other types



ሚርከር
marker



ሚካኒካዊ እርሳስ
mechanical pencil

ፎቶግራፍ እና ሳን
photography

ነጠላ ምስራት እንፀባራቂ ካሜራ
single-lens reflex camera

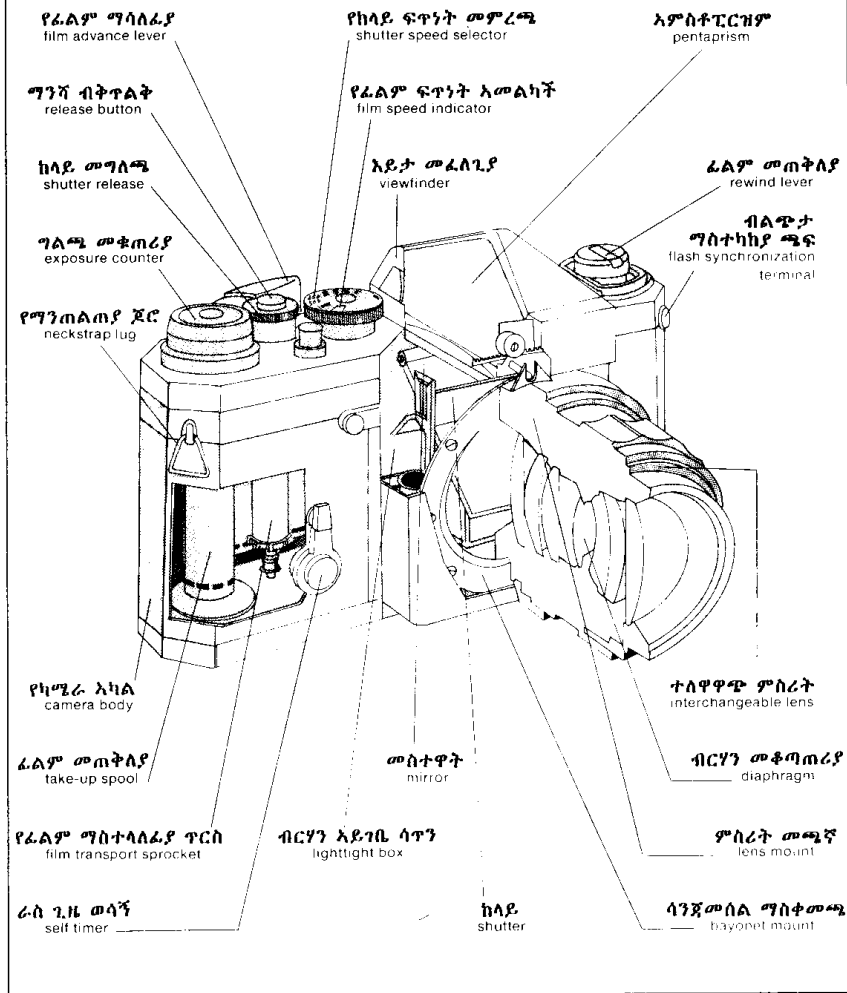

ፎቶግራፍ አነሳሰ
photography

እንቅስቃሴ አልባ ካሜራ
still cameras

ታጣፊ ካሜራ
folding camera

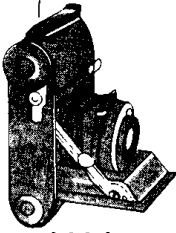

የጋዜጠኛ ካሜራ
press camera

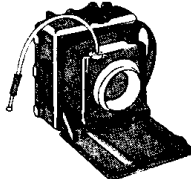

መካከለኛ አይነት ካሜራ
medium format SLR (6 x 6)

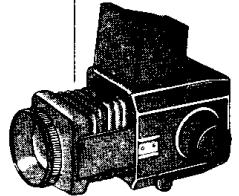

እይታ ካሜራ
view camera

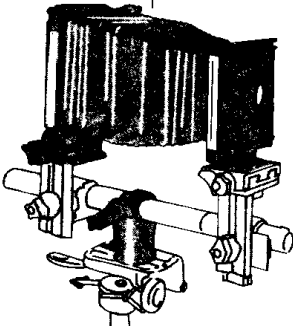

ስለት ጥልቀት ካሜራ
stereo camera

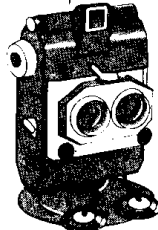

መንትያ ፍሰሪት አንጻራዊ ካሜራ
twin-lens reflex camera

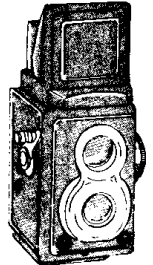

ርቀት መፈለጊያ
rangefinder

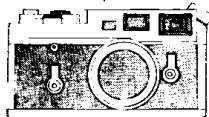

የኪሰ ካሜራ
pocket instamatic camera

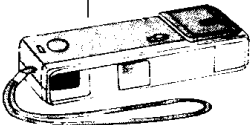

ዲስክ ካሜራ
disc camera

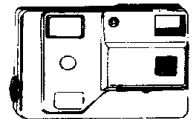

ትንሽ ካሜራ
subminiature camera



ፎቶግራፍ አነሳሰ
photography

ነገረ ምስራትና መለዋወጫዎች
objective and accessories

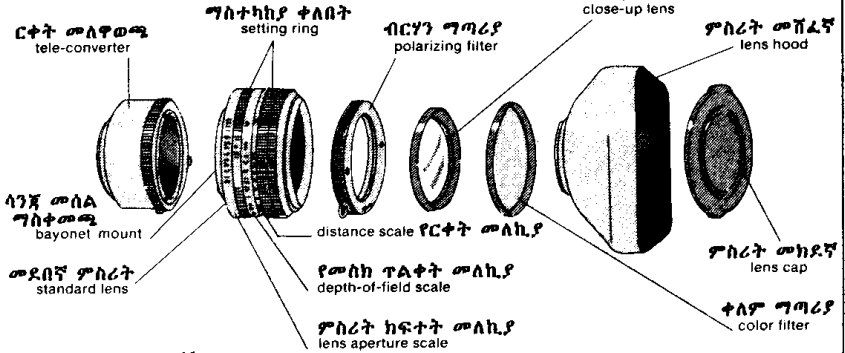

ተለዋዋጭ ምስራቶች
interchangeable lenses

መደበኛ ምስራት
standard lens



ከሬላ አይን ላሳ ምስራት
semi-fish-eye lens



ባለሰፊ አንግላ ምስራት
wide-angle lens



የፍት ግንጃ ምስራት
telephoto lens



ቅርብ ፍት ምስራት
zoom lens

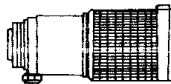

አሳ አይን ምስራት
fisheye lens

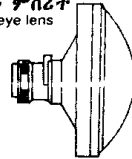

ቀጠ አንግላ መፈለጊያ
right angle finder

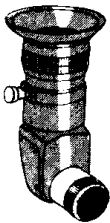

አይን አቅርብ ግጉሊያ
eyepiece magnifier



አይን ግግሮች
eyecups



ፎቶግራፍ አነሳስ
photography

አሃድ ብልጭታ
flash unit

ኤሌክትሮኒክ ብልጭታ
electronic flash

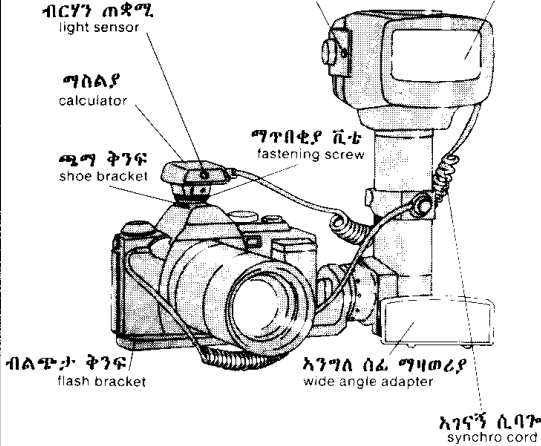

ብልጭታ አምጥል
flash lamp

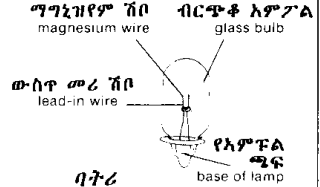

ብልጭታ ኩብ
flashcube



ግልጠት መለኪያ
exposure meter

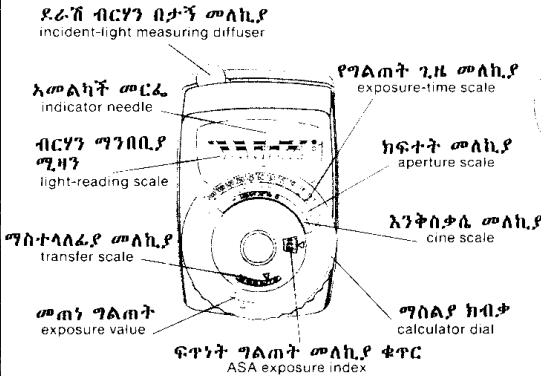

ብርሃን መለኪያ
spotmeter

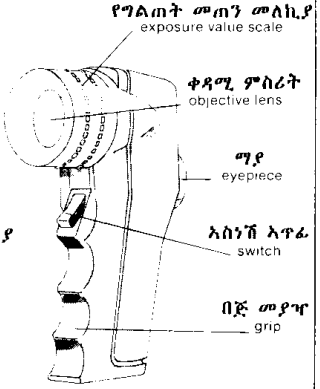

ፎቶግራፍ አነሳሽ
photography

የስቀዲዮ መብራት ቁሳቁስ
studio lighting

ብልጭታ ሰጭ
flash

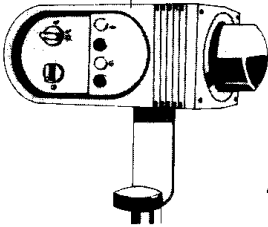

አሰራጭ
infrared transmitter



ብልጭታ ለኪ
flash meter

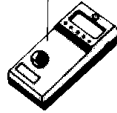

ኖኚ ብርሃን ማጣሪያ ዋህድ
diffuser filter set

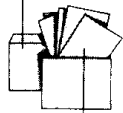

ቀለም ማጣሪያ ዋህድ
color filter set

ኢሌክትሪክ አስተካካይ ኪብል
sync cable



ኖኚ ጃንጥላ
umbrella diffuser

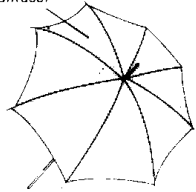

ዋና የሌትሪክ ገመድ
main cable

መለወጫ
converter

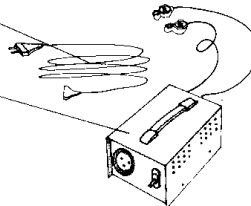

ጉተራ ቦሮች
barn doors

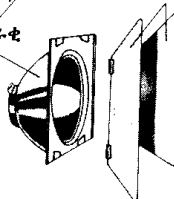

ጉን ውርውር አንጻራቂ
parabolic reflector

ቅንብቢት አፍንጫ
conical snoot

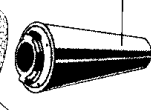

ዳሚ
stand

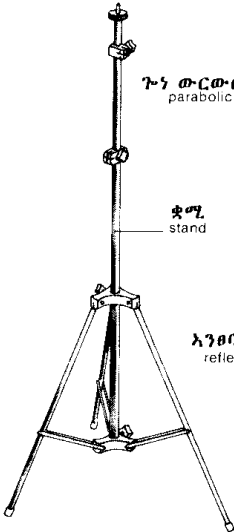

አይነስ ጉ ኖኚ
honeycomb diffuser

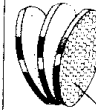

አንጻራቂ መጋረጃ
reflecting screen

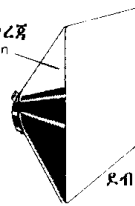

ኖኚ
diffuser

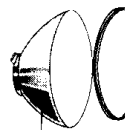

ብርሃን መፈንጠቂያ ማገናኛ
spot projector attachment



ደብዛዛ ብርሃን አንጻራቂ
softlight reflector

ፎቶግራፍ አገላለጽ

photography

ፎቶግራፍ ግንባታ መለዋወጫዎች

የአየር አምፕላ መልቀቂያ



ካብ መልቀቂያ



ስሉስ እግር

የካሜራ ቅርንፕቶድ

መደበ ካሜራ

አገባታሽ መያዣ

እግር ሩቅ እይታ

ታችኛው የካሜራ መሽከርከሪያ እግር

ጉንጋዶ ቱልኛ

አንሺ አውራጅ ራስ

ቱል አምድ

አምድ መዘወሪያ

አምድ

የእግር ቀለበት

የስቲዲዮ መለዋወጫዎች

studio accessories

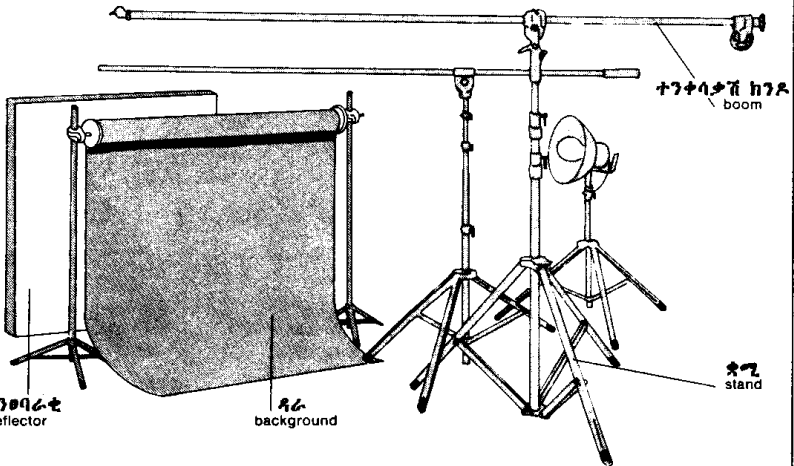

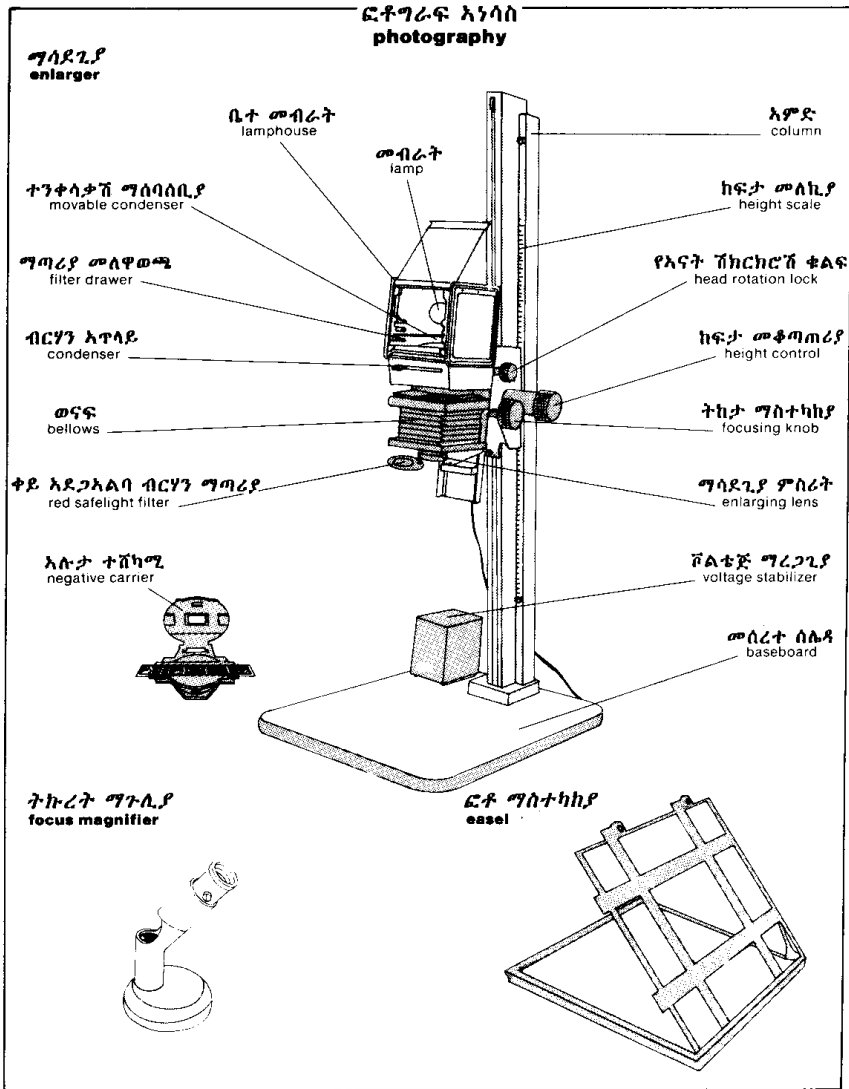

ፎቶግራፍ እና ሳስ
photography

ምስል ፈንጣቂ
slide projector

ምስል ተሸካሚ መደርደሪያ
slide tray

አቀዝቃዥ አራጋቢ
cooling fan

ምስል ተሸካሚ ቀያሪ
slide changer

የፍንጠቃ መብራት
projection lamp

ብርሃን አጥላይ
condenser

ዋና ገመድ
main cord

የፍንጠቃ ግርጃ
projection screen

ማንጠልጠያ
hanger

መወጣሪያ
saddle

መላቢያ ቀለበት
pull bail

አብረቅራቂ ፊልም ግምጃ
pearl screen

ቱቦ
tube

ገፊ ብቅጥልቅ
push-button

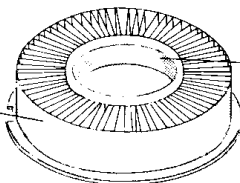

መቆላፊያ ቀለበት
lock ring

ሞተር
motor

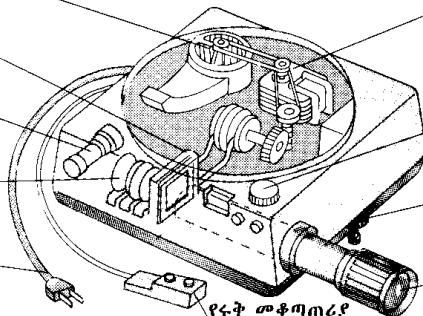

ትኩራ ማስተካከያ
focusing knob

ማደላያ እግር
leveling foot

ምስራት
lens

የሩቅ መቆጣጠሪያ
remote control

ብርሃን አስተላላፊ ምስል ተሸካሚ
transparency slide

የምስል ተሸካሚ ክፈፍ
mount frame blinder

ፎቶግራፍ ስእል
photographic picture

ግርጃ መያዣ
screen case

ስሎስ እግር
tripod

መርገጫ
shoe

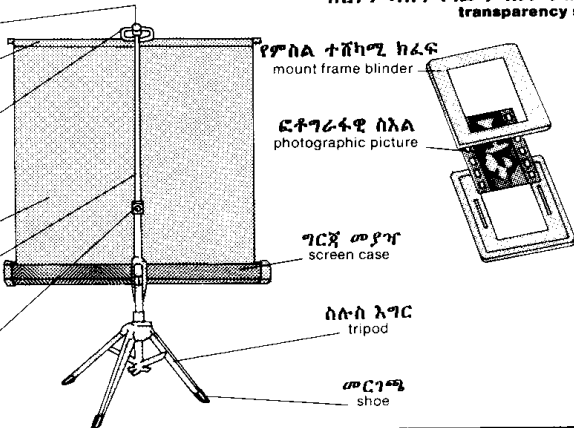

ድምፅ አወጣጥ ስርአት

sound reproducing system

የመሰሪያው ክፍሎች
system elements

አገናኝ ካቦ
connecting cable

ቅድመአገሊ አገሊ
preamplifier-amplifier

ድምፅ ማጉሊያ
loudspeaker

መቅረቦ ድምፅ
tape deck

ማዳመጫ
headphone
ድምፅ ማጉያ
speaker

ማይክሮፎን
microphone

ተ.ኩ
AC cord
(ተለዋዋጭ ኮረንቲ ገመድ)

መጠነ ድምፅ መቆጣጠሪያ
level controls

ድምፅ ማስተካከያ
tuner

ሸክላ ማዲዎች
turntable

ሳጥን
cabinet

ለክሊ ቀጥን ድምፅ
supertweeter

አኩል አድራጊ
equalizer

ድምፅ ቀጥን
tweeter

ማእከል መዳረሻ
midrange

ድምፅ ወፍራም
woofer

ተርገብጋቢ
diaphragm

ቅምብቢት
cone

ሸንሽን
corrugation

መከላከያ ፍርግርግ
grille

ማዳመጫ
headphone
ድምፅ መቆጣጠሪያ
volume control

ራስ ገጠም
headband

መከላከያ ፍርግርግ
grille

የጆር ምቹ
ear cushion

ተሰኪ
jack

ድምፅ አወጣጥ ስርአት

sound reproducing system

አጉሊ ማስተካከያ
amplifier-tuner

ክልል መምረጫዎች
band selectors

ድግግሞሽ እውቶማቲካዊ መቆጣጠሪያ
frequency automatic control

መቆጣጠሪያ አመልካች
monitor indicator

የድግግሞሽ አስተካክል ስቲሪዮ አመልካች
FM stereo indicator

አምሳለ ድግግሞሽ መለኪያ
analog frequency meter

ድምፅ ማጉያ መምረጫ
speaker selector

አሃዛዊ ድግግሞሽ ማሳያ
digital frequency display

የግብአት መምረጫዎች
input selectors

አቅም መክፈቻ
power switch

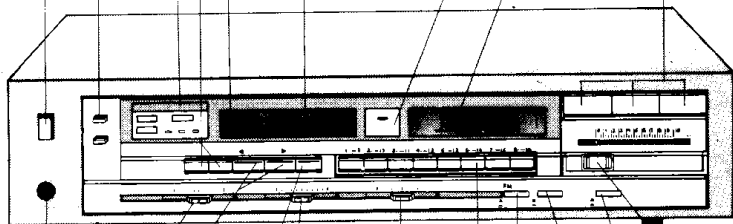

ማዳመጫ መለኪያ
headphone jack

ድምፅ መቆጣጠሪያ
volume control

ወፍራም ዜማ መቆጣጠሪያ
bass tone control

ሚዛኑ ድምፅ መቆጣጠሪያ
balance control

የድምፅ ከፍታ ቁልፍ
loudness switch

ድምፅ ማስተካከያ ቁልፎች
tuning buttons

ቅድመ ማስተካከያ ቁልፍ
preset tuning button

ክር መቆጣጠሪያ ቁልፍ
tape monitor switch

አስታውሴ ቁልፍ
memory button

ከፍተኛ ዜማ መቆጣጠሪያ
treble tone control

ድግግሞሽ አስተካክል መምረጫ
FM mode selector

ድምፅ አወጣጥ ስርዓት

sound reproducing system

መቅረፅ ድምፅ
tape deck

ከር መምረጫ
tape selector

ቆጣሪ መመለሻ ቁልፍ
counter reset button

የክር አይነት አመልካች
tape-type indicator

ከር ቆጣሪ
tape counter

ብርሃን ፈንጣቂ የድምፅ
LED peak level meter
ከፍታ መለኪያ

አቅም መክፈቻ
power switch

አፍኔ መቅረጫ ቁልፍ
record muting button

ግፀደረ ካሴት
cassette holder

ድምፅ መቅረጫ ቁልፍ
record button

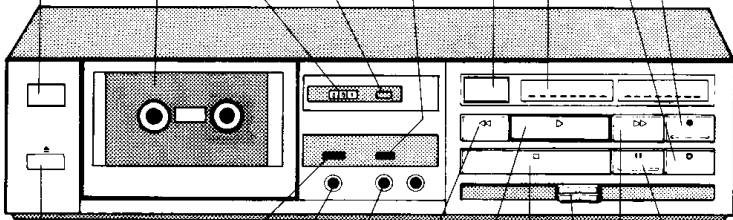

ካሴት ግስፈንጠሪያ
eject button

ግዘሊያ ቁልፍ
pause button

የግምገማታዊ ድምፅ መቀነሻ ቁልፍ
Dolby noise reduction switch

ግጠንጠኛ
ቁልፍ /
rewind button

ፈጣን ግስቀደሚያ ቁልፍ
fast-forward button

ድምፅ ራስ መስኪያ
headphone jack

ግጫወቻ ቁልፍ
play button

ጊዛን መቅረፅ ድምፅ ቁልፍ
recording level button

ግይክሮፎን መስኪያ
microphone jack

ግቆሚያ ቁልፍ
stop button

ቪዲዮ-ቴፕ ሬከርደር
video tape recorder

ግዘጊያ/ግቆሚያ
pause/still

ግቆሚያ
stop

መልሶ አጠገብኝ
rewind

ያስታውሱ ቆጣሪ ቁልፍ
counter memory button

ካሴት ግስገቢያ ክፍተት
cassette loading slot

ፈጣን ግስቀደሚያ
fast forward

መላሽ ቁልፍ
reset button

አቅም መክፈቻ
power switch

መቅረጫ
record

አሃዛዊ ሰአት
digital clock

መስፈገጠሪያ
eject

መክፈቻ
play

ትድመ ግስተካክያ መቆጣጠሪያ
pre-tuning control

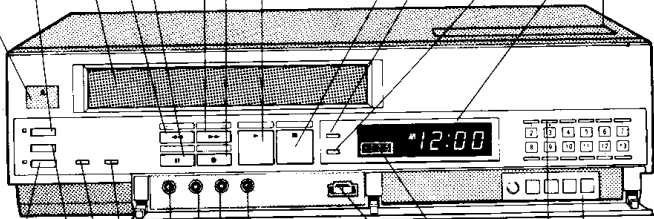

በሰአት ግስጂመሪያ ቁልፍ
timer on switch

ድምፅ ውጣት
audio output

ፕሮግራሚንግ የቀረጸ ሰአት ግስተካክያ
programmable timer

አቅም/በሰአት ግቆሚያ ቁልፍ
power/timer off switch

ቪዲዮ ውጣት
video output

መስመር መምረጫ መቆጣጠሪያ
channel selector control

ቪዲዮ/ቴሌቪዥን መምረጫ
video/TV selector

የድምፅ ገብላት
audio input

ክር ቆጣሪ
tape counter

የክር ፍጥነት መምረጫ
tape speed selector

ቪዲዮ ግስተላለፊያ
video input

ፕራት መቆጣጠሪያ
tracking control

ተንቀሳቃሽ ምስል አነሳስ
cinematography

ባለድምፅ ካሜራ
sound camera

የቀን ብርሃን ግጥሪያ መቆጣጠሪያ
daylight filter control

እይታ መረገያ
viewfinder

የጅ ቅርብ ሩቅ ቀለበት
manual zoom ring

የአይን ግጥም
eyecup

ትክታ ቀለበት
focusing ring

የባትሪ መቆጣጠሪያ መለኪያ
battery check meter

ከፍያል ትኩራ ግስተካክያ
macro focusing knob

የፊልም ርዝመት ቆጣሪ
film footage counter

ቃታ
trigger

የሩቅ መቆጣጠሪያ መለኪያ
remote control socket

የጅ መያዣ
handgrip

ብልጭታ መለኪያ
flash socket

የካሜራ ባትሪ
camera battery

የጅ ክፍተት መቆጣጠሪያ
manual aperture control

ግስንሻ ቁልፍ
on/off switch

ድምፅ ፈንጣቂ
sound projector
ተቀባይ ሽከርካር ግጥጦች
take-up reel

አቀባይ ሽከርካር ግጥጦች
supply reel

ትክታ መቆጣጠሪያ
focusing control

ፈለገ ፊልም
film path

ድምፅ ማጉያ
speaker

ቀረገ ግገሻ መልቀቂያ
recording switch

መብራት
lamp

ፈንጣቂ ቅርብ-ሩቅ ምስራት
projector zoom lens

ድምፅ መቆጣጠሪያ
volume control

ጠርዝ መቆጣጠሪያ
framing control

ኪግ መቆጣጠሪያ
tone control

መቅረጫ-ግጥሜ አናት
recording reproducing head

ድምፅ ግስጂመሪያ
ድምፅ መቆጣጠሪያ
sound-on-sound control

ወደፊት/ወደኋላ ግገሻ መልቀቂያ
forward reverse switch

ተስተካካይ መርገሜ
adjustable foot

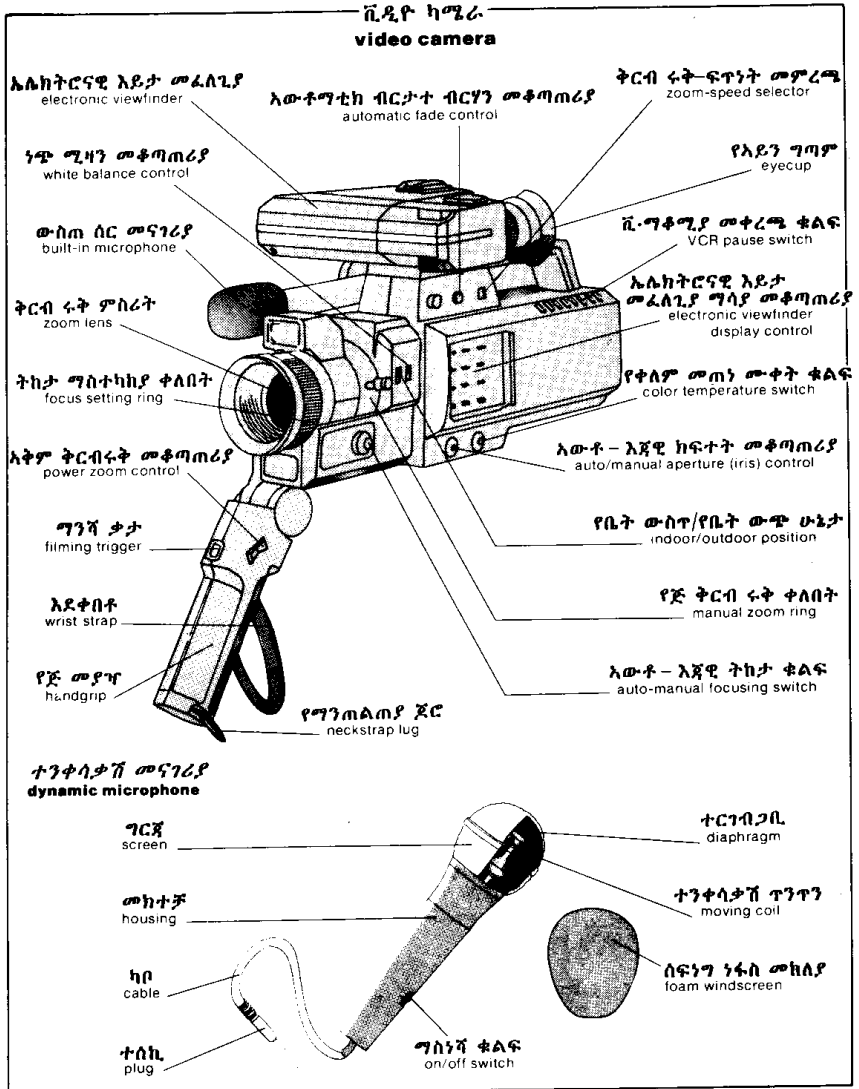

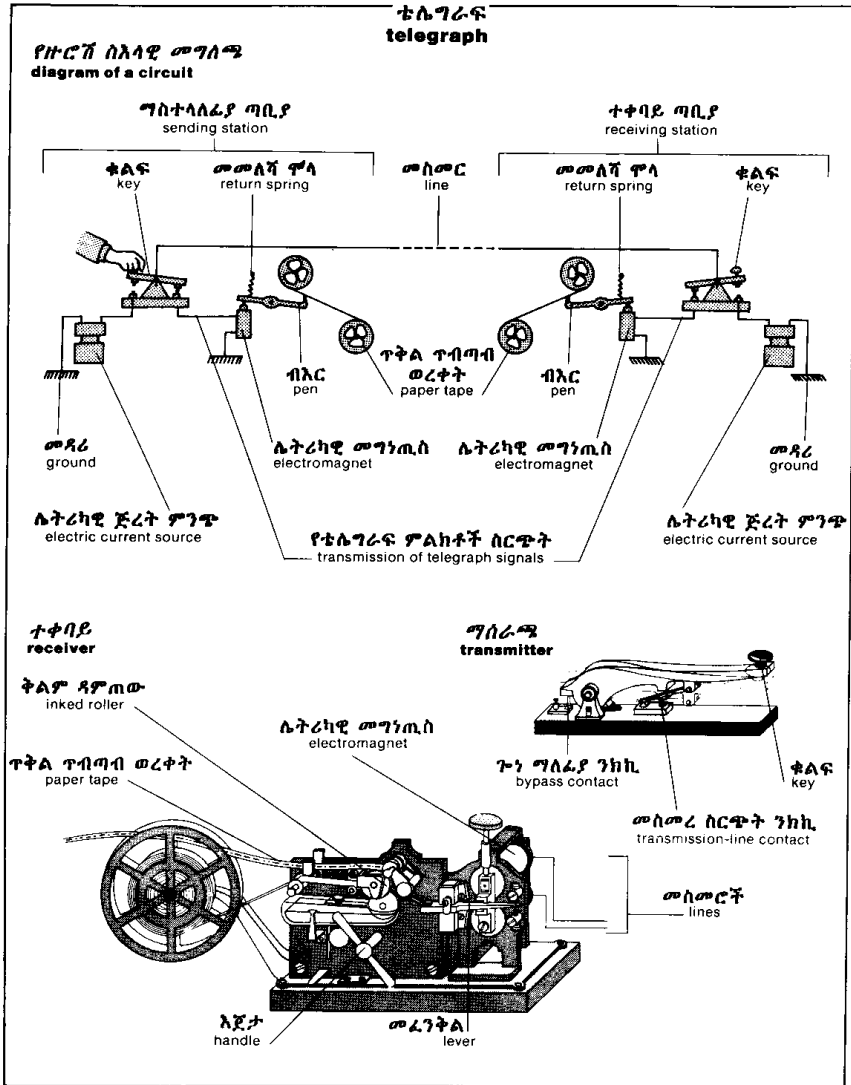

ቴሌግራፍ
telegraph

Morse code

alphabet

A	• •
B	• • • •
C	• • • • •
D	• • • •
E	•
F	• • • •
G	• • • •
H	• • • •
I	• •
J	• • • • •
K	• • • •
L	• • • • •
M	• • • •
N	• • •
O	• • • •
P	• • • • •
Q	• • • • •
R	• • • •
S	• • • •
T	• •
U	• • • •

V	• • • • •
W	• • • •
X	• • • • •
Y	• • • • •
Z	• • • • •

period (.)	• • • • •
comma (,)	• • • • •
interrogation (?)	• • • • •
colon (:)	• • • • •
semicolon (;)	• • • • •
hyphen (-)	• • • • •
slash (/)	• • • • •
quotation marks (")	• • • • •

numerals

1	• • • • •
2	• • • • •
3	• • • • •
4	• • • • •
5	• • • • •
6	• • • • •
7	• • • • •
8	• • • • •
9	• • • • •
0	• • • • •

dash	—
dot	•

ቴሌክስ ሩቅ ተያቢ
telex: teleprinter

ጥቅል ጥብጣብ ወረቀት
paper tape

መብሻ
perforator

የብስ ጥልቅ ወረቀት አንባቢ
punched paper tape reader

ጥቅል ጥብጣብ ወረቀት ማስጀመሪያ ቁልፍ
paper tape start button

መተያቢያ ቁልፍ
keyboard

ቁርጥራዊ ወረቀት ማጠራቀሚያ
chad container bin

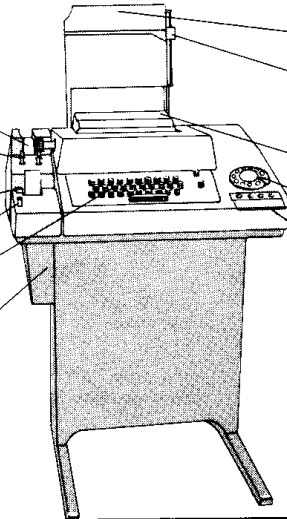

ማህደረ ቅጂ
copy holder

መስመር መሪ
line guide

ጥቅል ወረቀት
roll of paper

መደወያ
dial

መቆጣጠሪያ
controls

ንዝ ስልክ
telephone set

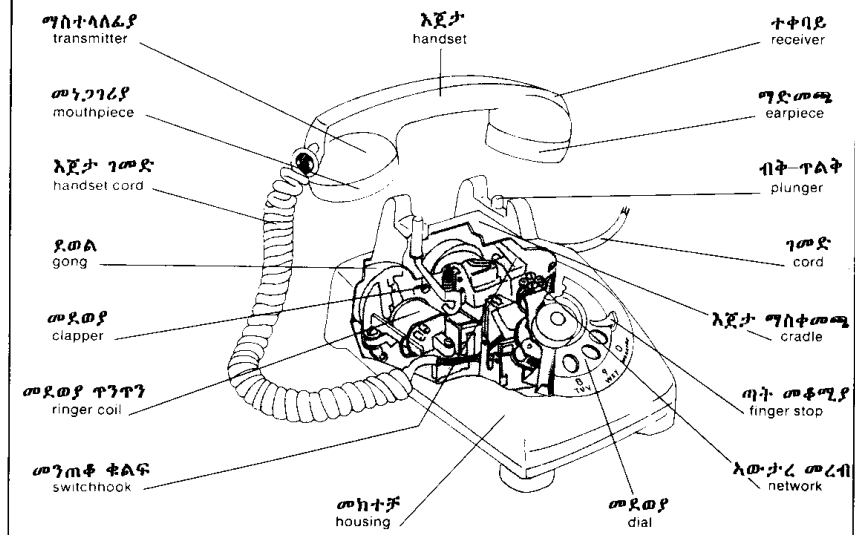

ተቀባይ
receiver

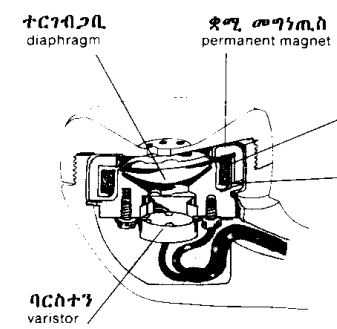

ማሰራጫ
transmitter

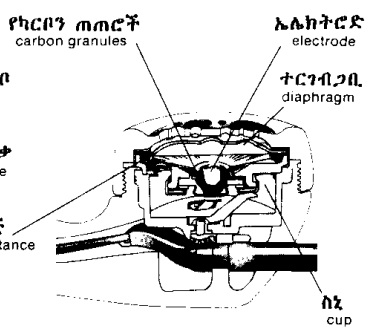

የስልክ አይነቶች
types of telephones

የውስጥ ግዞሪያ
call director telephone

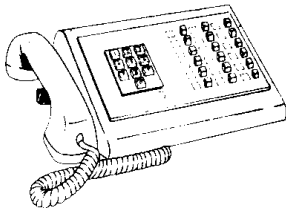

ገመድ አልባ ስልክ
cordless telephone

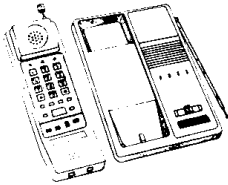

ጥሪ መላሽ መኪና
telephone answering machine

- መሰረጥ ቁልፍ
erase button
- መክፈቻ/ግጫዎቻ
ቁልፍ
on/play button
- ግጠንጠኛ ቁልፍ
rewind button
- ፈጣን ግስቀደጫ ቁልፍ
fast forward button
- ግድመጫ ቁልፍ
listen button
- መዝጊያ ቁልፍ
stop button
- ቀረጥ ግሳያ ቁልፍ
record announcement button

ግይክሮሮን
microphone

የወጪ ግስታወቂያ መያዣት
outgoing announcement cassette

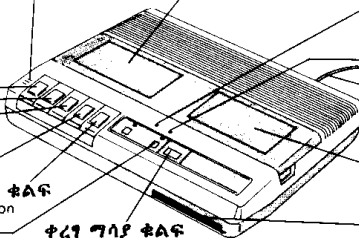

የባንቲም ስልክ
coinbox telephone

ባንቲም ግስገቢያ
coin slot

ባንቲም ግስመለሽ
coin return knob

ጠቅጠቅ መደወያ
push buttons

እጀታ
handset

የተመላሽ ባንቲም መራገሬያ
coin return bucket

ብረት ለበስ ገመድ
armored cord

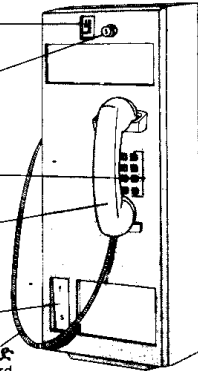

ጠቅጠቅ ስልክ
push-button telephone



እጀ አይነክ ስልክ
handsfree telephone

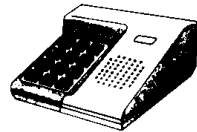

ራስመላሽ አመልካች
auto answer indicator

የጥሪዎች አመልካች
calls indicator

የስልክ ገመድ
telephone cord

የገቢ መልእክት መያዣት
incoming message cassette

ድምፅ መቆጣጠሪያ
volume control

ትራንስፖርት
TRANSPORTATION

አውቶሞቢል
automobile

ፊት እይታ
front view

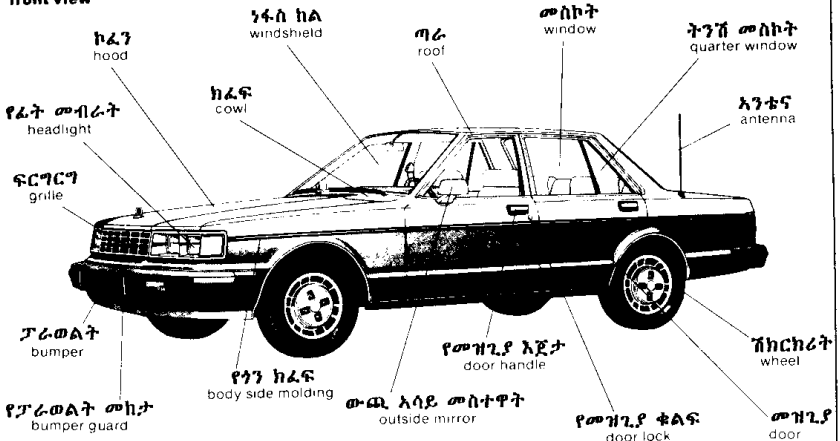

ኋላ እይታ
rear view

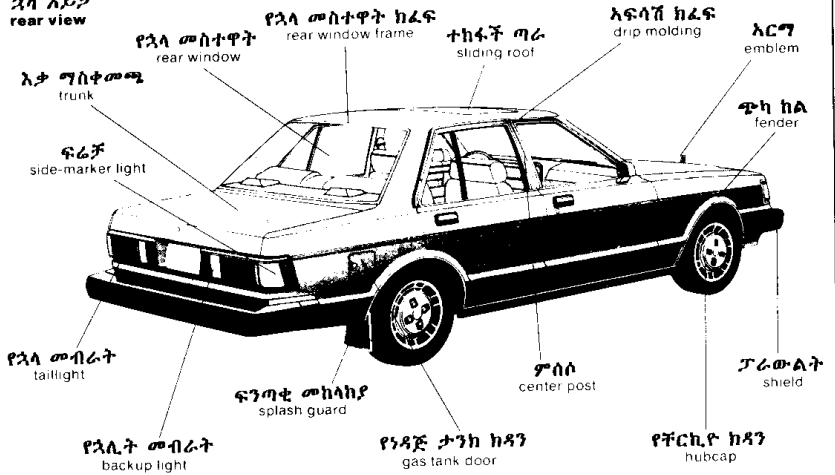

አውቶሞቢል
automobile

የአካል አይነቶች
types of bodies



ባለሁለት በር ሴዳን
two-door sedan



ባለ ድፍን ጣራ
hardtop



ስቴሽን ዋገን
station wagon



ባለአራት በር ሴዳን
four-door sedan



ሊመዚን
limousine

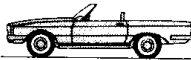

ተጠቅላይ ጣራ
convertible



የሸቅድድም መኪና
racing car

የፊት መብራት
headlight

የፊት መብራት አቃፊ
headlight housing shell

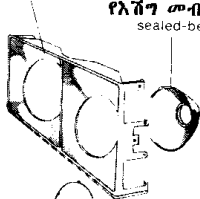

የእሽግ መብራት ማሰሪያ ቀለበት
sealed-beam mounting ring



ገዢ ቀለበት
retaining ring

የመብራት አቃፊ
headlamp bezel

የስቴሽን ዋገን ጳላ
back of a station wagon

ፓርቶባሊያ
luggage rack

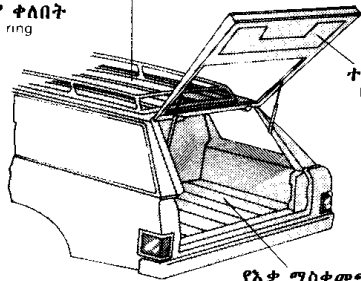

ወደላይ ተከፋች በር
lift gate

የእቃ ማስቀመጫ ወለል
trunk floor

የዝናብ መጥረጊያ
windshield wiper

የዝናብ መጥረጊያ መቆንጠጫ
windshield wiper blade

የመጥረጊያ እጅታ
wiper arm

ወጣሪ ሞላ
tension spring

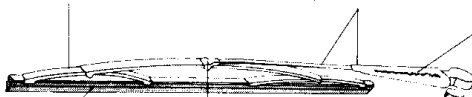

መጥረጊያ
wiper

መጋጠሚያ
articulation

ሰንጠረዥ ኩላላ
fluted shaft

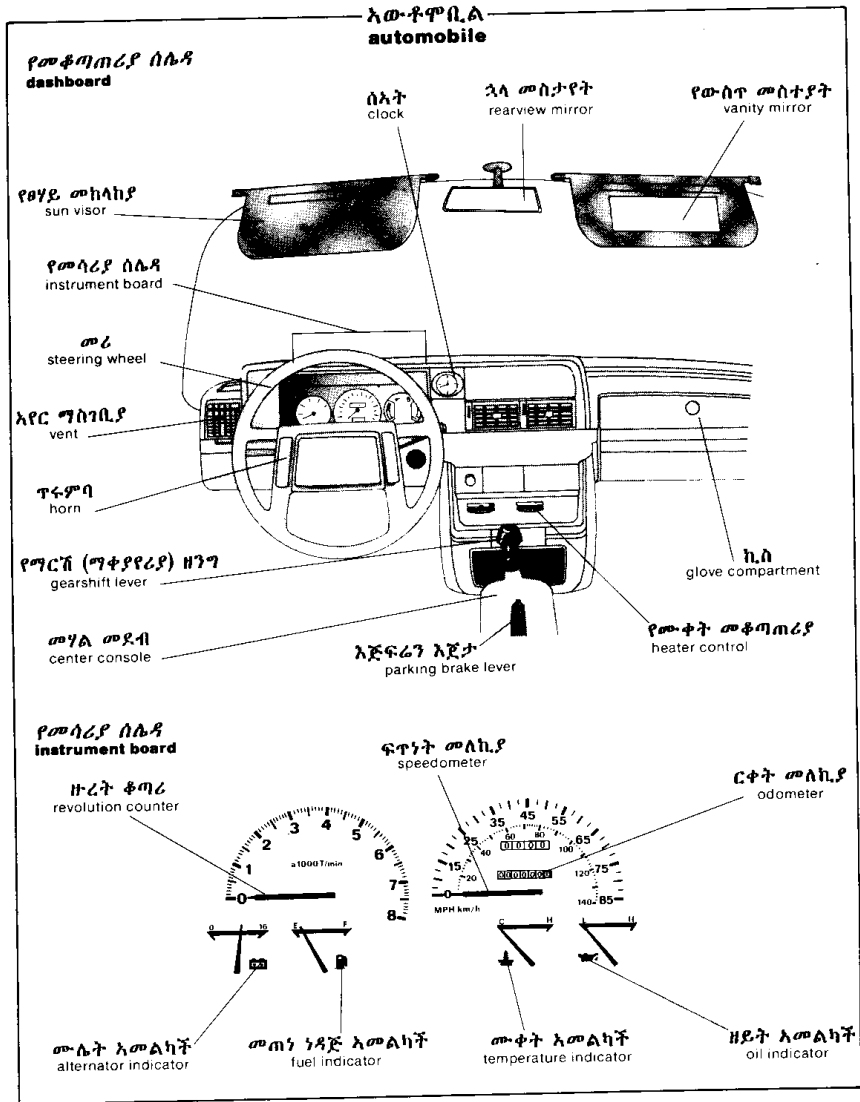

አውቶሞቢል
automobile

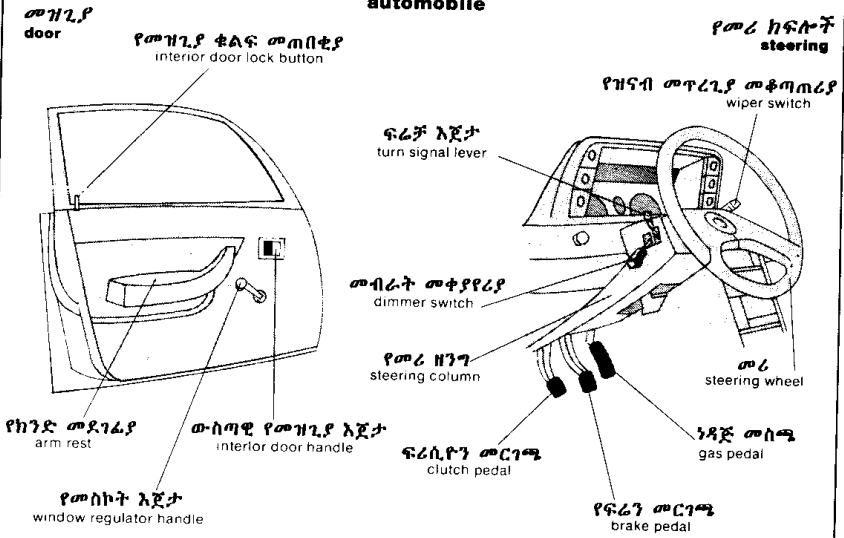

መቀመጫዎች
seats

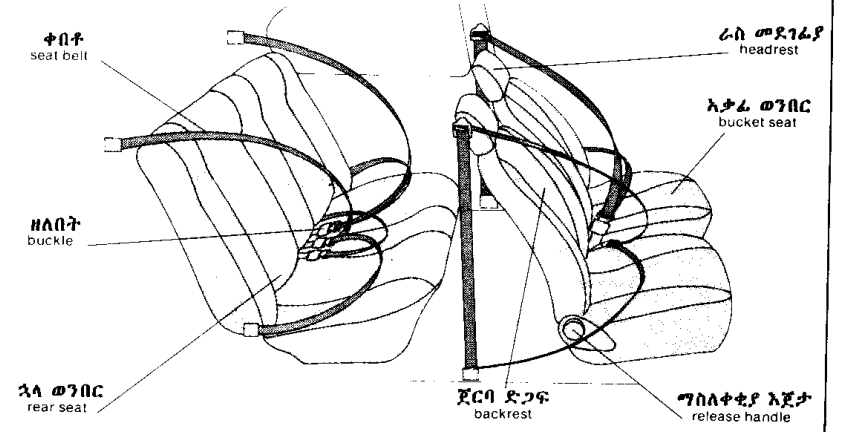

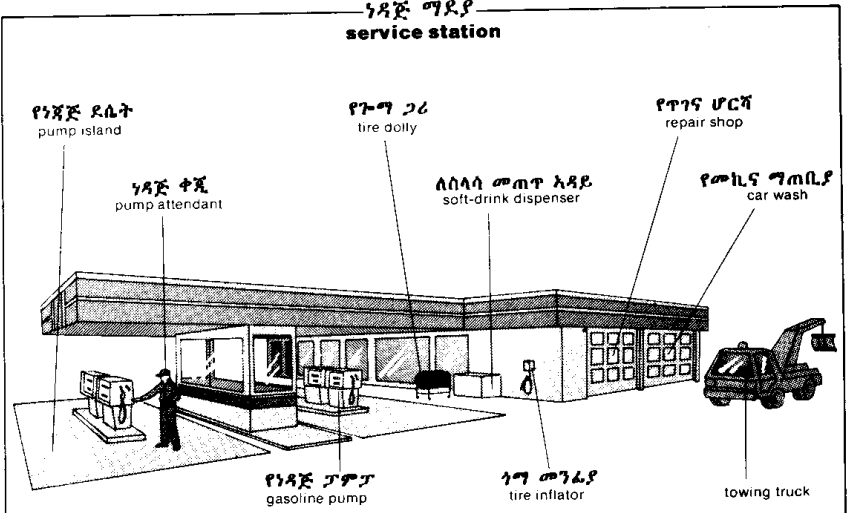

የነጻጅ ፓምፓ
gasoline pump

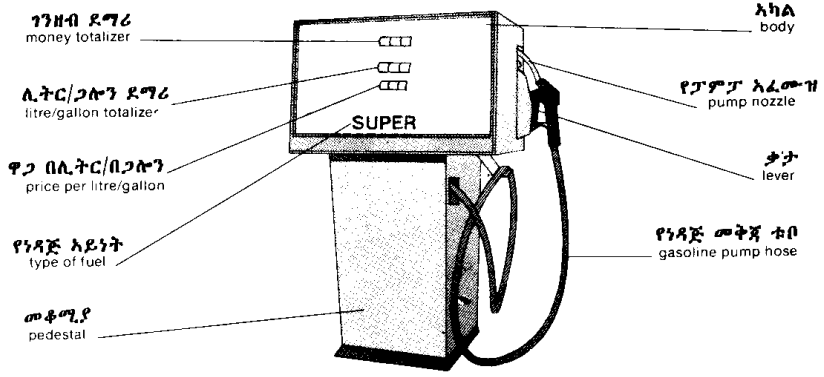

ተሳቢ
semitrailer

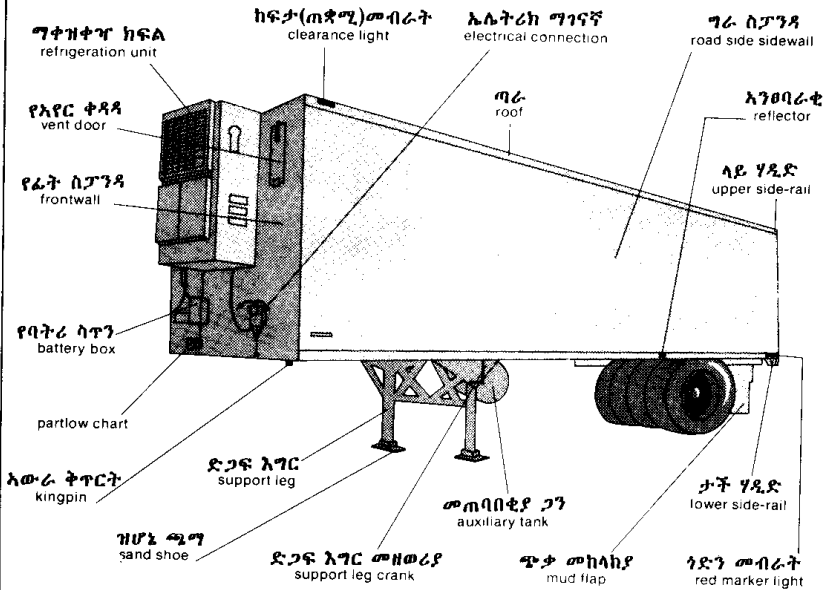

ግልጥ ግማሽ ተሳቢ
platform

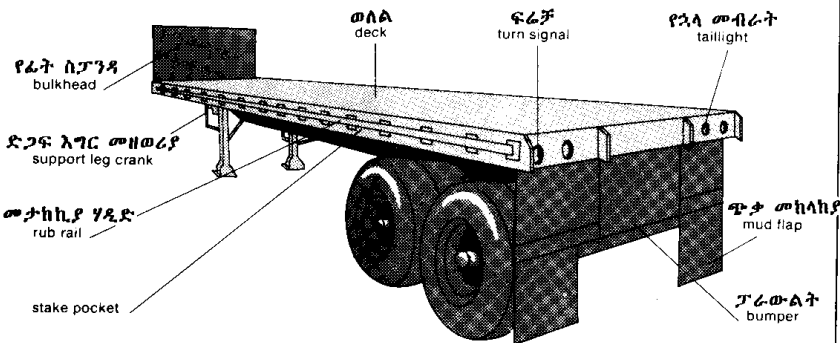

ጥተርኝ
engines

ዲዝል ጥተር
diesel engine

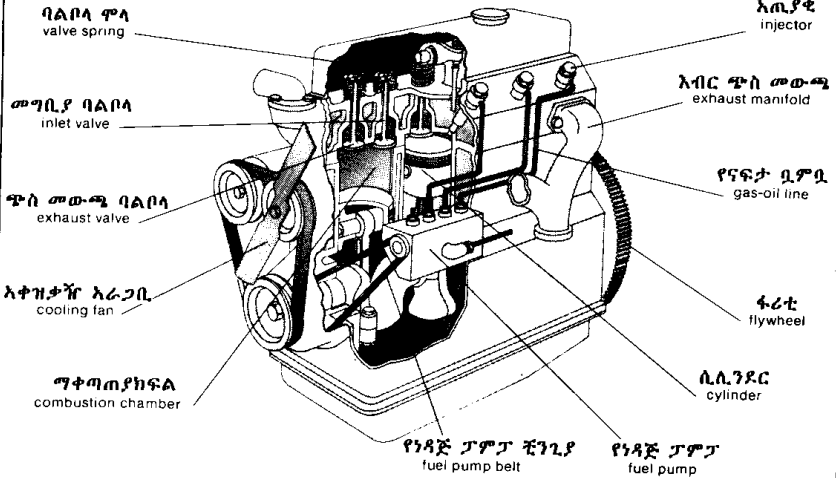

ቱርቢ አማቂ ጥተር
turbo-compressor engine

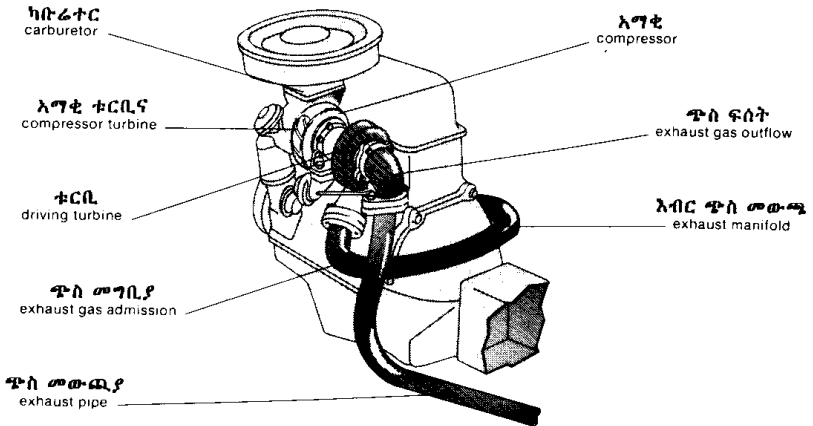

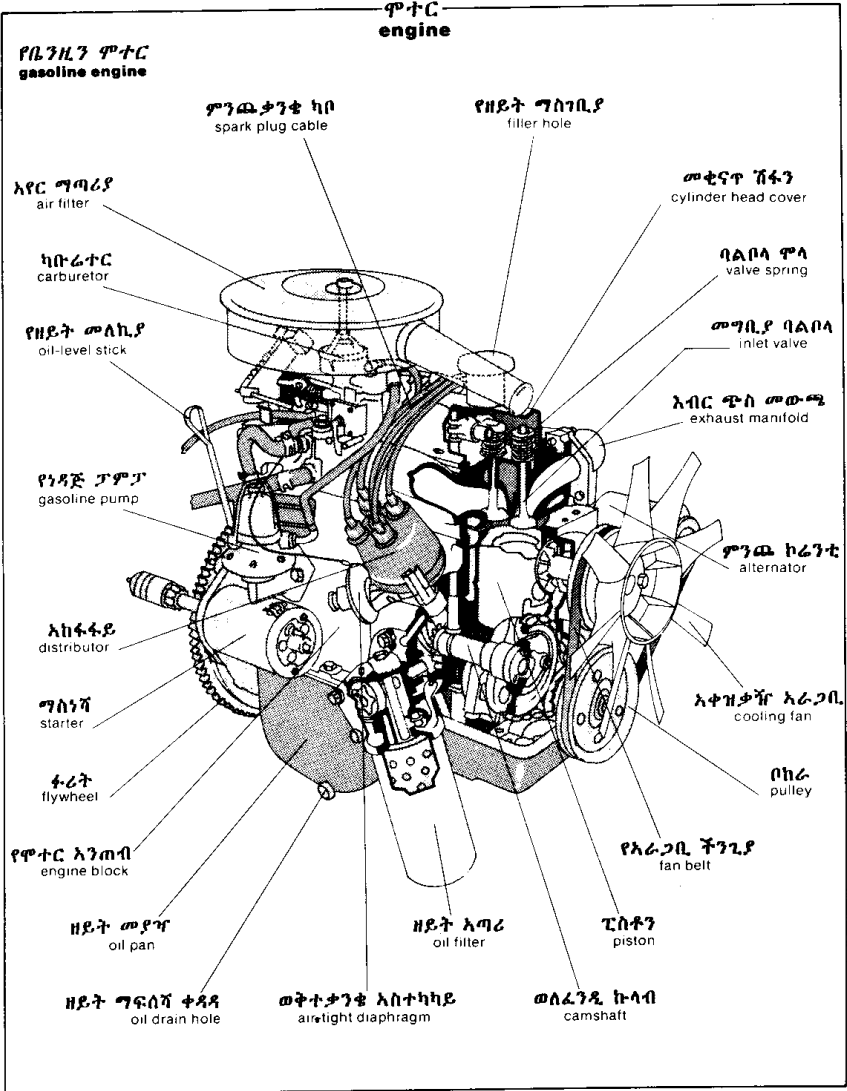

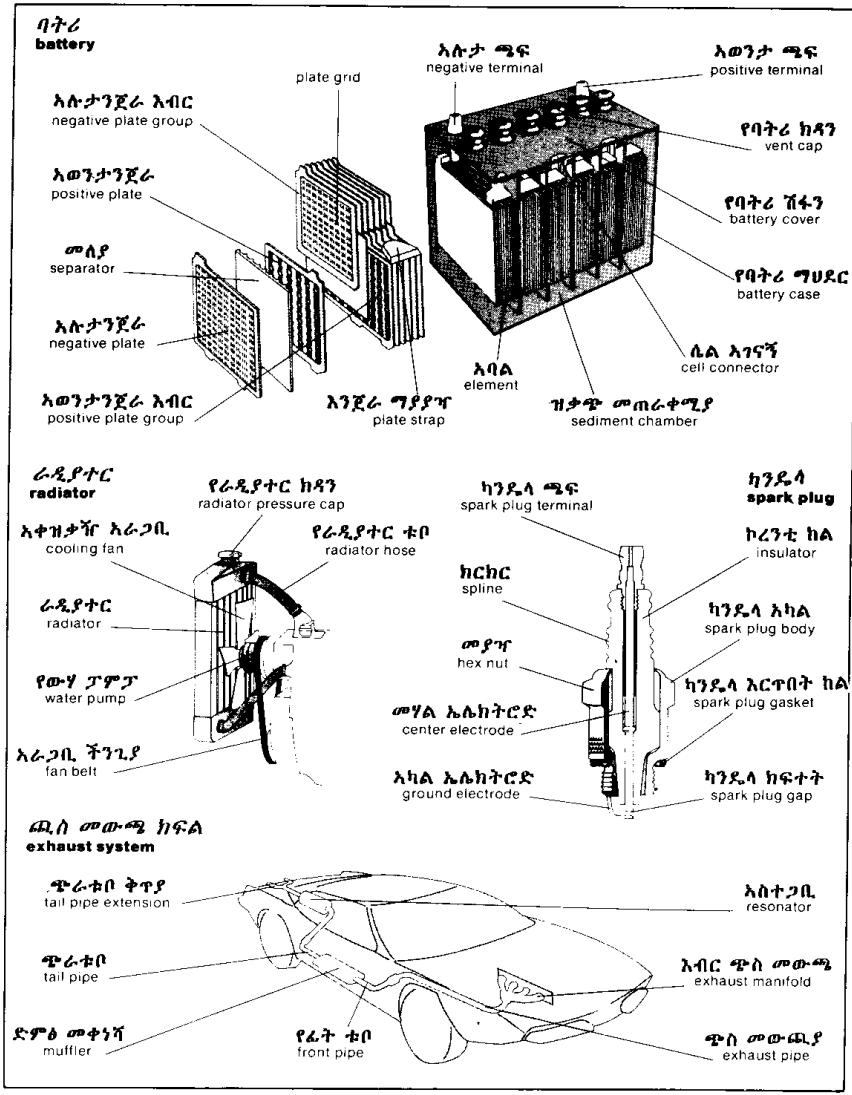

ጎማዎች
tires

በላቸ ድርብ ጎማ
bias-ply tire

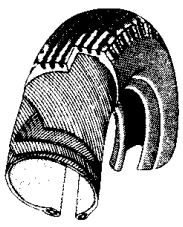

ራዲያል ጎማ
radial tire

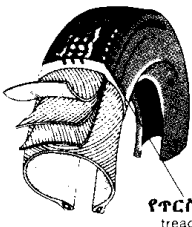

ጥምጥም ራዲያል ጎማ
belted radial tire

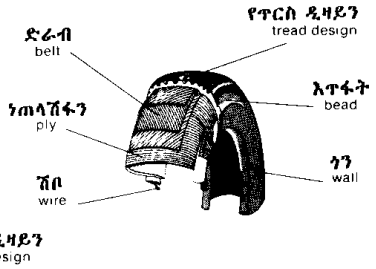

snow tire

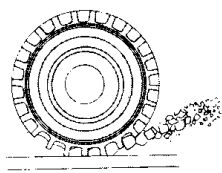

ሽከርካሪ
wheel

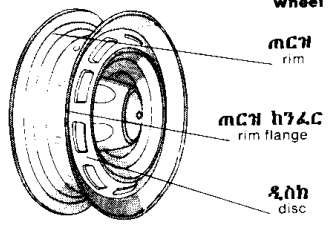

ታምቡር ፍራን
drum brake

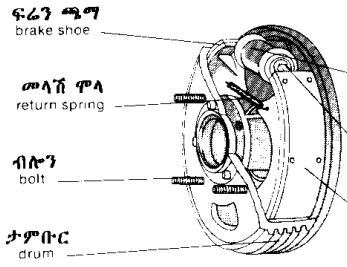

ፍራን ፍራን
brakes

ዲስክ ፍራን
disk brake

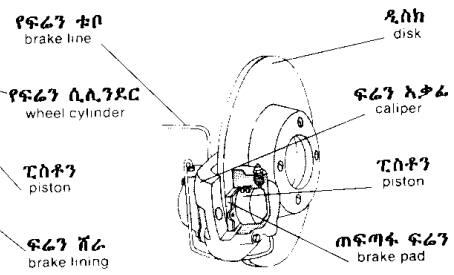

ሞተር ብስክሌት
motorcycle

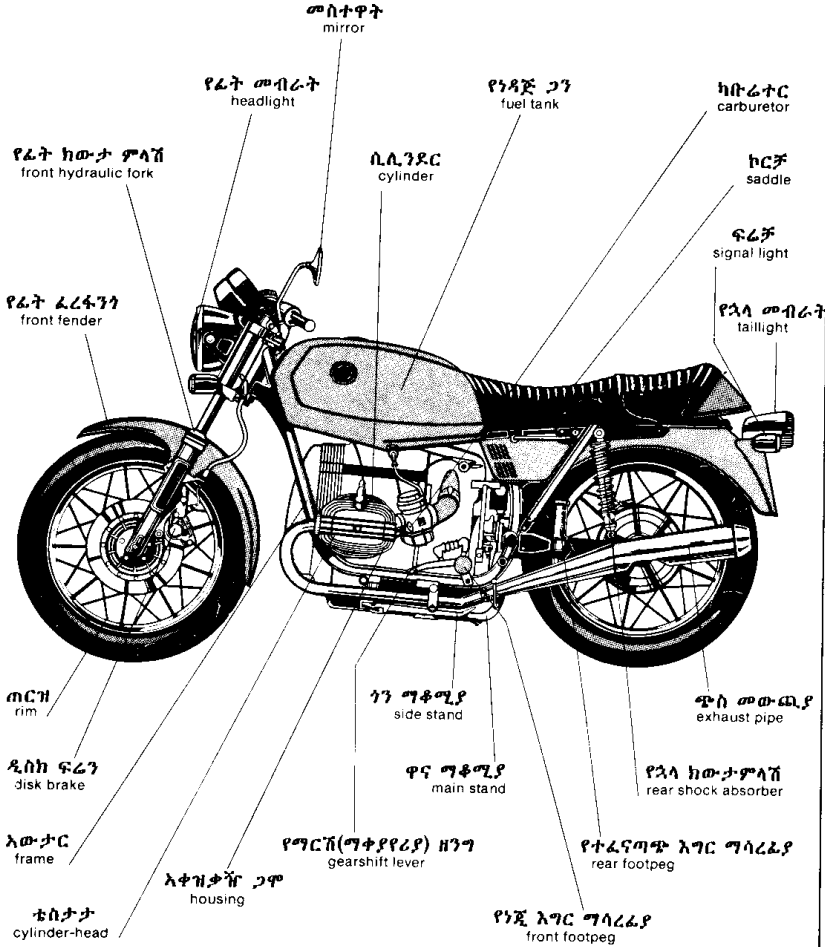

ሞተር ብስክሌት
motorcycle

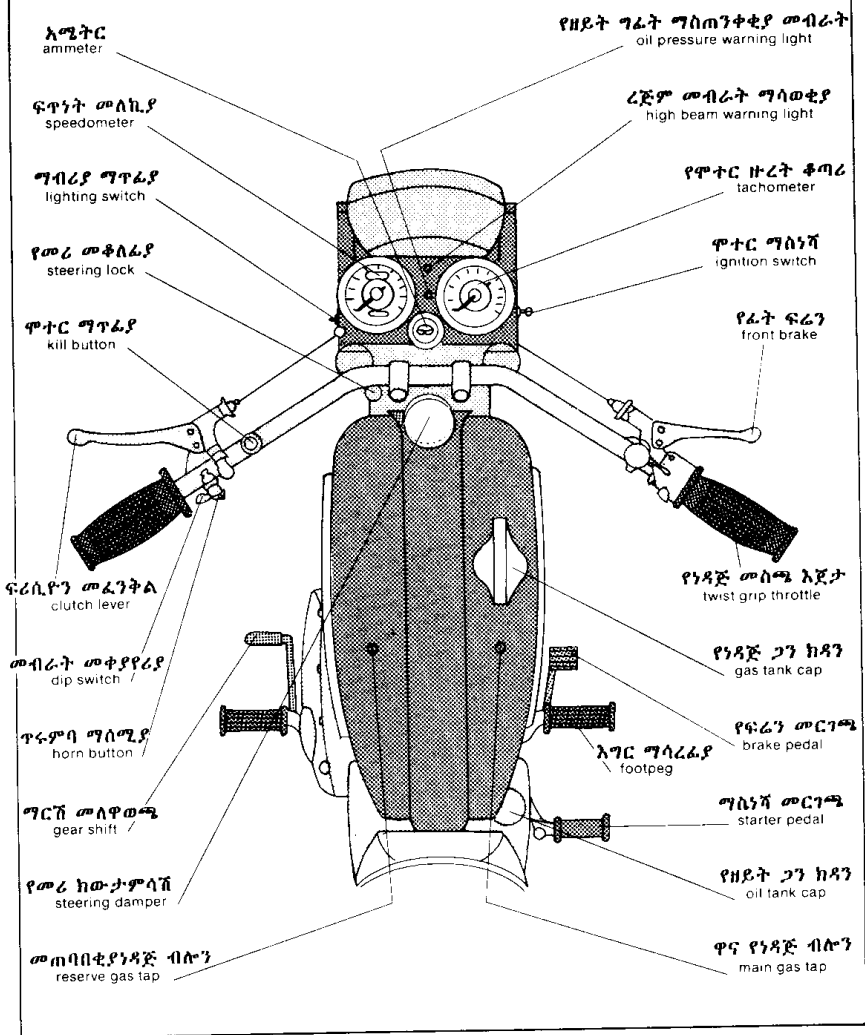

ብስክሌት
bicycle

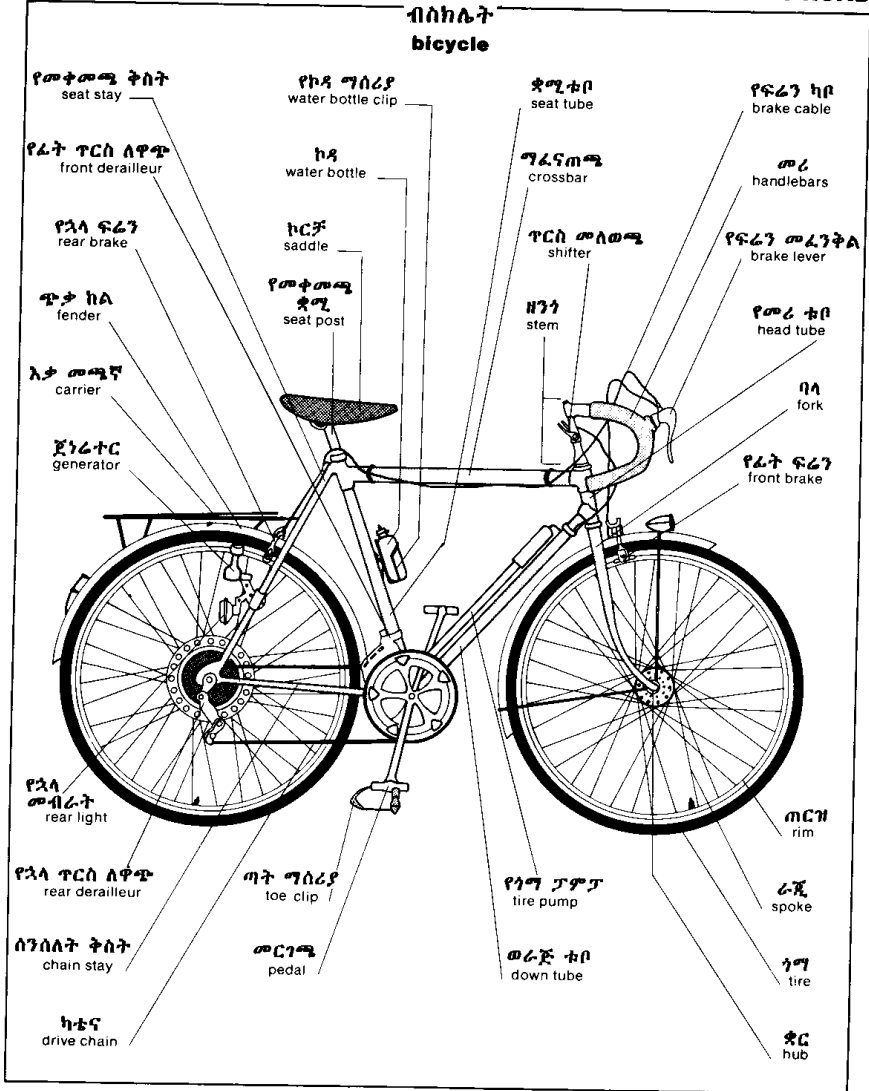

ብስክሌት bicycle

ጉልበት ማስተላለፊያ power train

ሰንሰለት chain

እባር ክራንች sprocket cluster

የሰንሰለት ቅስቀሴ መሪ chain guide

የፊት ፕሮስ ለዋዊ front derailleur

ፕሮስ መለወጫ shifter

ወጣሪ ተንከባይ tension roller

ሁለገብ ተንከባይ jockey roller

የሰንሰለት ማሽከርከሪያ chain wheel

ዘንግ bottom bracket axle

መቆጣጠሪያ ካቦ control cable

መዘወሪያ crank

መርገሜ pedal

ተጨማሪ accessories

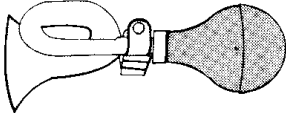

የብስክሌት ጥሩምባ bicycle horn

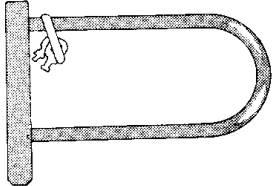

ቁልፍ lock

የጎጃና ምስል ክፉይ
cross section of a street

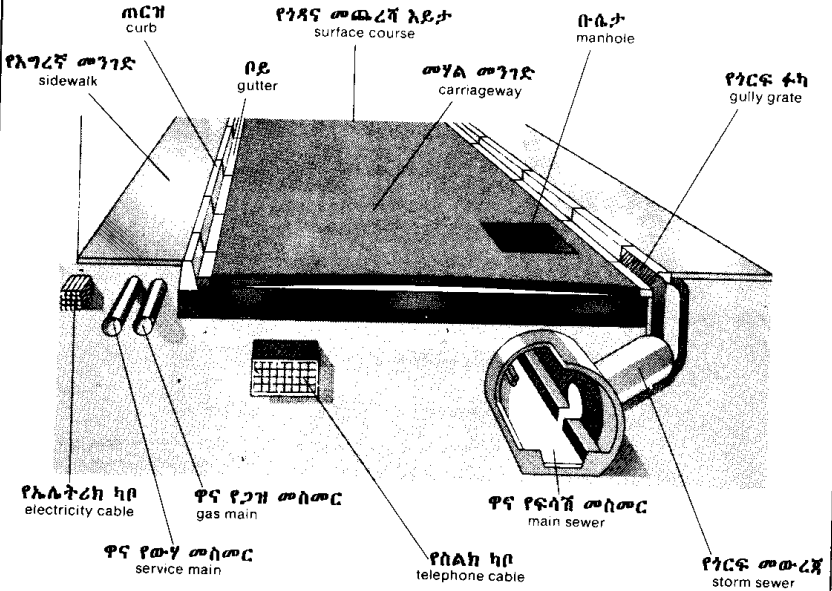

cross section of a road

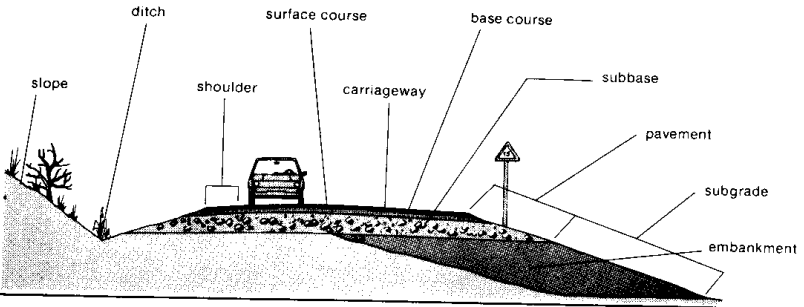

የገጽገሳተሰ ድልድቸ

fixed bridges

ግንጥ ገንጠ
beam bridge

አንድ ግንጥ
continuous beam

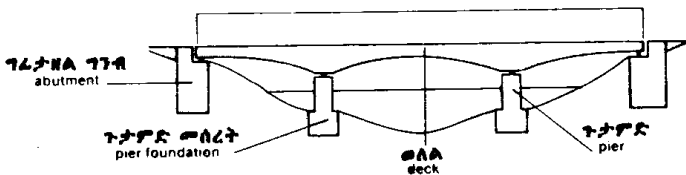

types of beam bridges

multiple-span beam bridge



simple-span beam bridge

overpass

viaduct

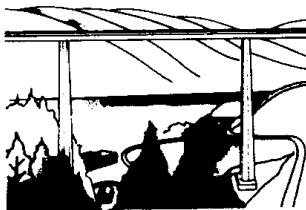
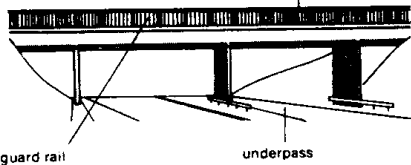

cantilever bridge

suspended span

cantilever span

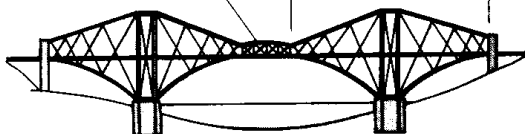

የግደንቀላቀሱ ድልድዮች
fixed bridges

ቅስት ድልድይ
arch bridge

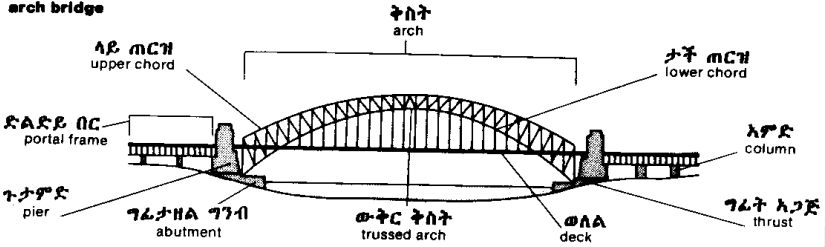

types of arch bridges

half-through arch bridge

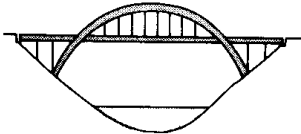

through arch bridge

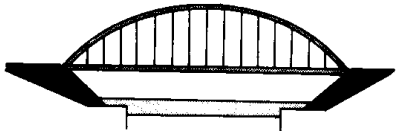

deck arch bridge

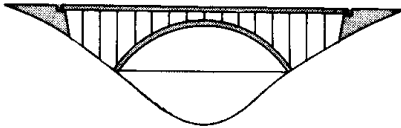

portal bridge

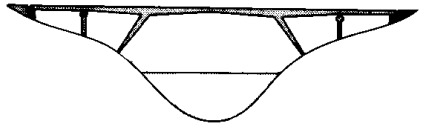

types of arches



fixed arch



two-hinged arch



three-hinged arch

የግድንቀሳቀሱ ድልድዮች
fixed bridges

ተንጠልጣይ ድልድይ
suspension bridge

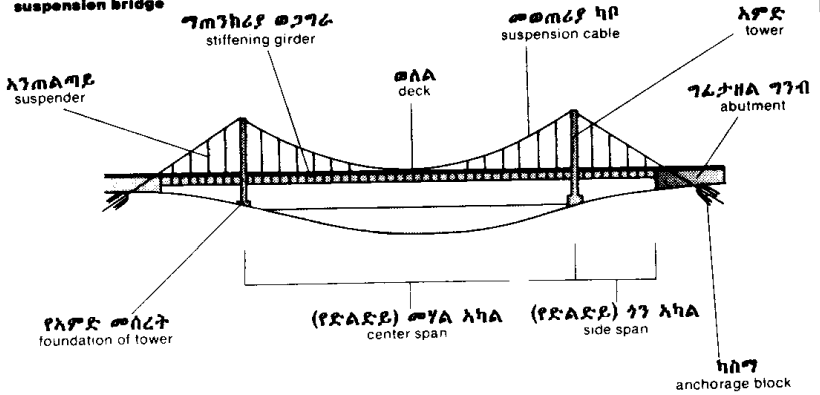

cable-stayed bridge

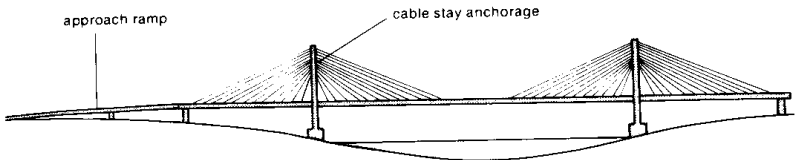

fan cable stays

harp cable stays

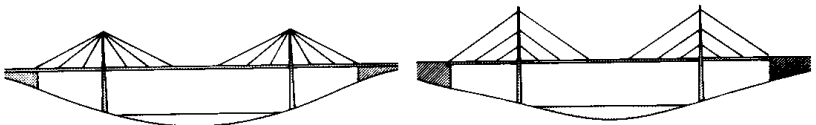

ተንቀሳቃሽ ድልድይ
movable bridges

አሳንሮ ድልድይ
lift bridge

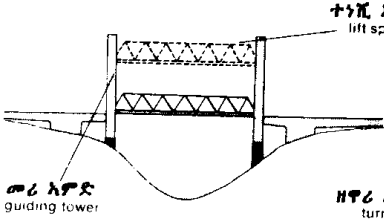

ተኮሮ ድልድይ
swing bridge

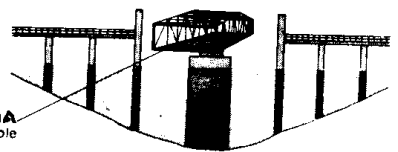

single-leaf bascule bridge

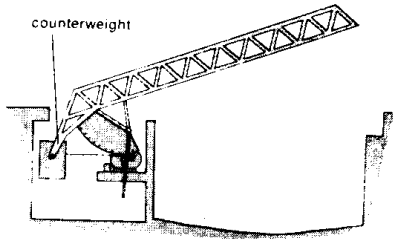

double-leaf bascule bridge



transporter bridge

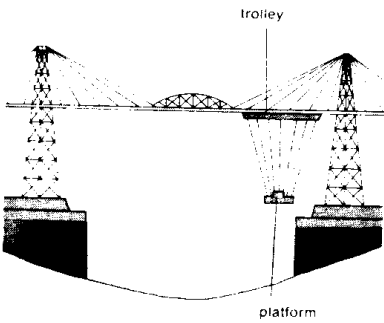

Bailey bridge



floating bridge



የእቃ ጋራ እይነቶች
types of cars

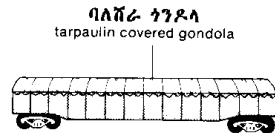
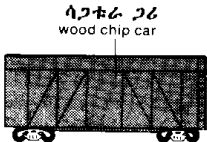
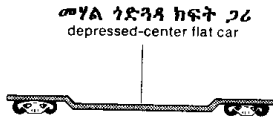
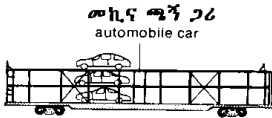
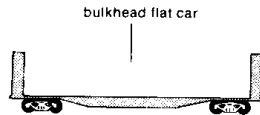
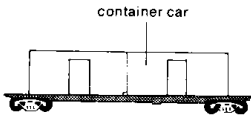
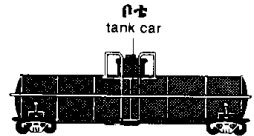
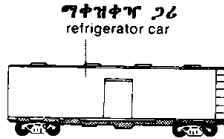
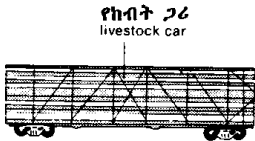
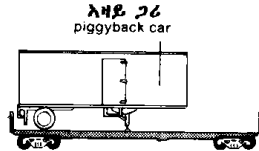
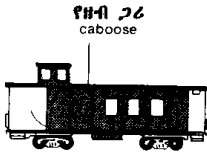
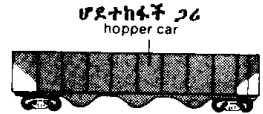
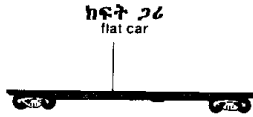
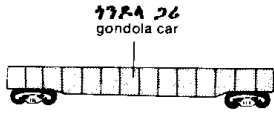

የባቡር መንገድ
railroad track

የባቡር መንገድ
railroad track

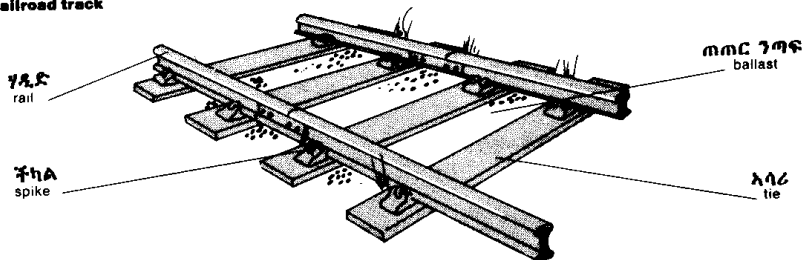

የሃዲድ መጋጠሚያ
rail joint

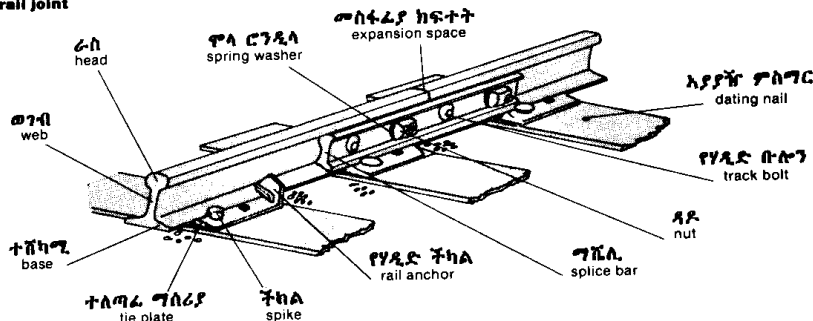

ጂጂ
manually-operated switch

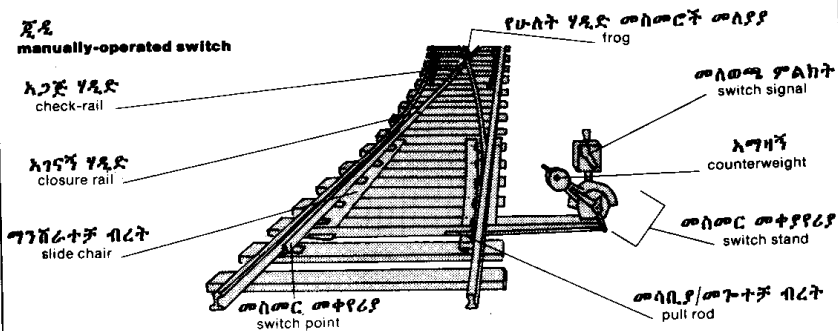

የባቡር መንገድ
railroad track

remote-controlled switch

electrically illuminated switch signal

channel

points motor

point wire

turnbuckle

stretcher bar

switch point lock

trough

ፖላስቶች
signals

አውራ ገዳና ግድረጫ
highway crossing

ገዳና ግድረጫ ፖላስቶች
crossbuck sign

ግጥሎች (+ገዳና)
peep hole

ግጥሞች ግድረጫ
flashing light

ግጥሞች ግድረጫ ግድረጫ
signal background plate

ግድረጫ ግድረጫ ግድረጫ
gate arm lamp

ግድረጫ ግድረጫ
gate arm

ግድረጫ ግድረጫ ግድረጫ
gate arm support

ተሸከሚ
base

አውራ ገዳና ግድረጫ ግድረጫ
highway crossing bell

ግድረጫ
pinnacle

ግድረጫ
mast

ግድረጫ
visor

ግድረጫ ግድረጫ ግድረጫ
junction box

ግድረጫ ግድረጫ ግድረጫ
number of tracks sign

አግዛዥ
counterweight

ግድረጫ ግድረጫ ግድረጫ
crossing gate mechanism

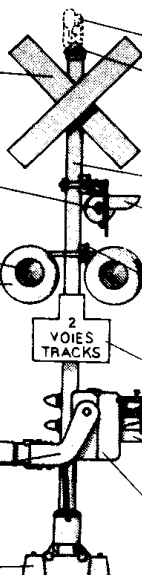

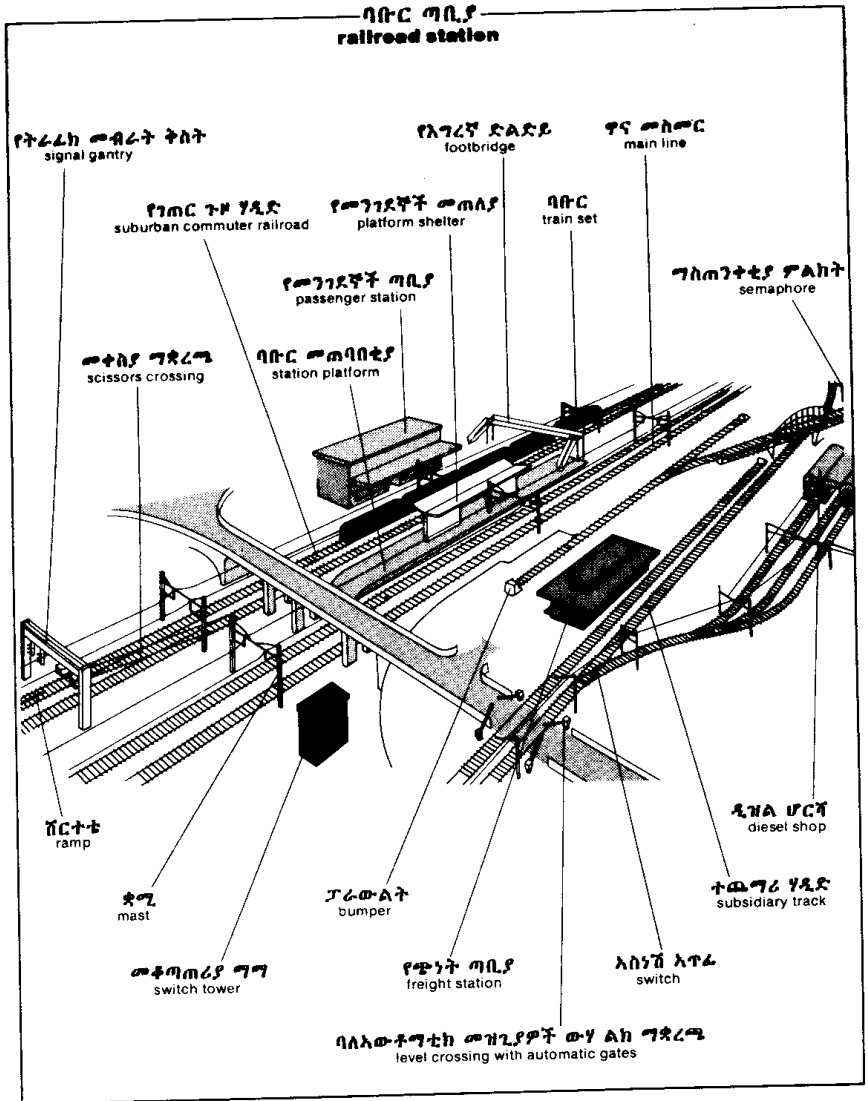

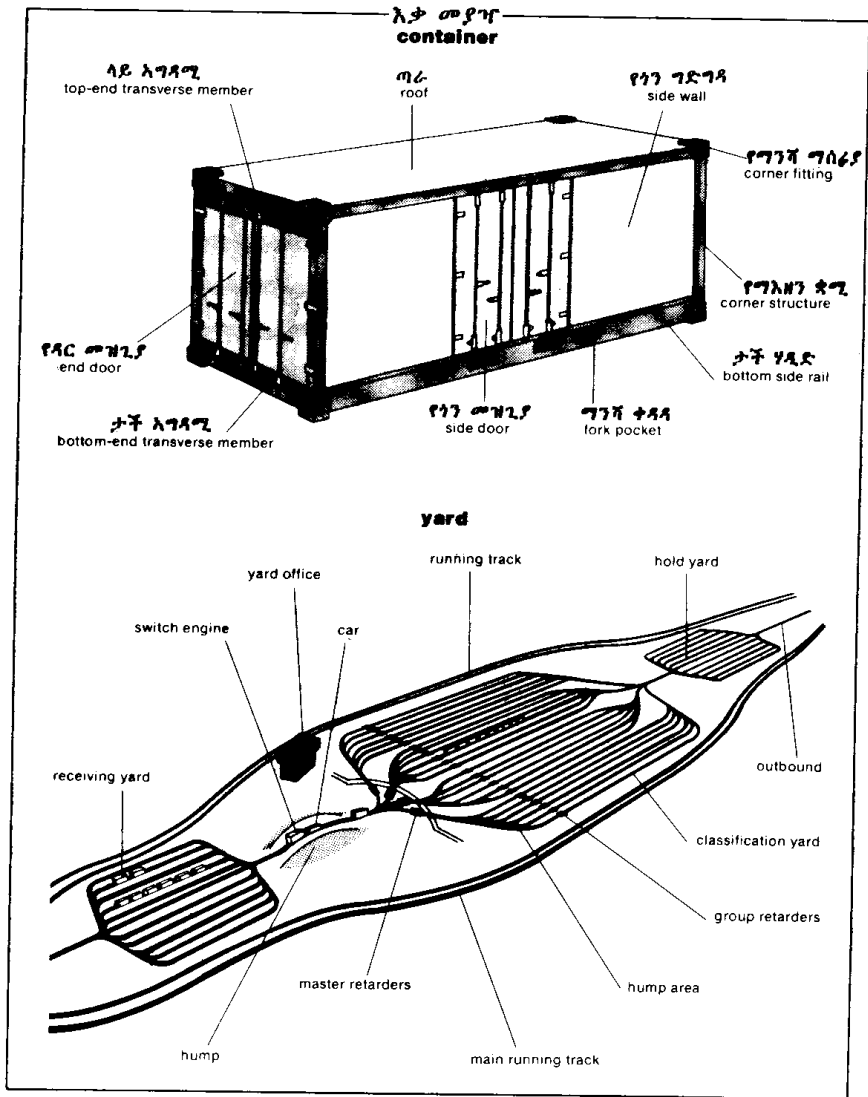

የመንገደኞች መርከብ
passenger liner

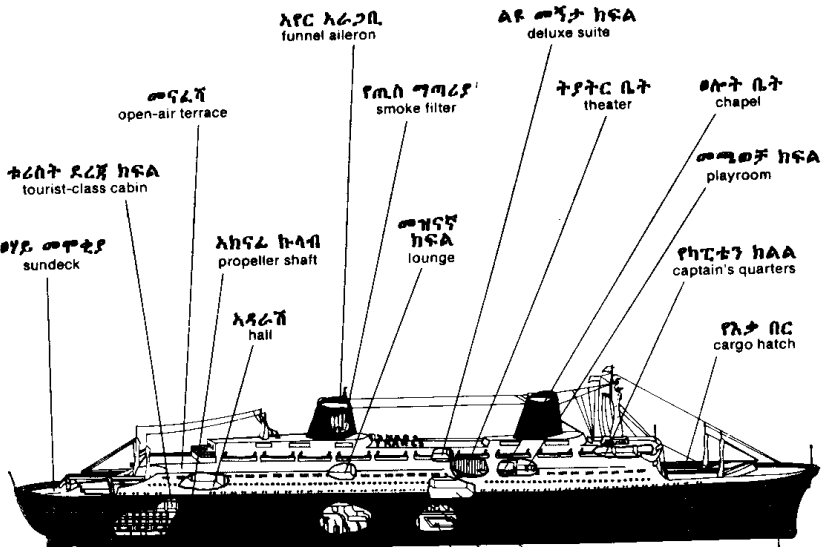

አየር አራጋቢ
funnel aileron

ልዩ ሙዥታ ክፍል
deluxe suite

መናፈሻ
open-air terrace

የጤስ ግጣሪያ
smoke filter

ትያትር ቤት
theater

ፀሎት ቤት
chapel

ቀሪስት ደረጃ ክፍል
tourist-class cabin

መጫወቻ ክፍል
playroom

ፀሃይ መጥቂያ
sundeck

አክናፊ ኩላብ
propeller shaft

መዝናኛ ክፍል
lounge

የካፒቲን ክፍል
captain's quarters

አዳራሽ
hall

የእቃ ቦር
cargo hatch

ጋራሽ
garage

የመላህት መጣያና ግንባ ክፍል
anchor-windlass room

የመርከቦች ክፍል
crew quarters

ፖግብ ቤት
dining room

ጭነት መያዣ
freight hold

የወይን ጠጅ ክፍል
wine cellar

አክናፊ
propeller

ግፍያዎች
boilers

አንደኛ ግሊረግ መዋኛ
first-class swimming pool

አትጣጫ መለጠጫ
rudder

ያላ ርጋታ ጋዋ
aft stabilizer fin

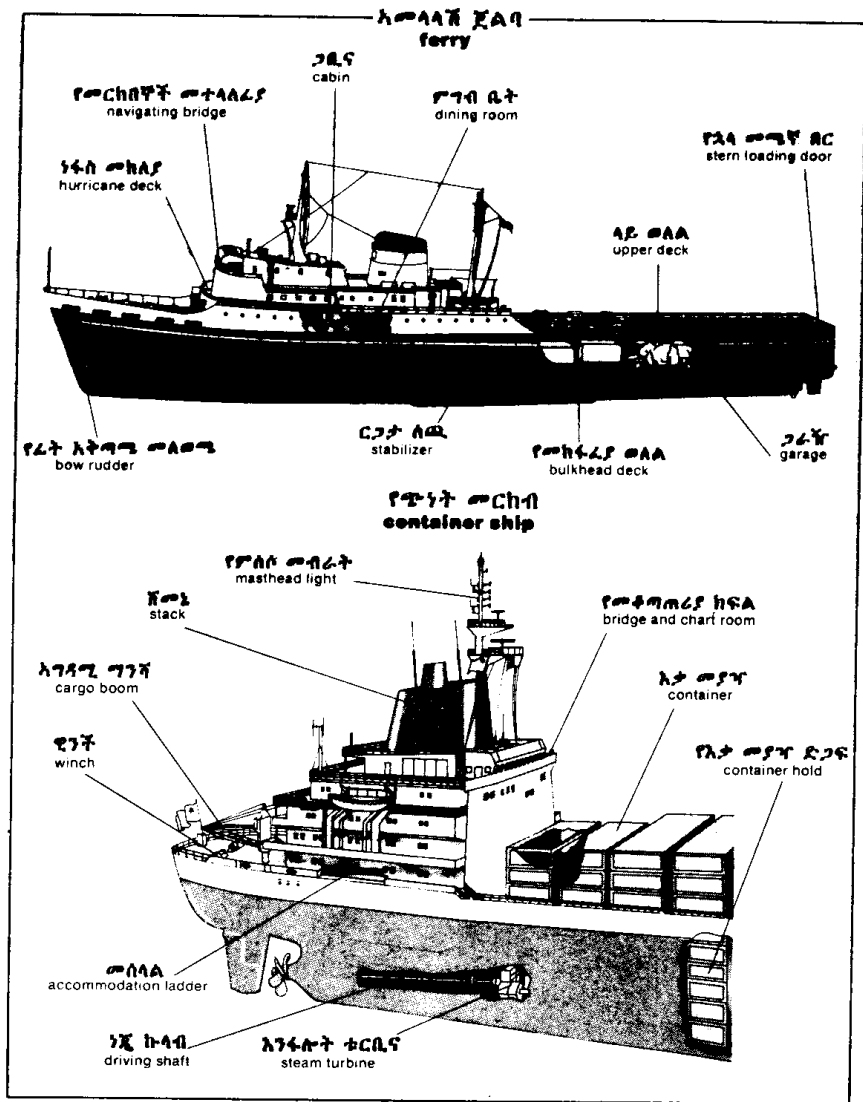

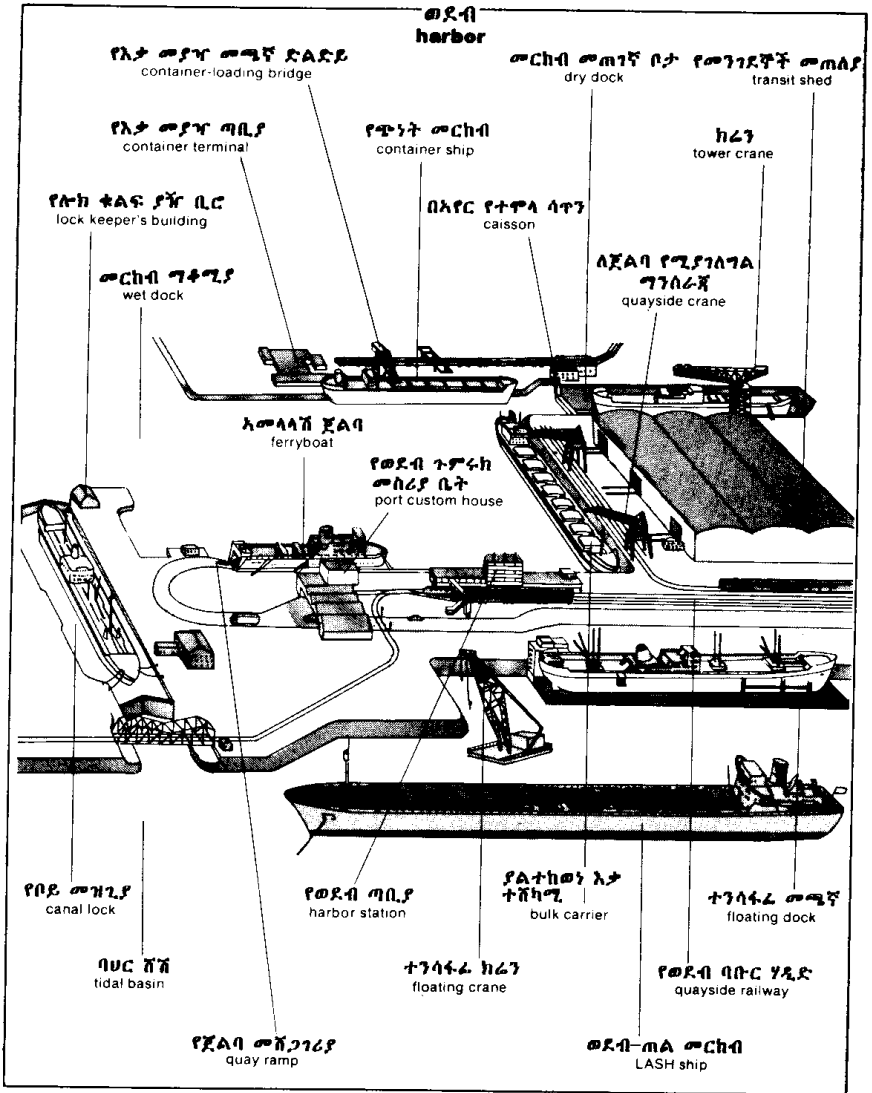

የባህር ጉዞ መሳሪያዎች
navigation devices

ድምፅ አስተታቢ መሳሪያ
echo sounder

ዲያል አሰልፋኝ
dial-type display

አቃፊ
housing

ተጸካጊ
bracket

ጠክሎ
on-off switch

ጸካፊ አገራር
knurled button

ድምፅ ግስተካኪያ
tuning control

ጥንድጥርስ ብሎጊ
stud

ጻጺ
nut

አስተታቢ ሊቃ
transducer

ተቀባይ አሰልፋኝ
receiver-indicator

አስተታቢ ሊቃ
transducer

የገደል ግግተ
acoustic echo

የድምፅ ትርጉ
pulse of sound

cable

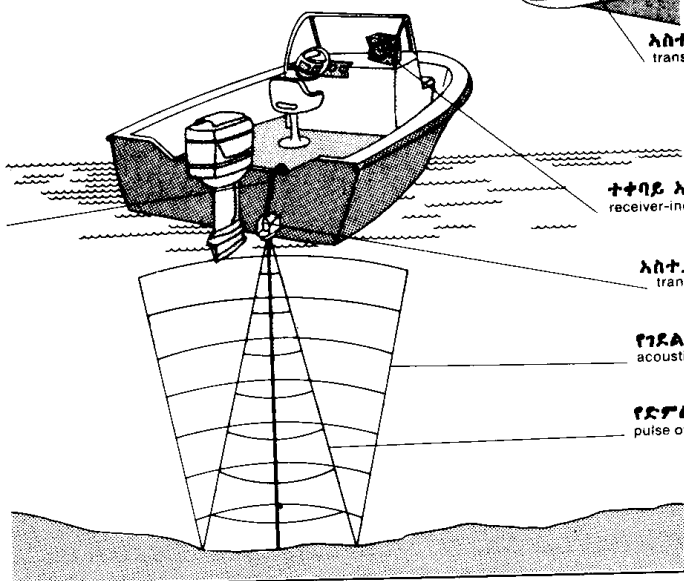

የባህር ጉዞ መሳሪያዎች
navigation devices

ለብግሊዝ መለኪያ
sextant

ግጥሪያ
filter

እድግስ ጫሳ
horizon glass

ግጥሪያ
filter

እርዳ
scale

ግስተካክያ መስተዋት
index mirror

ቴሌስኮፕ
telescope

እውታር
frame

ግስተካክያ እጅታ
index arm

የግድከርግትር ግስተካክያ
micrometer drum

ባለፈላሽ ኮምፓስ
liquid compass

የኮምፓስ ካርድ
compass card

መስተዋት ደዎ
glass dome

ውሃልክ ተለበት
gimbal ring

የቁመትዮሽ እመልካች መስመር
lubber's line

ካርድ ተሸካሚ
jewel cap

pivot

የመሙያ ክፍን
filler plug

float

ጎድጓዳ ላህን
bowl

የቁመትዮሽ እመልካች መስመር ክብ እቃ
lubber's line disk

መስፋፋያክፍል
expansion chamber

መግንጢስ
magnet

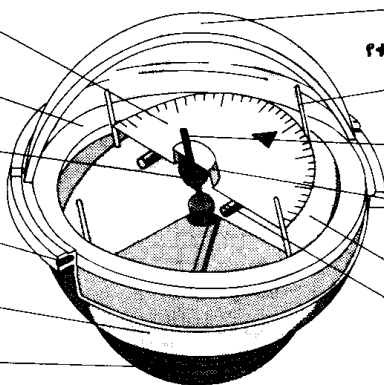
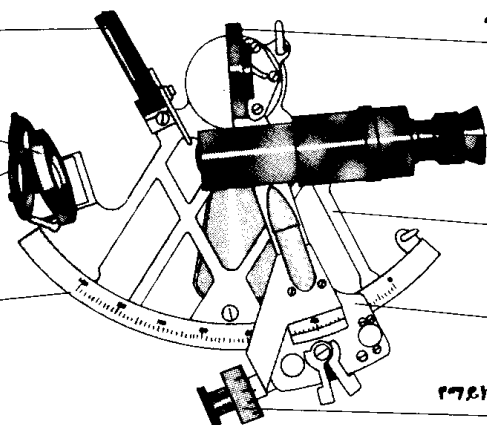

የባህር ላይ የሥልጣት
maritime signals

ተንባፋፊ የሥልጣት
buoys

ከፍተኛ ተንባፋፊ መብራት
high focal plane buoy

ተንባፋፊ ብርጭቶ
can buoy

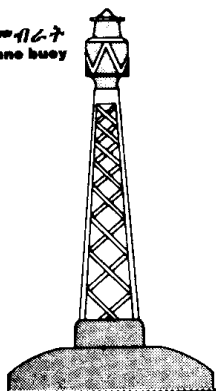
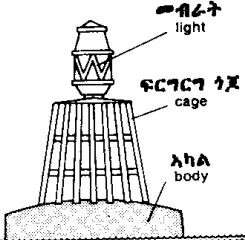

ትምብብ ተንባፋፊ
conical buoy

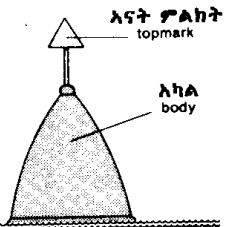

የሰበ የሥልጣት
pole beacon

ደምፅ ሰጪ ተንባፋፊ
whistle buoy

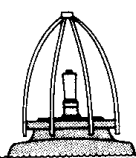

ተንባፋፊ ደወል
bell buoy

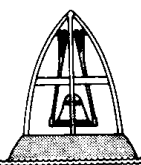

ሰንጠረዥ የሥልጣት
checkers

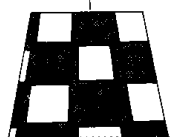

ሽንትር የሥልጣት
stripes

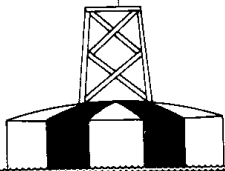

ጥምጥም የሥልጣት
bands

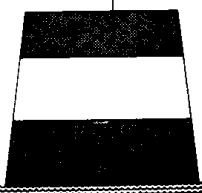

የባህር ላይ ምልክቶች
maritime signals

መብራት ቤት
lighthouse

ዋና የምልክት አሰጣጥ ዘዴ
cardinal system of marking

ጉብታ
cupola

የፋናስ መስተዋት
lantern pane

ፋናስ
lantern

ፍርገርግ አቃፊ
astragal

ሰንገት
gallery

ጊወራት
murette

አገልግሎት መስጫ ክፍል
service room

መኝታ ክፍል
bedroom

የመኖሪያ ክፍል
living quarters

መቆጣጠሪያ ክፍል
control room

የነጻጽ ጋን
fuel tank

የሃይል ግጥሚያዎች
power generators



ሁለት ትምብቦች ጫፋቸው ወደላይ
two cones point upward



ሁለት ትምብቦች ጫፋቸው ወደታች
two cones point downward



ሁለት ትምብቦች ጫፍ ለጫፍ
two cones point to point



ሁለት ትምብቦች መቀመጫ ለመቀመጫ
two cones base to base

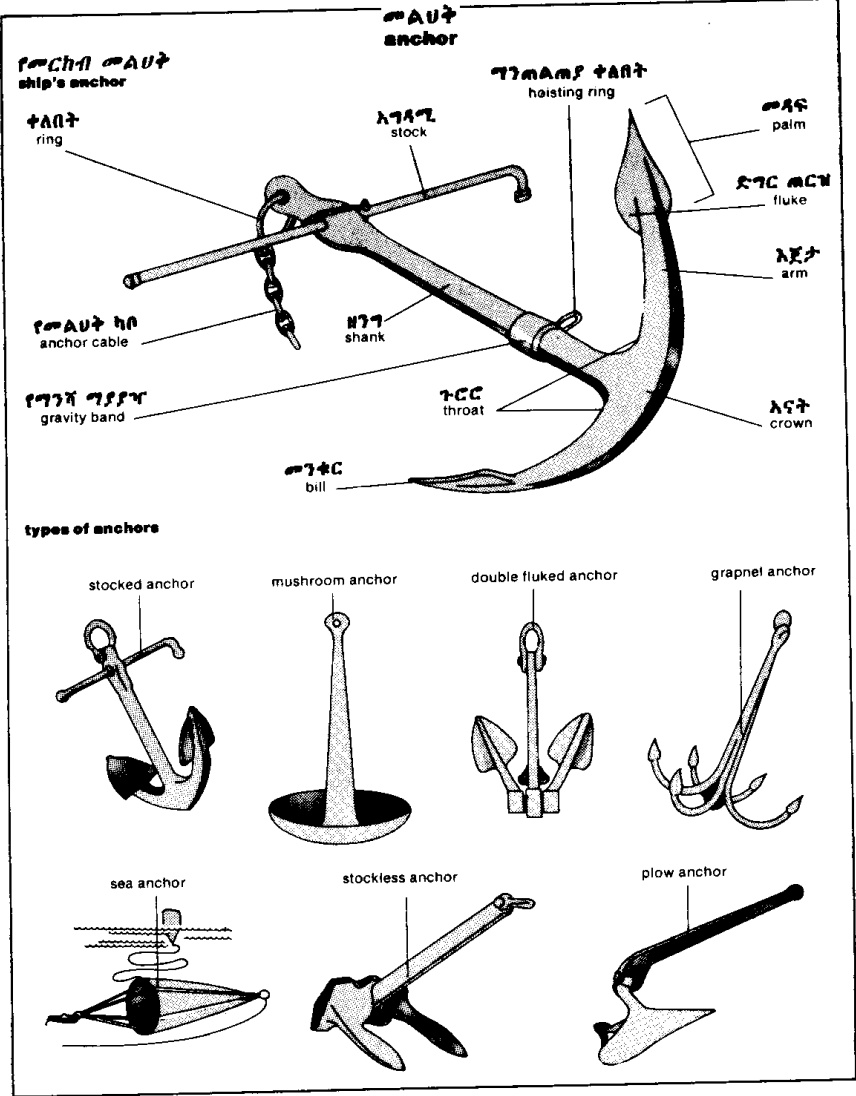

ቶርቦጅት ፎታር
turbo-jet engine

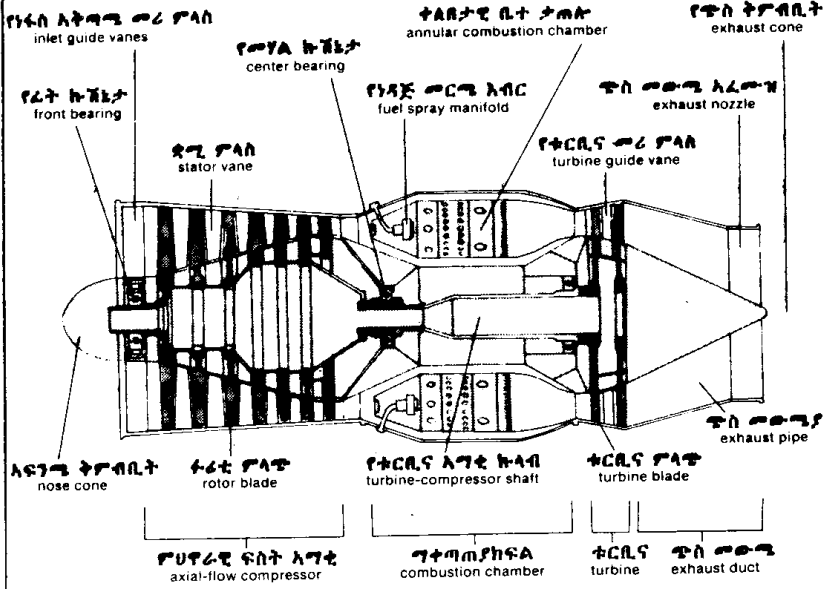

turbofan engine

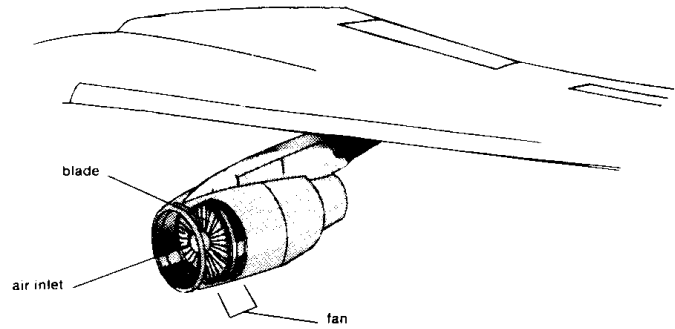

የቦረራ መቆጣጠሪያ ክፍል
flight deck

አውቶግሬትክ አብራራ መቆጣጠሪያ
autopilot control

ያናት ግብሪያ ሰሌዳ
overhead switch panel

የመቆጣጠሪያ መረገጥ
control levers

አትዎ መቆጣጠሪያ መሳሪያዎች
power plant instruments

ነፋስ ከላ
windshield

የቦረራ መሳሪያዎች
flight instruments

ዋና የመሳሪያዎች ሰሌዳ
central instrument panel

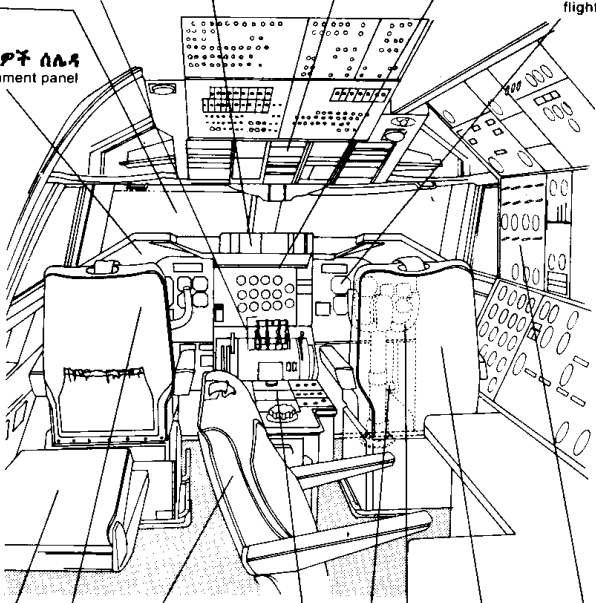

የተመልካች መቀመጫ
observer's seat

መሃል መደብ
central console

የቦረራ መሃንዲስ ሰሌዳ
flight engineer's panel

የካፒቲን መቀመጫ
captain's seat

የአትጣጫ መለወጫ መርገጫ
rudder pedal

የረዳት አብራራ መቀመጫ
first officer's seat

የቦረራ መሃንዲስ መቀመጫ
flight engineer's seat

መቆጣጠሪያ ፖስት
control column

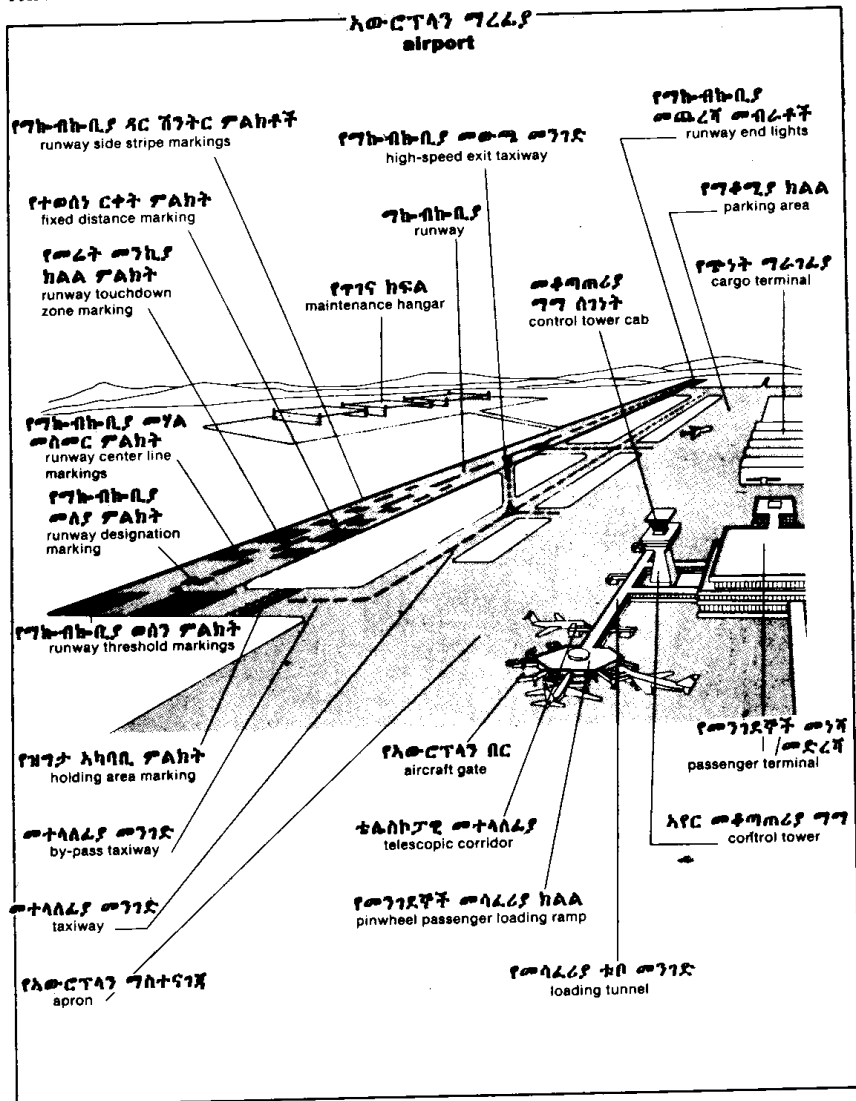

አውርፕላን ግረጊያ
airport

የአውርፕላን ግረጊያ መሳሪያዎች
ground airport equipment

የግብ አትራቢ ተሽከርካሪ
catering vehicle

ጎን አላላሽ
baggage conveyor

የመጠ ውሃ አትራቢ ተሽከርካሪ
potable water truck

ባለ-ሰላላ የጥንት ተሽከርካሪ
boom truck

ሽንት ቤት መጣጥ ተሽከርካሪ
lavatory truck

የመንገዶች ግድረሻ
passenger transfer vehicle

ጎጃ የጊዮላ ተሽከርካሪ
jet refueler

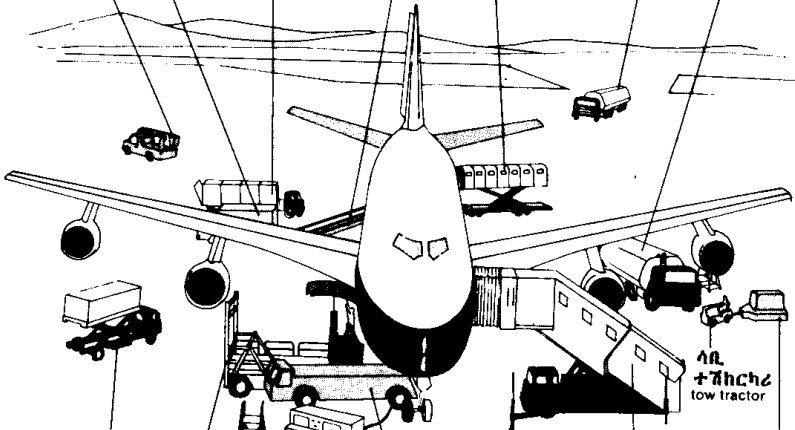

ወለላ ግስተካክያ ተሽከርካሪ
truck level floor

ፓሌትና እቃ መያዣ ግጓጓዣ
pallet and container transporter

የመንገዶች መሰላላ
universal step

ሳቢ ተሽከርካሪ
tow tractor

የጎን ግላላሽ ተሳቢ
baggage trailer

ተንተላታሽ የመንገዶች መሰላላ
mobile passenger escalator

የኮረንቲ ሃይል ምንጭ
electrical power unit

ታኮ
wheel chock

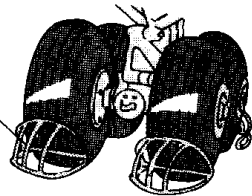

የመገንደኞች መጓገቢያ/መድረሻ
passenger terminal

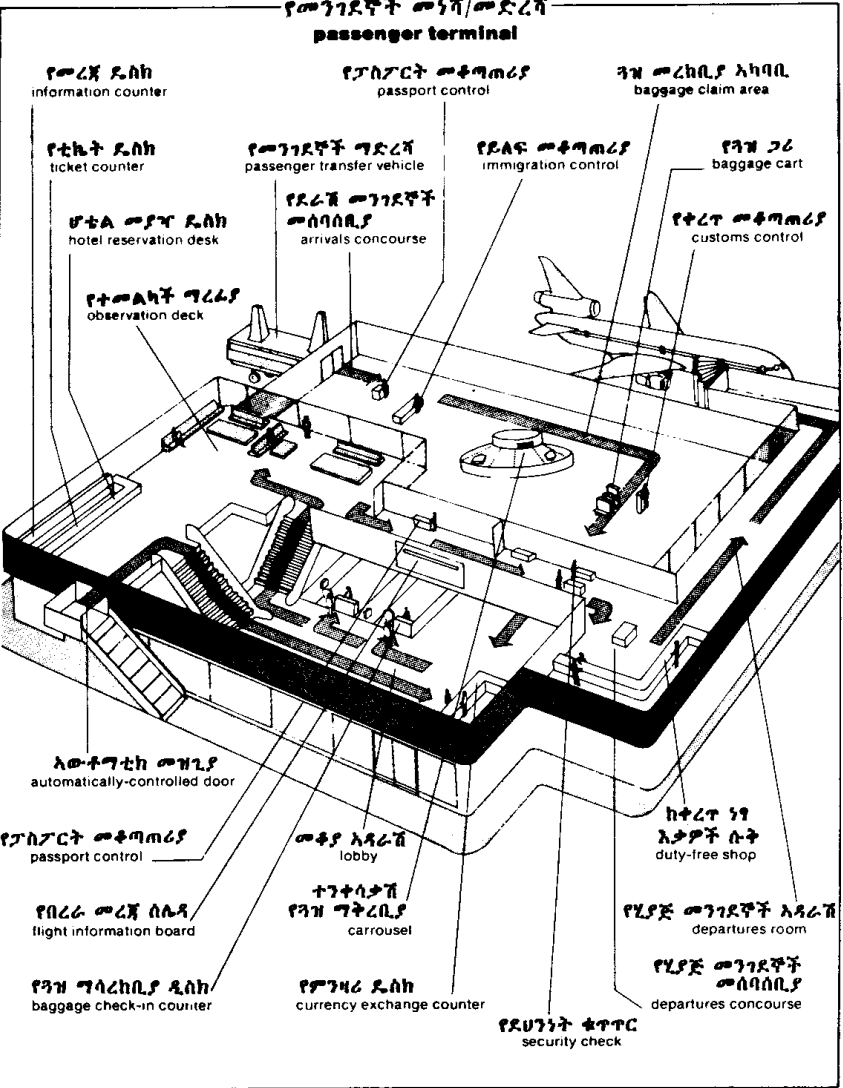

የመረጃ ዴሳስ
information counter

የፓስፖርት መቆጣጠሪያ
passport control

ጓዥ መረከቢያ አካባቢ
baggage claim area

የቲኬት ዴሳስ
ticket counter

የመገንደኞች ግድረሻ
passenger transfer vehicle

የይገዳ መቆጣጠሪያ
immigration control

የጓዥ ጋራ
baggage cart

ሆቴል መያዣ ዴሳስ
hotel reservation desk

የደራሽ መገንደኞች
መሰባሰቢያ
arrivals concourse

የቀረጥ መቆጣጠሪያ
customs control

የተመልካች ግረሬያ
observation deck

አውቶግሬቲክ መዝጊያ
automatically-controlled door

የፓስፖርት መቆጣጠሪያ
passport control

መቆያ አዳራሽ
lobby

ከቀረጥ ነፃ
እቃዎች ስቶ
duty-free shop

የበረራ መረጃ ሰሌዳ
flight information board

ተጓጎላታሽ
የጓዥ ግቅረቢያ
carrousel

የሂያጅ መገንደኞች አዳራሽ
departures room

የጓዥ ግላረከቢያ ዲሳስ
baggage check-in counter

የጭንፋራ ዴሳስ
currency exchange counter

የሂያጅ መገንደኞች
መሰባሰቢያ
departures concourse

የደህንነት ቁጥጥር
security check

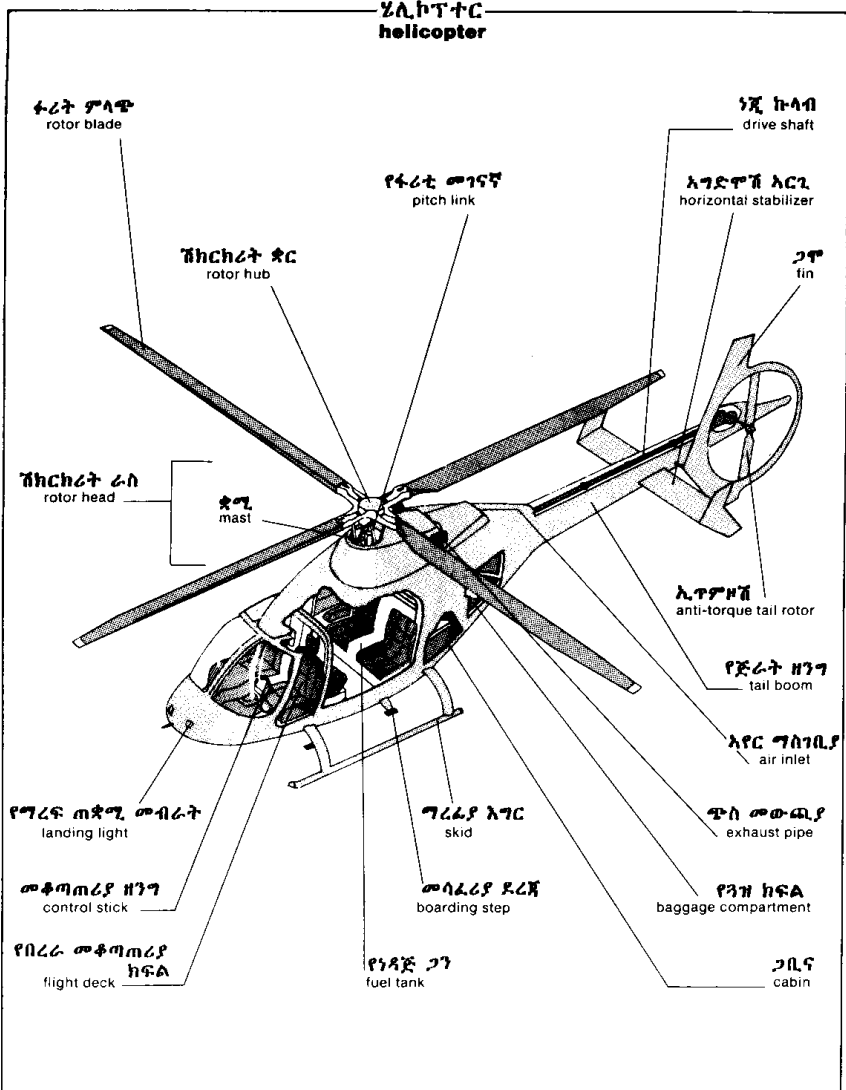

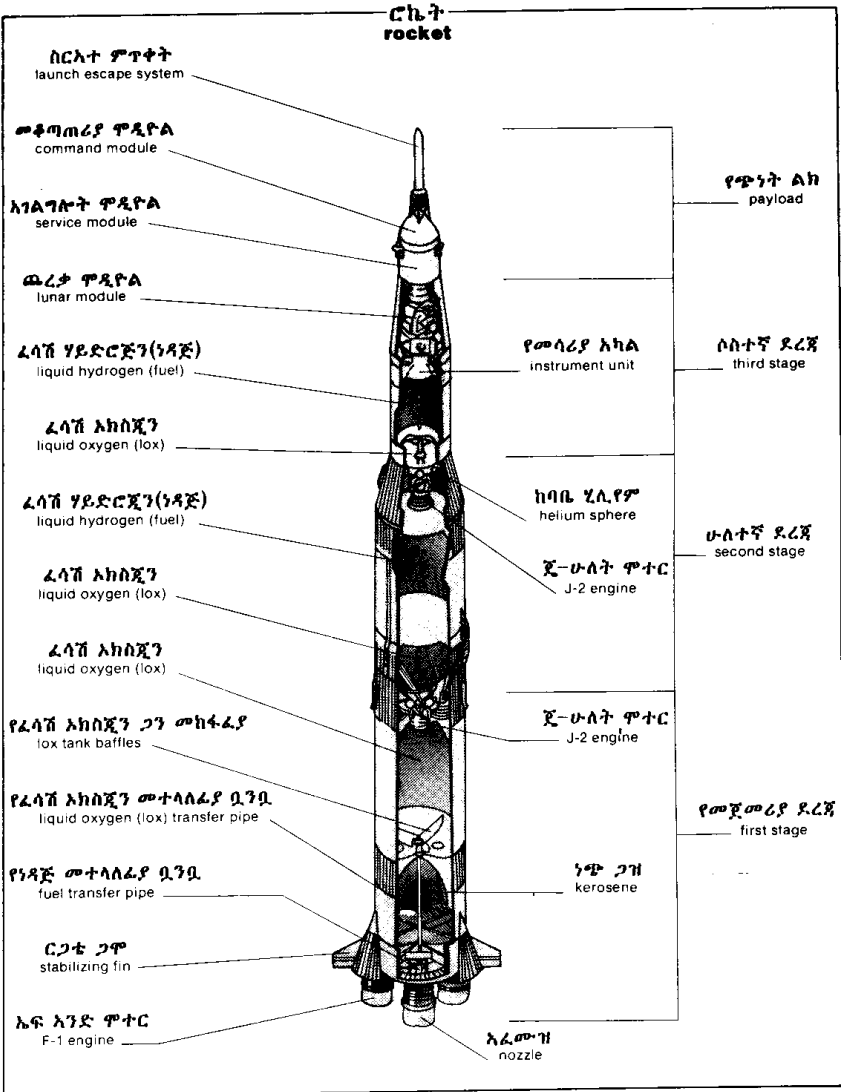

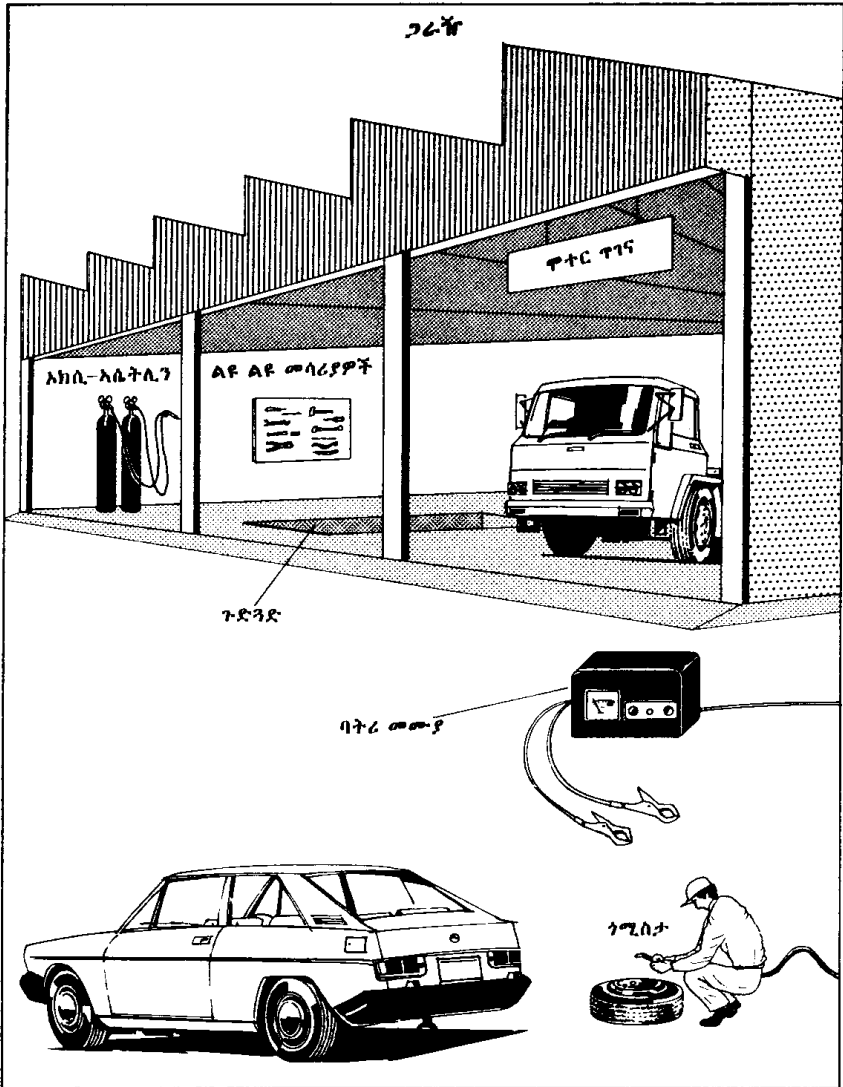

ጋሪ

