

አትክልት ስራ
GARDENING

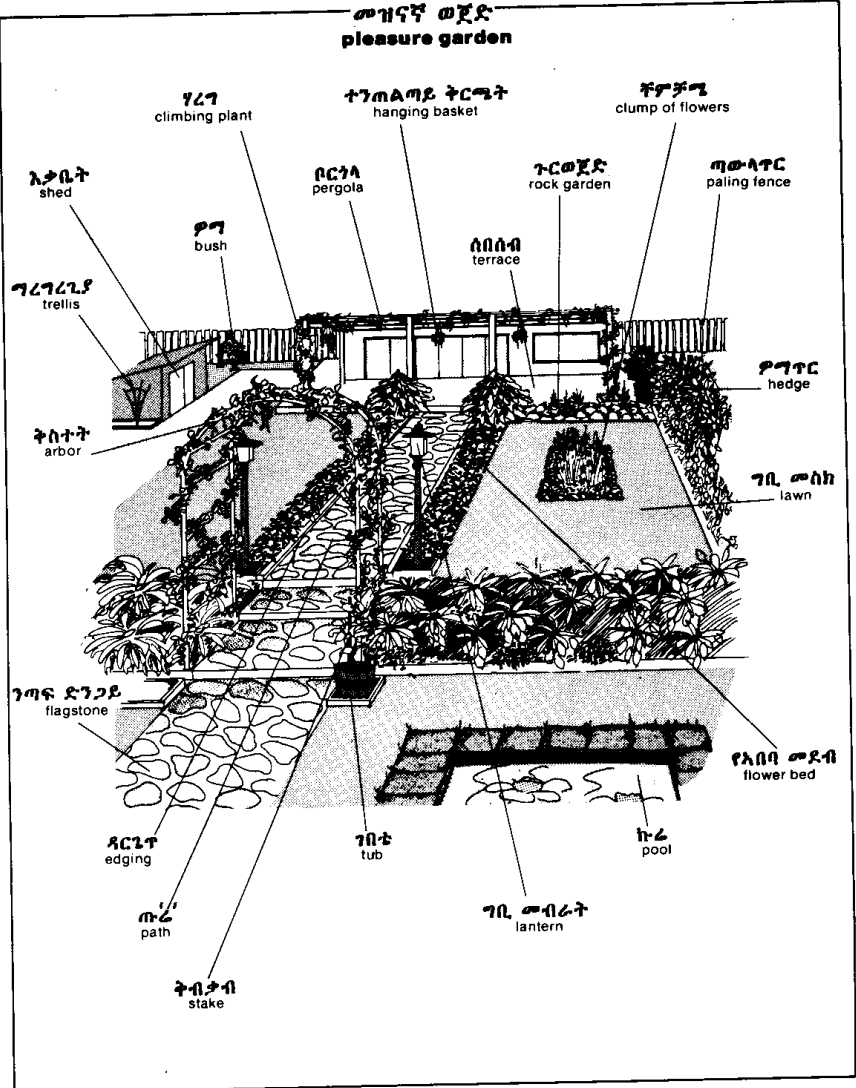

የእጅ መሳሪያዎች
tools and equipment

አካፋ
shovel



መቀፈሪያ አካፋ
spade



ወረወረ መጠርክገሪያ
lawn edger



መንሽ
spading fork

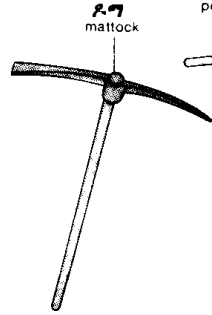

ደግ
mattock

ቆፍርዛት
post-hole digger

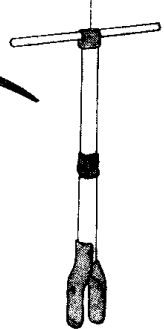

ራክ
rake

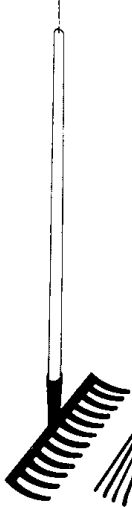

መያዥ
lawn rake



ቆላፋ መንሽ
hook



ተገፈ መኮኮኮች
scuffle hoe



መኮኮኮች
hoe



መኮኮኮች
garden hoe



ደርጣት
weeding hoe



ደግት
hoe-fork

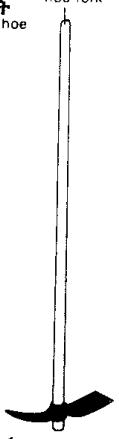

የእጅ መሳሪያዎች
tools and equipment

ግጉርጥ
small hand cultivator



ግንቆሪያ
dibble



ግረጫያ
weeder

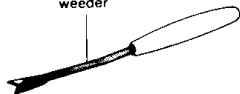

አካፊት
trowel

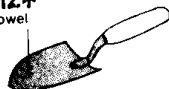

መንሸት
hand fork

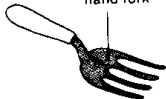

መተለጫያ
garden line



መደንቁያ
bulb dibble

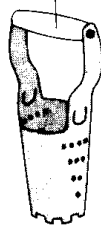

መዝሪያ
seeder



መግረዥያ
pruning shears

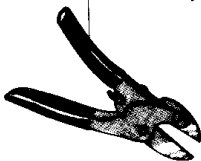

መመልመያ
tree pruner



ወንቃፍ
pruning hook

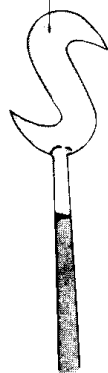

መቀንጠሺያ
lopping shears

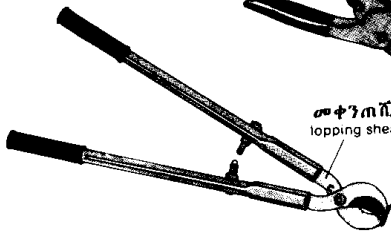

መከረካጫ
hedge shears

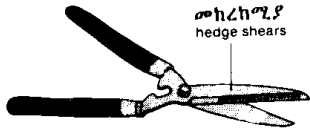

የእጅ መሳሪያዎች
tools and equipment

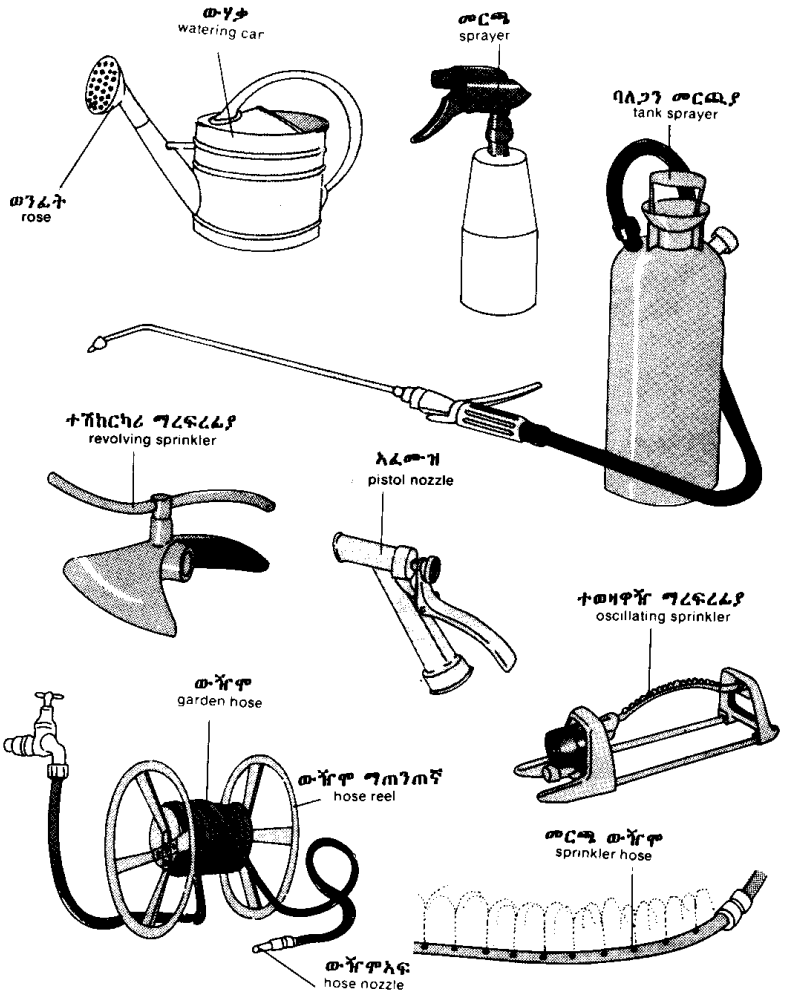

የእጅ መሳሪያዎች
tools and equipment

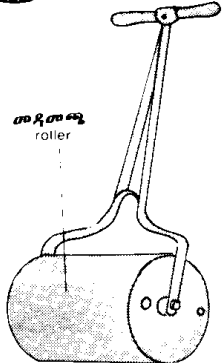
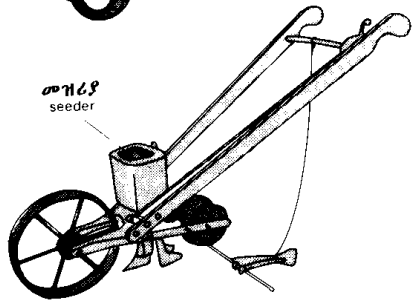
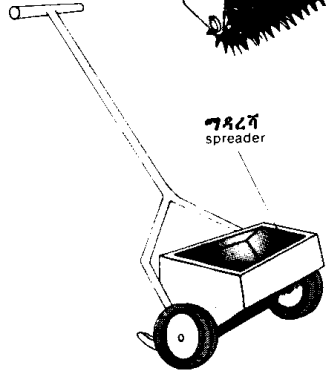
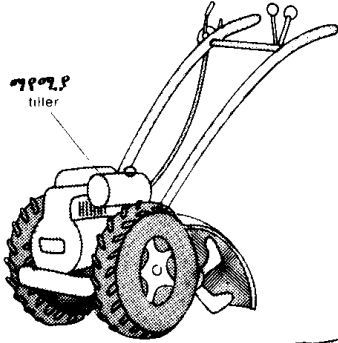
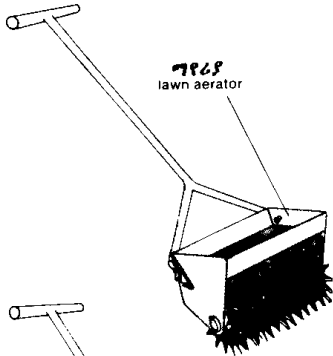
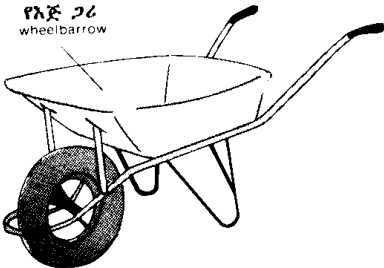

የእጅ መሳሪያዎች
tools and equipment

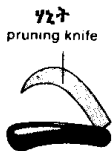
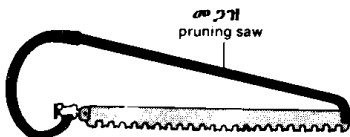

መጠርከሮያ
edger

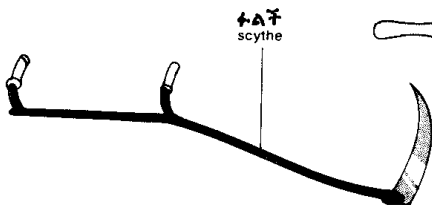
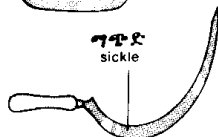

የጨረ መክርካሪያዎች
lawn mowers

የእጅ ግጨኛ
hand mower

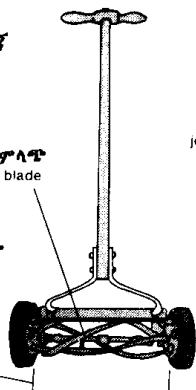

ባለግጥር መክርካሪያ
motor mower

መቀለሻ
jet deflector

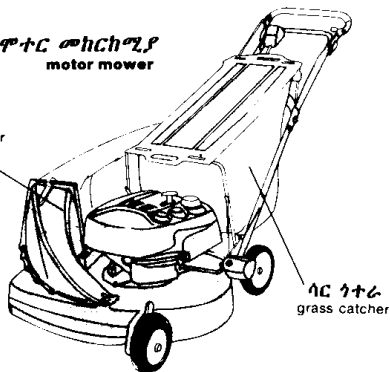

ሰንሰለት መጋዝ
chainsaw

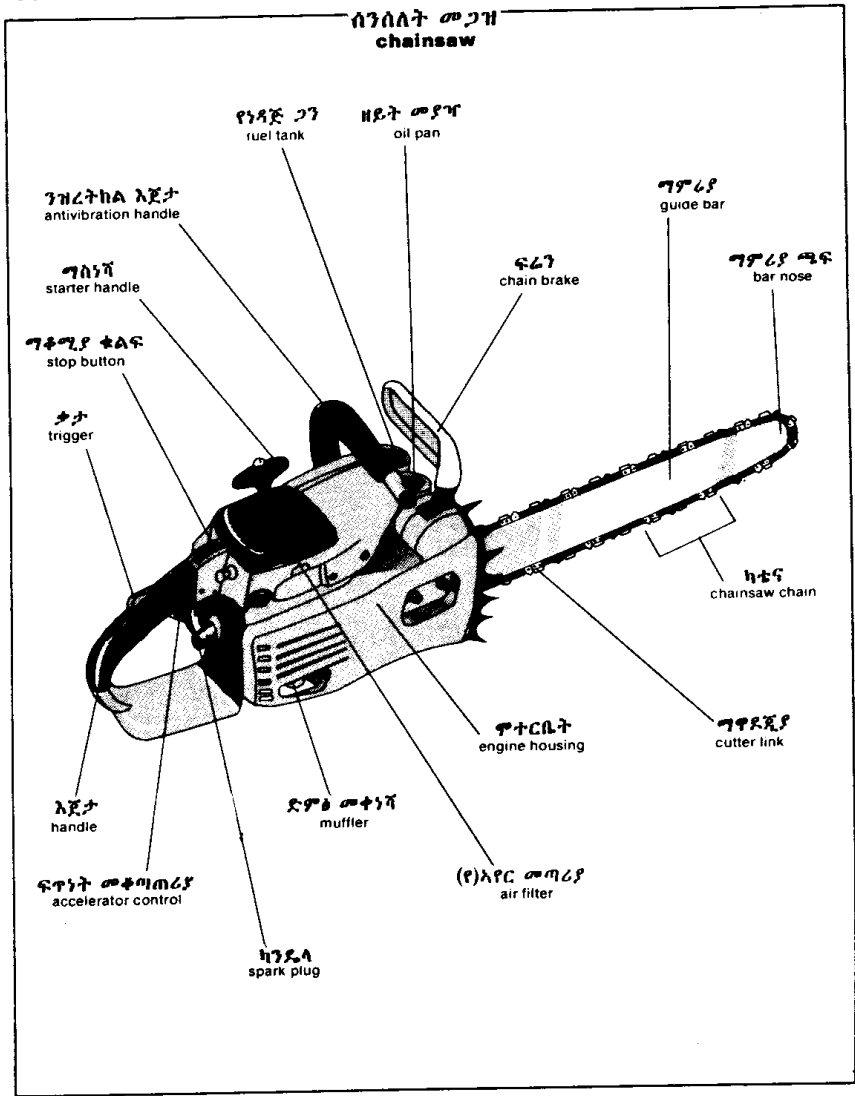

ራስህ ስራው
DO-IT-YOURSELF

ራስህ ስራው

የእናጢ መሳሪያዎች
carpentry: tools

የእናጢ መደሻ
carpenter's hammer

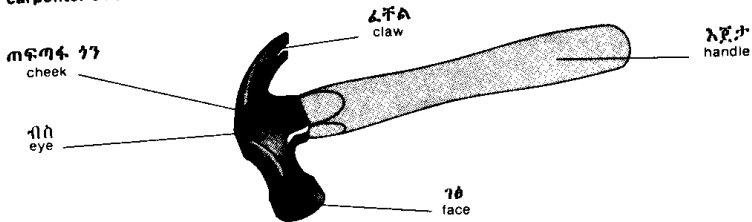

ክብ ጭንቅላት መደሻ
ball peen hammer

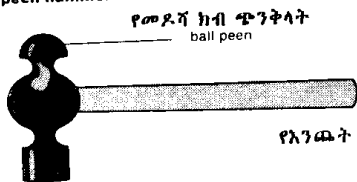

የእንጨት መደሻ
mallet

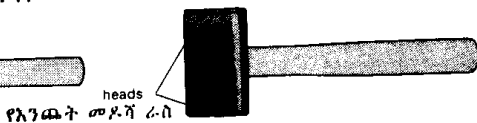

መላጊያ
plane

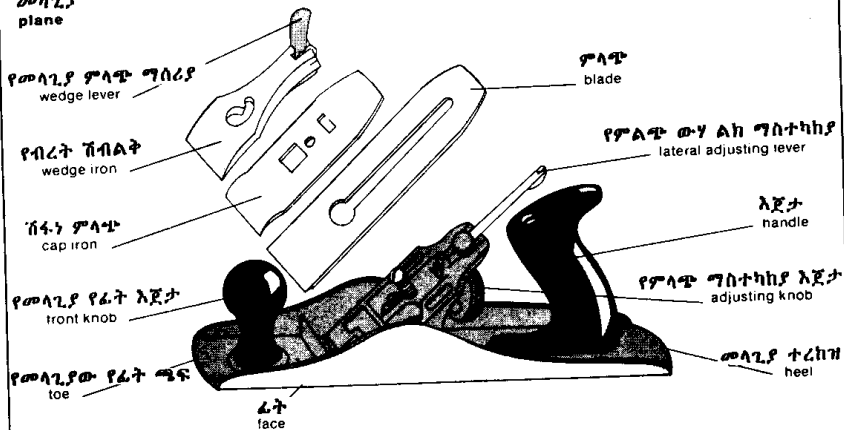

የእናጢ መሳሪያዎች
carpentry: tools

ተስፋንጣሪ የጠመንጃ መፍቻ
spiral ratchet screwdriver

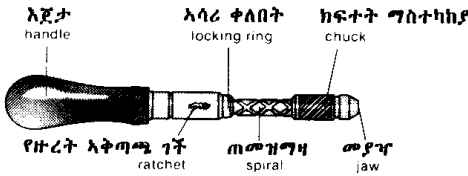

ጠመንጃ መፍቻ
screwdriver

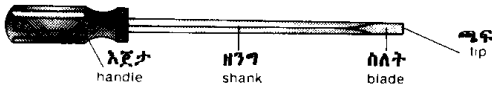

ጠፍጣፋ ጫፍ
flat tip

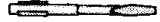

ፎርሮትስን ጫፍ
Robertson tip



ፊሊፕስ ጫፍ
Phillips tip



መፍቻ
wrenches

ተስተካካይ መፍቻ
adjustable wrench

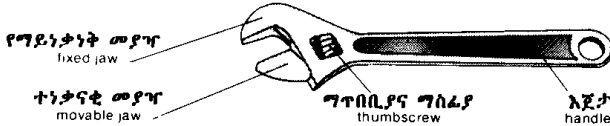

ክብና ክፍት መፍቻ
combination box and open end wrench



ጫፊ ሳጥን መፍቻ
box end wrench



ስድስት ግእዘን ጫፍ ሳጥን መፍቻ
6-point box end wrench



ጥርሳግ መፍቻ
flare nut wrench



ጫፊ ክፍት መፍቻ
open end wrench



የእናጢ መሳሪያዎች
carpentry: tools

የኢሌክትሪክ ሽቦ
መመዥሊያ ጉጠት
rib joint pliers

ተንሸራታች ጉጠት
slip joint pliers

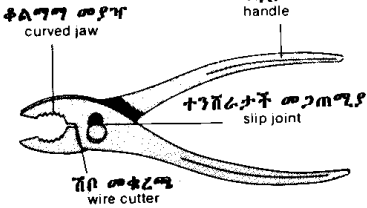

ቦያግ ተስተካካይ
adjustable channel

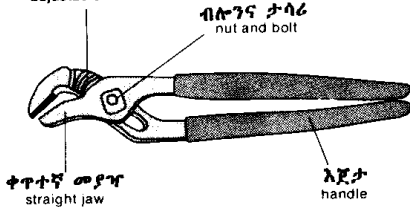

ተቆላፊ ጉጠት
locking pliers

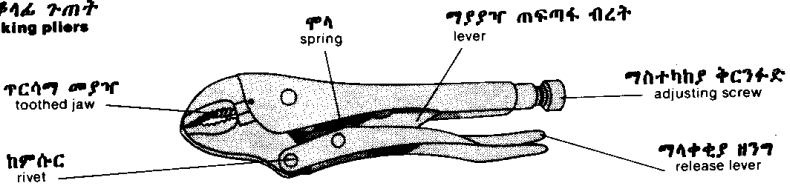

ጥርሳ
vise

C-ጥርሳ
C-clamp

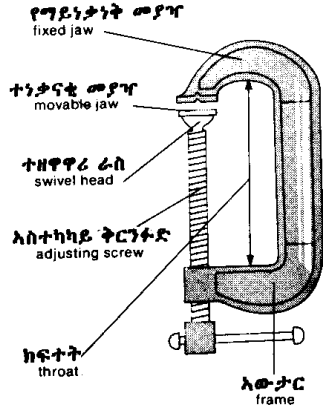
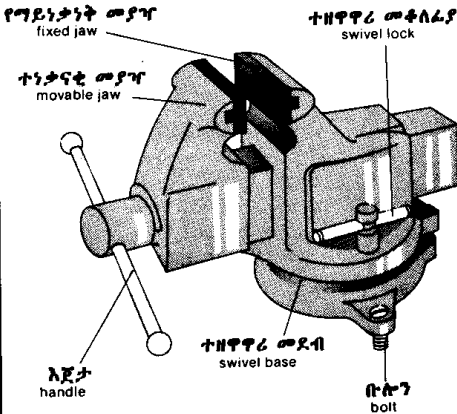

የእናጢ መሳሪያዎች
carpentry: tools

ደጋጋ መሰርሳሪያ
brace

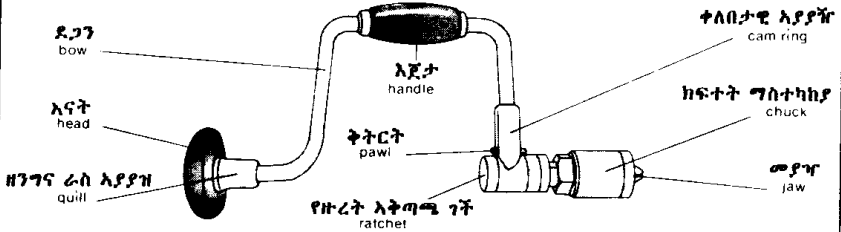

የእጅ መሰርሳሪያ
hand drill

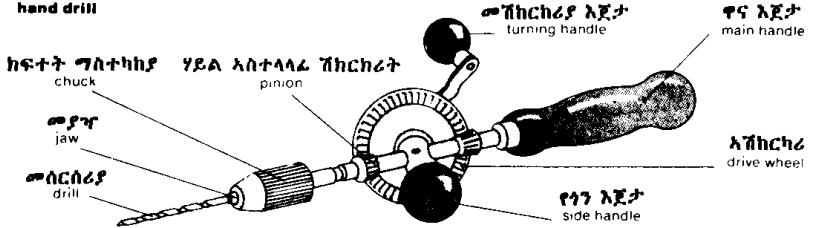

መሰርሳሪያ መኪና
router

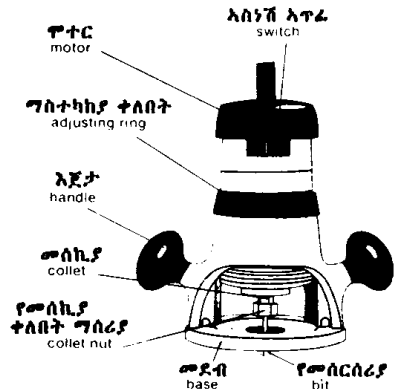

ባለሁለት ጥምዝ ፐርስ መሰርሳሪያ
double-twist auger bit



ጥምዝ መሰርሳሪያ
twist drill

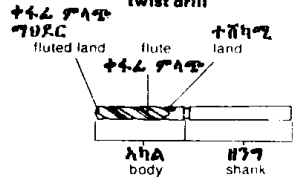

ጥምዝ መሰርሳሪያ ጫና
auger bit

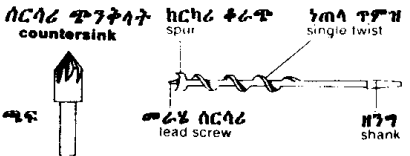

የአኖጢ መሳሪያዎች
carpentry: tools

መብሻ ግሽን
drill press

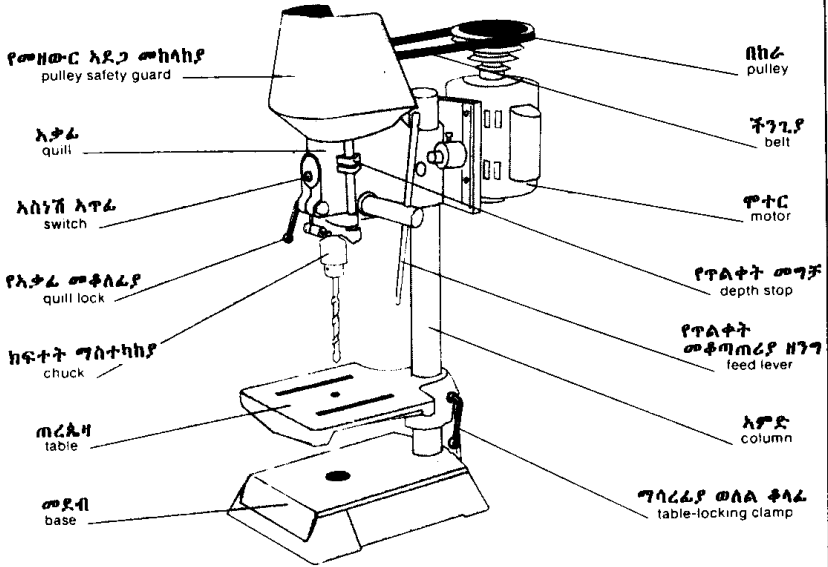

ኤሌክትሪክ መብሻ
electric drill

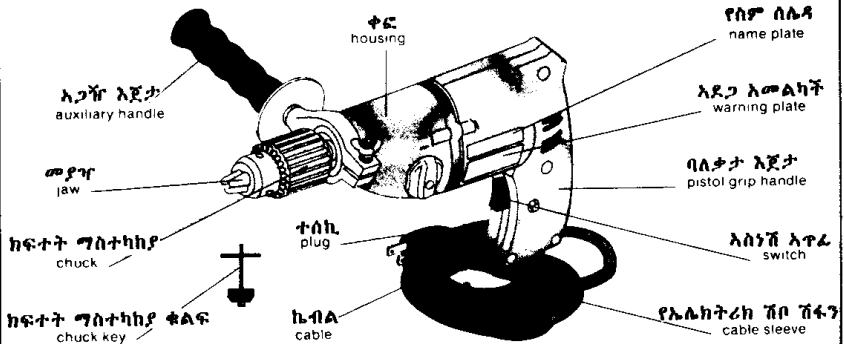

የእናጠ መሳሪያዎች
carpentry: tools

ክብ መጋዝ
bench saw

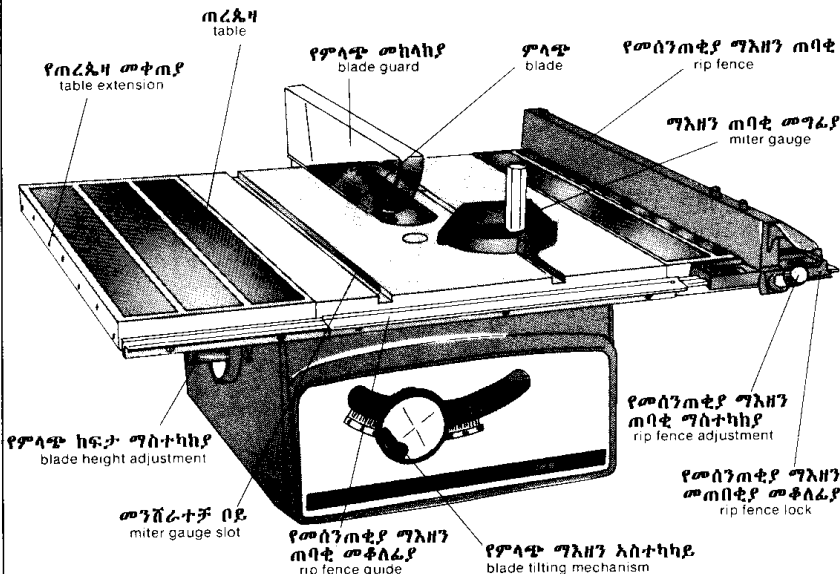

ብረት መቀረጫ መጋዝ
hacksaw

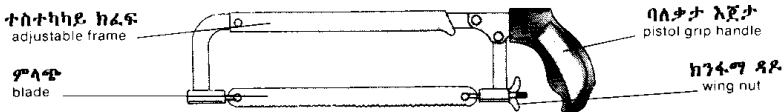

የእንጨት መጋዝ
handsaw

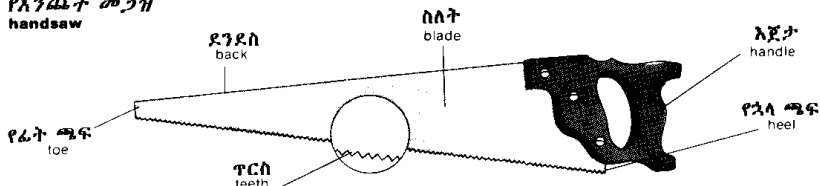

የእናጢ መሳሪያዎች
carpentry: tools

ክብ መጋዝ
circular saw

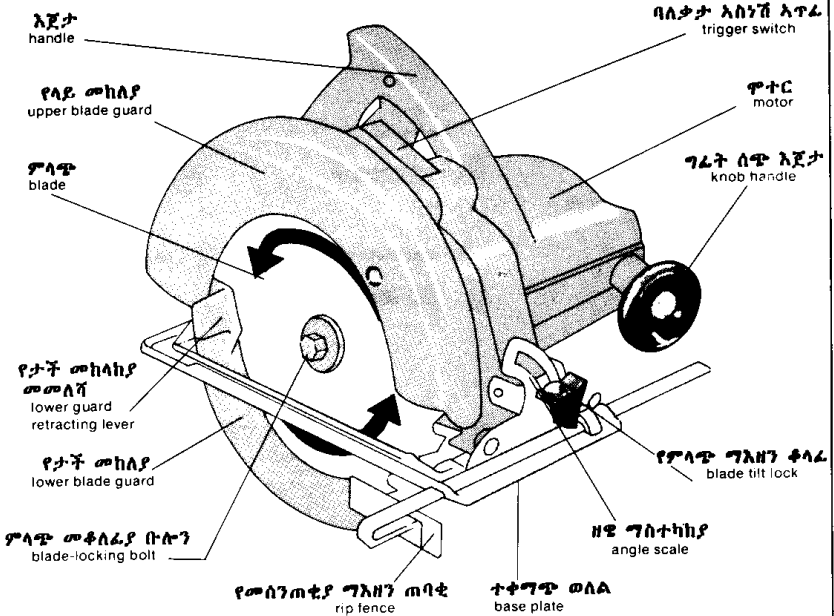

ተሽከርካሪ መጋዝ ምላጭ
circular saw blade



የእነዚህ ማያያዣዎች
carpentry: fasteners

ምስግር
nail

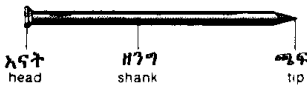

ቅርንፉድ
screw

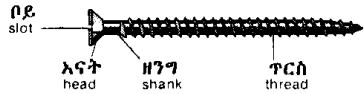

ጠፍጣፋ ስፍት
flat head



ግላላ ስፍት
oval head



ክብ ስፍት
round head

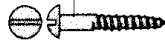

መስቀልኛ ስፍት
cross head (Phillips)



ማእዘን ስፍት
socket head (Robertson)



አንድ ወጥ ስፍት
one way head

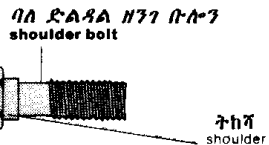
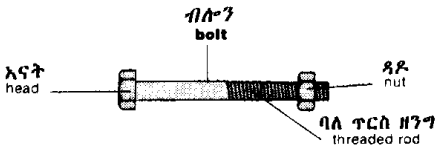

ዝግ ጻዶ
acorn nut

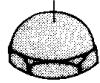

ክንፋማ ጻዶ
wing nut

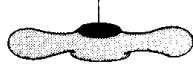

ባለ ሙሉ ፐርስ ዘንግ ቡሎን
toggle bolt

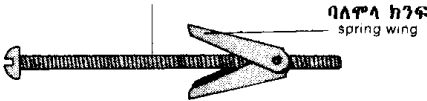

ተለጣጭ ዘንግ ቡሎን
expansion bolt

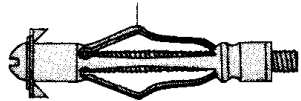

ባለ ውጪ ፐርስ አካሪ ሮንዶላ
external tooth lock washer

ሮንዶላ
flat washer



አካሪ ሮንዶላ
lock washer



ባለ ውስጥ ፐርስ አካሪ ሮንዶላ
internal tooth lock washer



እንግ
carpentry

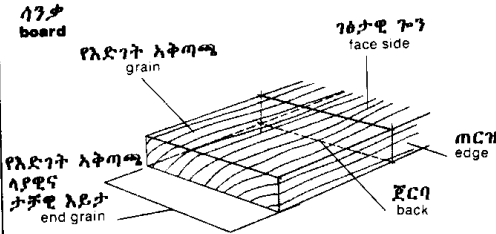

ቅፋፊ ተለጣፊ እንጨት
peeled veneer

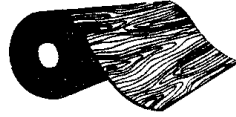

የእንጨት ውጤቶች
wood-based panel

ተደራራቢ ስስ እንጨት
multi-ply

ባለ ቅርፅ ተደራራቢ ስስ እንጨት
moulded plywood

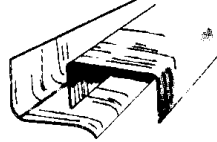
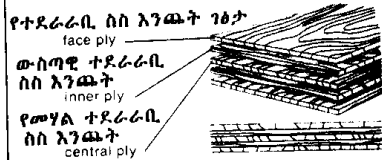

ተሸፋኝ ስስ እንጨት
core plywood

ውስጠ ክፍት እንጨት ስራ
hollow-wood construction

ድፍን ላንታ
blockboard

ተያያዥ ላንታ
laminboard

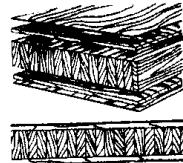
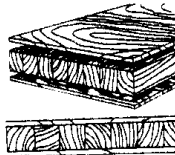

ቸጥ-ውድ
particle board

ፋይዚት
hardboard

ተለጣፊ ላንታ
laminare board

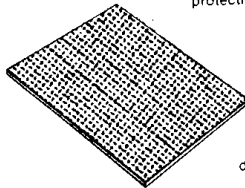
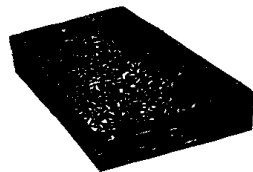

መከላከያ ሽፋን
protective sheet

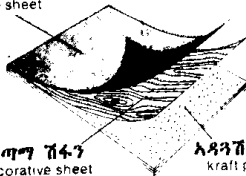

ጌጣጣ ሽፋን
decorative sheet

አዳኝ ሽ ወረቀት
kraft paper

እናት ቁልፍ lock

ተሰንቃሪ ቁልፍ mortise lock

ሰረገላ ቁልፍ cylinder

የቁልፍ ቀዳዳ keyhole

እስኩቶ escutcheon

እጀታ knob

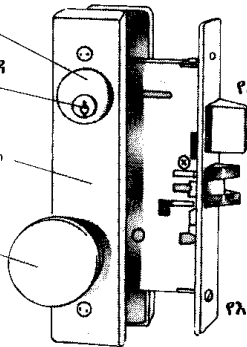

የሲሊንደር ቀዳዳ cylinder hole

ገፈና መላሽ turn knob hub

የፊት ስፈት ተለጣፊ faceplate

የተቆላፊ ምላስ dead bolt

ቆላፊ ምላስ latch bolt

የእጀታ-ዘንግ አቃፊ hub

ቆላፊ ምላስ መላሽ long hub lever

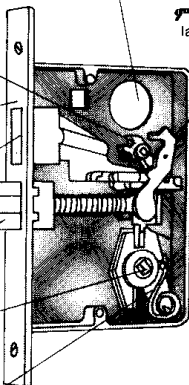

ምላስ ዘንግ latch lever

አቃፊ strike

ሰረገላ ቁልፍ cylinder

ሞላ spring

ቅትርት pin

ሽከርካሪ rotor

አይሽከርካሪ stator

ቁልፍ key

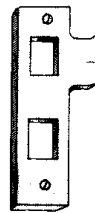
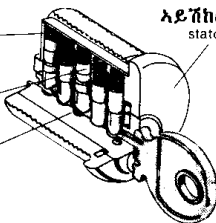

ከንፈር lip

ቱቦ ቁልፍ tubular lock

ውጫዊ እጀታ outside knob

ፅጌረዳ ቅርፅ አቃፊ rose

ምላስ bolt

የምላስ አቃፊ faceplate

እንዝርት spindle

ቅርንፋድ screw

ውስጣዊ እጀታ inside knob

ጫኔ ቁልፍ push-button

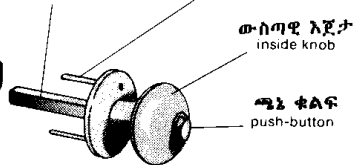
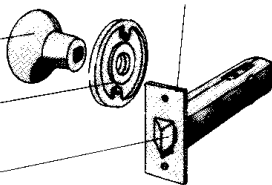

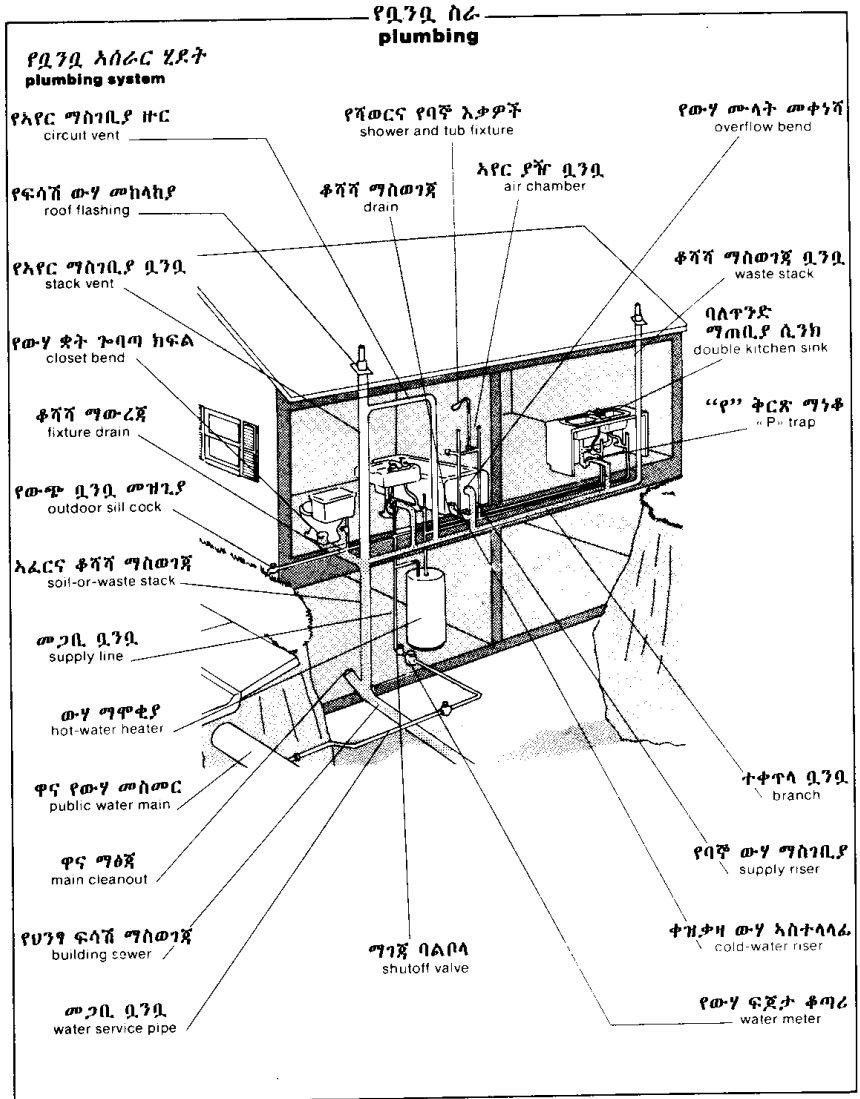

የቧንቧ ስራ
plumbing

መፀዳሽ
toilet

የውሃ ግፍለሻ እጅታ
trip lever

መሽጫ ትቦ
refill tube

ሙላት መቀነሻ ትቦ
overflow tube

ሙላት መቆጣጠሪያ ባልቦላ
ball-cock supply valve

ተንባፋፊ ኳስ
float ball

ጥይት ትቦ
filler tube

የውሃ ጋን ባልቦላ
tank ball

የተሸቃዛ ውሃ ቧንቧ
cold-water line

የባልቦላ ግረፊያ ትቦ
valve seat shaft

አሳሪ ጻፎ
locking nut

ግሰረዘጫ ቧንቧ
stub out

ትንብቢት ሮንዶላ
conical washer

ግገሻ ባልቦላ
shutoff valve

የመፀዳሽ ቋት
toilet bowl

ግፊት ቀለበት
wax seal

የወለል ግገናኛ ነሃስ
brass floor flange

መገናኛ ዘንግ ቡሎን
flange bolt

የቆሻሻ ግስመገሻ ቧንቧ
waste pipe



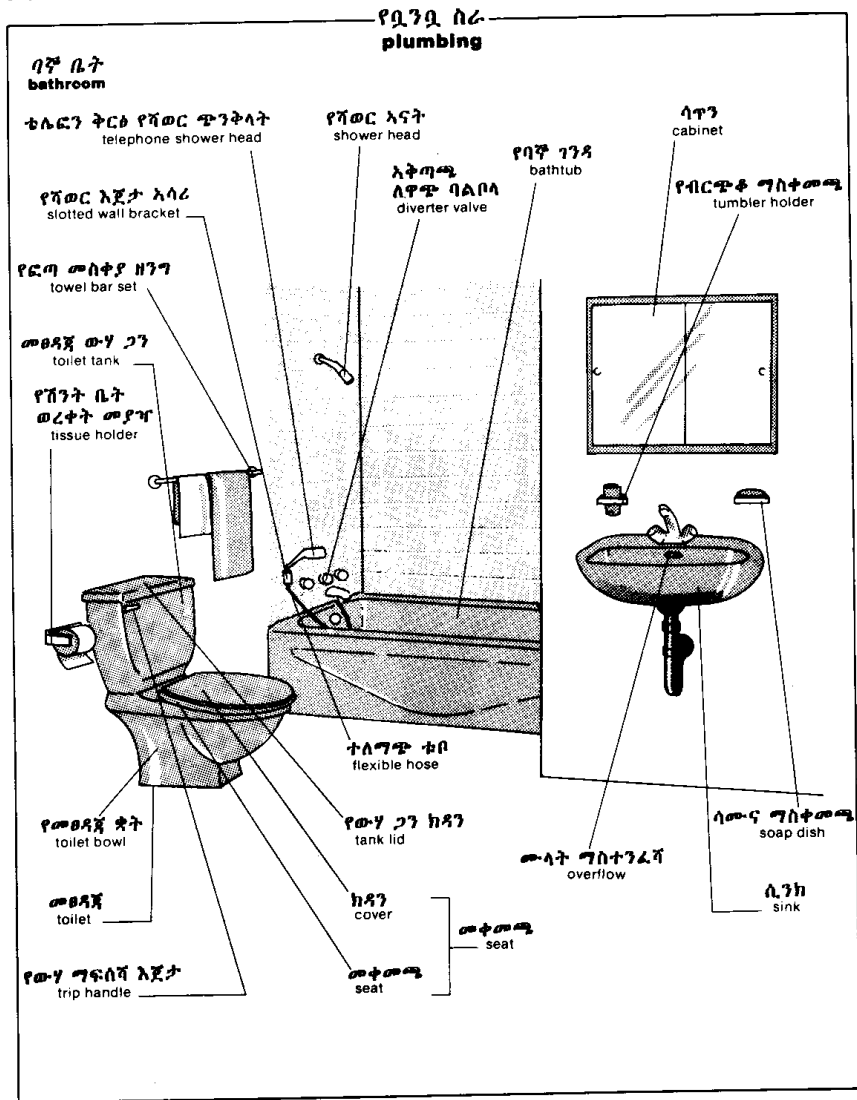

የቧንቧ ስራ
plumbing

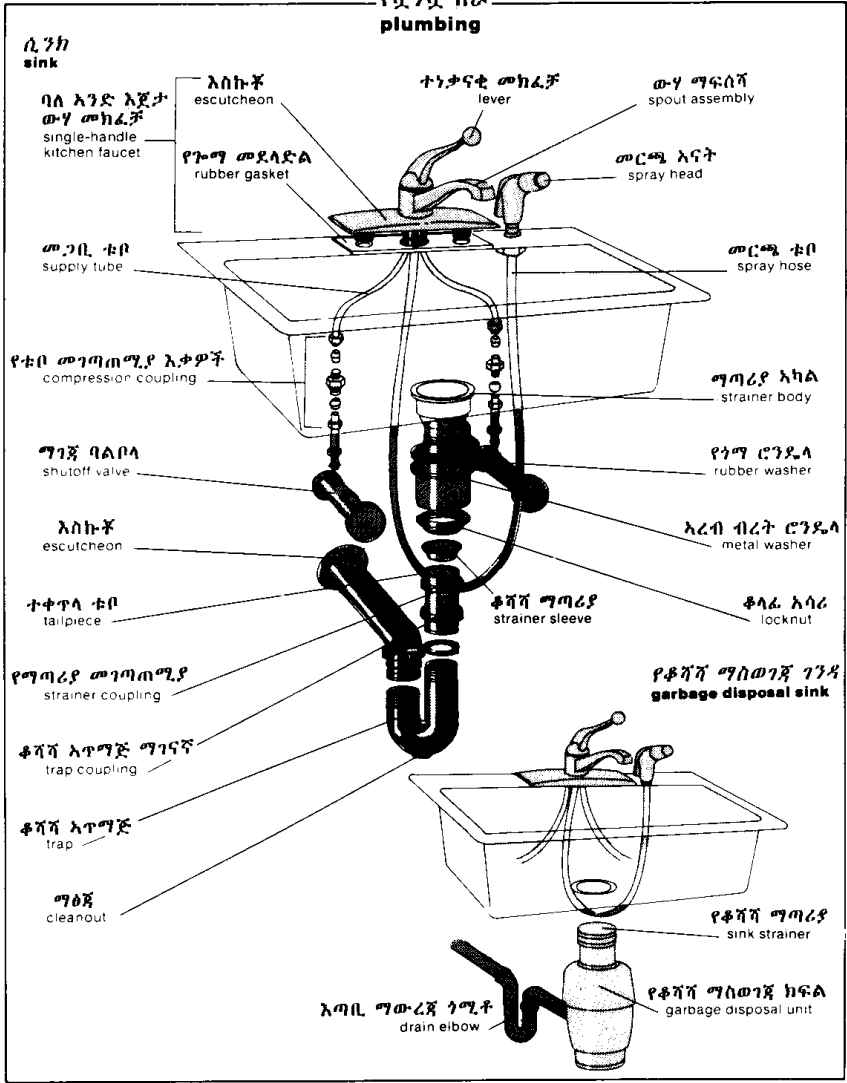

የቧንቧ ስራ
plumbing

ዋና ክፍች
stem faucet

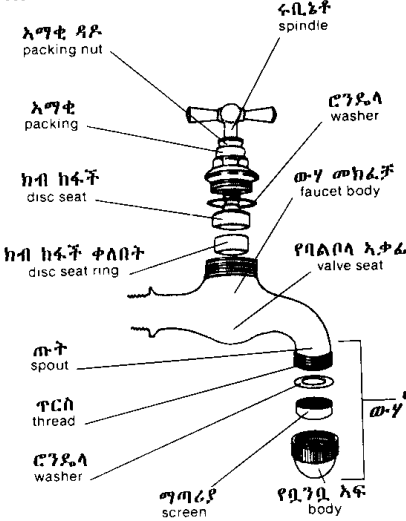

አጋዳይ የውሃ መክፈቻ
tipping valve faucet

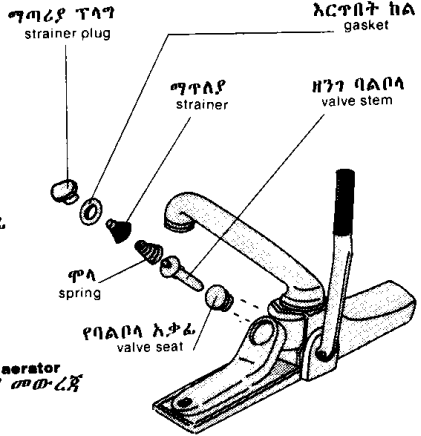

ባለአንድ እጅታ የውሃ መክፈቻ
single-handle kitchen faucet

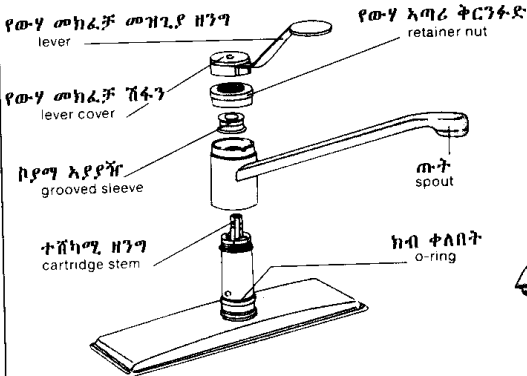

ኳላማ ነፃስ የውሃ መክፈቻ
brass ball faucet

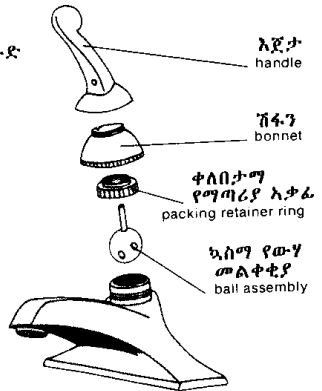

የቧንቧ ስራ
plumbing

የኤሌክትሪክ ውሃ ግጥሚያ በርሚል
electric water-heater tank

የኤሌክትሪክ ሃይል መጋቢ
electric supply

የአዋር ገፊት ግስተንፈሻ ባልቦላ
pressure relief valve

የውሃ ሙላት መቀነሻ ቧንቧ
overflow pipe

ክለት
insulation

መድረሻዊ ሽፋን
access panel

የታችኛው መቆጣጠሪያ
lower thermostat

ግፍሰሻ ባልቦላ
drain valve

የቀዝቃዛ ውሃ መስመር
cold-water line

ሙቅ ውሃ መጋቢ መስመር
hot-water supply line

ቀዝቃዛ ውሃ ግድረጫ ባልቦላ
cold-water shutoff valve

አኖድ
anode

ከፍተኛ ሙቀት ግድረጫ
high-temperature cutoff

የላይ መቆጣጠሪያ
upper thermostat

የላይ ሙቀት ሰጭ
upper heating element

ክለት
insulation

የታች ሙቀት ሰጭ
lower heating element

ግሽጊያ
seal

የቧንቧ ስራ
plumbing

የቧንቧ ማገናኛዎች
mechanical connectors

አማቂ መገጣጠሚያ
compression fitting

ቧንቧ
pipe

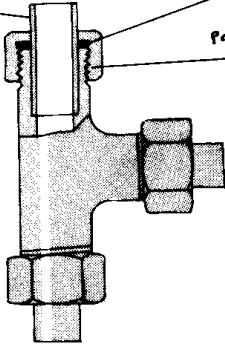

እርጥበት ከሌ
gasket

የመገናኛ አሳሪ
flange nut

ደውላማ ቅርፅ አያያዥ
flare joint

የቱቦ ማፍ
tube end

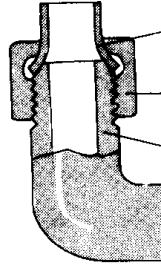

ድንገተኛ ቃጠሎ
ተከላካይ ቅርንፉድ
flare nut

ግጋጠሚያ
fitting

ግጥጥጥ
union

የመዳብ ቧንቧ
copper pipe

አሳሪ ቅርንፉድ
ring nut

ግጥጥጥ ቅርንፉድ
union nut

እርጥበት ከሌ
gasket

ግጥጥጥ ቅርንፉድ
union nut

ቧንቧ
pipe

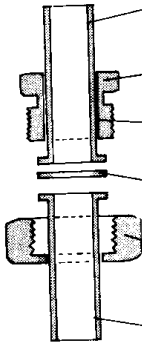

የመዳብ ቧንቧ
copper pipe

ግጥጥጥ
union

ቧንቧ
pipe

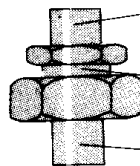

የቧንቧ ስራ
plumbing

ማጋጠሚያዎች
fittings



ክርን ቅርጽ
elbow



ታላራ ክርን ቅርጽ
base elbow



U-ቅርጽ ታጣፊ
U-bend

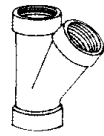

ቅርፅ ባላ
wye branch

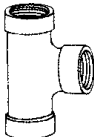

T-ቅርጽ አያያዥ
tee

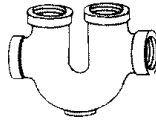

ቆሻሻ አጥማጅ
trap



መቀነሻ
reducing coupling



አባብ ወረድ
offset

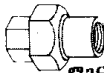

ማገናኛ
pipe coupling



ማጥበቢያ
nipple



መቀነሻ
flush bushing

ጣራ ማናፈሻ
roof vent

አገናኝ መገጣጠሚያ
transition fittings

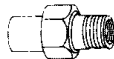

copper to steel
መዳብን ከብረት

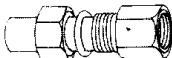

ብረትን ከፕላስቲክ
steel to plastic

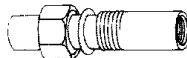

መዳብን ከፕላስቲክ
copper to plastic



ባለስድስት ጎን መቀነሻ
hexagon bushing



ባለጥርስ መድፈኛ
threaded cap



ማገናኛ
cap



አራት ማለዘን ራስ መድፈኛ
square head plug



ማናፈሻ መስመር
vent line

የቧንቧ ስራ
plumbing

የቧንቧ መሳሪያዎች
plumbing tools



የባለባ ማያያዣ
valve seat wrench

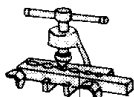

የላስቲክ መተካሻ
tube flaring tool



ብረት መጋክ
hacksaw



መበየጃ
torch

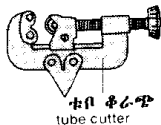

ቱቦ ቆራጭ
tube cutter



ባለ ጠፍር መፍቻ
strap wrench

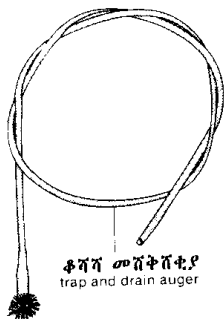

ቆሻሻ መሸቅሸቂያ
trap and drain auger

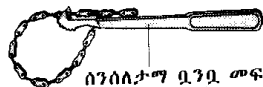

ሰንሰለታማ ቧንቧ መፍቻ
chain pipe wrench



ቅርፅ ዝንጀሮ መፍቻ
monkey wrench

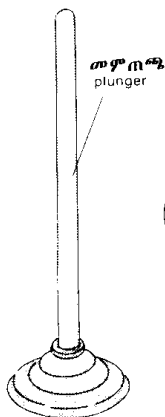

መምጠጫ
plunger

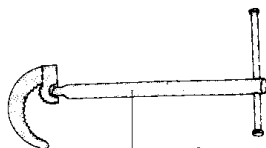

ገንዳ መፍቻ
basin wrench

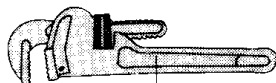

ቧንቧ (ባለቱቦ) መፍቻ
pipe wrench

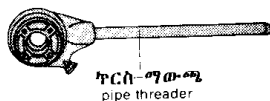

ኮርሰ-ማውጫ
pipe threader

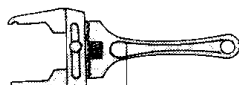

ተስተካካይ መፍቻ
adjustable spud wrench

የቧንቧ ስራ
plumbing

የሰገራ ጉድጓድ
septic tank

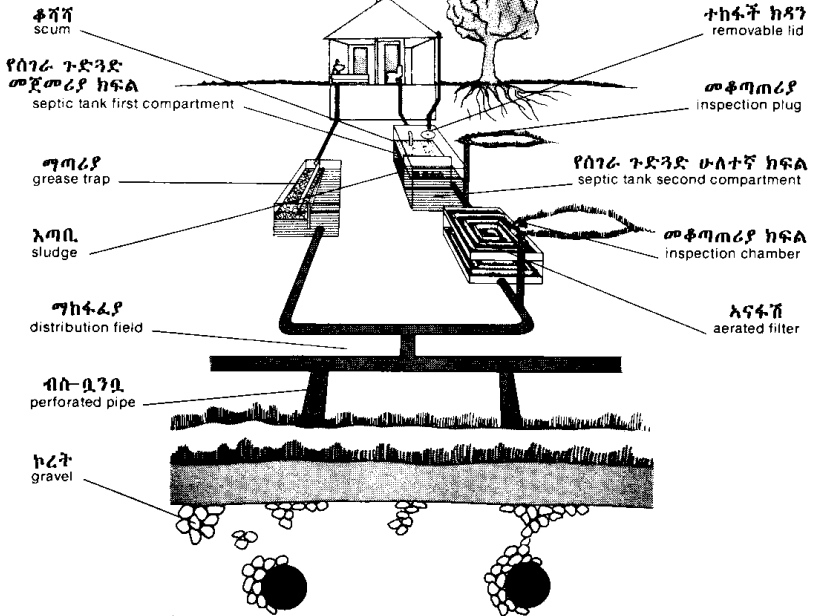

በእግር የሚሰራ ክፍት መሳቢያ
pedestal type sump pump

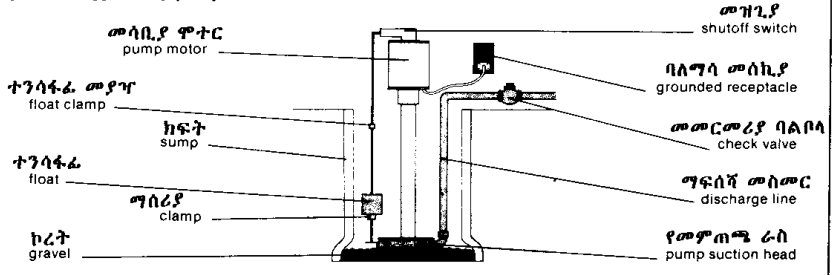

DO-IT-YOURSELF

የቀለም መቀቢያ መሰሪያዎች
painting upkeep

መሰላሎችና መወጣጫዎች
ladders and stepladders

ቀጥታ መሰላላ
straight ladder

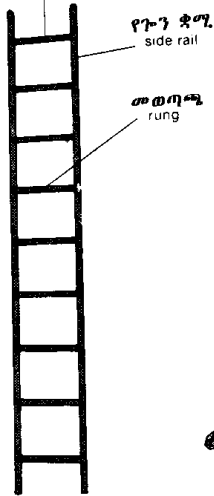

ተቀጣይ መሰላላ
extension ladder

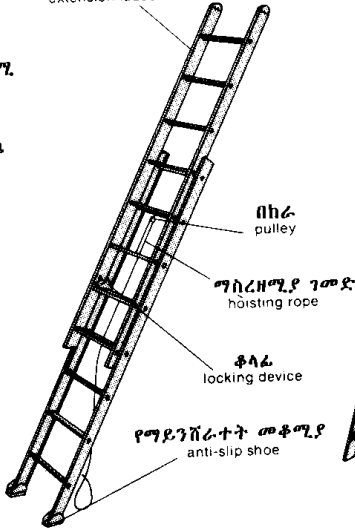

ሁለገብ መሰላላ
multi-purpose ladder

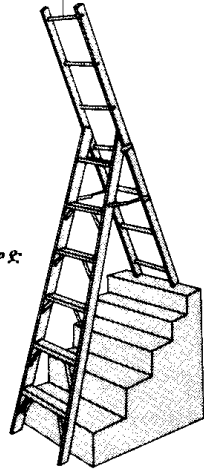

መንጠቋማ መሰላላ
hook ladder

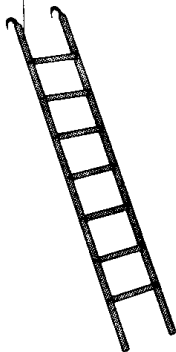

የገመድ መሰላላ
rope ladder



ተክርጊ መሰላላ
foldaway ladder

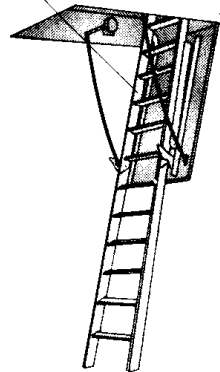

መሰላሎችና መወጣጫዎች
ladders and stepladders

ተሽከርካሪ መሰላላ
rolling ladder

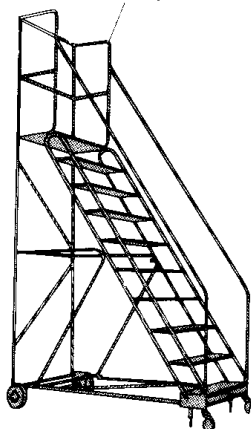

የቀለም መቀቢያ መሰላላዎች
painting upkeep

ፍራ-ፍሬ መልቀሚያ መሰላላ
fruit-picking ladder

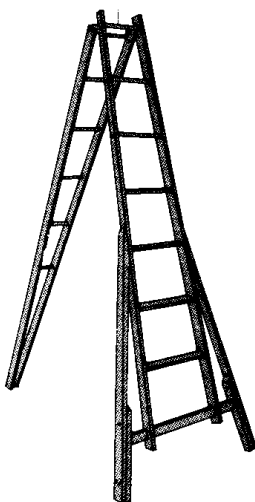

ማማ መሰላላ
ladder scaffold

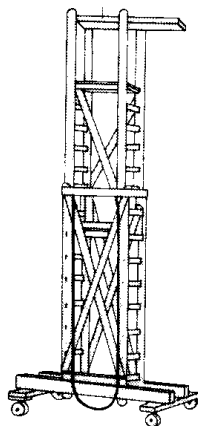

ደረጃ መሰላላ
stepladder

እቃ ማስቀመጫ ትሪ
tool tray

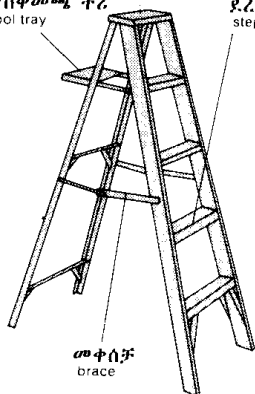

ደረጃ
step

የመድረክ መሰላላ
platform ladder

መደገፊያ
safety rail

መቆሚያ
platform

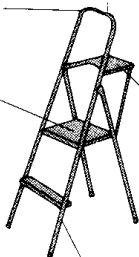

መደርደሪያ
shelf

ደረጃማ መቀመጫ
step stool

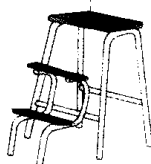

መቀሰቻ
brace

እውታር
frame

የቀለም መቀበያ መሳሪያዎች
painting upkeep

ቀለም መርጫ
spray paint gun

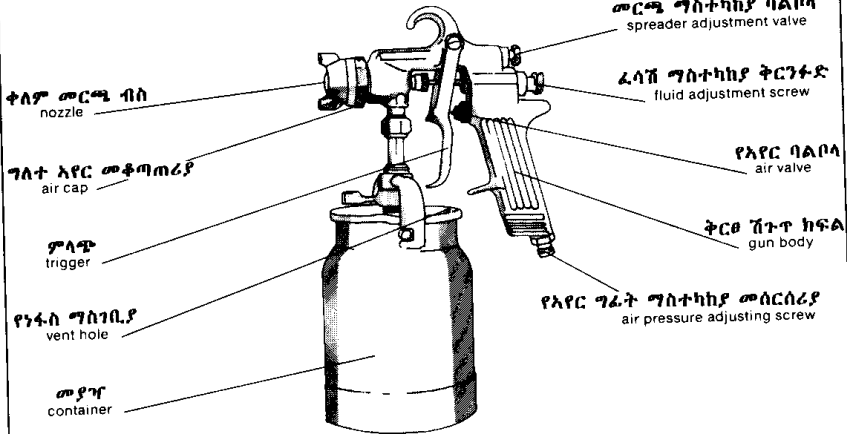

ቡሩሽ
brush

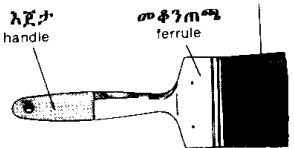

መፈቅፈቂያ
scraper

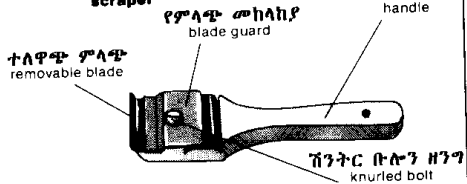

ተሽከርካሪ ቀለም መቀበያ
paint roller

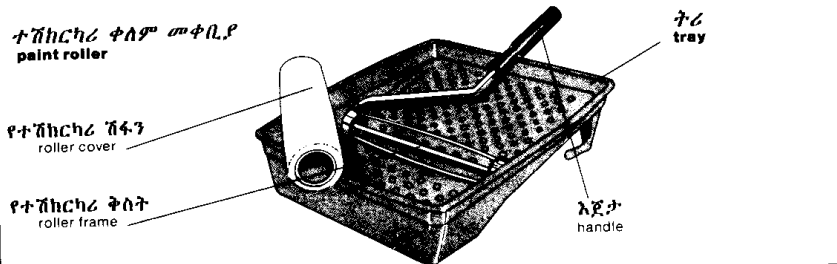

መበየጃና ማጣበቂያ
soldering and welding

መበየጃ ብረት
soldering iron

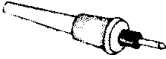

ሽጉጥ መሰል መበየጃ
soldering gun

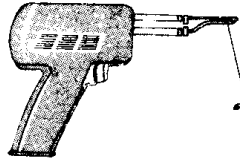

ሜቶ
tip

መበየጃ (ፋና) ነበልባል
soldering torch

የእርሳስ ሜቶ
pencil point tip



ነበልባል ረጭ ሜቶ
flame spreader tip

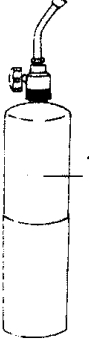

ተጣይ የነዳጅ በርሜል
disposable fuel cylinder

ጠርመስ መያዣ ጋሪ
bottle cart

የጋዝ መበየጃ
oxyacetylene welding

ግፊት አስተካካይ
pressure regulator

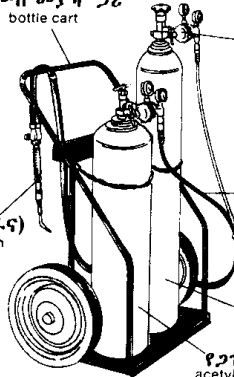

ክፍን
cap

ቱቦ
hose

መበየጃ ነበልባል (ፋና)
welding torch

የኦክስጅን በርሜል
oxygen cylinder

የጋዝ በርሜል
acetylene cylinder

የኤሌክትሪክ መበየጃ
arc welding

ኤሌክትሮድ
electrode

የኤሌክትሮድ መያዣ
electrode holder

ግላ ግሰሪያ
ground clamp

የኤሌክትሪክ ቀስት
electric arc

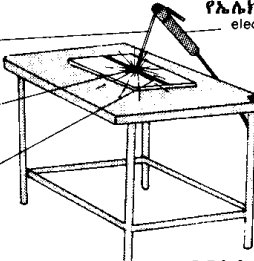

የብየዳ ፍንጣቂ
weld bead

የግላ እርሳስ
work lead

ኤሌክትሮድ አድራሽ
electrode lead

የኤሌክትሪክ መበየጃ ግሽን
arc welding machine

መበደኛና ማጣበቂያ
soldering and welding

መበደኛ ነበልባል (ፋና)
welding torch

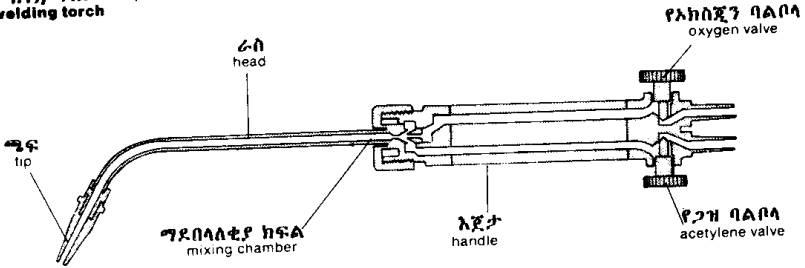

መቁረጫ ነበልባል
cutting torch

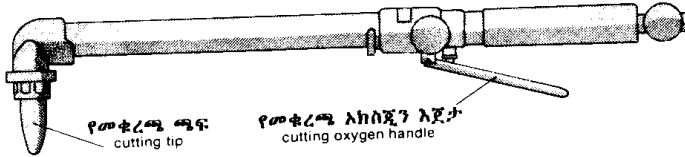

ገጣሚ ብዩዳ
butt welding

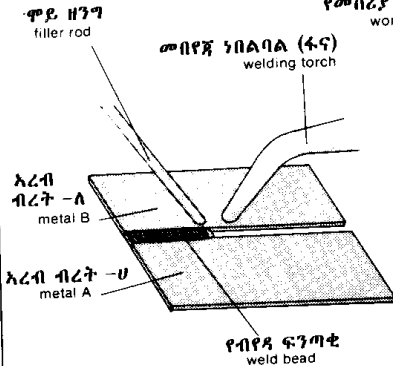

ግፊት አስተካካይ
pressure regulator

የመስሪያ የእየር ግፊት መለኪያ
working pressure gauge

በርሜሎ እየር ግፊት መለኪያ
cylinder pressure gauge

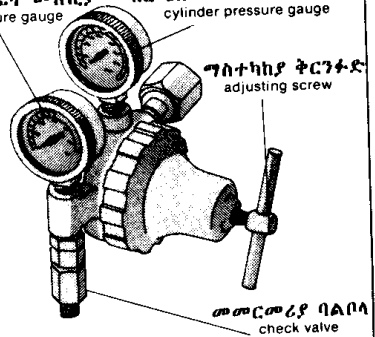

መበደጃና ማጣበቂያ
soldering and welding

መከላከያ ልብስ
protective clothing

የእይታ መከላከያ መነፅር
goggles

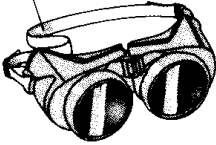

ተያዥ መከላከያ
hand shield

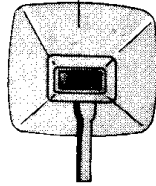

መከላከያ ጥሩር
helmet

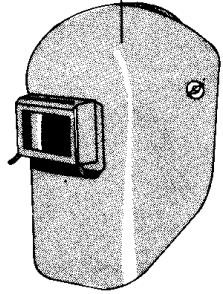

ዱሽ የብድዳ ዓንገት
mitt

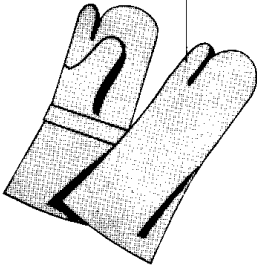

ዓንገት
gauntlet

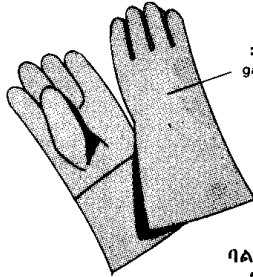

እሳት ጫራ
striker

ባልጮት
flint



የብድዳ መጋረጃ
welding curtain

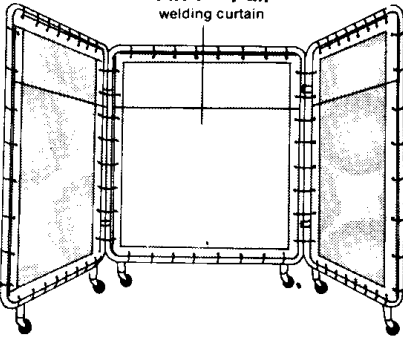

የጫፍ ማገጃ
tip cleaners



መተካኝ እርሳስ
solder



ብርሃን ሰጭ አምጥል
incandescent lamp

ኢሌክትሪክ
electricity

ባዚቃ ቅብ አምጥል
mercury-vapor lamp

ኢነርት ጋዝ
inert gas

አምጥል
bulb

አምጥል
bulb

ቅብት ቱቦ ቋሚ
arc tube mount structure

ድር
filament

ዘንጎ
stem

አንፀባራቂ
reflector

ተሸካሚ
support

የሙቀት አቅጣጫ
ለዋጭ
heat deflecting disc

ቅብት ቱቦ
arc tube

አስተላላፊ ሽቦ
lead-in wire

አቃፊ
pinch

ኒትሮጂን
nitrogen

ማያያዥያ
button

ጢስ ማስተላለፊያ ቱቦ
exhaust tube

አንቀሳቃሽ
ኢሌክትሮድ
starting electrode

መሰረት
base

ዋና ኢሌክትሮድ
main electrode

ዋገል መሰረት
mogul base

መነሻ/አነሳስ ገዥ
starting resistor

ፍሎረሴንት አምጥል
fluorescent lamp

ፎስፎር ቅብ
phosphor coating

ኢሌክትሮድ
electrode

አምጥል
bulb

ቅትርት
pin

አስተላላፊ ሽቦ
lead-in wire

ማስተላለፊያ ቱቦ
exhaust tube

አቃፊ
pinch

ጋዝ
gas

የተሰኪ መደብ
pin base

ባዚቃ
mercury

ኤሌክትሪክ
electricity

እቃዎች
supplies

የእምግላ መሰኪያ
lamp socket

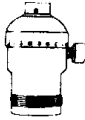

ክዳን
cap



መሰኪያ
socket



የኮረንቲ ስበት
መከላከያ
insulating sleeve



የውጭ ሽፋን
outer shell



የኮረንቲ ማቋረጫ
circuit breaker

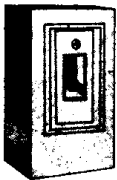

ኤሌክትሪክ መሰጫ
electric switch



ኤሌክትሪክ መቆጣጠሪያ ሰሌዳ
switch plate



ግብሪያ ማጠፊያ
switch



አደብዛኛ ማብሪያ
dimmer switch

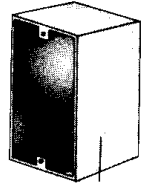
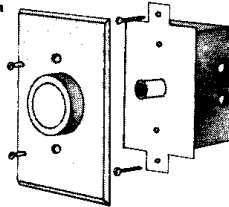

የኤሌክትሪክ ሳጥን
electrical box

የኮረንቲ መቀነሻ
outlet

ተሰኪ
plug



የማሳ መሰኪያ
grounding prong

ምላጭ
blade

ፈውዝ
fuses



መሰኪያ ፈውዝ
plug fuse

አውሮፓዊ መሰኪያ
European plug

የፕላግ ጫፍ
terminal

የማሳ መሰኪያ
grounding prong

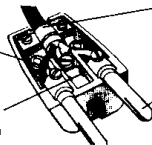

ግሰሪያ
clamp

ምላጭ
blade



cartridge fuse
ጥይት መሰል ፈውዝ



knife-blade cartridge fuse
የፈውዝ ጥይት ምላጭ

ኤሌክትሪክ
electricity

የኤሌክትሪክ ሰራተኛ መሳሪያዎች
electrician's tools

ኒዮን መመርመሪያ
neon tester

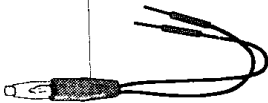

ተክታታይንን መመርመሪያ
continuity tester

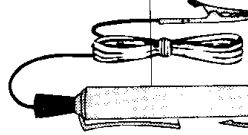

የመ-ከራ መመርመሪያ
tester probe

ፊውዝ መሰባጠያዎች
fuse pullers

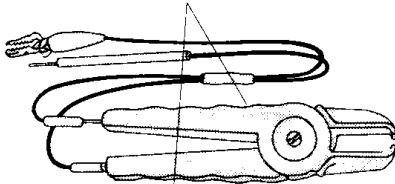

ከፍተኛ ሾልቲጅ መመርመሪያ
high-voltage tester

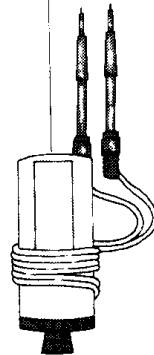

የሾልቲጅ መመርመሪያ
voltage tester

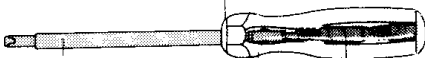

ኤሌክትሪክ ዘል ምላጭ
insulated blade

ኤሌክትሪክ ዘል ለጀታ
insulated handle

ኒዮን ለምግል
neon lamp

ግስተላላፊያ መርግሮ
receptacle analyzer

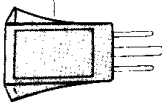

የሾልት መለኪያ
voltmeter

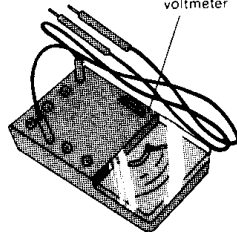

የኤሌክትሪክ ሰራተኛ መሳሪያዎች
electrician's tools

ኤሌክትሪክ
electricity

ሁለገብ መሳሪያ
multipurpose tool

ሹል ጉጠት
long-nose pliers

መቆጣጠሪያ
crimper

ኤሌክትሪክ ክል እጀታ
insulated handle

መጋጠሚያ
pivot

ሽቦ መቁረሚያ
wire cutter

ሽቦ መላላሚያ
wire stripper

የመስመር ሰራተኛ ጉጠት
lineman's pliers

ሽቦ መላላሚያ
wire stripper

መያዥ ገሳ
jaw

ሽቦ መቁረሚያ
wire cutter

ኤሌክትሪክ ክል እጀታ
insulated handle

ግስተካካያ ሽክርካርት
adjustment wheel

ቆራጭ
cutter

አሳ ቅርፅ ሽቦ መሳሪያ
fish wire

ገመድ ቀዳጅ
cable ripper

መደሻ
hammer

ምላጭ
blade

ኤሌክትሪክ
electricity

ማከፋፈያ ሰሌዳ
distribution board

240 ሾልት መጋቢ ካቦ
240-volt feeder cable

ማቋረጫ
knockout

ማገናኛ
connector

ክመስመር መስመር ማስተላለፊያ
bonding jumper

ማሳ ማገናኛ
ground bond

ዋና ማቋረጫ
main breaker

የዋናው መስመር ካቦ
main power cable

ባለሁለት መስመር ማቋረጫ
double pole breaker

ኤሌክትሪክ አልባ ሽቦ
neutral service wire

ኤሌክትሪክ ብረት
hot bus bar

240-ሾልት ዙር
240-volt circuit

ፕላስቲክ የኤሌክትሪክ ስበት መከላከያ
plastic insulator

120-ሾልት ዙር
120-volt circuit

ኤሌክትሪክ አልባ ሽቦ
neutral wire

የማሳ ጉድለት ዙር አቋራጭ
ground fault circuit interrupter

አንድ መስመር ማቋረጫ
single pole breaker

ብረት የውሃ ዓ.ንዓ.
metal water pipe

የማሳ ሽቦ
ground wire

ኤሌክትሪክ አልባ ጠፍጣፋ የማሳ ብረት
ground/neutral bus bar

የማሳ ሽቦ
ground wire