

THE FIGHT FOR THE HIGH GROUND: THE U.S. ARMY AND
INTERROGATION DURING OPERATION IRAQI
FREEDOM I, MAY 2003 - APRIL 2004

A thesis presented to the Faculty of the U.S. Army
Command and General Staff College in partial
fulfillment of the requirements for the
degree

MASTER OF MILITARY ART AND SCIENCE
Military History

by

DOUGLAS A. PRYER, MAJOR, U.S. ARMY
B.A., Missouri State University, Springfield, Missouri, 1989

Fort Leavenworth, Kansas
2009

Approved for public release; distribution is unlimited.

REPORT DOCUMENTATION PAGE			<i>Form Approved</i> <i>OMB No. 0704-0188</i>		
Public reporting burden for this collection of information is estimated to average 1 hour per response, including the time for reviewing instructions, searching existing data sources, gathering and maintaining the data needed, and completing and reviewing this collection of information. Send comments regarding this burden estimate or any other aspect of this collection of information, including suggestions for reducing this burden to Department of Defense, Washington Headquarters Services, Directorate for Information Operations and Reports (0704-0188), 1215 Jefferson Davis Highway, Suite 1204, Arlington, VA 22202-4302. Respondents should be aware that notwithstanding any other provision of law, no person shall be subject to any penalty for failing to comply with a collection of information if it does not display a currently valid OMB control number. PLEASE DO NOT RETURN YOUR FORM TO THE ABOVE ADDRESS.					
1. REPORT DATE (DD-MM-YYYY) 12-06-2009		2. REPORT TYPE Master's Thesis		3. DATES COVERED (From - To) AUG 2008– JUN 2009	
4. TITLE AND SUBTITLE THE FIGHT FOR THE HIGH GROUND: THE U.S. ARMY AND INTERROGATION DURING OPERATION IRAQI FREEDOM I, MAY 2003 - APRIL 2004			5a. CONTRACT NUMBER		
			5b. GRANT NUMBER		
			5c. PROGRAM ELEMENT NUMBER		
6. AUTHOR(S) Major Douglas A. Pryer			5d. PROJECT NUMBER		
			5e. TASK NUMBER		
			5f. WORK UNIT NUMBER		
7. PERFORMING ORGANIZATION NAME(S) AND ADDRESS(ES) U.S. Army Command and General Staff College ATTN: ATZL-SWD-GD Fort Leavenworth, KS 66027-2301			8. PERFORMING ORG REPORT NUMBER		
9. SPONSORING / MONITORING AGENCY NAME(S) AND ADDRESS(ES)			10. SPONSOR/MONITOR'S ACRONYM(S)		
			11. SPONSOR/MONITOR'S REPORT NUMBER(S)		
12. DISTRIBUTION / AVAILABILITY STATEMENT Approved for Public Release; Distribution is Unlimited					
13. SUPPLEMENTARY NOTES					
14. ABSTRACT During Operation IRAQI FREEDOM I (OIF I), U.S. soldiers waged a desperate war against a growing insurgency. Mounting U.S. casualties became the catalyst for a hidden "war within the war." Arrayed on one side of this secret conflict were leaders who believed that the "ends justify the means." Opposing this camp were those who believed that U.S. soldiers do not torture because of the higher ideals to which all Americans should subscribe. This clandestine conflict was waged at every level of command, from the fields of Iraq to Washington, D.C. In this history, the adverse influence of the ends-justify-the-means camp in Iraq is charted. Conversely, interrogation operations within the largest division task force and brigade combat team of OIF I are explored to explain why most interrogators treated detainees humanely. Those deficiencies of Army doctrine, force structure, and training that enabled harsh interrogation policies to sometimes trump traditional virtues are explained. Lastly, the Army's recent dramatic improvements with regard to interrogations are summarized and still-existing deficiencies are noted. This history concludes that the damage done by abusive interrogations will be felt for years to come--and that much work still needs to be done to ensure such damage never recurs.					
15. SUBJECT TERMS Interrogation, Operation Iraqi Freedom I, HUMINT, Detention, SERE, Abu Ghraib, Camp Cropper, Camp Bucca, Military Intelligence, Law of War, CJTF-7, 1st Armored Division, Striker, Ethics, Detainee Abuse, ICRC					
16. SECURITY CLASSIFICATION OF:			17. LIMITATION OF ABSTRACT	18. NUMBER OF PAGES	19a. NAME OF RESPONSIBLE PERSON
a. REPORT	b. ABSTRACT	c. THIS PAGE			19b. PHONE NUMBER (include area code)
(U)	(U)	(U)	(U)	224	

Standard Form 298 (Rev. 8-98)
Prescribed by ANSI Std. Z39.18

MASTER OF MILITARY ART AND SCIENCE
THESIS APPROVAL PAGE

Name of Candidate: MAJ Douglas A. Pryer

Thesis Title: THE FIGHT FOR THE HIGH GROUND: THE U.S. ARMY AND
INTERROGATION DURING OPERATION IRAQI FREEDOM I, MAY
2003 - APRIL 2004

Approved by:

_____, Thesis Committee Chair
Jonathan M. House, Ph.D.

_____, Member
Lieutenant Colonel Nathan J. Hoepner, M.A.

_____, Member
David Roeder, M.A.

Accepted this 12th day of June 2009 by:

_____, Director, Graduate Degree Programs
Robert F. Baumann, Ph.D.

The opinions and conclusions expressed herein are those of the student author and do not necessarily represent the views of the U.S. Army Command and General Staff College or any other governmental agency. (References to this study should include the foregoing statement.)

ABSTRACT

THE FIGHT FOR THE HIGH GROUND: THE U.S. ARMY AND INTERROGATION DURING OPERATION IRAQI FREEDOM I, MAY 2003 - APRIL 2004, by MAJ Douglas A. Pryer, 224 pages.

During Operation IRAQI FREEDOM I (OIF I), U.S. soldiers waged a desperate war against a growing insurgency. Mounting U.S. casualties became the catalyst for a hidden "war within the war." Arrayed on one side of this secret conflict were leaders who believed that the "ends justify the means." Opposing this camp were those who believed that U.S. soldiers do not torture because of the higher ideals to which all Americans should subscribe. This clandestine conflict was waged at every level of command, from the fields of Iraq to Washington, D.C. In this history, the adverse influence of the ends-justify-the-means camp in Iraq is charted. Conversely, interrogation operations within the largest division task force and brigade combat team of OIF I are explored to explain why most interrogators treated detainees humanely. Those deficiencies of Army doctrine, force structure, and training that enabled harsh interrogation policies to sometimes trump traditional virtues are explained. Lastly, the Army's recent dramatic improvements with regard to interrogations are summarized and still-existing deficiencies are noted. This history concludes that the damage done by abusive interrogations will be felt for years to come--and that much work still needs to be done to ensure such damage never recurs.

ACKNOWLEDGMENTS

First, I would like to thank Dr. Jonathan House, my committee chairman, and Lieutenant Colonel Nathan Hoepner, one of my committee members, for their remarkable diligence and mentorship while helping me produce this history. I am also grateful for the helpful comments of others who reviewed the transcript, especially John McCool, Operational Leadership Experiences Team Chief; and Lieutenant Colonel Jeffery Lippert, Chief of Detention, Judicial, and Legal Policy, Multi-National Force-Iraq.

Secondly, I would like to thank the former 1st Armored Division and 501st Military Intelligence Battalion leaders who consented to interviews in support of this project, including not only Lieutenant Colonel Hoepner but also Lieutenant Colonel Russell Godsil, Lieutenant Colonel (Retired) Elizabeth Rogers, Lieutenant Colonel Larry Wilson, Lieutenant Colonel Mark Crisman, Major Craig Martin, Major Brad Johnson, Captain Nicole Lauenstein, Captain Scott Linker, Chief Warrant Officer 5 (Retired) Robert Ferguson, Chief Warrant Officer 3 Kenneth Kilbourne, Chief Warrant Officer 3 John Groseclose, and Ms. Amanda Meyer. I have truly enjoyed crossing paths with all these great leaders again.

Thirdly, I would like to thank my wife, Sunny, for her enduring love and support. My pursuit of this project has certainly proven a distraction from what was supposed to be, during the year field grade officers spend with our families at Fort Leavenworth, the "best year of our lives." Despite the distraction of this project, any year spent at home is a good year, and I feel blessed to have had her and our time together at this storied and idyllic Army post.

Lastly, I would like to express my heartfelt admiration for the Human Intelligence leaders and soldiers of Operation Iraqi Freedom I, the vast majority of whom fought hard to keep themselves and others on the moral high ground. Without their good judgment and deeds, this paper would not have been possible. I dedicate this project to them.

TABLE OF CONTENTS

	Page
MASTER OF MILITARY ART AND SCIENCE THESIS APPROVAL PAGE	iii
ABSTRACT.....	iv
ACKNOWLEDGMENTS	v
TABLE OF CONTENTS.....	vii
ACRONYMS.....	ix
ILLUSTRATIONS	xii
TABLES	xiii
CHAPTER 1 ONE TERRIBLY HOT SUMMER	1
CHAPTER 2 "IT'S JUST NOT RIGHT"	17
Interrogations and Law	18
Interrogations and UCMJ, Regulations, and Doctrine.....	21
Interrogation Approaches in Army Doctrine	24
Ambiguities and Inconsistencies	27
Key Conclusions.....	33
CHAPTER 3 THE CITY UPON THE HILL	39
The Bush Administration and Interrogation Policy	40
SERE Interrogation Techniques Migrate to Iraq	49
Key Conclusions	55
CHAPTER 4 CJTF-7'S LONG LIST OF NOT NEARLY ENOUGH'S	64
Too Few MI Soldiers	68
Too Few MPs.....	72
Too Few Lawyers	74
CJTF-7's Austere Interrogation Facilities	79
"Short-Lived and Poorly Drafted" Interrogation Policies.....	89
Key Conclusions	95
CHAPTER 5 OLD IRONSIDES	112
The Road to Stability Operations.....	113
Seizing the Moral High Ground.....	116

Out Front!	119
An MI Community Takes Charge	121
The TF 1AD DIF	124
MI Shortfalls	126
Key Conclusions	133
CHAPTER 6 THE IRON BRIGADE	143
"HUMINT-Centric Operations"	145
Camp Striker	150
Key Conclusions	153
CHAPTER 7 THE ASCENT FROM ABU GHRAIB	158
Publishing New Doctrine	158
Growing the Interrogation Force	163
Improving Professional Education and Training	170
Key Conclusions	172
CHAPTER 8 A TALE OF TWO CITIES.....	177
GLOSSARY	185
APPENDIX A CHRONOLOGY	190
BIBLIOGRAPHY.....	194
INITIAL DISTRIBUTION LIST	209

ACRONYMS

1AD	1st Armored Division
2BCT	2nd Brigade Combat Team
2LCR	2nd Light Cavalry Regiment
3ACR	3rd Armored Cavalry Regiment
4ID	4th Infantry Division
AO	Area of Operations
AIT	Advanced Individual Training
AR	Army Regulation
BCT	Brigade Combat Team
BFSB	Battlefield Surveillance Brigade
CG	Commanding General
CI	Civilian Internee or Counterintelligence
CID	Criminal Investigation Division
CIA	Central Intelligence Agency
CJSOTF-AP	Combined Joint Special Operations Task Force-Arabian Peninsula
CJTF-7	Coalition Joint Task Force 7
CJTF-180	Combined Joint Task Force 180
CSA	Chief of Staff of the Army
COL	Colonel
CW	Chief Warrant Officer
DIF	Division Interrogation Facility
DAIG	Department of the Army Inspector General
DIVARTY	Division Artillery

DOCEX	Document Exploitation
DoD	Department of Defense
EPW	Enemy Prisoner of War
FBI	Federal Bureau of Investigation
FOIA	Freedom of Information Act
FRAGO	Fragmentary Order
FM	Field Manual
G2	Deputy Chief of Staff, Intelligence
GSR	Ground Surveillance Radar
GTMO	Guantanamo Bay, Cuba
GWOT	Global War on Terrorism
HCT	HUMINT Collection Team
HOC	HUMINT Operations Cell
HUMINT	Human Intelligence
ICE	Interrogation Control Element
IG	Inspector General
J2	Joint Staff Directorate, Intelligence
JIDC	Joint Interrogation and Debriefing Center
JSOC	Joint Special Operations Command
JPRA	Joint Personnel Recovery Agency
LTC	Lieutenant Colonel
LTG	Lieutenant General
MAJ	Major
MG	Major General
MI	Military Intelligence

MP	Military Police
MWD	Military Working Dog
MSO	Military Source Operations
MTOE	Modified Table of Organization and Equipment
NCO	Noncommissioned Officer
OD	Other Detainee
OIF	Operation Iraqi Freedom
OMT	Operational Management Technician
PMO	Provost Marshal Officer
ROE	Rules of Engagement
RP	Retained Person
S2	Staff Officer, Intelligence
SERE	Survival, Evasion, Resistance, Escape, and Rescue
SIGINT	Signals Intelligence
SIR	Summary Interrogation Report
SJA	Staff Judge Advocate
SMU	Special Mission Unit
THT	Tactical HUMINT Team
TF	Task Force
TF 1AD	Task Force 1st Armored Division
UCMJ	Uniform Code of Military Justice
WO	Warrant Officer

ILLUSTRATIONS

	Page
Figure 1. Combined Joint Task Force 7 Area of Operations	3
Figure 2. Interrogation Policies in Guantanamo, Afghanistan and Iraq.....	54
Figure 3. 205th MI Brigade Task Organization, August 2003.....	71
Figure 4. U.S. Detention Facilities as of August 2003.....	73
Figure 5. CJTF-7 Detention Process	78
Figure 6. Interrogation Approaches Posted at Abu Ghraib, Oct-Dec 2003	92
Figure 7. TF 1AD Area of Operations	115
Figure 8. 1AD Detainee/Information Flow	123
Figure 9. TF 1AD Division Interrogation Facility	125
Figure 10. 501st MI Battalion Information Flow	132
Figure 11. 2BCT, 1AD Intel Organization.....	146
Figure 12. 2BCT, 1AD Detainee Holding Area.....	151
Figure 13. MI versus MP Responsibilities	160
Figure 14. Increased MI Capability.....	167

TABLES

	Page
Table 1. U.S. Army Doctrinal Interrogation Approaches during OIF I.....	26
Table 2. CJTF-7 Detainee Classifications	76

CHAPTER 1

ONE TERRIBLY HOT SUMMER

We have taken casualties in every war we have ever fought--that is part of the very nature of war. We also inflict casualties, generally many more than we take. That in no way justifies letting go of our standards. We have NEVER considered our enemies justified in doing such things [torture] to us. Casualties are part of war--if you cannot take casualties then you cannot engage in war. Period.

BOTTOM LINE: We are American soldiers, heirs of a long tradition of staying on the high ground. We need to stay there."¹

— Major Nathan J. Hoepner,
501st Military Intelligence Operations Officer

One day in the spring of 2004, Maj. Gen. James Mattis was walking out of a mess hall in al Asad, in western Iraq, when he saw a knot of his troops intently hunched over a television, watching a cable news show. . . . "What's going on?" Mattis asked. It was, he learned, the revelations about Abu Ghraib, along with sickening photos of cruelty and humiliation. A nineteen-year old lance corporal glanced up from the television and told the general, "Some assholes have just lost the war for us."²

— Thomas E. Ricks,
Fiasco: the American Military Adventure in Iraq

It was the end of what had been a terribly hot summer,³ and the hopes of coalition forces for quickly establishing stability in Iraq seemed to have slipped out of reach. In July 2003, the number of attacks against coalition forces had been twice the number of attacks against coalition forces in June.⁴ Worse, these attacks had increased in both lethality and strategic effect: dangerous roadside bombs had become the weapon of choice for anti-coalition attackers, and vehicle bombs--to include the vehicle bomb that killed 11 people on 7 August and closed the Jordanian Embassy--were exploding at an almost daily rate. Compounding the frustration for coalition forces was the difficulty these forces had in determining just who it was that was attacking them. This difficulty included not only identifying who these attackers were as individuals, but it included even categorizing who these attackers were as a general group. Were these attackers

predominantly "regime dead-enders," as Secretary of Defense Donald Rumsfeld would later famously put it in a 25 November press briefing?⁵ Or, were they mostly Islamic mujahedeen or "foreign terrorists" as President Bush would later label these attackers in a 28 October news briefing?⁶ Or, were they largely part of a bona fide, home-grown insurgency growing from genuine feelings of disenfranchisement within the Sunni community, as would later prove to be the case?

For U.S. soldiers who had deployed to Iraq as part of Operation Iraqi Freedom I (OIF I), the first rotation of U.S. troops to replace the initial U.S. invasion force, it was truly a dismaying time. Rather than getting easier and less dangerous, their deployment was getting harder and more dangerous, and any hope some soldiers may have had of redeploying home early was, along with the hope of quickly establishing stability in Iraq, rapidly disappearing.

It was within this climate that a military intelligence captain working for the Human Intelligence (HUMINT) section of the Coalition Joint Task Force 7 (CJTF-7) wrote an e-mail to division-level HUMINT intelligence officers throughout Iraq. In this 14 August e-mail, this CJTF-7 HUMINT captain stated that the "gloves are coming off regarding these detainees."⁷ He then went on to ask recipients for a "wish list" of interrogation techniques they believed might make their interrogators more effective.⁸

When this email was written, three of CJTF-7's major subordinate commands were responsible for portions of what was called "the Sunni Triangle," the most dangerous area in Iraq: the 3rd Armored Cavalry Regiment (3ACR) had responsibility for Al Anbar Province, which was a Sunni stronghold, the primary entry point for Islamic mujahedeen into Iraq, and the future site of two epic battles for Fallujah in 2004; the 4th

Infantry Division (4ID) had responsibility for several hotbeds of insurgent activity, including Saddam Hussein's hometown of Tikrit; and the 1st Armored Division (1AD) had responsibility for Baghdad, by far the largest and most challenging urban environment in Iraq.

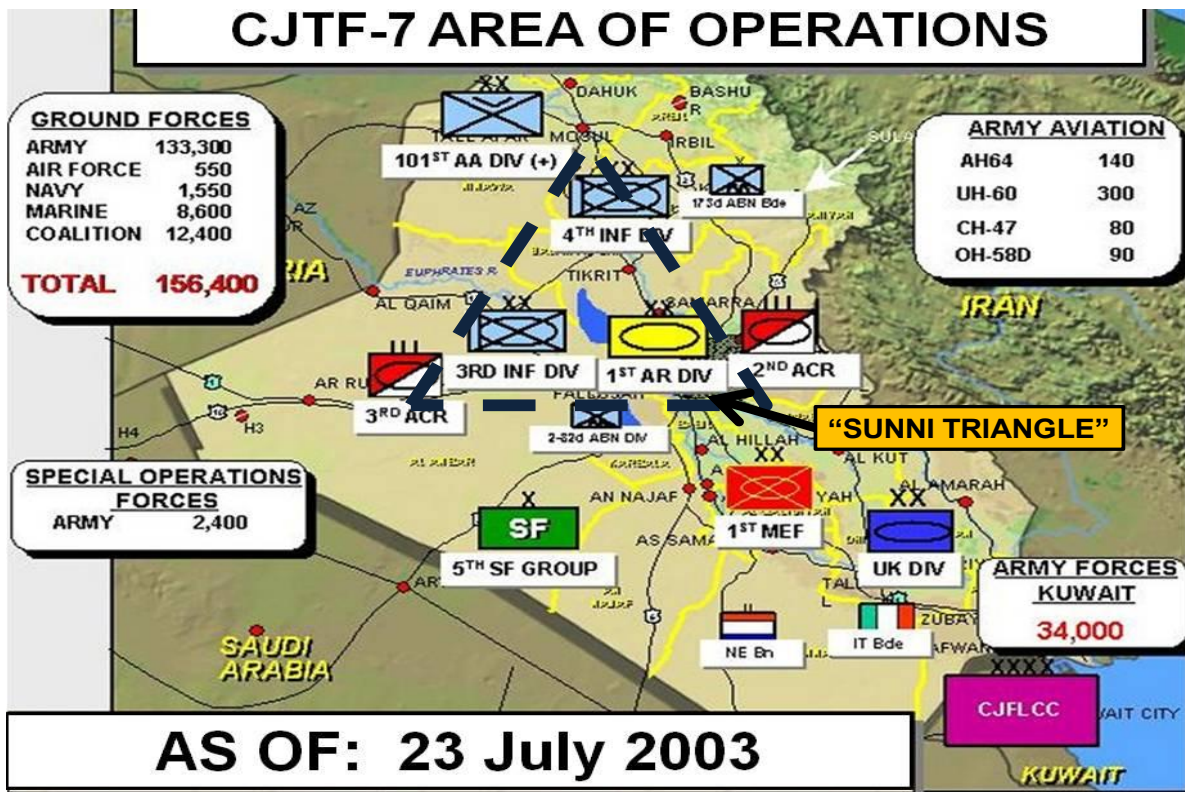

Figure 1. Combined Joint Task Force 7 Area of Operations
 Source: General John Keane Press Briefing, July 23, 2003, http://www.globalsecurity.org/military/library/report/2003/767_congress_final-10jul03.pdf (May 4, 2009).

Although the intelligence officers of these three units may have equally felt the pressure to create actionable intelligence, the "gloves are coming off" e-mail from the CJTF-7 HUMINT captain evoked philosophically antithetical reactions from HUMINT

leaders within these three units. The responses of the 3ACR and 4ID officers represented one type of reaction. Chief Warrant Officer 3 (CW3) Lewis Welshofer, Jr., the senior HUMINT officer for the 3ACR, emailed all previous recipients⁹ that he had spent several months in Afghanistan interrogating the Taliban and al Qaeda and that he agreed that "the gloves need to come off."¹⁰ According to CW3 Welshofer, who would later be convicted of negligent homicide after a detainee died during interrogation,¹¹ CJTF-7 should adopt "a baseline interrogation technique that at a minimum allows for physical contact resembling that used by SERE [Survival, Evasion, Resistance, Escape, and Rescue] instructors," to include "open- handed facial slaps from a distance of no more than about two feet and back-handed blows to the midsection from a distance of about 18 inches."¹² He also added that other techniques should include "close confinement quarters, sleep deprivation, white noise, and a litnany [sic] of harsher fear-up approaches . . . fear of dogs and snakes appear to work nicely."¹³ A 4ID non-commissioned officer replied in a similar vein, submitting a "wish list" of interrogation techniques that included "Stimulus Deprivation," "Pressure Point Manipulation," "Close-Fist Strikes," "Muscle Fatigue Inducement," and "Low Voltage Electrocutation."¹⁴

An officer from the 1AD, however, spoke very differently in his reply to all. Major Nathan Hoepner, operations officer for the 501st Military Intelligence (MI) Battalion, wrote that they needed to "take a deep breath and remember who we are." He reminded all recipients of the U.S. Army's core values and its long tradition of staying "on the high ground."¹⁵ Then, a few hours after emailing his reply, during an evening humvee ride at the Baghdad airport from the 1AD's command post to the living area for 501st MI Battalion headquarters personnel, Major Hoepner expressed concern to his

battle captain that the willingness of a few soldiers to do all the wrong things for all the right reasons might lead such soldiers (or those they led) to commit criminal abuses of detainees--some of whom might even be entirely innocent of any wrongdoing.¹⁶

Yet, even this perceptive Army major could not have imagined the photos of detainee abuse that would be splashed across newspapers and magazines seven months later. These photos, which were to be taken by military police soldiers assigned to the Abu Ghraib Prison west of Baghdad, would be shockingly cruel, lurid, and unforgettable. There would be photos of nude Iraqi males piled on top of one another into human pyramids, of a hooded and wired prisoner standing on a box, of a smiling female Army specialist pointing at the genitalia of nude Iraqi males, and of other equally shameful subject matter. Although most of the soldiers who were present during the crimes in these infamous photographs were military police (MP) soldiers, such investigators as Lieutenant General Anthony Jones and Major General George Fay would later conclude that MI interrogators had encouraged MPs to abuse detainees as part of their interrogation approaches.¹⁷

Before the Abu Ghraib photos were first aired for the American public by *60 Minutes II* on April 28, 2004,¹⁸ few Americans had suspected that any American soldier, let alone a group of American soldiers, was capable of perpetrating such crimes. After April 28, 2004, however, the world would understand differently.

The resulting scandal is today as much a part of America's historical vernacular as "My Lai" and "Watergate." Commonly referred to as simply "Abu Ghraib," this scandal has proven an invaluable recruitment and propaganda tool for America's enemies across the world, to include Iraqi insurgents. "What brought me [to Iraq], for example, is what I

have seen on Al-Jazirah and Al-Arabiya of people in Abu Ghurayb torturing naked people," said one Tunisian fighter captured in Hit, Iraq.¹⁹ Said yet another foreign fighter captured and interrogated in Iraq: "They used to show events [on television] in Abu Ghurayb, the oppression, abuse of women, and fornication, so I acted in the heat of the moment and decided . . . to seek martyrdom in Iraq."²⁰ Matthew Alexander, an Air Force major who led the interrogation team that successfully hunted down Musab al-Zarqawi, said, "I learned in Iraq that the No. 1 reason foreign fighters flocked there to fight were the abuses carried out at Abu Ghraib and Guantanamo."²¹

The scandal also contributed to a significant loss of American political will to continue the fight in Iraq. "We now spend ninety percent of our time talking about the Abu Ghraib stuff, and one percent talking about the valor of the troops," said Bing West, probably the most prominent of the chroniclers of the Marines during OIF.²² A CNN poll taken one month after the scandal broke stated that the support of Americans for the war in Iraq had dropped below 50 percent for the first time, with 27 percent of the Americans polled saying that the scandal had made them "less supportive" of the war.²³ In turn, loss of support for the war among Americans contributed to President Bush's rapidly-diminishing popularity, helped the Democratic Party to eventually take control of the U.S. Congress in January 2007, and inspired the party to then try unsuccessfully to force President Bush to order U.S. troops home. In short, the Abu Ghraib scandal threatened to lead to the defeat of the U.S. in Iraq through the only means the U.S. has ever lost a war--through the loss of political will at home rather than through insurmountable defeat on the battlefield.

What is more, the Abu Ghraib scandal may very well define OIF in the minds of future generations, just as the My Lai Massacre has unfairly defined the Vietnam War for many members of the war's subsequent generations. With the exception of the role that alleged stockpiles of weapons of mass destruction played in the political decision of the U.S. government to invade Iraq, no other subject has engendered even half as many books, editorials, and documentaries about Iraq as the Abu Ghraib scandal. Many of these books, including some masquerading as scholarly appraisals, have such sensational titles as *Torture and Truth: America, Abu Ghraib, and the War on Terror*, *Abu Ghraib: The Politics of Torture*, and *The Torture Papers: The Road to Abu Ghraib*. A common theme in such books is that unfortunate U.S. soldiers during OIF I, the first rotation of U.S. forces in theater, carried out the will of their political and military masters by systematically torturing detainees throughout Iraq.

However, should the actions of a group of officers, soldiers, and contract civilians at Abu Ghraib be considered representative of the actions of U.S. military service members during OIF? Indeed, is this misconduct even representative of the way detainees were handled and questioned by the vast majority of U.S. forces during OIF I?

All U.S. government-sponsored investigations have concluded thus far that the actions of this group at Abu Ghraib were not representative of the actions of other U.S. military service members and contractors in Iraq at the time.²⁴ On February 10, 2004, the Army's Acting Secretary of the Army, R. L. Brownlee, directed Lieutenant General Paul Mikolashek, the Army's Inspector General, to investigate detainee operations across the Army. The resulting Inspector General task force concluded in a report on July 21, 2004 (referred to as the "Mikolashek Report" throughout this history), that "the overwhelming

majority of our leaders and Soldiers understand the requirement to treat detainees humanely and are doing so."²⁵ James R. Schlesinger, former U.S. Secretary of Defense and Central Intelligence Agency (CIA) director, headed a five-member independent panel which published a report on August 24, 2004 (hereafter referred to as the "Schlesinger Report"), and which concluded that the "vast majority of detainees in Guantanamo, Afghanistan and Iraq were treated appropriately, and the great bulk of detention operations were conducted in compliance with U.S. policy and directives."²⁶ On March 10, 2005, the DoD presented the unclassified portion of the report of Vice Admiral Albert T. Church, III, the Navy Inspector General, who had investigated detainee operations across the DoD. This report (hereafter referred to as the "Church Report") assessed that "the vast majority of detainees held by the U.S. in the Global War on Terror have been treated humanely, and that the overwhelming majority of U.S. personnel have served honorably."²⁷ Even Major General Antonio Taguba's initial investigation from January to March 2004 into a deeply troubled unit, the 800th MP Brigade, concluded that investigators had "observed many individual Soldiers and some subordinate units under the 800th MP Brigade that overcame significant obstacles, persevered in extremely poor conditions, and upheld the Army values."²⁸

When judging if the Abu Ghraib scandal is representative of how detainee and interrogation operations were conducted during OIF I, future historians will examine these reports and conclude that either the investigators were lying in order to cover up the crimes committed by the political and military leaders of OIF I, or that these investigators were telling the truth and what MI and MP soldiers did to detainees at Abu Ghraib prison in October 2003 was an especially horrific "exception to the rule" of how detainees were

treated during OIF I. As will be demonstrated in this paper, the latter is closer to the truth; however, less-horrific "exceptions to the rule" clearly existed as well. Thus, one purpose of this history is to provide research and analysis that may someday contribute to a historical corrective of the current widespread misperceptions of interrogation operations during OIF I--misperceptions that mushroomed exponentially in the wake of the Abu Ghraib scandal. A secondary purpose of this history is to analyze the root causes of the abuse of detainees by a few interrogators at a few locales during OIF I and then determine whether these root causes have been sufficiently addressed and corrected by current Army doctrine, force structure, and training.

To accomplish this twofold purpose, this history analyzes a slice of the various command-levels responsible for interrogation operations during OIF I, much as a geologist describes the geological history of a region through the careful study of a slice of the earth's strata in that region. Chapter 2 examines interrogation operations within the "strata" of international law, U.S. national law, and U.S. Army doctrine, describing how the "Law of War" and national law influenced the regulations and doctrine that governed U.S. Army interrogation operations during OIF I. This chapter also outlines shortfalls in doctrine that later inspectors and investigators considered contributing causes of detainee abuse. Chapter 3 analyzes the influence of the Bush Administration on interrogation policies and how the concept of "unlawful combatants" and the administration's re-definition of "torture" set the stage for interrogation abuse. Chapter 4 discusses interrogation operations within CJTF-7, the headquarters that was responsible for military operations in Iraq for almost all of OIF I. Chapters 5 and 6 examine interrogation operations at the tactical level during OIF I, specifically, how CJTF-7's largest division

and largest brigade conducted these operations (and avoided interrogation abuse).

Chapter 7 summarizes what the Army has done to correct the conditions that led to interrogation abuse during OIF I--and indicates where work still needs to be done.

Finally, Chapter 8 puts interrogation abuse during OIF I in its proper perspective.

Ultimately, it is the author's hope that this history--as well as the interviews the author conducted and archived for this history--will prove essential source documents for any researcher seeking a balanced perspective of interrogation operations during OIF I.

¹4th Infantry Division 15-6 Investigation, "Exhibit A (Email correspondences)." *American Civil Liberties Union: Torture FOIA*, October 6, 2003, http://www.aclu.org/torturefoia/released/041905/6570_6668.pdf (accessed February 20, 2009), 53. Although Lieutenant Colonel Hoepner's name is redacted in this email exchange, the author knew the writer--who was the author's boss for five months--during OIF I.

²Thomas E. Ricks, *Fiasco: The American Military Adventure in Iraq* (New York: The Penguin Press, 2006), 290. *Fiasco* is not a work of scholarship but rather is a book that was written to be a bestseller. Consequently, Ricks consistently emphasizes the negative in U.S. efforts in Iraq, deemphasizes the positive, and almost melodramatically presents U.S. civilian and military leaders as either heroes or villains in the "fiasco" he says resulted from the U.S.-led invasion of Iraq. Still, as a source of dramatic, negative anecdotes and as a compendium of harsh criticisms (some surely valid to a degree) of the U.S.'s political and military leadership before, during, and immediately after the invasion of Iraq, it is probably unmatched by any other secondary source published-to-date.

³According to Kenneth Estes in "U.S. Army Soldier," which is the command-supported but privately published campaign narrative of 1AD in Iraq from 2003 to 2004, the end in Baghdad of 91 straight days of temperatures over 100 degrees Fahrenheit occurred on September 6, 2003 (page 6).

⁴Anthony H. Cordesman, "Iraq's Evolving Insurgency: the Nature of Attacks and Patterns and Cycles in the Conflict," *Center for Strategic & International Studies*, http://www.csis.org/media/csis/pubs/060203_iraqicombattrends.pdf (accessed December 4, 2008), 32.

⁵Federal Document Clearing House, "Political/Congressional Transcript Wire: Donald H. Rumsfeld Holds Defense Department News Briefing, November 25, 2003;" *AccessMyLibrary*, http://www.accessmylibrary.com/coms2/summary_0286-2787794_ITM (accessed December 5, 2008).

⁶Joel Brinkley and Eric Schmitt, "U.S. Officers in Iraq Find Few Signs of Infiltration by Foreign Fighters," *The New York Times*, November 19, 2003, <http://query.nytimes.com/gst/fullpage.html?res=950CE1DA163BF93AA25752C1A9659C8B63> (accessed December 5, 2008).

⁷4th Infantry Division AR 15-6 Investigation, 54. Names in this document are redacted. Thomas Ricks in *Fiasco* correctly identifies Captain William Ponce (who was in a promotable status at this time) as the writer of this email.

⁸Ibid.

⁹Nicholas Riccardi, *Los Angeles Times: Interrogator Convicted in Iraqi's Death*, January 22, 2006, <http://articles.latimes.com/2006/jan/22/nation/na-interrogate22> (accessed February 20, 2009). This article is one of many that provides the name of the warrant officer involved in this email exchange. Due to the scandal resulting from his conviction in the death of an Iraqi detainee (see below), CW3 Welshofer's notoriety has earned him his own Wikipedia entry.

¹⁰4th Infantry Division 15-6 Investigation, 53-54.

¹¹Riccardi, *Los Angeles Times*; Josh White, *Washington Post: Documents Tell of Brutal Improvisation by GIs*, August 3, 2005, http://www.washingtonpost.com/wp-dyn/content/article/2005/08/02/AR2005080201941_pf.html (accessed February 20, 2009). As noted in Nicholas Riccardi's article, CW3 Welshofer was convicted in the November 23, 2003, negligent homicide of a former Iraqi general and suspected insurgent leader, Major General Abed Mowhoush. According to Josh White's article, Mowhoush died during an interrogation at the 3ACR's Regimental Detainee Holding Area in al-Qaim: CW3 Welshofer stuffed Mowhoush into a sleeping bag head first, wrapped the bag tightly with electrical cords, then sat on Mowhoush's chest until he suffocated. Mowhoush's death had been preceded by CW3 Welshofer's permitting a CIA agent and local Iraqis working with this CIA agent to physically beat Mowhoush, resulting in several broken ribs for the detainee. During his defense in court, CW3 Welshofer cited the above-mentioned email from Captain Ponce and his previous experience in Afghanistan, stating that he had been simply "taking the gloves off" as directed when he applied an interrogation technique he had used previously in Afghanistan. Based on the crime committed here by the 3ACR's senior HUMINT warrant officer, it is not surprising that the February 2004 report of the International Committee of the Red Cross (ICRC) into detention operations in Iraq listed the 3ACR's Regimental Detainee Holding Area in al-Qaim as one of the five U.S. military detention facilities where significant detainee abuse had taken place during the previous year. The 3ACR also probably operated a second of the five U.S. military detention facilities identified by the ICRC as a main internment facility for abuse, a facility (or facilities) the February 2004 ICRC report identified as the "Al-Baghdadi, Heat Base, and Habbania [sic] Camp in Ramadi governorate." Although this ICRC report did not specify that the 3ACR was the unit responsible for the allegations of abuse collected at Abu Ghraib from detainees who had been previously interned at this location (or locations) from July to

August 2003, the 3ACR was responsible for the Al-Baghdadi/Ramadi/Habbaniya geographical area before it moved west in September 2003 to focus on operations on the Iraq-Syrian border from its new headquarters in al-Qaim.

¹²4th Infantry Division 15-6 Investigation, 54.

¹³Ibid.

¹⁴ Ibid., 59. The name and rank of this 4ID non-commissioned officer is redacted; all that is given is his duty position, which was non-commissioned-officer-in-charge (NCOIC) of the 4ID Interrogation Control Element (ICE). Based on the 4ID ICE NCOIC's email and other indicators, it seems likely that the 4ID's Detainee Holding Area on Forward Operating Base (FOB) Pack Horse was the facility named as one of the five main U.S. military internment areas where detainee abuse had allegedly occurred in the ICRC's February 2004 report. [The ICRC referred in this report to the "Tikrit holding area (former Saddam Hussein Islamic School)" as an alleged center of detainee abuse.] The facility at FOB Pack Horse certainly showed surface indicators of underlying abuse, including a case where a detainee was wrongfully shot and killed on September 11, 2003, for allegedly placing his hands near the concertina wire of his enclosure, and a case where a detainee died on February 8, 2004, due to medical inattention. Also, unsurprisingly, one of the handful of substantiated allegations outside of Abu Ghraib that involved a school-trained interrogator abusing a detainee took place in the 4ID Detainee Holding Area: six weeks after this unidentified 4ID officer recommended to CJTF-7 that interrogators be allowed to hit detainees with closed fists, an interrogator and linguist at the 4th ID interrogation facility repeatedly hit a detainee's back, buttocks, and the bottom of his feet with a baton. In a follow-up interrogation, the same detainee was forced to walk around a table on his knees until his knees were bloody. According to the incident's investigator, the idea for the "techniques" used during this harsh interrogation may have come from the "wish list" document the 4ID ICE NCOIC had sent to CJTF-7 in response to Captain Ponce's email (4th Infantry Division 15-6 Investigation, 43). The ICE NCOIC, who was administered a written reprimand for this case of substantiated interrogation abuse, responded in his rebuttal to this reprimand that he did not believe that the interrogation techniques listed in the army's interrogation field manual were "applicable" [based on context, he probably meant "effective"] in a "counterinsurgency" environment (4th Infantry Division 15-6 Investigation, 27). Worth noting, this non-commissioned officer made the argument in his reprimand that, despite published 4ID policies promoting the humane treatment of detainees, off-the-record remarks made by unidentified senior 4ID leaders had led to interrogator confusion as to the legal status of detainees and how detainees should be treated (4th Infantry Division 15-6 Investigation, 27-28). It is unclear as to what level of command this non-commissioned officer is referring, but certainly the 4th ID suffered disciplinary actions for detainee abuse at higher military ranks than suffered by any other Division during OIF I: Lieutenant Colonel Allen West, Commander of the 2-20th Field Artillery Battalion, was relieved for an incident on August 20, 2003, when he twice fired a pistol near a detainee's head to get the detainee to give information; and Lieutenant Colonel Nathan Sassaman, Commander of the 1-8 Infantry Battalion, received a career-ending written reprimand in his role in the

attempted cover-up of the drowning death of a detainee--a death that had resulted from an abusive practice being perpetrated by one of his platoons.

¹⁵Ibid.

¹⁶The author of this thesis was this battle captain.

¹⁷Lieutenant General Anthony R. Jones, "AR 15-6 Investigation of the Abu Ghraib Prison and 205th Military Intelligence Brigade," *United States Department of Defense Detainees Investigations*, August 25, 2004, <http://www.defenselink.mil/news/Aug2004/d20040825fay.pdf> (accessed March 20, 2009), 4. Based on Major General Antonio Taguba's recommendation in his investigation into the 800th MP Brigade and the Abu Ghraib abuses, on March 31, 2004, Lieutenant General Sanchez appointed Major General George Fay to investigate any role members of the 205th MI Brigade had in detainee abuses. On June 16, 2004, the acting Secretary of the Army, R.L. Brownlee, appointed General Paul Kern, U.S. Army Material Command, to appoint an additional investigating officer that could also investigate the chain of command above the 205th MI Brigade for misconduct. General Kern appointed Lieutenant General Jones to conduct this supplemental investigation on June 26, 2004. (In the U.S. military, an officer cannot find a senior officer guilty of negligence or misconduct. Thus, by appointing Jones to conduct a supplemental investigation, the most senior military leaders of CJTF-7 became potentially subject to a finding of negligence or misconduct--to include Lieutenant General Sanchez himself since Jones outranked Sanchez by date-of-rank.) Jones would find that Sanchez and the CJTF-7 staff held some responsibility for instances of "non-violent and non-sexual abuses" at Abu Ghraib; however, subsequent Army inquiries would absolve Lieutenant General Sanchez, Major General Wojdakowski (the CJTF-7 Deputy Commander) and Major General Barbara Fast (the CJTF-7 senior military intelligence officer) of any wrongdoing. The joint report filed by Jones and Fay is hereafter referred to as the Fay/Jones report.

¹⁸CBS News, *Abuse of Iraqi POWs by GIs Probed*, April 28, 2004, <http://www.cbsnews.com/stories/2004/04/27/60II/main614063.shtml> (accessed December 5, 2008).

¹⁹Ahmed S. Hashim, *Insurgency and Counter-Insurgency in Iraq* (Ithaca: Cornell University Press, 2006), 144-45.

²⁰Ibid., 144.

²¹Matthew Alexander, "I'm Still Tortured by What I Saw in Iraq," *The Washington Post*, November 30, 2008, <http://www.washingtonpost.com/wp-dyn/content/article/2008/11/28/AR2008112802242.html> (accessed April 22, 2009).

²²Ricks, 380.

²³Keating Holland, *CNN, Poll: Support for Bush, Iraq War Dropping*, May 22, 2004, <http://www.cnn.com/2004/ALLPOLITICS/05/14/bush.kerry/index.html> (accessed December 12, 2008).

²⁴Of the major investigations derived from the abuses at Abu Ghraib, only Major Taguba's report had been completed prior to the publication of the infamous Abu Ghraib photos by the press on April 30, 2004. Two other investigations, however, had already been initiated--Major General Fay's investigation into the 205th MI Brigade and the Department of the Army's Inspector General inspection of the U.S. Army's detention operations. Three other major investigations soon followed the media's publication of the Abu Ghraib photos--the investigation of Lieutenant General Jones and Major General Fay into intelligence operations at the CJTF-7 level, the Independent Panel to Review DoD Detention Operations, and the Navy Inspector General's inspection of DoD detention operations. The pages of these reports are among the more than 100,000 declassified and redacted pages pertaining to DoD detention operations during the Global War on Terrorism (GWOT) that can be found on the American Civil Liberty Union's "Torture FOIA" website, <http://www.aclu.org/safefree/torture/torturefoia.html>. Since these reports represent the cumulative efforts of scores of investigators and inspectors and go into far more detail regarding strategic- and operational-level detention and interrogation operations than the author is able to delve into within Chapters 2, 3, and 4 of this paper, the author strongly encourages anyone with a scholar's interest in interrogation operations during the GWOT to consult these sources directly. Also, the U.S. Department of Defense maintains copies of these reports on various websites, copies that have the advantage over documents on the ACLU website of often being saved in word-searchable formats. Probably the most comprehensive site for these reports is on the Office of the Secretary of Defense and Joint Staff Reading Room website, http://www.dod.mil/pubs/foi/detainees/other_related.html#cid_reports. For those of a less scholarly interest in the subject matter, transcripts of press briefings of various investigators and inspectors (which serve well as succinct summaries of key findings), are found on the defenselink website, <http://www.defenselink.mil/news/brieftrans.html>. The best unclassified source of information regarding the influence of national policy on harsh interrogation techniques in Iraq is the Senate Armed Services Committee's *Inquiry into the Treatment of Detainees in U.S. Custody* (November 20, 2008). This report was declassified on April 20, 2009, and it is posted on the committee's website at the following url: http://armedservices.senate.gov/Publications/Detainee%20Report%20Final_April%2022%202009.pdf

²⁵Department of the Army Inspector General, "Detainee Operations Inspection, July 21, 2004," *United States Department of Defense Detainees Investigations*, <http://www4.army.mil/ocpa/reports/ArmyIGDetaineeAbuse/DAIG%20Detainee%20Operations%20Inspection%20Report.pdf> (accessed November 2, 2008), 3. The specific scope of the investigation was to inspect detainee operations in Iraq, Afghanistan, and the continental U.S.. (The team did not inspect detention operations at Guantanamo Bay, Cuba.) The Inspector General's methodology was as follows: "Two teams conducted inspections of 25 locations in Iraq, Afghanistan, and the Continental United States (CONUS). The CONUS team consisted of seven personnel, including augmentees, and

visited seven locations while the OCONUS team consisted of nine personnel, including augmentees, and inspected 16 locations. We interviewed and surveyed over 650 leaders and Soldiers spanning the ranks from Private to Major General. We also reviewed 103 reports of allegations of abuse from Criminal Investigation Division (CID) and 22 unit investigations that cover the period of September 2002 to June 2004" (Mikolashek Report, 25).

²⁶James R. Schlesinger, Harold Brown, Tillie K. Fowler, and General Charles A. Horner, "Final Report of the Independent Panel to Review DoD Detention Operations," August 23, 2004, *United States Department of Defense Detainees Investigations*, <http://www.defenselink.mil/news/Aug2004/d20040824finalreport.pdf> (accessed November 2, 2008), 18. Secretary of Defense Donald Rumsfeld requested the formation of this panel on May 12, 2004 to review DoD Detention Operations. This panel examined detention operations across the DoD, to include in Iraq, Afghanistan, and Guantanamo Bay. As part of its methodology, the panel reviewed all significant investigations into DoD detention operations during the previous two years as well as interviewed any senior DOD political or military leader with significant influence on DoD detention operations, to include Rumsfeld himself.

²⁷Department of the Navy Inspector General, "Review of Department of Defense Detention Operations and Detainee Interrogation Techniques," *The Office of the Secretary of Defense and Joint Staff Reading Room, Detainee Related Documents*, March 7, 2005, http://www.dod.mil/pubs/foi/detainees/church_report_1.pdf (accessed February 10, 2009), 21. This investigation, which Rumsfeld chartered two weeks after he chartered Schlesinger's Independent Panel, took nearly ten months to complete and was focused on analyzing any role interrogation policies and specific interrogation techniques may have played in the abuse of detainees by U.S. military interrogators. When appointing Admiral Church to conduct this investigation, Rumsfeld directed that all of DoD allow the Naval Inspector General (IG) Team complete and unfettered access to any available DoD documentary evidence pertaining to detention operations. In addition to surveying vast troves of documentary evidence, according to page one of the Executive Summary, the investigation "included over 800 interviews with personnel serving or having served in Iraq, Afghanistan and Guantanamo Bay, Cuba and senior policy makers in Washington." The Executive Summary for this report is unclassified; the rest of this report is slightly redacted.

²⁸General Antonio Taguba, "AR 15-6 Investigation of the 800th Military Police Brigade, May 27, 2004," *American Civil Liberties Union: Torture FOIA*, <http://www.aclu.org/torturefoia/released/TR3.pdf> (accessed December 12, 2008), 60. As of May 5, 2009, this report had not been posted on the DoD defense link website; instead, an unclassified, word-searchable extract has been published on the Department of the Army's IG website. The entire, redacted version of this report can only be found on the ACLU website. Unfortunately, this version of the report is not by-word searchable. At the time of this investigation, Major General Taguba was the Deputy Commanding General Support for the Coalition Forces Land Component Command, a command that was headquartered in Kuwait. Major General Taguba's investigation primarily addressed

the 800th Military Police Brigade and the role several of this brigade's members played in the most infamous of the abuses at Abu Ghraib. Although Major General Taguba collected some evidence that is relevant to interrogation operations at Abu Ghraib, the investigations conducted by Lieutenant General Anthony Jones and Major General George Fay into the interrogation operations of CJTF-7 and the 205th Military Intelligence Brigade respectively, are more relevant to interrogation operations in Iraq during OIF I.

CHAPTER 2

"IT'S JUST NOT RIGHT"

Army professionalism is moral because the capability to wield tools of destruction in a brutal environment carries with it a moral responsibility. Our professional moral imperative derives from ancient ethical and religious standards. The Law of Land Warfare, the Uniform Code of Military Justice, and the Code of Conduct give structure to the moral imperative. The moral and ethical tenets of the Constitution, the Declaration of Independence, and Army values characterize the Army's professional ideals. As the environment of conflict becomes more complex, this moral dimension of Army professionalism takes on greater importance.¹

— Army Field Manual (FM) 1, *The Army*

Our doctrine is not right. It's just not right. I mean, there are so many things that are out there that aren't right in the way that we operate for this war. This is a doctrinal problem of understanding where you bring, what do the MPs do, what do the military intelligence guys do, how do they come together in the right way. And this doctrinal issue has got to be fixed if we're ever going to get our intelligence right to fight this war and defeat this enemy.²

— General John Abizaid,
Commander of U.S. Central Command

On May 19, 2004, the courts martial of an Army staff sergeant³ and specialist⁴ began at the CJTF-7 Headquarters, Camp Victory, Baghdad. These two courts martial would be the first trials of the "Abu Ghraib Nine"--seven MP soldiers and two MI soldiers who would be court martialed for the detainee abuses they had either committed or allowed to occur at the Abu Ghraib Prison. Ultimately, eight of the "Abu Ghraib Nine" would be sentenced to prison. A recurring theme of the testimony of soldiers during these courts martial, to include the courts martial of the Army staff sergeant and specialist mentioned above, would be that MP soldiers had often abused detainees at the order (or at least with the tacit approval) of MI interrogators. According to numerous testimonies, MI soldiers had expected MP soldiers at Abu Ghraib Prison to abuse detainees so that these detainees would be "softened up" for interrogations.

Also on May 19, 2004, and halfway across the world, General Abizaid, Lieutenant General Sanchez, Major General Geoffrey Miller (Deputy Commander for Detainee Operations, Multinational Force-Iraq), and Colonel Marc Warren (CJTF-7 Judge Advocate General) testified about the abuses at Abu Ghraib Prison before a much different audience--the U.S. Senate Armed Services Committee.⁵ During this hearing, General Abizaid testified that the causes of the Abu Ghraib abuses had not been simply criminal misconduct but a "breakdown in procedures."⁶ General Abizaid also impassionededly referred to a "doctrinal issue" that had left MI and MP soldiers unclear about their respective roles in interrogation operations.⁷

As evidenced by these testimonies delivered on the same date by soldiers of vastly different ranks and levels of responsibility in two very different locations, U.S. Army interrogation doctrine during OIF I was, if not grossly deficient, at the very least unclear. The purpose of this chapter is to lay bare these ambiguities.

Interrogations and Law

International law has long been the foundation of the U.S. Army's interrogation-related doctrine. During OIF I, this international law consisted primarily of the four conventions which were adopted in Geneva, Switzerland, on August 12, 1949, and which were ratified by the U.S. Congress on August 2, 1955.⁸ Of these four conventions, Conventions I, III and IV potentially pertained to interrogation operations during OIF I. Convention I, which contains nine parts and 64 articles, covers the treatment of wounded soldiers on the battlefield; Convention III, which is divided into six parts and 143 articles, deals with the treatment of Enemy Prisoners of War (EPWs); and Convention IV, which is divided into four parts and 159 articles, deals with the protection of civilians in time of

war.⁹ All of these conventions give extensive rights to certain categories of detainees. The War Crimes Act of 1996 was the U.S. law which implemented the Geneva Conventions of 1949 and which was in effect during OIF I: this act made "grave breaches" of any articles of the Geneva Conventions a crime.¹⁰

Legal controversy during the Global War on Terrorism (GWOT) has revolved around the applicability of the Geneva Conventions to a type of detainee that the Bush Administration labeled "unlawful combatants." As defined by the Military Commissions Act of 2006, an "unlawful combatant" is "a person who has engaged in hostilities or who has purposefully and materially supported hostilities against the United States or its co-belligerents who is not a lawful enemy combatant (including a person who is part of the Taliban, al Qaeda, or associated forces)." This legislation then defines a "lawful enemy combatant" as "a member of the regular forces of a State party engaged in hostilities against the United States" or "a member of a militia, volunteer corps, or organized resistance movement belonging to a State party engaged in such hostilities, which are under responsible command, wear a fixed distinctive sign recognizable at a distance, carry their arms openly, and abide by the law of war;" or who is "a member of a regular armed force who professes allegiance to a government engaged in such hostilities, but not recognized by the United States."

This definition of "unlawful combatant" derives from a precise reading of the "unencumbered" verbiage of the Geneva Conventions (that is, reading the conventions without referencing the body of interpretative jurisprudence that has been established in international courts since the U.S. ratified the treaty in 1955.) According to such a reading, Convention III applies only to EPWs, who it defines as prisoners who, at their

time of capture, had fixed distinctive sign (such as a uniform), carried arms openly, and operated in accordance with the laws of war.¹¹ In addition, such a reading of Convention IV shows that this convention does not protect combatants who pose a security risk to the United States: Article 5 of this convention states that when a person is "definitely suspected of or engaged in activities hostile to the security of the State, such individual person shall not be entitled to claim such right and privileges under the present Convention as would, if exercised in the favor of such individual person, be prejudicial to the security of such State."¹²

The U.S. Supreme Court has upheld the Bush Administration's definition of "unlawful combatant" with one notable exception: in its landmark June 29, 2006, decision in the case of *Hamdan vs. Rumsfeld*, the U.S. Supreme Court ruled that Common Article 3 of all four Geneva Conventions applies to all detainees held on the territory of a signatory to the Geneva Conventions.¹³ The general protections provided by Common Article 3 to detainees include protection from "violence to life and person," "taking of hostages," "outrages upon personal dignity," and "the passing of sentences and the carrying out of executions without previous judgment pronounced by a regularly constituted court."¹⁴ Common Article 3 also stipulates that these detainees, when wounded and sick, "shall be collected and cared for."¹⁵

The United Nations' "Convention against Torture and other Cruel, Inhuman, or Degrading Treatment or Punishment," which the U.S. ratified on October 21, 1994, gave additional protection to all U.S. detainees.¹⁶ Specifically, the "1994 Torture Convention" prohibited the infliction of torture and any "other acts of cruel, inhuman or degrading treatment or punishment."¹⁷ When ratifying this treaty, however, the U.S. government

did so with the understanding (or "reservation") that there was nothing in this convention that required additional action beyond national law (such as the 8th Amendment's prohibition against members of the U.S. government inflicting "cruel and unusual punishment").¹⁸ Thus, this ratification did not become important until its implementing U.S. legislation (U.S. Code, Title 18, Chapter 113C) was passed in October 1994 by the U.S. Congress. This new law prohibited U.S. citizens and others persons within U.S. jurisdiction from committing any act "specifically intended to inflict severe physical or mental pain or suffering (other than pain or suffering incidental to lawful sanctions) upon another person within his custody or physical control."¹⁹ It also defined "severe mental pain or suffering" as "prolonged mental harm" caused by the "intentional infliction or threatened infliction of severe physical pain or suffering," the administration of "mind-altering substances," the "threat of imminent death," or the threat that another person will be imminently "subjected to death, severe physical pain or suffering, or . . . mind-altering substances."²⁰

To summarize, it was not clear during OIF I that any article of the Geneva Conventions applied to "unlawful combatants." However, the "Torture Convention of 1994" and the U.S. law that implemented this treaty protected all U.S. detainees--even "unlawful combatants"--from "severe physical or mental pain or suffering" at the hands of U.S. citizens.

Interrogations and UCMJ, Regulations, and Doctrine

While international law and its implementing U.S. criminal code provided only limited protection for "unlawful combatants," the Uniform Code of Military Justice (UCMJ) gave extensive protection to all detainees in U.S. military custody. U.S. Code,

Title 10, Chapter 47 (or UCMJ) was signed into law on August 10, 1956. This law provides several punitive articles that could be applied to U.S. military service members if these service members were to mistreat detainees, including Article 78 (accessory after the fact), Article 80 (inchoate offense of attempt), Article 81 (conspiracy), Article 82 (solicitation), Article 93 (cruelty and maltreatment), Article 118 (murder), Article 119 (manslaughter), Article 124 (maiming), Article 128 (assault), and Article 134 (communicating a threat and negligent homicide).²¹ (It would be violations of articles of the UCMJ that would ultimately send the "Abu Ghraib Nine" to prison.)

In addition to protections provided by the UCMJ, "unlawful combatants" were potentially protected by the directives and regulations of the U.S. Department of Defense (DoD) and its proponent for detainee operations, the U.S. Army. Prior to OIF I, both the DoD and the U.S. Army had published directives and regulations giving full Geneva protections to any U.S. military detainee. DoD Directive 5100.77, published on December 9, 1998, stated that "the Heads of the DoD Components" must ensure "that the members of their DoD Components comply with the law of war during all armed conflicts, however such conflicts are characterized, and with the principles and spirit of the law of war during all other operations."²² Additionally, Army Regulation 190-8, *Enemy Prisoners of War, Retained Personnel, Civilian Internees and Other Detainees* (October 1, 1997), stated that all "persons taken into custody by U.S. forces will be provided with the protection of the GPW [Geneva Conventions Relative to the Treatment of Prisoners of War] until some other legal status is determined by competent authority.

U.S. Army military intelligence doctrine during OIF I extended full Geneva protections to all Army detainees. FM 34-52, *Intelligence Interrogation* (September

1992), represented this doctrine during OIF I. The preface to this manual stated that Army interrogations were to be conducted within the constraints established by the Geneva Conventions.²³ The section titled "Prohibition Against Use of Force" in Chapter 1 gave four reasons why interrogators needed to apply the law of war in all cases: first, acts of violence, intimidation, torture, threats, insults, and inhumane treatment were illegal; secondly, the "use of torture and other illegal methods was a poor technique that yields unreliable results"; thirdly, the use of such techniques would undermine domestic and international support for the war effort; and fourthly, the use of such techniques would place U.S. personnel who are captured at greater risk of similar abuse from their captors.²⁴ This section went on to list examples of illegal physical torture, to include "electric shock," "infliction of pain through chemicals or bondage, forcing an individual to stand or kneel for prolonged periods, food deprivation, any form of beating," "mock executions," and "abnormal sleep deprivation."²⁵ Also listed were unlawful examples of coercion, such as threatening a subject with abuse or intentionally depriving them of medical assistance if they were to withhold information.²⁶ Of great importance here, however, was the fact that this doctrine was not legally binding.

U.S. Army military police doctrine during OIF I also extended full Geneva protections to any Army detainee. FM 3-19.40, *Internment/Resettlement Operations*, 1 August 2001, defined all military detainees with reference to Army Regulation 190-8 and specific articles of the Geneva Conventions. According to this FM, an EPW, who is defined as a detainee meeting the criteria for EPWs set forth in Article 4 of Convention III, must receive the extended protections of Convention III; a Civilian Internee (CI), who is defined as a detainee who is a security risk (specifically written to include insurgents),

must be treated in accordance with all of the provisions of Convention IV; a Retained Person (RP), who is defined as medical personnel, chaplains, and members of duly recognized voluntary aid organizations, must receive the same rights as EPWs; and an Other Detainee (OD), who is a detainee classified as neither an EPW nor a CI, must be treated as an EPW until "a legal status is ascertained by competent authority."²⁷ Also, this field manual made it clear that working dogs could only be used for security purposes (and not for coercing intelligence from detainees).²⁸

Interrogation Approaches in Army Doctrine

FM 34-52, *Intelligence Interrogation*, September 1992, outlined 17 interrogation approaches that could be used by U.S. military interrogators. Of these 17 approaches, the field manual states that the "Direct" approach is "the most effective:" it is "always the first to be attempted," and it was shown to be "90 percent effective as an approach during World War II and 95 percent effective during Operations Urgent Fury, Just Cause, and Desert Storm." Conversely, the "Fear Up" approaches are identified as having "the greatest potential to violate the law of war" and as working on only a limited number of detainees, that is, detainees who are young, inexperienced, and "exhibit a greater than normal amount of fear or nervousness." Of the three "Fear Up" approaches, the "Fear-Up (Harsh)" approach is singled out as "usually a dead end," and interrogators are cautioned to use this approach only as a final "trump card."

Unfortunately, this field manual did not specify what techniques interrogators could use when employing a specific interrogation approach. Interrogators were reminded throughout the manual to conduct interrogations in accordance with the Law of War, and Figure 1-4 of the manual lists the articles of the Geneva Conventions that are

most pertinent to interrogations. Nonetheless, it is not always apparent how the Law of War applies to all of the potential techniques used to implement a given approach. Strip searches were sanctioned by MP doctrine, but could MI interrogators use the technique of "Forced Nudity" as part of a "Pride and Ego-Down" approach? The Geneva Conventions expressly prohibited the employment of "prolonged standing" and "punishment drills" as detainee control measures, but did this apply to making a detainee assume other stress positions or doing light, non-injurious exercise? Could an interrogator lawfully alter a detainee's sleep cycle as part of a Rapid Fire approach? Could military working dogs be used to apply a Fear Up Harsh approach? Unit policy writers and interrogators, it seems, had to apply their own judgment as to the legality of specific techniques.²⁹

Leaving the legality of specific techniques to the judgment of staff officers and interrogators would contribute to interrogation abuse during OIF I. This stands to reason: if the top military and civilian lawyers in the country could debate for years over the legality of certain interrogation techniques (a debate discussed further in Chapter 3), how could tactical-level personnel be expected to know which techniques lawfully supported doctrinal interrogation approaches?

Tony Lagouranis, a former Army interrogator, describes his heavy reliance on the "Fear Up Harsh" interrogation approach in *Fear Up Harsh: An Army Interrogator's Dark Journey through Iraq*.³⁰ When in Iraq in 2004, Lagouranis used such harsh techniques as inducing hypothermia and using dogs to implement a "Fear Up Harsh" approach. He had picked up these techniques from hearsay and poor examples set by other, more senior and experienced interrogators. Although emotionally conflicted at using techniques that seemed to run counter to the Law of War, he felt he could use such techniques because

they seemed to be acceptable in theater and because his previous training had not explicitly prohibited these specific techniques.

Table 1. U.S. Army Doctrinal Interrogation Approaches during OIF I

U.S. Army Doctrinal Interrogation Approaches during OIF I		
1	Direct	"The interrogator asks questions directly related to information sought, making no effort to conceal the interrogation's purposes."
2	Incentive	". . . based on the application of inferred discomfort upon an EPW or detainee . . . must not amount to a denial of basic human needs"
3	Emotional Love	"This approach usually involves some incentive such as communication with the source's family."
4	Emotional Hate	"The emotional hate approach focuses on any genuine hate, or possibly a desire for revenge, the source may feel."
5	Fear-Up (Harsh)	"In this approach, the interrogator behaves in an overpowering manner with a loud and threatening voice."
6	Fear-Up (Mild)	"In most cases, a loud voice is not necessary . . . fear is increased by helping the source realize the unpleasant consequences the facts may cause..."
7	Fear-Down	"This technique is nothing more than calming the source" and "works best if the source's fear is unjustified."
8	Pride and Ego-Up	"The source is constantly flattered into providing certain information in order to gain credit."
9	Pride and Ego-Down	". . . based on attacking the source's sense of personal worth."
10	Futility	". . . the interrogator convinces the source that resistance to questioning is futile."
11	We Know All	"the interrogator convinces the source that resistance is useless as everything is already known."
12	File and Dossier	A substantial-looking file and dossier is created. Goal is to convince source that "everything is known . . ."
13	Establish Your Identity	"The interrogator insists the source . . . [is] an infamous individual. . . . In an effort to clear himself . . . the source . . . may provide . . . information."
14	Repetition	"the interrogator listens carefully to a source's answer to a question, and then repeats the question and answer several times."
15	Rapid Fire	the interrogator uses rapid fire questions that confuse the source, "the interrogator then confronts the source with the inconsistencies"
16	Silent	". . . the interrogator says nothing to the source, but looks him squarely in the eye . . . [until] the interrogator is ready to break silence"
17	Change of Scene	"The idea . . . is to get the source away from the atmosphere of an interrogation room" so that they are more comfortable.

Source: Headquarters, Department of the Army, Field Manual (FM) 34-52, *Intelligence Interrogation* (Washington, DC: Government Printing Office, 1992), 3-10 to 3-20.

Colonel John Custer (now Major General Custer) was probably the first GWOT investigator to refer to this significant doctrinal shortfall. After his August 14 to September 4, 2002, investigation of interrogation operations at Guantanamo Bay, Colonel Custer pointed out that some interrogators might adopt an overly conservative interpretation of the interrogation approaches of FM 34-52, resulting in their hands being tied to the degree that they could not effectively employ these approaches, whereas other interrogators might feel unconstrained in their reading of this field manual.³¹ Thus, Colonel Custer said, U.S. Southern Command should develop a metric clearly delineating what techniques were permissible for their interrogators.³²

From the vantage point of Abu Ghraib, it is apparent that not only U.S. Southern Command but also the U.S. DoD should have followed Colonel Custer's advice: clearly, an unambiguous, DoD-wide "metric" of acceptable interrogation techniques could have prevented interrogation abuse during OIF I. Or, as expressed by the Schlesinger Report, "We cannot be sure how the number and severity of abuses would have been curtailed had there been early and consistent [interrogation] guidance from higher levels."³³

Ambiguities and Inconsistencies

Official government inspectors and investigators have identified other shortfalls in U.S. doctrine that contributed to the abuse of detainees during interrogations. One of the recurring findings of these inspectors and investigators was the same finding impassionedly expressed by General Abizaid in his senate testimony, specifically, the failure of MI and MP doctrine to consistently describe exactly how MP soldiers at detention facilities should support interrogation operations.

On this subject, Lieutenant General Jones wrote the following:

MP personnel and MI personnel operated under different and often incompatible rules for treatment of detainees. The military police referenced DoD-wide regulatory and procedural guidance that clashed with the theater interrogation and counterresistance policies that the military intelligence interrogators followed. Further, it appeared that neither group knew or understood the limits imposed by the other's regulatory or procedural guidance concerning the treatment of detainees, resulting in predictable tension and confusion. This confusion contributed to abusive interrogation practices at Abu Ghraib.³⁴

The most striking doctrinal inconsistency, as noted in the Mikolashek Report, was that while MP doctrine gave MPs a passive role when supporting interrogations (MPs could only pass observations on to interrogators regarding detainee behavior), MI doctrine implied an active role for MPs in the screening process, to include MI interrogators telling MP guards "what types of behavior on their part will facilitate the screenings."³⁵

Perhaps surprisingly, a majority of the major reports on DoD interrogation operations during the early years of the GWOT favored MP guards actively setting the conditions for interrogations. First, Colonel Stuart Herrington, a retired Army military intelligence officer who visited the U.S. strategic internment facility at the naval base at Guantanamo Bay, Cuba, on March 16-21, 2002, and who had previously gained extensive interrogation experience in Vietnam, Panama, and Operation Desert Storm, argued strongly in favor of MP guards setting conditions for interrogations.³⁶ In his trip report, Herrington noted, "one day, we might instruct the guards to be particularly warm and cheerful toward a given detainee . . . on another day, with a different detainee, a cold, firm demeanor by the guards might be more suitable."³⁷ Other inspectors of interrogation operations in various theaters, such as Colonel John Custer, Major General Geoffrey Miller, Schlesinger's Independent Panel, and Vice Admiral Church's Navy Inspector General team have concurred with Herrington's assessment. For example, the Church

Report stated that, "When conducted under controlled conditions, with specific guidance and rigorous command oversight, as at GTMO, this is an effective model that greatly enhances intelligence collection and does not lead to detainee abuse."

Major General Antonio Taguba and Major General Donald Ryder disagreed, strongly asserting that MPs should have no role outside the interrogation room in actively setting the conditions for future interrogations. Major General Ryder, who inspected detention operations in Iraq from October 13 to November 6, 2003, and who was the Army's Provost Marshal General during OIF I, stated in his November 6, 2003, report that the active setting of conditions for interrogations by military police runs "counter to the smooth operation of a detention facility, [which is] attempting to maintain its population in a compliant and docile state."³⁸ The Mikolashek Report and the Fay/Jones Report were neutral in this matter, essentially arguing that it matters less whether MPs actively or passively set conditions for interrogators than that Army doctrine is consistent.

Of still greater import, Army intelligence doctrine during OIF I was not designed for counterinsurgency operations on a non-contiguous battlefield. This issue is discussed in *On Point II, Transition to the New Campaign: The United States Army in Operation Iraqi Freedom, May 2003 - January 2005*, which is as close to an official history of OIF I and OIF II as the Army is likely to produce for at least a decade. *On Point II* describes a "paradigm shift" that occurred during OIF I as intelligence became a bottom-up-driven process rather than a top-down-driven process.³⁹ This book notes that intelligence shifted from being supplied primarily by division-level and higher units to being supplied primarily by brigades, battalions, and companies.⁴⁰ This shift took place largely due to

the lack of intelligence supplied to tactical units by CJTF-7 and higher echelons.⁴¹ In addition, a shortage of MI personnel at the brigade- and battalion-levels meant that soldiers at these levels had to assume HUMINT roles for which they had not been trained, to include running sources and conducting interrogations.⁴²

The Schlesinger Report makes similar observations, saying that doctrine needs to be changed to reflect the fact that the vast majority of intelligence collection was taking place in "line combat units."⁴³ This report states that "current doctrine assumes a linear battlefield" where detainees can be speedily transferred to the rear for the timely gathering of intelligence by corps-level interrogators.⁴⁴ However, the modern battlefield is more likely to be a non-contiguous battle space where there are "no safe areas behind 'friendly lines'."⁴⁵ On such battlefields, it is usually impossible or at least very risky to expedite the movement of detainees to the rear. In Iraq, this report notes, detainees were routinely held up to 72 hours in line units even though doctrine states that combat units should hold onto detainees for 12-24 hours only.⁴⁶ At Corps level, the problem was even worse, with detainees being held at Corps holding areas for 30 to 45 days before being sent to a prison or the theater internment facility.⁴⁷

Another doctrinal issue may be the most significant doctrinal issue of all. As will be described further in this history (particularly chapter 5), the quality of an interrogation unit's ethical leadership played a decisive role in OIF I in ensuring that units refrained from engaging in interrogation abuse and, by so refraining, that they remained strategically effective. Speaking to this, the Schlesinger Report says:

For the U.S., most cases for permitting harsh treatment of detainees on moral grounds begins with variants of the "ticking time bomb" scenario. . . . Such cases raise a perplexing moral problem: Is it permissible to employ inhumane treatment

when it is believed to be the only way to prevent loss of lives? In periods of emergency, and especially in combat, there will always be a temptation to override legal and moral norms for morally good ends. Many in Operations Enduring Freedom and Iraqi Freedom were not well prepared by their experience, education, and training to resolve such ethical problems.⁴⁸

The panel concludes that "major service programs, such as the Army's 'core values' . . . are grounded in organizational efficacy rather than the moral good" and that these values "do not address humane treatment of the enemy and noncombatants, leaving military leaders and educators an incomplete tool box with which to deal with 'real-world' ethical problems."⁴⁹

Why was the Schlesinger Panel unimpressed with our Army's basic tool for ethical decision-making, our "Army Values" paradigm? It was probably because the six "values" of this paradigm ("Loyalty, Duty, Respect, Selfless Service, Honor, Integrity, and Personal Courage") are broad ideals, not definitive guidelines or a practical methodology for solving specific ethical problems. In fact, these values can actually be used to support an interrogator's use of "the ticking time bomb" rationale. One can argue, for example, that Abu Ghraib interrogators displayed their "loyalty" to their Army, unit, and other troops by using harsh techniques to save the lives of these troops; they did their "duty" by working hard and displaying initiative; they treated detainees with the "respect" they deserved (which was with no respect, since these detainees were suspected terrorists and criminals); they exercised "selfless service" by doing hard, dirty work for good ends; they showcased "honor" by living up to the other Army values; they demonstrated "integrity" by using only those harsh techniques which they believed to be approved for use; and they exhibited "personal courage" by deliberately agitating dangerous detainees. Thus, what seems patently obvious to most Americans--that, say, leaving an untried

suspect naked, alone, and shivering in a brightly lit, air-conditioned cell for days at a time is behavior that is inconsistent with our nation's core values--is easily lost when leaders apply our Army's basic tool for ethical decision-making.

This is not to say that this tool actually condones harsh interrogation techniques. After all, this same tool could also be used to argue that certain interrogators at Abu Ghraib were disloyal to the U.S. Constitution when they punished detainees without "due process of law;" that they failed in their duty to enforce the prohibition of Common Article 3 of the Geneva Convention's against committing "outrages upon personal dignity, in particular humiliating and degrading treatment" of captives;¹ and that they violated their integrity by thus breaking the law. However, this argument can truly only be made in the light of later U.S. Supreme Court decisions. During OIF I, the legal limits of interrogation techniques were hotly debated by the U.S.'s most senior civilian and military lawyers and were not at all clear to politicians, military leaders, or interrogators. Thus, what the Army needs is a different tool, or at least a sharper tool, to more usefully guide ethical decision-making when laws are ambiguous (as they often are).

Various inspectors and investigators noted other doctrinal shortfalls related to interrogations during OIF I, to include the following deficiencies:

1. A lack of clear command responsibility at detention facilities. (What commander should have command responsibility of a detention facility?)
2. A lack of clear staff responsibility for detainee operations. (What deputy commander or staff section has overall responsibility for detainee operations within a specific unit?)

3. A lack of doctrine concerning the handling and training of contract personnel, especially contract interrogators and interpreters. (How are contract personnel counseled and disciplined? What training do contract personnel receive prior to deploying and upon arriving in theater?)

4. A lack of competent interpreters and a lack of mature, experienced interrogators capable of establishing an advantageous relationship with older, savvy detainees. (Are MI forces sufficiently augmented with contract interrogators and interpreters?)

5. A lack of doctrine concerning the handling of interrogations by non-military agencies, particularly the Central Intelligence Agency (CIA), in Army facilities. (What are DoD procedures for handling detainees from other governmental agencies?)

6. A lack of doctrine concerning interrogator access to the medical records of detainees. (Should interrogators be allowed access to these records? If so, how much access?)

7. A lack of doctrine defining the role of behavioral science personnel in support of interrogation activities. (What tasks should and should not be performed by behavioral science personnel?)

Key Conclusions

During OIF I, it was not clear among interrogators or their leaders whether "unlawful combatants" (a category that described the vast majority of insurgents captured in Iraq) were entitled to the protections of any article of the Geneva Conventions. However, the "Torture Convention of 1994" and its implementing law in the U.S. protected all U.S. detainees in Iraq from "severe physical or mental pain." Furthermore,

the UCMJ protected all U.S. military detainees from grosser forms of mistreatment. What is more, DoD and Army directives ordered U.S. service members to extend full Geneva protections to all U.S. military detainees: if these directives had been enforced and detainees had been provided full Geneva protections, there is little doubt but that interrogation abuse during OIF I would have been greatly curtailed.

Yet, these directives were not consistently enforced. Why was this the case? As described above, part of the answer lays in the ambiguities and inconsistencies of doctrine during OIF I. As we shall see in the next chapter, however, the greater part of this answer lies within the interrogation-related policies of the Bush Administration.

¹Department of the Army, Field Manual 1, *The Army* (Washington, DC: U.S. Government Printing Office, 2001), 8.

²Federal Document Clearing House, Senate Armed Services Committee, "Hearing on Treatment of Iraqi Prisoners, May 19, 2008," *American Civil Liberties Union: Torture FOIA*, <http://www.aclu.org/projects/foiasearch/pdf/DODDOA010336.pdf> (accessed December 9, 2008), 49.

³III Corps Headquarters, "Verbatim Record of Trial, Staff Sergeant Ivan Frederick, September 21, 2005," *American Civil Liberties Union: Torture FOIA*, <http://www.aclu.org/projects/foiasearch/pdf/DOD041193.pdf> (accessed December 12, 2008), 2.

⁴III Corps Headquarters, "Verbatim Record of Trial, Specialist Jeremy Sivits," January 27, 2005, *American Civil Liberties Union: Torture FOIA*, <http://www.aclu.org/projects/foiasearch/pdf/DOD002393.pdf> (accessed December 12, 2008), 4.

⁵Federal Document Clearing House, Senate Armed Services Committee, 1.

⁶*Ibid.*, 49.

⁷*Ibid.* Regarding this same doctrinal issue, Senator Ted Kennedy would direct perhaps the toughest question of the hearing to Major General Miller. Specifically, Senator Kennedy asked Major General Miller whether, if Miller had indeed recommended to Lieutenant General Sanchez prior to the Abu Ghraib abuses that "the guard force be actively engaged in setting the conditions for the successful exploitation of the internees," then did Miller accept responsibility for the abuses committed by MP

soldiers trying to set conditions for successful interrogations? Miller's answer to Senator Kennedy's question was that he had never recommended to Lieutenant General Sanchez that military police soldiers "actively participate" in the interrogation process. But rather, Major General Miller said, he had recommended that military police soldiers set the conditions for interrogations by employing "passive intelligence gathering." This meant, he said, that MP soldiers should "observe the detainees, to see how their behavior was, to see who they would speak with and then to report that to the interrogators" (pages 25-26). Major General Miller's testimony in this regard is incomplete and, perhaps, circumspect. After all, according to both the Church Report and the Schlesinger Report, MPs at GTMO actively set conditions for successful interrogations by giving incentives to detainees (or taking away these incentives) as directed by GTMO interrogators. However, it should be noted that this condition-setting at GTMO had never been abusive, and both the Church Report and the Schlesinger Report (among other reports) concluded that this was a humane, effective practice. Due to the harsh circumstances surrounding his testimony (which some partisan commentators characterized as a "witch hunt"), it is not surprising that Miller was probably somewhat circumspect in his testimony.

⁸International Committee of the Red Cross, *Geneva Conventions of 12 August 1949*, <http://www.icrc.org/ihl.nsf/WebSign?ReadForm&id=375&ps=P> (accessed December 12, 2008). This website lists the dates each signatory country ratified the Geneva Conventions of 1949. To access the text of all four conventions, one should go to the ICRC website in English, <http://www.icrc.org/eng>. Then, one navigates to the text of the Geneva Conventions through the hyperlink on the left side of the website.

⁹International Committee of the Red Cross, *The Geneva Conventions: The Core of International Humanitarian Law*, January 9, 2006, <http://www.icrc.org/Web/Eng/siteeng0.nsf/htmlall/genevaconventions> (accessed December 9, 2008).

¹⁰United States of America, *Torture, U.S. Code, Title 18, Chapter 113C*, April 30, 1994, <http://www.icrc.org/ihl-nat.nsf/> (accessed February 10, 2009). The ICRC website contains the national laws and military regulations that implement the Geneva Conventions by signatory country. To find these laws, simply navigate from this site to the implementing laws and regulations that are specific to the U.S. government.

¹¹International Committee of the Red Cross, "Convention (III) Relative to the Treatment of Prisoners of War, 1949," *International Humanitarian Law -- Treaties & Documents*. August 12, 1949, <http://www.icrc.org/ihl.nsf/7c4d08d9b287a42141256739003e636b/6fef854a3517b75ac125641e004a9e68> (accessed February 10, 2009).

¹²Ibid.

¹³Supreme Court of the United States, "Hamdan v. Rumsfeld, Secretary of Defense, Et Al," *Supreme Court of the United States*, June 29, 2006, <http://www.supremecourtus.gov/opinions/05pdf/05-184.pdf#search=%22Salim%20Ahmed%20Hamdan%20and%20Supreme%20Court%20decision%22> (accessed February 10, 2009). Specifically, the U.S. Supreme Court opined that "Common Article 3, by contrast,

affords some minimal protection, falling short of full protection under the Conventions, to individuals associated with neither a signatory nor even a non-signatory 'Power' who are involved in a conflict 'in the territory of' a signatory" (page 75).

¹⁴International Committee of the Red Cross, "Convention (IV) Relative to the Protection of Civilian Persons in Time of War," *International Humanitarian Law--Treaties & Documents*, August 12, 1949, <http://www.icrc.org/ihl.nsf/7c4d08d9b287a42141256739003e636b/6756482d86146898c125641e004aa3c5> (accessed February 10, 2009).

¹⁵*Ibid.*

¹⁶United Nations, "Convention Against Torture and Other Cruel or Degrading Treatment or Punishment," *Office of the United Nations High Commissioner for Human Rights*, <http://untreaty.un.org/english/treatyevent2001/pdf/07e.pdf> (accessed December 12, 2008).

¹⁷*Ibid.*

¹⁸*Ibid.*

¹⁹United States of America, *Torture, U.S. Code, Title 18*.

²⁰*Ibid.*

²¹Major General Michael E. Dunlavey, "Memorandum For Commander, United States Southern Command: Counter-Resistance Strategies." *George Washington University National Security Archives*, October 11, 2002, <http://www.gwu.edu/~nsarchiv/NSAEBB/NSAEBB127/02.10.11.pdf> (accessed January 17, 2009). A legal brief accompanies the request of Major General Dunlavey, GTMO Commander, requesting approval for the use of several controversial interrogation techniques. This legal brief, which was written by Lieutenant Colonel Diane Beaver, states that U.S. military personnel could potentially violate articles of the UCMJ when using some of the proposed interrogation techniques. The text of the UCMJ articles can be found on the ICRC website as U.S. implementing regulations of the 1949 Geneva Conventions, <http://www.icrc.org/ihl-nat.nsf>.

²²Department of Defense, Directive Number 5100.77, *DoD Law of War Program* (Washington, DC: U.S. Government Printing Office, 1998), 4.

²³Department of the Army, Field Manual 34-52, *Intelligence Interrogation* (Washington, DC: U.S. Government Printing Office, 1999), iv-v.

²⁴*Ibid.*, 1-8.

²⁵*Ibid.*

²⁶Ibid.

²⁷Department of the Army, Field Manual 3-19.40, *Internment/Resettlement Operation* (Washington, DC: U.S. Government Printing Office, 2001), 1-2-1-4.

²⁸Ibid., 117.

²⁹As the Church Report stated, "Nevertheless, to a significant degree this [lack of clear legal guidelines] left implementation of interrogation techniques up to individual interrogators' judgment."

³⁰Tony Lagouranis and Allen Mikaelian, *Fear Up Harsh: An Army Interrogator's Dark Journey Through Iraq*, New York: Penguin Books Ltd., 2007. Mr. Lagouranis, it seems, allowed poor examples and hearsay to guide his actions, despite his prior training on the Law of War at the MI schoolhouse at Ft. Huachuca, AZ. Mr. Lagouranis and his co-author de-emphasize Mr. Lagouranis' personal responsibility for his own actions and broadly blame senior political and military leaders without clearly delineating exactly how and where the decisions of these senior leaders may have contributed to his personal actions. Yes, ambiguity existed in Army doctrine as well as in CJTF-7 interrogation policies at the time. Nonetheless, Mr. Lagouranis must bear some responsibility for his willingness to interpret policies in a shameful manner--a responsibility he seems unwilling to shoulder. Still, his case is not an isolated one, and any leader of interrogators would be well-advised to read book as a an example of how a school-trained interrogator could choose to employ techniques in the field that he believed ran counter to the principles that he had been taught in the MI schoolhouse.

³¹Department of the Navy Inspector General, "Review," 109.

³²Ibid.

³³Schlesinger, Brown, Fowler, and Horner, 14-15.

³⁴Jones, 8-9.

³⁵Department of the Army Inspector General, "Detainee Operations Inspection," v-vi.

³⁶Department of the Navy Inspector General, "Review," 49.

³⁷Ibid., 52.

³⁸Major General Donald Ryder, "Report on Detention and Corrections Operations in Iraq," *American Civil Liberties Union: Torture FOIA*, November 6, 2003, <http://www.aclu.org/torturefoia/released/a19.pdf> (accessed February 15, 2009), 27.

³⁹Dr. Donald P. Wright and Colonel Timothy R. Reese, *On Point II, Transition to the New Campaign: the United States Army in Operation IRAQI FREEDOM, May 2003 - January 2005* (Fort Leavenworth, KS: Combat Studies Institute Press, 2008), 196.

⁴⁰*Ibid.*, 196-201.

⁴¹*Ibid.*, 196.

⁴²*Ibid.*, 197-200.

⁴³Schlesinger, Brown, Fowler, and Horner, 57-58.

⁴⁴*Ibid.*, 57.

⁴⁵*Ibid.*

⁴⁶*Ibid.*, 58.

⁴⁷*Ibid.*

⁴⁸*Ibid.*, 123.

⁴⁹*Ibid.*, 125-126.

CHAPTER 3

THE CITY UPON THE HILL

For we must consider that we shall be as a city upon a hill. The eyes of all people are upon us. So that if we shall deal falsely with our God in this work we have undertaken . . . we shall be made a story and a by-word throughout the world. . . . We shall shame the faces of many of God's worthy servants, and cause their prayers to be turned into curses upon us til we be consumed out of the good land whither we are a-going.¹

— John Winthrop

Well, we started to connect the dots, in order to protect the American people. And, yes, I'm aware our national security team met on this issue [of enhanced interrogation techniques]. And I approved. I don't know what's new about that; I'm not so sure what's so startling about that.²

— President George W. Bush

The naval base at Guantanamo Bay, Cuba, is not only the oldest overseas U.S. naval base, but it also is the only U.S. military base located in a country with which the U.S. does not share diplomatic relations. Since 2002, this naval base has been the site of the U.S. government's only strategic internment facility. During OIF I, this strategic internment facility (often referred to as "GTMO") consisted of three camps located on a series of low, rolling hills overlooking the eastern side of Guantanamo Bay.

Almost since its inception, this detention facility has served as a lightning rod for international controversy. One of the most hotly debated issues regarding the facility has been whether the Bush Administration was legally correct when it suspended Geneva Convention protections for detainees at this facility. (As noted in chapter 2, the U.S. Supreme Court decided in June 2006 that, as a minimum, all detainees at this facility were entitled to the general protections offered by Common Article 3 of the Geneva Conventions.) Other much-debated issues have included whether the Bush Administration and the U.S. Congress made constitutionally lawful decisions when they

suspended the rights of detainees at this facility to the due process of law seemingly provided for them by the Fifth Amendment of the U.S. Constitution and to the right of habeas corpus appeals seemingly guaranteed for them by Article One of the Constitution. (Although the *Detainee Treatment Act of 2005* and the *Military Commissions Act of 2006* denied due process and habeas corpus appeals to GTMO detainees, a June 12, 2008, Supreme Court decision subsequently ruled that these denials were unconstitutional.)³ The most hotly debated topic regarding GTMO, however, has been whether the Bush Administration sanctioned "torture" during the interrogations of certain detainees at the facility, interrogations that have included the use of such coercive techniques as "Waterboarding," "Isolation," and "Forced Nudity" to break the will of detainees.

The net result of this controversy has been the empowerment of our nation's jihadist enemies at the expense of the U.S. government's standing as a moral leader in the world. Speaking to this, Vice Admiral Alberto Mora, the U.S. Navy General Counsel, testified to the Senate Armed Services Committee in June 2008 that "there are serving U.S. flag-rank officers who maintain that the first and second identifiable causes of U.S. combat deaths in Iraq--as judged by their effectiveness in recruiting insurgent fighters into combat--are, respectively the symbols of Abu Ghraib and Guantanamo."⁴

The twin scandals of GTMO and Abu Ghraib are intimately entwined with interrogations. This chapter explores how these scandals could have occurred when the laws, directives, and doctrine outlined in chapter 2 should have prevented such scandals.

The Bush Administration and Interrogation Policy

Within the U.S. government, two individuals have the authority to suspend or override DoD directives, Army regulations, and Army doctrine. These two individuals

are the President and the Secretary of Defense. Both the President and the Secretary of Defense began asserting their authority in this regard soon after the fall of the Taliban government in Afghanistan.

In December 2001, the DoD General Counsel requested information regarding the interrogation of detainees from the Joint Personnel Recovery Agency (JPRA),⁵ which is the component of U.S. Joint Forces Command with oversight of SERE training for U.S. military personnel. SERE training is designed to prepare U.S. military personnel to survive capture by nations that do not adhere to the Geneva Conventions. This training subjects U.S. military personnel to interrogation techniques largely gleaned from the Korean War, where the Chinese Communist Army had used illegal interrogation techniques to extract false confessions for these confessions' propaganda value.⁶ At the time of the September 11 attacks, interrogation techniques used within the U.S. military's SERE schools included forced nudity, sleep deprivation, use of extreme temperatures, use of prolonged and uncomfortable "stress positions," use of loud music and flashing lights, putting hoods over subjects' heads, and slapping the face and body.⁷ Until recently, "interrogators" at the U.S. Navy SERE School even employed "waterboarding," the controversial interrogation technique that simulates drowning.⁸

The SERE schools' "interrogators," who are not usually real world U.S. military interrogators but rather actors playing the role of hostile enemy interrogators, are legally able to employ such interrogation techniques against U.S. service members because of the "safeguards" that accompany these techniques.⁹ The most important of these safeguards is the fact that a U.S. service member attending a SERE school can at any point choose to stop the training: such stoppage may result in the service member's

failing to complete the school, but through this safeguard and other safeguards, U.S. service members attending SERE school are given some measure of control over their environment.¹⁰ Of course, subjects of real world hostile interrogations do not enjoy similar control over their environments.

It is unclear from unclassified sources exactly why this request was made. Certainly, there was dissatisfaction by 2002 at various levels of command with the intelligence that was being produced via conventional interrogation techniques. For example, one of the behavioral science consultants at GTMO later testified that the GTMO chain-of-command had become frustrated over the inability of interrogators to establish a link between al Qaeda and Iraq.¹¹ Supporting this psychologist's assertion, David Becker, the Chief of the Interrogation Control Element (ICE) at GTMO, told the Senate Armed Services Committee that the office of the Deputy Secretary of Defense, Paul Wolfowitz, had called Major General Michael Dunlavey, the commander of Joint Task Force 170 at GTMO, on multiple occasions to express concern about insufficient intelligence production.¹² Becker also alleged that Wolfowitz had personally told Dunlavey that his interrogators should use more aggressive interrogation techniques to extract this intelligence.¹³ Thus, it seems likely that, in December 2001, there was already a perception within the Bush Administration that conventional rapport-building interrogation techniques were not producing the desired intelligence, and because of this perception, DoD leaders moved to consult their only source of expertise regarding non-doctrinal techniques, the JPRA.

Whatever the reason for the request, this request was unusual. After all, SERE schools specializes in training U.S. soldiers on how to resist providing reliable

intelligence when tortured, and it does not specialize in training interrogators on how to extract reliable intelligence information.¹⁴ One would think that the JPRA would not have been the first place that DoD leaders consulted for reliable interrogation practices; instead, more obvious organizations to which to turn would have included the U.S. Federal Bureau of Investigation (FBI) and various law enforcement agencies. These other organizations have accumulated millions of man-hours of experience extracting information from real-world, non-compliant suspects. Unfortunately, though, the experience of these agencies had led them to depend on rapport-building techniques that were falling out of favor within the Bush Administration.

Ali Soufan, a former FBI agent who took part in the initial interrogations of Abu Zubaydah (an al Qaeda leader captured in Afghanistan) claims today that the FBI's "soft" techniques were indeed effective when he applied them to Abu Zubaydah. Soufan cites his extracting from Abu Zubaydah the identity of Khalid Sheikh Mohammed as the mastermind of the September 2001 terrorist attacks on U.S. soil as an example of this effectiveness.¹⁵ Regrettably, he says, he was pulled off the case too soon because of his resistance to the CIA's plan to use harsh interrogation methods on the captured al Qaeda leader. An article in the May 4, 2009, edition of *Newsweek* describes what happened when Soufan then went to train interrogators in early 2002 at GTMO:

He [Soufan] gave a powerful talk, preaching the virtues of the FBI's traditional rapport-building techniques. Not only were such methods the most effective, Soufan explained that day, they were critical to maintaining America's image in the Middle East. 'The whole world is watching what we do here,' Soufan said. 'We're going to win or lose this war depending on how we do this.' As he made these comments, about half the interrogators in the room--those from the FBI and other law-enforcement agencies--were 'nodding their heads' in agreement,' recalls [Robert] McFadden [a U.S. Naval Criminal Investigator]. But the other half--CIA and military officers--sat there 'with blank stares. It's like they were thinking,

'This is bull crap.' Their attitude was, 'You guys are cops; we don't have time for this.'¹⁶

Despite the strangeness of the DoD General Counsel's request, this initial contact with the JPRA developed into a two-year relationship between the JPRA and certain U.S. military interrogation facilities.¹⁷

Rumsfeld helped set the stage for this two-year relationship in a January 19, 2002, memo to the Chairman of the Joint Chiefs of Staff. In this memo, Rumsfeld stated that, although Geneva protections did not technically apply to unlawful combatants such as al Qaeda and Taliban, U.S. detainees belonging to these organizations should be treated humanely "and, to the extent appropriate and consistent with military necessity, in a manner consistent with the principles of the Geneva Conventions of 1949."¹⁸ What was important in Rumsfeld's memo was not that members of al Qaeda and the Taliban should, if captured, be treated in accordance with Geneva Conventions: existing DoD directives, regulations, and doctrine already required such treatment. Rather, what Rumsfeld was saying that was truly significant was, one, the Geneva Conventions did not technically apply to members of al Qaeda and the Taliban, and two, the U.S. Armed Forces did not have to apply the Geneva Conventions to members of al Qaeda and the Taliban in cases of "military necessity."¹⁹

Rumsfeld's position here would be supported by President Bush. In a February 7, 2002, memo to his national security advisors, Bush borrowed Rumsfeld's language, stating that he expected U.S. Armed Forces to "continue to treat detainees humanely and, to the extent appropriate and consistent with military necessity, in a manner consistent with the principles of Geneva."²⁰ Also noteworthy in Bush's memo were his assertions that, because of the transnational nature of al Qaeda, none of its members were entitled to

Geneva protections since "al Qaeda is not a High Contracting Party to Geneva,"²¹ and that, because members of the Taliban are "unlawful combatants," they did "not qualify as prisoners of war under Article 4 of the Third Geneva Convention, nor did they qualify for the general protections offered in common Article 3 of the Geneva Conventions."²² Thus, essentially, President Bush was directing the application of Fourth Geneva Convention protections to members of these two organizations, except in cases of "military necessity." In cases of "military necessity," it would seem, almost any treatment of al Qaeda and Taliban detainees might be permissible.

In late July 2002, JPRA provided the DoD General Counsel's office with several documents, including a list of SERE interrogation techniques and extracts from training modules for SERE schools' mock interrogators.²³ A week later, the Department of Justice's Office of Legal Counsel issued a legal opinion that "redefined torture" as prohibited in the 1994 Torture Convention and this convention's implementing U.S. legislation. This opinion stated that pain was only "severe" if it caused lasting physical or psychological pain--pain "equivalent in intensity to the pain accompanying serious physical injury, such as organ failure, impairment of bodily function, or even death."²⁴ Thus, with President Bush and his Secretary of Defense formally expressing their willingness to suspend the Geneva protections of "unlawful combatants" in cases of "military necessity" and with the infliction of non-enduring pain and suffering now permissible according to the Department of Justice, the stage was set for the U.S. government to employ SERE interrogation techniques against real world detainees.

In mid-September 2002, interrogators and behavioral scientists traveled from GTMO to attend training conducted by SERE instructors.²⁵ Soon after this trip, two

behavioral scientists began drafting a list of proposed interrogation techniques for GTMO that would include several SERE techniques.²⁶ During their drafting process, Jonathan Fredman, Chief Counsel to the CIA's Counterterrorist Center, visited GTMO, telling leaders that, "It [torture] is basically subject to perception. If the detainee dies you're doing it [the interrogation] wrong."²⁷ When finalized, the list of techniques drafted by these two scientists would serve as the basis of an October 11, 2002, memo sent from Major General Dunlavey to his superior, General James Hill, the commander of U.S. Southern Command. In this memo, Dunlavey explicitly requested approval for techniques that derived from "U.S. military interrogation resistance training" (SERE schools).²⁸ Hill forwarded this documentation on October 25, 2002, to General Richard Myers, the Chairman of the Joint Chiefs of Staff, for approval.²⁹

Upon receipt of Hill's request, Myers asked the various military services to review the request.³⁰ Each military service replied to Meyers that they had serious legal reservations regarding the request. The Chief of the Army's International and Operational Law Division, for example, pointed out that the implementation of some of the techniques would probably constitute violations of the U.S. "torture statute" and of the UCMJ.³¹ All services also called for an extensive legal review of the proposal, and Navy Captain Jane Dalton, who was Myers' senior legal counsel, began just such a review.³² However, due perhaps to pressure from Rumsfeld for a quick decision,³³ the DoD General Counsel, William Haynes II, largely ignored the reservations expressed by Dalton and the various military services.³⁴ On November 27, 2003, Mr. Haynes produced a memo for Rumsfeld's endorsement that would have Rumsfeld approving all but three of the requested interrogation techniques.³⁵ On December 2, 2003, Rumsfeld

followed Mr. Haynes' advice and endorsed the memo, and by doing so, formally authorized the use of SERE interrogation techniques at GTMO.³⁶ Myers then directed Dalton to stop her legal review of the initial request.³⁷

There has been a great deal of speculation that a still-classified Executive Order signed by President Bush further sanctioned Rumsfeld's approval of SERE interrogation techniques for use at GTMO and elsewhere. This speculation derives chiefly from one of the redacted documents provided by the FBI to the American Civil Liberties Union. This redacted document is a May 22, 2004, email from the "On Scene Commander" of the FBI in Baghdad to another agent (presumably his boss). In this email, this "On Scene Commander" refers to interrogation techniques authorized by "an Executive Order signed by President Bush"--interrogation techniques that included "sleep management," "use of MWDs (military working dogs)," "stress positions" and "environmental manipulation" to include "the use of loud music" and "sensory deprivation."³⁸ Adding fuel to this speculation was the CIA's admission to a U.S. federal court on January 5, 2007, that a document existed that matched the American Civil Liberty Union's description of a "Directive signed by President Bush that grants CIA the authority to set up detention facilities outside the United States and/or outlining interrogation methods that may be used against Detainees."³⁹ However, since the Bush Administration consistently denied the existence of this classified executive order, at this point in history, this speculation remains precisely that--speculation.⁴⁰

In part due to growing service concerns, Rumsfeld rescinded his blanket approval of SERE interrogation techniques on January 15, 2003, stating that he would only approve the use of such techniques on a case-by-case basis.⁴¹ On the same day,

Rumsfeld ordered the establishment of a working group to review the legal considerations of U.S. interrogation operations and to propose legally acceptable interrogation techniques.⁴² As this working group conducted this legal review, various senior lawyers tried unsuccessfully to have their concerns about certain interrogation techniques incorporated into the working group's report; however, their attempts were unsuccessful.⁴³ Their concerns were dismissed in favor of a second legal opinion concerning interrogation techniques that had been issued by the U.S. Justice Department--a legal opinion (later rescinded) which supported the use of SERE interrogation techniques and which, at the direction of Haynes, was to be considered "authoritative" by the working group and was to "supplant the legal analysis being prepared by the Working Group action officers."⁴⁴

The working group adhered to Haynes' guidance. Subsequently, it published a final report on April 4, 2003, that supported the use of 35 interrogation techniques, including many harsh techniques.⁴⁵ The interrogation techniques that this report recommended for approval included "removal of clothing, prolonged standing, sleep deprivation, dietary manipulation, hooding, increasing anxiety through the use of a detainee's aversions like dogs, and face and stomach slaps."⁴⁶ The final report was so contentious among Working Group members that, apparently, the members who had argued most vociferously against its reasoning were never directly informed of its publication.⁴⁷

Despite his securing legal "cover" for the use of SERE interrogation techniques, Rumsfeld continued to deny blanket approval for the use of most SERE techniques at GTMO. On April 16, 2003, Rumsfeld issued a memo approving 24 interrogation

techniques for GTMO, also stating that, for the use of "additional interrogation techniques for a particular detainee, you should provide me, via the Chairman of the Joint Chiefs of Staff, a written request describing the proposed technique, recommended safeguards, and the rationale for applying it with an identified detainee."⁴⁸ Rumsfeld also directed that interrogators obtain his specific approval for the use of four of the most potentially controversial techniques in the memorandum, which were the Incentive/Removal of Incentive (such as removal of the Koran), Pride and Ego Down, Mutt and Jeff, and Isolation techniques.⁴⁹ After an April 22, 2003, case of substantiated detainee abuse, Brigadier General Miller, GTMO Commander, restricted controversial interrogation techniques further, prohibiting interrogators from using the Fear-Up Harsh approach⁵⁰ Nonetheless, Rumsfeld later approved the use of harsh SERE interrogation techniques on at least one GTMO detainee.⁵¹

SERE Interrogation Techniques Migrate to Iraq

Rumsfeld's blanket approval for the use of SERE interrogation techniques at GTMO on December 2, 2002, influenced the adoption of similar techniques by U.S. forces in Afghanistan.⁵² From Afghanistan, these techniques would migrate to Iraq.

Soon after being formed, Rumsfeld's working group asked U.S. Central Command for a list of interrogation techniques being used in Afghanistan.⁵³ In response, Lieutenant Colonel Robert Cotell, the Deputy Staff Judge Advocate for Combined Joint Task Force 180 (CJTF-180), produced a January 24, 2003, memo describing techniques used by CJTF-180 interrogators and recommending the use of five additional techniques.⁵⁴ Techniques identified as having been used by CJTF-180 interrogators included "the use of female interrogators to create 'discomfort' and gain more

information; sleep adjustment, defined as 'four hours of sleep ever 24 hours, not necessarily consecutive;' use of individual fears; removal of comfort items; use of safety positions; isolation; deprivation of light and sound in living areas; the use of a hood during interrogation; and mild physical contact."⁵⁵ The employment of some (if not all) of these techniques required approval on a case-by-case basis from CJTF-180 MI and legal personnel,⁵⁶ and these techniques had begun being used at approximately the same time Rumsfeld approved the use of harsh techniques for GTMO.⁵⁷ Lieutenant Colonel Cotell's memo also recommended that the DoD working group approve the use of "deprivation of clothing," "food deprivation," "sensory overload -- loud music or temperature regulation," "controlled fear through the use of muzzled, trained, military working dogs," and "use of light and noise deprivation."⁵⁸

Lieutenant Colonel Cotell acknowledged in his memo that Rumsfeld had rescinded authority for the use of these techniques at GTMO.⁵⁹ Nonetheless, in the absence of any specific higher guidance contradicting the use of these techniques in Afghanistan, CJTF-180 leadership concluded that the use of these techniques was acceptable in Afghanistan.⁶⁰ In fact, Lieutenant General Dan McNeill, the CJTF-180 commander, endorsed harsh techniques that included "individual fears [exploiting], black out goggles, deprivation of light and sound, sleep adjustment, threat of transfer to another agency or country, and safety positions."⁶¹ Harsh interrogation techniques would continue to be used in Afghanistan until May 6, 2004, when General Abizaid directed that all U.S. military forces operating in the U.S. Central Command Area of Responsibility (AOR) use only doctrinal FM 34-52 techniques. Some of these harsh techniques as published in a March 27, 2004, CJTF-180 interrogation standard operating

procedures would include the use of "safety positions" (in other words, "stress positions"), "sleep adjustment," "sensory overload," "dietary manipulation," "adjusting temperature or introducing an unpleasant smell," and the use of "blacked out goggles."⁶²

Leaders and interrogators who, during their previous deployments to GTMO or Afghanistan had gained knowledge of the SERE techniques sanctioned in these two other theaters, often employed these techniques in Iraq. For example, CW3 Lewis Welshofer, the 3ACR warrant officer who was later convicted in the interrogation homicide of an Iraqi general, employed harsh interrogation techniques that he claimed had been effective for him in Afghanistan. (See the email exchange related in Chapter 1) Captain Carolyn Wood is another example. Captain Wood, who would later lead the first contingent of interrogators at Abu Ghraib, was in charge of the intelligence section at Bagram Airfield in Afghanistan until January 2003. In Afghanistan, she had become familiar with the harsh interrogation techniques approved for use in that theater. She had also become familiar with the harsh techniques used at GTMO: she later said that, after asking GTMO for their interrogation "parameters," she had received a faxed PowerPoint slide from GTMO that had listed the harsh techniques that Rumsfeld had approved for the facility on December 2, 2002.⁶³ Based on this previous experience and knowledge, she would allow her interrogators at Abu Ghraib to use the SERE techniques of "sleep adjustment" and "stress positions" even before Lieutenant General Sanchez temporarily approved the use of these techniques: "Because we had used the techniques in Afghanistan, and I perceived the Iraq experience to be evolving into the same operational environment as Afghanistan, I used my best judgment and concluded they would be effective tools for interrogation operations at AG [Abu Ghraib]."⁶⁴

Special operations units were also a significant conduit for the migration of SERE techniques to Iraq. The Special Mission Unit (SMU) in Afghanistan that was responsible for tracking down high-profile al Qaeda and Taliban targets sent a team to GTMO from October 8-10, 2002, to assess interrogation operations.⁶⁵ This visit occurred when behavioral scientists at GTMO were drafting the list of harsh interrogation techniques that Rumsfeld would approve for use at GTMO on December 2, 2002.⁶⁶ This team returned with recommendations that the SMU adopt numerous SERE techniques.⁶⁷

On January 10, 2003, the SMU Task Force Commander approved the unit's first interrogation standard operating procedures (SOP).⁶⁸ This SOP included four harsh techniques, namely, "isolation, multiple interrogators, stress positions, and sleep deprivation."⁶⁹ In February 2003, the SMU would add the use of military working dogs as an approved interrogation technique.⁷⁰

With the start of OIF in March 2003, a separate SMU Task Force was established in Iraq. According to unclassified news reports, this Joint Special Operations Command task force included members of "the Army unit Delta Force, Navy's Seal Team 6 and the 75th Ranger Regiment."⁷¹ Also, interrogators from the Defense Intelligence Agency and Army reserve units were temporarily assigned to the task force, and CIA and FBI agents worked closely with the unit.⁷² According to other news articles on the internet, the name of this task force evolved from Task Force (TF) 20 to TF 121 to TF 6-26 during OIF I.⁷³

The SMU Task Force in Iraq had an interrogation policy already in place before the start of OIF, a policy that was copied verbatim from the policy of the SMU Task Force in Afghanistan.⁷⁴ This policy governed SMU Task Force interrogations in Iraq until it was superseded by a new policy July 15, 2003.⁷⁵ This new policy added the

technique of "yelling, loud music, and light control" to the techniques that had been previously approved.⁷⁶ According to one of this task force's interrogators, the use of harsh techniques was approved on a case-by-case basis at Camp Nama, the SMU Task Forces detention facility on the Baghdad Airport:

There was an authorization template on a computer, a sheet that you would print out, or actually just type it in. And it was a checklist. And it was all already typed out for you, environmental controls, hot and cold, you know, strobe lights, music, so forth. Working dogs, which, when I was there, weren't being used. But you would just check what you want to use off, and if you planned on using a harsh interrogation you'd just get it signed off.⁷⁷

While SMU Task Force policy never included "Forced Nudity," this technique was nonetheless employed at Camp Nama. According to the officer who took command of the SMU TF in October 2003, he "discovered that some of the detainees were not allowed clothes" as part of interrogation approaches and that he ended the practice in December 2003 or January 2004.⁷⁸ Although the use of the "Forced Nudity" interrogation at the facility may have had its roots elsewhere, the use of this technique was reinforced by the assistance visit of a three-man JPRA team to the facility from September 5-23, 2003.⁷⁹ During their visit, this team demonstrated the SERE interrogation techniques of stress positions, sleep deprivation, and forced nudity.⁸⁰ This JPRA team also reported observing an interrogation in which an SMU Task Force interrogator repeatedly slapped a detainee across the face, which was apparently a common practice at the facility despite its not yet being formally approved.⁸¹

The SMU Task Force in Iraq adopted its most aggressive policy on March 26, 2004, a policy that would be in effect only until May 6, 2004, at which time General Abizaid suspended the use of all non-doctrinal techniques in the U.S. Central Command AOR.⁸² This March 26, 2004, SMU policy included 14 harsh interrogation techniques,

such as the "use of muzzled dogs, 'safety positions (during interrogations),' sleep adjustment/management, mild physical contact, isolation, sensory overload, sensory deprivation, and dietary manipulation."⁸³

Interrogation Policies in Guantanamo, Afghanistan and Iraq

Number of Authorized Techniques				Number of Authorized Techniques				Number of Authorized Techniques			
Policy	Date	Notes		Policy	Date	Notes		Policy	Date	Notes	
17	FM 34-52 (1992)	Jan 02 - 01 Dec 02		17	FM 34-52 (1992)	27 Oct 01 - 24 Jan 03		17	FM 34-52 (1992)		
33	Secretary of Defense Approved Tiered System	02 Dec 02 - 15 Jan 03	1	33	CJTF 180 Response to Director, Joint Staff	24-Jan-03	1, 3, 6	29	CJTF-7 Signed Policy	14-Sep-03	1
20	FM 34-52 (1992) with 3 Cat I Techniques	16 Jan 03 - 15 Apr 03		32	CJTF 180 Detainee SOP	27-Mar-04	1	19	CJTF-7 Signed Policy	12-Oct-03	4
24	Secretary of Defense Memo	16 Apr 03 - Present	1,2	19	CJTF-A Rev 2 Guidance	Jun-04	4	19	CJTF-7 Signed Policy	13-May-04	4

- 1 Some techniques specifically delineated in this memo are inherent to techniques contained in FM 34-52, e.g. Yelling as a component of Fear Up
- 2 Five Approved Techniques require SOUTHCOM approval and SECDEF notification.
- 3 Figure includes techniques that were not in current use but requested for future use.
- 4 Figure includes one technique which requires CG approval.
- 5 Memorandum cited for Afghanistan and Iraq are classified.
- 6 Figure includes the 17 techniques of FM-34-52, although they are not specified in the Memo.

Appendix D

Source: Naval IG Investigation

Figure 2. Interrogation Policies in Guantanamo, Afghanistan and Iraq
 Source: James R. Schlesinger, Harold Brown, Tillie K. Fowler, and General Charles A. Horner, "Final Report of the Independent Panel to Review DoD Detention Operations, August 23, 2004," *United States Department of Defense Detainees Investigations*, <http://www.defenselink.mil/news/Aug2004/d20040824finalreport.pdf> (accessed November 2, 2008), 110.

Interrogation policy for this SMU task force directly influenced the drafting of the first interrogation policy for conventional forces in Iraq. This influence began with Captain Wood, who was the de facto head of interrogations at Abu Ghraib from August to December 2003.⁸⁴ Captain Wood has stated that she "plagiarized" the interrogation policy of TF 121 (according to news reporting, the name of this SMU task force at the time of her plagiarization) to create a draft interrogation policy for her own interrogators at Abu Ghraib.⁸⁵ She then submitted this draft policy to her higher headquarters (the 519th MI Battalion, the 205th MI Brigade and CJTF-7 Headquarters) for approval.⁸⁶ According to the Church Report, CJTF-7's first interrogation policy, which was published on September 14, 2003, was heavily influenced by Rumsfeld's April 2003 approval memo for GTMO and by the draft interrogation policy submitted by Captain Wood.⁸⁷

Key Conclusions

Interrogation techniques that had been designed to train U.S. military personnel on how to resist and survive interrogations by an enemy unconstrained by the Geneva Conventions made their way, via formal and informal means, from U.S. military SERE schools to GTMO and Afghanistan, and from these two theaters, to Iraq. While the question of whether certain military leaders, Donald Rumsfeld, and possibly President Bush actually violated U.S. national law with their approval of certain harsh interrogation techniques at our nation's strategic internment facility is much debated, what should not be greatly debated is whether their granting of this approval was unwise. For decades if not centuries to come, the twin symbols of GTMO and Abu Ghraib and all that these symbols have done to fuel the insurgencies in Iraq and Afghanistan and to incur international

condemnation of the U.S., should serve as a cautionary tale for any other senior U.S. leader who might someday consider a similarly unwise course of action.

In a famous sermon delivered in 1630 on board the *Arbella* just prior to its landing, John Winthrop told the Puritan founders of the Massachusetts Bay Colony that their new community would be a "city upon a hill" watched by the world.⁸⁸ This metaphor has been frequently invoked in the modern age by various U.S. politicians and political theorists. In his moving farewell speech to the nation, for example, President Ronald Reagan said the following:

The past few days when I've been at that window upstairs, I've thought a bit of the 'shining city upon a hill' . . . I've spoken of the shining city all my political life, but I don't know if I ever quite communicated what I saw when I said it. But in my mind it was a tall proud city built on rocks stronger than oceans, wind-swept, God-blessed, and teeming with people of all kinds living in harmony and peace, a city with free ports that hummed with commerce and creativity, and if there had to be city walls, the walls had doors and the doors were open to anyone with the will and the heart to get here. That's how I saw it and see it still.⁸⁹

Ironically, considering the long-life this metaphor has enjoyed in the speeches and essays of this nation's political leaders, the interrogation facilities at both GTMO and Abu Ghraib were situated atop hills. Truly, though, the moral examples set by these two detention facilities for the world to view did not represent the shining city ("America") envisioned by Winthrop, our founding fathers, and our nation's finest leaders.

¹"John Winthrop: 1630," In *Speeches that Changed the World*, edited by Owen Collins, 63-65, Westminster: John Knox Press, 1999, 65.

²ABC News, *Full Transcript of ABC's Martha Raddatz Interview with President Bush*, April 11, 2008, <http://abcnews.go.com/Politics/Story?id=4634219&page=4> (accessed April 20, 2009).

³Supreme Court of the United States, "Boumediene Et Al v. Bush, President of the United States, Et Al," *Supreme Court of the United States*, June 12, 2008,

<http://www.supremecourt.us/opinions/07pdf/06-1195.pdf> (accessed February 10, 2009), 3.

⁴Vice Admiral Alberto Mora, "Statement of Alberto J. Mora," *U.S. Senate Committee on Armed Services*, June 17, 2008, <http://armed-services.senate.gov/statemnt/2008/June/Mora%2006-17-08.pdf> (accessed January 17, 2009), 5.

⁵U.S. Senate Armed Services Committee, "Inquiry into the Treatment of Detainees in U.S. Custody," *U.S. Senate Armed Services Committee*, November 20, 2008, http://armed-services.senate.gov/Publications/Detainee%20Report%20Final_April%2022%202009.pdf (accessed May 2, 2009), xiii. This report is hereafter referred to as the "U.S. Senate Armed Services Committee Inquiry."

⁶*Ibid.*

⁷*Ibid.*

⁸*Ibid.*

⁹*Ibid.*, xiii, xix.

¹⁰*Ibid.*, xix. According to this Senate Armed Services report, safeguards at U.S. SERE schools include students being subjected to "extensive medical and psychological pre-screening"; the imposing of "strict limits on the frequency, duration, and/or intensity of certain techniques"; the presence of psychologists "to intervene should the need arise"; and giving to students "a special phrase they can use to immediately stop the techniques from being used against them."

¹¹*Ibid.*, 41.

¹²*Ibid.*

¹³*Ibid.*, 41-42.

¹⁴*Ibid.*, xiii.

¹⁵Michael Isikoff, "We Could Have Done This the Right Way," *Newsweek*, May 4, 2009: 21.

¹⁶*Ibid.*

¹⁷U.S. Senate Armed Services Committee, "Inquiry," xiv. The JPRA's influence on the development of interrogation techniques for GTMO is documented in pages xiii to xv of this report.

¹⁸Donald Rumsfeld, "George Washington University's The National Security Archives," *Counter-Resistance Techniques in the War on Terrorism*, April 16, 2003,

<http://www.gwu.edu/~nsarchiv/NSAEBB/NSAEBB127/03.04.16.pdf> (accessed November 2, 2008), 1.

¹⁹Ibid., 1.

²⁰President George W. Bush, "Memorandum, Humane Treatment of al Qaeda and Taliban Detainees, 7 February 2002," *George Washington University's The National Security Archive*, <http://www.gwu.edu/~nsarchiv/NSAEBB/NSAEBB127/02.02.07.pdf> (accessed November 2, 2008), 2.

²¹Ibid., 1. This is a hard argument for someone who is not a lawyer to follow. If another international group, say, the ICRC, were to suddenly commence hostilities against the U.S., should not this group's members, when captured by U.S. forces, be granted Geneva protections based on the country of their citizenship rather than their group membership? The Bush Administration's argument here is certainly not the customary interpretation of the Geneva Conventions, in which there is no such thing as "unlawful combatants" and all detainees are guaranteed either the extended protections of Convention III or of Convention IV. Although it is hard argument to follow, there is indeed some ambiguity within the Geneva Conventions--ambiguity, it should be noted, which is erased in Protocol 1 of the Geneva Conventions of 1949. Protocol 1 binds all signatories to customary interpretations of the Geneva Conventions (or in other words, binds signatories to the judicial opinions rendered by international courts). However, while Protocol I has been ratified by 167 countries, it has not been ratified by the United States. In his inaugural address, President Barack Obama stated that "we are ready to lead once more." Perhaps ratifying Protocols I and II of the Geneva Conventions would send a stronger signal to the world that the U.S. is ready to resume its role as a moral leader than the closure of a facility (GTMO) that will just need to be reestablished elsewhere.

²²Ibid., 2.

²³U.S. Senate Armed Services Committee, "Inquiry," xiv.

²⁴Ibid., xv.

²⁵Ibid., xvi.

²⁶Ibid., xvii.

²⁷Ibid., xvii.

²⁸Ibid., 4.

²⁹General James T. Hill, "Memorandum for Chairman of the Joint Chiefs of Staff; SUBJECT: Counter-Resistance Techniques," *George Washington University National Security Archive*, October 25, 2002, <http://www.gwu.edu/~nsarchiv/NSAEBB/NSAEBB127/02.10.25.pdf> (accessed January 17, 2009), 1.

³⁰U.S. Senate Armed Services Committee, "Inquiry," xvii.

³¹*Ibid.*, xviii.

³²*Ibid.*

³³*Ibid.*, xix. Mr. Haynes is quoted as saying, "There was a sense by the DoD Leadership that this decision was taking too long." Rumsfeld allegedly prompted his senior advisors, "I need a recommendation."

³⁴The Schlesinger Report would later conclude that, if the "Secretary of Defense had [possessed] a wider range of legal opinions and [allowed] a more robust debate regarding detainee policies and operations," the fluctuations in policy that occurred between December 2, 2002, and April 16, 2003, might well have been avoided" (Schlesinger, 10).

³⁵Rumsfeld, *Counter-Resistance Techniques in the War on Terrorism*, April 16, 2003, 1.

³⁶*Ibid.* These interrogations techniques were tiered, with Category III techniques being the harshest techniques. All interrogation techniques described in the U.S. Senate Armed Services Committee Inquiry as SERE techniques are listed as either Category II or Category III techniques in this GTMO policy memorandum.

³⁷U.S. Senate Armed Services Committee, "Inquiry," xviii. According to Captain Dalton, Mr. Haynes ordered her to stop the review because of concerns that people would see the military services' analysis of the GTMO request as non-supportive. Captain Dalton also stated that this was the only time she was ever ordered to halt a legal review.

³⁸Redacted, "Email from REDACTED to Briese, M.C. (Div13) (FBI)," *American Civil Liberties Union: Torture FOIA*, May 22, 2004, http://www.aclu.org/torturefoia/released/FBI.121504.4940_4941.pdf (accessed January 11, 2009), 1. The cited interrogation techniques are consistent with allegations of the interrogation techniques employed by the secretive Special Mission Unit task force in Iraq. Corroborating this, the FBI agent even mentions this unit by its name at that time ("TF 6-26") in the email.

³⁹Marilyn Dorn, "Sixth Declaration of Marilyn A. Dorn, Information Review Officer, Central Intelligence Agency," *American Civil Liberties Union*, January 5, 2007, http://www.aclu.org/pdfs/safefree/20070110/cia_dorn_declaration_items_1_29_61.pdf (accessed February 10, 2009), 4.

⁴⁰The ostensible reason for this email was that, in the wake of the Abu Ghraib scandal, the FBI "On Scene Commander" wanted guidance from his superiors regarding which U.S. military interrogation techniques, if observed by his FBI agents, should be reported to his higher. President Bush's later admission to ABC News White House Correspondent Martha Raddatz on April 9, 2008, that he knew of and approved of his national security team meeting to discuss such controversial interrogation techniques as

sleep deprivation and waterboarding has further intensified speculation that President Bush did indeed sign a still-classified Executive Order approving SERE interrogation techniques. Considered altogether, the circumstantial evidence gathered from unclassified sources suggests strongly that President Bush signed a still-classified order authorizing SERE interrogation techniques, though this order--if it indeed existed--may have only applied to CIA interrogation operations.

⁴¹Rumsfeld, *Counter-Resistance Techniques in the War on Terrorism*, April 16, 2003, 1.

⁴²Donald Rumsfeld, "Memorandum for the General Counsel of the Department of Defense, Subject: Detainee Interrogations," *George Washington University's National Security Archives*, January 15, 2003, <http://www.gwu.edu/~nsarchiv/NSAEBB/NSAEBB127/03.01.15b.pdf> (accessed January 19, 2009), 1.

⁴³U.S. Senate Armed Services Committee, "Inquiry," xxi.

⁴⁴*Ibid.*, 120.

⁴⁵*Ibid.*, xxii.

⁴⁶*Ibid.*

⁴⁷*Ibid.*, 131.

⁴⁸Donald Rumsfeld, "Memorandum for the Commander, U.S. Southern Command," 1.

⁴⁹*Ibid.*, 1-4.

⁵⁰Department of the Navy Inspector General, "Review," 55. Although often associated with the Fear-Up Harsh approach, SERE techniques can also be used when implementing other doctrinal approaches, such as the Pride (Ego Down) approach

⁵¹U.S. Senate Armed Services Committee, "Inquiry," xxii. It should be noted that the fact that all U.S. detainees (including all unlawful combatants) were entitled to at least the minimum legal protections of U.S. national law held true even where and when Rumsfeld chose to override DoD directives and U.S. Army regulations. Thus, while the interrogation techniques used at GTMO may have been legally permissible within the letter of international law as agreed upon and ratified by the U.S. government, these techniques when implemented probably constituted, even with the use of substantial safeguards, violations of national law--law that included the 8th Amendment to the Constitution; U.S. Code, title 18, Chapter 113C (prohibition against torture), and the UCMJ. Based on these potential violations of national law, Rumsfeld could conceivably face prosecution for authorizing certain controversial interrogation techniques at GTMO. Calls for Rumsfeld's prosecution have grown increasingly strident with the December 11, 2008, publication of the Executive Summary of the Senate Armed Services Committee

report on the "Treatment of Detainees in U.S. Custody" as well as the April 20, 2009, release of the full report. This summary and report, which are referenced throughout this chapter, faulted Rumsfeld for approving interrogation techniques at GTMO that conveyed "the message that physical pressures and degradation were appropriate treatment for detainees in U.S. military custody."

⁵²Ibid., 154. Conversely, the Church Report concluded that harsh interrogation techniques in Afghanistan, though nearly identical to the techniques approved by Rumsfeld at GTMO, evolved independently from techniques approved for use at GTMO. However, the subsequent DoD Inspector General Report of 2006 and the Senate Armed Services Committee Report of 2008, both of which referenced the Church Report and other sources, concluded that techniques used in Afghanistan had indeed been influenced by Rumsfeld's approval of harsh interrogation techniques for GTMO. For this history, the author has chosen the conclusions of the latter two reports over the conclusions of the earlier Church Report, whenever these conclusions are at odds.

⁵³Ibid., 155.

⁵⁴Ibid.

⁵⁵Ibid. These techniques approved in Afghanistan are essentially the same as those attributed to SERE schools by the U.S. Senate Armed Services Committee Inquiry.

⁵⁶Captain Carolyn Wood, "Sworn Statement of CPT, 519th MI BN; Annex to Fay/Jones/Kern Report," *American Civil Liberties Union: Torture FOIA*, May 21, 2004, <http://www.aclu.org/projects/foiasearch/pdf/DOD000598.pdf> (accessed January 10, 2009), 5. Although Captain Wood's name is redacted in this sworn statement, the name of the commander of Company A, 519th MI Battalion, during this time period can be found in thousands of unclassified sources. Captain Wood even has a very extensive entry in Wikipedia, courtesy of the Abu Ghraib scandal.

⁵⁷Department of the Navy Inspector General, "Review," 6; U.S. Senate Armed Services Committee, "Inquiry" 151.

⁵⁸U.S. Senate Armed Services Committee, "Inquiry," xxiii.

⁵⁹Ibid., 155.

⁶⁰Ibid.

⁶¹Ibid., 157.

⁶²Ibid., 221-222.

⁶³Ibid., 155-156.

⁶⁴Captain Wood, "Sworn Statement," 5-6. The Taguba Report rightly found fault in the 205th MI Brigade's chain-of-command for allowing two of Captain Wood's interrogators to continue to interrogate despite an open CID case--later substantiated--that these two interrogators were involved in the physical abuse and deaths of two detainees in Afghanistan.

⁶⁵U.S. Senate Armed Services Committee, "Inquiry," 149.

⁶⁶Ibid.

⁶⁷Ibid., 150.

⁶⁸Ibid., 153.

⁶⁹Ibid.

⁷⁰Ibid., 156.

⁷¹Eric Schmitt and Carolyn Marshall, *New York Times: In Secret Unit's 'Black Room,' a Grim Portrait of U.S. Abuse*, March 19, 2006, 3. http://www.nytimes.com/2006/03/19/international/middleeast/19abuse.html?_r=2&pagewanted=1 (accessed February 17, 2009), 3.

⁷²Ibid.

⁷³ABC News, *The Blotter: Secret U.S. Task Force 145 Secretly Changes Its Name, Again*, June 12, 2006, http://blogs.abcnews.com/theblotter/2006/06/ssecret_us_task_.html (accessed February 17, 2009).

⁷⁴U.S. Senate Armed Services Committee, "Inquiry," 149.

⁷⁵Ibid., 149, 159.

⁷⁶Ibid., 159-160.

⁷⁷Human Rights Watch, "No Blood, No Foul," *Human Rights Watch*, July 2006, <http://www.hrw.org/en/reports/2006/07/22/no-blood-no-foul-0> (accessed February 17, 2009), 12. The title of this Human Rights Watch report is a reference to the signs that camp personnel had allegedly posted at Camp Nama--signs that essentially condoned the bloodless beatings of detainees.

⁷⁸Ibid., 161. The SMU Task Force Legal Advisor contradicted this statement, stating that the TF SMU commander explicitly directed the continuation of the "Forced Nudity" technique in a meeting that took place in December 2003 or January 2004.

⁷⁹U.S. Senate Armed Services Committee, "Inquiry," 173, 186-187.

⁸⁰Ibid., 182-183.

⁸¹Ibid., 176-178. According to Lieutenant Colonel Kleinman, who headed the JPRA team, he stopped this interrogation and other interrogations which were conducted by SMU Task Force personnel and which he deemed illegal. He also alleged that one SMU Task Force member subsequently threatened him, sharpening a knife and telling him to "sleep lightly" because they did not "coddle terrorists" at the facility (U.S. Senate Armed Services Committee, "Inquiry into the Treatment of Detainees in U.S. Custody," 186). It should be noted that Lieutenant Colonel Kleinman's observations regarding physical abuse at Camp Nama are consistent with allegations that a special operations unit close to Camp Cropper was regularly dropping off detainees at Camp Cropper with signs of physical abuse. This allegation, which was investigated by Lieutenant Colonel Natalie Lee, is discussed further in Chapter 4. Furthermore, this observation of physical abuse is consistent with testimony concerning Camp Nama that was collected in the Human Rights Watch report, "No Blood, No Foul," <http://www.hrw.org/en/reports/2006/07/22/no-blood-no-foul-0> and in such open-source reports as Eric Schmitt's and Carolyn Marshall's article in the *New York Times*, "In Secret Unit's 'Black Room,' a Grim Portrait of U.S. Abuse," http://www.nytimes.com/2006/03/19/international/middleeast/19abuse.html?_r=2&pagewanted=1.

⁸²Ibid., 222.

⁸³Ibid.

⁸⁴According to the Taguba Report (among other reports), the titular head of interrogation operations at Abu Ghraib, Lieutenant Colonel Steve Jordan, had essentially abdicated his operational responsibilities, focusing on force protection and life support issues rather than interrogations.

⁸⁵Captain Wood, "Sworn Statement," 6.

⁸⁶Ibid., 6.

⁸⁷Department of the Navy Inspector General, "Review," 8.

⁸⁸Winthrop, *Speeches that Changed the World*, 63.

⁸⁹Ronald Reagan, *Farewell Address to the Nation*, January 11, 1989, <http://www.reaganfoundation.org/reagan/speeches/farewell.asp> (accessed February 10, 2009).

CHAPTER 4

CJTF-7'S LONG LIST OF NOT NEARLY ENOUGH'S

As you know, you go to war with the Army you have. They're not the Army you might want or wish to have at a later time.

— Donald Rumsfeld, U.S. Secretary of Defense

Right from the start of our involvement [March 2003], it was clear that we lacked anywhere near the amount of either trained interrogators or Arabic linguists required to do our job. In fact, for most of my tour in Iraq, my unit--one of the largest HUMINT units in Iraq--never had more than 8-10 Arabic linguists at any one time. . . .With that small cadre, we were conducting dozens of intelligence gathering missions and interviewing 50-100 Iraqis every day. . . .[Consequently,] there were numerous cases of tactical, non-military intelligence units conducting 'CI' operations on their own without any permission to do so, all within the 205th's area of operation (AO). Many of these rogue intelligence gathering operations led to allegations of abuse and misconduct later on.¹

— David DeBatto, 205th MI Brigade Interrogator

The invasion of Iraq was launched on March 20, 2003. During its fighting march north from Kuwait, the V Corps Headquarters performed magnificently. The headquarters directed its heavy mechanized forces efficiently, ensuring its forces employed precise and devastating firepower against any enemy force that stood in its way. These enemy forces included the Fedayeen Saddam, an irregular enemy militia who, unexpectedly, supplied a ferocious and tenacious resistance to advancing coalition forces. Their fierce resistance caused Lieutenant General William Wallace, the V Corps Commander, to famously remark that this enemy "was not the one we'd war-gamed against," much to the chagrin of his military and civilian superiors. In the suburbs of Baghdad, V Corps forces took advantage of what would probably have proven to be only a temporarily disorganized defense of the city, launching tank-heavy raids (or "thunder runs") into the heart of the city to seize key political and military infrastructure. With the Iraq military's ability to command and control its units effectively destroyed, organized

resistance in the city crumbled, and the much-feared block-by-block battle for the city--with all of this battle's accompanying carnage--never took place. Tikrit, Saddam's home city, and Kirkuk in northern Iraq fell a few days later, and on April 14, 2003, the Pentagon declared the end of major fighting.

In retrospect, it is no wonder the V Corps Headquarters performed so magnificently during the invasion of Iraq, for leading this invasion was very much a role this headquarters had been born to play. After their commissioning, officers in this headquarters, just as other officers across the Army at the time, had been nourished by a myriad of military schools, maneuver training centers, and training exercises to wage just such a conflict. In fact, less than two months before the invasion, the V Corps Headquarters and its subordinate headquarters had conducted a massive exercise called "Victory Scrimmage" at Grafenwoehr, Germany, that had focused almost exclusively on training commanders and their staffs on how to conduct this invasion.² What is more, the V Corps Headquarters directed troops that were task-organized for high-intensity conflicts as well as equipped with some of the best warfighting equipment on the planet, including M1A1 tanks, M2 Bradley infantry fighting vehicles, and M109A6 Paladin self-propelled howitzers. Even the way the headquarters understood the enemy and its own battlespace was defined by high-tech MI sensors that produced imagery, signals, and radar-derived intelligence--intelligence that efficiently pinpointed such enemy targets as combat equipment, headquarters buildings, communications nodes, lines of communication, and uniformed military personnel.

With the destruction of Saddam's Army, however, the V Corps' ability to impact its operational environment in the manner it wanted to decreased dramatically. Although

jubilant at the fall of a much-despised regime (even many Sunnis celebrated Saddam's fall),³ vast numbers of Iraqis turned against coalition forces as law and order, electricity, garbage disposal, and other essential services failed to quickly materialize. Contributing to lawlessness was the problem of police officers, judges, and other government personnel not returning to their jobs, a problem that resulted in chaos as criminal gangs--many populated by the thousands of criminals Saddam had released just a few months earlier in a mass parole--looted government buildings and terrorized other Iraqis. Also contributing to this lawlessness was the fact that V Corps forces were ill-equipped, untrained, and mentally unprepared to deal with the problem. Stories abounded of U.S. soldiers staying on their tanks as looters paraded by them with stolen goods. Even senior U.S. officers were seemingly gripped by a sense of ennui and confusion at the situation they found themselves in. "I can remember quite clearly," one general officer reportedly said several months later, "I was on a street corner in Baghdad, smoking a cigar, watching some guys carry a sofa by--and it never occurred to me that I was going to be the guy to go get that sofa back."⁴

Then, with two signatures from his pen, Ambassador Paul Bremer added fuel to an already smoldering insurgency. The first Coalition Provisional Authority order that Ambassador Bremer signed, Order No. 1, barred members of the top four ranks of the Baath party from government office and subjected lesser ranks of the party to review. The second Coalition Provisional Authority order, Order No. 2, formally dissolved all Iraqi military and intelligence organizations. With these two signatures, hundreds of thousands of Iraqi men--including any Iraqi with any skill at running a large governmental organization as well as nearly all of Iraq's trained saboteurs and combat

specialists--found their professional careers and hopes of a steady paycheck decisively ended. Insurgents took immediate advantage of the anger generated by these Coalition Provisional Authority orders to attract more (and more skillful) insurgents--some of whom were motivated by patriotism to join the insurgency, but some of whom were motivated by simple economics and their need for the money paid by insurgent groups for anti-coalition attacks.⁵

As V Corps maneuver leaders tried to keep a lid on lawlessness and a growing insurgency, these leaders found themselves wishing for fewer Abrams tanks, Bradleys, and Paladins and for more dismounted troops to conduct patrols and to secure key sites; for fewer tactical psychological operations teams and for more public affairs detachments to convince, not regular army units to surrender, but rather the great mass of the Iraqi people that it was in their own best interest to support coalition efforts in their country; and for fewer imagery, signals, and radar intelligence collection platforms and for more HUMINT collectors to talk to Iraqis and help them find their soldiers' non-uniformed assailants; and. What V Corps leaders wanted, in short, was a greater capacity for conducting counter-insurgency and military stabilization operations.

Unfortunately, however, civilian and military leaders in Washington, D.C., had already chosen to reduce rather than increase this capacity. Lulled by the assumption that the situation in Iraq would soon stabilize, leaders in the Pentagon had decided in May 2003 to inactivate Coalition Force Land Component Command at Camp Doha, Kuwait, as the headquarters governing most coalition operations in Iraq and redesignate the much smaller V Corps headquarters as CJTF-7, the headquarters governing all of the coalition's military operations in Iraq.⁶ The V Corps headquarters would remain the core

headquarters for CJTF-7 throughout OIF I until III Corps headquarters, as part of the package of OIF II units, would assume the role of core headquarters for CJTF-7 on February 1, 2004.⁷

Too Few MI Soldiers

With the establishment of the V Corps Headquarters as CJTF-7 Headquarters on June 14, 2003, the capacity of coalition forces for conducting counter-insurgency and military stabilization operations instantly declined. This loss of capacity started with a lack of sufficient headquarters personnel. Although U.S. Central Command had allocated sufficient personnel for the new headquarters in a Joint Manning Document, this allocation was "not being filled systemically by the other services (except the Marines) or by coalition partners."⁸ In fact, when activated, CJTF-7 Headquarters had "only 495 [personnel], or roughly a third, of the manning requirements."⁹ As a result of the failure of the various services to adequately fill the CJTF-7 Headquarters, this headquarters would never come close to reaching its authorized strength. Speaking to the CJTF-7 Headquarters' chronic manpower shortage, CJTF-7 Chief of Operations (CJ3), Major General Thomas Miller, said "that the healthiest that [the CJ3 staff] ever got was probably at about the 50 percent mark, but you never sustained that more than 30 to 40 days because of the turnaround ratio you had amongst the various services."¹⁰ Similarly, Major General Barbara Fast, the CJTF-7 Chief of Intelligence (CJ2), noted that her section never exceeded 50 percent of its required manning.¹¹

This chronic shortage of personnel led directly to the loss of several key capabilities within the CJTF-7 headquarters. For example, the CJTF-7 staff was consumed by day-to-day tactical operations, resulting in an inability of the staff to

adequately address its long-range as well as its strategic- and operational-level responsibilities. Major General Thomas said the following regarding this issue:

Quite frankly, the day-to-day fight, the turmoil of transition . . . and all the other unforeseen tasks (Iraqi Civil Defense Corps, Police, Iranian Mujahedin-e Khalq forces, etc.), and then the enormous task of orchestrating a force rotation completely consumed the undermanned staff (CJ3). So as a result of that, I would have to say that the tactical situation and associated current operations tasks received the bulk of our attention, especially within the CJ3.¹²

Just as alarmingly for a headquarters leading a counterinsurgency campaign (regardless of what political leaders in Washington were calling it),¹³ the CJ2 section lacked a Joint Intelligence Center for conducting advanced HUMINT analysis.¹⁴ This lack of a robust HUMINT analytical capability had originated in the V Corps Headquarters' own organic shortfalls here, and inadequate augmentation would prevent Fast from sufficiently growing this capability throughout OIF I. Another significant CJ2 capability lost with the birth of CJTF-7 was that of a "Red Team," which is a team of analysts that provides oversight of staff planning, ensuring plans are the best possible plans.¹⁵

Not only were there too few intelligence officers working for the CJTF-7 CJ2, but generally, the CJ2's MI officers were less skilled than the MI officers of Coalition Forces Land Component Command at conducting strategic- and operational-level analysis in support of counter-insurgency operations. Lieutenant General Sanchez would later say of his intelligence officers that, although very smart and hard-working, they had been trained to "fight a conventional fight."¹⁶ As a result, he said, "we were completely lost in a totally different operational environment and we were really struggling."¹⁷

Most decisively, by the time the CJTF-7 Headquarters was stood up, the Iraq theater had already lost the majority of its strategic- and operational-level intelligence assets. Between January and April 2003, 17 MI Battalions supported combat operations

in Iraq.¹⁸ By July 2003, however, ten of these 17 MI battalions had redeployed from Iraq. Perhaps most critically, when the 513th MI Brigade redeployed, this brigade took with it this brigade's robust number of strategically-skillful HUMINT operators.¹⁹ Many of the Defense Intelligence Agency's HUMINT teams also redeployed prior to the establishment of CJTF-7, leaving most of the HUMINT teams it still had in Iraq in support of the quixotic quest of the Iraqi Survey Group for weapons of mass destruction.²⁰ The loss of these MI battalions and other HUMINT assets left CJTF-7 with only the V Corps' own MI Brigade, the 205th, to conduct theater- and operational-level intelligence operations. Although the 205th MI Brigade had been augmented prior to the invasion by three additional MI battalions (that, significantly, included three counterintelligence companies and one interrogation company), it still possessed a sum total of only seven battalions operating in Iraq.²¹

Three of the seven MI battalions remaining in Iraq were battalions organic to the 205th MI Brigade and the V Corps. Although these three battalions did have some HUMINT capability, they had been primarily designed for conventional warfare. Major Art LaFlamme, who led an MI company within one of 205th MI Brigade's organic battalions during OIF I, would later describe how his company used its sophisticated Tactical Exploitation System to provide a great number of enemy targets to coalition maneuver forces during the invasion.²² His primary mission, as LaFlamme would put it, "was finding stuff to kill," and his company was able to use his company's analysts and advanced analytical equipment "to shove intel down their [maneuver units'] throats."²³ But with the defeat of Saddam's Army, LaFlamme said, his mission "dropped to almost freaking nothing."²⁴

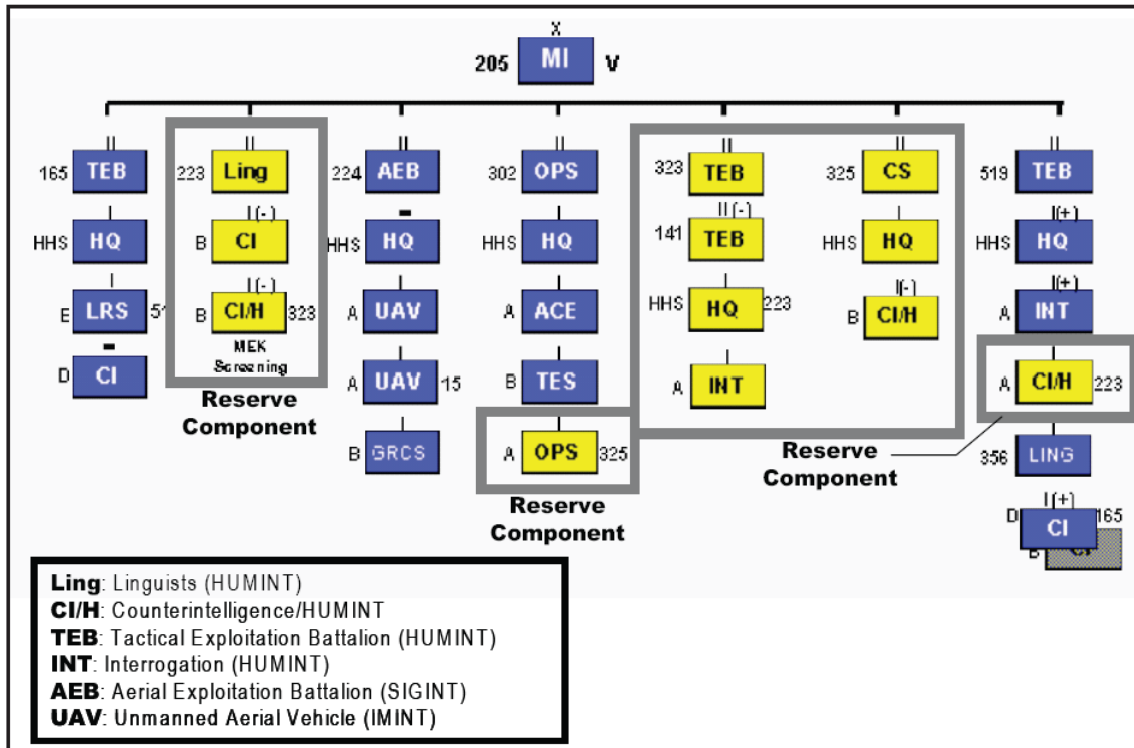

Figure 3. 205th MI Brigade Task Organization, August 2003

Source: Major General George R. Ray, "AR 15-6 Investigation of the Abu Ghraib Detention Facility and 205th Military Intelligence Brigade," *United States Department of Defense Detainees Investigations*, August 25, 2004, <http://www.defenselink.mil/news/Aug2004/d20040825fay.pdf> (accessed March 20, 2009).

Albeit hard-working, CJTF-7's small number of HUMINT personnel would prove grossly insufficient to accomplish their required tasks. The chief of interrogations for the 4ID, for example, would later state that, while he had needed 20 to 30 interrogators to accomplish his mission, he had only had six.²⁵ This shortage of HUMINT personnel would be aggravated even further in January 2004 when the 205th MI Brigade redeployed from Iraq with its seven battalions, leaving just the two battalions of its replacement OIF II brigade, the 504th MI Brigade, to provide theater-level collectors and analysis for CJTF-7.

In short, as a result of CJTF-7's lack of capacity for conducting counter-insurgency intelligence operations, CJTF-7's major subordinate commands were unable to rely on significant intelligence support from CJTF-7. Major General Fast has stated that tactical-level units (division-level and lower) generated approximately 95 percent of the intelligence they used to focus their military operations.²⁶ However, even this low assessment of CJTF-7's contribution to tactical-level intelligence may have been generous. With regard to interrogation support specifically, Major General Raymond Odierno, 4ID Commander, has said that "they [CJTF-7 interrogators] were so overwhelmed that they did not, in my mind, provide us with the information we needed."²⁷ Lieutenant Colonel Mark Crisman, the S2 for the 1st Brigade Combat Team (BCT), 1AD, has spoken even more bluntly: "Not once did I, as a BCT S2, receive a single piece of relevant feedback from interrogators at Abu Ghraib, this after personally delivering detainees with all associated target packets, initial interrogation results and associated physical evidence."²⁸

Too Few MPs

Prior to the invasion of Iraq, the planners of Coalition Forces Land Component Command believed that coalition forces would capture between 16,000 and 57,000 EPWs during the invasion, resulting in the establishment of up to 12 major coalition detention facilities.²⁹ These vast numbers of EPWs did not initially materialize, and starting on May 1, 2003, coalition detention facilities began releasing detainees at the rate of 300 EPWs a day.³⁰ Due to the rapidly shrinking number of EPWs (though these EPWs were being quickly replaced by criminals captured during the initial breakdown of law and order in Iraq) as well as due to the assumption that there would be no insurgency, military

leaders in Washington directed the de-mobilization of reserve MP units which were still in the U.S. and which had been preparing to deploy to Iraq.³¹ This decision left three MP brigades operating in Iraq during OIF I: the 18th MP Brigade was attached in direct support to 1AD in Baghdad; the 220th MP Brigade handled various theater-level missions throughout Iraq; and the 800th MP ran theater-level detention operations.³²

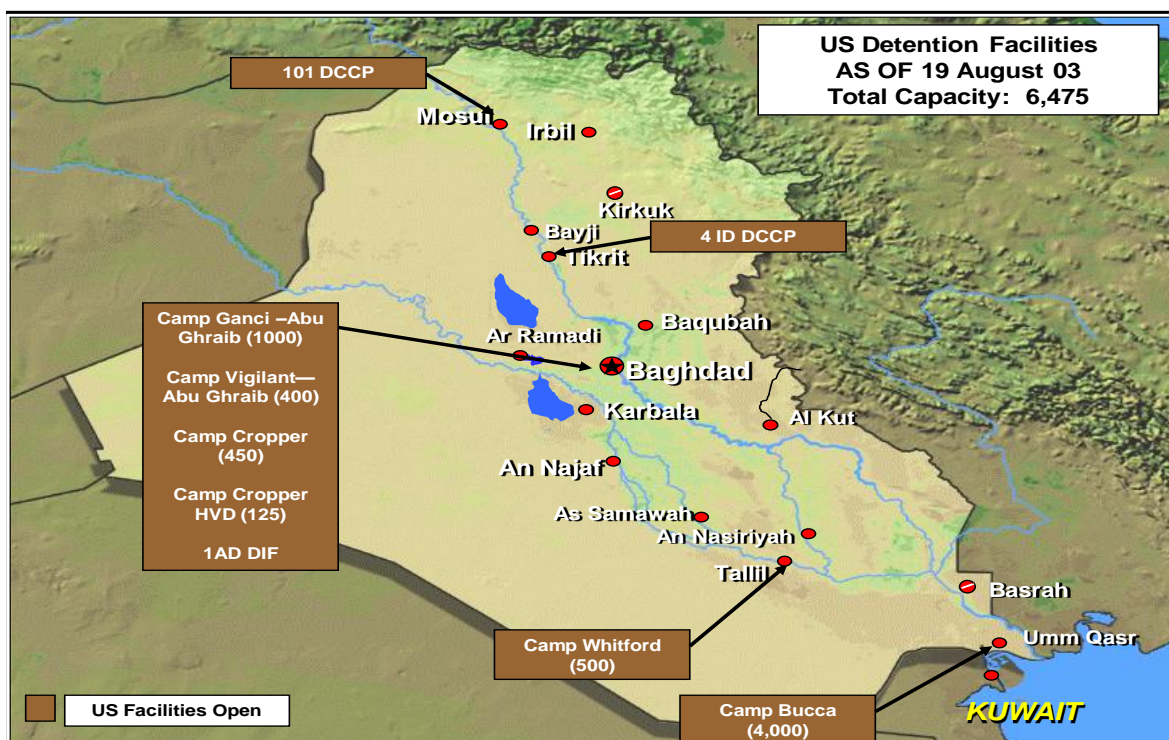

Figure 4. U.S. Detention Facilities as of August 2003

Source: CJTF-7 Staff. "Detention Summit Briefing to LTG Sanchez." Camp Victory, Iraq, August 11, 2003.

When Brigadier General Janice Karpinski assumed command of the 800th MP Brigade on June 30, 2003,³³ Coalition Forces Land Component Command still controlled her brigade. Her brigade, however, would fall under CJTF-7's control when CJTF-7 was

activated two weeks later.³⁴ For most of OIF I, the 800th MP Brigade had eight battalions in Iraq: starting in July 2003, one battalion with five companies managed the Baghdad Central Confinement Facility at Abu Ghraib; one battalion with two companies ran Camp Ashraf; two battalions with five companies total ran Camp Bucca; one battalion with two companies ran Camp Whitford; one battalion with two companies ran the High Value Detainee facility in Camp Cropper; one battalion with two companies ran the Ad Diwaniyah Prison, and one battalion jointly managed several prisons and jails with Iraqi policemen and guards.³⁵ These Iraqi prisons and jails included the Russafa and Women/Youth detention centers as well as the Irbil and Mosul Interim prisons.³⁶ Altogether, the 800th MP Brigade was responsible for 11, 333 detainees on June 15, 2003, the day after CJTF-7 was established.³⁷

By December 1, 2003, four of the 800th MP Brigade's battalions had redeployed home, leaving just four battalions in charge of 11,699 detainees.³⁸ The Ad Diwaniyah Prison and the Camp Whitford detention facility had been closed,³⁹ which enabled the brigade to more efficiently utilize its remaining MPs at fewer installations. Nonetheless, this 50 percent reduction in MP battalions marked a dramatic decline in the MP-to-detainee ratio at coalition holding facilities. This ratio would only worsen during OIF II, when the 89th and 16th MP brigades of OIF II conducted a transfer of responsibility with the three theater-level MP brigades of OIF I on February 1, 2004.⁴⁰

Too Few Lawyers

Although the CJTF-7 Headquarters published several minor detention-related Fragmentary Orders in June and July of 2003, the headquarters did not immediately publish a comprehensive directive governing every facet of detainee operations in Iraq.

This changed when, on August 24, 2003, CJTF-7 issued Fragmentary Order 749 (Intelligence & Evidence Led Detention Operations Relating to Detainees) to Operations Order 03-036.⁴¹ This Fragmentary Order, which would serve as CJTF-7's base order regarding detainee operations throughout OIF I, was so long that some officers jokingly referred to it as "The Mother of all FRAGOs."⁴²

Fragmentary Order 749 began with definitions. First, this Fragmentary Order defined two major categories for CJTF-7 detainees, Civilian Internees (CIs) and Enemy Prisoners of War (EPWs).⁴³ Both CIs and EPWs were defined in accordance with their doctrinal definitions. Undoctrinally, however, CJTF-7 created two additional categorizations within the CI category, namely, "Criminal Detainees" and "Security Internees."⁴⁴ These additional sub-categories were created to reflect two different sets of handling procedures, both of which are discussed below. Also, the Fragmentary Order stated that both CIs and EPWs could be labeled with up to two additional caveats, "Criminal Investigation Division (CID) Hold" or "MI Hold." A CI or EPW with the additional "CID Hold" caveat could not be released until this caveat had been lifted by a U.S. Army CID agent.⁴⁵ Similarly, a detainee with the "MI Hold" caveat could not be released until this caveat had been lifted by a U.S. MI soldier.⁴⁶

According to Fragmentary Order 749, subordinate units had 48 hours to report through operational channels "that a person has been detained."⁴⁷ This initial report had to include "the person's name, address, and age; date, time, location, circumstances of capture and if applicable, capture tag number."⁴⁸ Subordinate units then had 72 hours (and up to two weeks for security internees) to either release detainees or transport them to the Baghdad Central Confinement Facility at the Abu Ghraib Prison.⁴⁹ When

transporting detainees to Abu Ghraib, subordinate units were responsible for ensuring all required documentation and evidence accompanied detainees; this documentation included a Coalition Provisional Authority Forces Apprehension Form, two sworn statements "from coalition soldiers/officers or Iraqi nationals that witnessed the crime/incident and apprehension," and an evidence/property custody form for any evidence or personal property accompanying the detainee.⁵⁰ At Abu Ghraib, detainees underwent "induction," which Fragmentary Order 749 defined as "the process by which a detainee or internee is received in the Coalition Holding Facility"⁵¹ and which included inputting a detainee's personal data and circumstances of capture into the National Detainee Reporting System,⁵² a classified database that MPs in Iraq were required to maintain.⁵³

Table 2. CJTF-7 Detainee Classifications

CJTF-7 Detainee Classifications	
Category	Description
Civilian Internees (CIs)	A doctrinal term, CJTF-7 applied this category to individuals who had "committed an offense (insurgent or criminal) against the detaining power." According to regulation and this CJTF-7 order, such detainees were entitled to Geneva Convention IV protections
Criminal Detainee	A sub-category of CIs, this is a person detained because he/she is reasonably suspected of having committed a crime against Iraqi Nationals or Iraqi property on a crime not related to the coalition force mission." Such detainees were to be handed over to the nascent Iraqi legal system for disposition.
Security Internee	A sub-category of CIs, this is primarily suspected insurgents, though it also included individuals suspected of war crimes. This category was further broken down to include High Value Detainees, who were defined as "security internees of significant intelligence or political value."
Enemy Prisoners of War (EPWs)	Another doctrinal term, CJTF-7 applied this category to a "member of armed or uniformed security forces that conform to the requirements of Article 4, Geneva Convention, relating to the treatment of prisoners of war." Such detainees were entitled to Geneva Convention III protections.

Source: CJTF-7 Headquarters, "FRAGO 749 to CJTF OPORD 03-036 (Annex 17 to Formica Report)," *The Office of the Secretary of Defense and Joint Staff Reading Room*, August 24, 2004, http://www.dod.mil/pubs/foi/detainees/formica_annexes_1.pdf (accessed January 13, 2009), 40-41.

Fragmentary Order 749 also stated that, after induction at Abu Ghraib, the "Detention Review Authority" had 72 hours to determine whether a detainee was a "Criminal Detainee," "Security Internee," or EPW.⁵⁴ The Detention Review Authority, which consisted of CJTF-7 Judge Advocate General officers (of captain or higher rank), also had the authority to release Iraqis suspected of minor crimes as well as to recommend, in the case of legally insufficient evidence, the release of Iraqis suspected of major crimes.⁵⁵ The Detention Review Authority would make recommendation for the release of Criminal Detainees suspected of major crimes to the Release Board, which initially consisted of Colonel Marc Warren, the senior legal officer in CJTF-7, and Brigadier General Karpinski, the 800th MP Brigade Commander.⁵⁶ The Detention Review Authority would also make recommendations for the release of any Security Internees (suspected insurgents) to the Review and Appeal Board, which initially consisted of Major General Fast, Colonel Warren, and Colonel Robert Hipwell, the CJTF-7 Provost Marshall.⁵⁷ In accordance with Article 78 of Geneva Convention IV, all detainees had the right to appeal their continued internment: in the case of Criminal Detainees, such appeals would be forwarded to the Release Board, and in the case of Security Internees, such appeals would be forwarded to the Review and Appeal Board.⁵⁸ If unappealed, the first time either board of senior officers would review a detainee's case was after the detainee had been in detention for six months.⁵⁹

The theater-wide detention procedures which CJTF-7 put in place in August 2003 were comprehensive and fully commensurate with the Law of War. Plus, these procedures made sense--at least in theory.⁶⁰ Nonetheless, despite CJTF-7's development of comprehensive procedures for handling detainees, serious problems remained in its

detention system. The problem (as always) was resources: CJTF-7 simply could not sufficiently resource the detention procedures outlined in Fragmentary Order 749. For one, giving subordinate units just 72 hours to build evidence packets and transport criminal detainees to a coalition holding facility was not always practical, considering the dangerous environments through which units maneuvered.

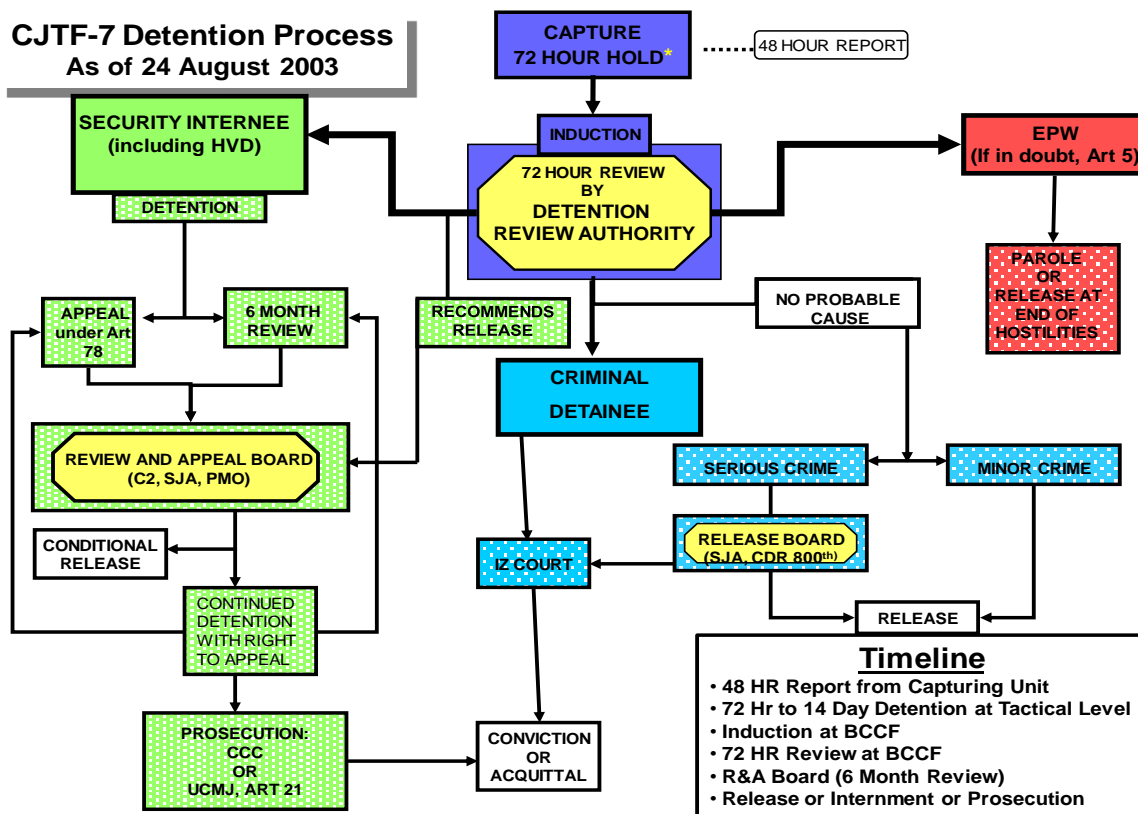

Figure 5. CJTF-7 Detention Process

Source: CJTF-7 Staff, "Detention Summit Briefing to LTG Sanchez," Camp Victory, Iraq, Slide 8.

More troubling still, there were not enough military lawyers to meet the suspense of conducting a 72-hour review of a detainee's status once a detainee had been inducted

into a coalition detention facility. One CJTF-7 lawyer later referred to a "backlog of 8,000 files" that had accrued during the summer of 2003, and he said that Colonel Warren had been forced to bring in as many lawyers as "he could get his hands on" to reduce this backlog of detainee files.⁶¹ Since it would have taken several weeks if not months for such a backlog to accrue, it can be inferred from this lawyer's statement that, at least through the first half of OIF I, there may have been thousands of detainees held in coalition detention facilities without probable cause for far longer than the 72 hours directed by Fragmentary Order 749. Fortunately, a full-time detainee review board existed by February 2004, and according to Lieutenant General Sanchez' testimony, this board was reviewing 100 detainee packets a day (which presumably was sufficient to prevent a large backlog).⁶²

Yet, the detention of Iraqis on little probable cause for weeks or even months for much of OIF I no doubt created much bitterness among wrongfully-detained Iraqis and their families. Such bitterness could have done nothing but aid the insurgency. It seems that, due to no lack of effort on the part of CJTF-7's leaders but rather due to a lack of resources, CJTF-7 was often unable to accomplish everything its leaders clearly knew they needed to accomplish with regard to detention procedures.

CJTF-7's Austere Interrogation Facilities

On March 22, 2003, "Task Force EPW"⁶³ of the 3rd Infantry Division established a Division EPW Collection Point on Assault Point Barrow on the Talil Air Base in south-central Iraq.⁶⁴ Two days later, Task Force EPW handed off control of the Division Collection Point at the air base to the 709th MP Battalion and headed north behind 3rd Infantry Division combat forces.⁶⁵ This collection point would eventually become the

Camp Whitford detention facility, the first semi-permanent U.S. detention facility established in Iraq. Meanwhile 300 kilometers to the south, U.S. forces assumed responsibility on April 9, 2003, of Camp Freddy, which British forces had established near the Kuwait border and the Iraqi port city of Umm Qasar.⁶⁶ Three days later, interrogators from the 1st Marine Expeditionary Force and the 323rd MI Battalion began conducting interrogation operations at this formerly British facility,⁶⁷ now re-named Camp Bucca by U.S. forces. Throughout the invasion, Camp Whitford would serve as a trans-shipment point, the place maneuver units would take prisoners for transport by the 800th MP Brigade to Camp Bucca, the theater internment facility, in the south.⁶⁸

During the course of the invasion, Task Force EPW established additional temporary division collection points, first at Life Support Area Bushmaster near An Najaf on April 8, 2003, and then at Camp Dogwood, which was located just an hour south of Baghdad near Iskandaria.⁶⁹ On May 1, 2003, the division's detention and interrogation operations moved north again, this time settling within the sprawling confines of the Baghdad International Airport.⁷⁰ Within this airport's walls, the 205th MI Brigade's 519th MI Battalion and 223rd MI (Linguist) Battalion and the 513th MI Brigade's 202nd MI Battalion set up the second enduring corps-level interrogation facility to be established in Iraq, Camp Cropper.⁷¹

In addition to corps-level interrogation operations at Camp Cropper, CJTF-7 assumed responsibility on June 14, 2003, for interrogation operations at Camps Whitford, Bucca, and Ashraf.⁷² Camp Ashraf was located near Baquba, about 100 kilometers west of the Iranian border and 60 kilometers northeast of Baghdad, and it was an EPW facility that held about 3,800 members of the Iranian insurgent group, the Mujahedin el-Khalq.⁷³

On July 3, 2003, Ambassador Bremer approved the use of Abu Ghraib Prison as a coalition holding facility.⁷⁴ Bremer's decision was controversial because of the prison's notoriety: under the oversight of Saddam's Special Security Organization, tens of thousands of political prisoners had been tortured and executed there, and Bremer was sensitive to the Iraqi perception that Saddam's tyrannical Iraqi regime had simply been replaced by a tyrannical U.S. regime--a perception already aided by the coalition tactic of appropriating Saddam's palaces for use by military headquarters units. When making the decision to re-open Abu Ghraib, Bremer did so under the belief that the facility would be closed as soon as an Iraqi government could be formed and a new prison constructed.⁷⁵

With the approval to use Abu Ghraib secured, Lieutenant General Sanchez chose to consolidate interrogation operations by October 1, 2003, at Abu Ghraib, now re-named the Baghdad Central Confinement Facility, and re-designate this facility as the Theater Internment Facility. A component of Sanchez' decision to centrally consolidate interrogation operations was his decision to also close the main Camp Cropper detention facility, which would result in the transfer of interrogators from this facility to the Abu Ghraib detention facility in mid-September 2003. This closure left only the High Value Detainee detention facility still operational at the Camp Cropper site. (This special detention facility is discussed below.) Additionally, Camp Whitford was closed and U.S. interrogation operations at Camp Bucca ceased. By the time British forces resumed responsibility for a few months of Camp Bucca on September 25, 2003, U.S. interrogators had already moved from Camp Bucca and Camp Whitford to the Abu Ghraib detention facility.⁷⁶

Below are descriptions of the three sites for large-scale interrogation operations in CJTF-7.

Camp Bucca. When CJTF-7 inherited Camp Bucca, the detention facility was CJTF-7's least-crowded facility. Although Camp Bucca had a capacity for 4000 detainees, only 2539 detainees were being held at this facility on August 19, 2003.⁷⁷ During Major General Taguba's investigation into Abu Ghraib abuses from January to March 2004, however, he found that Camp Bucca had become overcrowded.⁷⁸ This temporary overcrowding would be remedied by OIF II, thanks in part to a new facility at the camp that could hold 500 more detainees than the old facility.⁷⁹

During an inspection in the spring of 2004, the Army Inspector General inspection team found internal security problems at the camp, to include blind spots for guards along the perimeter, inadequate communications systems, and poorly constructed concertina barriers.⁸⁰ The team also pointed out detainee life-support issues at the camp, to include inadequate laundry services and the location of a water source near a sewage point.⁸¹

On May 12, 2003, a serious incident of detainee abuse involving multiple detainees and multiple MPs occurred at Camp Bucca.⁸² The abuse involved the battering of several detainees by MPs, to include one detainee having his nose broken.⁸³ An Army CID investigation followed, and this investigation's final report substantiated Cruelty and Maltreatment of Detainees and other UCMJ charges against 10 MPs for the incident.⁸⁴ Despite this serious incident of MP abuse, the ICRC would report in February 2004 that interrogators at Camp Bucca were not abusing detainees to the degree that their counterparts at Camp Cropper and (especially) Abu Ghraib were abusing detainees.

Significantly, this ICRC report contained no allegations that suggested that Camp Bucca interrogators were using SERE interrogation techniques: according to the report, although interrogators at Camp Bucca would curse and verbally threaten their subjects, "none of those interviewed by the ICRC in Um Qasr and Camp Bucca spoke of physical ill-treatment during interrogation."⁸⁵

Nonetheless, one case of substantiated interrogation abuse occurred at Camp Bucca. A counterintelligence specialist (not an interrogator) was questioning three detainees when one of the detainees tried to strike his questioner.⁸⁶ The soldier responded by punching the detainee in the left eye with a closed fist.⁸⁷ This instance of violence, however, had nothing to do with SERE interrogation techniques but rather was due to the inexperience of the questioner.

Throughout OIF I, MPs at Camp Bucca had the ability to induct new detainees into the coalition detention system. However, Abu Ghraib Prison would assume primary responsibility for this function after CJTF-7 consolidated its detention operations at Abu Ghraib Prison on October 1, 2003. Subsequently, even if a criminal or insurgent were captured just outside Camp Bucca's gates, MPs had to make the two-day roundtrip to take the detainee to Abu Ghraib for initial induction and interrogation.⁸⁸ With regard to the release of detainees, Camp Bucca released detainees during OIF I by dropping them off at a nearby Iraqi bus station with sufficient cash to purchase a ticket home.⁸⁹ This release procedure did not change until Major General Geoffrey Miller became Deputy Commander for Detainee Operations of Multi-National Force-Iraq, at which time he required Camp Bucca's MPs to transport all detainees to Abu Ghraib for release.⁹⁰

Camp Cropper. By the time CJTF-7 assumed control, Camp Cropper contained two segregated facilities, the main Camp Cropper camp and a Special Confinement Facility.⁹¹ This Special Confinement Facility was reserved for High Value Detainees.⁹² High Value Detainees were primarily senior political members of Saddam's regime: any captured Iraqi from the "deck of 55"--the 55 most wanted fugitives as pictured on a deck of playing cards issued to coalition forces--were held in this special facility.⁹³

CJTF-7's major subordinate commands were responsible for transporting detainees to Camp Cropper. Once at Camp Cropper, MPs from the 115th MP Battalion would induct all new detainees. After detention and possibly interrogation, these MPs would either transport detainees to Camp Bucca (which was the "theater internment facility" for the first half of OIF I) or release them. When releasing detainees, MPs would transport detainees in a coalition-owned passenger bus (nicknamed the "freedom bus") to a release point near their point of capture.⁹⁴

Although the main camp at Camp Cropper had been built to hold no more than 450 detainees,⁹⁵ it held approximately 1200 detainees by July 2003.⁹⁶ Dramatic overcrowding greatly contributed to the significant life support issues that Camp Cropper struggled with during the first few months of its existence. According to the ICRC, Camp Cropper's problems at this time included inadequate showers, latrines, waste removal, bedding, food, and water stations for detainees.⁹⁷ It should be noted, however, that coalition forces similarly lacked adequate life support at this time in Iraq: the days of air-conditioned tents, giant buffet-style dining facilities, a large post exchange, and even restaurants had not yet arrived for coalition forces at the airport (though these days would arrive impressively fast). Just as living conditions were to dramatically improve for

coalition soldiers at the airport as the summer progressed, living conditions were to also greatly improve for detainees at Camp Cropper: the ICRC would report on August 3, 2003, that Camp Cropper had shown significant improvement with regard to all life support issues, and detainees were being afforded such Geneva rights as elected representation at regular meetings with camp authorities.⁹⁸

More troubling than poor living conditions, however, was the ICRC's forwarding in early July 2003 a list of 50 cases alleging detainee abuse by interrogators at Camp Cropper.⁹⁹ The ICRC alleged that Camp Cropper interrogators were communicating threats to subjects (to include threatening to intern subjects indefinitely, to arrest family members, or to transfer subjects to GTMO); hooding subjects; employing "stress positions (kneeling, squatting, standing with arms raised above head) for three or four hours;" "taking aim at individuals with rifles;" striking sources "with rifle butts, slaps, punches;" and forcing subjects to endure "prolonged exposure to the sun" and "isolation in dark cells."¹⁰⁰ The use of "isolation" in the High Value Detainee facility was allegedly especially severe, with detainees kept "in cells devoid of sunlight for nearly 23 hours a day."¹⁰¹ Adding credibility to the ICRC's allegations are the facts that, one, most of this abuse is consistent with descriptions of SERE techniques, and two, at least three-to-four interrogators at Camp Cropper had previous experience in Afghanistan, where the use of certain SERE techniques had been formally promulgated as interrogation policy.¹⁰²

Additionally, the ICRC alleged that some detainees had been beaten at a nearby location before being taken to Camp Cropper.¹⁰³ This is consistent with an allegation later made by a member of the Iraqi Survey Group that special operations soldiers at a location close to Camp Cropper (probably Camp Nama) were beating detainees before

transporting them to Camp Cropper or after checking detainees out of Camp Cropper for up to 72 hours.¹⁰⁴ This allegation is also consistent with testimonies collected in various open-source reports regarding physical abuse at Camp Nama.¹⁰⁵

More than half a year after the ICRC's allegations of abuse at Camp Cropper, Lieutenant Colonel Natalie Lee investigated the allegation that special operations soldiers had beaten detainees interned at Camp Cropper. Lee concluded that she could find insufficient evidence to substantiate this allegation.¹⁰⁶ According to the Church Report, however, Lieutenant Colonel Lee's report was "extremely brief and cursory, and there were obvious gaps in the investigation methodology."¹⁰⁷ Most importantly, the Church Report noted, she did not locate or interview certain key personnel.¹⁰⁸ (Due to the long passage of time between her investigation and the alleged incidents, these key personnel had already left Iraq.)¹⁰⁹ The Church Report concluded that this "passage of time is unexplained, and represents a lost opportunity to address potential detainee abuse in Iraq early on."¹¹⁰

Due to the large number of allegations of abuse at Camp Cropper during its first 3-4 months of existence, the February 2004 ICRC report put the camp on its short list of the "main places of internment" where alleged detainee abuse had taken place during the previous year.¹¹¹ This ICRC report also noted, however, that after forwarding the initial 50 cases of alleged abuse to coalition forces, the alleged abuse of detainees by Camp Cropper interrogators had eventually "declined significantly and even stopped."¹¹² Conversely, the same ICRC report stated that its earlier allegations concerning abuse at Abu Ghraib had not only not stopped but had actually been adopted as part of the

facility's "standard operating procedures"--an allegation later substantiated by investigators.¹¹³

Abu Ghraib. After the Abu Ghraib Prison re-opened, CJTF-7's major subordinate units were responsible for taking captured Iraqis to this facility for induction and internment. The Abu Ghraib prison consisted of three separate facilities--the hard site, Camp Vigilant, and Camp Ganci.¹¹⁴ Although the hard site was a Coalition Provisional Authority-supervised, Iraqi-run detention site for criminals, the 205th MI Brigade Headquarters successfully coordinated with the Coalition Provisional Authority for interrogators to use cells in the Tier 1 section of the hard site.¹¹⁵ These 40 Tier I cells, which was where the most infamous Abu Ghraib abuses would occur, were employed to hold detainees for immediate interrogation.¹¹⁶ The advantage of using these cells to house subjects for interrogation was that these detainees could be segregated so that they could not brief each other regarding interrogations.¹¹⁷

Camp Ganci was built to hold up to 4000 criminal detainees, but by March 2004, this eight-compound camp held 5000 detainees.¹¹⁸ Camp Vigilant, which was the long-term holding pen for suspected insurgents (or "Security Internees"), was built to hold no more than 400 detainees.¹¹⁹ Yet, its population would grow to nearly 1000 detainees by March 2004.¹²⁰ In fact, both the hard site and Camp Vigilant were overcrowded as early as November 2003.¹²¹ Compounding the overcrowding issue was the extremely poor MP-to-detainee ration: for instance, there were only 90 MPs in charge of 7,000 detainees at the facility in October 2003.¹²² Investigators would also note that the 320th MP Battalion, which had transferred from Camp Bucca (where several members had participated in the cases of detainee abuse described above), was running Abu Ghraib.

The Abu Ghraib detention facility suffered from frequent mortar attacks, sometimes with deadly results. These attacks included a mortar attack on August 16, 2003, that killed five detainees and injured 67 other detainees;¹²³ a mortar attack on September 20, 2003, that killed two U.S. soldiers and injured 11 other soldiers (including the commander of the Joint Interrogation Center);¹²⁴ and a mortar attack on April 20, 2004, that left 22 detainees dead and more than 100 injured.¹²⁵ In their February 2004 report, the ICRC pointed out that placing the detainees in this facility at such grave risk constituted a violation of Article 83 of the Fourth Geneva Convention, which states that detainees cannot be interned in areas "particularly exposed to the dangers of war."¹²⁶ The Army Inspector General team that visited Abu Ghraib in the Spring of 2004 also pointed out significant life support issues at the facility, to include a "deteriorating infrastructure" and "poor food quality and food distribution, lack of laundry capability, and inadequate personal hygiene facilities."¹²⁷

On August 4, 2003, 14 interrogators from Company A, 519th MI Battalion, comma (including Captain Wood and one warrant officer) arrived at the facility to begin conducting interrogations.¹²⁸ This unit had redeployed from Bagram Air Base in Afghanistan at the end of January 2003, where they had been introduced to SERE techniques.¹²⁹ In fact, CID was still investigating two of these 14 interrogators for alleged abuse in Afghanistan that had resulted in the deaths of two detainees.¹³⁰ (CID would ultimately substantiate the charges against these two interrogators. Not surprisingly, these same two interrogators would sexually assault a female detainee on October 7, 2003, at the Abu Ghraib detention facility.) As discussed in Chapter 3,

Captain Wood's interrogators immediately began using the harsh interrogation techniques of "sleep adjustment" and "stress positions" at Abu Ghraib.

The ICRC visited Abu Ghraib on October 9-12 and 21-23, 2003, just when the worst, most criminal abuses at the facility had begun.¹³¹ In a subsequent November report, the ICRC's inspectors gave to coalition forces a long list of abusive interrogation practices at the facility--a report that Lieutenant General Sanchez would later testify he had personally reviewed.¹³²

Although the Abu Ghraib scandal would mainly involve soldiers of the 372nd MP Company, a reserve unit based out of Maryland that had just arrived in country before the most infamous photographed abuses,¹³³ two MI soldiers would also be imprisoned for their role in detainee abuse at the facility. One of the Army investigators into the Abu Ghraib scandal, Major General Fay, would find 16 cases of detainee abuse that had been allegedly committed by MP soldiers at the instigation of MI soldiers.¹³⁴ Fay would find an additional 11 cases of alleged abuse in which MI soldiers had been directly involved.¹³⁵ It should be noted here, however, that Fay also classified as abuse the SERE techniques of "Use of Military Working Dogs," "Forced Nudity," and "Isolation"-- techniques believed to be authorized by the interrogators who used them.

"Short-Lived and Poorly Drafted" Interrogation Policies¹³⁶

During the first few months of OIF I, U.S. Central Command, Coalition Forces Land Component Command, and CJTF-7 did not publish any policy governing interrogation approaches in Iraq.¹³⁷ During this time period, the only document that maneuver divisions in Iraq could turn to for interrogation guidance was FM 34-52, *Intelligence Interrogation* (September 1992).

One of the recommendations of Major General Miller's GTMO team, which inspected CJTF-7's interrogation operations from August 31 to September 9, 2003, was for CJTF-7 to establish written guidance "specifically addressing interrogation policies and authorities" for dissemination to units.¹³⁸ The Miller Report stated that the CJTF-7 staff had already begun to work on such a policy at the time of the report's writing.¹³⁹ Part of the staffing process for this policy probably included the initial request for a "wish list" of interrogation techniques--a request which was emailed out by a CJTF-7 J2X captain on August 14, 2003, and which was discussed in Chapter 1.

Within a week of the departure of Major General Miller's GTMO team, Lieutenant General Sanchez signed CJTF-7's first interrogation policy. In this September 14, 2003, policy memorandum, several SERE interrogation techniques were formally authorized for use in CJTF-7.¹⁴⁰ These SERE techniques included "Dietary Manipulation," "Environmental Manipulation," "Sleep Adjustment," "Isolation," "Sleep Management," "Presence of Military Working Dog," "Yelling, Loud Music, and Light Control," "Deception," and "Stress Positions."¹⁴¹ In addition, this list included an approach from the rescinded 1987 version of FM 34-52. This approach was the "Mutt and Jeff" (or "good cop/bad cop") approach, and the CJTF-7 September policy memo warned that this technique should be used with caution since some countries might consider the use of this technique as "inconsistent" with Article 13 of the Third Geneva Convention.¹⁴² Six of the interrogation approaches and techniques listed in this September memo required CG approval.¹⁴³ But interrogators could still employ such harsh interrogation techniques as "Sleep Adjustment," "Dietary Manipulation,"

"Environmental Manipulation," "Sleep Management," and "Yelling, Loud Music, and Light Control" on their own.¹⁴⁴

Unlike at GTMO, Rumsfeld's approval was never sought for the use of harsh techniques in Iraq: "As in Afghanistan," the Church Report stated, "interrogation policy in Iraq was developed and promulgated by the senior command in the theater."¹⁴⁵ Both Lieutenant General Sanchez and his superior officer, General Abizaid, testified before the Senate Armed Services Committee that they believed they had the authority to approve these techniques, despite the fact that such techniques ran counter to DoD directives and guidance. In fact, Lieutenant General Sanchez seemed to believe that, by specifying which harsh interrogation techniques could be used, he was actually reducing the chance of abuse by "imposing standards and approval and oversight mechanisms."¹⁴⁶

After approving the September memorandum, Lieutenant General Sanchez forwarded the memorandum to U.S. Central Command for review. Upon reviewing the memorandum, U.S. Central Command's lawyers deemed some of the memorandum's interrogation techniques to be "unacceptably aggressive."¹⁴⁷ It is unclear from unclassified sources why this was the case since these lawyers were probably familiar with the similar techniques then being employed in Afghanistan. The reason for this determination probably had something to do with the fact that national policy had only exempted members of al Qaeda and the Taliban from Geneva protections in the event of "military necessity," and this exemption was commonly perceived at this time as not applying to detainees in Iraq. (Abu Musab Zarqawi had not yet affiliated his growing terrorist organization in Iraq with al Qaeda.) So, another interrogation policy was staffed at CJTF-7 and approved by Sanchez on October 10, 2003.¹⁴⁸

INTERROGATION RULES OF ENGAGEMENT

Approved approaches for

All detainees:

Direct
 Incentive
 Incentive Removal
 Emotional Love / Hate
 Fear Up Harsh
 Fear Up Mild
 Reduced Fear
 Pride & Ego Up
 Futility
 We Know All
 Establish Your Identity
 Repetition
 File & Dossier
 Rapid Fire
 Silence

Require CG's Approval:

Change of scenery down
 Dietary Manip (monitored by med)
 Environmental Manipulation
 Sleep Adjustment (reverse sched)
 Isolation for longer than 30 days
 Presence of Mil Working Dogs
 Sleep Management (72 hrs max)
 Sensory Deprivation (72 hrs max)
 Stress Positions (no longer than 45 min)

Safeguards:

- ~ Techniques must be annotated in questioning strategy
- ~ Approaches must always be humane and lawful
- ~ Detainees will NEVER be touched in a malicious or unwanted manner
- ~ Wounded or medically burdened detainees must be medically cleared prior to interrogation
- ~ The Geneva Conventions apply within CJTF-7

**EVERYONE IS RESPONSIBLE FOR ENSURING COMPLIANCE TO THE IROE.
 VIOLATIONS MUST BE REPORTED IMMEDIATELY TO THE OIC.**

The use of the techniques are subjects to the general safeguards as provided as well as specific guidelines implemented by the 205th MI Cdr. FM 34-52, and the Commanding General, CJTF-7

Figure 6. Interrogation Approaches Posted at Abu Ghraib, Oct-Dec 2003

Source: Captain Carolyn Wood, "Interrogation Rules of Engagement," *American Civil Liberties Union: Torture FOIA*, October-December 2003, <http://www.aclu.org/projects/foiasearch/pdf/DODDOA003220.pdf> (accessed April 30, 2009), 3.

Since the October 2003 policy no longer listed the "aggressive" techniques contained in the September memo, the October memo seemed to be executing U.S. Central Command's intent of eliminating these aggressive techniques. However, since such techniques could still be submitted with "recommended safeguards" and a "legal review" to Sanchez for approval, the October memo actually allowed the continued use of such techniques under the same conditions these techniques had previously been used (that is, with Sanchez' approval).¹⁴⁹ As illustrated in Figure 6 above, this is certainly how Abu Ghraib interrogators understood the October memo.¹⁵⁰ What is more, because of newly added, ambiguous phrasing in this memo, some interrogators (again, most clearly

those at Abu Ghraib) treated the October memo as if it were more permissive than the September memo, giving them the latitude at their level to employ SERE techniques.

One of the reasons for this permissive interpretation of the October memo was a sentence in this memo from the outdated, 1987 version of FM 34-52. This new sentence stated that interrogators needed to control "all aspects of the interrogation, to include the lighting, heating and configuration of the interrogation room, as well as the food, clothing and shelter given to the security internee."¹⁵¹ It is easy to see how interrogators may have thought such earlier CJTF-7 interrogation techniques as "Environmental Manipulation," "Dietary Manipulation," and "Light Control"¹⁵² had simply migrated to this sentence of the October memo.¹⁵³ Furthermore, some interrogators at Abu Ghraib misinterpreted the October memo's injunction that interrogators must control even a detainee's clothing as a license to now use, without higher approval, the "Forced Nudity" technique they had become acquainted with during their previous deployments to either Afghanistan or GTMO.¹⁵⁴ The fact that the October memo kept as a technique "Removal of Incentive," which some interrogators mistook to potentially include the removal of clothing, reinforced this perception.¹⁵⁵

Nearly as tragic was how interrogators misinterpreted the October memorandum with regard to the use of military working dogs.¹⁵⁶ The September memorandum had offered the "presence of military working dogs" as a technique that, with Lieutenant General Sanchez' approval, could be used to exploit the "Arab fear of dogs while maintaining security during interrogations." The October memorandum no longer listed the use of dogs as an interrogation technique, but it stated that, "should military working dogs be present during interrogations, they will be muzzled and under control of a

handler at all times to ensure safety."¹⁵⁷ Colonel Warren later stated that the intent of the October memorandum had been to convey that military working dogs could be used as a means to control detainees (that is, as a thinly veiled threat against detainee misbehavior) and not as an interrogation technique.¹⁵⁸ However, due to the ambiguity of the phrasing in the October memorandum, almost as soon as military working dogs arrived at Abu Ghraib on November 20, 2003, interrogators began using these dogs as part of "Fear Up (Harsh)" interrogation approaches with Colonel Pappas' approval.¹⁵⁹

Many of CJTF-7's subordinate units did not immediately get the word that CJTF-7's September interrogation policy had been rescinded. One of these units was Combined Joint Special Operations Task Force-Arabian Peninsula (CJSOTF-AP), a task force that, according to news reports, included the Army's 5th and 10th Special Forces Groups.¹⁶⁰ After investigating allegations of interrogation abuse within CJSOTF-AP, Brigadier Richard Formica noted that this unit produced an interrogation policy on February 27, 2004, that referenced CJTF-7's September interrogation policy.¹⁶¹ Apparently, CJSOTF-AP did not find out about CJTF-7's October 10, 2003, interrogation policy until May 29, 2004.¹⁶² The problem here was in how CJTF-7 promulgated its October policy: the policy was simply posted on CJTF-7's classified website and no one bothered to call units to ensure they were aware of the new policy.¹⁶³

Although CJTF-7 directed that its interrogators receive training on the non-doctrinal interrogation approaches outlined in its interrogation policy memoranda, it did not direct who would conduct this training--and who would train these unit trainers on how to use new techniques. Since this was the first time most interrogators in Iraq had seen these techniques, expecting they would know how to implement these techniques

was (at best) an unrealistic expectation. CW3 Kenneth Kilbourne, a HUMINT warrant officer in Company A, 501st MI Battalion, would later say: "This memo was idiotic; it was like providing a new, dangerous piece of equipment to a soldier and telling them that they are authorized to use it, but you don't have an instruction manual to give them to show them how to operate it safely and effectively."¹⁶⁴

In short, thanks to incomplete and inconsistent Army doctrine; vague, ambiguous, and poorly promulgated CJTF-7 policy memoranda, and a lack of effective training on new interrogation techniques, various inspectors found a wide variety of interrogation techniques being employed by different units across Iraq during OIF I. The consequence of this variety was, in some cases, interrogation abuse. Speaking to this, the Mikolashek Report noted, "The potential for abuse increases when interrogations are conducted in an emotionally-charged environment by untrained personnel who are unfamiliar with the approved interrogation approach techniques."¹⁶⁵

Key Conclusions

Iraq was a tough environment for coalition units during OIF I. Many of the difficulties faced by these units, however, could not have been prevented by the U.S.'s civilian and military leaders during 2003. Most notably, since the U.S. military's leaders in the 1980s and 1990s had done a poor job of predicting the Clausewitzian "nature" of its next fight (hardly a singular occurrence in our nation's history), the U.S. Army was simply not built to wage large-scale counterinsurgency operations in 2003. The Army's kinetic mindset in 2003--the personality it had assumed during the previous decades of equipping, training, and doctrine--all but assured that, during that first terribly hot summer of OIF I, the feelings of triumph, even of invincibility experienced by coalition

forces would quickly dissipate and be replaced by feelings of confusion, uneasiness, and desperation. It also guaranteed that the V Corps headquarters and many of its subordinate units would find themselves floundering as part of a force of occupation.

Still, the hard-working leaders and soldiers of CJTF-7 would probably have found a way to secure Iraq if only CJTF-7 had been adequately resourced. As opposed to the character of the Army in 2003, the woefully inadequate resourcing of CJTF-7 did derive from poor decisions made by senior U.S. political and military leaders during 2003. It is hard to even understand today how CJTF-7 could have been so inadequately resourced. When the critics of the Bush Administration (and of Donald Rumsfeld and Paul Wolfowitz in particular) chalk up CJTF-7's lack of resources to false assumptions and personal hubris, history may very well conclude that these critics are right.

Thanks to poor decisions made in Washington, the list of "not nearly enough's" with regard to CJTF-7 was extensive: CJTF-7 did not have nearly enough ground troops to secure key sites in Iraq; the CJTF-7 headquarters did not have nearly enough personnel to function effectively; there were not nearly enough construction engineers to build adequate coalition detention facilities while simultaneously re-building Iraq's infrastructure; there were not nearly enough MPs who had been trained in detention operations to prevent untrained detention personnel from unwittingly abusing detainees; there were not nearly enough military lawyers to ensure that, when innocent Iraqis were swept up with guilty Iraqis, these innocent Iraqis' cases could be promptly reviewed and these innocents released; and, most relevantly to this paper, there were not nearly enough HUMINT personnel in Iraq. Largely as a result of this shortage of HUMINT personnel, CJTF-7 often seemed a "black hole" when it came to providing intelligence from the

detainees that subordinate units like 1AD sent to it, which left units like 1AD often seeing little sense to the requirement to rapidly expedite detainees to coalition holding facilities.

Worst of all, harsh interrogation techniques were used systemically at Abu Ghraib and special operations facilities (and probably briefly at Camp Cropper as well). At Abu Ghraib, these harsh techniques rapidly descended into sadistic, sexualized violence that shamed a nation. Contributing factors for this abuse are numerous, but perhaps the most troubling factors were the ones that derived from CJTF-7's poorly considered and written policy memoranda, since these factors could have been easily prevented.¹⁶⁶

Despite ethical failures at a few theater-level detention facilities, the vast majority of OIF I units adapted remarkably well to their tough circumstances and conducted themselves with honor while initiating the processes that would eventually culminate in a democratic Iraq. The largest of these units was the 1AD.

¹David DeBatto, "Testimony of Former U.S. Army Counterintelligence Special Agent David DeBatto, previously assigned to 205th Military Intelligence Brigade under Colonel Thomas Pappas in 2003, for the German criminal procedure against DOD Donald Rumsfeld and others," *Republikanischer Anwaltinnen-und Anwalteverein*, http://www.rav.de/download/Testimony_DeBatto.pdf (accessed January 10, 2009), 2. David DeBatto was a senior enlisted counterintelligence soldier in the 223rd MI Battalion, which was attached to the 205th MI Brigade for OIF I. Mr. DeBatto's testimony was part of a criminal complaint filed by the Center for Constitutional Rights and four Iraqi citizens against Rumsfeld and ten other American political and military leaders. This complaint, which was filed on November 30, 2004, in the Stuttgart State Supreme Court, alleged violations of Law of War. Citing jurisdiction concerns, this court declared the petition inadmissible on September 13, 2005. When an appeal was then heard by the German Federal Supreme Court, the highest German court upheld the lower court's decision and declined to initiate proceedings. The court's decision here can be read at the following url, <http://ccrjustice.org/files/ProsecutorsDecision.pdf>.

²Wright and Reese, 622. The author can attest to the purpose and character of this exercise because he participated in this exercise.

³Perhaps no example better illustrates the joy even many Sunnis felt at Saddam's fall than the fact that the famous video footage of a statue of Saddam being pulled down

in front of a cheering, dancing Iraqi crowd took place in largely Sunni Adhamiya, the same Baghdad district where Saddam had bid farewell to his faithful before his escape into hiding. And perhaps there is no sadder example of the rapid change of heart many Sunnis experienced toward coalition forces than the fact that Adhamiya--the same district that had seen such a celebratory scene at Saddam's fall--would become an insurgent stronghold mere months after this famous scene.

⁴Ricks, 152.

⁵Bruce Hoffman, "Insurgency and Counterinsurgency in Iraq, June 2004," *Rand National Security Research Division*, http://www.rand.org/pubs/occasional_papers/2005/RAND_OP127.pdf (accessed January 10, 2008), 12. Hoffman quotes Major General Raymond Odierno, 4ID Commander, as saying that the bounty paid by insurgents to many anti-coalition attackers rapidly increased during OIF I: "When we first got here," Major General Odierno said, "We believed it was about \$100 to conduct an attack against coalition forces, and \$500 if you're successful. We now believe it's somewhere between \$1,000 and \$2,000 if you conduct an attack, and \$3,000 to \$5,000 if you're successful."

⁶Wright and Reese, 160.

⁷*Ibid.*, 38.

⁸Unknown CJTF J2 Planner, "Sworn Statement of LTC, G2 planner for V Corps/CJTF-7; Annex to Fay/Jones/Kern Report," *American Civil Liberties Union: Torture FOIA*, July 16, 2004, <http://www.aclu.org/torturefoia/search/searchresults2.php> (accessed January 10, 2009).

⁹Jones, 9.

¹⁰Unknown CJTF J2 Planner, "Sworn Statement of LTC," 193.

¹¹Wright and Reese, 160.

¹²*Ibid.*, 159.

¹³As late as November 2005, Donald Rumsfeld was still saying that coalition forces faced "terrorists," not "insurgents," in Iraq. The first senior U.S. political or military leader to publicly state he believed that coalition forces faced an insurgency, or a "classic guerilla-type campaign," was the new U.S. Central Command Commander, General Abizaid, on July 16, 2003.

¹⁴Wright and Reese, 159.

¹⁵*Ibid.* "Red Teams" have gained acceptance only recently in the Army. A Red Team serves as a kind of "devil's advocate" during the development of any staff plan, ensuring that the plan's assumptions are considered and, if necessary, questioned; that the

plans adequately address all facets of an operation; that staff-sections are cross-talking during plan development; and that, in general, the plan is as sound as possible considering a particular planning process's time constraints.

¹⁶Ibid., 160.

¹⁷Ibid.

¹⁸Ibid., 192.

¹⁹Ibid.

²⁰Ibid., 193.

²¹Colonel Thomas Pappas, "Sworn Statement of Col, HHD, 205th MI Brigade, Annex to Fay/Jones/Kern Report," *American Civil Liberties Union: Torture FOIA*, May 14, 2004. http://www.aclu.org/torturefoia/released/030905/DOD616_653.pdf (accessed January 10, 2009), 11. Although Colonel Pappas' personal information is redacted from this sworn statement, the Commander of the 205th MI Brigade at this time can be ascertained from numerous investigations and websites. According to this statement, Colonel Pappas' 165th, 223rd, 224th, and 325th MI Battalions were headquartered at Camp Anaconda in Balad, Iraq; the 302nd MI Battalion was headquartered at Camp Victory in Baghdad; the 323rd MI Battalion was headquartered at the Baghdad International Airport; the 519th MI Battalion was headquartered near Tikrit at Camp Speicher; and the 1st MI Battalion remained in Wiesbaden, Germany.

²²John H. McCool, "Interview with MAJ Art La Flamme," *Operational Leadership Experiences in the Global War on Terrorism*, September 13, 2006, <http://cgsc.cdmhost.com/cgi-bin/showfile.exe?CISOROOT=/p4013coll13&CISOPTR=286&filename=287.pdf#search=%22command%22> (accessed January 10, 2009), 5. The Operational Leadership Experiences Project has built a substantial database of interviews of U.S. Army leaders who participated in combat operations during the GWOT, to include several interviews submitted by the author for this paper. This collection of interviews is a great starting point for anyone looking for primary sources regarding the GWOT. The author has 14 interviews archived on this site--interviews that were conducted for this history. The site is located on the Fort Leavenworth's Digital Library website, which also includes a number of first-rate secondary-source offerings, <http://cgsc.leavenworth.army.mil/carl/contentdm/home.htm>.

²³Ibid., 7, 12. The U.S. Army's Tactical Exploitation System brings together signals-, imagery-, and radar-derived intelligence from national- and operational-level intelligence collection platforms. Thus, during the invasion of Iraq, Major La Flamme's analysts fused intelligence from multiple sources to create products in support of maneuver forces. Perhaps most proudly for Major La Flamme, his company provided "intelligence overwatch" for the operators who rescued Private First Class Jessica Lynch.

²⁴Ibid., 15.

²⁵Wright and Reese, 206.

²⁶Ibid., 200.

²⁷Ibid., 205.

²⁸Major Douglas A. Pryer, "Interview with LTC Mark Crisman," *Operational Leadership Experiences in the Global War on Terrorism*, January 27, 2009, http://cgs.cdmhost.com/cdm4/item_viewer.php?CISOROOT=/p4013coll13&CISOPTR=1418&CISOBOX=1&REC=2 (accessed February 13, 2009), 10.

²⁹Department of the Navy Inspector General, "Review," 244, 250.

³⁰Ibid, 243.

³¹Ibid., 243, 250.

³²CJTF-7 Headquarters, "FRAGO 176 (Military Police Task Org Change and OIF I to OIF 2 Transition)," *American Civil Liberties Union: Torture FOIA*. February 1, 2004, <http://www.aclu.org/torturefoia/released/a29.pdf> (accessed January 12, 2009), 3-5.

³³Colonel Ralph Sabatino, "Annex 47, Taguba Report," *The Center for Public Integrity: The Abu Ghraib Supplementary Documents*, February 10, 2004, <http://www.publicintegrity.org/assets/pdf/Abu16.pdf> (accessed January 12, 2009), 11.

³⁴Redacted, "Sworn Statement of S-3, 205th MI Bde," 1.

³⁵800th MP Brigade, "Order of Battle Slides (Annex 41 to Taguba Report)," *The Office of the Secretary of Defense and Joint Staff Reading Room*, February 2004, http://www.dod.mil/pubs/foi/detainees/taguba/ANNEX_041_ORDER_OF_BATTLE_SLIDES.pdf (accessed January 12, 2009), Slide 1.

³⁶CJTF-7 Staff, "Detention Summit Briefing to LTG Sanchez," Camp Victory, Iraq, Slide 39. The author obtained this briefing along with some detention-related emails of CJTF-7 leaders from Mr. Fred Huff, the current V Corps Historian. The slide deck itself is undated; however, supporting data for the slides was retrieved on August 19, 2003. Thus, this slide deck was probably presented to Lieutenant General Sanchez as a decision brief for CJTF-7 FRAGO 749, which was the baseline FRAGO for CJTF-7 detainee operations for the rest of OIF I and which CJTF-7 published on August 24, 2003. This briefing to Lieutenant General Sanchez had, in turn, probably been based on an earlier slide deck presented at a Detention Summit hosted by Major General Fast, the CJ2, on August 11, 2003. It is indicative of the undocrinally large role that the MI branch played early-on in detainee operations during OIF I that the CJ2 rather than the CJTF-7 PMO hosted this August 11, 2003, CJTF-7 detention summit. In fact, the author possesses an August 12, 2003, email from Major General Fast that states that it was not

until this summit that the CJTF-7 Headquarters resolved that the PMO would be the proponent for future detention operations.

³⁷800th MP Brigade, "Order of Battle Slides," Slide 1.

³⁸*Ibid.*, Slide 2.

³⁹*Ibid.*

⁴⁰CJTF-7 Headquarters, "FRAGO 176 (Military Police Task Org Change and OIF I to OIF 2 Transition)," 3.

⁴¹CJTF-7 Headquarters, "FRAGO 749 to CJTF OPOD 03-036 (Annex 17 to Formica Report)," *The Office of the Secretary of Defense and Joint Staff Reading Room*, August 24, 2004, http://www.dod.mil/pubs/foi/detainees/formica_annexes_1.pdf (accessed January 13, 2009), 39.

⁴²Wright and Reese, 205.

⁴³CJTF-7 Headquarters, "FRAGO 749," 40-41.

⁴⁴*Ibid.*

⁴⁵*Ibid.*, 41.

⁴⁶*Ibid.*

⁴⁷*Ibid.*, 43.

⁴⁸*Ibid.*

⁴⁹CJTF-7 Staff, "Detention Summit Briefing," Slide 8.

⁵⁰CJTF-7 Headquarters, "FRAGO 749," 48. This Fragmentary Order also required that the unit transporting a detainee to obtain a detainee's new Individual Serial Number, or ISN, once the detainee was transported to the Abu Ghraib detention facility. The transporting unit was then required to provide to the capturing unit this identification number for the capturing unit's tracking purposes.

⁵¹*Ibid.*, 42.

⁵²Christopher Ives, "Interview with MAJ Douglas Smith," *Operational Leadership Experiences in the Global War on Terrorism*, November 3, 2005, http://cgsc.cdmhost.com/cdm4/item_viewer.php?CISOROOT=/p4013coll13&CISOPTR=86&CISOBX=1&REC=19 (accessed January 10, 2009), 6. Major Smith was the operations officer for the MP battalion who ran Camp Bucca during OIF II. In this interview, Major Smith pointed out that, when he arrived at Camp Bucca in early 2004,

Camp Bucca still retained the capability to induct detainees. However, all detainees had to be initially transferred and inducted at Abu Ghraib, even if the detainee were captured just outside of Camp Bucca's gates. Similarly, he said, the release of detainees would eventually be centralized through the Abu Ghraib detention facility as well, but this would not happen until after Major General Miller became Deputy Commander for Detainee Operations, Multinational Force-Iraq, in April 2004. Although Camp Bucca no longer initiated the induction process, it would repeat the induction process for all of its detainees, double-checking to ensure its detainees' electronic records were accurate and complete.

⁵³Major General Barbara Fast, "Highlights from Detainee 'Summit,' *Email Forwarded to Author from V Corps Historian*," Camp Victory, Baghdad, August 12, 2004, 1. Although not mentioned in Fragmentary Order 749, CJTF-7 was also in the process of adopting a supplemental database called the Biometric Automated Tool System (BATS). The most obvious advantage to this new system was that it incorporated biometrics: thanks to implementation of this database, Iraqis with variant English transliterations of their names could be accurately tracked in and out of coalition detention facilities. According to the Detainee Summit Briefing, other advantages included the ability of the BATS database to handle relatively large files, to interface with a HUMINT database called "CHIMS" and, even more significantly, to interface with unclassified databases then being established for use by Iraqi courts.

⁵⁴CJTF-7 Headquarters, "FRAGO 749," 43.

⁵⁵*Ibid.* Fragmentary Order 749 defined "serious crime" as any crime considered punishable by more than five years imprisonment under the Iraqi Criminal Act of 1969, and it gives a non-inclusive list of serious crimes. Examples of serious crimes, according to this list, are "murder, rape, armed robbery, kidnapping, abduction, state infrastructure sabotage, car-jacking, assault causing bodily harm, arson, destruction of property or theft with a value in excess of 500 U.S. dollars, or conspiracy or solicitation as an accomplice or attempting to commit one of these offenses."

⁵⁶CJTF-7 Staff, "Detention Summit Brief," Slide 8.

⁵⁷*Ibid.* The names of these leaders are in the notes page of this slide.

⁵⁸*Ibid.*

⁵⁹*Ibid.* In addition, Fragmentary Order 749 stated that, when possible, Criminal Detainees were to be turned over to local Iraqi jails. If a local jail were unavailable, a coalition detention facility could intern the detainee, and coalition forces would transport detainees to Iraqi courts as required. Coalition forces were required to honor Iraqi court release orders in cases involving Criminal Detainees. Thus, even if the initial judgment of the Detention Review Board as well as the six-month judgment of the Release Board deemed sufficient evidence existed to keep a specific Criminal Detainee interned, an Iraqi judge could overrule these coalition decision-makers and effect the detainee's release.

This was not, however, the case for alleged insurgents (that is, Security Internees). Once the Detention Review Authority deemed the initial evidence sufficient to keep a Security Internee interned, then this detainee would stay interned for at least six months (unless they successfully appealed their internment decision). This requirement for a periodic review every six months was required by Army Regulation 190-8, which in turn derived from Article 78, Geneva Convention IV. The exception to this six-month rule occurred when, as coalition holding facilities grew increasingly overcrowded, mass paroles of both Criminal Detainees and Security Internees took place. But even during such paroles, a Security Internee who was under "MI Hold" or who had "participated in attacks resulting in death or injury of a U.S., Coalition, or Fellow Iraqi member" was ineligible for parole (Khaghani, 1).

⁶⁰Most significantly, the creation of a 72-hour suspense for the Detention Review Authority to conduct detainee status reviews, which was not a requirement by law or doctrine, seemed to promise to reduce overcrowding at coalition detention facilities and to help mitigate the unintended long-term detention of innocents--the so-called "50 meters detainees" swept up in coalition raids for being in the wrong place at the wrong time.⁶⁰ Also, prior to Fragmentary Order 749's creation of review boards manned by senior CJTF-7 senior officers, junior legal officers had often single-handedly made the decisions to release suspected insurgents. The release of suspected insurgents upon the order of a single junior legal officer had frequently caused great consternation among CJTF-7's subordinate maneuver units, who, due to the rate they were starting to lose their soldiers to enemy action, were inclined to adopt a "better safe than sorry" perspective with regard to the long-term detention of alleged insurgents. The use of a board of senior CJTF-7 officers to make such decisions should have, in theory anyway, reduced the feeling among subordinate units that releases were being conducted without due consideration of the opinions and evidence collected by these units to support detainees' continued detention. In practice, however, the process was unwieldy and impractical since the designated senior officers had other duties to which they had to attend, and they could not review detainee packets all day every day, as their new duty required. By early November 2004, however, senior officers were permitted to delegate their responsibility for sitting on these boards to subordinate leaders, and Criminal Detainee and Security Internee boards were consolidated into one board in order to promote efficiency.

⁶¹Laurence Lessard, "Interview with LTC Paul Perrone," *Operational Leadership Experiences in the Global War on Terrorism*, March 28, 2007, <http://cgsc.cdmhost.com/cgi-bin/showfile.exe?CISOROOT=/p4013coll13&CISOPTR=813&filename=814.pdf> (accessed January 13, 2009), 8.

⁶²Federal Document Clearing House, Senate Armed Services Committee, "Hearing on Treatment of Iraqi Prisoners, May 19, 2008," 10.

⁶³Department of the Navy Inspector General, "Review," 245. According to the Church Report, Task Force EPW was an ad hoc force established due to the lack of combat-ready MP units when the invasion commenced. (The planners of Coalition Forces Land Component Command had decided to put MP units in the "tail" of forces

flowing into theater.) Task Force EPW consisted of the division's MP company and numerous medical, legal, and HUMINT assets.

⁶⁴Ibid., 242.

⁶⁵Ibid. According to Army doctrine at the time, detention camps or facilities consisted of "collecting points," "holding areas," and "Internment/Resettlement facilities." "Collecting points," which were normally operated by the MP companies attached to Army divisions, were further classified as forward or central collecting points. Forward collecting points were supposed to hold detainees no more than 12 hours, and central collecting points were allowed to hold detainees up to 24 hours. Holding areas, which were normally operated by the MP companies attached to Army corps, could hold up to 2,000 detainees. Internment/Resettlement facilities, normally operated by specially trained MP battalions, normally consisted of semi-permanent structures capable of holding up to 4,000 detainees (Church, 38).

⁶⁶Sabatino, "Annex 47," 4. On page 14 of their February 2004 Report, the ICRC lists the date that U.S. forces assumed administrative control of Camp Freddy as April 7, 2009. It is unclear which date is accurate.

⁶⁷205th MI Brigade, "Annex 40," Slide 4.

⁶⁸Department of the Navy Inspector General, "Review," 243.

⁶⁹205th MI Brigade, "Annex 40," Slide 4.

⁷⁰Ibid.

⁷¹Ibid.

⁷²Colonel Thomas Pappas, "Sworn Statement," 1.

⁷³Department of the Navy Inspector General, "Review," 249. Prior to the U.S. invasion, the U.S. State Department had classified the Mujahedin el-Khalq, which had been a Saddam-supported insurgent group dedicated to the overthrow of the Islamic Republic of Iran, as a terrorist organization. The Mujahedin el-Khalq was comprised of Iranians, and according to the authors of *On Point II*, the group had risen during Saddam's reign to become an elite force that had joined the Iraqi Army to fight invading coalition forces. Very little information has been declassified about operations at Camp Ashraf, probably due to the politically-sensitive fact that these detainees were Iranian citizens. The 530th MP Battalion ran Camp Ashraf, and in the Taguba Report, Major General Taguba lauded this battalion for its administration of this facility.

⁷⁴Colonel Robert Hipwell, "800th MP BDE Inaugural Jails/Justice/Jails Meeting with CPA 1000 hrs Thursday," *Email Forwarded to Author from V Corps Historian*, Camp Victory, Baghdad, July 3, 2003, 1.

⁷⁵Jones, 10.

⁷⁶ICRC, "Report of the International Committee of the Red Cross," 14.

⁷⁷Detainee Summit Briefing, Slide 36.

⁷⁸DAIG, "Detainee Operations Inspection," 71.

⁷⁹Ibid.

⁸⁰Ibid., 70.

⁸¹Ibid.

⁸²10th Military Police Detachment (CID). "CID Report of Investigation," *The Center for Public Integrity: The Abu Ghraib Supplementary Documents*, June 8, 2003, <http://www.publicintegrity.org/articles/entry/506/> (accessed January 12, 2009), 1.

⁸³Major Stacy Garrity, "Interview Conducted by Panel of Officers," *The Center for Public Integrity: Abu Ghraib Supplementary Document*, February 14, 2004, <http://www.publicintegrity.org/articles/entry/506/> (accessed January 12, 2009), 5.

⁸⁴10th Military Police Detachment (CID), "CID Report of Investigation," 3. The investigative summary lists ten names, six of which have been redacted, and states that there is "probable cause" that these "individuals committed the offenses of Aggravated Assault, Conspiracy, Cruelty and Maltreatment of EPW, Dereliction of Duty and False Swearing when they physically and verbally assaulted EPWs under their charge." The senior-ranking NCO on this list, a female master sergeant, had had two previous allegations of detainee abuse unsubstantiated against her. One of the two previous cases had been unsubstantiated because there had been no additional witnesses to the incident. All of these soldiers presumably transferred with their unit to Abu Ghraib when Abu Ghraib opened.

⁸⁵ICRC, "Report of the International Committee of the Red Cross," 14.

⁸⁶Department of the Navy Inspector General, "Review," 301-302.

⁸⁷Ibid., 302.

⁸⁸Ives, "Interview with MAJ Douglas Smith," 6.

⁸⁹Ibid.

⁹⁰Ibid., 7.

⁹¹John H. McCool, "Interview with LTC Wayne Sylvester," *Operational Leadership Experiences in the Global War on Terrorism*, October 10, 2005,

http://cgsc.cdmhost.com/cdm4/item_viewer.php?CISOROOT=/p4013coll13&CISOPTR=65&CISOBX=1&REC=2 (accessed January 10, 2009), 8.

⁹²Ibid., 8.

⁹³Ibid., 10.

⁹⁴John H. McCool, "Interview with CPT Amos Nelson," 7. According to CPT Nelson, the bus had been nicknamed "The Freedom Bus" by the first Iraqi prisoners released via this bus. This nickname was reinforced, Captain Nelson says, as Iraqi prisoners at Camp Cropper chanted frequently each day, "Freedom, freedom!"

⁹⁵Detainee Summit Briefing, Slide 33. In her sworn statement, Captain Wood actually provides a number of 200 for the maximum capacity for detainees at Camp Cropper. Other estimates of Camp Cropper's detainee capacity range from 200 to 450. The author selected the number of 450 because this estimate was the officially accepted estimate at the time, even if it was the most optimistic estimate the author read.

⁹⁶Sabatino, "Annex 47," 4.

⁹⁷Detainee Summit Briefing, Slide 33.

⁹⁸Ibid.

⁹⁹ICRC, "Report of the International Committee of the Red Cross," 15.

¹⁰⁰ Ibid.

¹⁰¹Ibid, 4.

¹⁰²Lieutenant Colonel Natalie Lee, "Army Regulation 15-6 Investigation into Alleged Mistreatment of EPWs and HVDs held at JIDC, Camp Cropper," *The Office of the Secretary of Defense and Joint Staff Reading Room*, January 23, 2004, http://www.dod.mil/pubs/foi/detainees/Lee_Report_release_dec07.pdf (accessed May 11, 2009), 24.

¹⁰³ICRC, "Report of the International Committee of the Red Cross, 15.

¹⁰⁴Lee, 14-17.

¹⁰⁵For a summary of some of these reports, see Endnote 81 to Chapter 3 above.

¹⁰⁶Department of the Navy Inspector General, "Review," 61.

¹⁰⁷Ibid.

¹⁰⁸Ibid.

¹⁰⁹Ibid.

¹¹⁰Ibid. Although the main Camp Cropper detention facility closed in September 2003, a new detention facility would be eventually built at Camp Cropper. In 2006, the Abu Ghraib site closed and all of its detainees moved to the newly constructed site at Camp Cropper. As of May 2009, all coalition detainees in Iraq are interned at two coalition detention facilities, Camp Cropper and Camp Bucca. Unfortunately, even though Camp Cropper and Camp Bucca have interned far more detainees than the relatively short-lived facility at Abu Ghraib, the facility at Abu Ghraib is the only corps holding area in Iraq of which the vast majority of Americans have heard.

¹¹¹ICRC, "Report of the International Committee of the Red Cross, 7.

¹¹²Ibid., 16.

¹¹³Ibid., 11.

¹¹⁴Captain Wood, "Sworn Statement," 8.

¹¹⁵Ibid.

¹¹⁶Ibid., 5.

¹¹⁷Ibid.

¹¹⁸DAIG, "Detainee Operations Inspection," 23.

¹¹⁹Detainee Summit Briefing, Slide 35.

¹²⁰DAIG, "Detainee Operations Inspection," 23.

¹²¹Captain Wood, "Sworn Statement," 6.

¹²²Department of the Navy Inspector General, "Review," 80.

¹²³ICRC, "Report of the International Committee of the Red Cross," 23.

¹²⁴Fay, 38.

¹²⁵Armed Forces Press Service, *Insurgents Attack Abu Ghraib Prison, Kill Detainee*, September 21, 2004, <http://www.defenselink.mil/news/newsarticle.aspx?id=25250> (accessed January 16, 2009).

¹²⁶ICRC, "Report of the International Committee of the Red Cross," 23.

¹²⁷DAIG, "Detainee Operations Inspection," 27.

¹²⁸Wright and Reese, 207.

¹²⁹Captain Wood, "Sworn Statement," 1, 5.

¹³⁰Fay, 119. Also, according to the Church Report, the Army's Criminal Investigative Division would ultimately substantiate the allegations of homicide in these two cases and recommend charges be filed against 15 soldiers (11 MP and 4 MI) for the December 4, 2002, case and against 17 soldiers (20 MP and seven MI) for the December 10, 2002, case (14-15). According to numerous news reports, both cases of detainee deaths at Bagram involved the two detainees being tethered to ceilings and beaten over the course of several days.

¹³¹*Ibid.*, 64.

¹³²Federal Document Clearing House, "Hearing on Treatment of Iraqi Prisoners," 24. Adding to the credibility of the ICRC's allegations regarding other detention facilities in Iraq (such as Camp Cropper) is the fact that nearly all of the types of detainee abuse the ICRC alleged was occurring at Abu Ghraib would actually be substantiated later by Army investigators. Within this context, it is unsurprising that the Schlesinger Report faulted CJTF-7 leadership for failing to heed the ICRC's allegations regarding Abu Ghraib (17).

¹³³Fay, 40. The 372nd MP Company arrived at Abu Ghraib on October 1, 2003.

¹³⁴*Ibid.*, 7.

¹³⁵*Ibid.*

¹³⁶Department of the Navy Inspector General, "Review," 82.

¹³⁷*Ibid.*, 258.

¹³⁸Major General Geoffrey Miller, "Assessment of DoD Counterterrorism Interrogation and Detention Operations in Iraq," *American Civil Liberties Union: Torture FOIA*, September 9, 2003, <http://www.aclu.org/torturefoia/released/a20.pdf> (accessed January 11, 2009), 2.

¹³⁹*Ibid.*

¹⁴⁰Although not identified as "SERE" techniques in the policy memorandum, some of the techniques approved on September 14, 2003, for Iraq match the SERE techniques described by the Senate Armed Services Committee in its "Inquiry into the Treatment of Detainees in U.S. Custody."

¹⁴¹CJTF-7 Headquarters, "Interrogation and Counter-Resistance Policy Memorandum, 14 September 2003," *American Civil Liberties Union: Torture FOIA*, <http://www.aclu.org/FilesPDFs/september%20sanchez%20memo.pdf> (accessed November 2, 2008), 4-5.

¹⁴²*Ibid.*, 4. The Fay/Jones Report notes that CJTF-7 Headquarters was using the outdated, 1987 version of FM 34-52 until at least June 9, 2004. The use of this rescinded

field manual caused the headquarters to wrongly incorporate the "Mutt and Jeff" technique, along with other errors, in the headquarters' September and October interrogation policy memoranda. It remains unclear why, with regard to the Mutt and Jeff technique, the September policy referred to the Third Geneva Convention for EPWs when it had already been established by Fragmentary Order 749, other CJTF-7 Fragmentary Orders, and the Geneva Conventions themselves that the Fourth Geneva Convention applied to Security Internees being interrogated in Iraq. This reference to the Third Geneva Convention seems to be just another example of an error within a policy memorandum which is riddled with errors and ambiguities and which must have been very hastily reviewed by the relevant staff sections of the CJTF-7 Headquarters--if reviewed at all.

¹⁴³CJTF-7 Headquarters, "Interrogation and Counter-Resistance Policy Memorandum, September 14, 2003," 1.

¹⁴⁴Ibid.

¹⁴⁵Department of the Navy Inspector General, "Review," 7.

¹⁴⁶Wright and Reese, 214.

¹⁴⁷Schlesinger, Brown, Fowler, and Horner, "Final Report of the Independent Panel," 12.

¹⁴⁸CJTF-7 Headquarters, "Interrogation and Counter-Resistance Policy Memorandum, October 12, 2003," *American Civil Liberties Union: Torture FOIA*, <http://www.aclu.org/FilesPDFs/october%20sanchez%20memo.pdf> (accessed December 12, 2008), 1.

¹⁴⁹Ibid., 2.

¹⁵⁰Captain Wood, "Sworn Statement," 3. When CJTF-7's October memorandum was published, Captain Wood said, it was explained to her by someone "from higher," that the September techniques were still permissible, they just needed Commanding General approval. Thus on the slide she posted at Abu Ghraib (Figure 6), she simply moved several interrogation techniques from the September memorandum to a column on the posted slide indicating techniques that needed the approval of the Commanding General to implement. The result was that the October memorandum applied few (if any) additional restrictions on how her interrogators did business: she simply continued to forward requests to use such SERE techniques as "sleep deprivation" and "use of military working dogs" to her boss, Colonel Pappas, whom she believed had been delegated the authority to approve the use of such techniques by Lieutenant General Sanchez.

¹⁵¹CJTF-7 Headquarters, "Interrogation and Counter-Resistance Policy Memorandum, October 12, 2003," 1.

¹⁵²CJTF-7 Headquarters, "Interrogation and Counter-Resistance Policy Memorandum, September 14, 2003," 4-5.

¹⁵³The earlier, outdated 1987 field manual had not intended to sanction the denial of basic necessities of food and clothing to interrogation sources, for such would have constituted clear violations of the Geneva Conventions. This outdated Army field manual did intend, however, to allow interrogators to use additional food, clothing, and other items--beyond the basic requirements directed by the Geneva Conventions--as incentives. Due perhaps to the potential for misunderstanding here, doctrine-writers had deleted this paragraph from the 1992 field manual.

¹⁵⁴Jones, 10. In addition to the Company A, 519 MI Battalion, personnel who had previously served in Afghanistan, there were six trainers from GTMO assisting and conducting interrogations at Abu Ghraib from October 4, 2003, to December 2, 2003, a period concurrent with the most significant instances at Abu Ghraib of detainee abuse. (Fay, 59)

¹⁵⁵CJTF-7 Headquarters, "Interrogation and Counter-Resistance Policy Memorandum, October 12, 2003," 3.

¹⁵⁶Colonel Warren, "Sworn Statement," 1. It is remotely possible that the ambiguity in the October memorandum was deliberate, thus enabling the "aggressive" interrogation techniques of the September memorandum to find their way via deliberate ambiguity into the October memorandum. To take such an approach--subtly refusing to execute the intent of a higher directive via deliberately ambiguous phrasing--would have certainly been within the capability of the bright CJTF-7 lawyers who drafted the October memorandum, and the motivation for doing so (which can be articulated as "U.S. Central Command is far away and does not understand what our soldiers are dealing with") may have existed. However, since Colonel Warren and other CJTF-7 lawyers have provided a satisfactory alternative explanation for this ambiguity and since none of the various investigators into the interrogation operations of CJTF-7 have discussed this possibility, one must assume that the mistakes made by the CJTF-7 lawyers who drafted the October memorandum were honest mistakes. Further supporting this assumption is the fact these CJTF-7 lawyers had possessed no experience with regard to drafting verbiage for interrogation approaches prior to CJTF-7's September and October policy memoranda. Thus, it is likely that the gross ambiguities in the CJTF-7 October policy memorandum--ambiguities that contributed to systemic, non-sexual, relatively minor abuse at Abu Ghraib and other detention facilities after October 2003--were simply the mistakes of inexperience on the part of CJTF-7's lawyers.

¹⁵⁷CJTF-7 Headquarters, "Interrogation and Counter-Resistance Policy Memorandum, October 12, 2003," 4.

¹⁵⁸Colonel Warren, "Sworn Statement," 1

¹⁵⁹ Fay, 10. According to the Fay, the arrival of military working dogs at Abu Ghraib had grown out of a recommendation made by Major General Miller's GTMO team to CJTF-7.

¹⁶⁰Eric Schmitt, *The New York Times: Pentagon Study Describes Abuse by Units in Iraq*, June 17, 2006, <http://www.nytimes.com/2006/06/17/washington/17formica.html?ex=1308196800&> (accessed February 17, 2009).

¹⁶¹Brigadier General Richard Formica, "CJTF-7 Interrogation Techniques as of 30 May 04," *The Office of the Secretary of Defense and Joint Staff Reading Room: Formica Report Annexes, Part I*. November 8, 2004, http://www.dod.mil/pubs/foi/detainees/formica_annexes_1.pdf (accessed February 2009, 17), 85.

¹⁶²Ibid.

¹⁶³Ibid.

¹⁶⁴Major Douglas A. Pryer, "Interview with CW3 Kenneth Kilbourne," *Operational Leadership Experiences in the Global War on Terrorism*, December 21, 2008, http://cgsc.cdmhost.com/cdm4/item_viewer.php?CISOROOT=/p4013coll13&CISOPTR=1440&CISOBOX=1&REC=2 (accessed March 31, 2009), 7.

¹⁶⁵Department of the Army Inspector General, "Detainee Operations Inspection," 35.

¹⁶⁶The Schlesinger Report, which is echoed in this conclusion by the Church Report, concludes that "There is no evidence of a policy of abuse promulgated by senior officials or military authorities." Despite these conclusions, whether such CJTF-7 techniques as "Presence of Military Working Dogs," "Sleep Management," and "Stress Positions" were humane, non-abusive, legal, and moral techniques during OIF I--even when properly implemented--remains a matter of public debate. However, it should also be noted that Lieutenant General Sanchez and his team of lawyers almost certainly did not intend for their CJTF-7 interrogation memoranda to be understood in the fashion these memoranda were understood by some interrogators (most dramatically at Abu Ghraib). This misunderstanding was due to ambiguity within the memoranda themselves as well as to CJTF-7's failure to adequately proscribe training for interrogators on new techniques. Thus, CJTF-7's lack of clarity regarding what actions new interrogation techniques actually permitted and CJTF-7's failure to adequately direct training for interrogators on new techniques are perhaps CJTF-7's most significant failures with regard to interrogation operations.

CHAPTER 5

OLD IRONSIDES

As you've heard me say before, we must remember who we are. Our example is what will cause us to prevail in this environment, not our weapons. I really believe that. We need to show the Iraqi people what "right" looks like. They must see the difference between us and the former regime. . . . Please reinforce this with your troopers. They will hear this debate. Try to help them not to be confused by it.¹

— Major General Martin Dempsey,
1AD Commander

Whether or not mock executions, naked pyramids, beatings, and other forms of abuse succeed in extracting information, such behavior often slides down a slippery slope to more severe forms of mistreatment, perhaps leading eventually to injury and death. Prisoner abuse degrades the abuser as well as the abused; as Americans we should stay on a higher moral plane. . . . We had to remain constantly vigilant in this regard, lest we lose our soul in the name of mission accomplishment.²

— Colonel Peter Mansoor,
1st Brigade Combat Team, 1AD, Commander

Prior to its deployment to Iraq, the bulk of the 1st Armored Division ("Old Ironsides")³ was situated amidst the hilly vineyards, broad rivers, and solitary castles of Germany's wine country. The headquarters for the division was located on Wiesbaden Army Airfield, about one mile from the Rhine River and an hour's drive west of Frankfurt. The division's 1st Brigade, an armored brigade, was stationed a 45 minute drive north of Wiesbaden in the town of Friedberg; its 2nd Brigade, a mechanized infantry brigade, was located about an hour and a half west of Wiesbaden and an hour east of the French border in the town of Baumholder; and its 4th Brigade, an aviation brigade, was stationed in Hanau (just a few minutes from Friedberg).⁴ The division's 3rd Brigade, another armored brigade, was across the Atlantic in Fort Riley, Kansas.

The Road to Stability Operations

For the last half of 2002, the leaders and soldiers of the 1AD planned and trained as if they would take part in the invasion of Iraq. In fact, the 1AD was part of the V Corps' invasion plan for Iraq until February 7, 2003, just two months before the 1AD began deploying from Germany to Kuwait.⁵ This late change-of-mission from an invasion force to a stabilizing force did not affect all of the division since a substantial portion of the 3rd Brigade began deploying to Iraq on February 20, 2003 and still took part in the invasion.⁶ But it did mean that the bulk of the 1AD's units (including nearly all of the 1AD's units in Germany) had focused their training on the wrong type of operations--offensive conventional operations rather than stability operations.

The 501st MI Battalion, which was stationed across the Rhine River from the 1AD Headquarters amidst the orchards of Wackernheim, was 1AD's organic intelligence battalion. This battalion was responsible for all of the 1AD's HUMINT support during OIF I. Like the rest of the 1AD, the 501st MI Battalion spent 2002 and the first part of 2003 training for the wrong fight. With regard to interrogation operations, the battalion thought much of its time in Iraq would be spent screening (that is, quickly processing, separating, and sending to V Corps) large numbers of EPWs.⁷ The battalion did not cross-train all of its counterintelligence soldiers as interrogators since the assumption was that there would be no counter-insurgency fight and, after the initial mass screenings of EPWs were complete, there would be sufficient interrogators on-hand to accomplish any residual interrogation mission.⁸ The battalion's training in Germany and Kuwait included extensive Law of War and Rules of Engagement training, convoy reaction drills, convoy

live fire training, first aid training, and training on tasks specific to conventional operations.⁹

The 1AD assembled in Baghdad from May 16-23, 2003,¹⁰ and on May 29, 2003, the 1AD with attachments assumed military responsibility for Baghdad as "TF Baghdad."¹¹ Once it assumed this responsibility, the 1AD did not relinquish it until 1AD's transition of authority with the 1st Cavalry Division, its OIF II replacement, on April 15, 2004.¹² Throughout OIF I, the 1AD exercised military control of Baghdad with six maneuver brigades. In addition to the 1AD's four organic brigades, the 2nd Light Cavalry Regiment (2LCR) was attached to the 1AD throughout OIF I.¹³ The humvee-mounted 2LCR was responsible for eastern Baghdad (to include the large, overcrowded slum of Sadr City).¹⁴ Initially, the 2nd Brigade of the 82nd Airborne Division was also attached to the 1AD. This airborne brigade was responsible for southern Baghdad until it was relieved in place by the 1st Armored Division Artillery on January 23, 2004.¹⁵ Also, it is worth noting here that 1AD's 3rd Brigade relinquished control of northwestern Baghdad relatively early (February 12, 2004) to the 2nd Brigade of the 1st Cavalry Division.¹⁶

Major General Sanchez commanded the 1AD when it deployed to Iraq. On June 15, 2003, Sanchez (now as a Lieutenant General) assumed command of CJTF-7, leaving command of the 1AD to the 1AD's Assistant Deputy Commander-Maneuver, Major General Fred Robinson.¹⁷ On July 17, 2003, Brigadier General Martin Dempsey assumed command of the 1AD, a responsibility he would have for the next two years. Soon after assuming command, General Dempsey ordered that the division task force be called "Task Force 1st Armored Division" (TF 1AD) rather than Task Force Baghdad.¹⁸

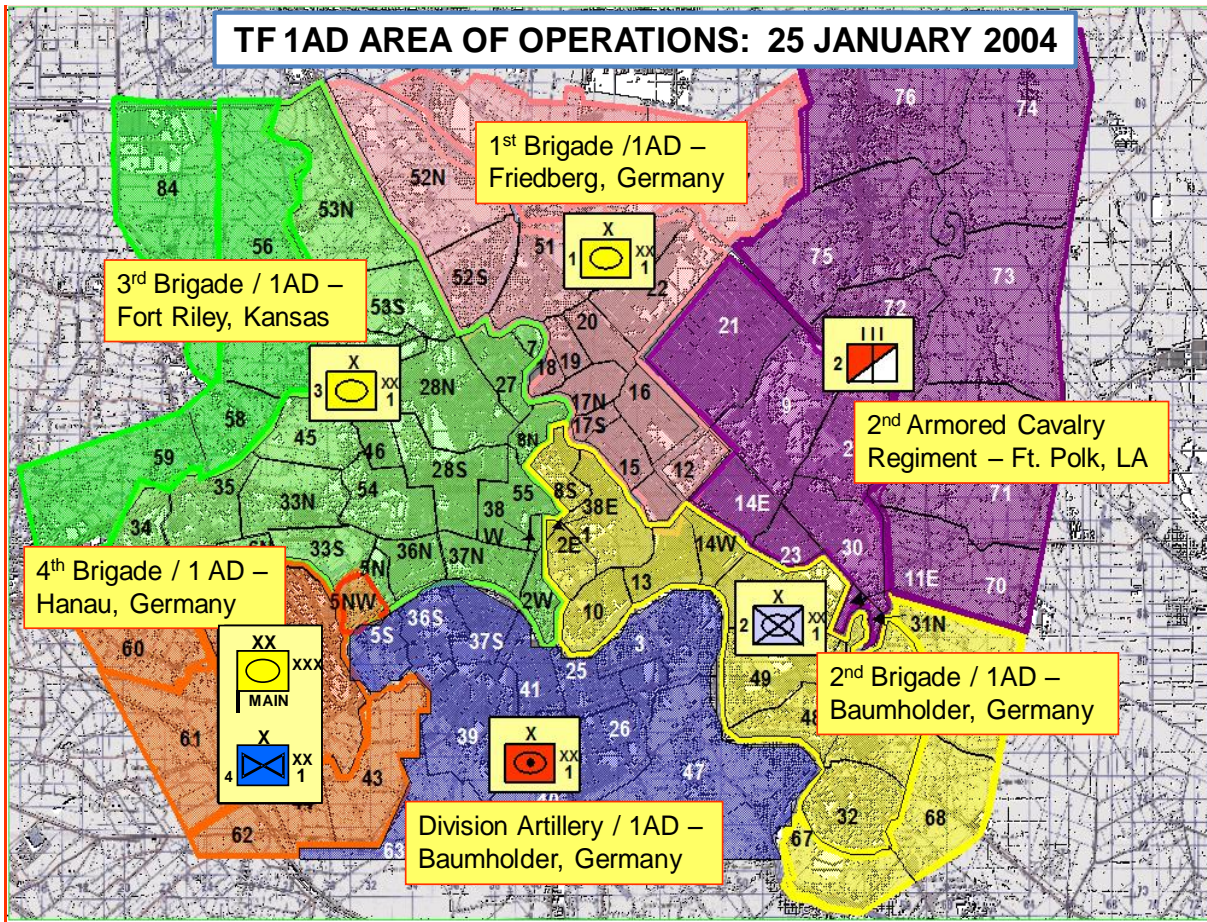

Figure 7. TF 1AD Area of Operations

Source: Headquarters, Task Force 1st Armored Division. Briefing: *TF 1AD Says Thanks to the United States*. Baghdad, July 2004, Slide 6.

During OIF I, TF 1AD was not only the largest division-based task force in Iraq, it was the largest division-based task force in U.S. Army history.¹⁹ In addition to the 2LCR and the 2nd Brigade of the 82nd Airborne Division, other large units attached to TF 1AD at various times included the 18th and 89th MP brigades, the 493rd Engineer Group, seven engineer battalions, the 55th Personnel Service Battalion, the 8th Finance Battalion, the 350th and 354th Civil Affairs Battalions, the 415th and 345th Psychological Operations Battalions, and the 16th Corps Support Group.²⁰ At its largest,

TF 1AD included more than 39,000 soldiers--slightly more than twice the number of soldiers in an ordinary division and one-fourth of CJTF-7's total strength.²¹

Seizing the Moral High Ground

Considering the scale and timeframe of its operations in Iraq, it is significant that TF 1AD did not have a single substantiated case of school-trained interrogators abusing detainees. In fact, from declassified written records and verbal testimonies, it appears that the division never even received an allegation of abuse concerning school-trained interrogators--at least not an allegation that anyone deemed serious enough to formally investigate.²² It also appears that, while one brigade did request a SERE interrogation technique on one occasion, the use of this technique was disapproved (probably by division-level MI personnel) and the division's school-trained interrogators never actually employed a SERE interrogation technique.²³ Also, according to various verbal testimonies,²⁴ all TF 1AD detention facilities passed numerous ICRC inspections with no major deficiencies and no allegations of detainee abuse. Corroborating this testimony is the fact that, while the February 2004 ICRC report listed five detention facilities in Iraq with serious detainee abuse problems and several other facilities with less serious abuse problems, this report did not mention any TF 1AD facility in this report.²⁵ Additionally, a 2006 Human Rights Watch report on interrogation abuse during OIF I was similarly mute regarding TF 1AD's interrogation operations.²⁶

The only questionable practice some TF 1AD interrogators and detention personnel employed was the use of stress positions and exercise to control unruly detainees.²⁷ Although MP doctrine at the time prohibited "physical activity or body positions designed to place undue stress on a prisoner,"²⁸ it is unclear that the type of

light physical activity and body positions employed by some units in the division to regain control of unruly detainees constituted "undue" stress. MI doctrine, DoD directives, Army regulations, and U.S. national law did not specifically address the practice. With regard to international law, Article 31 of the 4th Geneva Convention did prohibit physical coercion for the purpose of obtaining information, but it did not prohibit physical coercion for the purpose of regaining control of a detainee or modifying his bad behavior.²⁹ More to the point, Article 100 of the 4th Geneva Convention prohibited detention personnel from making detainees perform physical exertion that was dangerous to their health or involved "physical victimization."³⁰ In addition, it specifically prohibited "prolonged standing" and "punishment drill."³¹ However, whether these prohibitions were applicable to stress positions (other than prolonged standing) that were temporary and only mildly discomforting and whether this prohibition applied to such forms of light exercise as jumping jacks was open to interpretation. Despite the lack of legal and doctrinal clarity on the issue, it appears that only a minority of TF 1AD's holding areas used stress positions and exercise to control detainees, and of these, most (if not all) did so only briefly.

In all other areas, the 1AD's school-trained HUMINT interrogators clearly stayed on "the moral high ground," particularly with regard to their refraining from the use of SERE interrogation techniques. So, a key question is as follows: how did 1AD's interrogators steer clear of the controversy that eventually surrounded CJTF-7's approval and use of harsh interrogation techniques?

The answer starts with TF 1AD's command climate. Throughout his command, Major General Dempsey made it clear that he expected Iraqis to be treated with dignity

and respect. In fact, just four days after Dempsey took command, the TF 1AD Headquarters published Fragmentary Order 383A [General Order - Civilian or Detainee Maltreatment] to Operations Order 03-215 (Iron Stability), a general order that criminalized an extensive list of potentially abusive behaviors of Iraqis by 1AD soldiers.³² This general order applied to all TF 1AD soldiers (including interrogators), and it specifically stated that detainees undergoing "questioning" or "interrogation" would not be maltreated.³³ Dempsey's general order went on to define "maltreatment" as "an act or actionable omission, which results in physical pain or mental anguish to a person without justifiable cause."³⁴ This order also specifically forbade specific types of maltreatment, to include some of the behavior exhibited by "actor interrogators" at SERE schools. For example, Dempsey specifically prohibited such maltreatment as the "hitting" of detainees, "using abusive language" on detainees, and "causing mental oppression" of detainees.³⁵

Additionally, Dempsey frequently reinforced this general order with multiple verbal and written orders to his subordinates.³⁶ Consequently, the commanders of TF 1AD's maneuver brigades--who probably did not need to be persuaded of the importance of treating detainees well--made the humane treatment of Iraqi detainees one of their priorities.

Nonetheless, despite a command climate that clearly and consistently reinforced the message that detainees should be treated humanely, there were still instances of substantiated detainee abuse in TF 1AD. Most of these abuses took place at the point of capture, when emotions ran high and soldiers failed to rapidly adjust from fighting enemy combatants to treating these same enemy combatants humanely. However, a few cases of

substantiated abuse did take place at TF 1AD holding areas, and what is more, a few of these cases involved abusive interrogations. The TF 1AD soldiers, though, who abused detainees during interrogations, were non-HUMINT soldiers conducting interrogations that they had never been authorized to conduct. Thus, what is truly distinctive about TF 1AD with regard to detainee abuse is that there is no record of the use of a SERE interrogation technique by school-trained TF 1AD interrogators or of school-trained interrogators being formally accused of detainee abuse.

So, how did TF 1AD's school-trained interrogators manage to "stay on the moral high ground?" We must dig deeper.

Out Front!

The motto of the 501st MI Battalion, which inactivated in 2007, was "Out Front!" Certainly, the battalion's leadership intended their unit to "lead from the front" ethically.³⁷

The unit's battalion commander during the unit's preparation to deploy and initial deployment was Lieutenant Colonel Kenneth Devan. Major Elizabeth Rogers was the unit's operations officer during the same time period. Six weeks after the unit arrived in Baghdad, Devan became the division's senior intelligence officer, the 1AD G2, and Lieutenant Colonel Laurence Mixon assumed command of the 501st MI Battalion.³⁸ One week later, Rogers became the 1AD Deputy G2, and Major Nathan Hoepner moved from the TF 1AD G2 Shop to become the 501st MI Battalion operations officer.

Both Mixon and Hoepner played pivotal roles in ensuring the 501st MI Battalion's interrogators did not abuse detainees. Their strong ethical stands were especially critical during late-Summer and early-Fall 2003 when SERE-interrogation techniques were officially promulgated in CJTF-7's interrogation policy memoranda. Hoepner's response

to a CJTF-7 captain who had said that the CJTF-7's Deputy CJ2 had decided that the "gloves are coming off regarding these detainees" is recorded at the start of this study. Yet, Mixon was just as insistent that his soldiers stay on the moral high ground, and since he was the commander, he exercised more influence than his operations officer in this regard. Captain Nicole Lauenstein, who served as the battalion's HUMINT Operations Cell Chief and then as a platoon leader in the battalion, said:

I think it [the 501st MI Battalion] was very successful [at staying on the moral high ground], mostly because our Battalion Commander, LTC [Lieutenant Colonel] Mixon, expected the highest moral standards from all of his officers and Soldiers. You were allowed to make mistakes, but moral violations were not acceptable. Also, we had very experienced HUMINT Warrant Officers at the company level where the HUMINT operations were being conducted, guiding less-experienced Soldiers and advising OMTs. I think the combination of both of these elements led to our success. . . . I think if we had had less experienced warrant officers at the company level, 501st MI Battalion could have succumbed to the mistakes of other units.³⁹

Captain Lauenstein's point about the importance of first-line supervisors (warrant officers) in preventing detainee abuse is an extremely important point. For all or most of OIF I, CW2 Kenneth Kilbourne, CW2 Joel Giefer, and WO1 John Groseclose were the senior Operational Management Technicians (OMTs) for the HUMINT sections of Company A, Company B, and Company C respectively. All three officers were uniformly consistent in insisting that their intelligence personnel operate within the moral parameters outlined by Army doctrine, national law, and the Geneva Conventions. They also served as a sounding board and support group for each other when, as occasionally happened, they were compelled to tell a military leader senior to them that neither they nor their soldiers could perform a certain mission in a certain way. Groseclose said:

You know, it doesn't matter which theater you go into, or which rotation that you're on, when you have commanders out there that are losing soldiers, or their soldiers are getting wounded, they're going to pressure you to get more

information. They want to know who is doing it; they want to make it stop. So, yes, there were times when we were under pressure to get more information or to do interrogations a certain way that they thought would be more productive. It really is up to interrogators to explain to them why we don't do those things. But, we didn't face undue pressure. The topic did come up on occasion, and I would just sit down with a commander and talk to them, and we'd talk through it. I'd say, first of all, that is not what we're going to do, and this is why we're not going to do it. There are better ways of doing things.⁴⁰

When asked why neither she nor any of her interrogators ever used harsh interrogation techniques, Sergeant Amanda Meyer, a Company A, 501st MI Battalion, interrogator, cited the lack of time available to receive approval for such requests, since they were only allowed to hold detainees for up to 72 hours.⁴¹ But above all other influences, Sergeant Meyer cited the importance of her warrant officers' mentorship, saying, "Our warrants also taught us to work within the laws and system and emphasized the fact that there was no need for us to utilize these techniques."⁴²

An MI Community Takes Charge

One week after CJTF-7 published what would be its baseline mission order governing detention operations for the rest of OIF I, TF 1AD published TF 1AD Fragmentary Order 539A. Major Hoepner and Luis Guzman, a G2 planner and contract employee, wrote this August 30, 2003, Fragmentary Order.⁴³ Among many other directives, this Fragmentary Order tasked subordinate units to input detainee data into an All Source Analysis System-Light (ASAS-L) database.⁴⁴ (The ASAS-L was a Panasonic toughbook computer with common software that was owned by intelligence shops throughout TF 1AD.)

Unwritten but apparent in this directive was the fact that TF 1AD's MI community, the owners of the ASAS-L, had become the managers of TF 1AD's detainee

population. This assumption of a doctrinally MP mission by MI units and sections was due to necessity: while each detention facility had an associated MI unit or section, MP units were too busy recruiting, training, and supporting Baghdad's new police force to support (let alone run) all of the division's detention facilities.

Fragmentary Order 539A directed TF 1AD's subordinate units to either release or move detainees to a higher detention facility (either Abu Ghraib or, in the case of "division targets," the TF 1AD's Division Interrogation Facility) within 72 hours of apprehension.⁴⁵ It also directed TF 1AD's Division Interrogation Facility (DIF) to hold detainees for only 96 hours.⁴⁶ Brigadier General Dempsey reserved for himself the authority to have a detainee transferred to the DIF or, once at the DIF, released or transferred to Abu Ghraib.

Dempsey's decision-making process with regard to DIF operations worked as follows: Hoepner briefed Dempsey each morning on the status of "Detainees of Intelligence Interest" (suspected insurgents, or whom CJTF-7 called "Security Internees").⁴⁷ This brief included highlights from Summary Interrogation Reports as well as recommended dispositions for specific detainees.⁴⁸ If a Security Internee were being held at a brigade or regimental holding area, the 501st MI Battalion S3 Section would pass on Dempsey's disposition guidance (that is, whether to take the detainee to Abu Ghraib or to the DIF) to the appropriate brigade or regimental S2 section.⁴⁹ Also, before recommending the release or transfer of a detainee from the DIF, the 501st MI Battalion Tactical Operations Center would build a "disposition packet" for this detainee.⁵⁰ This packet would then be staffed through the responsible brigade or regimental commander, the TF 1AD G2, the 501st MI Battalion Commander, and the TF 1AD Staff Judge

Advocate, who would each recommend either releasing the detainee, transferring the detainee to Abu Ghraib, or transferring the detainee to Abu Ghraib as an "Intel Hold."⁵¹ Dempsey would then make the final decision on a detainee's disposition based on his subordinate leaders' recommendations.⁵²

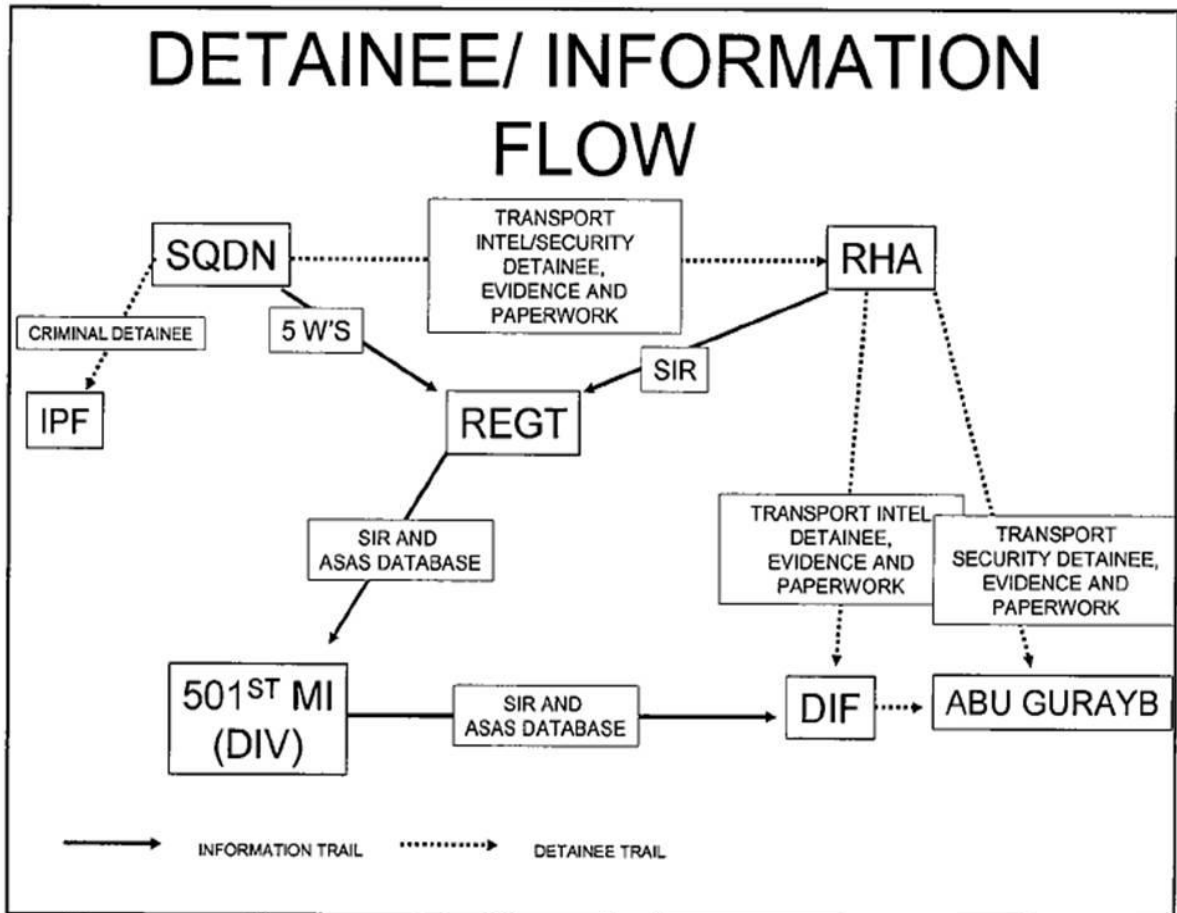

Figure 8. 1AD Detainee/Information Flow

Source: Headquarters, 2nd Light Cavalry Regiment, "SEP 03 PPT Briefing/ Laydown of Division Detention Operations," *American Civil Liberties Union: Torture FOIA*, September 2003, <http://www.aclu.org/projects/foiasearch/pdf/DOD043598.pdf> (accessed April 1, 2009), 4.

The TF 1AD DIF

The TF 1AD DIF was established at the Baghdad International Airport during the same time period (late July 2003) that the Abu Ghraib detention facility was activated and for the same reason--to support the large influx of detainees expected as a result of Operation Victory Bounty.⁵³ The 501st MI Battalion was neither designed nor trained to run a detention facility; nonetheless, it would perform this task admirably.

TF 1AD engineers did most of the initial construction of the DIF. The headquarters company of 501st MI Battalion locally contracted any work that the division's engineers could not complete.⁵⁴ Altogether, construction on the facility took one to two months to complete.⁵⁵ When finished, the facility had portable latrines, a portable shower, hand washing and shaving facilities.⁵⁶ It also had an inner and outer fence comprised of concertina wire, two guard towers, four cells each able to hold up to 10 detainees, and four interrogation booths.⁵⁷

The headquarters company of 501st MI Battalion provided logistical support to the facility. This support included a water truck, toiletries, towels, meals-ready-to-eat, and eventually, uniforms.⁵⁸ Medical support initially came from the 47th Forward Support Battalion of TF 1AD's 2nd Brigade, but this mission eventually transitioned to a medical company that happened to be stationed across the street from the DIF.⁵⁹

An MP platoon from the 18th MP Brigade, which was "operationally controlled" by TF 1AD, initially guarded the DIF.⁶⁰ Eventually, this platoon was replaced by a platoon from 1AD's organic 501st MP Company, which had a strength of 18 MPs.⁶¹ Although 501st MI Battalion operationally controlled these two MP platoons, the rating chains for the leaders of these two platoons remained within their respective MP

companies. Furthermore, the company leadership of these platoons would visit their soldiers at the DIF on an almost daily basis, which helped to maintain separation between the DIF's security forces (MPs) and the DIF's interrogators (MI personnel).⁶² "MPs had no role in the interrogation process," Hoepner said.⁶³

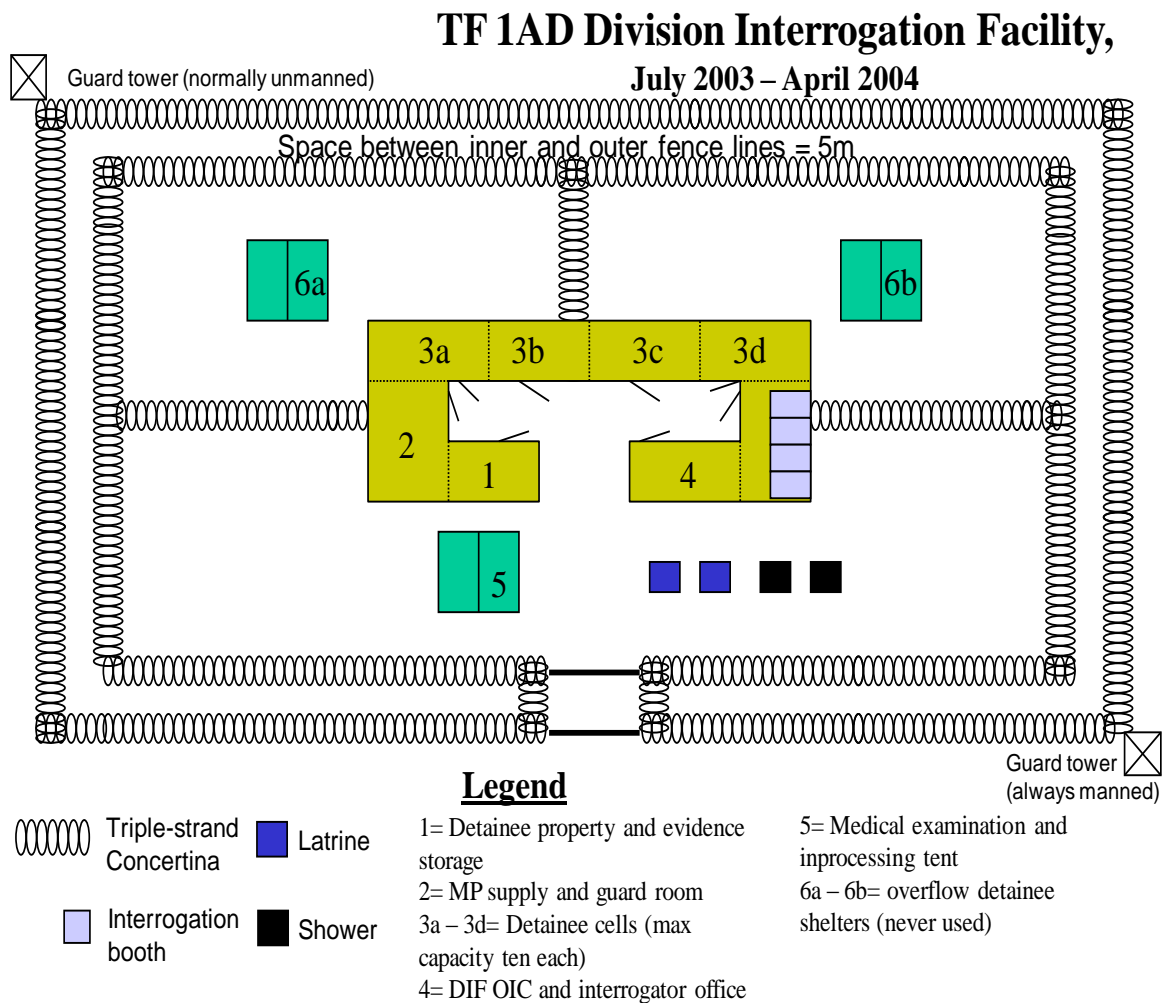

Figure 9. TF 1AD Division Interrogation Facility

Source. Major Douglas A. Pryer, "Interview with LTC Nathan Hoepner," *Operational Leadership Experiences in the Global War on Terrorism*, February 2, 2009, http://cgsc.cdmhost.com/cdm4/item_viewer.php?CISOROOT=/p4013coll13&CISOPTR=1441&CISOBX=1&REC=6 (accessed March 5, 2009), 7.

During TF 1AD's 15 month-long deployment, its DIF would incur not a single allegation of serious detainee abuse.⁶⁴ Declassified documents and interviews indicate that there were only three instances of abuse at the facility, and all three of these instances were fairly minor: there were two cases of MPs counseled for yelling at detainees and one instance of a contract interrogator who was fired for yelling at and threatening a detainee.⁶⁵

In addition to the absence of serious detainee abuse, there were none of the indicators of abuse at the TF 1AD DIF that were occurring at a few other detention facilities in Iraq. There was not, for example, a single riot, detainee shooting, detainee death, or escape attempt at the facility.⁶⁶ The fact that there were no serious allegations of abuse or even indicators of abuse held true even after TF 1AD was extended into OIF II for an additional three months and DIF operations moved to a new compound.⁶⁷ Also, the facility passed all ICRC inspections with no significant deficiencies or allegations of detainee abuse noted.⁶⁸ Thus, it is perhaps no wonder then that, when Colonel Stuart Herrington (a retired MI officer and one of America's foremost experts on interrogation operations) inspected CJTF-7 interrogation operations in December 2003, he singled out TF 1AD's detention facility as "organized, clean, well-run, and impressive."⁶⁹

MI Shortfalls

The 501st MI Battalion had been organized for high-intensity mechanized warfare, not counterinsurgency operations. Thus, the DIF had serious manning shortages, to include shortages in all MI-related areas--interrogation, interpretation, and analysis.

The number of interrogators at the DIF never exceeded six, and this number was only reached briefly. The DIF's first team of interrogators was four junior interrogators provided by CJTF-7.⁷⁰ When this team of reservists redeployed home, the battalion was forced to reassign junior interrogators from its direct-support companies to the DIF, which was hardly a popular move with the brigades to which these highly valued Soldiers had been attached.⁷¹ At this point, there was still no experienced warrant officer to guide the DIF's interrogators. Early in 2004, the battalion received six experienced contract civilian interrogators for the DIF (which became five contract interrogators when one of them was fired), though the DIF still lacked an experienced warrant officer and would not have a warrant officer until it moved to another compound in April 2004.⁷²

The DIF had four contract linguists who served as interpreters for interrogations and translators for the DIF's "document exploitation cell."⁷³ Additionally, there was no analytical support at the DIF until the 501st MI Battalion was able to assign two intelligence analysts (one military and one civilian analyst) to the facility midway through the deployment.⁷⁴ The net result of the DIF's manning shortfalls was that the facility did not operate as effectively as it could have operated.

Yet, a shortfall in the quantity and experience of MI personnel was not confined to the DIF: the problem was endemic to interrogation operations across TF 1AD. Incredibly, the 501st MI Battalion--the unit responsible for providing HUMINT support to a division with responsibility for securing a city with five million Iraqis--was authorized a sum total of just nine interrogators. These nine interrogators consisted of three sections of three interrogators--one chief warrant officer 2, one E-5 sergeant, and one E-4 specialist. Each section was assigned to an MI company in direct support of a

brigade. In addition to 501st MI Battalion's nine interrogators, the maneuver brigades attached to TF 1AD were each authorized three interrogators as well. Also, for much of OIF I, TF 1AD received 4-6 interrogators from CJTF-7 to support the TF 1AD DIF. Thus, if TF 1AD's interrogation sections had been at full strength, TF 1AD would have had a total of 19-21 interrogators.

Unfortunately, TF 1AD's interrogation sections were never at full strength. For example, although Company B, 501st MI Battalion was authorized an interrogation section with one warrant officer 2, one E-5, and one E-4, it actually had on-hand only two E-4 interrogators. Other interrogation sections periodically faced similar shortages. Thus, in reality, TF 1AD had approximately 15-18 school-trained interrogators at any one time. This number, of course, was not nearly sufficient to support counterinsurgency interrogations in a huge and violent city, support that included conducting tens of thousands of screenings of Iraqi applicants for positions in the nascent Iraqi security forces).

Considering this dramatic shortage of interrogators, it is no wonder that counterintelligence specialists were sometimes tasked by their warrant officer supervisors to conduct interrogations. Though not prohibited by Army regulations, this practice was frowned upon by Army doctrine because 97B counterintelligence specialists--although skillful at detecting deception and screening individuals--had never been school-trained to interrogate. The division's school-trained interrogators were unhappy with this situation, but they realized they sometimes had no choice but to ask counterintelligence specialists to interrogate. Said CW3 Groseclose:

There was a couple times we did that [used counterintelligence specialists as interrogators] because we didn't have anyone else available. . . . I didn't like to use my CI folks for interrogations because they had a hard time doing it. If a detainee was cooperative, they were very good at giving the detainee follow-up questions to get the information we were looking for. On the other hand, if a detainee was uncooperative and they needed to use approaches, they didn't have the training, and they just didn't do very well at it.⁷⁵

This practice was even more prevalent in MI units (such as Companies A and B of the 501st MI Battalion) that did not have all three of their assigned interrogators.

There was not just a shortage of interrogators in TF 1AD; this shortage existed across all of Iraq. Thus, it is unsurprising that the majority of interrogation abuse which occurred during OIF I was not committed by school-trained interrogators. Such abuse normally took place either at the "point of capture" or in temporary battalion holding facilities. In such cases, angry and frustrated troops would resort to interrogating Iraqis themselves in an attempt to immediately acquire desperately needed intelligence.

The Church Report identified 16 substantiated cases of interrogation abuse in Iraq before September 30, 2004.⁷⁶ (Several high-profile cases were not yet complete and thus were not listed in this report.) Of these 16 cases, six cases involved school-trained interrogators and 10 cases involved harsh, unauthorized questioning by non-interrogators.⁷⁷ Although none of the cases of school-trained interrogators involved TF 1AD, half of the cases of abuse involving non-interrogators belonged to TF 1AD. These five substantiated cases as written in the Church Report were as follows:

On June 21, 2003, a Quick Reaction Force assigned to 4th Battalion, 1st Field Artillery [3rd Brigade] responded to reports of sniper fire from the Iraq Museum of Military History in Baghdad. An Iraqi civilian was taken into custody as a suspect. . . . A private first class approached the detainee . . . struck the detainee in the face, making his nose bleed. . . . Later, a staff sergeant allegedly pointed his M-16 at the detainee's head and then charged it. . . . It was later determined that the detainee, who was subsequently released, had been hired by the U.S. Army to guard the museum.⁷⁸

On August 31, 2003, a specialist from the 1st Battalion, 36th Infantry [1st Brigade], threatened two Iraqi detainees during questioning in a building near Baghdad. . . . In separate interrogations, the SPC handed one detainee a bullet and told him that the round would kill him if he did not talk. . . . Within hearing distance of the detainee but out of his field of vision, the SPC simulated charging an empty weapon to lead the detainee to believe the weapon was loaded.⁷⁹

On September 1, 2003, three detainees were seized near a mosque in Baghdad, their hands were zip-cuffed behind their backs, and they were taken to a nearby Ammunition Collection Point (ACP) operated by the 2nd Battalion, 6th Infantry Regiment [2nd Brigade]. They matched the description of individuals who were seen earlier in the vicinity of the ACP perimeter with weapons . . . [a] SFC asked one detainee if he was there to bomb the base or shoot soldiers, and slapped a detainee during questioning for not telling the truth. As instructed by the SFC, three SSGs alternated in kicking, tripping, and shoving the detainees . . . The detainees claimed they were security guards for the local mosque and were eventually released to a cleric from the mosque.⁸⁰

On October 1, 2003, near the perimeter of the Baghdad International Airport (BIAP), soldiers assigned to A Battery, 1st Battalion, 4th Air Defense Artillery [DIVARTY], apprehended nine detainees suspected of trespassing through a hole in BIAP's southern wall and stealing metal pipe. A captain interrogated the zip-tied detainees at gunpoint and fired his pistol approximately six times to deflate the tires of the tractor the detainees had been riding when caught.⁸¹

On October 14, 2003, at a temporary holding facility in Al Ademiya, a detainee was questioned about his knowledge of plans to attack a U.S. convoy. . . . Two SGTs from the 32nd Military Police Company [519th MP Battalion, 18th MP Brigade] took the detainee to the Al Ademiya police station. . . . [A] SGT held a pistol to the detainee's head and threatened him during questioning.⁸²

To prevent interrogation abuse, it is clearly not enough to ensure school-trained interrogators adhere to the high ground. The U.S. Army also needs to ensure that, one, non-interrogators understand that they cannot interrogate prisoners themselves, and that, two, units go to war with enough interrogators to reduce the temptation of other troops to conduct their own interrogations.

The shortage of MI personnel was also keenly felt in the area of interrogator management. During OIF I, for example, the 501st MI Battalion did not have an organic HUMINT Operations Cell (HOC). According to current Army doctrine, a HOC is

"assigned under the J/G2X to track all HUMINT activities."⁸³ Among other duties, a HOC "deconflicts HUMINT collection operations," "establishes and maintains a consolidated HUMINT source database," "manages requirements and taskings for HUMINT collectors," and "expedites preparation of intelligence reports and their distribution to consumers at all levels."⁸⁴ During OIF I, however, a HOC was new doctrine that the 501st MI Battalion's manning authorization document did not reflect. As a result, the 501st MI Battalion was forced to stand up a HOC during OIF I that, frequently, was manned by personnel with no HUMINT experience whatsoever. Near the beginning of the deployment, for example, the two-man HOC consisted of a first lieutenant and a 96R (ground surveillance radar specialist) master sergeant--neither of whom had any HUMINT knowledge or experience.⁸⁵

Since the HOC was undermanned and inexperienced, the 501st MI Battalion S-3 Section (whose members also had little HUMINT experience) assumed many of the tasks that would eventually become doctrinal HOC tasks. For example, the S3 Section tracked and tasked HUMINT assets, distributed the DIF's document exploitation report and DIF interrogation summary, and provided interrogation priorities and lines of questioning to the DIF. For much of the deployment, the HOC performed little more than administrative tasks--proofreading Critical Intelligence Information Reports and Summary Interrogation Reports submitted by Company HUMINT sections, rolling up these daily reports into a single report for distribution to intelligence sections across TF 1AD (and adjacent units as needed), compiling the division's source database, and compiling and submitting a daily report of the significant activities of HUMINT teams to CJTF-7. Although the HOC would eventually assume a greater share of its doctrinal

Key Conclusions

The TF 1AD DIF shared the same tactical problem faced by all interrogation facilities in Iraq during OIF I. This tactical problem can be defined as follows: "how do we interrogate effectively, when casualties are mounting, higher interrogation policy is permissive, manning is dramatically inadequate, and our interrogators are young and inexperienced?" The leaders at a few interrogation facilities believed that, in order to save lives, the use of harsh interrogation methods were needed. Unfortunately, the facilities that allowed such techniques (such as Abu Ghraib) unerringly developed cases of serious detainee abuse.

All of TF 1AD's school-trained interrogators adhered to doctrinal interrogation techniques and incurred zero allegations of serious detainee abuse. Thus, no TF 1AD interrogators received UCMJ punishment or jail time for detainee abuse. Also of great strategic importance, TF 1AD's interrogators stayed out of the news.

Why were TF 1AD's school-trained interrogators more strategically effective than interrogators in a few other facilities during OIF I? The answer comes down to the quality of the interrogators' ethical leadership. Simply put, there was no leader in the chain-of-command of any 1AD interrogator, from the commanding general to warrant officer supervisors, who prized the acquisition of short-term intelligence at the cost of, as Major General Dempsey put it in an email to his subordinate commanders, our failing to "remember who we are" as American Soldiers.

Of course, those who believe in the efficacy of harsh interrogation techniques will argue that TF 1AD's interrogators were not as successful tactically as they would have been if they had employed such techniques. However, this is unlikely to be true. The

501st MI Battalion's HUMINT warrant officers certainly did not accept such an argument. To a man, they believed that they would have been less successful if they had employed harsh techniques, often saying "torture is for amateurs, professionals don't need it."⁸⁶ Their judgment is corroborated by other sources. In "How to Break a Terrorist," for example, Matthew Alexander (one of the interrogators who led U.S. forces to Musab al Zarqawi), convincingly argues that interrogators who build rapport with sources and then intelligently apply doctrinal approaches are more successful than those who rely on brutal methods.⁸⁷

Now, we make one last stop in TF 1AD, this time to study brigade-level interrogation operations. During this stop, we examine one deliberately-chosen brigade, a brigade that was not only CJTF-7's largest brigade combat team but also TF 1AD's most innovative brigade with regard to HUMINT operations. This innovation stirred a great deal of controversy during OIF I, at least within the division's intelligence community. If the study of any TF 1AD brigade during OIF I can usefully illustrate what brigade-level intelligence doctrine should look like (or perhaps, what it should not look like), it would be the study of TF 1AD's 2nd Brigade Combat Team (2BCT).

¹Peter R. Mansoor, *Baghdad at Sunrise* (New Haven & London: Yale University Press, 2008), 178.

²Ibid., 178-179.

³The 1st Armored Division was activated on 15 July 1940 at Fort Knox, Kentucky. Its commander at the time, Major General Bruce Magruder, nicknamed the division "Old Ironsides" after the famously resilient and undefeated U.S. warship, the U.S.S. *Constitution*. During World War II, the division fought with distinction in North Africa and Italy. In North Africa, after its first encounter with (and defeat by) Rommel's Afrika Korps at the Battle of the Kasserine Pass, the 1AD and other American forces adapted quickly, forcing the surrender of the entire Afrika Corps just three months later. Shortly before his death, Rommel reflected on the North African campaign, writing

"what was astonishing was the speed with which the Americans adapted themselves to modern warfare." (Rommel, 521). Forty years later, the 1AD would need both the resilience of the U.S.S. *Constitution* and the adaptability of its forebear in North Africa to operate effectively in Baghdad, which was arguably the most complex and dangerous terrain for coalition forces during OIF I.

⁴The 1AD is currently in the process of moving to Fort Bliss, a move that will be complete by Fiscal Year 2012. The headquarters, 1AD, is scheduled to move to Fort Bliss in 2011; the 1st Brigade completed its move to Fort Bliss on October 27, 2008; the 2nd Brigade is still at Baumholder and will be re-flagged as the 170th Infantry Brigade in 2010, whereupon it will stay in Germany (a brigade from the 1st Cavalry Division will be flagged as the 2BCT, 1AD, at that time on Fort Bliss); the 3rd Brigade is still at Fort Riley, but it was re-flagged as the 2nd Brigade, 1st Infantry Division, on March 28, 2008 (a new 3rd Brigade, 1AD, has not yet been established on Fort Bliss); the 4th Brigade, now a heavy combat team instead of an aviation brigade, has been re-designated from the 4th Brigade, 1st Cavalry Division, and has been established on Fort Bliss; and the 1AD now has a 5th Brigade that was activated in 2007 on Fort Bliss. The 1AD Engineer Brigade, Division Artillery (DIVARTY), and the 501st MI Battalion have all been inactivated. Also, a combat aviation brigade will be moved from Fort Hood to Fort Bliss, where it will be assigned to the 1AD.

⁵Estes, *U.S. Army Soldier Baghdad 2003-04*, 6.

⁶Ibid. Two battalions of the 3rd Brigade, the 1-41st Infantry Battalion and the 2-70th Armor Battalion, were attached to the 3rd Infantry Division for the invasion.

⁷Major Douglas A. Pryer, "Interview with CW3 John Groseclose," *Operational Leadership Experiences in the Global War on Terrorism*, January 7, 2009, http://cgsc.cdmhost.com/cdm4/item_viewer.php?CISOROOT=/p4013coll13&CISOPTR=1429&CISOBX=1&REC=1 (accessed March 1, 2009), 6. The assumption that the battalion would be conducting large scale screening operations was rooted in the battalion's experience a decade earlier during DESERT STORM.

⁸Ibid; Major Douglas A. Pryer, "Interview with CW3 Kenneth Kilbourne," 5. CW3 Groseclose, who managed HUMINT operations for Company C, 501 MI Battalion, states that he did not cross-train his CI personnel as interrogators before deployment. On the other hand, CW3 Kilbourne, who managed HUMINT operations for Company A, 501st MI BN, says he did conduct this cross-training. The author, who commanded Company B, 501st MI BN for one year after November 2003, does not believe that Company B conducted this pre-deployment cross-training in early 2003. Since these three companies held all of 1AD's HUMINT personnel, approximately one-third of the 1AD's counterintelligence personnel had been cross-trained as interrogators prior to the OIF I deployment.

⁹Major Douglas A. Pryer, "Interview with CW3 John Groseclose," 7; and Major Douglas A. Pryer, "Interview with LTC (Ret.) Elizabeth Rogers," *Operational*

Leadership Experiences in the Global War on Terrorism, January 11, 2009, http://cgsc.cdmhost.com/cdm4/item_viewer.php?CISOROOT=/p4013coll13&CISOPTR=1442&CISOBOX=1&REC=4 (accessed March 5, 2009), 3-4.

¹⁰In addition to two of the 3rd Brigade's battalions, the 2nd Brigade of the 82nd Airborne Division, which would be attached to the 1AD for the first half of OIF I, took part in the invasion.

¹¹Estes, *U.S. Army Soldier Baghdad 2003-04*, 6.

¹²*Ibid.*, 7.

¹³At the time of its deployment to Iraq, the 2LCR's home station was Fort Polk, Louisiana. After redeployment, the unit moved to Fort Lewis, Washington, and was transformed into a Stryker Brigade. On June 1, 2006, the unit was re-designated as the 4th Brigade, 2nd Infantry Division.

¹⁴Zone 21 has had several names. When it was built in 1959, it was called "Al Thawra" (or Revolution City). After the Baath Party Coup of 1963, it was officially re-named Saddam City in honor of Saddam Hussein, though many continued to refer to it as al-Thawra. After the coalition invasion of Iraq, the district was unofficially renamed Sadr City by its residents after the assassinated Shiite leader, Mohammad Sadeq al-Sadr. This district, which is unquestionably the most populated slum in Iraq, has more than one million residents.

¹⁵Estes, *U.S. Army Soldier Baghdad 2003-04*, 7.

¹⁶*Ibid.* Unlike most of the division, which had a 15-month deployment due to its extension for Operation Iron Saber, most of the 3rd Brigade had only a 12-month deployment, since it had deployed early and thus also redeployed early: when 1AD got the news of its extension, the 3rd Brigade was already home and most of its soldiers on leave.

¹⁷Charlie Coon, "'Stability Operation' Turned into 15-Month Street Fight," *Stars and Stripes*, September 2004: 5-16, 16.

¹⁸Brigadier General Dempsey's star has risen rapidly since taking command of the 1AD. Since OIF I, he has held such notable jobs as acting commander for U.S. Central Command and (his current job) the commanding general of U.S. Training and Doctrine Command.

¹⁹1st Armored Division Headquarters, *1st Armored Division History*, <http://www.1ad.army.mil/History.htm> (accessed March 23, 2009).

²⁰*Ibid.*

²¹Ibid. TF 1AD's nation-building efforts were truly prodigious during OIF I. For example, TF 1AD recruited, equipped, and trained 12,000 policemen, 6,200 Iraqi civil defense corps personnel; 5,500 Facility Protection Services guards (Hensley, 1-2, and Estes, 40). The division also increased Baghdad's fire departments from 10 to 23 fire stations and from 450 to 1250 firemen (Hensley, 2). Additionally, the division discovered caches that included over 55 million rounds of small-arms ammunition and more than one million items of explosives and arms (Estes, 50). What is more, the division supervised an estimated \$2 billion in improvements to Baghdad on thousands of community projects, to include improved hospitals, clinics, schools, electrical infrastructure, police stations, and sewage treatment plants (Hensley, 2). Perhaps most importantly, though, the 1AD helped initiate democracy from the "ground up," establishing 88 democratically-selected neighborhood advisory councils that, in turn, elected members to nine district advisory councils in the city (Hensley, 3). As a result of these and other efforts, the division slowly reduced criminal violence during OIF I and, although not successful in preventing insurgent violence, successfully kept a lid on truly significant insurgent violence during OIF I: such violence would not erupt until OIF II, upon which time acts of violence would dramatically increase over the course of the next three years.

²²Major Douglas A. Pryer, "Interview with LTC Nathan Hoepner," *Operational Leadership Experiences in the Global War on Terrorism*, February 2, 2009, http://cgsc.cdmhost.com/cdm4/item_viewer.php?CISOROOT=/p4013coll13&CISOPTR=1441&CISOBX=1&REC=6 (accessed March 5, 2009), 11; Major Douglas A. Pryer, "Interview with LTC (Ret.) Elizabeth Rogers," 5. These two interviews of the 501st MI Battalion S-3 and the 1AD Deputy G2 corroborate the assertion that no 501st MI Battalion school-trained HUMINT interrogator was ever investigated for detainee abuse.

²³Major Douglas A. Pryer, "Interview with CW3 John Groseclose," 13. Considering the character of the commander and S-3 of the 501st MI Battalion, it is unlikely that these leaders would have forwarded a request for a SERE interrogation technique to CJTF-7. After all, it was the S-3 for the 501st MI Battalion, Lieutenant Colonel Hoepner, who refused to submit a "wish list" for harsh interrogation techniques to CJTF-7 and who cautioned other CJTF-7 J2X personnel to stay "on the high ground" (as described in the email exchange at the start of this paper).

²⁴Major Douglas A. Pryer, "Interview with LTC Russell Godsil," *Operational Leadership Experiences in the Global War on Terrorism*, December 20, 2008, http://cgsc.cdmhost.com/cdm4/item_viewer.php?CISOROOT=/p4013coll13&CISOPTR=1443&CISOBX=1&REC=7 (accessed March 8, 2009), 6; Major Douglas A. Pryer, "Interview with LTC Mark Crisman," 5. These two interviews are of the 1st and 3rd Brigade S-2s respectively, both of whom state their inspections with the ICRC went very well. Lieutenant Colonel Larry Wilson, the 2BCT S2, also validated for the author that the ICRC never found a deficiency at the 2BCT's holding area.

²⁵ICRC, "Report of the International Committee of the Red Cross," 1-24.

²⁶Human Rights Watch, "No Blood, No Foul," 1-55.

²⁷The exact nature and extent of 1AD's use of stress positions on detainees is unclear. When the author was the Company B, 501st MI Battalion, commander, an interrogator was assigned to his company from Company C, 501st MI Battalion, who (immediately after his assignment to Company B) made a detainee do push-ups and jumping jacks. This interrogator was not doing this as part of an interrogation approach (which is illegal according to the Geneva Conventions) but was doing this to control an unruly detainee (which was not technically illegal). The interrogator told the author that he believed he was allowed to do this. Despite the lack of clear higher guidance on the subject, the author and his HUMINT section supervisor, CW3 Joel Giefer, formally counseled this interrogator not to do this again. When the author recently interviewed the Company C, 501st MI Battalion, senior HUMINT technician, the interviewee denied that his interrogators ever employed harsh stress positions and exercises to control detainees, though he neither denied nor confirmed the use of light stress positions and exercises to control detainees (Pryer, Interview with CW3 John Groseclose, 12). He also denied that his interrogators ever used stress positions as part of an interrogation approach (Pryer, Interview with CW3 John Groseclose, 12). The Brigade S2 for the 3rd Brigade, on the other hand, stated that he believed interrogators had used stress positions as part of interrogation approaches during the brief period (September 14 to October 10, 2003) when the use of this technique had been sanctioned by Lieutenant General Sanchez, even though Sanchez' policy required Sanchez' personal approval for the use of this technique (Pryer, Interview with LTC Mark Crisman, 9). Also, the Brigade S2 for the 2BCT stated that unruly detainees were sometimes made to stand on sandbags (Pryer, Interview with LTC Larry Wilson, 12). Additionally, Lieutenant Colonel Hoepner, the Battalion S-3 for the 501st MI Battalion, has stated that he counseled interrogators during holding area inspections that it was okay to use stress positions to control detainees but not to use such methods to coerce answers from detainees (Pryer, Interview with LTC Nathan Hoepner, 12). The author also remembers allegations early in OIF I of 2/82nd detention personnel making unruly detainees engage in light exercise. Based on the scanty and inconsistent evidence outlined in this endnote, the author believes it likely that some interrogators and detention personnel in some TF 1AD units for short periods of time used light exercises and stress positions to control unruly detainees, but they did not use such techniques as part of coercive interrogation approaches--even during the brief time that Sanchez permitted the use of such techniques. Further supporting the conclusion that stress positions were not used in TF 1AD as interrogation techniques is the fact that there is no published record of Sanchez ever approving their use for TF 1AD interrogations--or of TF 1AD ever requesting such approval.

²⁸Department of the Army, Field Manual 3-19.40, *Internment/Resettlement Operations*, (2001), 7-27.

²⁹International Committee of the Red Cross, "Convention (IV) Relative to the Protection of Civilian Persons in Time of War."

³⁰Ibid.

³¹Ibid.

³²1AD Headquarters, "FRAGO 383A [General Order - Civilian or Detainee Maltreatment] to OPORD 03-215 (Iron Stability)," *American Civil Liberties Union: Torture FOIA*, July 21, 2003, <http://www.aclu.org/projects/foiasearch/pdf/DODDOA027333.pdf> (accessed March 4, 2009), 58-60. This Fragmentary Order is archived as part of an unsubstantiated allegation of the abuse of a detainee. Based on various clues, the incident that prompted the investigation in which this order is contained probably occurred at the 3BCT holding area in Baghdad. (The investigating officer found this allegation of abuse to be unsubstantiated.)

³³Ibid., 59.

³⁴Ibid.

³⁵Ibid.

³⁶Major Douglas A. Pryer, "Interview with LTC Nathan Hoepner," 11. Also see Dempsey's email to his brigade commander's at the beginning of this chapter.

³⁷For example, in the first sentence of his command philosophy, Lieutenant Colonel Laurence Mixon, who commanded the battalion for most of OIF I, matter of factly asserted that the battalion was a "values-based organization." Then, in the very next sentence he borrowed the shining "city upon the hill" metaphor by presenting key moral principles as "guideposts, lighting our way ahead."

³⁸The author extracted the timeline cited in this paragraph from his personal emails during this period.

³⁹Major Douglas A. Pryer, "Interview with Captain Nicole Lauenstein," *Operational Leadership Experiences in the Global War on Terrorism*, March 4, 2009, <http://cdm15040.contentdm.oclc.org/cgi-bin/showfile.exe?CISOROOT=/p4013coll13&CISOPTR=1454&filename=1457.pdf#search=%22Pryer%22> (accessed April 30, 2009), 7.

⁴⁰Major Douglas A. Pryer, "Interview with CW3 John Groseclose," 13.

⁴¹Major Douglas A. Pryer, "Interview with Ms. Amanda Meyer," *Operational Leadership Experiences in the Global War on Terrorism*, January 5, 2009, http://cgsc.cdmhost.com/cdm4/item_viewer.php?CISOROOT=/p4013coll13&CISOPTR=1395&CISOBX=1&REC=10 (accessed April 1, 2009), 7.

⁴²Ibid.

⁴³Major Douglas A. Pryer, "Interview with LTC Nathan Hoepner," 15.

⁴⁴Headquarters, 1st Armored Division, "1 AD PAM 1-201 Command Inspection Checklist, September 2003," *American Civil Liberties Union: Torture FOIA*, <http://www.aclu.org/projects/foiasearch/pdf/DOD045364.pdf> (accessed December 12, 2008), 3, 12.

⁴⁵*Ibid.*, 13.

⁴⁶*Ibid.*

⁴⁷CPT Douglas A. Pryer, "501st MI BTOC SOP," Standard Operating Procedures, Baghdad, November 3, 2003, B-a-1. The author compiled the SOP for the 501st MI Battalion Tactical Operations Center while serving as the night battle captain for this center. He completed the SOP just a few days before moving to downtown Baghdad to take command of Company B, 501st MI Battalion. Almost certainly, the author has the only remaining copy of this document.

⁴⁸*Ibid.*, D-c-1.

⁴⁹*Ibid.*, B-a-1.

⁵⁰*Ibid.*, D-k-1.

⁵¹*Ibid.*, D-k-2.

⁵²*Ibid.*

⁵³Major Douglas A. Pryer, "Interview with LTC Nathan Hoepner," 6; Estes, *U.S. Army Soldier Baghdad 2003-04*, 54.

⁵⁴*Ibid.*

⁵⁵*Ibid.*, 8.

⁵⁶*Ibid.*

⁵⁷*Ibid.*, 7.

⁵⁸*Ibid.*, 8.

⁵⁹*Ibid.*

⁶⁰*Ibid.*, 5.

⁶¹*Ibid.*

⁶²*Ibid.*, 15.

⁶³*Ibid.*, 12.

⁶⁴Major Douglas A. Pryer, "Interview with LTC Nathan Hoepner," 18.

⁶⁵*Ibid.*, 16; 501st MP Platoon Leader, "Collection Point & Internment Facility Interview Questions," *American Civil Liberties Union: Torture FOIA*, March 23, 2004, <http://www.aclu.org/projects/foiasearch/pdf/DOD018576.pdf> (accessed March 23, 2009), 17.

⁶⁶LTC Nathan Hoepner, *Email to Author, "Re: Interview!"*, March 25, 2009.

⁶⁷*Ibid.*

⁶⁸LTC Nathan Hoepner, *Email to Author: Re: Interview!*, March 28, 2009.

⁶⁹Department of the Navy Inspector General, "Review," 60.

⁷⁰Major Douglas A. Pryer, "Interview with LTC Nathan Hoepner," 4.

⁷¹*Ibid.*

⁷²*Ibid.*

⁷³*Ibid.*

⁷⁴*Ibid.*

⁷⁵Major Douglas A. Pryer, "Interview with CW3 John Groseclose," 5-6.

⁷⁶*Ibid.*, 294.

⁷⁷*Ibid.*, 294-302.

⁷⁸*Ibid.*, 298. The investigative packet for this incident is posted at <http://www.aclu.org/projects/foiasearch/pdf/DODDOA027333.pdf>

⁷⁹*Ibid.*, 300. The investigative packet for this incident is posted at <http://www.aclu.org/projects/foiasearch/pdf/DODDOA027333.pdf>

⁸⁰*Ibid.* The investigative packet for this incident is posted at http://www.aclu.org/torturefoia/released/DOA_779_843.pdf

⁸¹*Ibid.*, 300-301.

⁸²*Ibid.*, 301.

⁸³Department of the Army, Field Manual 2-22.3, *Human Intelligence Collector Operations* (Washington, DC: U.S. Government Printing Office, 2006), 30.

⁸⁴*Ibid.*

⁸⁵Major Douglas A. Pryer, "Interview with Captain Nicole Lauenstein," 4.

⁸⁶Major Douglas A. Pryer, "Interview with LTC Nathan Hoepner," 11.

⁸⁷Matthew Alexander and John R. Bruning, *How to Break a Terrorist: The U.S. Interrogators Who Used Brains, Not Brutality, To Take Down the Deadliest Man in Iraq* (New York: Free Press, 2008).

CHAPTER 6

THE IRON BRIGADE

You can't rely on the THT [Tactical HUMINT Team] to do it all for you. THTs come with varying levels of competency and expertise. If that's the only source of HUMINT you have coming in, you're going to be in a hurt box. At the end of the day, more intelligence means less people dead.¹

— Lieutenant Colonel Larry Wilson,
Brigade S-2, 2nd Brigade, TF 1AD

Many of these “leaders” that were conducting their own intelligence-gathering operations were . . . getting people killed. What I heard . . . was that the 2nd Brigade's S2 chose not to use his HUMINT assets due to their youth and inexperience and then built a ridiculous 27 member S2X called the “Striker Service Agency” and gave everyone badges like they were some special three-letter agency. This was a joke and made a mockery of the entire HUMINT skill set.²

— CW3 Kenneth Kilbourne,
Operational Management Technician, 1st Brigade, TF 1AD

If Baghdad is the political heart of Iraq, then TF 1AD's 2nd Brigade Combat Team (2BCT) in downtown Baghdad operated within the heart of hearts of Iraq--or at the "tip of the spear" of U.S. stabilization efforts, to use more conventional parlance. Properly symbolizing the key terrain it occupied, the 2BCT's headquarters was located in the Al Faw Palace, a palace that, since it had been Saddam's official residence, could be considered the "White House" of Saddam's regime.

Within this "heart of hearts" of Iraq, the 2BCT was responsible for two of Baghdad's nine districts, the Karada and Karkh districts. The Karada district was on the east side of the Tigris River and extended from the center of Baghdad southeast to the Tuwaitha Nuclear Facility on Baghdad's outskirts. This relatively well-educated, affluent district included Baghdad's main banking district, the University of Baghdad, and most of Baghdad's embassies. On the west side of the Tigris River was the Karkh District, a

district that included such notable landmarks as the national Ba'ath Party headquarters, the Iraqi Cultural Museum, the Baghdad Zoo, the Crossed Sabers Monument, and the "Green Zone," the seat of the Coalition Provisional Authority during OIF I. Also, an insurgent stronghold was located in the Karkh District: the violence within this stronghold, which encompassed the businesses and high-rise apartments of Haifa Street as well as this notorious street's adjacent neighborhoods, stood in stark contrast to the secure environment established by the 2BCT in the Green Zone.

Five battalions were responsible for geographical sections of the 2BCT's area of responsibility. This included organic units (1-6 Infantry, 2-6 Infantry, 1-35 Armor, and 4-27 Field Artillery) as well as one attached unit (3rd Squadron/2LCR). With these troops, the brigade not only secured the Green Zone and a large amount of critical infrastructure, but most importantly, the 2BCT was responsible for the security of somewhere between 700,000 and one million Iraqis. Since the brigade itself had between 5,000 and 6,000 soldiers, the counterinsurgent-to-population ratio in the brigade's area ranged from five to eight counterinsurgents for every 1,000 Iraqis. Although this ratio improved slightly as the brigade slowly trained Iraqi security forces, this ratio never came close to reaching the "minimum troop density required" for effective counterinsurgency operations as codified in current Army doctrine--doctrine that now recommends 20 to 25 counterinsurgents for every 1,000 residents.³

Despite such long odds, the 2BCT accomplished much of which it would later be justifiably proud. These accomplishments included establishing and securing the Green Zone; recruiting and training a 960-man battalion of the Iraqi Civil Defense Corps; recruiting, screening, training, clothing, arming, and paying 2035 Facility Protection

Services personnel; recruiting and screening 1858 candidates for the Iraqi police; coordinating, securing, and paying for the renovation and reconstruction of 1002 projects worth \$13.5 million; and standing up 18 Neighborhood Advisory Councils and two democratically selected District Advisory Councils.⁴ The 2BCT would also serve as TF 1AD's main effort during the division's four-month extension in Iraq. As a result of its herculean efforts, the 2BCT was one of three TF 1AD units awarded the Presidential Unit Citation for its actions during the deployment. (The other two TF 1AD units so honored were the 1st Brigade Combat Team and the 2LCR.)

To accomplish a huge mission with limited troops, the 2BCT's leaders had to come up with creative solutions to their tactical problems. Nowhere was the need for creativity greater than in the field of intelligence.

"HUMINT-Centric Operations"

The primary architects of the 2BCT's intelligence innovations were Colonel Ralph Baker, the brigade commander, and Major Larry Wilson, the Brigade S-2. According to Colonel Baker, soon after he assumed command of the brigade on July 7, 2003, he understood that the brigade had to reform the way it conducted intelligence operations and "transition our conventional BCT intelligence system into a HUMINT-centric system."⁵ With the help of Wilson, who arrived in August 2003, Baker began transforming his brigade into an organization that heavily emphasized HUMINT collection and analysis.

Baker published Figure 10 below in an article in the March-April, 2007, edition of *Military Review*. Although the personnel numbers in this figure are incorrect, the diagram is conceptually accurate.⁶ What it accurately describes is how bright, motivated

non-MI soldiers joined soldiers from the brigade's S2 Section and direct-support MI company to create a large S2X (or HUMINT Analysis) Section. This new S2X Section, in turn, was divided into five subordinate sections--Targeting, EPW, Document Exploitation, Passive HUMINT Collection, and Database Functions.

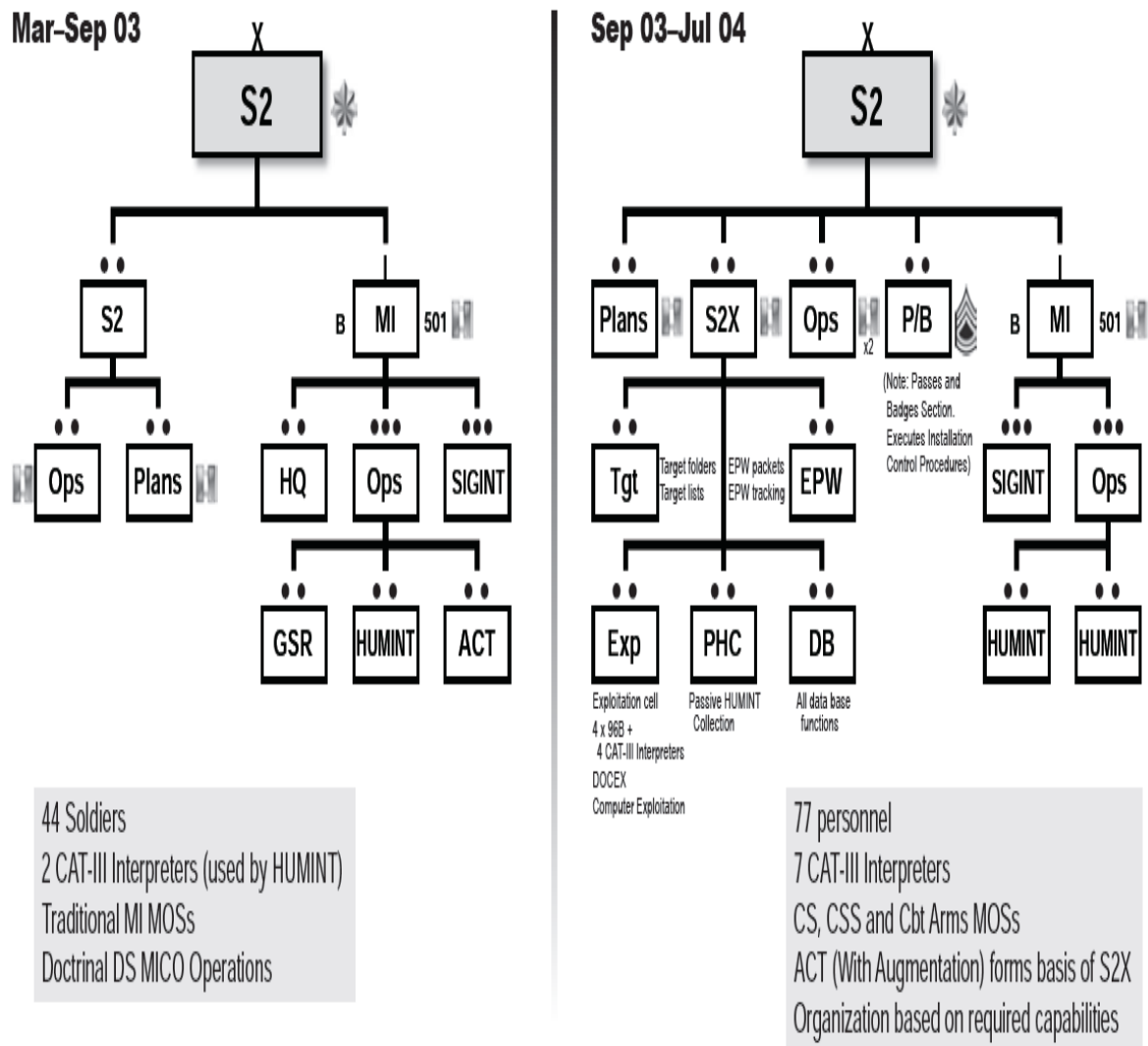

Figure 11. 2BCT, 1AD Intel Organization

Source: Colonel Ralph O. Baker, "HUMINT-Centric Operations: Developing Actionable Intelligence in the Urban Counterinsurgency Environment," *Military Review* (March-April 2007): 12-21, 14.

All of these S2X sections played a role in the brigade's interrogation operations: the Targeting, Document Exploitation, and Passive HUMINT sections provided interrogators with reports that helped them develop their interrogation plans; interrogators' SIRs found their way into detainee packets built by the EPW Section; and data specialists within the Database Functions Section archived data collected through interrogations and screenings. Also under Major Wilson's guidance, these sections developed and implemented capabilities that may have been unique to the 2BCT among CJTF-7's brigades. One of these capabilities, for example, was the brigade's use of FBI software to gather intelligence from captured hard drives.⁷ Yet another perhaps unique capability was the EPW Section's extensive use of an FBI polygraphist, whose conclusions regarding the truthfulness of detainees could then be passed on to interrogators to enhance interrogation plans.⁸

But the S2X capability that Wilson considered most valuable was employed by the Passive HUMINT Section, namely, the use of a "cage rat" and other carefully hidden informants to collect intelligence.⁹ The "cage rat" was an Iraqi who was planted as a prisoner in the 2BCT detention facility so as to clandestinely collect information from detainees. Wilson considered his "cage rat" to be more effective than a hidden microphone because of this informant's ability to engage detainees in conversation and actively elicit information of value.¹⁰ The brigade also routinely placed an informant masquerading as a prisoner in the trucks used to transport detainees after a raid.¹¹ In addition, if a detainee strongly suspected of insurgent ties had to be released because of insufficient evidence, the brigade might have an Iraqi taxi driver (who was also an informant) take the detainee home: if the detainee boasted of how he had "fooled the

stupid Americans" or provided some other self-incriminating evidence, the brigade could later detain him for further questioning.¹²

In addition to growing his headquarters and its intelligence-collection capabilities, Baker made it a command priority for each of his battalions to develop informant networks. At weekly Reconnaissance and Surveillance meetings, he checked on the number of informants each battalion had gathered and was briefed on the priority intelligence requirements each informant was trying to answer.¹³ Eventually, each Battalion S2 section developed three to five informants that they considered reliable.¹⁴ Wilson also had three to five informants, as did Captain William Bell, the captain in charge of his S2X section.¹⁵ The brigade's informants included "members of political parties, local government officials, prostitutes, police officers, retired Iraqi generals, prominent businessmen, and expatriates."¹⁶ According to Wilson, informant networks and "EPW collection" (that is, interrogators and hidden informants) had "to operate in concert in order to provide the brigade with the intelligence that it needed."¹⁷

By adding such capabilities, the 2BCT leadership believed that it achieved intelligence successes that it would not otherwise have achieved. Most proudly, this leadership pointed to the arrest of an insurgent cell which it called the "Muhalla 636 Gang" and which it believed responsible for the October 26, 2003, rocket attack on the al Rasheed Hotel. (This rocket attack had killed Army Lieutenant Colonel Charles Buehring and wounded several others. Uninjured in the attack had been Deputy Secretary of Defense Paul Wolfowitz, also staying in the hotel.)¹⁸ Although professional HUMINT collectors played a role in these captures, the 2BCT's leadership believed that its informant networks deserved most of the credit for its apprehension of this gang.¹⁹

Many leaders within TF 1AD's MI community, however, had serious reservations regarding both the 2BCT's informant networks and the purported successes of these networks.²⁰ The biggest concern of these HUMINT professionals involved the 2BCT's extensive use of informant networks. These professionals believed that "sensitizing" informants regarding the brigade's priority intelligence requirements was tantamount to "tasking" or "running" sources to collect specific information.²¹ Running sources, such professionals argued, is a complex counterintelligence function requiring years of professional education and hands-on experience to master.²² In the hands of non-professional handlers, informants might be paid too much, thus adversely impacting source operations when sources moved from professional handlers to unprofessional (but higher) bidders.²³ These professionals also argued that informants might be tasked by non-professionals to collect intelligence for which they did not have placement and access, leading to their being killed by insurgents.²⁴ Additionally, these professionals noted that, since the 2BCT's non-professional source handlers had no division oversight, there was nothing to stop these handlers from using sources proven unreliable by HUMINT soldiers in other brigades. What is more, they argued, improperly screened (or "vetted") informants were likely to provide misinformation, thus resulting in the brigade's unknowingly actioning poor intelligence and detaining innocent Iraqis. Worst of all, they said, deliberate misinformation might get soldiers ambushed and killed.

A few incidents that allegedly occurred during OIF I may have justified such concerns. To this day, many of TF 1AD's MI leaders and soldiers believe that 2BCT informants died because they were improperly handled.²⁵ As for such successes as the apprehension of the Muhalla 636 gang, at least one HUMINT operator intimately

connected with this operation continues to privately voice his belief that the 2BCT's leadership did not capture whom they thought they captured: they captured the wrong bad guys, he says.²⁶ Although there is no definitive proof to support the largely private and strongly voiced beliefs of many MI professionals with regard to the 2BCT's informant networks, these leaders and soldiers have earned enough credibility to make their opinions on this subject worth noting.

Camp Striker

The 2BCT had one incident of substantiated interrogation abuse involving combat troops (not school-trained interrogators). This incident, which involved 2-6 Infantry Battalion, is described in Chapter 5 above. There was no such abuse at the Brigade Holding Facility, though. According to Major Wilson, Colonel Baker told him "there will be no 15-6's [investigations] in our detention facility."²⁷ Thus, Wilson says, he was very careful to ensure that the facility followed "both the spirit and the letter of the law for detainees."²⁸ This indeed was the case, since the facility not only incurred zero cases of alleged detainee abuse, but it easily passed inspections by such outside agencies as the ICRC, U.S. Central Command, the U.S. Army Inspector General, and TF 1AD.²⁹

Like a few other facilities in TF 1AD, however, the facility did occasionally employ stress positions to control unruly detainees: according to Wilson, "about the worst thing we ever did was make a guy stand on a sandbag."³⁰ The use of this questionable tactic was employed only by guards, never by interrogators, though. Even more critically, there is no record of an allegation that the brigade's school-trained interrogators employed harsh interrogation methods on sources.

placed on the tennis court. The tennis court fence was patrolled by guards and topped with barbed wire. Soon after Wilson arrived, however, serious construction began on the site. By October 2003, the facility had a sally port entrance, interrogation rooms, and 36 cells with two cages each. This upgraded configuration was more secure, kept detainees segregated, and was handier for interrogators since they no longer had to have sources escorted 100 meters to underground interrogation rooms at the palace. Also, the facility was an ideal setting for eavesdropping by the brigade's "cage rat," since this hidden informant could now be placed between the cells of suspected insurgent group members.

Three different units served as guards at the facility--platoons from the 38th MP Company, 4-27 Field Artillery Battalion and 2-6 Infantry Battalion.³¹ Somewhat surprisingly, Wilson has said that he was the least pleased with the performance of the MP guards, who he says kept having minor administrative issues: "the issue there was that the ability of these troops had nothing to do with their basic skill set; it has to do with basic troop leading procedures when maintaining a standard."³²

Colonel Baker made it clear to Major Wilson soon after he arrived "that the S-2 had staff proponency over all detainee operations," to include "the MPs, the interrogators, the MI company, and the transportation assets we used to move detainees around the battlefield."³³ Thus, although Wilson probably could have directed MPs to "soften up" detainees for interrogations, he never did this: "Colonel Baker and I had a discussion early on that, if a guy wasn't going to talk to us, it wasn't going to do us any good to try to beat information out of him," he said. "At the end of the day, if a guy wasn't going to talk to us, our only recourse was just to process him for Abu Ghraib." Unknown at the time,

this decision to protect uncooperative detainees by simply shipping them to Abu Ghraib would be, in retrospect, an ironic decision.

Key Conclusions

Although the largest brigade combat team in Iraq during OIF I, the 2BCT was still drastically under-resourced for its huge mission. Most relevantly, the brigade's S2 shop and direct-support MI company were inadequately manned and ineffectively structured to provide the brigade with all of the intelligence capabilities that the brigade needed. So, the brigade's leadership employed non-standard intelligence personnel and methods to solve this tactical problem--sometimes improvising brilliantly. Examples of methods that worked include the brigade's use of an FBI polygraphist and of FBI computer-exploitation software to support interrogations and the building of criminal charges against detainees.

The results of the brigade's extensive use of informants, however, were mixed. Having seven MI officers (the Brigade S2, Brigade S2X, and Battalion S2s) essentially "running sources" may have provided the brigade with more intelligence than it would have been able to otherwise obtain. However, it was an extremely dangerous practice, and, if the brigade's HUMINT professionals were correct, the quality of the intelligence gleaned in this fashion was worse than the 2BCT's leadership realized. Additionally, the 2BCT's leadership may not have understood that HUMINT soldiers were neither screening the informants being run by S2s nor being given the opportunity to assume responsibility for especially valuable informants.³⁴

The placing of the lives of civilian informants in the hands of untrained handlers struck many HUMINT professionals as amoral and unworthy of our nation's tradition of

staying on the moral high ground. Before reaching such a judgment, though, one must consider that the informants themselves were willing participants: these informants knowingly risked their lives for ends they themselves believed worth obtaining. Thus, while one can perhaps reasonably argue that relegating informants to non-professional handlers was irresponsible, it was certainly not amoral considering the informants' freedom of choice in the matter. In the end, the writers of *On Point II* probably got it right when they wrote that "tactical commanders had little choice" but to pursue such non-doctrinal methods.³⁵ This judgment noted, the consequences of this limited choice were probably sometimes grave, and our Army must ensure that tactical commanders are given more resources--and better choices--in the future.

Finally, the 2BCT built a superb brigade detention facility that effectively supported interrogation operations. This structure was not only well-designed, but it also remained free of interrogation abuse. Thus, with regard to the conduct of its school-trained interrogators, the 2BCT clearly stood with the rest of TF 1AD on the moral high ground.

¹Major Douglas A. Pryer, "Interview with LTC Larry Wilson," *Operational Leadership Experiences in the Global War on Terrorism*. January 30, 2009, http://cdm15040.contentdm.oclc.org/cdm4/item_viewer.php?CISOROOT=/p4013coll13&CISOPTR=1471&CISOBX=1&REC=3 (accessed April 30, 2009), 8

²Pryer, "Interview with CW3 Kenneth Kilbourne," 11.

³Department of the Army, Field Manual 3-24, *Counterinsurgency* (Washington, DC: U.S. Government Printing Office, 2006), 1-13.

⁴Headquarters, 2nd Brigade Combat Team, "2nd BCT Collective Accomplishments, May 12, 2003, through April 14, 2004," Flyer, Baghdad, Iraq, 2004. 2BCT leaders received a copy of this two-page flyer upon the conclusion of OIF I for distribution to their troops. The author maintains a copy of this flyer.

⁵Colonel Ralph O. Baker, "HUMINT-Centric Operations: Developing Actionable Intelligence in the Urban Counterinsurgency Environment," *Military Review* (March-April 2007): 12-21, 13.

⁶The author of this history was the Company B, 501st MI Battalion, Commander for 12 months, December 2003 to November 2004. By its manning document, this company was authorized 43 soldiers. A Signals Intelligence (SIGINT) platoon from Company D, 501st MI Battalion, was attached to the company throughout the deployment, and it was authorized 18 soldiers. The BDE S2 section was authorized 10 soldiers. Although not at 100 percent manning, these units were close to 100 percent manning. Thus, the baseline number of MI soldiers assigned or attached to the 2BCT headquarters should be 61 soldiers. Plus, the number of Category II interpreters (who were used by HUMINT operators because of their SECRET security clearances) and the number of Category III interpreters (who were used by SIGINT operators because of their TOP SECRET security clearances) fluctuated only slightly during the course of OIF I. The number of Category II and III interpreters assigned to the Company B headquarters, which was consistently 4-6 interpreters, was also a number that brigades had no control (and very little influence) over. Thus, 65 MI personnel would be a more accurate total baseline number than 44 MI personnel. What may be accurate numbers-wise is that there may indeed have been more than 20 non-MI soldiers added to the Brigade S2 section, though this number still seems high. Additionally, there are two conceptual inaccuracies in this diagram. The first is that the diagram seems to illustrate the MI company's Ground Surveillance Radar (GSR) section as being absorbed by the S2X. This in fact never happened: although only occasionally conducting GSR missions, this section reinforced brigade scouts on occasion while, much more frequently, providing convoy security for HUMINT and other MI company assets. The second conceptual inaccuracy is that the company's Common Ground Sensor section is not depicted. The personnel of this section were either absorbed within the BDE's new S2X section or were tasked to run the Company B headquarters.

⁷Baker, 19.

⁸Pryer, "Interview with LTC Larry Wilson," 18. The 2BCT had greater access to the polygraphist because the polygraphist, who was a CJTF-7 resource, resided inside the Green Zone. The TF 1AD DIF coordinated with the CJTF-7 J2X for the polygraphist on a few occasions, but the DIF used him less frequently, at least in part because of the drive through hostile terrain from the Green Zone to the Baghdad International Airport (where the DIF was located).

⁹Ibid., 12-13.

¹⁰Ibid., 12.

¹¹Baker, 20-21.

¹²Ibid.

¹³Ibid., 15.

¹⁴Ibid., 17.

¹⁵Pryer, "Interview with LTC Larry Wilson," 14.

¹⁶Baker, "HUMINT-Centric Operations," 15.

¹⁷Pryer, "Interview with LTC Larry Wilson," 8.

¹⁸Wright and Reese, 201-202.

¹⁹Pete Connors, "Interview with COL Ralph Baker," *Operational Leadership Experiences in the Global War on Terrorism*, November 11, 2005, <http://cgsc.cdmhost.com/cgi-bin/showfile.exe?CISOROOT=/p4013coll13&CISOPTR=126&filename=127.pdf> (accessed May 10, 2009), 7-8; Pryer, "Interview with LTC Larry Wilson," 17. See also *On Point II*, pages 201-203, which describes the "Muhalla 636 Operation."

²⁰"Interview with LTC Nathan Hoepner," 13; Pryer, "Interview with LTC Russell Godsil," 10-11; Major Douglas Pryer, "Interview with MAJ Craig Martin," *Operational Leadership Experiences in the Global War on Terrorism*. December 21, 2008, http://cgsc.cdmhost.com/cdm4/item_viewer.php?CISOROOT=/p4013coll13&CISOPTR=1431&CISOBX=1&REC=9 (accessed April 10, 2009), 10; Pryer, "Interview with CW3 Kenneth Kilbourne," 10-11; Pryer, "Interview with CW3 John Groseclose," 15-16.

²¹Pryer, "Interview with LTC Larry Wilson," 15. According to LTC Wilson, 2BCT leaders and S2s did not task informants to collect specific intelligence, they "sensitized" informants to the intelligence needed and let informants figure out how to get this information.

²²Pryer, "Interview with LTC Nathan Hoepner," 13.

²³Ibid. LTC Hoepner is referring here to a complaint the author heard several times in Iraq, namely, that professional HUMINT collectors were losing sources to overpaying, untrained 2BCT handlers.

²⁴Pryer, "Interview with LTC Nathan Hoepner," 13; Pryer, "Interview with LTC Russell Godsil," 10-11; Pryer, "Interview with MAJ Craig Martin," 10; Pryer, "Interview with CW3 Kenneth Kilbourne," 10-11; and Pryer, "Interview with CW3 John Groseclose," 15-16.

²⁵Pryer, "Interview with LTC Russell Godsil," 10-11; Pryer, "Interview with MAJ Craig Martin," 10; Pryer, "Interview with CW3 Kenneth Kilbourne," 10-11. The author can also attest to the fact (since he was their commander at the time) that the HUMINT soldiers in direct support of the 2BCT shared this perception.

²⁶This former Company B, 501st MI Battalion, HUMINT operator declined to be formally interviewed for this history, wishing to remain anonymous.

²⁷Pryer, "Interview with LTC Larry Wilson," 12.

²⁸Ibid.

²⁹Ibid., 7. Although unnoted in the author's online interview with Lieutenant Colonel Wilson, Wilson informed the author during this meeting that the 2BCT passed all of these inspections with no deficiencies noted. Lieutenant Colonel Hoepner, who inspected the 2BCT's detention facility on more than one occasion, has corroborated this assertion.

³⁰Ibid., 12.

³¹Ibid., 4.

³²Ibid.

³³Ibid.

³⁴It is unclear why HUMINT professionals were never asked to "vet" (or screen) 2BCT informants or to run themselves those informants deemed to be especially valuable. In fact, the 2BCT's HUMINT professionals reported "push back" whenever they inquired about informants. Perhaps an unintended consequence of Colonel Baker's decision to praise units with the most robust HUMINT networks was to instill a competition that, at least with regard to encouraging units to hand-off their sources to HUMINT professionals, was not always a healthy competition.

³⁵Reese and Wright, 192.

CHAPTER 7

THE ASCENT FROM ABU GHRAIB

In accordance with the Detainee Treatment Act of 2005, the only interrogation approaches and techniques that are authorized for use against any detainee, regardless of status or characterization, are those authorized and listed in this Field Manual.¹

— FM 2-22-3, *Human Intelligence Collector Operations* (September 2006)

So much of what the divisions are doing is just so much eye wash. Shifting assets between modular BCTs is extremely difficult and nearly impossible concerning the organic systems/personnel that the BCT brings into theater. In the end, the CG [Commanding General] is left with an extremely biased and lopsided view of the battlefield since his view comes through the lens of the BCT collection effort."²

— Lieutenant Colonel Russell Godsil,
1AD Deputy G2

Since OIF I, the U.S. Army has made great strides in improving interrogation-related doctrine, force structure, and training. However, serious deficiencies still remain.

Publishing New Doctrine

U.S. Army doctrine published post-OIF I more clearly promotes adherence to the Law of War than doctrine published before OIF I. Other doctrinal deficiencies uncovered during the course of this paper have largely been corrected as well. Below is a summary of how current doctrine addresses (and in a few cases, does not address) the major doctrinal deficiencies of OIF I.

Interrogation Approaches. Many SERE and other abusive interrogation techniques are explicitly prohibited in MI doctrine today, to include "damaging or destroying an individual's religious articles," "forcing the detainee to be naked," "placing hoods or sacks over the head of a detainee," "applying beatings, electric shock, burns, or

other pain," "waterboarding," "using military working dogs," "inducing hypothermia or heat injury," "conducting mock executions," and "depriving the detainee of necessary food, water, or medical care."³ However, since "pain" is left undefined (a critical shortcoming in light of the Bush Administration's so-called "torture memos"), it is unclear whether such SERE techniques as the use of mild "stress positions," "bright lights and loud noise," "environmental manipulation," "close-quarters confinement," and "sleep deprivation" are prohibited for use on all detainees. Failing to explicitly prohibit every SERE technique might prove a serious oversight if it were not for the Detainee Treatment Act of 2005, which made it illegal for any military interrogator to use approaches or techniques other than those included in FM 2-22.3, *Human Intelligence Collector Operation*. Nonetheless, doctrine should be updated so as to help prevent potential misunderstanding.

MI Versus MP Responsibilities. Any ambiguity with regard to whether MPs can actively set conditions for screenings or interrogations has been removed. According to current MI doctrine, "MPs will not take any actions to set conditions for interrogations (for example, 'softening up' a detainee)."⁴ MI doctrine states that MPs may, however, provide incentives to detainees at the behest of interrogators if these incentives are "approved by the MP facility commander," do "not affect the baseline standards of humane treatment," and do "not violate detainee custody and control or facility security."⁵ MP doctrine precisely mirrors MI doctrine here, stating that MPs "never set conditions for future interrogation operations"⁶ and that MPs may provide incentives to detainees under the same three conditions outlined by MI doctrine above.⁷ Figure 12, which is taken from the current interrogations manual, further delineates MI and MP

responsibilities--a delineation that is mirrored by a nearly identical table in current MP doctrine, FM 3-19.40, *Internment/Resettlement Operations*.⁸

POINT OF CAPTURE THROUGH EVACUATION	
<p style="text-align: center;"><u>MP Functions</u></p> <ul style="list-style-type: none"> • Maneuver and Mobility Support Operations • Area Security • Internment and Resettlement Operations • Law and Order Operations • Police Intelligence Operations • Ensure detainee abuse is avoided and reported 	<p style="text-align: center;"><u>HUMINT Functions</u></p> <ul style="list-style-type: none"> • Screen and question detainees at TCPs and checkpoints • Question contacts, local civilians, refugees, and EPWs • Conduct liaison with military and civilian agencies • Report information obtained • Ensure detainee abuse is avoided and reported • Support DOCEX
DETENTION FACILITY	
<p style="text-align: center;"><u>MP Functions</u></p> <ul style="list-style-type: none"> • Detain and guard EPWs, civilian internees, and other detainees • Conduct reception and processing • Coordinate Classes I, II, and VIII supplies • Coordinate NGOs, PVOs, and interagency visits • Ensure detainee abuse is avoided and reported • Transport detainees within the detention facility to interrogation area • Maintain security during interrogation operations 	<p style="text-align: center;"><u>HUMINT Functions</u></p> <ul style="list-style-type: none"> • Debrief guards • Screen detainees and EPWs for PIR and IR • Provide linguist support when possible • Observe detainees under MP control • Ensure detainee abuse is avoided and reported • Conduct interrogations • Report information obtained • Cross-cue other intelligence disciplines (as needed) • Support DOCEX

Figure 13. MI versus MP Responsibilities

Source: Department of the Army, Field Manual 2-22.3, *Human Intelligence Collector Operations* (Washington, DC: U.S. Department of the Army, September 2006), 5-18.

Staff Proponency. With regard to staff proponency for detainee operations, the Secretary of the Army has designated the Provost Marshal General as having "the executive role for detainee operations and long-term confinement of U.S. military prisoners."⁹ Also, MI doctrine now lays out clearly which MI element has what staff responsibility with regard to all HUMINT operations. There remains at least one

significant issue within this framework, though: doctrine states that the "MI Commander/OMT" is responsible for mission execution at the division level;¹⁰ yet, divisions lost their organic MI battalions during the Army's transition to modular brigades. Due to this loss, it is unlikely that a division will receive an MI headquarters with the ability to perform this doctrinal responsibility during a deployment.

Chain of Command. Command and control at detention facilities has been clarified. MP doctrine states that, "All HUMINT units are under the TACON of the facility commander for the humane treatment, evacuation, and custody and control (reception, processing, administration, internment, and safety) of detainees; protection measures; and the operation of the internment facility."¹¹ It also states that, "The MI unit commander is responsible for the conduct of interrogation operations, to include prioritizing effort and controlling the technical aspects of interrogation or other intelligence operations."¹² MP doctrine does not direct that MP officers serve as facility commanders, presumably since the senior commander with soldiers at a facility may not be an MP officer. MP doctrine is clearer, however, with regard to who the overall Commander of Detainee Operations should be for a specific theater: this commander should be "the senior military police commander" in theater.¹³

Tactical Interrogation Timeline. Since tactical-level units routinely operate on non-contiguous battlefields and must generate the majority of their own intelligence, doctrine no longer dictates the length of time a detainee must spend at tactical command levels. The matter is now left to "command policy guidance."¹⁴

Contract Interrogator Management. FM 2-22.3, *Human Intelligence Collector Operations*, now dedicates an entire appendix to the management of contract

interrogators. This appendix covers the responsibilities of commanders and unit contracting officer representatives with regard to contract interrogators. It also states that contract interrogators "must successfully complete a training program approved by the United States Army Intelligence Center and Fort Huachuca, or the Defense HUMINT Management Office, which will serve as validation to perform MI interrogations."¹⁵

Other Governmental Agencies. Army doctrine now restricts CIA (and other non-DoD) agents from using abusive interrogation techniques in Army facilities. FM 2-22.3, *Human Intelligence Collector Operations*, states that non-DoD agencies may only use Army detention facilities upon approval of the appropriate Joint Task Force commander, theater commander, or "appropriate higher level official."¹⁶ Once approval is obtained, the non-DoD interrogator may only use Army-sanctioned approaches and techniques and must sign a statement agreeing to abide by Army rules.¹⁷ Also, non-DoD interrogations must be observed by DoD personnel.¹⁸

Medical Records. MI doctrine still does not say whether interrogators are given access to the medical records of detainees. MI doctrine does state, however, that "HUMINT collectors may interrogate a wounded or injured detainee provided that they obtain permission from a competent medical authority."¹⁹ Of course, the interrogator is not authorized to "give the impression that any type of medical treatment is conditional on the detainee's cooperation in answering questions."²⁰

Polygraphists. MI doctrine now explicitly states that polygraphists may support interrogations. There is still a lack, however, of both polygraphists and machines to support interrogations. The Army fielded 94 portable lie detectors called the Preliminary Credibility Assessment Screening System to troops in Afghanistan in April 2008.²¹

Troops are authorized to use the machines after receiving a one-week training course.²²

While declassified data is currently unavailable regarding the usefulness of these particular machines in the field, this seems to be a small step in the right direction.

Behavioral Scientists. Some doctrinal guidance is now provided for the employment of behavioral science consultants. For example, behavioral science consultants are "authorized to make psychological assessments of the character, personality, social interactions, and other behavioral characteristics of interrogation subjects and advise HUMINT collectors of their assessments, as needed."²³ As with polygraphists, however, the lack of such consultants at the tactical level remains an issue.

Ethical Toolkit. Unfortunately, the Army possesses the same "ethical toolkit" to assist leaders that it possessed during OIF I. This toolkit largely consists of the "Army Values" paradigm, which remains an unclear methodology for helping leaders solve complex, real-world ethical problems. For example, doctrine still defines the Army value of "respect" as to "treat someone as they should be treated."²⁴ Clearly, such a definition merely encourages the approach that, if a detainee were to be considered a "terrorist," this detainee should be treated as the captor thinks terrorists should be treated (that is, perhaps, treated very badly).

Growing the Interrogation Force

Since OIF I, the Army's interrogation force structure has grown dramatically. At the end of Fiscal Year 2005, the Army had 2,500 HUMINT soldiers, but this number is projected to grow to 6,000 by Fiscal Year 2011.²⁵ Although significant in itself, this increase in the number of HUMINT soldiers does not reflect the real growth in capability, since most of these HUMINT soldiers belong to the new 35M "HUMINT Collector"

military occupational specialty. Soldiers with this occupational specialty are trained both on how to interrogate and how to conduct source operations--tasks split previously between the 97B counterintelligence and 97E interrogation specialties. Thus, the addition of 3,000 35M HUMINT collectors is nearly equivalent to the addition of 3,000 of what used to be 97E interrogators and 3,000 97B counterintelligence agents.

Combat brigades have been the main beneficiaries of the Army's dramatic growth in HUMINT capability, though theater internment facilities have also benefitted. Unfortunately, despite the overall growth in HUMINT capability, the ability of divisions to manage HUMINT operations has declined. Below is a summary of major changes in interrogation-related force structure.

Tactical HUMINT Support. Direct support MI battalions are no longer organic to divisions. Instead, the headquarters units of these battalions have been inactivated, and the companies of these battalions have been task-organized with both HUMINT and SIGINT assets and assigned to the new "special troops battalions" of combat brigades. The MI companies now organic to combat brigades have a much greater HUMINT capability than the capability possessed by the direct-support MI companies of OIF I. As opposed to just four counterintelligence soldiers and three interrogators per MI company, each company now have three four-man HUMINT collection teams as well as a four-man OMT team.²⁶ Since all of these 16 personnel can either run sources or interrogate, each combat brigade is assigned more than four times the number of personnel who can lawfully run sources and more than five times the number of personnel who can lawfully interrogate than combat brigades had during OIF I. In fact, one combat brigade now has as many (or nearly as many) school-trained interrogators as all of TF 1AD had during

OIF I. What is more, each combat brigade now has its own four-man S2X section providing much-needed HUMINT expertise in Brigade S2 sections.

HUMINT Operational Cells. The HOC and HUMINT Analytical Cell of inactivated MI battalions have been reassigned to the headquarters of divisions. With this reassignment, divisions have lost some ability to effectively manage their HUMINT assets. For example, since the HOC now works for a staff officer (the Division G2) rather than a commander (the MI Battalion Commander), the HOC cannot directly task the HUMINT soldiers of subordinate brigades. Thus, it is often a struggle for the G2 and HOC to know what brigades are doing with regard to HUMINT operations. As recently stated by Lieutenant Colonel Godsil, the deputy G2 for the 1AD: "The loss of the direct support MI battalions takes the discussion of interrogation operations out of the command channel and puts it into the murky staff channels with the G2, PMO [Provost Marshal Officer] and IG [Inspector General] trying to figure out who is who [in the detention facilities of subordinate brigades]."²⁷ Similarly, a Division G2 lacks the ability to provide effective command and control of the HUMINT teams which are attached to a division and which may be performing a "general support" role for that division.²⁸

Division-Level Task Organization. In addition to being unable to adequately track Brigade HUMINT operations, a Division G2 now lacks the command authority to effectively task-organize subordinate HUMINT assets in support of the "division fight." If one brigade has a more violent sector or fewer organic HUMINT assets than another brigade, it is very difficult for the G2 to move HUMINT teams from one brigade to another brigade: almost invariably, subordinate brigade commanders fight the loss of valuable (and now organic) HUMINT teams. "The lack of an MI Battalion is disastrous

in terms of MI task organization and asset management," said Lieutenant Colonel Godsil. "Without the MI Commander and staff to prepare changes to task organization, the G2 (a staff wiener and probably the most junior primary staff officer) is stuck arguing against a BCT Commander in contact, which is not an equitable argument."²⁹

Joint Interrogation and Debriefing Center Battalions. Through 2005, the Army possessed only one battalion (the 202nd MI Battalion) that was designed to operate as a Joint Interrogation and Debriefing Center (JIDC).³⁰ Due to this uniqueness, the soldiers of 202nd MI Battalion spent 28 of the first 36 months of OIF deployed to Iraq.³¹ Since then, the Army activated its first formally designated JIDC battalion in January 2006.³² A total of four JIDC battalions (two active-duty and two reserve battalions) are projected to be activated. Once this occurs, the Army will possess the ability to surge more interrogators to support theater-level interrogation operations or, in the absence of such a surge, the ability to ensure JIDC soldiers deploy no more than once every three years.

Battlefield Surveillance Brigades. The Army has created a modular brigade in support of corps and/or division operations called the Battlefield Surveillance Brigade (BFSB). Each BFSB has a comparable HUMINT capability to that possessed by the 205th MI brigade, the brigade that supported CJTF-7 during OIF I. Whereas the 205th MI Brigade organically had two interrogation companies with 15 five-man interrogation teams each (a total of 150 interrogators), a BFSB has 35 four-man HUMINT teams (a total of 140 interrogators).³³ What is most significant here is not the capabilities of the BFSBs but the number of them: eight new MI battalions have been created to support the three active-duty BFSBs and the seven new national guard BFSBs.³⁴ Thus, if the U.S. Army were to engage in interrogation operations again on the scale these operations

occurred during OIF I, two to three supporting BFSBs and a JIDC battalion would not only possess a greater interrogation capability than possessed by the augmented 205th MI Brigade during OIF I, but this capability would be easily sustainable.

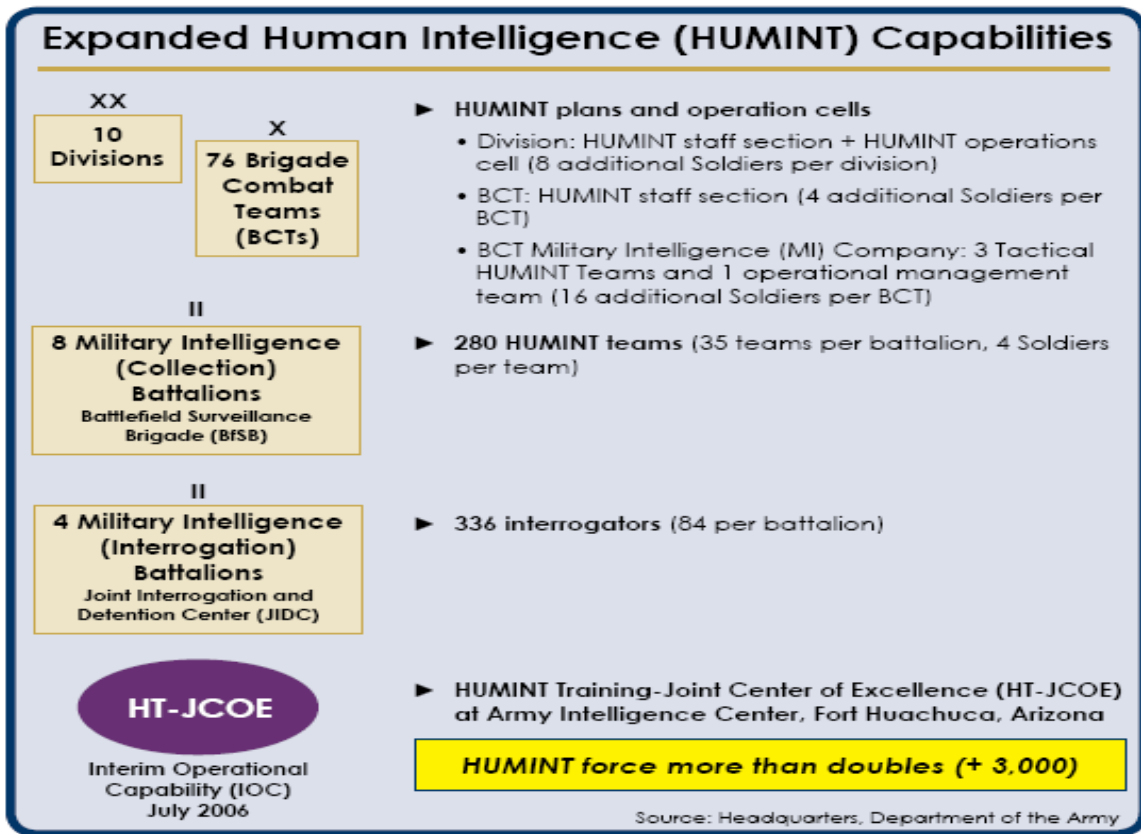

Figure 14. Increased MI Capability

Source: Association of the United States Army, "Torchbearer National Security Report," AUSA, July 2007, [http://www3.ausa.org/webpub/DeptILW.nsf/byid/JRAY-75LT2E/\\$File/TB-Intel.pdf?OpenElement](http://www3.ausa.org/webpub/DeptILW.nsf/byid/JRAY-75LT2E/$File/TB-Intel.pdf?OpenElement) (accessed April 24, 2009), 5.

Legal Support. The analysis of recent corps- and division-level unit manning documents (or MTOEs) shows that there has been no increase in the number of lawyers assigned to these units since OIF I. Hopefully, if the U.S. were to conduct again an

invasion such as the invasion of Iraq, Army leadership has learned that it would need to attach a large number of lawyers to the initial invasion and stabilization force, thus ensuring a more expeditious release of wrongly detained innocents. In turn, a quick release of innocents would help reduce the number of insurgents created by wrongful detention as well as, by reducing overcrowding in detention facilities, create the conditions for interrogators to operate more effectively.

Interrogator Experience. Although military interrogators today generally have less experience than their counterparts possessed during OIF I, the number of contract interrogators (who are normally older and more experienced) has dramatically increased in Iraq. At the end of OIF I, there were a total of 19 contract interrogators in Iraq.³⁵ Since then, the L-3 Corporation has signed a contract with the Army that requires the company to provide 306 interrogators, screeners, and intelligence analysts on 22 bases in Iraq.³⁶ It is unclear from unclassified sources how many of these employees are assigned as interrogators, but if at least one-third of these employees are interrogators (as seems likely), then there are at least five times as many contract interrogators on the ground in Iraq today as there were during OIF I. "Contract (L-3) interrogation teams did most of the heavy lifting in terms of the conduct of interrogation," stated Lieutenant Colonel Godsil in reference to the 1AD's October 2007 to December 2008 deployment to Iraq. "Most of the HCTs [HUMINT Collection Teams] were away from the detainee holding areas and focused on source operations."³⁷

Warrant Officers. Experienced and competent warrant officers played a critical role in ensuring interrogators performed their tasks in accordance with legal and doctrinal constraints during OIF I. Unfortunately, since it is much easier to "grow" interrogators

than it is to grow their warrant officer supervisors, the warrant officer supervisor-to-interrogator ratio is decidedly less favorable than it was during OIF I. For example, while Company A, 501st MI Battalion, was authorized both a counterintelligence warrant officer and an interrogation warrant officer for its seven-man HUMINT Section during OIF I, this MI company (which is now part of the Special Troops Battalion, 1st Brigade, 1AD) is only authorized one warrant officer for its entire 16-man HUMINT Section. Referring to the 1AD's recent deployment, Lieutenant Colonel Godsil said, "A lesson learned here is that MSO is a leadership intensive operation and more collectors does not necessarily mean more of better collection . . . Junior troops are stuck as HCT leaders, answering directly to a Rifle Battalion Commander, and the technical art of MSO suffers."³⁸

The Army is even having difficulty filling the reduced number of interrogation warrant officer slots it has: as of April 27, 2009, U.S. Recruiting Command identifies the interrogation warrant officer specialty (351M) and counterintelligence warrant officer specialty (351L) as two of nine specialties facing an "application shortage."³⁹ To fill this shortage, U.S. Recruiting Command is offering the "expanded warrant officer opportunity" of opening the two HUMINT warrant officer specialties to any enlisted soldier with the requisite rank and test scores.⁴⁰ This is a highly questionable "fix" and does not bode well for the short-term future of HUMINT operations. Ultimately, the Army may not be able to address this problem adequately until today's surge of 35M HUMINT collectors has gained enough rank and experience to become warrant officers.

Improving Professional Education and Training

The Army has improved professional education and training in all interrogation-related areas except one--ethical leadership. The points below summarize the key directions the Army has travelled with regard to interrogation-related training since OIF I.

HUMINT Training Joint Center of Excellence. The Army partnered with the Defense Intelligence Agency to establish the HUMINT Training Joint Center of Excellence at Fort Huachuca in April 2007.⁴¹ Three of this center's five courses are directly related to interrogation operations. The ten-week Joint Interrogations Certification Course ensures contract interrogators are trained to Army interrogation standards before they deploy;⁴² the five-week Defense Strategic Debriefing Course, which is open to officers, warrant officers, and non-commissioned officers in the counterintelligence and interrogation disciplines, teaches "techniques and methodologies for conducting strategic debriefings";⁴³ and the six-week Joint Analyst-Interrogator Collaboration Course, which is open only to warrant officers, trains "collectors and analysts to perform duties in a GWOT environment with advanced collector and analytical skills."⁴⁴

Although a significant improvement over the training that was available to interrogators and their leaders before OIF I, this center's influence is not as great as it should be due to the fact that this training is unit- rather than Army-directed training (the exception being the Joint Interrogation Certification Course, which is required training for all contract interrogators). Thus, the influence of this training extends only to those units whose leadership, deployment schedule, and funds allow for this training. "Once

you finish AIT," said CW3 John Groseclose, the DoD's HUMINT Collector of the Year for 2003. "The only additional training you can get as far as interrogations go is an interrogations course over at Huachuca. But, this course is difficult to get into because you have to pay for it, and there aren't a lot of units willing to foot the bill."⁴⁵

Pre-Deployment Training. The Army has initiated several pre-deployment training programs that have the potential (when utilized) to greatly enhance the effectiveness of interrogators. These programs include Project Foundry, Cultural Awareness Training, and Language Training. Project Foundry provides advanced skills training for MI soldiers about to deploy. There are nine permanent sites where this training occurs; however, units may also coordinate through the G3 Section of the U.S. Army Intelligence and Security Command for mobile training teams to deploy to the unit's home station.⁴⁶ The Army's new Culture Center, which opened on February 1, 2006, on Fort Huachuca, offers mobile training teams and a curriculum of up to 200 hours of regionally specific training in support of the GWOT.⁴⁷ The Army's expanded language program now includes the Army's extensive promulgation of the "Rosetta Stone" commercial language software, expanded support from mobile training teams to units, and the creation of eleven Defense Language Institute Foreign Language Center training support detachments to support enduring language training at unit home stations.⁴⁸

Ethics Education and Training. The Schlesinger Report recommends a "review of military ethics education" and says that a "professional ethics program" is needed to equip military leaders "with a sharper moral compass for guidance in situations often riven with conflicting moral obligations."⁴⁹ Unfortunately, the Army has neither

completed a review of military ethics education, nor implemented a professional ethics program.

Ethical training in Army units today looks much as it did during OIF I. In general, this training consists of uncertified instructors giving a non-standard "Army Values" brief once a year. Commonly, this brief includes a review of the doctrinal definitions that pertain to each Army Value as well as examples of leaders who exemplified (or did not exemplify) these values. Seldom does such training employ practical exercises to help troops reason through complex moral problems for themselves, and seldom does someone conduct this training who has received the professional education necessary to usefully guide troops toward ethical solutions.

Furthermore, school curriculum that makes a serious attempt at improving the ethical decision-making skills of Army leaders is rare. Nearly all Army officers, for example, attend Command and General Staff College, but the school provides few blocks of instruction related to improving ethical decision-making. This lack of attention is not the fault of any one college department, for all departments have subject matter in which they can introduce ethical vignettes. Instead, it is symptomatic of a lack of emphasis that still exists across our Army.

Key Conclusions

The U.S. Army has a tradition of rapid, successful innovation in the wake of defeat on the battlefield. In the five years since the Abu Ghraib scandal, the Army has lived up to this tradition by making dramatic improvements in its ability to conduct interrogation operations effectively and humanely. However, problems still remain. Of most concern, Army doctrine still relies on an "incomplete tool box" for helping Army

leaders solve real-world ethical dilemmas; the loss of an MI Battalion headquarters has adversely affected the ability of Army divisions to manage the "division fight;" the Army has been unable to produce experienced warrant officers as quickly as it has produced 35M HUMINT Collectors (which increases the chance that collectors will not receive proper guidance downrange); and the Army has failed to systematically review military ethics education and to implement a professional ethics program. In short, the Army's road since Abu Ghraib has been a sharp ascent, but the Army must climb further still.

¹Department of the Army, Field Manual 2-22.3, *Human Intelligence Collector Operations* (2006), 5-18.

²LTC Russell Godsil, *Email to Author: RE: RE: RE: Interview!* February 23, 2009.

³Department of the Army, Field Manual 2-22.3, *Human Intelligence Collector Operations* (2006), 5-21.

⁴*Ibid.*, 5-16.

⁵*Ibid.* As an example of a violation of "facility security," the manual states that an MP should not provide a detainee additional food at an interrogator's request if that detainee has been spitting food at guards.

⁶*Ibid.*, 4-3.

⁷Department of the Army, Field Manual 3-19.40, *Internment/Resettlement Operations* (Fort Leonard Wood: U.S. Government Printing Office, 2007), 4-3, 4-4.

⁸*Ibid.*, 4-3.

⁹*Ibid.*, 3-3.

¹⁰*Ibid.*, 4-1.

¹¹Department of the Army, Field Manual 3-19.40, *Internment/Resettlement Operations*, (2007), 2-5.

¹²*Ibid.*

¹³*Ibid.*, 2-3.

¹⁴Department of the Army, Field Manual 2-22.3, *Human Intelligence Collector Operations* (2006), 5-24.

¹⁵*Ibid.*, K-5.

¹⁶*Ibid.*, 5-14.

¹⁷*Ibid.*, 5-14, 5-15.

¹⁸*Ibid.*, 5-15.

¹⁹*Ibid.*, 5-27.

²⁰*Ibid.*

²¹Bill Dedman, "New Anti-Terror Weapon: Hand-held lie detector," *MSNBC*. April 9, 2008, <http://www.msnbc.msn.com/id/23926278> (accessed May 2, 2009).

²²*Ibid.*

²³*Ibid.*, 7-11.

²⁴Department of the Army, Field Manual 6-22, *Army Leadership: Competent, Confident, and Agile* (Washington, DC: U.S. Government Printing Office, 2006), 4-5.

²⁵Association of the United States Army, "Torchbearer National Security Report," *AUSA*. July 2007, [http://www3.ausa.org/webpub/DeptILW.nsf/byid/JRAY-75LT2E/\\$File/TB-Intel.pdf?OpenElement](http://www3.ausa.org/webpub/DeptILW.nsf/byid/JRAY-75LT2E/$File/TB-Intel.pdf?OpenElement) (accessed April 2009, 24), 5.

²⁶*Ibid.*

²⁷LTC Russell Godsil, *Email to Author: Re: Re: Douglas MacArthur & Your Points*, April 20, 2009.

²⁸LTC Russell Godsil, *Email: Re: Re: Interview!* February 19, 2009.

²⁹*Ibid.*

³⁰Lieutenant Colonel Dean Bland, *The Abu Ghraib Scandal: Impact on the Army Profession and the Intelligence Process*, Academic Research Paper, Carlisle Barracks, Carlisle, PA: U.S. Army War College, 2005, 20.

³¹*Ibid.*

³²Lieutenant Colonel Steve Iwicki, "CSA's Focus Area 16: Actionable Intelligence," *Military Intelligence Professional Bulletin*, January-March 2005: 51-53, 53.

³³Association of the United States Army, "Torchbearer," 5.

³⁴Command and General Staff College Department of Tactics, *Battlefield Surveillance Brigade*, Fort Leavenworth, Kansas, February 2009,

³⁵Department of the Army Inspector General, "Detainee Operations Inspection," 87.

³⁶Amnesty International, "Outsourcing Intelligence in Iraq." *Amnesty International USA*. December 2008, <http://www.amnestyusa.org/pmscs/corpwatch13rpt.pdf> (accessed April 25, 2009), 7.

³⁷LTC Russell Godsil, *Email: Re: Re: Interview!* February 19, 2009.

³⁸*Ibid.*

³⁹U.S. Army Recruiting Command, *Warrant Officer Recruiting Information Site*, April 20, 2009, <http://www.usarec.army.mil/hq/warrant/index.htm> (accessed April 27, 2009).

⁴⁰*Ibid.*

⁴¹Association of the United States Army, "Torchbearer," 6.

⁴²U.S. Army, *Army Training Requirements and Resources System: Information for Course 241-F4 (CT)*, August 19, 2008, [https://atrrs.army.mil/atrrscc/courseInfo.aspx?fy=2008&sch=307&crs=241-F4+\(CT\)&crstitle=JOINT+INTERROGATION+CERTIFICATION&phase=](https://atrrs.army.mil/atrrscc/courseInfo.aspx?fy=2008&sch=307&crs=241-F4+(CT)&crstitle=JOINT+INTERROGATION+CERTIFICATION&phase=) (accessed April 27, 2009).

⁴³U.S. Army, *Army Training Requirements and Resources System: Information For Course 3A-SI3Q/3C-ASI9N/241-ASIN*. April 1, 2009. <https://atrrs.army.mil/atrrscc/courseInfo.aspx?fy=2008&sch=307&crs=3A-SI3Q%2F3C-ASI9N%2F241-ASIN&crstitle=DOD+STRATEGIC+DEBRIEFING&phase=> (accessed April 27, 2009).

⁴⁴U.S. Army, *Army Training Requirements And Resources System: Information For Course 3A-F82/243-F30*, August 21, 2008, <https://atrrs.army.mil/atrrscc/courseInfo.aspx?fy=2008&sch=307&crs=3A-F82%2F243-F30&crstitle=JOINT+ANALYST-INTERROGATOR+COLLABORATION&phase=> (accessed April 27, 2009).

⁴⁵Major Douglas A. Pryer, "Interview with CW3 John Groeclose," 18.

⁴⁶Association of the United States Army, "Torchbearer," 6.

⁴⁷*Ibid.*, 12.

⁴⁸Ibid.

⁴⁹Schlesinger, Brown, Fowler, and Horner, 126.

CHAPTER 8

A TALE OF TWO CITIES

And so, to all the other peoples and governments who are watching today, from the grandest capitals to the small village where my father was born, know that America is a friend of each nation, and every man, woman and child who seeks a future of peace and dignity. And we are ready to lead once more.¹

— President Barack Obama,
Inaugural Address

My experiences have landed me in the middle of another war--one even more important than the Iraq conflict. The war after the war is a fight about who we are as Americans. Murderers like Zarqawi can kill us, but they can't force us to change who we are. We can only do that to ourselves.²

— Matthew Alexander,
Interrogator

In *A Tale of Two Cities*, Charles Dickens contrasted the horrors of Paris during the French Revolution with ordinary life in law-bound London. When drawing this contrast, Dickens chose the guillotine to symbolize the horrors of revolutionary Paris--horrors he describes as unleashed upon the aristocracy by the irrational fears and thirst for vengeance of the peasantry.

During OIF I, there were also two "cities," or schools of thought, on the use of harsh interrogation methods. One of these cities was dark and subterranean, lying concealed as it were beneath the classification caveats of "TOP SECRET" or "SECRET NOFORN."³ Those who dwelt in this city believed that the "ends justify the means," that is, if the end were noble enough, then they were obliged to extend the limits of what was legally permissible in order to achieve this end. Like the peasantry of Dickens' Paris, this city's dwellers were motivated by feelings of vengeance and fear--vengeance in the wake of deadly terrorist attacks and fears that, if they did not respond ruthlessly, even worse attacks might occur again. However, unlike the single image (the guillotine) that

symbolized the citizenry of Dickens' Paris, it was two U.S. interrogation facilities, Abu Ghraib and GTMO, which came to symbolize the denizens of this clandestine "city."

During OIF I, the citizens of this "city" occupied the highest levels of command. At the national level, President Bush was aware of his senior security advisors meeting on the issue of "enhanced interrogation techniques," and he approved of this discussion.⁴ Rumsfeld sanctioned interrogation techniques for GTMO that derived from the U.S. military's SERE schools--schools which, in training U.S. servicemembers how to resist torture, had adopted the methods of the Chinese Communist Army of the Korean War for eliciting false confessions from prisoners. Also, although not in the chain-of-command of military interrogators, CIA operatives influenced military interrogators, and these operatives interrogated in accordance with a January 28, 2003, memo which had been signed by George Tenet and which had approved the use of "enhanced," SERE-like interrogation techniques for up to 30 days.⁵

At the theater level, SERE techniques were approved for use in Afghanistan. These techniques then migrated to Iraq, where Lieutenant General Sanchez authorized the use of similar techniques on September 14, 2003. After October 10, 2003, Sanchez' policy was that only he could approve such techniques; however, due to a poorly written and promulgated policy memo, Sanchez' updated policy did not stop the blanket use of such techniques at a few CJTF-7 facilities. In fact, at some facilities, the use of these techniques would not stop until May of 2004.

Investigators have described the systemic use of SERE techniques at Abu Ghraib, Forward Operating Base Tiger (the 1st squadron/3ACR FOB in al Qaim), Camp Diamondback (the 2nd Brigade of the 101st Airborne Division FOB in Mosul), Camp

Honesty (the 2nd Brigade, 25th Infantry Division FOB near Kirkuk), and various special operations facilities.⁶ SERE techniques were also allegedly used for a brief time at CJTF-7's Camp Cropper, though the investigation into these charges occurred too late to potentially substantiate these allegations.⁷ Additionally, interrogators at the 4th Infantry Division's Forward Operating Base Pack Horse employed abusive SERE techniques on at least one detainee; however, a new command policy letter and decisive punishment seem to have prevented the use of SERE techniques from becoming systemic at this facility.⁸

Almost invariably, the use of SERE techniques during OIF I led to more serious detainee abuse and, in a few cases, strategic damage to the United States. This strategic damage included the energizing of the Iraqi insurgency and the loss of popular support for the war at home, and it nearly led to America's premature withdrawal from Iraq. What is more, this damage has been like a hydra that has continually grown new heads, as the adverse publicity surrounding the recent declassification of the CIA's harsh interrogation techniques from 2003 to 2005 has shown.

Yet, as terrible as these military and political effects have been, these effects do not represent the most pernicious effects of this damage. Troublingly, the Abu Ghraib and GTMO scandals as well as other similar media circuses (such as those surrounding Lieutenant Colonel Allen West and CW3 Lewis Welshofer) have tarnished the professional image of the U.S. soldier in the eyes of Americans.⁹ Mere months before this tarnishing, *Time Magazine* had named "The American Soldier" its "Man of the Year" for 2003. Now, it may be decades before U.S. soldiers again enjoy such uncritical support and lofty tribute at home. More troubling still, the extent of the psychological effects of interrogation abuse--on the abuser, on the abused, and on affected family

members--may negatively impact the lives of many Americans and Iraqis for decades to come. Although no psychologist, Lieutenant Colonel Hoepner probably expressed as eloquently as anyone the amorality of this predicament, saying, "I'm not sure any society has a right to turn a person into that kind of monster, even for a little while, not knowing how much of the monster will remain with them for the rest of their lives."¹⁰

It is frightening to think that, as extensive as this damage has been, this damage could have been far greater. The reason it was not worse was that the ends-justify-the-means mentality of one school of thought never represented the vantage point of most school-trained interrogators in Iraq. Instead, most of these interrogators resided morally within the "city upon the hill," a city which had been first envisioned by John Winthrop in 1630 and which had been given a firm foundation by America's founding fathers. In the Revolutionary War, leaders of the Continental Army and Congress had judged that it was not enough to win the war; they had "to win in a way that was consistent with the values of their society and the principles of their cause."¹¹ General George Washington had applied this ideal to the treatment of British and Hessian prisoners, adopting an uncommon policy of humanity. During the more than two centuries that have passed since the Revolutionary War, the U.S. Army's treatment of its enemies has been largely consistent with this tradition of humanity, with the Philippine-American War and various Indian wars representing racially motivated exceptions to this rule.¹²

Thanks to strong ethical leadership, the school-trained interrogators of TF 1AD were truly citizens of this higher "city." Furthermore, TF 1AD's interrogators were far from alone in this regard. Although the 101st Airborne Division had a facility at Camp Diamondback where SERE techniques (and worse abuse) occurred, there are no

indicators that SERE techniques were used at the score or so of other holding areas operated by this division. Similar conclusions can also be drawn regarding the vast majority of detention facilities operated by CJTF-7's other major subordinate commands. There are also no indicators that such theater-level camps as Camp Ashraf, Camp Whitford, or Camp Bucca systemically applied SERE or other abusive interrogation techniques. Thus, the numerous investigations into interrogation operations which followed the scandal at Abu Ghraib and which concluded that the vast majority of U.S. soldiers had not abused detainees were correct.

It is nonetheless profoundly disappointing that, if interrogation abuses were not commonplace during OIF I, they were at least far more common than they should have been. Thankfully, the U.S. Army has come a long way with regard to interrogation doctrine, force structure, and training since Abu Ghraib. The extent of the changes the Army has undergone in a very short time are truly impressive and a tribute to the U.S. Army's perhaps singular capability among the world's armies for rapid adaptation. However, the U.S. Army must continue to improve doctrine as well as the number and quality of its HUMINT soldiers, particularly its HUMINT warrant officers. The lack of an MI battalion commander and headquarters at the division-level has also presented significant challenges that need to be overcome.

In closing, we will return to the beginning. At the start of this history, an email exchange was recounted in which four Army leaders, faced with mounting U.S. casualties, took antithetical stands on the use of harsh interrogation techniques. Once three of these leaders agreed that it was time to "take the gloves off," they influenced interrogators to employ SERE interrogation techniques. The use of SERE techniques, in

turn, led to worse forms of detainee abuse. Conversely, one of the many MI units that did not abuse detainees was a unit with a leader who, like many other leaders of this same unit, chose to fight to keep soldiers on the moral high ground.

This brings us to the most critical point of this history. Since OIF I and the Abu Ghraib scandal, a myriad of inspectors and investigators have amassed an extremely lengthy list of reasons for detainee abuse. These reasons have ranged from a shortage of a certain resource to confusion over some item of doctrine or policy to soldiers being improperly trained for performing a specific task. Certainly, these various issues are important and need to be corrected. Consequently, during the course of this case study, we have uncovered and discussed many of these issues, as well as the Army's subsequent corrective actions.

However, the U.S. Army is in real danger of missing the forest for the trees, for most essentially, what was at the heart of any instance of interrogation abuse during OIF I was a leader (or leaders) making unethical decisions. In other words, leaders with flawed ethical decisionmaking skills were the *sine qua non* (or root) cause of interrogation abuse in Iraq. Thus, above all else, the Army needs to turn its attention to getting ethical training and professional education right. At stake is not just the Army's preventing such future strategic defeats as Abu Ghraib, which is important enough, but the Army's permanently solving what briefly became an existential crisis. This crisis arose when the denizens of a subterranean "city" grew far more influential than they should have grown. Although this city will always have its residents, this city is not where American soldiers belong.

American soldiers belong in the city upon the hill.

¹The White House, *President Barack Obama's Inaugural Address*, January 21, 2009, <http://www.whitehouse.gov/blog/inaugural-address/> (accessed April 27, 2009).

²Matthew Alexander, "I'm Still Tortured by What I Saw in Iraq."

³"NOFORN" is shorthand for "no foreign nationals."

⁴ABC News, *Full Transcript of ABC's Martha Raddatz Interview with President Bush*.

⁵Steven G. Bradbury, *Memorandum for John A. Rizzo, Senior Deputy General Counsel, Central Intelligence Agency*. May 30, 2005, http://luxmedia.vo.llnwd.net/o10/clients/aclu/olc_05302005_bradbury.pdf (accessed April 20, 2009), 7. An example of the media coverage of this recent declassification is Josh Meyer's and Gregg Miller's April 17, 2009, article in the *Los Angeles Times* titled "Memos Reveal Harsh CIA Interrogation Methods."

⁶Abuse at Forward Operating Base Tiger is described in Endnote 11 to Chapter 1. Declassified evidence regarding Camp Diamondback can be found in the Human Rights Watch report, "No Blood, No Foul." Also, one of the six substantiated incidents of abuse by school-trained interrogators that is listed in the Church Reports involves Camp Diamondback. The investigative report for this incident is located on http://www.aclu.org/torturefoia/released/032505/1081_1180.pdf. In the "Facts" section of this report, the investigating officer states that detainees "were being systematically and intentionally mistreated (heavy metal music, bullhorn, hit with water bottles, forced to perform repetitive physical exercises until they could not stand, having cold water thrown on them, deprived of sleep, and roughly grabbed off the floor when they could no longer stand)." The investigating officer also describes the SERE of "Dietary Management," namely, describing detainees being fed only "crackers & water." Three Navy Seals were later recommended for court martial for the death of a detainee at a facility co-located at Camp Diamondback; the medical examiner's report stated that, before his death, the detainee had been "hooded, sleep deprived, and subjected to hot and cold environmental conditions, including the use of cold water on his body and hood" (*No Blood, No Foul*, 47). In his book, "Fear Up Harsh," Tony Lagouranis described his experiences while stationed at Camp Diamondback from February to April 2004. According to Lagouranis, the chief warrant officer at the facility supervised the use of such SERE techniques as "sleep deprivation, exposure to severe cold, forced exercises and use of painful stress positions, use of guard dogs to intimidate blindfolded detainees, and use of loud music and strobe lights" (*No Blood, No Foul*, 41). The Camp Honesty interrogation plan is discussed in the Senate Armed Services Committee *Inquiry into the Treatment of Detainees in U.S. Custody*. However, while the use of a technique at the facility that is referred to as a SERE technique is described, it is not clear what is being described: detainees are placed in dark rooms, subjected to loud noise, and then touched with "string simulating sensors." (If these sensors are some kind of electric shock, this facility employed a form of abuse worse than anything applied at the U.S. military's SERE

schools.) Also, the systemic use of SERE techniques by an SMU Task Force is discussed in Chapter 3 of this paper. Finally, an investigation by Brigadier General Richard Formica into Combined Joint Special Operations Task Force-Arabian Peninsula indicates that this different special operations unit was systemically using SERE techniques until April 2004 in Iraq.

⁷See Chapter 4 regarding allegations of interrogation abuse at Camp Cropper.

⁸These incidents at Forward Operating Base Pack Horse and these conclusions are addressed in the AR 15-6 investigation at http://www.aclu.org/torturefoia/released/041905/6570_6668.pdf.

⁹LTC West, a battalion commander within the 4ID's 2nd Brigade, was relieved from command for an incident that occurred on August 20, 2003, when coercing intelligence from an unwilling detainee, LTC West watched five of his soldiers beat a detainee on the head and body, then he had taken the detainee outside, placed the detainee near a clearing barrel, and fired two shots into the clearing barrel.⁹ As a result of this incident, not only media pundits but also U.S. senators hotly debated the morality of LTC West's actions. Ultimately, in the midst of rancorous public debate, LTC West was allowed to retire rather than face a court martial.

¹⁰Nathan Hoepner, *Email to Author: "Re: Two More New Documents, Old Format,"* April 20, 2009.

¹¹David Hackett Fisher, *Washington's Crossing* (New York: Oxford University Press, 2004), 375.

¹²Numerous historical studies have highlighted the role racism has played in creating exceptions to this rule. See, for example, Wayne E. Lee's essay, "From Gentility to Atrocity: The Continental Army's Way of War," which contrasts the restraint shown by the Continental Army when fighting the British Army versus its brutality when fighting the Iroquois in 1779.

GLOSSARY

- Assign.** To place units or personnel in an organization where such placement is relatively permanent, and/or where such organization controls and administers the units or personnel for the primary function, or greater portion of the functions, of the unit or personnel. (FM 6-0)
- Attach.** The placement of units or personnel in an organization where such placement is relatively temporary. (FM 6-0)
- Battalion.** A unit consisting of two or more company-, battery-, or troop-sized units and a headquarters. (FM 3-90)
- Battle Captain.** The shift officer in charge within a command post, associated by position and not rank. The battle captain is located in the operations section of a command post and oversees the conduct of command post operations during his shift. (FM 1-02)
- Brigade.** A unit usually smaller than a division to which are attached groups and/or battalions and smaller units tailored to meet anticipated requirements. (FM 3-90)
- Civilian Internees.** Individuals who are detained or interned in the United States or in occupied territory for security reasons or protection. (FM 3-19.40)
- C/J/G/S2X:** The C/J/G/S2X is a staff element subordinate to the C/J/G/S2, is the primary advisor on HUMINT and CI, and is the focal point for all HUMINT and CI activities within a joint task force (J2X), an Army component task force (G2X) or a brigade combat team (BCT) (S2X). The 2X can be organic to the unit staff or can be attached or under operational control (OPCON) to the staff from another organization such as the theater MI brigade. The C/J/G/S2X is part of a coherent architecture that includes organic HUMINT assets and HUMINT resources from national, theater, and non-DOD HUMINT organizations. (FM 2-22.3)
- Command and Control.** The exercise of authority and direction by a properly designated commander over assigned and attached forces in the accomplishment of the mission. (FM 6-0)
- Corps.** The Army's largest tactical unit and the instrument by which higher echelons of command conduct maneuver at the operational level. (FM 3-90)
- Counterintelligence.** Information gathered and activities conducted to protect against espionage, other intelligence activities, sabotage, or assassinations conducted by or on behalf of foreign governments or elements thereof, foreign organizations, or foreign persons, or international terrorist activities. (FM 3-13)

Detainee. The term "detainee" means any person captured, detained, held, or otherwise under the control of DoD personnel (military, civilian, or contractor). Detainees may also include enemy combatants (lawful and unlawful), retained persons, and civilian internees. It does not include personnel being held for law enforcement purposes, except where the United States is the occupying power. (FM 3-19.40)

Division. A tactical unit/formation which combines in itself the necessary arms and services required for sustained combat, larger than a regiment/brigade and smaller than a corps. (FM 3-90)

Doctrine. Fundamental principles by which the military forces or elements thereof guide their actions in support of national objectives. It is authoritative but requires judgment in application. (FM 3-0)

Document Exploitation. The systematic extraction of information from documents either produced by the threat, having been in the possession of the threat, or that is directly related to the current or future threat situation for the purpose of producing intelligence or answering information requirements. This may be conducted in conjunction with human intelligence (HUMINT) collection activities or may be conducted as a separate activity. (FM 34-52)

Enemy Prisoners of War. An individual or group of individuals detained by friendly forces in any operational environment who meet the criteria as listed in Article 4 of the Geneva Convention Relative to the Handling of Prisoners of War. (FM 34-52)

Forward Operations Base. A base usually located in friendly territory that is established to extend command and control or communications or to provide support for training and tactical operations. (FM 100-25)

General Support. That support which is given to the supported force as a whole and not to any particular subdivision thereof. [Note: the Army designates general support as a "support relationship."] (FM 101-5)

Human Intelligence. A category of intelligence derived from information collected and provided by human sources. (FM 34-1.)

Human Intelligence Collector. A person who is trained to collect information from individuals (human intelligence sources) for the purpose of answering intelligence information requirements. (FM 34-52)

Human Intelligence Source. A person from whom information is collected for the purpose of producing intelligence. Human intelligence sources can include friendly, neutral, or hostile personnel. (FM 34-52)

Intelligence. The product resulting from the collection, processing, integration, analysis, evaluation, and interpretation of available information concerning foreign countries or areas. (FM 34-1)

Interrogation. Systematic effort to procure information by direct questioning of a person under the control of the questioner. (FM 34-52)

Law of War. That part of international law that regulates the conduct of armed hostilities. (FM 27-10)

Lawful Combatants. Lawful enemy combatants are persons entitled to protection under the *Geneva Conventions*, combatant immunity, or immunity from prosecution for their lawful acts as a belligerent. (FM 3-19.40)

Operational Control. Operational control is the authority to perform those functions of command over subordinate forces involving organizing and employing commands and forces, assigning tasks, designating objectives, and giving authoritative direction necessary to accomplish the mission. (FM 3-0)

Operation Order. A directive issued by a commander to subordinate commanders for the purpose of effecting the coordinated execution of an operation. Also called the five paragraph field order, it contains as a minimum a description of the task organization, situation, mission, execution, administrative and logistics support, and command and signal for the specified operation. (FM 101-5)

Operational Level of War. The level of war at which campaigns and major operations are planned, conducted, and sustained to accomplish strategic objectives within theaters or operational areas. (FM 3-0)

Priority Intelligence Requirements. Those intelligence requirements for which a commander has an anticipated and stated priority in his task of planning and decisionmaking. (FM 3-0)

Retained Persons. A special category for medical personnel and chaplains because of their special skills and training. These individuals may be retained by the detaining power to aid other detainees, preferably those of the armed forces to which they belong. (FM 3-19.40)

Rules of Engagement. Directives issued by competent military authority that delineate the circumstances and limitations under which United States forces will initiate and/or continue combat engagement with other forces encountered. (FM 3-07)

Screening. As it applies to human intelligence operations, the process of evaluating and selecting human and document sources based on pre-established criteria for the prioritized collection of information in support of command intelligence requirements. While screening is not in itself an information collection technique, it is vital to the rapid collection of information. (FM 34-52)

Secret NOFORN: Intelligence which is classified "Secret" and which cannot be shown to the citizens of any foreign country.

Signals Intelligence. Intelligence derived from communications, electronics, and foreign instrumentation signals. (FM 34-2)

Source. 1. A person, thing, or activity from which information is obtained. 2. In clandestine activities, a person (agent), normally a foreign national, in the employ of an intelligence activity for intelligence purposes. 3. In interrogation activities, any person who furnishes information, either with or without the knowledge that the information is being used for intelligence purposes. (FM 34-1)

Source Management. Processes and administrative procedures used to control, orchestrate, and deconflict all actions pertaining to individuals utilized by human intelligence collectors and counterintelligence special agents to obtain information requirements. (FM 34-52)

Special Operations Forces. Those Active and Reserve Component forces of the Military Services designated by the Secretary of Defense and specifically organized, trained, and equipped to conduct and support special operations. FM 100-25)

Stability Operations. Operations that promote and protect U.S. national interests by influencing the threat, political, and information dimensions of the operational environment through a combination of peacetime developmental, cooperative activities and coercive actions in response to crisis. (FM 3-0)

Standard Operating Procedures. A set of instructions covering those features of operations which lend themselves to a definite or standardized procedure without loss of effectiveness. The procedure is applicable unless ordered otherwise. (FM 6-0)

Strategic Level of War. The level of war at which a nation, often as a member of a group of nations, determines national or multinational (alliance or coalition) strategic security objectives and guidance, and develops and uses national resources to accomplish these objectives. (FM 3-0)

Tactical Level of War. The level of war at which battles and engagements are planned and executed to accomplish military objectives assigned to tactical units or task forces. (FM 3-0)

Task Force. A temporary group of units, under one commander, formed for the purpose of carrying out a specific operation or mission. (FM 1-02)

Task Organization. A temporary grouping of forces designed to accomplish a particular mission. (FM 3-0)

Techniques. The general and detailed methods used to perform assigned missions and functions, specifically, the methods of using equipment and personnel. (FM 3-90).

Unconventional Warfare. A broad spectrum of military and paramilitary operations, normally of long duration, predominantly conducted by indigenous or surrogate forces that are organized, trained, equipped, supported, and directed in varying degrees by an external source. It includes guerrilla warfare and other direct offensive, low visibility, covert, or clandestine operations, as well as the indirect activities of subversion, sabotage, intelligence activities, and evasion and escape. (FM 3-05.201)

Unlawful Enemy Combatants. Persons who are not entitled to combatant immunity and engage in acts against the United States or its coalition partners in violation of the laws and customs of war during armed conflict. (FM 3-19.40)

APPENDIX A
CHRONOLOGY

1949

8 Dec U.S. signs Geneva Conventions

1955

2 Aug U.S. Congress ratifies Geneva Conventions

1956

10 Aug Military UCMJ signed into laws

1992

28 Sep FM 34-52, *Intelligence Interrogation*, published

1994

21 Oct U.S. Congress ratifies "Torture Convention"

1996

29 Jul U.S. Congress passes War Crimes Act

1997

1 Oct Army Regulation 190-8, *Enemy Prisoners of War, Retained Personnel, Civilian Internees and other Detainees*, published

2001

20 Jan Inauguration of President George W. Bush

1 Aug FM 3-19.40, *Military Police Internment/Resettlement Operations*, published

11 Sep Al Qaeda terrorist attacks on America

Dec DoD General Counsel requests information regarding interrogation of detainees from JPRA

2002

19 Jan Secretary of Defense Donald Rumsfeld memo to Joint Chiefs of

Staff, "Status of Taliban and Al Qaeda," provides for withholding of Geneva protections for Taliban and al Qaeda detainees in the event of "military necessity"

7 Feb President Bush's memo to National Security Advisors, "Humane Treatment of al Qaeda and Taliban Detainees," provides for withholding of Geneva protections for Taliban and al Qaeda detainees in the event of "military necessity"

16-21 Mar Colonel Stuart Herrington inspects GTMO

Jul JPRA provides DoD General Counsel's office with SERE training extracts

14 Aug - 4 Sep Colonel John Custer inspects GTMO

11 Oct Major General Michael Dunlavey, GTMO commander, requests use of enhanced interrogation techniques at GTMO

2 Dec Rumsfeld provides blanket approval for the use of certain harsh interrogation techniques at GTMO

2003

15 Jan Rumsfeld rescinds blanket approval for the use of harsh interrogation techniques at GTMO, providing for approval on a case-by-case basis

7 Feb The 1AD is removed from the V Corps' invasion plan for Iraq

4 Mar The 1AD is officially notified that it will be deploying to Iraq to relieve the 3rd Infantry Division

9 Apr U.S. forces assume responsibility for Camp Freddy from British forces, renaming Iraq's first Theater Internment Facility "Camp Bucca"

14 Apr U.S. DoD declares end of major combat operations in Iraq

16 Apr Rumsfeld publishes memo that will be one of the primary source documents for CJTF-7's first interrogation policy

20 Apr U.S. led invasion of Iraq

May ICRC sends report to U.S. Central Command alleging 200 cases of detainee abuse at point of capture and temporary holding facilities

1 May Camp Cropper established at Baghdad International Airport

16-26 May 1AD assembles in Baghdad

29 May 1AD with attachments assumes military responsibility for Baghdad as "Task Force Baghdad"

14 Jun CJTF-7 established with Lieutenant General Ricardo Sanchez as commander

22 Jun Lieutenant Colonel Laurence Mixon assumes command of 501st MI Battalion, 1AD, from Lieutenant Colonel Kenneth Devan, and Devan assumes position of 1AD G2

30 Jun Brigadier General Janice Karpinski assumes command of the 800th MP Brigade

Early Jul ICRC sends working paper to U.S. Central Command alleging 50

3 Jul	cases of abuse in the intelligence section at Camp Cropper Ambassador Bremer approves use of Abu Ghraib Prison as a coalition holding facility
17 Jul	Brigadier General Martin Dempsey assumes command of TF 1AD
21 Jul	TF 1AD Fragmentary Order published that criminalizes the abuse of detainees within TF 1AD
End of Jul	TF 1AD DIF established
26 Jul - 2 Aug	CJTF-7 conducts Operation Victory Bounty
4 Aug	Coalitional Provisional Authority official re-opens Abu Ghraib prison
7 Aug	Jordanian Embassy bombing in Baghdad
14 Aug	CJTF-7 Deputy J2X sends email out to G2X personnel requesting a "wish list" of interrogation techniques
19 Aug	United Nations Headquarters bombing in Baghdad
20 Aug	Lieutenant Colonel Allen West, Commander of the 2-20th Field Artillery Battalion of the 4ID, fires a pistol near the head of a detainee during an interrogation
24 Aug	CJTF-7 publishes baseline order governing CJTF-7 detention and interrogation operations for OIF I
30 Aug	TF 1AD publishes baseline order governing TF 1AD detention and interrogation operations for OIF I
31 Aug - 9 Sep	Major General Geoffrey Miller, GTMO Commander, leads a survey team on intelligence, interrogation, and detention operations in Iraq
14 Sep	CJTF-7 headquarters publishes first CJTF-7 interrogation policy
25 Sep	British forces reassume temporary responsibility for Camp Bucca
Oct - Dec	Most serious detainee abuses occur at Abu Ghraib
1 Oct	Lieutenant General Sanchez' deadline for closing main Camp Cropper detention facility and consolidating all CJTF-7 interrogation operations at Abu Ghraib
11 Oct - 6 Nov	Major General Donald J. Ryder, Provost Marshall General of the Army, leads an inspection of detention facilities in Iraq
12 Oct	CJTF-7 headquarters publishes second CJTF-7 interrogation policy
23 Nov	Iraqi Major General Abed Mowhoush dies during interrogation by CW3 Lewis Welshofer on Forward Operating Base Tiger

2004

10 Feb	Acting Secretary of the Army, R.L. Brownlee, directs Lieutenant General Paul Mikolashek to investigate detainee operations across the Army
14 Feb	ICRC "Report on the Treatment by the Coalition Forces of Prisoners of War and Other Protected Persons by the Geneva Conventions in Iraq during Arrest Internment and Interrogation" published

6 Apr	TF 1AD relinquishes control of DIF to 1st Cavalry Division
15 Apr	Transition of Authority for Baghdad from TF 1AD to 1st Cavalry Division
28 Apr	CBS News breaks story of Abu Ghraib war crimes
13 May	Multi-National Force-Iraq issues interrogation policy requiring interrogators to use doctrinal approaches and techniques only
15 May	Multi-National Force-Iraq OPORD 04-01 inactivates CJTF-7 and activates Multi-National Force-Iraq and Multi-National Corps-Iraq
19 May	First two courts martial of the "Abu Ghraib Nine" begin; General John Abizaid, Lieutenant General Sanchez, Major General Miller, and Colonel Marc Warren testify before U.S. Senate Armed Services Committee about Abu Ghraib abuses
27 May	Taguba Report published
28 Jun	Coalition Provisional Authority dissolved
21 Jul	Mikolashek Report published
24 Aug	Schlesinger Report published
25 Aug	Fay/Jones Report published
10 Mar	Church Report published

2005

30 Dec	President Bush signs Detainee Treatment Act of 2005 (also known as the McCain Amendment) into law
--------	---

2006

Jan	Army activates first JIDC Battalion
1 Feb	Army's new Culture Center opens on Fort Huachuca
29 Jun	U.S. Supreme Court ruling, <i>Hamdan vs. Rumsfeld</i>
Sep	FM 2-22-3, <i>Human Intelligence Collector Operations</i> , published
17 Oct	President Bush signs Military Commissions Act of 2006 into law

2007

Apr	HUMINT Training Joint Center of Excellence established at Fort Huachuca
Sep	FM 3-19.40, <i>Internment/Resettlement Operations</i> , published

2008

12 Jun	U.S. Supreme Court ruling, <i>Boumediene et Al v. Bush, President of the United States, et Al</i>
--------	---

BIBLIOGRAPHY

Primary Sources

- 10th Military Police Detachment (CID). "CID Report of Investigation." *The Center for Public Integrity: The Abu Ghraib Supplementary Documents*. June 8, 2003. <http://www.publicintegrity.org/articles/entry/506/> (accessed January 12, 2009).
- 205th MI Brigade. "Annex 40 to Taguba Report, Joint Interrogation & Debriefing Center Briefing." *The Center for Public Integrity: The Abu Ghraib Supplementary Documents*. January 23, 2004. <http://www.publicintegrity.org/assets/pdf/Tag29.pdf> (accessed January 12, 2004).
- 4ID Staff Judge Advocate. "Documents provided by the 4th Infantry Division SJA." *American Civil Liberties Union: Torture FOIA*. May 12, 2004. <http://www.aclu.org/projects/foiasearch/pdf/DOD043552.pdf> (accessed March 22, 2009).
- 4th Infantry Division 15-6 Investigation. "Exhibit A (Email Correspondences)." *American Civil Liberties Union: Torture FOIA*. October 6, 2003. http://www.aclu.org/torturefoia/released/041905/6570_6668.pdf (accessed March 15, 2009).
- 4th Infantry Division Headquarters. "AR 15-6 Investigation." *American Civil Liberties Union: Torture FOIA*. August 24, 2003. http://www.aclu.org/torturefoia/released/041905/6570_6668.pdf (accessed February 20, 2009).
- 501st MP Platoon Leader. "Collection Point & Internment Facility Interview Questions." *American Civil Liberties Union: Torture FOIA*. March 23, 2004. <http://www.aclu.org/projects/foiasearch/pdf/DOD018576.pdf> (accessed March 23, 2009).
- 800th MP Brigade. "Order of Battle Slides (Annex 41 to Taguba Report)." *The Office of the Secretary of Defense and Joint Staff Reading Room*. February 2004. http://www.dod.mil/pubs/foi/detainees/taguba/ANNEX_041_ORDER_OF_BATTLE_SLIDES.pdf (accessed January 12, 2009).
- ABC News. *Full Transcript of ABC's Martha Raddatz Interview with President Bush*. April 11, 2008. <http://abcnews.go.com/Politics/Story?id=4634219&page=4> (accessed April 20, 2009).
- Alexander, Matthew. "I'm Still Tortured by What I Saw in Iraq." *The Washington Post*. November 30, 2008. <http://www.washingtonpost.com/wp-dyn/content/article/2008/11/28/AR2008112802242.html> (accessed April 22, 2009).
- Alexander, Matthew, and John R. Bruning. *How to Break a Terrorist: The U.S. Interrogators Who Used Brains, Not Brutality, To Take Down the Deadliest Man in Iraq*. New York: Free Press, 2008.

- Article 32 Hearing. "United States v. CW2 Williams, SFC Sommer and SPC Loper." *Washington Post*. December 2, 2004. http://www.washingtonpost.com/wp-srv/nation/documents/mowhoush_court_document.pdf (accessed March 21, 2009).
- Baker, Colonel Ralph O. "HUMINT-Centric Operations: Developing Actionable Intelligence in the Urban Counterinsurgency Environment." *Military Review* (March-April 2007): 12-21.
- Bradbury, Steven G. *Memorandum for John A. Rizzo, Senior Deputy General Counsel, Central Intelligence Agency*. May 30, 2005. http://luxmedia.vo.llnwd.net/o10/clients/aclu/olc_05302005_bradbury.pdf (accessed April 20, 2009).
- Bush, President George W. "Memorandum, Humane Treatment of al Qaeda and Taliban Detainees, February 7, 2002." *George Washington University's The National Security Archive*. <http://www.gwu.edu/~nsarchiv/NSAEBB/NSAEBB127/02.02.07.pdf> (accessed November 2, 2008).
- CJTF-7 Headquarters. "FRAGO 176 (Military Police Task Org Change and OIF I to OIF 2 Transition)." *American Civil Liberties Union: Torture FOIA*. February 1, 2004. <http://www.aclu.org/torturefoia/released/a29.pdf> (accessed January 12, 2009).
- . "FRAGO 749 to CJTF OPORD 03-036 (Annex 17 to Formica Report)." *The Office of the Secretary of Defense and Joint Staff Reading Room*. August 24, 2004. http://www.dod.mil/pubs/foi/detainees/formica_annexes_1.pdf (accessed January 13, 2009).
- . "Interrogation and Counter-Resistance Policy Memorandum, October 12, 2003." *American Civil Liberties Union: Torture FOIA*. <http://www.aclu.org/FilesPDFs/october%20sanchez%20memo.pdf> (accessed December 12, 2008).
- . "Interrogation and Counter-Resistance Policy Memorandum, September 14, 2003." *American Civil Liberties Union: Torture FOIA*. <http://www.aclu.org/FilesPDFs/september%20sanchez%20memo.pdf> (accessed November 2, 2008).
- CJTF-7 Staff. "Detention Summit Briefing to LTG Sanchez." Camp Victory, Iraq, August 11, 2003.
- Connors, Pete. "Interview with COL Ralph Baker." *Operational Leadership Experiences in the Global War on Terrorism*. November 11, 2005. <http://cgsc.cdmhost.com/cgi-bin/showfile.exe?CISOROOT=/p4013coll13&CISOPTR=126&filename=127.pdf> (accessed May 10, 2009).
- DeBatto, David. "Testimony of Former U.S. Army Counterintelligence Special Agent David DeBatto, previously assigned to 205th Military Intelligence Brigade under Colonel Thomas Pappas in 2003, for the German criminal procedure against DOD Donald Rumsfeld and others." *Republikanischer Anwaltinnen-und*

- Antwalteverein*. http://www.rav.de/download/Testimony_DeBatto.pdf (accessed January 10, 2009).
- Department of Defense. Directive Number 5100.77, *DoD Law of War Program*. Washington, DC: U.S. Government Printing Office, 1998.
- Department of the Army. Army Regulation 190-8, *Enemy Prisoners of War, Retained Personnel, Civilian Internees and Other Detainees*. Washington, DC: U.S. Government Printing Office, 1997.
- . Field Manual 1, *The Army*. Washington, DC: U.S. Government Printing Office, 2001.
- . Field Manual 2-22.3, *Human Intelligence Collector Operations*. Washington, DC: U.S. Government Printing Office, 2006.
- . Field Manual 3.0, *Operations*. Washington, DC: U.S. Government Printing Office, 2008.
- . Field Manual 3-19.40, *Internment/Resettlement Operations*. Fort Leonard Wood: U.S. Government Printing Office, 2007.
- . Field Manual 3-19.40, *Internment/Resettlement Operations*. Washington, DC: U.S. Government Printing Office, 2001.
- . Field Manual 3-24, *Counterinsurgency*. Washington, DC: U.S. Government Printing Office, 2006).
- . Field Manual 34-52, *Intelligence Interrogation*. Washington, DC: U.S. Government Printing Office, 1992.
- . Field Manual 6-22, *Army Leadership: Competent, Confident, and Agile*. Washington, DC: U.S. Government Printing Office, 2006.
- Department of the Army Inspector General. "Detainee Operations Inspection, July 21, 2004." *United States Department of Defense Detainees Investigations*. <http://www4.army.mil/ocpa/reports/ArmyIGDetaineeAbuse/DAIG%20Detainee%20Operations%20Inspection%20Report.pdf> (accessed November 2, 2008).
- Department of the Navy Inspector General. "Review of Department of Defense Detention Operations and Detainee Interrogation Techniques." *The Office of the Secretary of Defense and Joint Staff Reading Room, Detainee Related Documents*. March 7, 2005. http://www.dod.mil/pubs/foi/detainees/church_report_1.pdf (accessed February 10, 2009).
- Dorn, Marilyn. "Sixth Declaration of Marilyn A. Dorn, Information Review Officer, Central Intelligence Agency." *American Civil Liberties Union*. January 5, 2007.

- http://www.aclu.org/pdfs/safefree/20070110/cia_dorn_declaration_items_1_29_61.pdf (accessed February 10, 2009).
- Dunlavey, Major General Michael E. "Memorandum for Commander, United States Southern Command: Counter-Resistance Strategies." *George Washington University National Security Archive*. October 11, 2002. <http://www.gwu.edu/~nsarchiv/NSAEBB/NSAEBB127/02.10.11.pdf> (accessed January 17, 2009).
- Fast, Major General Barbara. "Highlights from Detainee 'Summit'." *Email Forwarded to Author from V Corps Historian*. Camp Victory, Baghdad, August 12, 2004.
- . "Sworn Statement of Barbara G. Fast, C2 for CJTF-7; Annex to Fay/Jones Report." *American Civil Liberties Union: Torture FOIA*. May 9, 2004. <http://www.aclu.org/torturefoia/search/searchdetail.php?r=814&q=> (accessed January 10, 2009).
- Fay, Major General George R. "AR 15-6 Investigation of the Abu Ghraib Detention Facility and 205th Military Intelligence Brigade." *United States Department of Defense Detainees Investigations*. August 25, 2004. <http://www.defenselink.mil/news/Aug2004/d20040825fay.pdf> (accessed March 20, 2009).
- Federal Document Clearing House. "Political/Congressional Transcript Wire: Donald H. Rumsfeld Holds Defense Department News Briefing, November 25, 2003." *AccessMyLibrary*. http://www.accessmylibrary.com/coms2/summary_0286-2787794_ITM (accessed December 5, 2008).
- Federal Document Clearing House, Senate Armed Services Committee. "Hearing on Treatment of Iraqi Prisoners, May 19, 2008." *American Civil Liberties Union: Torture FOIA*. <http://www.aclu.org/projects/foiasearch/pdf/DODDOA010336.pdf> (accessed December 9, 2008).
- Formica, Brigadier General Richard. "Article 15-6 Investigation of CJSOTF-AP and 5th SF Group Detention Operations." *The Office of the Secretary of Defense and Joint Staff Reading Room*. November 8, 2004. <http://www.dod.mil/pubs/foi/detainees/FormicaReportRelease.pdf> (accessed February 15, 2009).
- . "CJTF-7 Interrogation Techniques as of 30 May 04." *The Office of the Secretary of Defense and Joint Staff Reading Room: Formica Report Annexes, Part I*. November 8, 2004. http://www.dod.mil/pubs/foi/detainees/formica_annexes_1.pdf (accessed February 17, 2009).
- Garrity, Major Stacy. "Interview Conducted by Panel of Officers." *The Center for Public Integrity: Abu Ghraib Supplementary Documents*. February 14, 2004. <http://www.publicintegrity.org/articles/entry/506/> (accessed January 12, 2009).
- Godsil, LTC Russell. *Email to Author: Re: Re: Interview!* February 19, 2009.

- . *Email to Author: Re: Re: Douglas MacArthur & Your Points*. April 20, 2009.
- . *Email to Author: RE: RE: RE: Interview!* February 23, 2009.
- Headquarters, 1st Armored Division. "1 AD PAM 1-201 Command Inspection Checklist, September 2003." *American Civil Liberties Union: Torture FOIA*. <http://www.aclu.org/projects/foiasearch/pdf/DOD045364.pdf> (accessed December 12, 2008).
- Headquarters, 2nd Armored Cavalry Regiment. "15-6 Report of Investigation, Maltreatment of Detainees, July-August 2003." *American Civil Liberties Union: Torture FOIA*. http://www.aclu.org/torturefoia/released/032505/1781_1880.pdf (accessed December 12, 2008).
- . "Camp Duke Detainee Facility S.O.P., June 1, 2004." *American Civil Liberties Union: Torture FOIA*. http://www.aclu.org/torturefoia/released/032505/780_880.pdf (accessed December 12, 2008).
- . "Guidance on Minimum Standards for Brigade Holding Areas, August 13, 2003." *American Civil Liberties Union: Torture FOIA*. http://www.aclu.org/torturefoia/released/032505/780_880.pdf (accessed December 12, 2008).
- . "SEP 03 PPT Briefing/Laydown of Division Detention Operations." *American Civil Liberties Union: Torture FOIA*. September 2003. <http://www.aclu.org/projects/foiasearch/pdf/DOD043598.pdf> (accessed April 1, 2009).
- Headquarters, 2nd Brigade Combat Team. "2nd BCT Collective Accomplishments, May 12, 2003, through April 14, 2004." Flyer, Baghdad, Iraq, 2004.
- Headquarters, III Corps. "Verbatim Record of Trial, Specialist Jeremy Sivits, January 27, 2005." *American Civil Liberties Union: Torture FOIA*. <http://www.aclu.org/projects/foiasearch/pdf/DOD002393.pdf> (accessed December 12, 2008).
- . "Verbatim Record of Trial, Staff Sergeant Ivan Frederick, September 21, 2005." *American Civil Liberties Union: Torture FOIA*. <http://www.aclu.org/projects/foiasearch/pdf/DOD041193.pdf> (accessed December 12, 2008).
- Headquarters, Task Force 1st Armored Division. *Briefing: TF IAD Says Thanks to the United States*. Baghdad, July 2004.
- . "FRAGO 383A [General Order - Civilian or Detainee Maltreatment] to OPOD 03-215 (Iron Stability)." *American Civil Liberties Union: Torture FOIA*. July 21, 2003. <http://www.aclu.org/projects/foiasearch/pdf/DODDOA027333.pdf> (accessed April 1, 2009).
- Hensley, LTC Charles. "Narrative: Task Force 1AD May 2003 to July 2004." 2004.

- Hill, General James T. "Memorandum for Chairman of the Joint Chiefs of Staff; SUBJECT: Counter-Resistance Techniques." *George Washington University National Security Archive*. October 25, 2002. <http://www.gwu.edu/~nsarchiv/NSAEBB/NSAEBB127/02.10.25.pdf> (accessed January 17, 2009).
- Hipwell, Colonel Robert. "800th MP BDE Inaugural Jails/Justice/Jails Meeting with CPA 1000 hrs Thursday." *Email Forwarded to Author from V Corps Historian*. Camp Victory, Baghdad, July 3, 2003.
- Hoepner, LTC Nathan. *Email to Author, "Re: Interview!"* March 25, 2009.
- . *Email to Author: Re: Interview!* March 28, 2009.
- . *Email to Author: "Re: Stress Positions."* January 12, 2009.
- . *Email to Author: "Re: Two More New Documents, Old Format."* April 20, 2009.
- International Committee of the Red Cross. "Convention (III) Relative to the Treatment of Prisoners of War, 1949." *International Humanitarian Law -- Treaties & Documents*. August 12, 1949. <http://www.icrc.org/ihl.nsf/7c4d08d9b287a42141256739003e636b/6fef854a3517b75ac125641e004a9e68> (accessed February 10, 2009).
- . "Convention (IV) Relative to the Protection of Civilian Persons in Time of War." *International Humanitarian Law -- Treaties & Documents*. August 12, 1949. <http://www.icrc.org/ihl.nsf/7c4d08d9b287a42141256739003e636b/6756482d86146898c125641e004aa3c5> (accessed February 10, 2009).
- . *Geneva Conventions of 12 August 1949*. <http://www.icrc.org/ihl.nsf/WebSign?ReadForm&id=375&ps=P> (accessed December 12, 2008).
- . *International Humanitarian Law National Implementation, Implementing Laws & Regulations - By State*. <http://www.icrc.org/ihl-nat.nsf/WebLAW!OpenView&Start=1&Count=300&Expand=165#165> (accessed December 13, 2008).
- . "Report of the International Committee of the Red Cross (ICRC) on the Treatment by the Coalition Forces of Prisoners of War and Other Protected Persons by the Geneva Conventions in Iraq During Arrest, Internment and Interrogation, May 10, 2004." *GlobalSecurity.org: Military*. http://www.globalsecurity.org/military/library/report/2004/icrc_report_iraq_feb2004.htm (accessed January 16, 2009).
- . *The Geneva Conventions: the Core of International Humanitarian Law*. January 9, 2006. <http://www.icrc.org/Web/Eng/siteeng0.nsf/htmlall/genevaconventions> (accessed December 9, 2008).

- . "War Crimes, U.S. Code, Title 18, Chapter 118." *International Humanitarian Law National Implementation, Implementing laws & Regulations --By State*. August 21, 1996. <http://www.icrc.org/ihl-nat.nsf/6fa4d35e5e3025394125673e00508143/442ba359975b55a0c1256a460049a7f7!OpenDocument> (accessed February 10, 2009).
- Ives, Christopher. "Interview with MAJ Douglas Smith." *Operational Leadership Experiences in the Global War on Terrorism*. November 3, 2005. http://cgsc.cdmhost.com/cdm4/item_viewer.php?CISOROOT=/p4013coll13&CISOPTR=86&CISOBOX=1&REC=19 (accessed January 10, 2009).
- Jones, Lieutenant General Anthony R. "AR 15-6 Investigation of the Abu Ghraib Prison and 205th Military Intelligence Brigade." *United States Department of Defense Detainees Investigations*. August 25, 2004. <http://www.defenselink.mil/news/Aug2004/d20040825fay.pdf> (accessed March 20, 2009).
- Khaghani, Darius. "Conditional Release Program (Parole)." *Email Forwarded to Author from V Corps Historian*. Camp Victory, Baghdad, December 29, 2003.
- Kusnetz, Marc. "Torture on Trial -- HRF Observes Court Martial of Army Officer Accused in Death of Iraqi Major General." *Human Rights First*. January 13-17, 2006. http://www.humanrightsfirst.org/us_law/etn/trial/welshofer-011706.asp (accessed March 20, 2009).
- Lagouranis, Tony, and Allen Mikaelian. *Fear Up Harsh: An Army Interrogator's Dark Journey Through Iraq*. New York: Penguin Books Ltd., 2007.
- Lee, Lieutenant Colonel Natalie. "Army Regulation 15-6 Investigation into Alleged Mistreatment of EPWs and HVDs held at JIDC, Camp Cropper." *The Office of the Secretary of Defense and Joint Staff Reading Room*. January 23, 2004. http://www.dod.mil/pubs/foi/detainees/Lee_Report_release_dec07.pdf (accessed May 11, 2009).
- Lessard, Laurence. "Interview with LTC Paul Perrone." *Operational Leadership Experiences in the Global War on Terrorism*. March 28, 2007. <http://cgsc.cdmhost.com/cgi-bin/showfile.exe?CISOROOT=/p4013coll13&CISOPTR=813&filename=814.pdf> (accessed January 13, 2009).
- Mansoor, Peter R. *Baghdad at Sunrise*. New Haven & London: Yale University Press, 2008.
- McCool, John H. "Interview with CPT Amos Nelson." *Operational Leadership Experiences in the Global War on Terrorism*. March 2, 2006. http://cgsc.cdmhost.com/cdm4/item_viewer.php?CISOROOT=/p4013coll13&CISOPTR=468&CISOBOX=1&REC=1 (accessed January 10, 2009).

- . "Interview with LTC Wayne Sylvester," *Operational Leadership Experiences in the Global War on Terrorism*, October 10, 2005. http://cgsc.cdmhost.com/cdm4/item_viewer.php?CISOROOT=/p4013coll13&CISOPTR=65&CISOBOX=1&REC=2 (accessed January 10, 2009), 8.
- . "Interview with MAJ Art La Flamme." *Operational Leadership Experiences in the Global War on Terrorism*. September 13, 2006. <http://cgsc.cdmhost.com/cgibin/showfile.exe?CISOROOT=/p4013coll13&CISOPTR=286&filename=287.pdf#search=%22command%22> (accessed January 10, 2009).
- Miller, Major General Geoffrey. "Assessment of DoD Counterterrorism Interrogation and Detention Operations in Iraq." *American Civil Liberties Union: Torture FOIA*. September 9, 2003. <http://www.aclu.org/torturefoia/released/a20.pdf> (accessed January 11, 2009).
- Mora, Vice Admiral Alberto. "Statement of Alberto J. Mora." *U.S. Senate Committee on Armed Services*. June 17, 2008. <http://armed-services.senate.gov/statemnt/2008/June/Mora%2006-17-08.pdf> (accessed January 17, 2009).
- Odierno, Major General Raymond. "Treatment of Detainees in the Custody of U.S. Forces." *American Civil Liberties Union: Torture FOIA*. September 21, 2003. <http://www.aclu.org/projects/foiasearch/pdf/DOD043596.pdf> (accessed March 22, 2009).
- Pappas, Colonel Thomas. "Sworn Statement of Col, HHD, 205th MI Brigade, Annex to Fay/Jones/Kern Report." *American Civil Liberties Union: Torture FOIA*. May 14, 2004. http://www.aclu.org/torturefoia/released/030905/DOD616_653.pdf (accessed January 10, 2009).
- Pryer, Major Douglas A. "501st MI BTOC SOP." Standard Operating Procedures, Baghdad, November 3, 2003.
- . "Interview with Captain Nicole Lauenstein." *Operational Leadership Experiences in the Global War on Terrorism*. March 4, 2009. <http://cdm15040.contentdm.oclc.org/cgibin/showfile.exe?CISOROOT=/p4013coll13&CISOPTR=1454&filename=1457.pdf#search=%22Pryer%22> (accessed April 30, 2009).
- . "Interview with CW3 John Groeclose." *Operational Leadership Experiences in the Global War on Terrorism*. January 7, 2009. <http://cgsc.cdmhost.com/cgibin/showfile.exe?CISOROOT=/p4013coll13&CISOPTR=1429&filename=1431.pdf#search=%22Pryer%22> (accessed March 25, 2009).
- . "Interview with CW3 Kenneth Kilbourne." *Operational Leadership Experiences in the Global War on Terrorism*. December 21, 2008. http://cgsc.cdmhost.com/cdm4/item_viewer.php?CISOROOT=/p4013coll13&CISOPTR=1440&CISOBOX=1&REC=2 (accessed March 31, 2009).

- . "Interview with LTC (Ret.) Elizabeth Rogers." *Operational Leadership Experiences in the Global War on Terrorism*. January 11, 2009. http://cgsc.cdmhost.com/cdm4/item_viewer.php?CISOROOT=/p4013coll13&CISOPTR=1442&CISOBX=1&REC=4 (accessed March 5, 2009).
- . "Interview with LTC Larry Wilson." *Operational Leadership Experiences in the Global War on Terrorism*. January 30, 2009. http://cdm15040.contentdm.oclc.org/cdm4/item_viewer.php?CISOROOT=/p4013coll13&CISOPTR=1471&CISOBX=1&REC=3 (accessed April 30, 2009).
- . "Interview with LTC Mark Crisman." *Operational Leadership Experiences in the Global War on Terrorism*. January 27, 2009. http://cgsc.cdmhost.com/cdm4/item_viewer.php?CISOROOT=/p4013coll13&CISOPTR=1418&CISOBX=1&REC=2 (accessed February 13, 2009).
- . "Interview with LTC Nathan Hoepner." *Operational Leadership Experiences in the Global War on Terrorism*. February 2, 2009. http://cgsc.cdmhost.com/cdm4/item_viewer.php?CISOROOT=/p4013coll13&CISOPTR=1441&CISOBX=1&REC=6 (accessed April 1, 2009).
- . "Interview with LTC Russell Godsil." *Operational Leadership Experiences in the Global War on Terrorism*. December 20, 2008. http://cgsc.cdmhost.com/cdm4/item_viewer.php?CISOROOT=/p4013coll13&CISOPTR=1443&CISOBX=1&REC=7 (accessed March 30, 2009).
- . "Interview with MAJ Craig Martin." *Operational Leadership Experiences in the Global War on Terrorism*. December 21, 2008. http://cgsc.cdmhost.com/cdm4/item_viewer.php?CISOROOT=/p4013coll13&CISOPTR=1431&CISOBX=1&REC=9 (accessed April 10, 2009).
- . "Interview with Ms. Amanda Meyer." *Operational Leadership Experiences in the Global War on Terrorism*. January 5, 2009. http://cgsc.cdmhost.com/cdm4/item_viewer.php?CISOROOT=/p4013coll13&CISOPTR=1395&CISOBX=1&REC=10 (accessed April 1, 2009).
- Reagan, Ronald. *Farewell Address to the Nation*. January 11, 1989. <http://www.reaganfoundation.org/reagan/speeches/farewell.asp> (accessed February 10, 2009).
- Redacted. "Email from REDACTED to Briese, M.C. (Div13) (FBI)." *American Civil Liberties Union: Torture FOIA*. May 22, 2004. http://www.aclu.org/torturefoia/released/FBI.121504.4940_4941.pdf (accessed January 11, 2009).
- . "Sworn Statement of S-3, 205th MI Bde, V Corps; Annex to Fay/Jones/Kern Report." *American Civil Liberties Union: Torture FOIA*. May 24, 2004. <http://www.aclu.org/torturefoia/search/searchdetail.php?r=791&q=> (accessed January 12, 2009).

- Rumsfeld, Donald. "Action Memo, Counter-Resistance Techniques, December 2, 2002." *George Washington University's National Security Archive*. <http://www.gwu.edu/~nsarchiv/NSAEBB/NSAEBB127/02.12.02.pdf> (accessed December 12, 2008).
- . "Memorandum for Chairman of the Joint Chiefs of Staff, Status of Taliban and Al Qaeda, January 19, 2002." *George Washington University's The National Security Archives*. <http://www.gwu.edu/~nsarchiv/NSAEBB/NSAEBB127/02.01.19.pdf> (accessed December 12, 2008).
- . "Memorandum for the Commander, U.S. Southern Command, Subject: Counter-Resistance Techniques." *George Washington University's National Security Archives*. April 16, 2003. <http://www.gwu.edu/~nsarchiv/NSAEBB/NSAEBB127/03.04.16.pdf> (accessed January 17, 2009).
- . "Memorandum for the General Counsel of the Department of Defense; Subject: Detainee Interrogations." *George Washington University's National Security Archives*. January 15, 2003. <http://www.gwu.edu/~nsarchiv/NSAEBB/NSAEBB127/03.01.15b.pdf> (accessed January 19, 2009).
- Ryder, Major General Donald. "Report on Detention and Corrections Operations in Iraq." *American Civil Liberties Union: Torture FOIA*. November 6, 2003. <http://www.aclu.org/torturefoia/released/a19.pdf> (accessed February 15, 2009).
- Sabatino, Colonel Ralph. "Annex 47, Taguba Report." *The Center for Public Integrity: The Abu Ghraib Supplementary Documents*. February 10, 2004. <http://www.publicintegrity.org/assets/pdf/Abu16.pdf> (accessed January 12, 2009).
- Schlesinger, James R., Harold Brown, Tillie K. Fowler, and General Charles A. Horner. "Final Report of the Independent Panel to Review DoD Detention Operations, 23 August 2004." *United States Department of Defense Detainees Investigations*. <http://www.defenselink.mil/news/Aug2004/d20040824finalreport.pdf> (accessed November 2, 2008).
- U.S. Senate Armed Services Committee. "Inquiry into the Treatment of Detainees in U.S. Custody." *U.S. Senate Armed Services Committee*. November 20, 2008. http://armedservices.senate.gov/Publications/Detainee%20Report%20Final_April%202%202009.pdf (accessed May 2, 2009).
- Supreme Court of the United States. "Boumediene Et Al v. Bush, President of the United States, Et Al." *Supreme Court of the United States*. June 12, 2008. <http://www.supremecourtus.gov/opinions/07pdf/06-1195.pdf> (accessed February 10, 2009).
- . "Hamdan v. Rumsfeld, Secretary of Defense, Et. Al." *Supreme Court of the United States*. June 29, 2006. <http://www.supremecourtus.gov/opinions/05pdf/05-184.pdf#search=%22Salim%20Ahmed%20Hamdan%20and%20Supreme%20Court%20decision%22> (accessed February 10, 2009).

- Taguba, Major General Antonio. "AR 15-6 Investigation of the 800th Military Police Brigade, May 27, 2004." *American Civil Liberties Union: Torture FOIA*. <http://www.aclu.org/torturefoia/released/TR3.pdf> (accessed December 12, 2008).
- The White House. *President Barack Obama's Inaugural Address*. January 21, 2009. <http://www.whitehouse.gov/blog/inaugural-address/> (accessed April 27, 2009).
- U.S. Army. "165th MI Battalion Modified Table of Organization and Equipment." April 18, 2003.
- . "519th Modified Table of Organization and Equipment." October 17, 2001.
- . *Army Training Requirements and Resources System: Information for Course 241-F4 (CT)*. August 19, 2008. [https://atrrs.army.mil/atrrscc/courseInfo.aspx?fy=2008&sch=307&crs=241-F4+\(CT\)&crstitle=JOINT+INTERROGATION+CERTIFICATION&phase=](https://atrrs.army.mil/atrrscc/courseInfo.aspx?fy=2008&sch=307&crs=241-F4+(CT)&crstitle=JOINT+INTERROGATION+CERTIFICATION&phase=) (accessed April 27, 2009).
- . *Army Training Requirements And Resources System: Information For Course 3A-F82/243-F30*. August 21, 2008. <https://atrrs.army.mil/atrrscc/courseInfo.aspx?fy=2008&sch=307&crs=3A-F82%2F243-F30&crstitle=JOINT+ANALYST-INTERROGATOR+COLLABORATION&phase=> (accessed April 27, 2009).
- . *Army Training Requirements and Resources System: Information For Course 3A-SI3Q/3C-ASI9N/241-ASIN*. April 1, 2009. <https://atrrs.army.mil/atrrscc/courseInfo.aspx?fy=2008&sch=307&crs=3A-SI3Q%2F3C-ASI9N%2F241-ASIN&crstitle=DOD+STRATEGIC+DEBRIEFING&phase=> (accessed April 27, 2009).
- U.S. Army Recruiting Command. *Warrant Officer Recruiting Information Site*. April 20, 2009. <http://www.usarec.army.mil/hq/warrant/index.htm> (accessed April 27, 2009).
- U.S. Government Accountability Office. "299317; B-299317.2; B-299317.3, L-3 Communications Titan Corporation." *GAO*. March 29, 2007. <http://www.gao.gov/decisions/bidpro/299317.htm> (accessed April 26, 2009).
- U.S. Senate Armed Services Committee. "Inquiry into the Treatment of Detainees in U.S. Custody." *U.S. Senate Armed Services Committee*. November 20, 2008. http://armedservices.senate.gov/Publications/Detainee%20Report%20Final_April%202%202009.pdf (accessed May 2, 2009).
- Unidentified Investigating Officer. "Memo for Record--Evidence." *American Civil Liberties Union: Torture FOIA*. February 4, 2004. <http://www.aclu.org/projects/foiasearch/pdf/DOD043571.pdf> (accessed March 22, 2009).

United Nations. "Convention Against Torture and Other Cruel or Degrading Treatment or Punishment." *Office of the United Nations High Commissioner for Human Rights*. <http://untreaty.un.org/english/treatyevent2001/pdf/07e.pdf> (accessed December 12, 2008).

United States Army Criminal Investigation Command. "CID Report of Investigation." *American Civil Liberties Union: Torture FOIA*. August 3, 2004. <http://www.aclu.org/projects/foiasearch/pdf/DODDOACID004133.pdf> (accessed March 22, 2009).

United States of America. *Torture, U.S. Code, Title 18, Chapter 113C*. April 30, 1994. <http://www.icrc.org/ihl-nat.nsf/> (accessed January 20, 2009).

Unknown CJTF J2 Planner. "Sworn Statement of LTC, G2 planner for V Corps/CJTF-7; Annex to Fay/Jones/Kern Report." *American Civil Liberties Union: Torture FOIA*. July 16, 2004. <http://www.aclu.org/torturefoia/search/searchresults2.php> (accessed January 10, 2009).

Warren, Colonel Marc. "Sworn Statement of Col, OSJA, MNF-I (senior Legal Advisor to LTG Sanchez)." *American Civil Liberties Union: Torture FOIA*. June 18, 2004. <http://www.aclu.org/torturefoia/search/searchdetail.php?r=811&q=> (accessed January 16, 2009).

Winthrop, Roger. "1630 Sermon." In *Speeches that Changed the World*, edited by Owen Collins, 63-65. Westminster: John Knox Press, 1999.

Wood, Captain Carolyn. "Interrogation Rules of Engagement." *American Civil Liberties Union: Torture FOIA*. Oct-Dec 2003. <http://www.aclu.org/projects/foiasearch/pdf/DODDOA003220.pdf> (accessed April 30, 2009).

———. "Sworn Statement of CPT, 519th MI BN; Annex to Fay/Jones/Kern Report." *American Civil Liberties Union: Torture FOIA*. May 21, 2004. <http://www.aclu.org/projects/foiasearch/pdf/DOD000598.pdf> (accessed January 10, 2009).

Secondary Sources

1st Armored Division Headquarters. *1st Armored Division History*. <http://www.1ad.army.mil/History.htm> (accessed March 23, 2009).

ABC News. *The Blotter: Secret U.S. Task Force 145 Secretly Changes Its Name, Again*. June 12, 2006. http://blogs.abcnews.com/theblotter/2006/06/secret_us_task_.html (accessed February 17, 2009).

Amnesty International. "Outsourcing Intelligence in Iraq." *Amnesty International USA*. December 2008. <http://www.amnestyusa.org/pmscs/corppwatchl3rpt.pdf> (accessed April 25, 2009).

- Armed Forces Press Service. *Insurgents Attack Abu Ghraib Prison, Kill Detainee*. September 21, 2004. <http://www.defenselink.mil/news/newsarticle.aspx?id=25250> (accessed January 16, 2009).
- Association of the United States Army. "Torchbearer National Security Report." *AUSA*. July 2007. [http://www3.ausa.org/webpub/DeptILW.nsf/byid/JRAY-75LT2E/\\$File/TB-Intel.pdf?OpenElement](http://www3.ausa.org/webpub/DeptILW.nsf/byid/JRAY-75LT2E/$File/TB-Intel.pdf?OpenElement) (accessed April 2009, 24).
- Bigelow, Bruce V. "Iraq: 136 Titan Corp. Workers Killed Since Iraq War Began." *CorpWatch: The San Diego Union-Tribune*. March 25, 2005. <http://www.corpwatch.org/article.php?id=12000> (accessed April 25, 2009).
- Bland, Lieutenant Colonel Dean. *The Abu Ghraib scandal: Impact on the Army Profession and the Intelligence Process*. Academic Research Paper, Carlisle Barracks, Carlisle, PA: U.S. Army War College, 2005.
- Brinkley, Joel, and Eric Schmitt. "U.S. Officers in Iraq Found Few Signs of Infiltration by Foreign Fighters." *The New York Times*. November 19, 2003. <http://query.nytimes.com/gst/fullpage.html?res=950CE1DA163BF93AA25752C1A9659C8B63> (accessed December 5, 2008).
- CBS News. *Abuse of Iraqi POWs by GIs Probed*. April 28, 2004. <http://www.cbsnews.com/stories/2004/04/27/60II/main614063.shtml> (accessed December 5, 2008).
- Command and General Staff College Department of Tactics. *Battlefield Surveillance Brigade*. Fort Leavenworth, Kansas, February 2009.
- Coon, Charlie. "'Stability Operation' Turned into 15-Month Street Fight." *Stars and Stripes*, September 2004: 5-16.
- Cordesman, Anthony H., and Arleigh A. Burke. "Iraq's Evolving Insurgency: The Nature of Attacks and Patterns and Cycles in the Conflict, February 3, 2006." *Center for Strategic & International Studies*. http://www.csis.org/index.php?option=com_csis_pubs&task=view&id=2696 (accessed December 4, 2008).
- Dedman, Bill. "New Anti-Terror Weapon: Hand-held Lie Detector." *MSNBC*. April 9, 2008. <http://www.msnbc.msn.com/id/23926278> (accessed May 2, 2009).
- Estes, Kenneth W. *U.S. Army Soldier Baghdad 2003-04*. Oxford: Osprey Publishing Ltd., 2007.
- Ewing, Scott Andrew. "Discipline, Punishment, and Counterinsurgency." *Military Review* (September-October 2008): 10-20.
- Fisher, David Hackett. *Washington's Crossing*. New York: Oxford University Press, 2004.

- GlobalSecurity.Org. *Camp Ashraf MEK Training Camp*. <http://www.globalsecurity.org/military/world/iraq/camp-ashraf.htm> (accessed January 10, 2009).
- Greenburg, Jan Crawford, Howard L. Rosenberg, and Ariane de Vogue. *ABC News: Bush Aware of Advisers' Interrogation Talks*. April 11, 2008. <http://abcnews.go.com/TheLaw/LawPolitics/Story?id=4635175&page=1> (accessed January 11, 2009).
- Hajjar, Remi. "The Army's new TRADOC Culture Center." *Military Review* (November-December 2006).
- Hashim, Ahmed S. *Insurgency and Counter-Insurgency in Iraq*. Ithaca: Cornell University Press, 2006.
- Hoffman, Bruce. "Insurgency and Counterinsurgency in Iraq." *Rand National Security Research Division*. June 2004. http://www.rand.org/pubs/occasional_papers/2005/RAND_OP127.pdf (accessed January 10, 2008).
- Holguin, Jaime. *CBS News: FBI Memos Describe Prison Abuses*. December 21, 2004. <http://www.cbsnews.com/stories/2004/12/04/iraq/main659101.shtml> (accessed January 11, 2009).
- Holland, Keating. *CNN, Poll: Support for Bush, Iraq war dropping*. May 22, 2004. <http://www.cnn.com/2004/ALLPOLITICS/05/14/bush.kerry/index.html> (accessed December 12, 2008).
- Human Rights Watch. "No Blood, No Foul." *Human Rights Watch*. July 2006. <http://www.hrw.org/en/reports/2006/07/22/no-blood-no-foul-0> (accessed February 17, 2009).
- Isikoff, Michael. "'We Could Have Done This the Right Way'." *Newsweek*, May 4, 2009: 18-21.
- Iwicki, Lieutenant Colonel Steve. "CSA's Focus Area 16: Actionable Intelligence." *Military Intelligence Professional Bulletin*, January-March 2005: 51-53.
- Lee, Wayne E. "From Gentility to Atrocity: The Continental Army's Ways of War." *Army History: The Professional Bulletin of Army History*, Winter 2006: 3-19.
- Lopez, C. Todd. "Language Company First in Army." *ARMY.MIL/NEWS*. October 22, 2008. <http://www.army.mil/-news/2008/10/22/13503-language-company-first-in-army/> (accessed April 27, 2009).
- Meyer, Josh, and Gregg Miller. "Memos Reveal Harsh CIA Interrogation Methods." *Los Angeles Times*. April 17, 2009. <http://www.latimes.com/news/nationworld/nation/la-na-interrogation17-2009apr17,0,5555846.story?page=2> (accessed April 21, 2009).

- Riccardi, Nicholas. *Los Angeles Times: Interrogator Convicted in Iraqi's Death*. January 22, 2006. <http://articles.latimes.com/2006/jan/22/nation/na-interrogate22> (accessed February 20, 2009).
- Ricks, Thomas E. *Fiasco: The American Military Adventure in Iraq*. New York: The Penguin Press, 2006.
- Schmitt, Eric. *The New York Times: Pentagon Study Describes Abuse by Units in Iraq*. June 17, 2006. <http://www.nytimes.com/2006/06/17/washington/17formica.html?ex=1308196800&> (accessed February 17, 2009).
- Schmitt, Eric, and Carolyn Marshall. *New York Times: In Secret Unit's 'Black Room,' a Grim Portrait of U.S. Abuse*. March 19, 2006. http://www.nytimes.com/2006/03/19/international/middleeast/19abuse.html?_r=2&pagewanted=1 (accessed February 17, 2009).
- Shamsi, Hina. "Command's Responsibility: Detainee Deaths in U.S. Custody in Iraq and Afghanistan." *Human Rights First*. Edited by Deborah Pearlstein. February 2006. <http://www.humanrightsfirst.info/pdf/06221-etn-hrf-dic-rep-web.pdf> (accessed March 20, 2009).
- Warden, Leon. *The Signal: Karpinski: Rumsfeld OK'd Methods at Abu Ghraib*. July 2, 2004. <http://www.scvhistory.com/scvhistory/signal/iraq/sg070204.htm> (accessed December 12, 2008).
- White, Josh. "Documents Tell of Brutal Improvisation by GIs." *Washington Post*. August 3, 2005. http://www.washingtonpost.com/wp-dyn/content/article/2005/08/02/AR2005080201941_pf.html (accessed March 22, 2009).
- Wright, Dr. Donald P., and Colonel Timothy R. Reese. *On Point II, Transition to the New Campaign: the United States Army in Operation IRAQI FREEDOM, May 2003 - January 2005*. Fort Leavenworth: Combat Studies Institute Press, 2008.
- Zakaria, Fareed. "Pssst . . . Nobody Loves a Torturer." *Newsweek*. November 14, 2005. <http://www.fareedzakaria.com/ARTICLES/newsweek/111405.html> (accessed April 11, 2009).

INITIAL DISTRIBUTION LIST

Combined Arms Research Library
U.S. Army Command and General Staff College
250 Gibbon Ave.
Fort Leavenworth, KS 66027-2314

Defense Technical Information Center/OCA
825 John J. Kingman Rd., Suite 944
Fort Belvoir, VA 22060-6218

Dr. Jonathan House
Department of History
USACGSC
100 Stimson Ave.
Fort Leavenworth, KS 66027-2301

Lieutenant Colonel Nathan Hoepner
J2, Plans and Exercises
NATO Joint Force Command Naples
PSC 813 Box 134
FPO AE 09620

Lieutenant Colonel Russell Godsil
G2, Deputy
1st Armored Division
Unit 29623
APO AE 09096

CW3 Kenneth Kilbourne
5225 Cedar Springs Drive
Sierra Vista, AZ
85635

David Roeder
Department of Tactics
USACGSC
100 Stimson Ave.
Fort Leavenworth, KS 66027-2301

Lieutenant Colonel Gregory Ellsworth
Chief, U.S. Student Division
USACGSC
100 Stimson Ave.
Fort Leavenworth, KS 66027-2301

Mark Tolmachoff
Department of Tactics
USACGSC
100 Stimson Ave.
Fort Leavenworth, KS 66027-2301

Bob King
Department of Joint, Interagency and Multinational Operations
USACGSC
100 Stimson Ave.
Fort Leavenworth, KS 66027-2301

Lieutenant Colonel Brian Freidhoff
Department of Leadership
USACGSC
100 Stimson Ave.
Fort Leavenworth, KS 66027-2301

John McCool
Combat Studies Institute
ATTN: ATZL-CSH
201 Sedgwick
Fort Leavenworth, KS 66027

Dr. Donald Wright
Combat Studies Institute
ATTN: ATZL-CSH
201 Sedgwick
Fort Leavenworth, KS 66027

Dr. Peter Mansoor
Chair of Military History
Room 125A, Mershon Center for International Security Studies
1501 Neil Avenue
Columbus, OH 43201

Colonel Laurence Mixon
Commander, 513th MI Brigade
Bldg. 21710
Fort Gordon, GA 30905

Lieutenant Colonel Daniel Miller
Commander, Milwaukee Recruiting Battalion
11100 W. Liberty Drive, Suite 200
Milwaukee, WI 53224

Chief Warrant Officer 3 John Groseclose
G2X, 101st Abn Div (AASLT)
2700 Indiana Ave
Ft Campbell, KY 42223

Dr. Roger Silver
145 Fell Street, Apartment 502
San Francisco, CA 94102

Wayne Pryer
3660 South Cox Avenue, Apartment 502
Springfield, MO 65807-6913