

Salottobuono

ESINO LARIO

VIABILITÀ

BOZZA 23062010

*“ . . . in that Empire, the Cartographer’s art achieved such a degree of perfection that the **Map** of a single Province occupied an entire City, and the **Map** of the Empire, an entire Province. In time, these vast Maps were no longer sufficient. The Guild of Cartographers created a **Map** of the Empire, which perfectly coincided with the Empire itself. But Succeeding Generations, with diminished interest in the Study of Cartography, believed that this immense **Map** was of no use, and not Impiously, they abandoned it to the Inclemency of the Sun and of numerous Winters. In the Deserts of the West ruined Fragments of the **Map** survive, inhabited by Animals and Beggars; in all the Country there is no other Relic of the Geographical Disciplines.”*

(from Viajes de Varones Prudentes, Suárez Miranda, book IV, chap. XIV, Lérida, 1658. Quoted by Jorge Luis Borges, Historia universal de la infamia “Etcetera,” Buenos Aires, 1935).

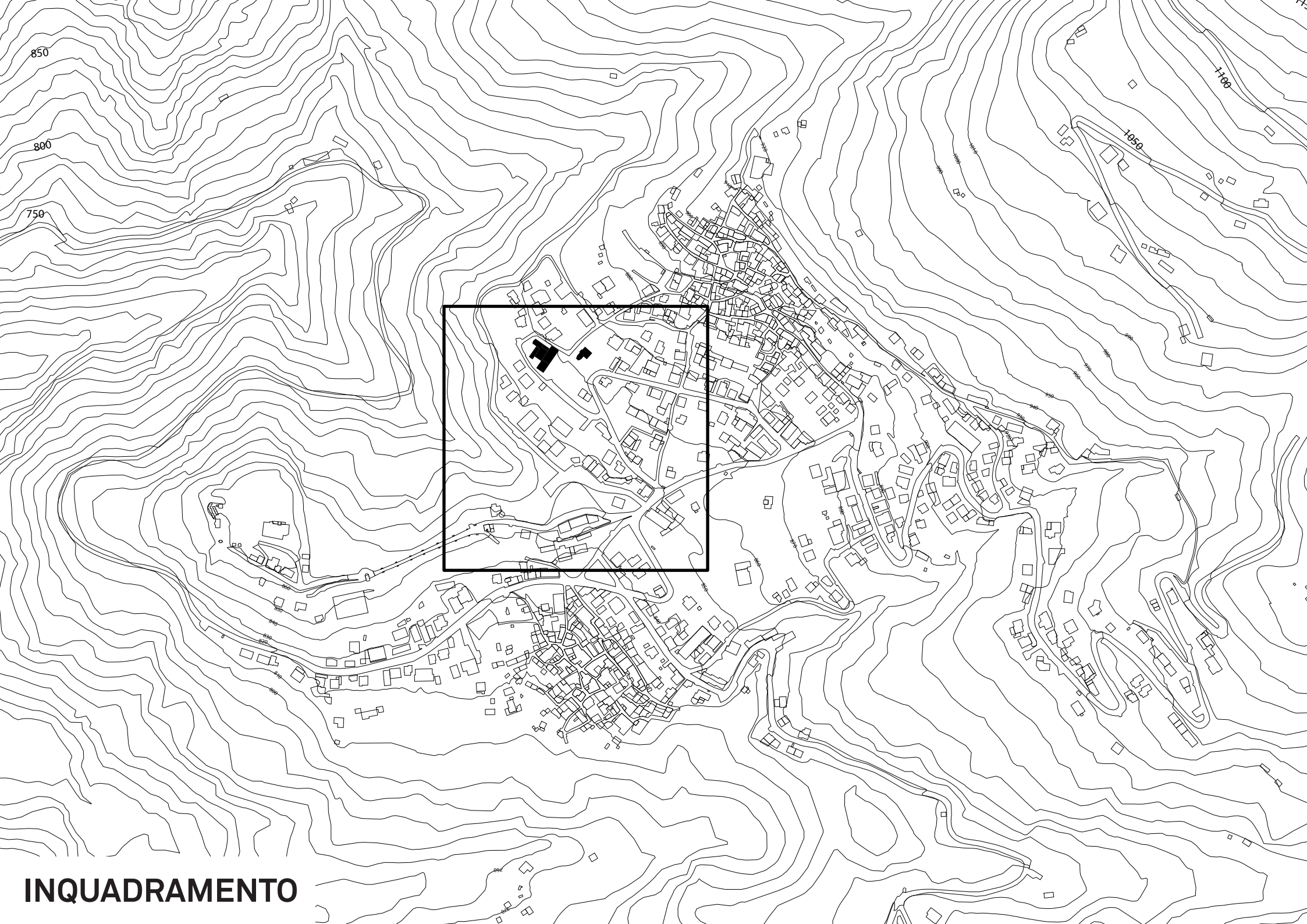

INQUADRAMENTO

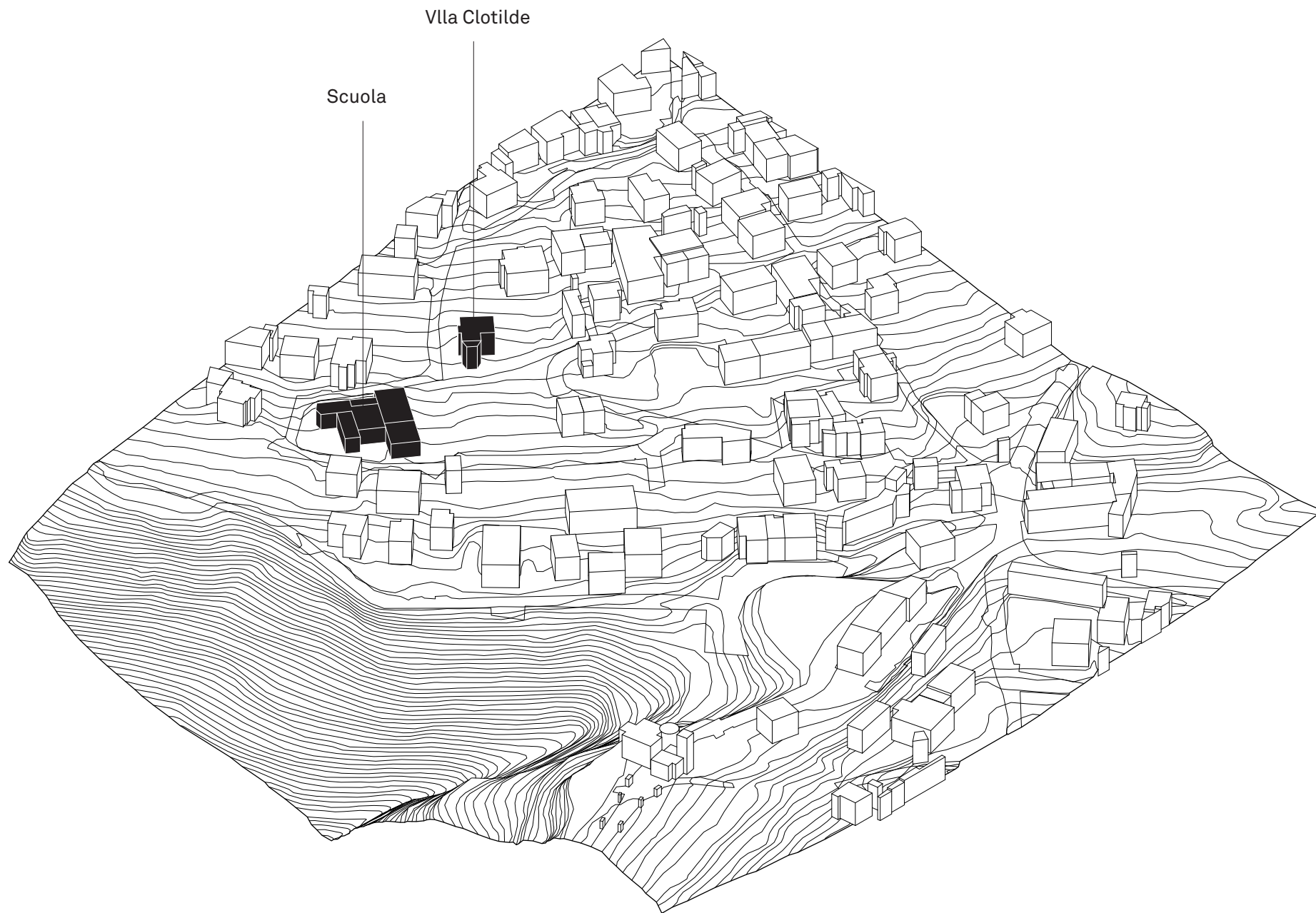

APPROFONDIMENTO

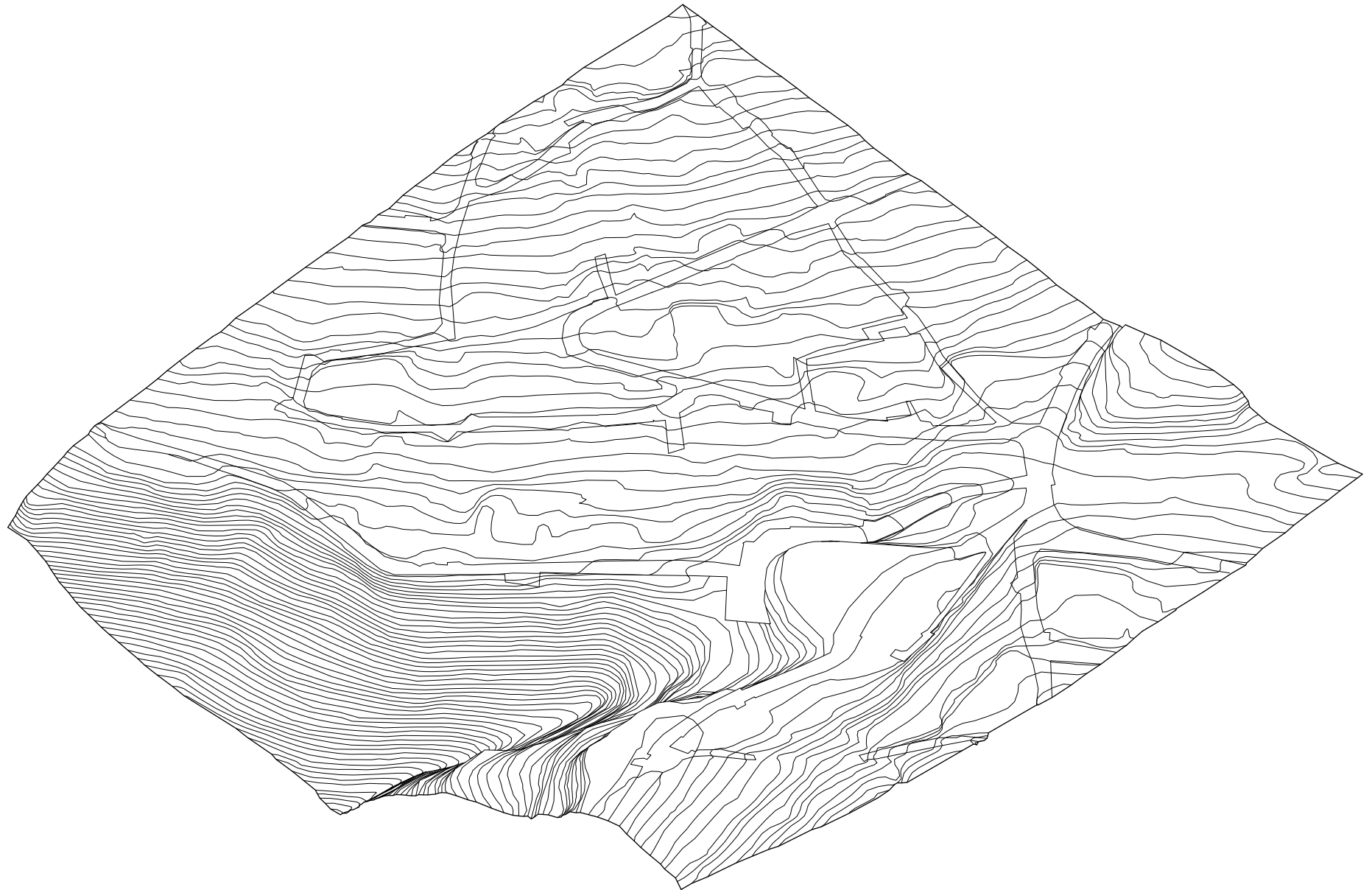

APPROFONDIMENTO - ALTIMETRIA

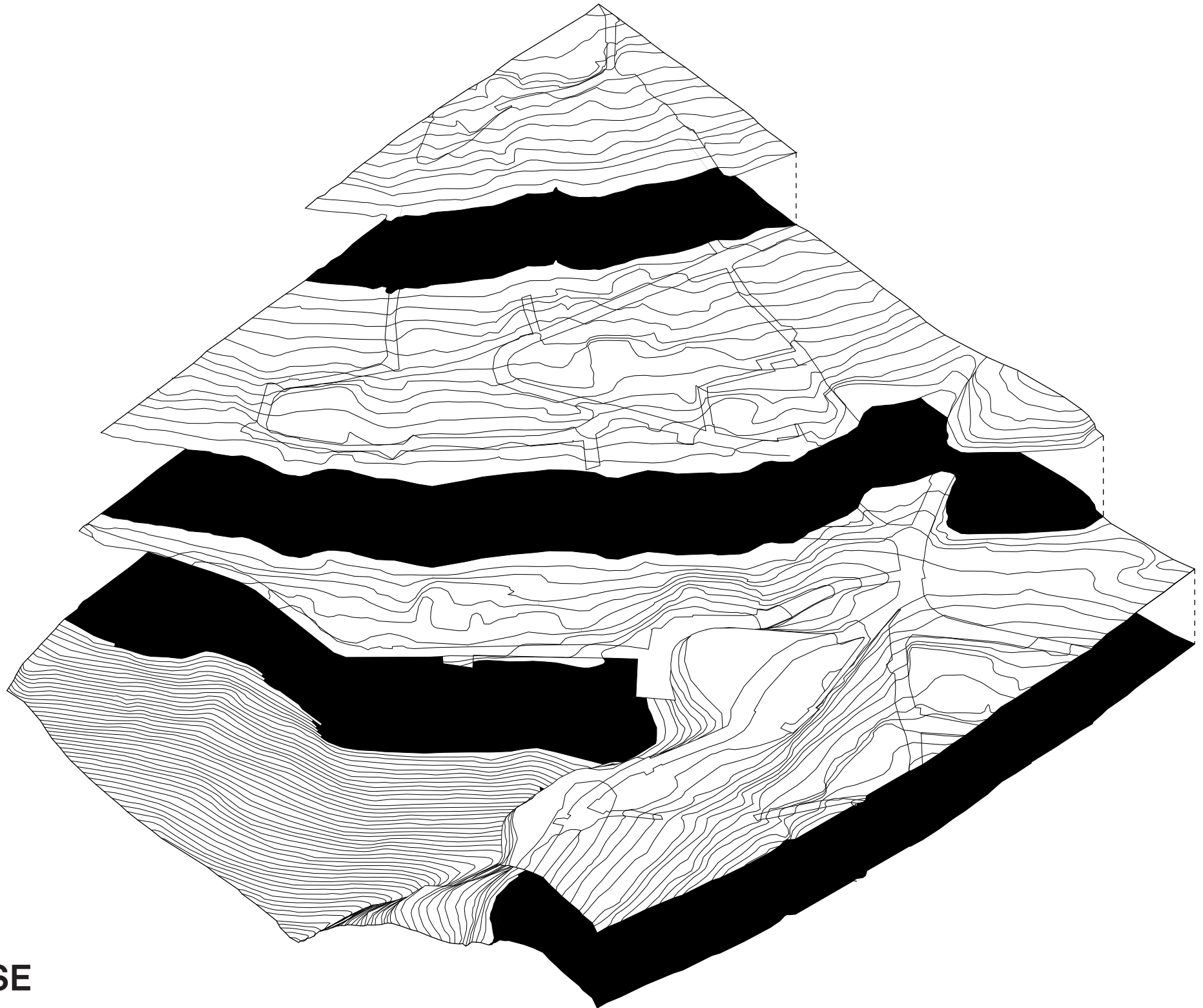

ISOIPSE

SECUNDÄR - FORMATION

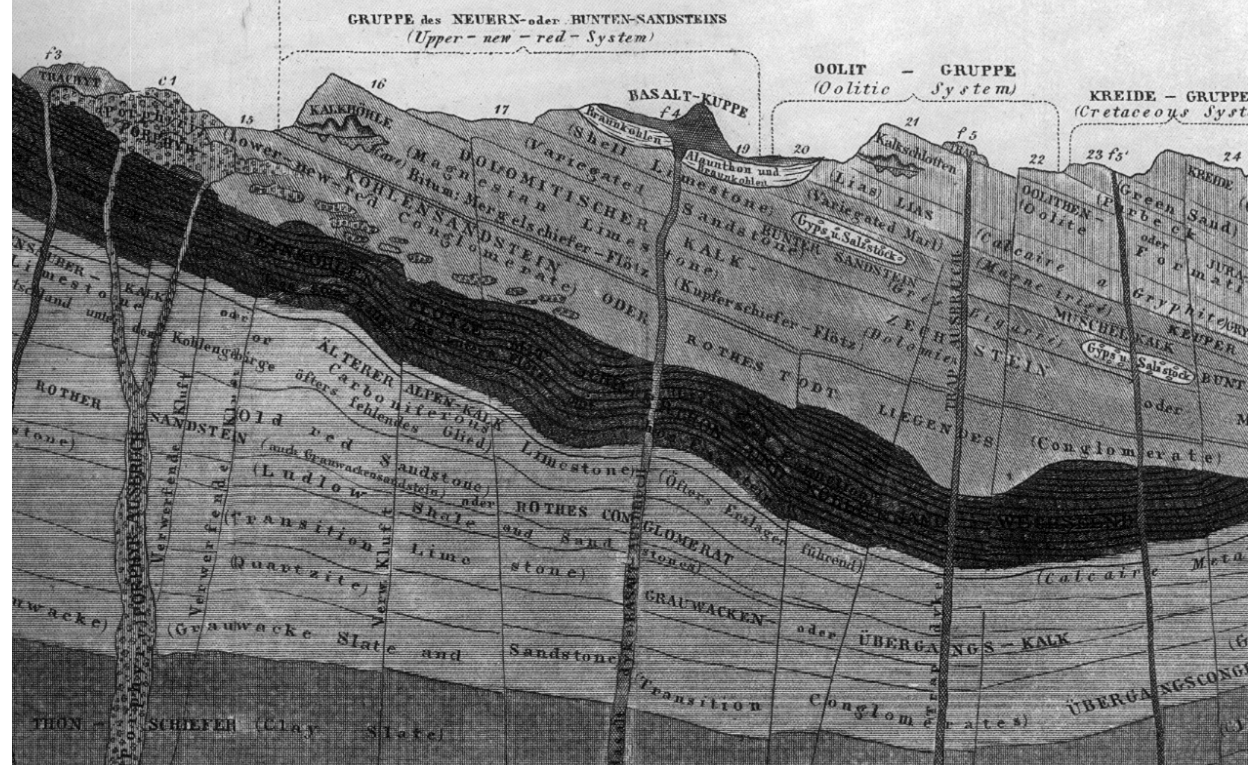
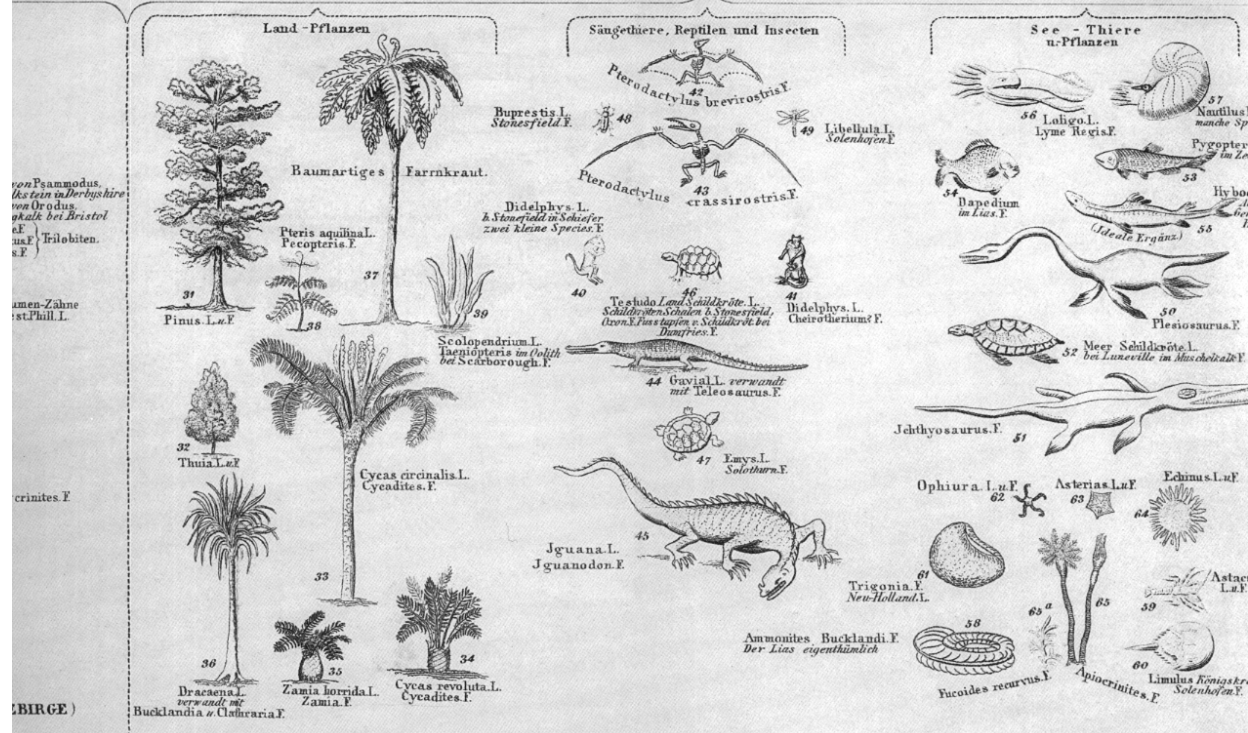

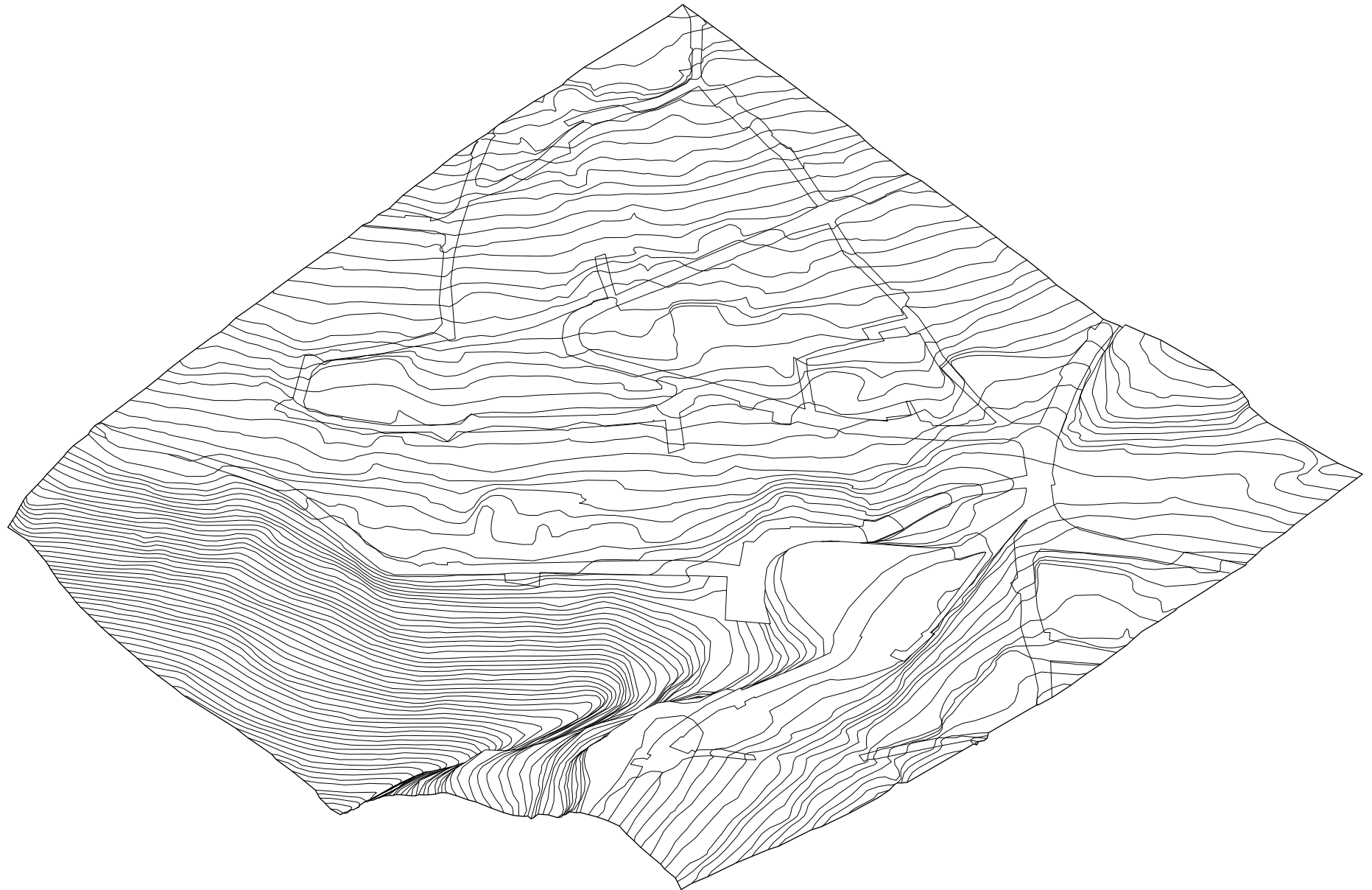

APPROFONDIMENTO - ALTIMETRIA

Via Montefiori

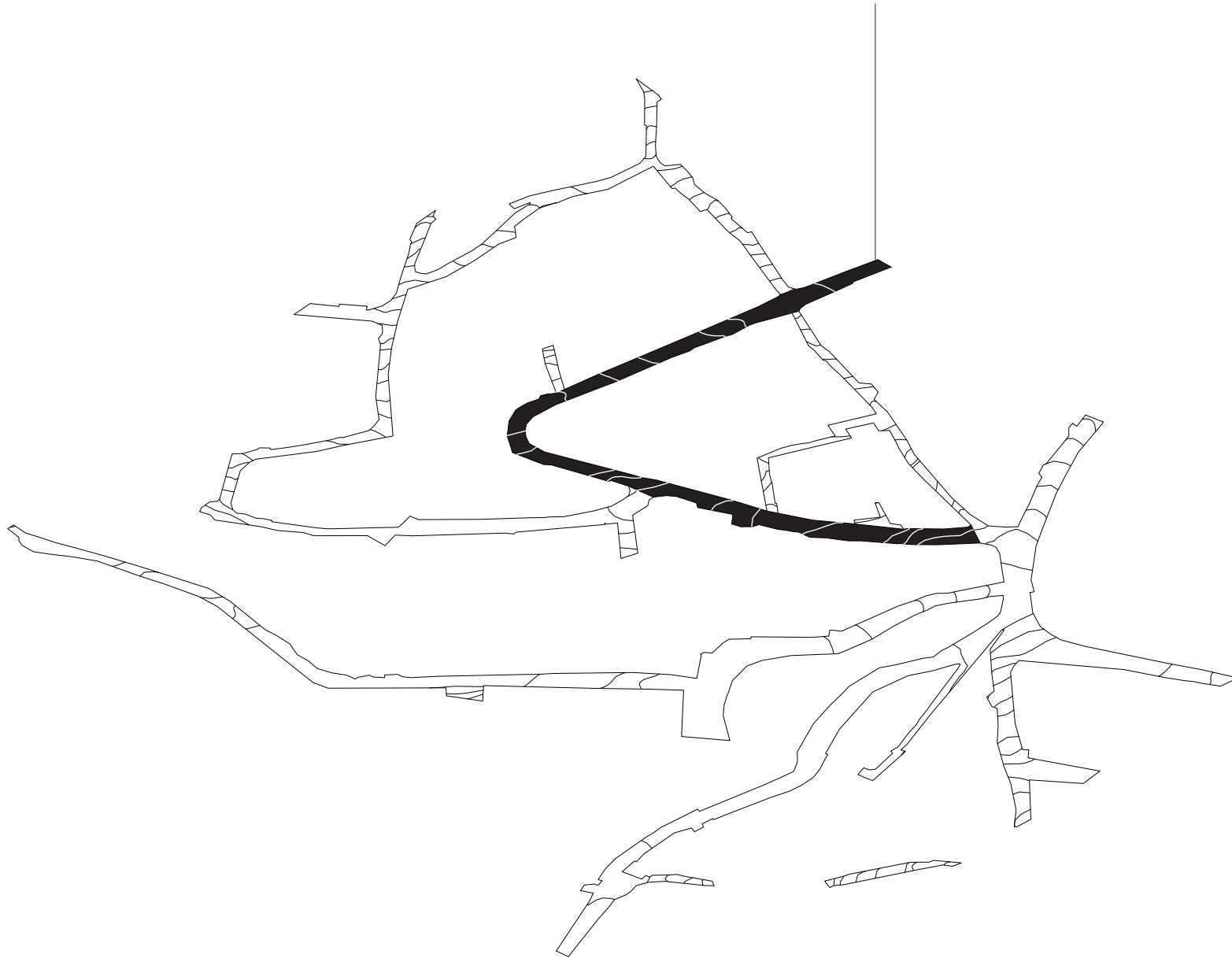

APPROFONDIMENTO - STRADE

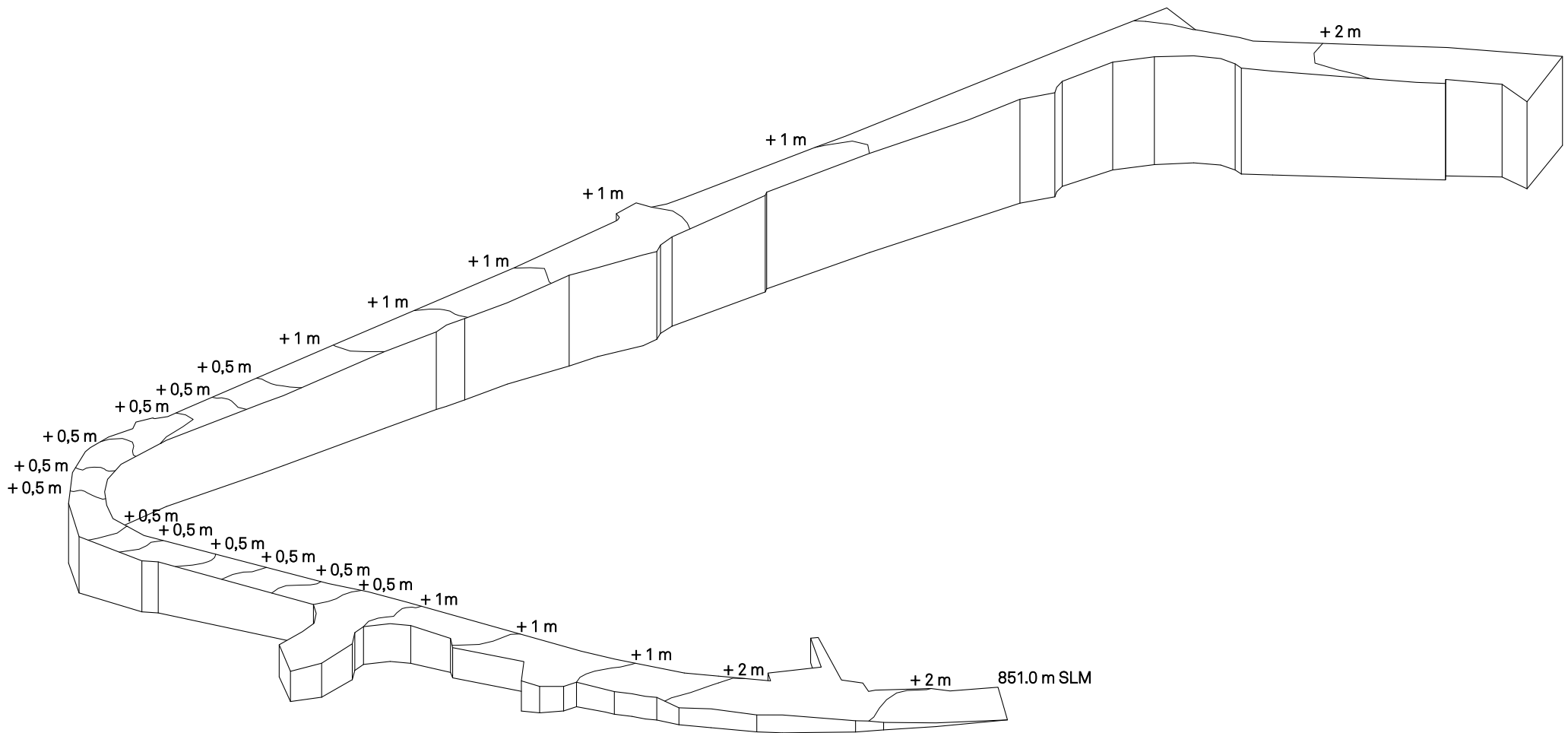

VIA MONTEFIORI - PROGRESSIONE ALTIMETRICA



861.5

862.0

862.5

863.0