

# Basic Antenna Theory

Ryszard Struzak

Note: These are preliminary notes, intended only for distribution among the participants. Beware of misprints!

# Purpose

- to refresh basic physical concepts needed to understand better the operation and design of microwave antennas

# Outline

- Introduction
- Review of basic antenna types
- Radiation pattern, gain, polarization
- Equivalent circuit & radiation efficiency
- Smart antennas
- Some theory
- Summary

# Quiz

Transmitting antennas

used to radiate RF energy, whereas

receiving antennas

designed to capture RF energy

Somebody told that receiving antennas,

radiate radio waves during the reception

Is it a true fact or a slip of the tongue?

- It is true...

# Intended & unintended radiators

- Intended antennas
  - To produce/ receive specified EM waves:
    - Radiocommunication antennas;
    - Measuring antennas;
    - EM sensors, probes;
    - EM applicators (Industrial, Medical, Scientific)

- Unintended antennas - active
  - EM waves radiated as an unintended side-effect:
    - Any conductor/ installation with varying electrical current (e.g. electrical installation of vehicles)
    - Any slot/ opening in the screen of a device/ cable carrying RF current

- Unintended antennas - passive
  - Any discontinuity in transmission medium (e.g. conducting structures/ installations) irradiated by EM waves
    - Stationary (e.g. antenna masts or power line wires);
    - Time-varying (e.g. windmill or helicopter propellers);
    - Transient (e.g. aeroplanes, missiles)



# Antenna function

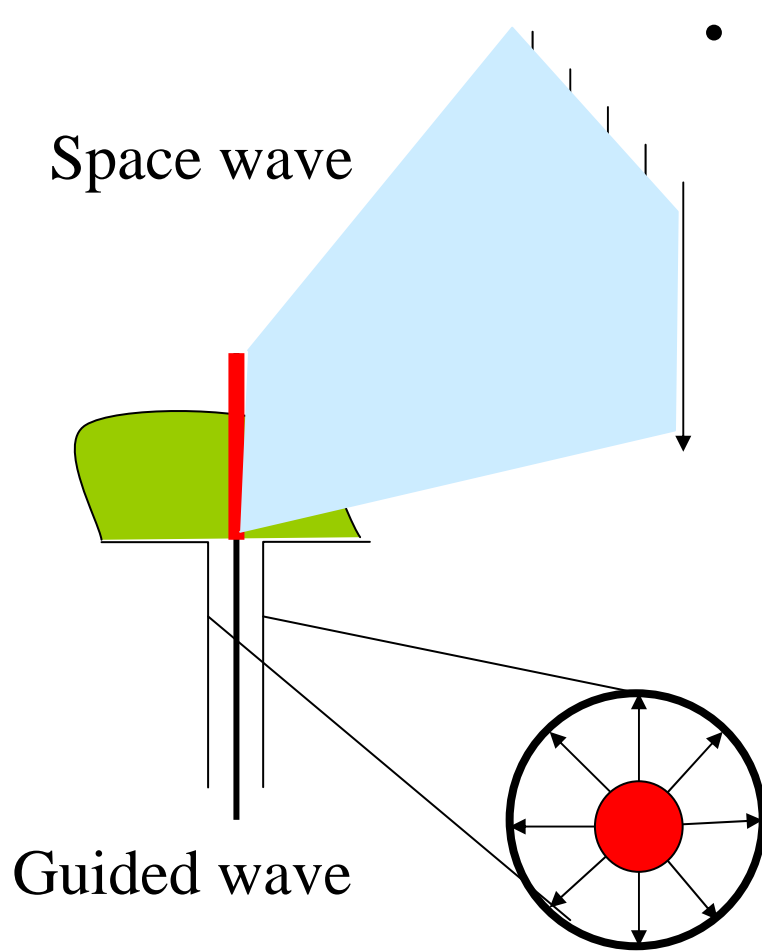

- Transformation of a guided EM wave (in waveguide/ transmission line ) into an EM wave freely propagating in space (or vice versa)
  - Transformation from time-function into RF wave (= vectorial field dependent on time and 3 space-dimensions)
  - The specific form and direction of the wave is defined by the antenna structure and the environment

- Transmission line
  - Power transport medium – the transition ideally without power reflections (matching devices!)
- Radiator
  - Must radiate efficiently – must be of a size comparable with the half-wavelength
- Resonator
  - Unavoidable - for broadband applications resonances must be attenuated

# Monopole (dipole over plane)

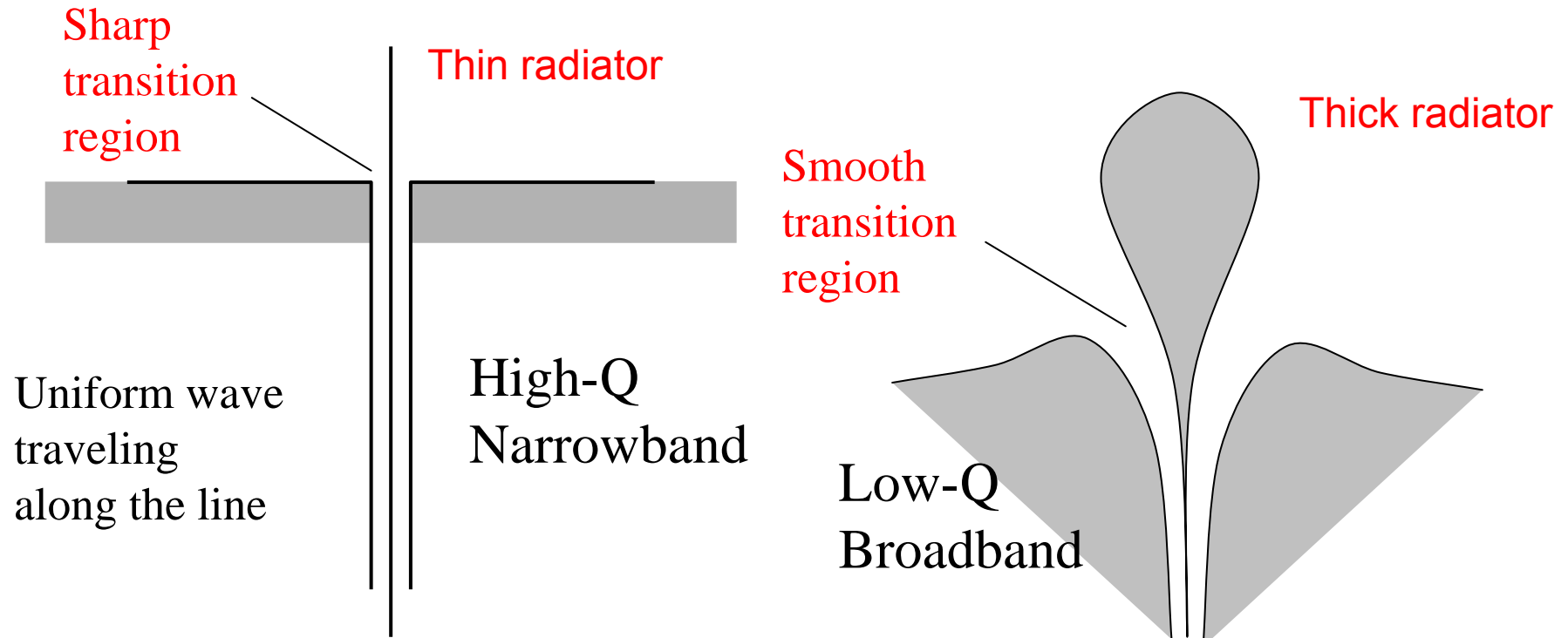

- If there is an inhomogeneity (obstacle, or sharp transition), reflections, higher field-modes and standing wave appear.
- With standing wave, the energy is stored in, and oscillates from electric energy to magnetic one and back. This can be modeled as a resonating LC circuit with  $Q = (\text{energy stored per cycle}) / (\text{energy lost per cycle})$
- Kraus p.2

# Outline

- Introduction
- **Review of basic antenna types**
- Radiation pattern, gain, polarization
- Equivalent circuit & radiation efficiency
- Smart antennas
- Some theory
- Summary

# Dipole antenna

- Java applet on thin linear dipole antenna (length effects):

<http://www.amanogawa.com/archive/DipoleAnt/DipoleAnt-2.html>

- Java applet on detailed analysis of dipole antennas:

<http://www.amanogawa.com/archive/Antenna1/Antenna1-2.html>

# Dipole, Slot & INF antennas

- Slot antenna: a slot is cut from a large (relative to the slot length) metal plate.
  - The center conductor of the feeding coaxial cable is connected to one side of the slot, and the outside conductor of the cable - to the other side of the slot.
  - The slot length is some  $(\lambda/2)$  for the slot antenna and  $(\lambda/4)$  long for the INF antenna.
- The INF and the slot antennas behave similarly.
  - The slot antenna can be considered as a loaded version of the INF antenna. The load is a quarter-wavelength stub, i.e. a narrowband device.
  - When the feed point is moved to the short-circuited end of the slot (or INF) antenna, the impedance decreases. When it is moved to the slot center (or open end of the INF antenna), the impedance increases

# Antennas for laptop applications

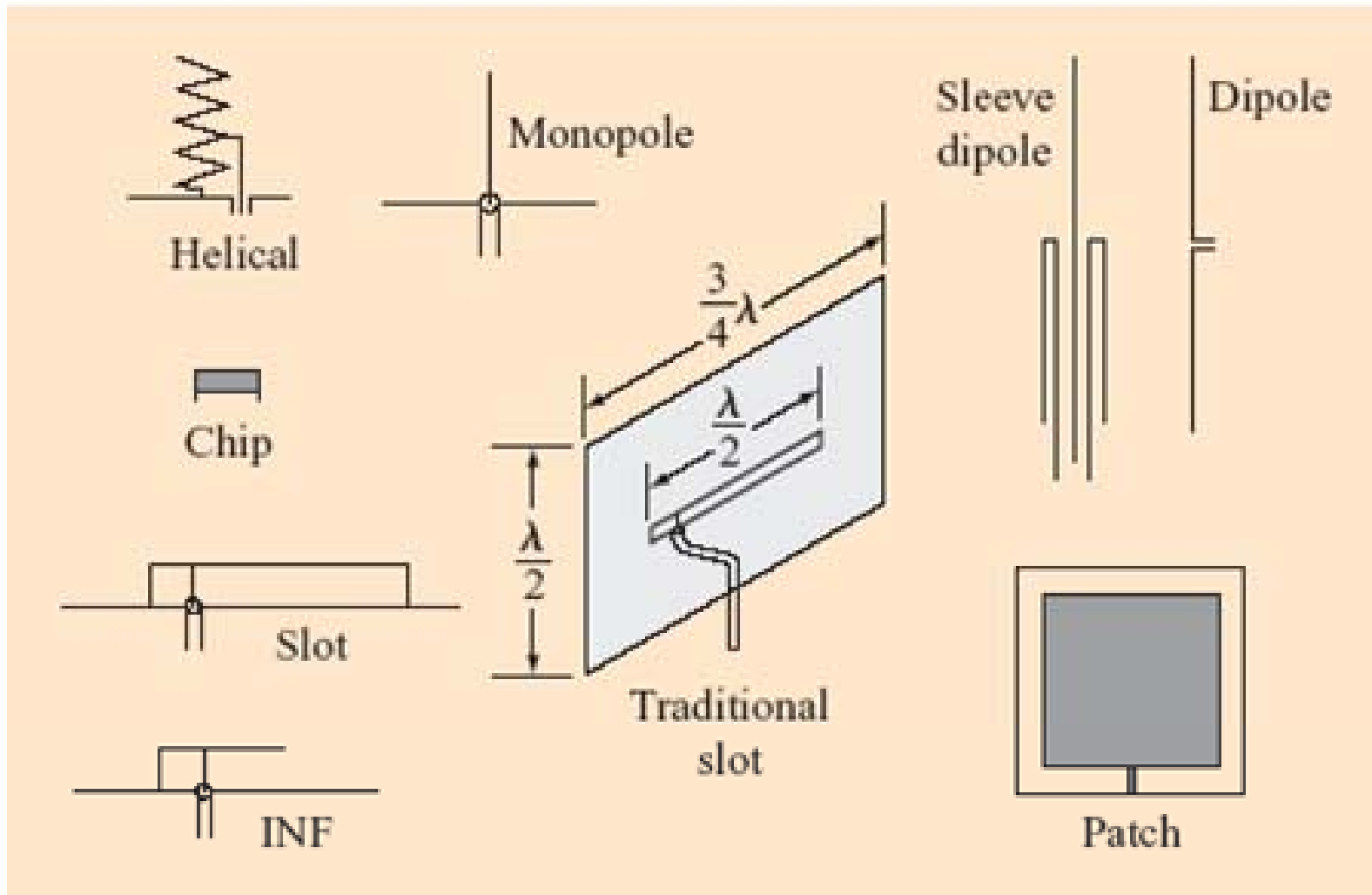

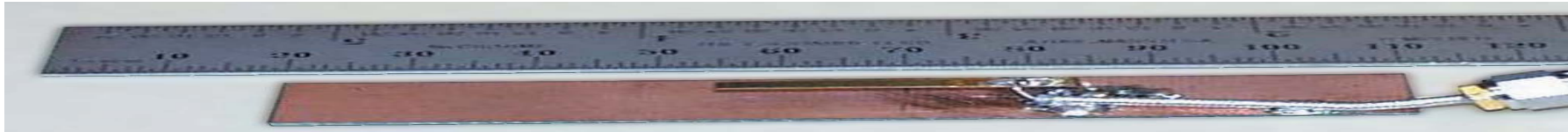

- Patch and slot antennas derived from printed-circuit and micro-strip technologies
- Ceramic chip antennas are typically helical or inverted-F (INF) antennas, or variations of these two types with high dielectric loading to reduce the antenna size

Source: D. Liu et al.: Developing integrated antenna subsystems for laptop computers; IBM J. RES. & DEV. VOL. 47 NO. 2/3 MARCH/MAY 2003 p. 355-367



- Patch and slot antennas are
  - Cheap and easy to fabricate and to mount
  - Suited for integration
  - Light and mechanically robust
  - Have low cross-polarization
  - Low-profile - widely used in antenna arrays
    - spacecrafts, satellites, missiles, cars and other mobile applications

# Aperture-antenna

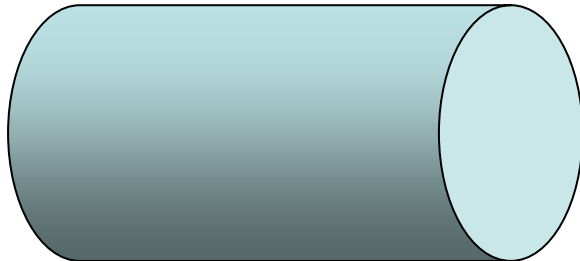
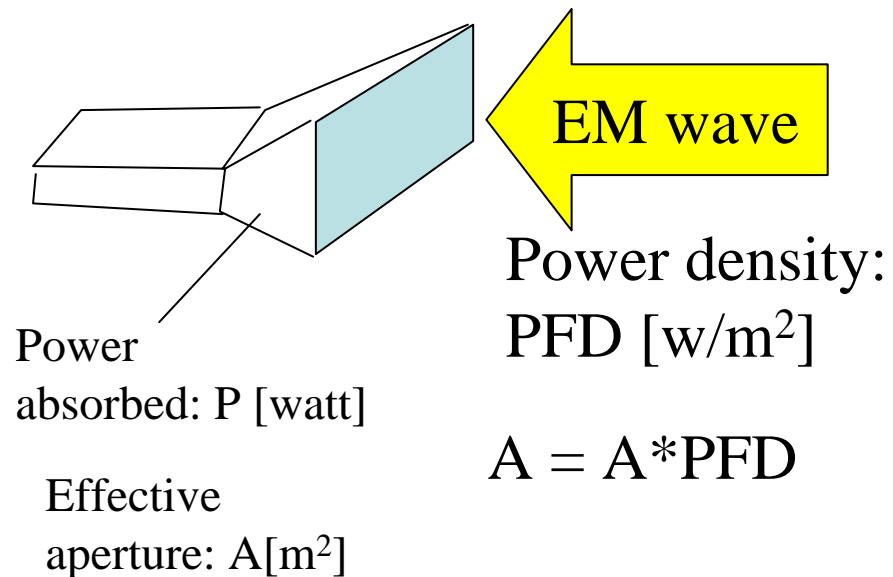

- Aperture antennas derived from waveguide technology (circular, rectangular)
- Can transfer high power (magnetrons, klystrons)
- Above few GHz
- Will be explored in practice during the school
- Note: The aperture concept is applicable also to wired antennas. For instance, the max effective aperture of linear  $\lambda/2$  wavelength dipole antenna is  $\lambda^2/8$

# Leaky-wave antennas

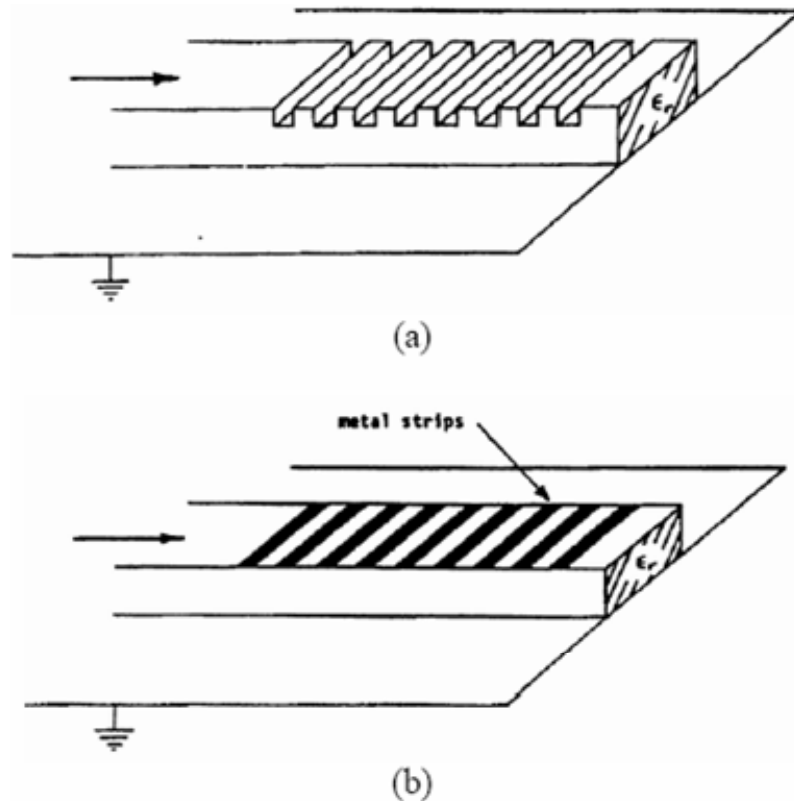

- Derived from millimeter-wave guides (dielectric guides, microstrip lines, coplanar and slot lines).
- For frequencies  $> 30$  GHz, including infrared
- Subject of intensive study.
  - Note: Periodical discontinuities near the end of the guide lead to substantial radiation leakage (radiation from the dielectric surface).

# Reflector antennas

- Reflectors are used to concentrate flux of EM energy radiated/ received, or to change its direction
- Usually, they are parabolic (paraboloidal).
  - The first parabolic (cylinder) reflector antenna was used by Heinrich Hertz in 1888.
- Large reflectors have high gain and directivity
  - Are not easy to fabricate
  - Are not mechanically robust
  - Typical applications: radio telescopes, satellite telecommunications.

# Image Theory

- Antenna above perfectly conducting plane surface
- Tangential electrical field component = 0
  - vertical components: the same direction
  - horizontal components: opposite directions
- The field (above the ground) is the same as if the ground is replaced by an mirror image of the antenna
- <http://www.amanogawa.com/archive/wavesA.html>

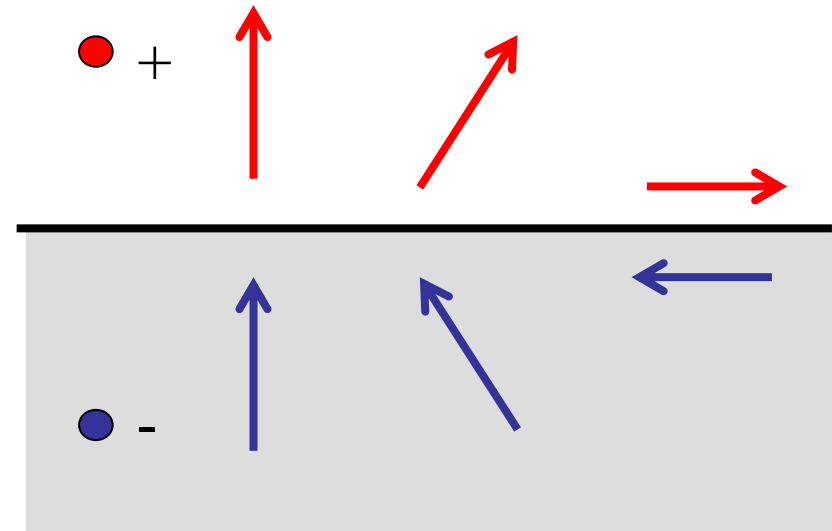

Elliptical polarization:  
change of the rotation sense!

# Planar reflectors

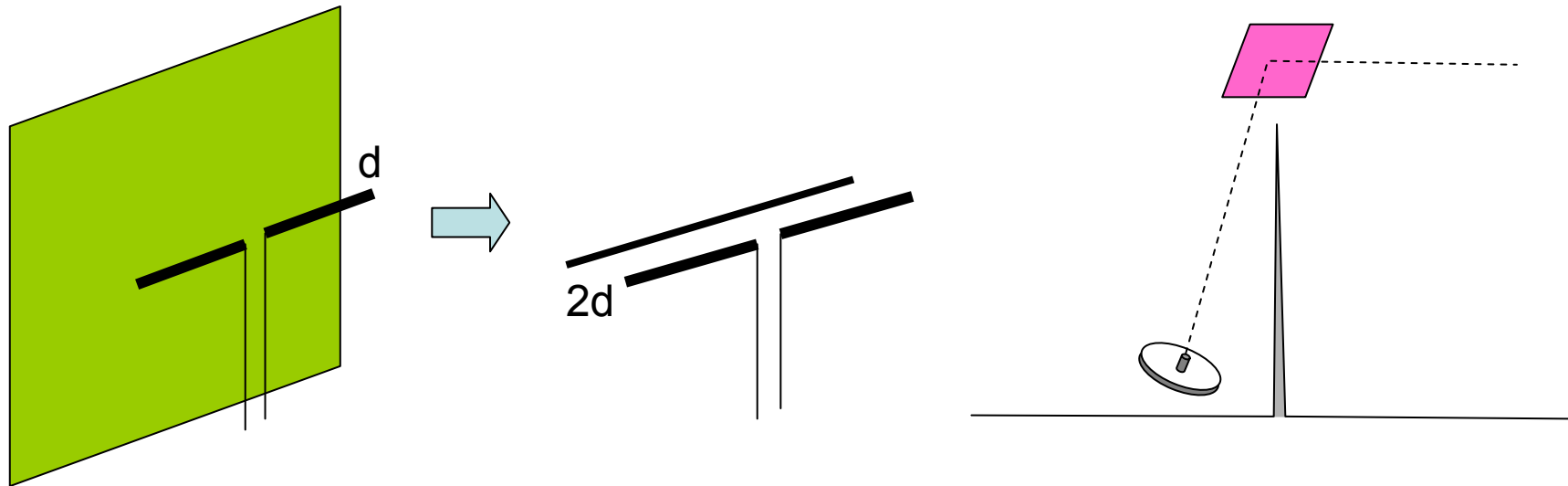

- Uda-Yagi, Log-periodic antennas
- Intended reflector antenna allows maintaining radio link in non-LOS conditions (avoiding propagation obstacles)
- Unintended reflector antennas create interference

# Example

double-layer printed Yagi antenna + matching transformer

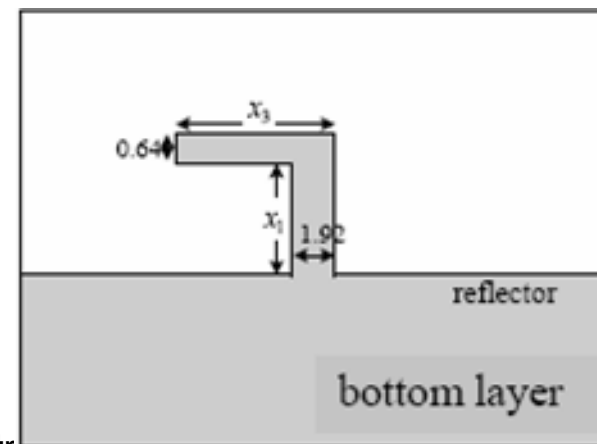
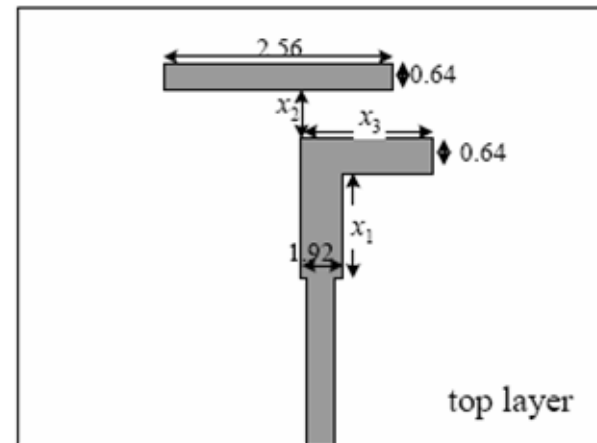
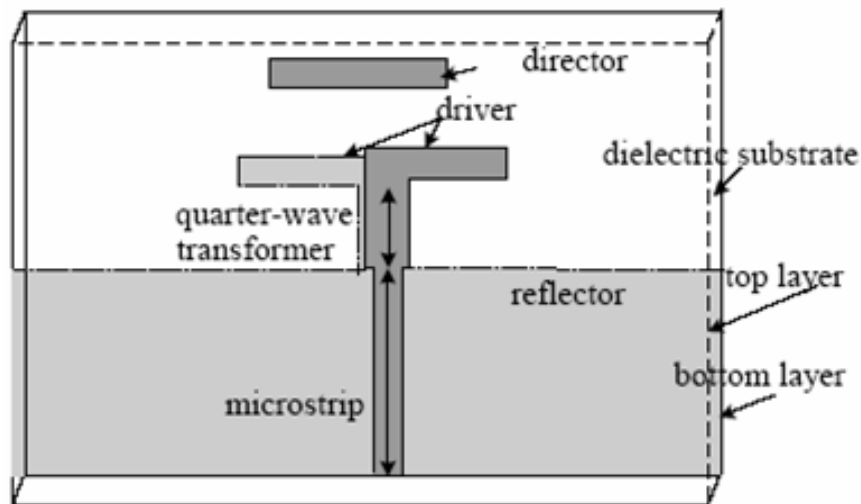

Note: no galvanic contact with the director

Source: N Gregorieva

R Struzar

# Paraboloidal reflectors

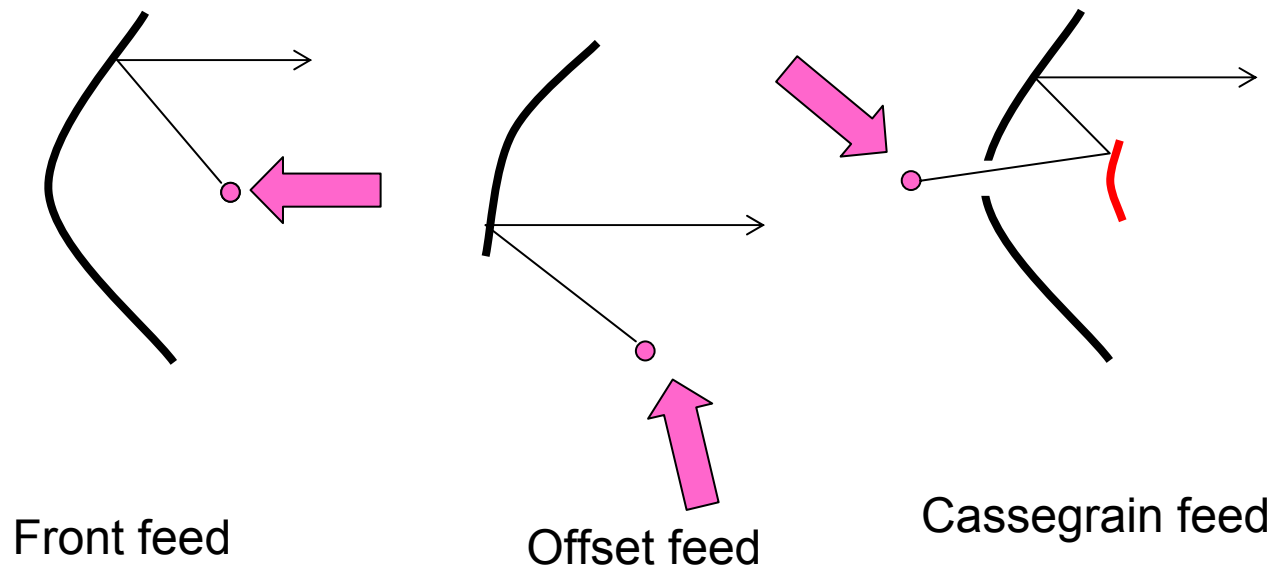



# The largest radio telescopes

- Max Planck Institut für Radioastronomie radio telescope, Effelsberg (Germany), 100-m paraboloidal reflector
- The Green Bank Telescope (the National Radio Astronomy Observatory) – paraboloid of aperture 100 m

# The Arecibo Observatory Antenna System



The world's  
largest single  
radio telescope

304.8-m  
spherical  
reflector

National  
Astronomy and  
Ionosphere  
Center (USA),  
Arecibo,  
Puerto Rico

# The Arecibo Radio Telescope



[Sky & Telescope  
Feb 1997 p. 29]

# Lens antennas

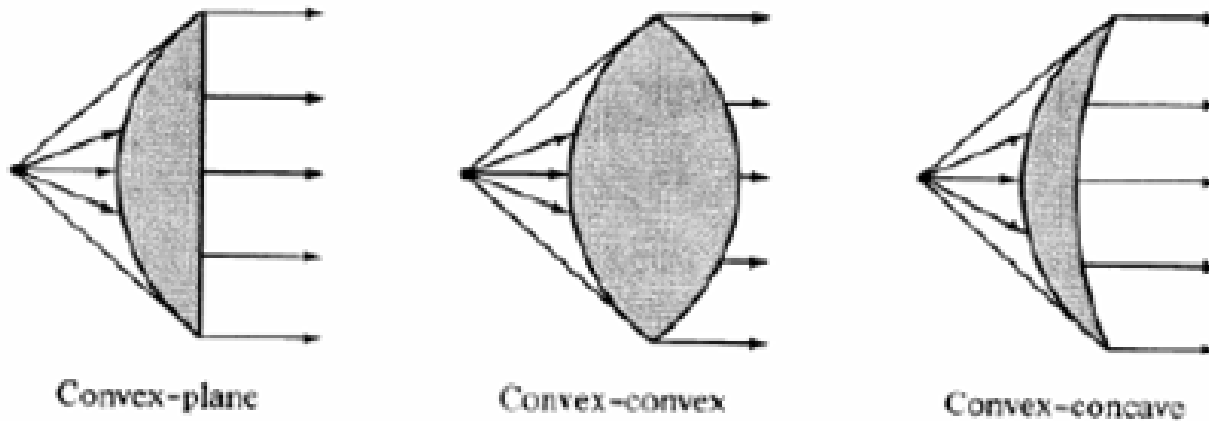

(a) Lens antennas with index of refraction  $n > 1$

Lenses play a similar role to that of reflectors in reflector antennas: they collimate divergent energy  
Often preferred to reflectors at frequencies  $> 100$  GHz.

# Outline

- Introduction
- Review of basic antenna types
- **Radiation pattern, gain, polarization**
- Equivalent circuit & radiation efficiency
- Smart antennas
- Some theory
- Summary

- Antenna characteristics of gain, beamwidth, efficiency, polarization, and impedance are independent of the antenna's use for either transmitting or receiving.
- The properties we will discuss here apply to both cases.

# Radiation pattern

- The *radiation pattern of antenna* is a representation (pictorial or mathematical) of the distribution of the power out-flowing (radiated) from the antenna (in the case of transmitting antenna), or inflowing (received) to the antenna (in the case of receiving antenna) as a function of direction angles from the antenna
  - Antenna radiation pattern (*antenna pattern*):
    - is defined for large distances from the antenna, where the spatial (angular) distribution of the radiated power does not depend on the distance from the radiation source
    - is independent on the power flow direction: it is the same when the antenna is used to transmit and when it is used to receive radio waves
    - is usually different for different frequencies and different polarizations of radio wave radiated/ received

# Power pattern vs. Field pattern

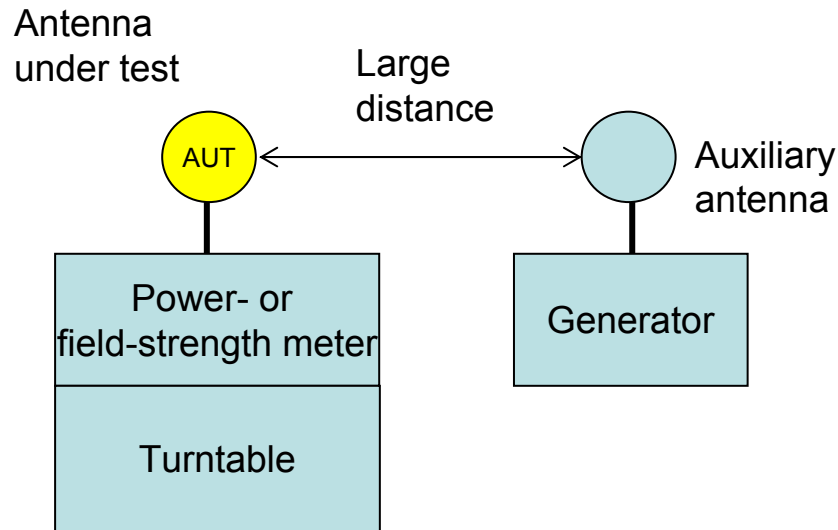

- The power pattern and the field patterns are inter-related for plane wave:  
$$P(\theta, \varphi) = (1/\eta) * |E(\theta, \varphi)|^2 = \eta * |H(\theta, \varphi)|^2$$

P = power  
E = electrical field component vector  
H = magnetic field component vector  
 $\eta = 377$  ohm (free-space, plane wave impedance)

- The *power pattern* is the measured (calculated) and plotted received power:  $|P(\theta, \varphi)|$  at a constant (large) distance from the antenna
- The *amplitude field pattern* is the measured (calculated) and plotted electric (magnetic) field intensity,  $|E(\theta, \varphi)|$  or  $|H(\theta, \varphi)|$  at a constant (large) distance from the antenna



# Normalized pattern

- Usually, the pattern describes the *normalized* field (power) values with respect to the maximum value.
  - Note: The power pattern and the amplitude field pattern are the same when computed and when plotted in dB.

# Reference antenna ( $\lambda/2$ dipole)

Reference antenna ( $\lambda/2$  dipole)

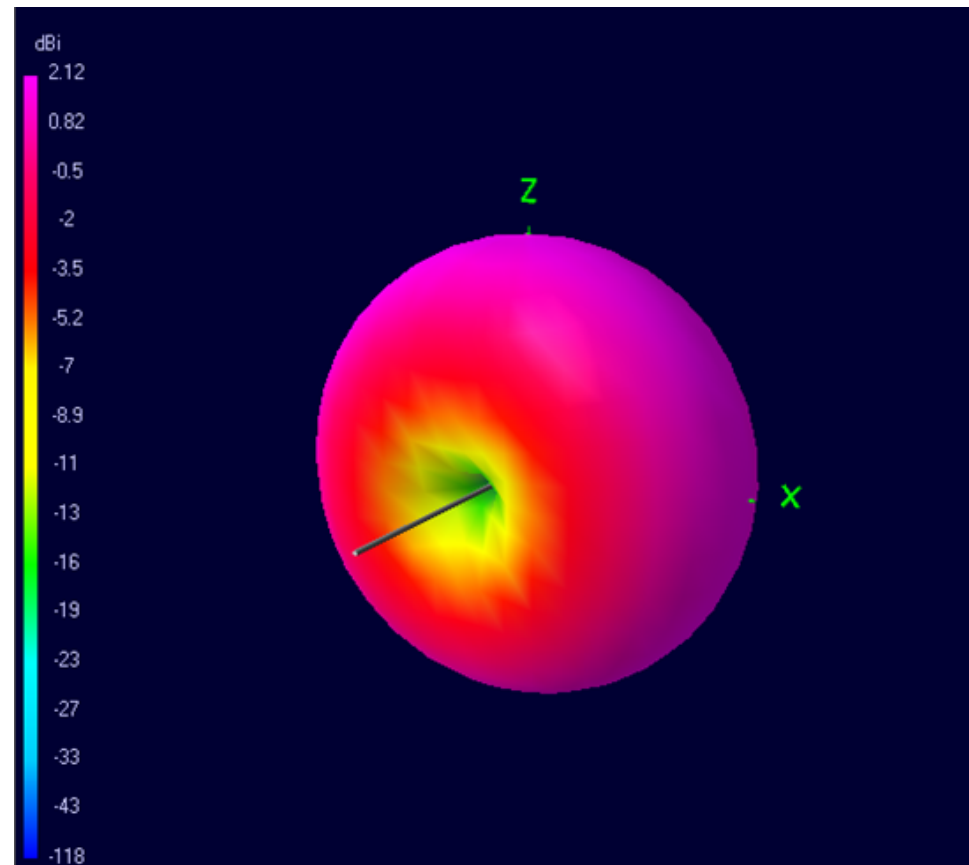

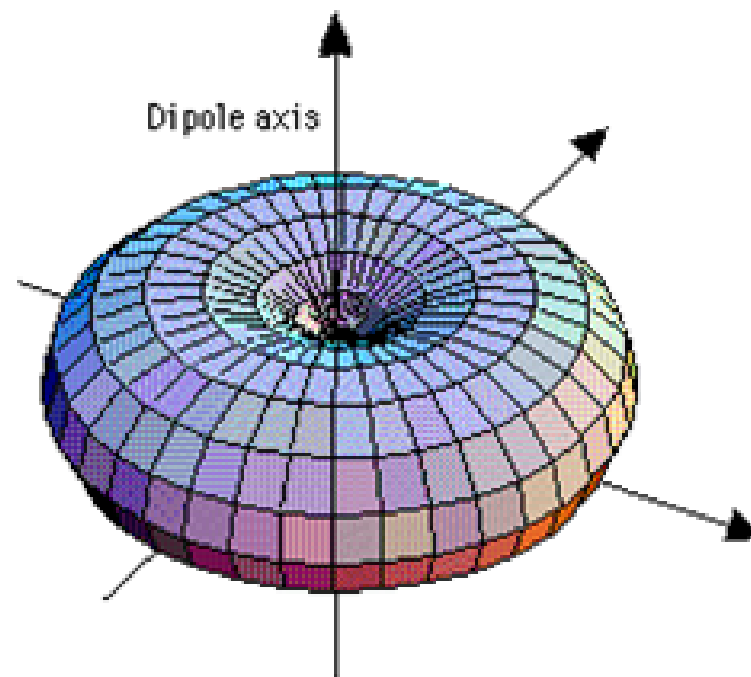
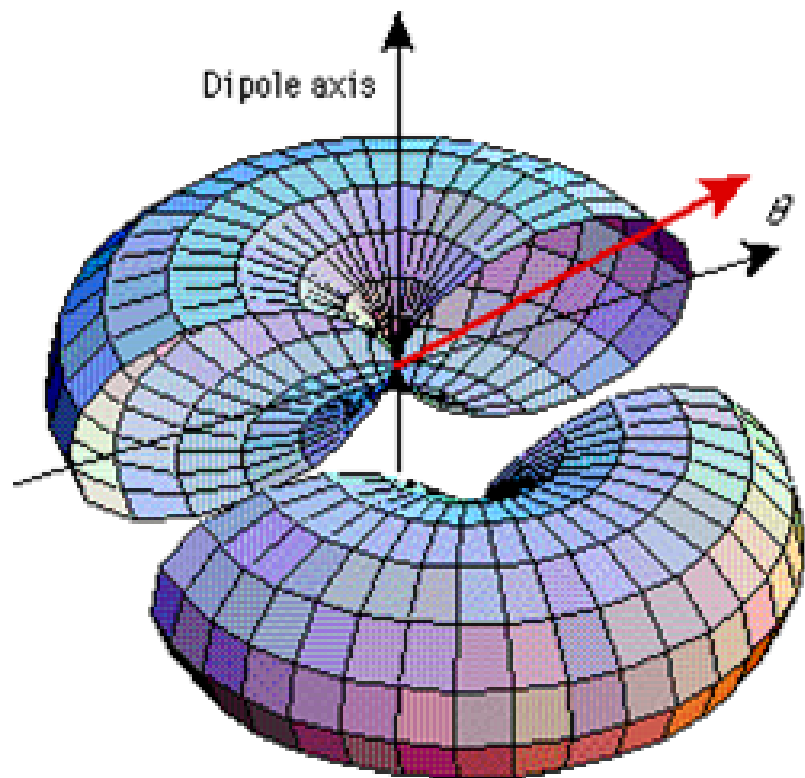

# 'Biquad'

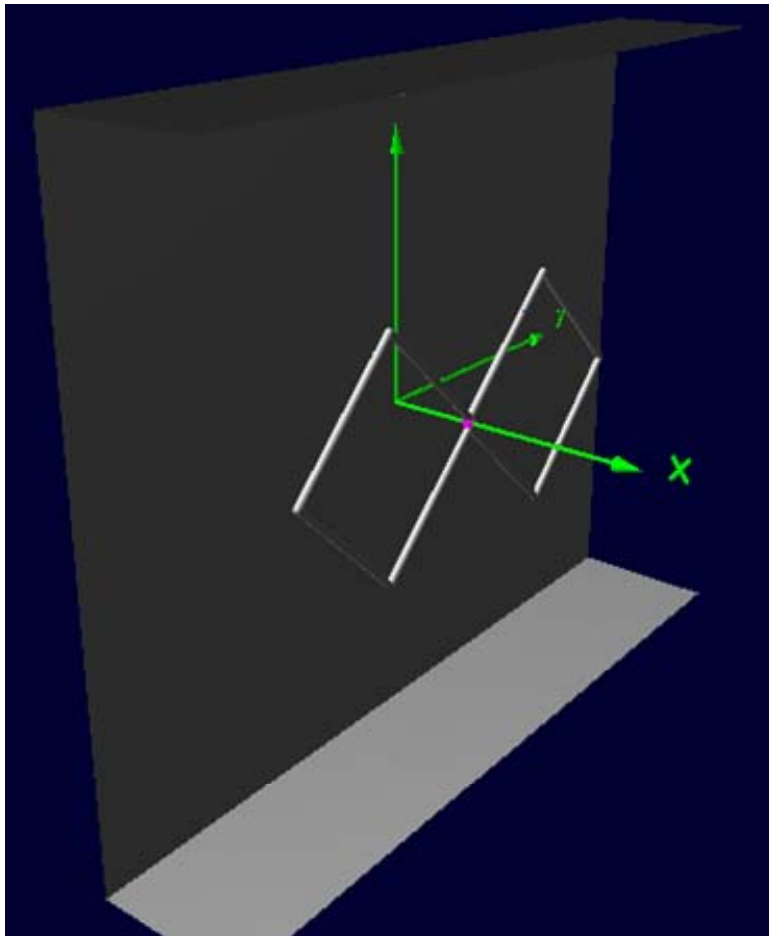

Biquad antenna

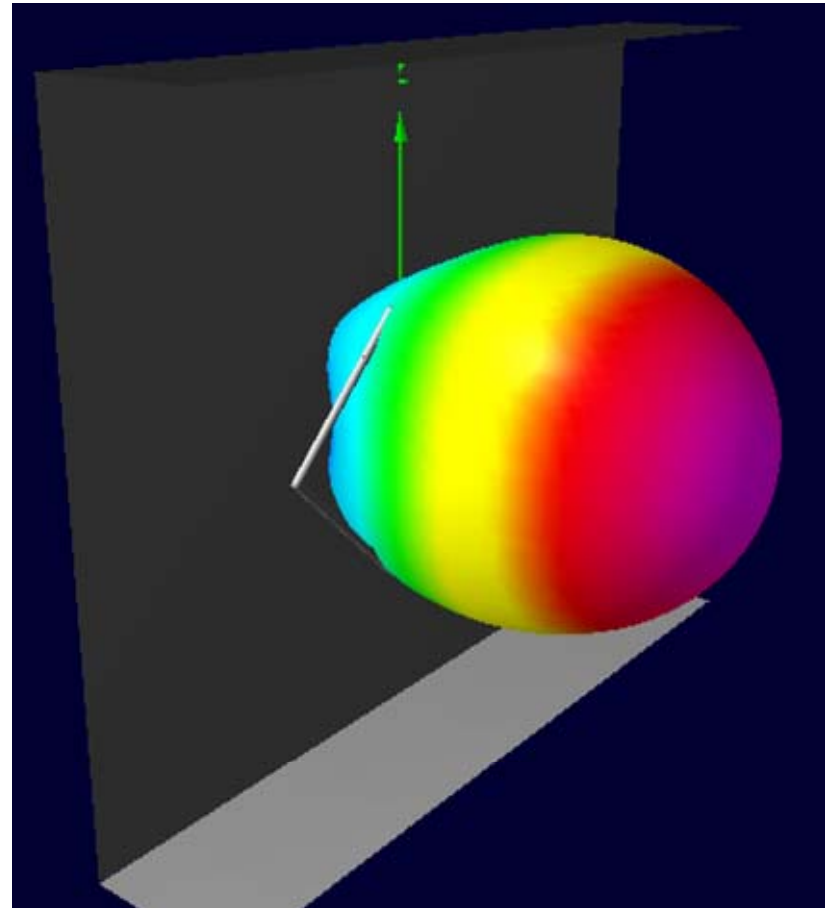

# 'Cantenna'

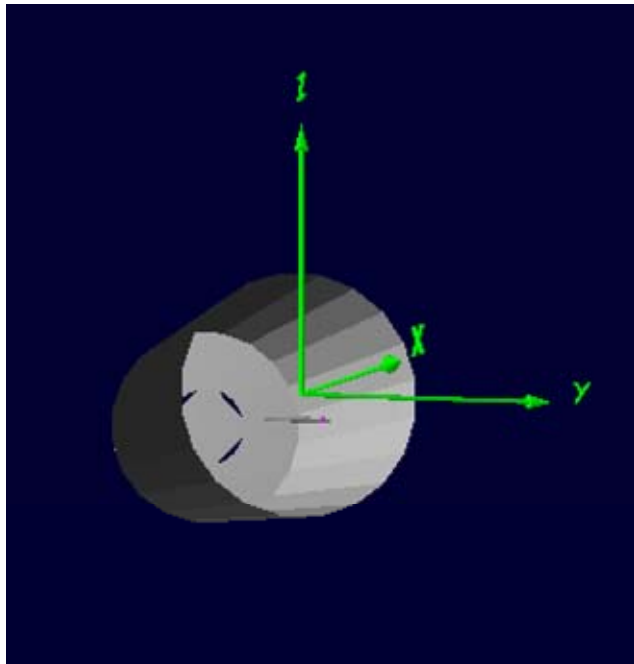

Cantenna

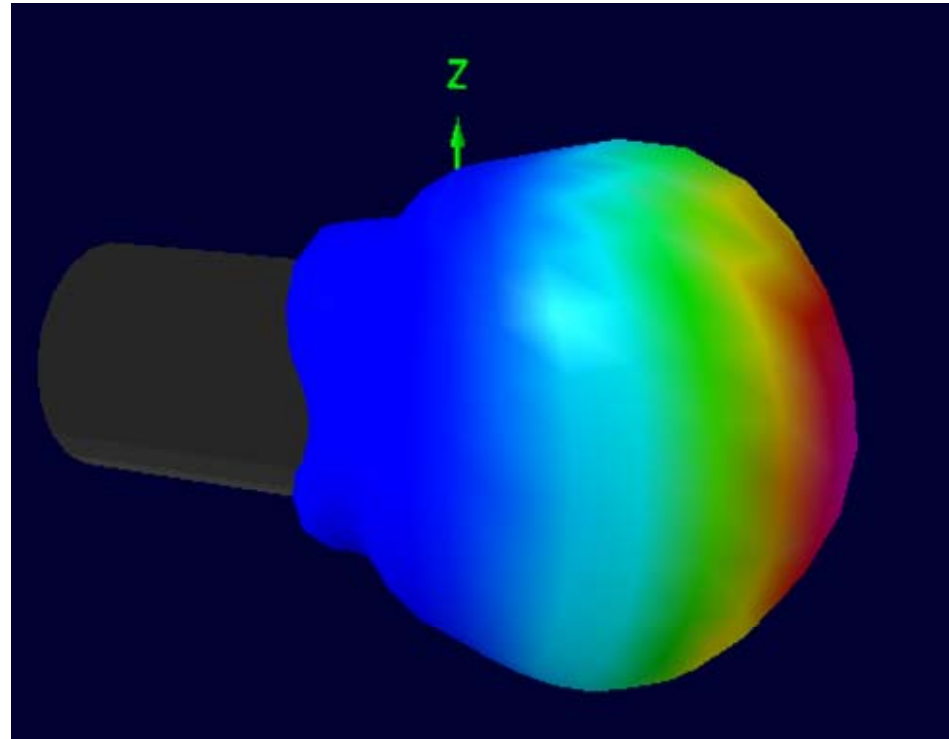

# 3-D pattern

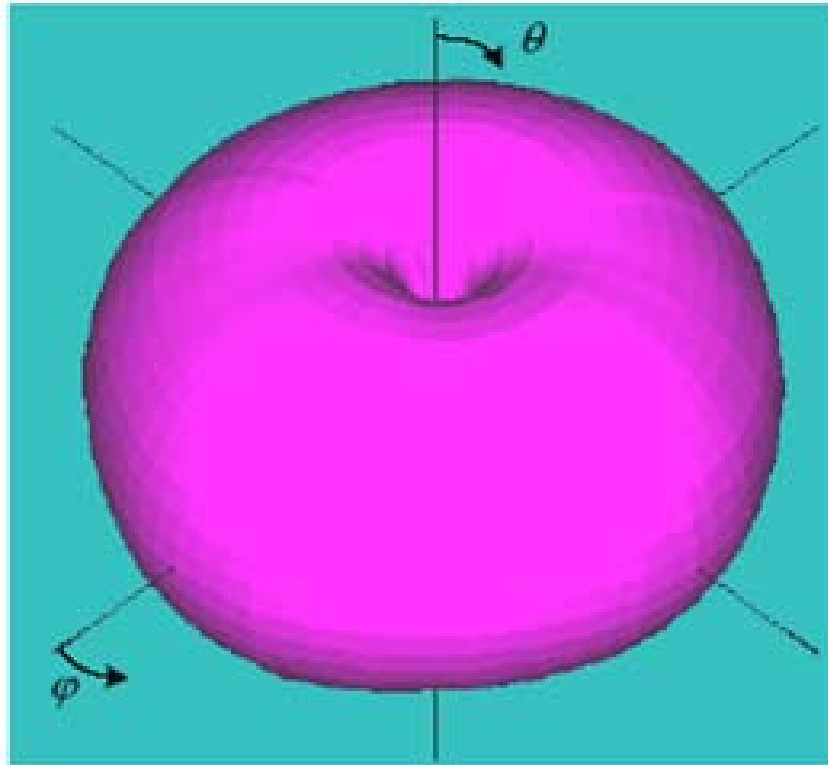

3-D pattern

- Antenna radiation pattern is 3-dimensional
- The 3-D plot of antenna pattern assumes both angles  $\theta$  and  $\varphi$  varying, which is difficult to produce and to interpret

Source: NK Nikolova

# 2-D pattern

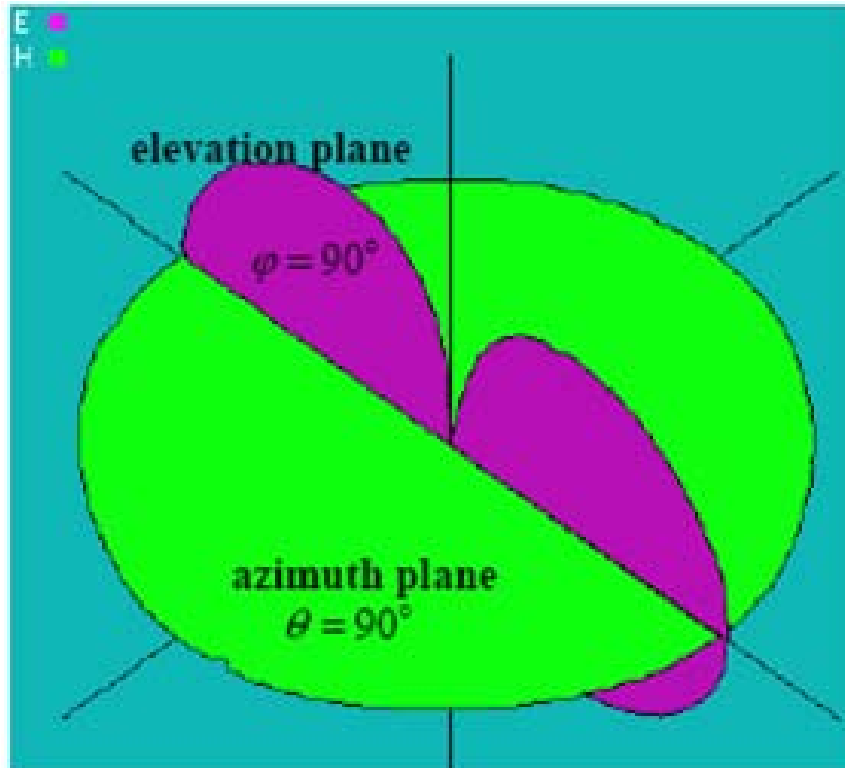

Two 2-D patterns

- Usually the antenna pattern is presented as a 2-D plot, with only one of the direction angles,  $\theta$  or  $\varphi$  varies
- It is an intersection of the 3-D one with a given plane
  - usually it is a  $\theta = \text{const}$  plane or a  $\varphi = \text{const}$  plane that contains the pattern's maximum

Source: NK Nikolova

# Example: a short dipole on z-axis

Elevation plane:  $\varphi = \text{const}$

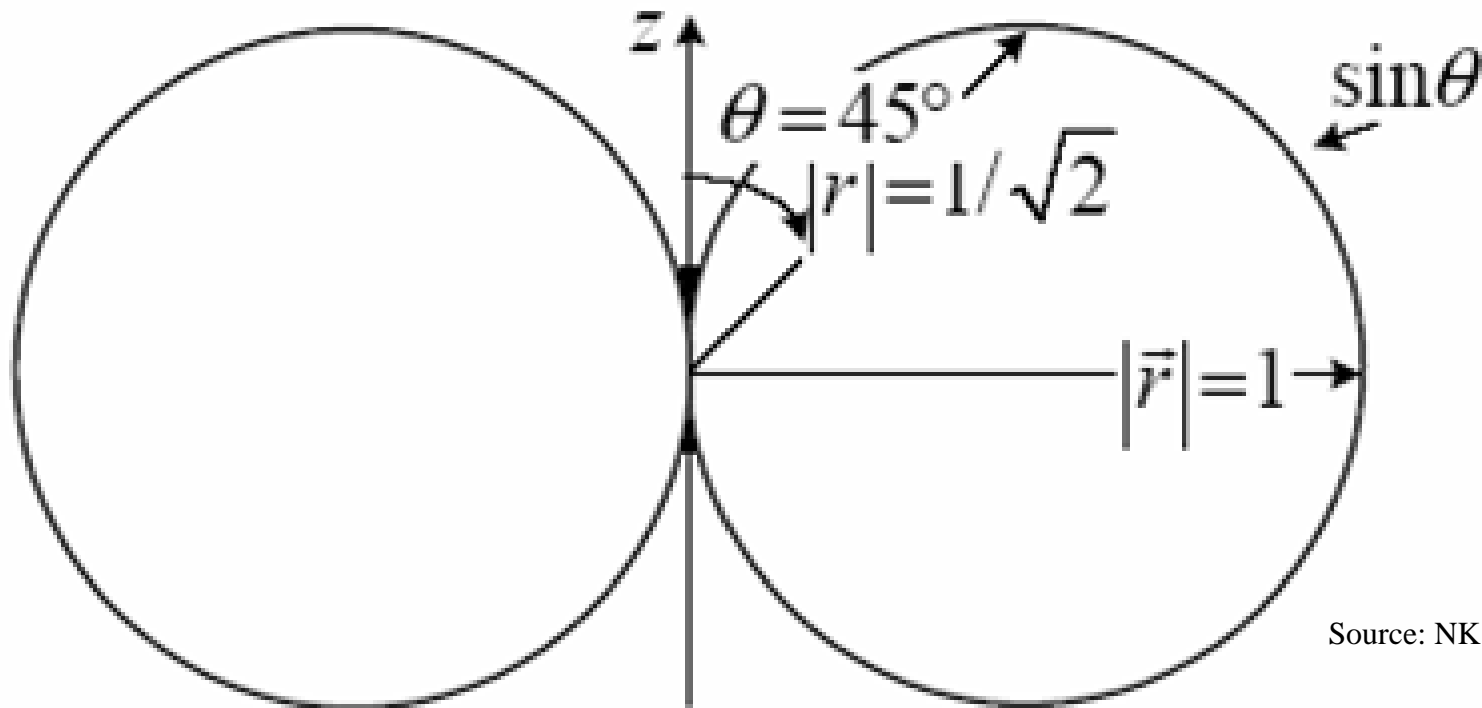

Linear dipole antenna Java demo (length): <http://www.amanogawa.com/archive/DipoleAnt/DipoleAnt-2.html>



# Principal patterns

- Principal patterns are the 2-D patterns of linearly polarized antennas, measured in 2 planes
  1. the ***E-plane***: a plane parallel to the  $E$  vector and containing the direction of maximum radiation, and
  2. the ***H-plane***: a plane parallel to the  $H$  vector, orthogonal to the  $E$ -plane, and containing the direction of maximum radiation

# Example

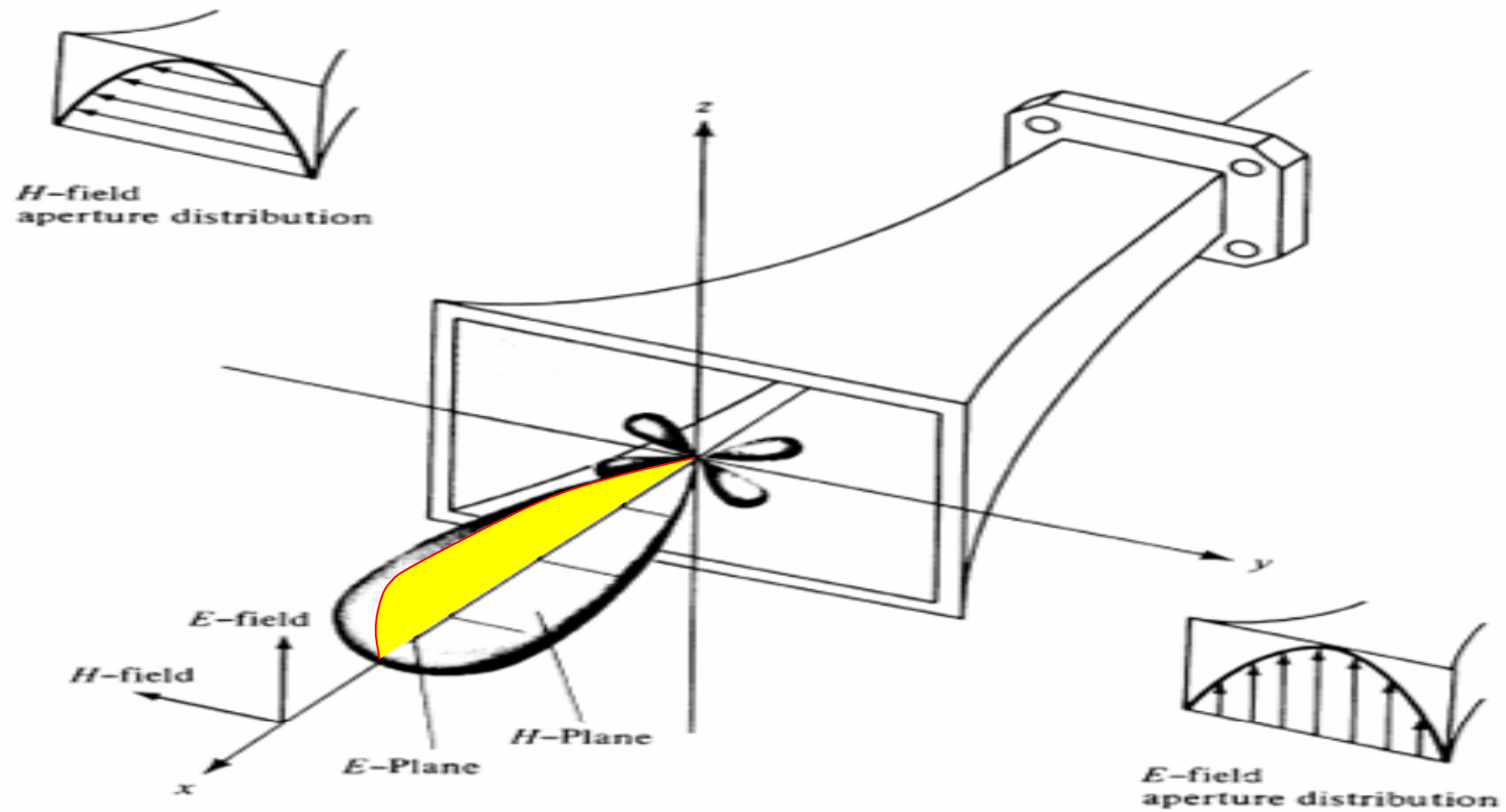

Source: NK Nikolova

# Isotropic antenna

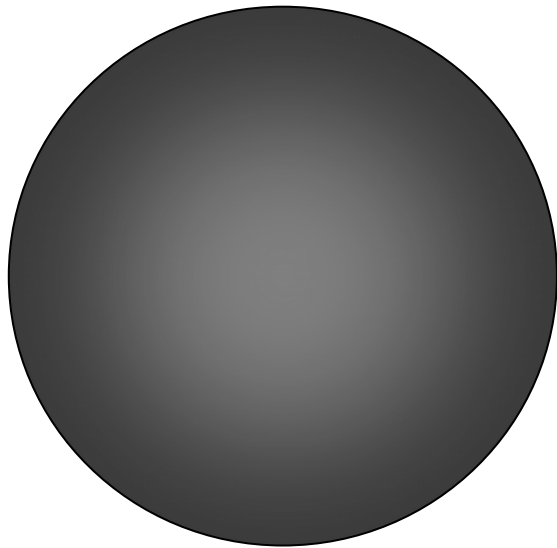

- ***Isotropic antenna or isotropic radiator*** is a hypothetical (not physically realizable) concept, used as a useful reference to describe real antennas.
- Isotropic antenna radiates equally in all directions.
  - Its radiation pattern is represented by a sphere whose center coincides with the location of the isotropic radiator.

Source: NK Nikolova

# Directional antenna

- ***Directional antenna*** is an antenna, which radiates (or receives) much more power in (or from) some directions than in (or from) others.
  - Note: Usually, this term is applied to antennas whose directivity is much higher than that of a half-wavelength dipole.

# Omnidirectional antenna

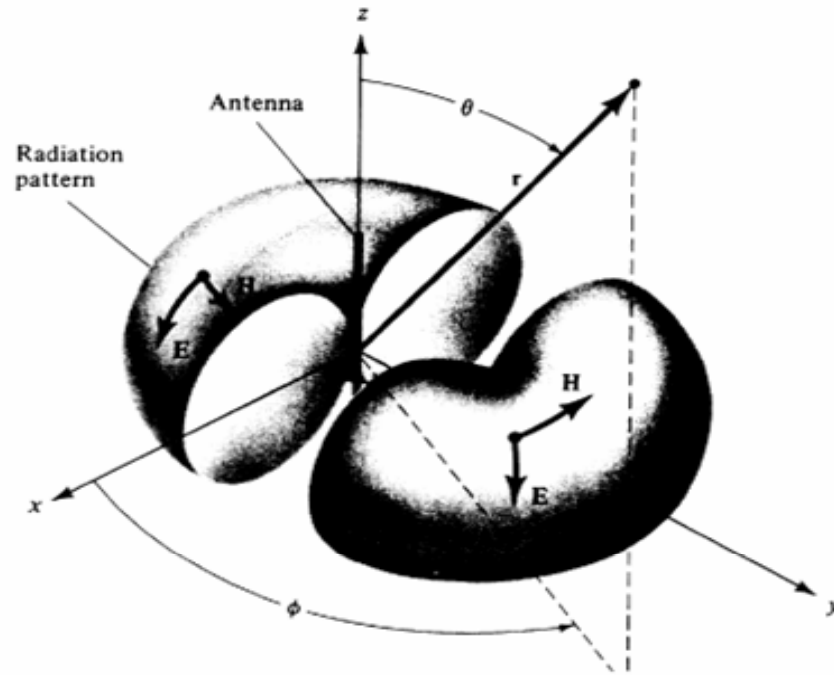

- An antenna, which has a non-directional pattern in a plane
  - It is usually directional in other planes

Source: NK Nikolova

# Pattern lobes

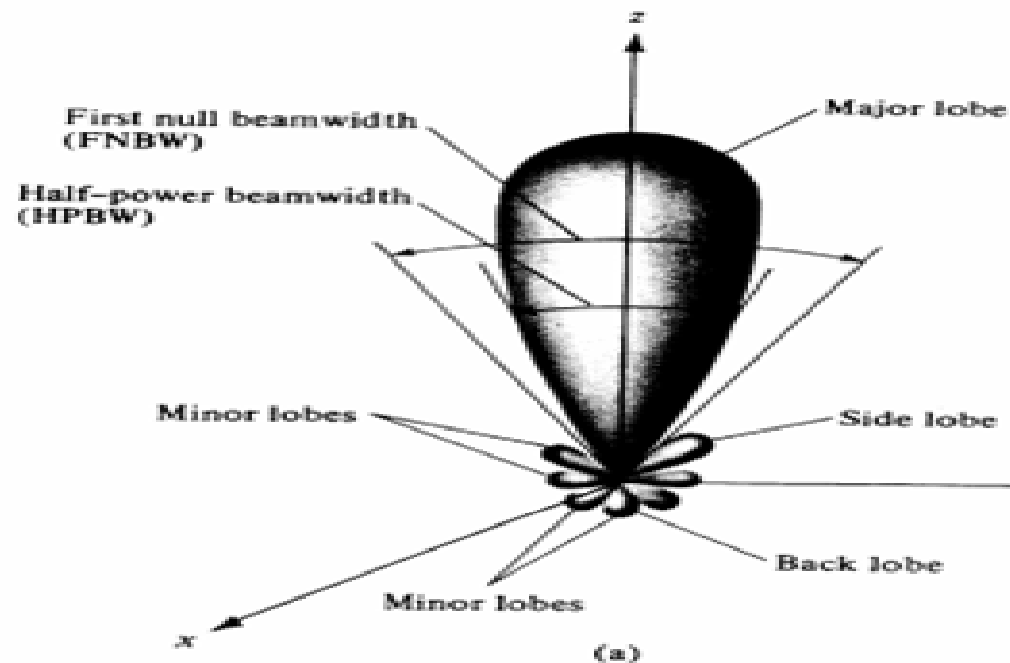

*Pattern lobe* is a portion of the radiation pattern with a local maximum

Lobes are classified as: major, minor, side lobes, back lobes.

Source: NK Nikolova

# Pattern lobes and beam widths

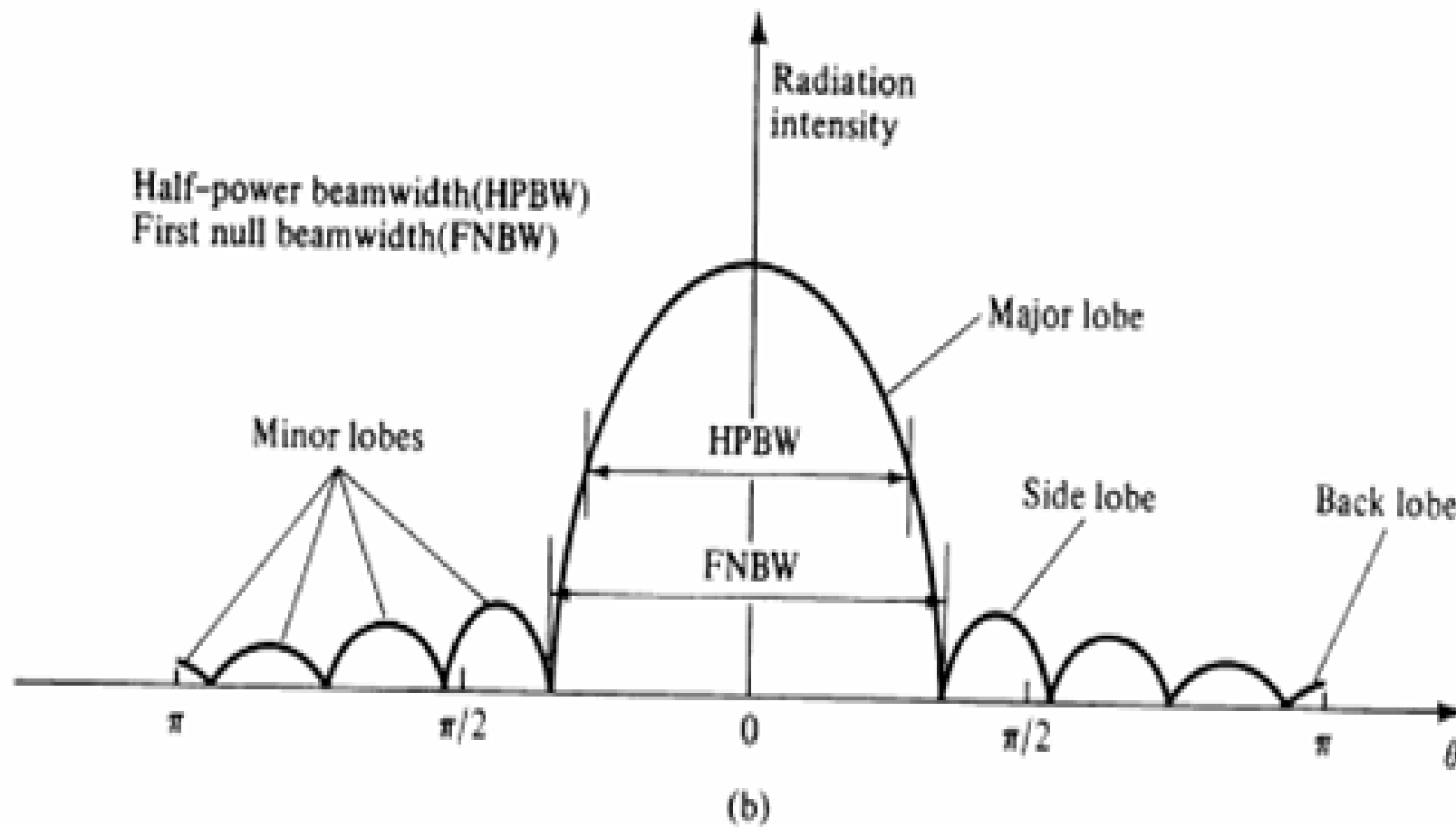

Source: NK Nikolova

# Example

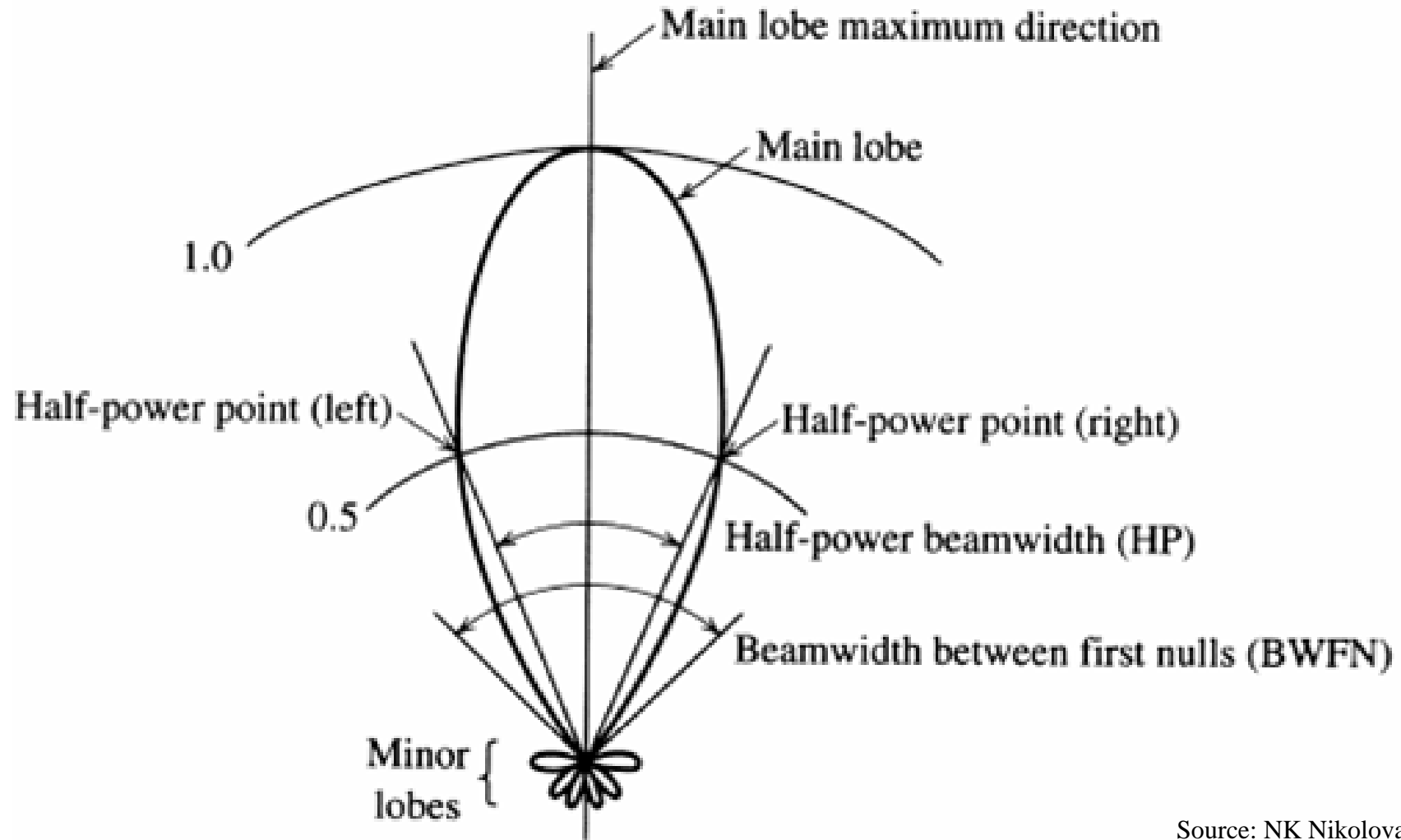

Source: NK Nikolova



# Beamwidth

- ***Half-power beamwidth*** (HPBW) is the angle between two vectors from the pattern's origin to the points of the major lobe where the radiation intensity is half its maximum
  - Often used to describe the antenna resolution properties
    - » Important in radar technology, radioastronomy, etc.
- ***First-null beamwidth*** (FNBW) is the angle between two vectors, originating at the pattern's origin and tangent to the main beam at its base.
  - » Often  $\text{FNBW} \approx 2 \cdot \text{HPBW}$

# Antenna Mask (Example 1)

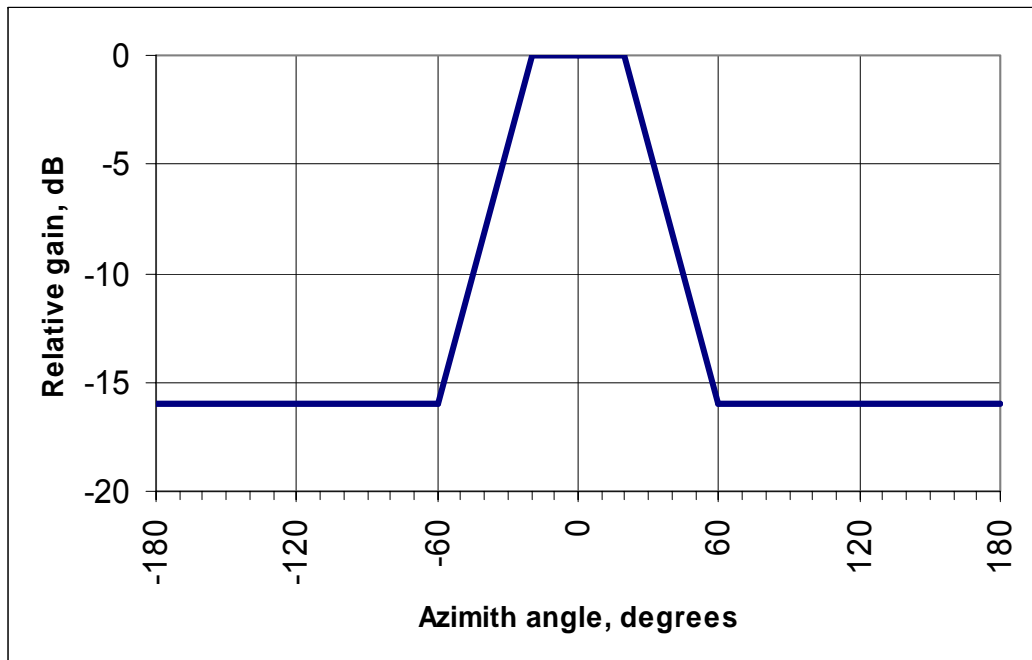

Typical relative directivity- mask of receiving antenna (Yagi ant., TV dcm waves)

[CCIR doc. 11/645, 17-Oct 1989)

# Antenna Mask (Example 2)

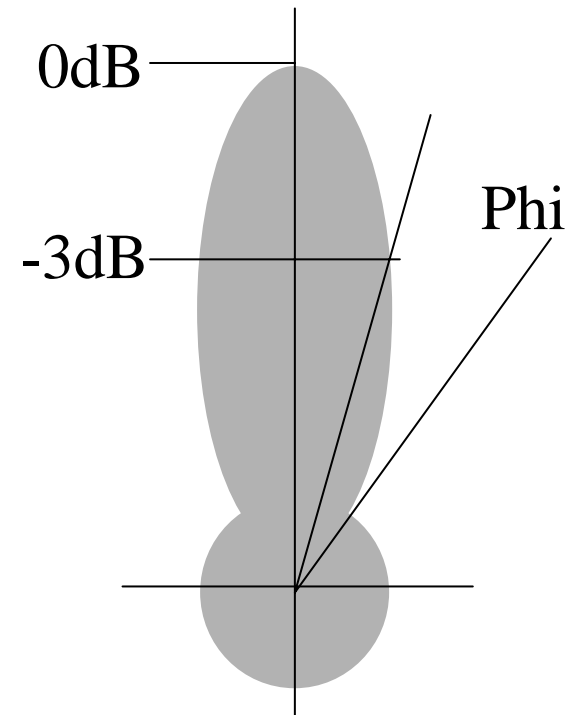
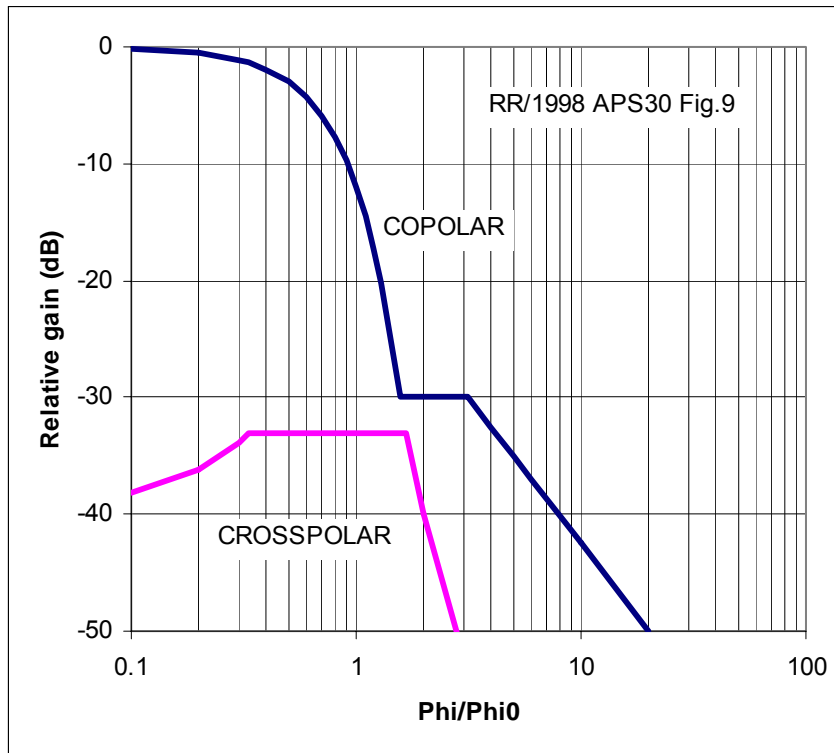

Reference pattern for co-polar and cross-polar components for satellite transmitting antennas in Regions 1 and 3 (Broadcasting ~12 GHz)

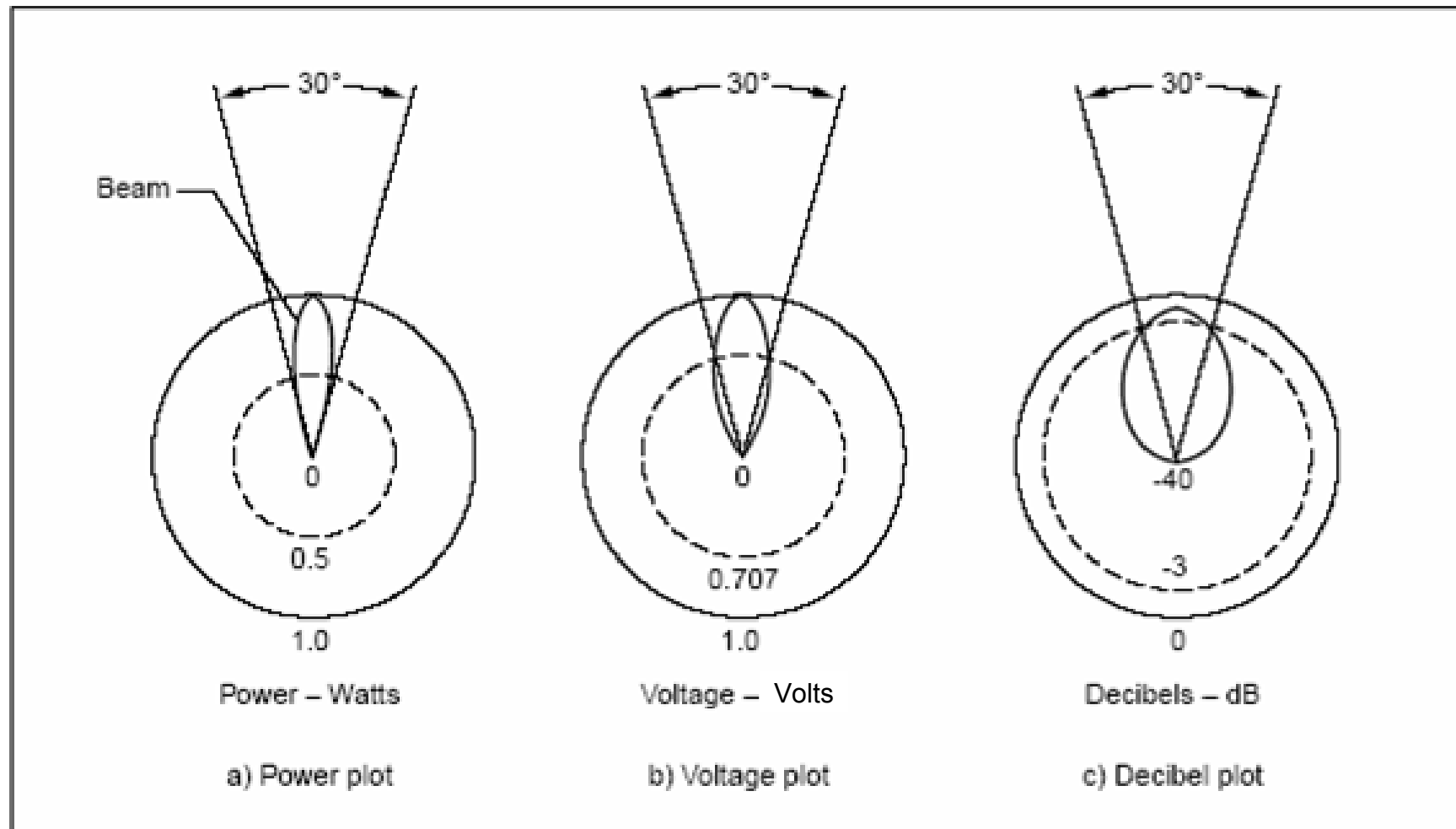

Equivalent half-power beamwidth representations of an antenna's radiation pattern.

# Anisotropic sources: gain

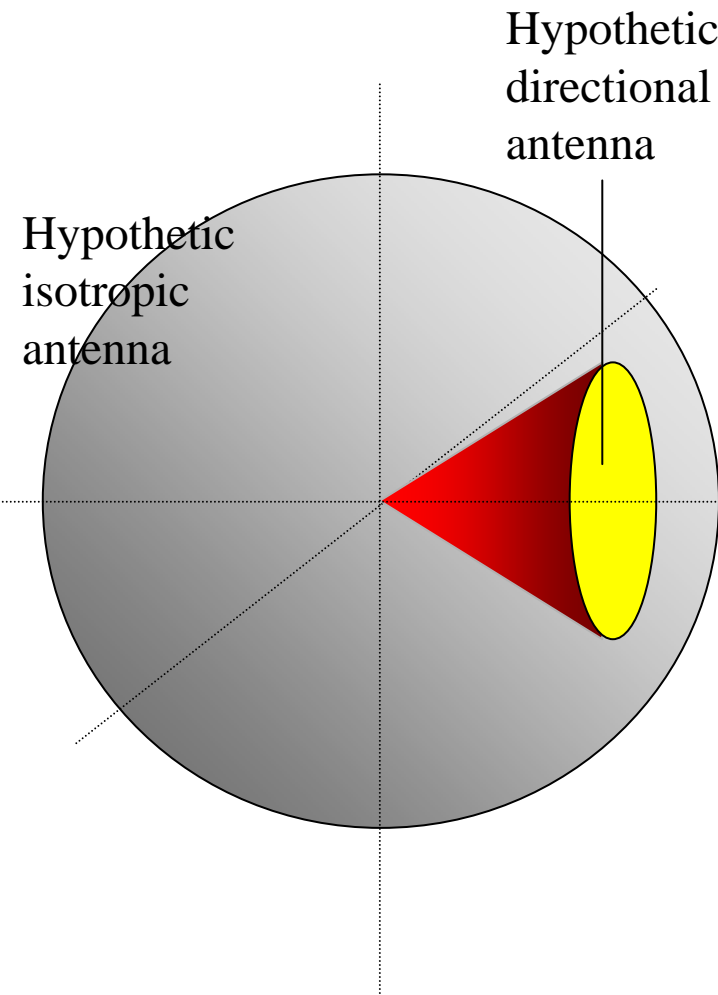

- Every real antenna radiates more energy in some directions than in others (i.e. has directional properties)
- Idealized example of directional antenna: the radiated energy is concentrated in the yellow region (cone).
- Directive antenna gain: the power flux density is increased by (roughly) the inverse ratio of the yellow area and the total surface of the isotropic sphere
  - Gain in the field intensity may also be considered - it is equal to the square root of the power gain.

# Plane angle: radian

- Angle in radians,

$$\omega = l_{\omega} / r; \quad l_{\omega} = \omega * r$$

- $l_{\omega}$  is the length of the arc segment supported by the angle  $\omega$  in a circle of radius  $r$ .

- There are  $2\pi$  rad in a full circle

- $1 \text{ rad} = (360 / 2\pi) \text{ deg}$

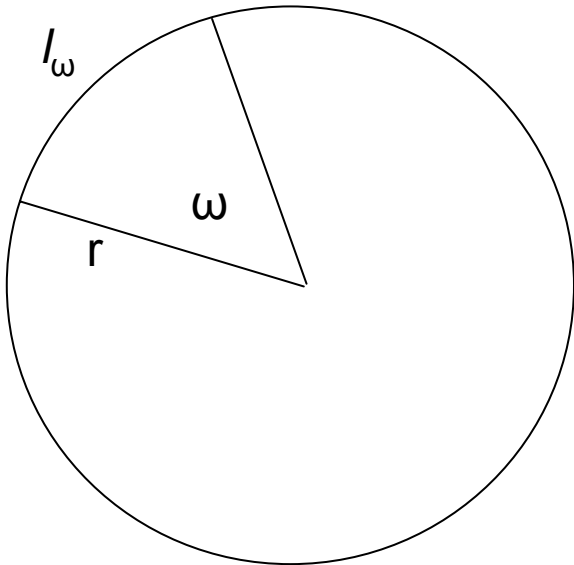

# Solid angle: steradian

- Solid angle in **steradians (sr)**,

$$\Omega = (S_{\Omega})/r^2; \quad S_{\Omega} = \Omega r^2$$

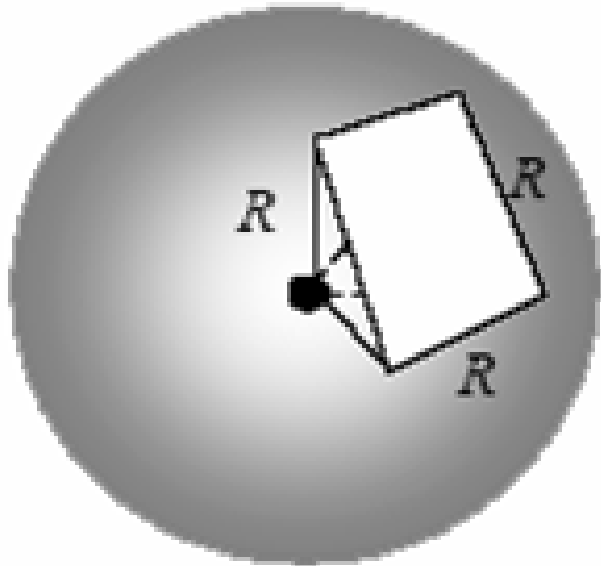

$S_{\Omega}$  is the spherical surface area supported by the solid angle  $\Omega$  in a sphere of radius  $r$

- The steradian is the area cut out by the solid angle, divided by the sphere's radius squared - 'squared radian'.
- If the area is  $S$ , and the radius is  $d$ , then the angle is  $S/d^2$  steradians. The total solid angle (a full sphere) is thus  $4\pi$  steradians.
- As one radian is  $180/\pi = 57.3$  degrees, the total solid angle is  $4\pi \times (57.3)^2 \approx 41253$  square degrees, one steradian is 3282.806 square degrees, and one square degree is about  $305 \times 10^{-6}$  steradians

# Example: gain of 1 deg<sup>2</sup> antenna

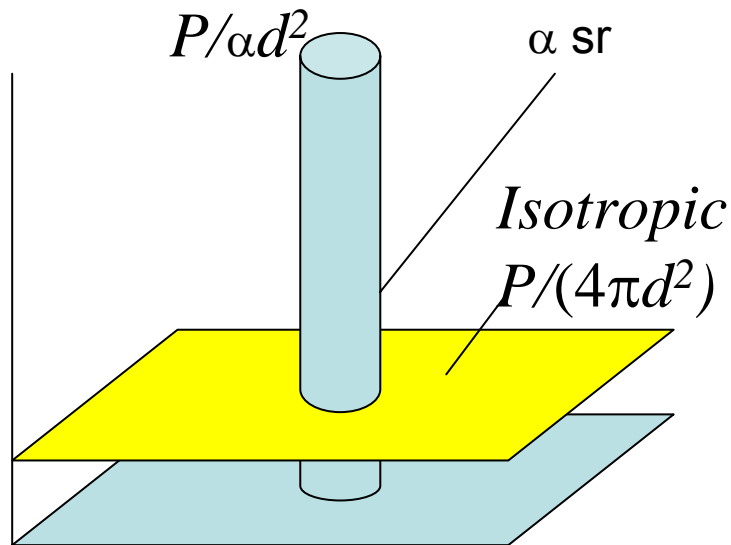

$$G = 4\pi/\alpha$$

If  $\alpha = 1 \text{ deg}^2$ , then

$$G = 4\pi/305 \cdot 10^{-6} = 46 \text{ dB}$$

- A hypothetical source radiates  $P$  watts uniformly within the solid angle of  $\alpha$  steradians in a given direction and zero outside
- The total surface of the sphere is  $4\pi d^2$  and the average irradiance is the power divided by the surface:  $[P/(4\pi d^2)] \text{ w/m}^2$
- $\alpha$  steradians corresponds to spherical surface of  $\alpha d^2$  and irradiance within that angle is  $[P/\alpha d^2] \text{ w/m}^2$
- The antenna gain equals the ratio of these two, or  $4\pi/\alpha$
- For  $\alpha = 1 \text{ deg}^2 (= 305 \cdot 10^{-6} \text{ sr})$ ; the gain =  $4\pi/305 \cdot 10^{-6} = 46 \text{ dB}$ .



# Effect of sidelobes

Let the main beamwidth of an antenna be  $\Omega$  square degrees, with uniform irradiance of  $W$  watts per square meter. Let the sidelobe irradiance (outside the main beam) be uniform and  $k$  times weaker, i.e.  $(W/k)$  watts per square meter,  $k \geq 1$ . Then:

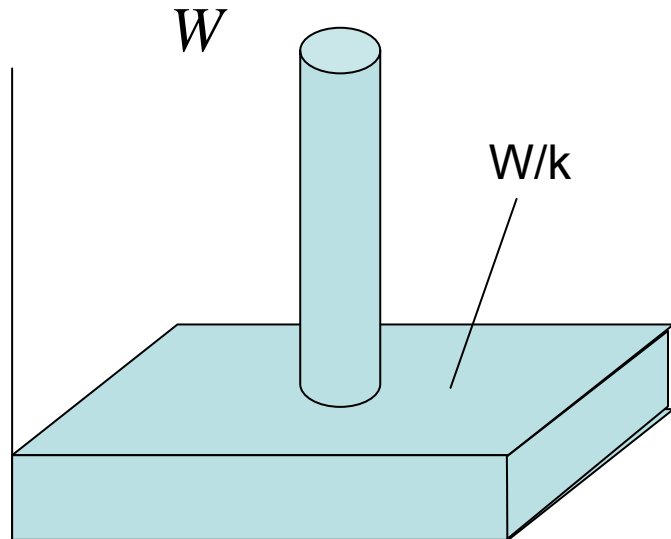

The gain decreases with the sidelobe level and beamwidth.

If the main lobe is 1 square degree and the sidelobes are attenuated by 20 dB, then  $k = 100$  and  $G = 100$  (or 20dB), much less than in the previous example (46dB).

In the limit, when  $k = 1$ , the gain tends to 1 (isotropic antenna).

$$G = \frac{W}{W_0} = \frac{1}{\frac{1}{k} + \left(\frac{k-1}{k}\right) \left(\frac{\Omega}{41253}\right)}$$

$$P_M = W\Omega d^2 \quad - \text{ power radiated within the main lobe}$$

$$P_S = \left(\frac{W}{k}\right)(41253 - \Omega)d^2 \quad - \text{ power radiated by sidelobes}$$

$$P_T = P_M + P_S = Wd^2 \left( \Omega + \frac{41253}{k} - \frac{\Omega}{k} \right) \quad - \text{ total power}$$

$$W_0 = \frac{P_T}{41253d^2} = W \left[ \frac{1}{k} + \frac{k\Omega - \Omega}{41253k} \right] \quad - \text{ average irradiation}$$

$$G = \frac{W}{W_0} = \frac{1}{\frac{1}{k} + \left(\frac{k-1}{k}\right)\left(\frac{\Omega}{41253}\right)} \quad - \text{ antenna gain}$$

# Antenna gain measurement

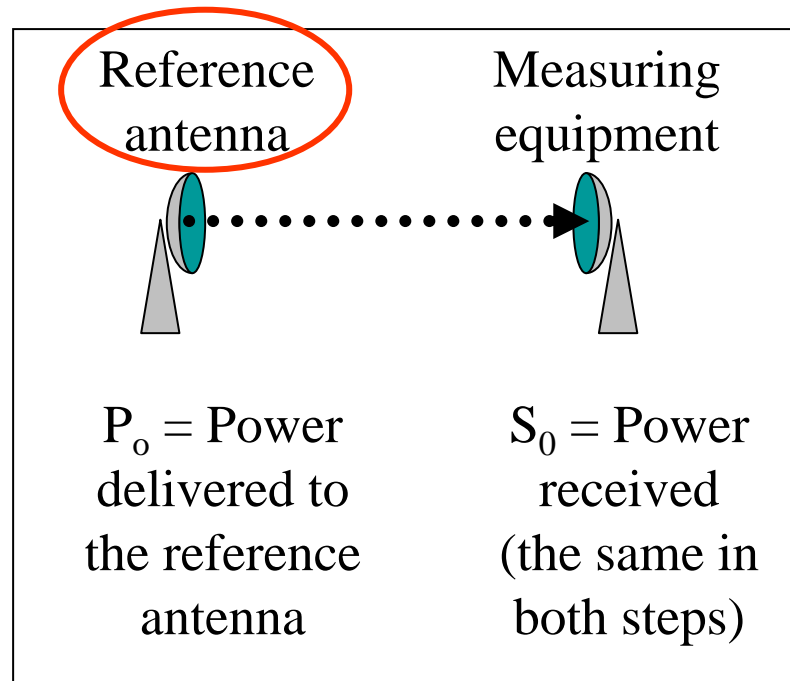

Step 1: reference

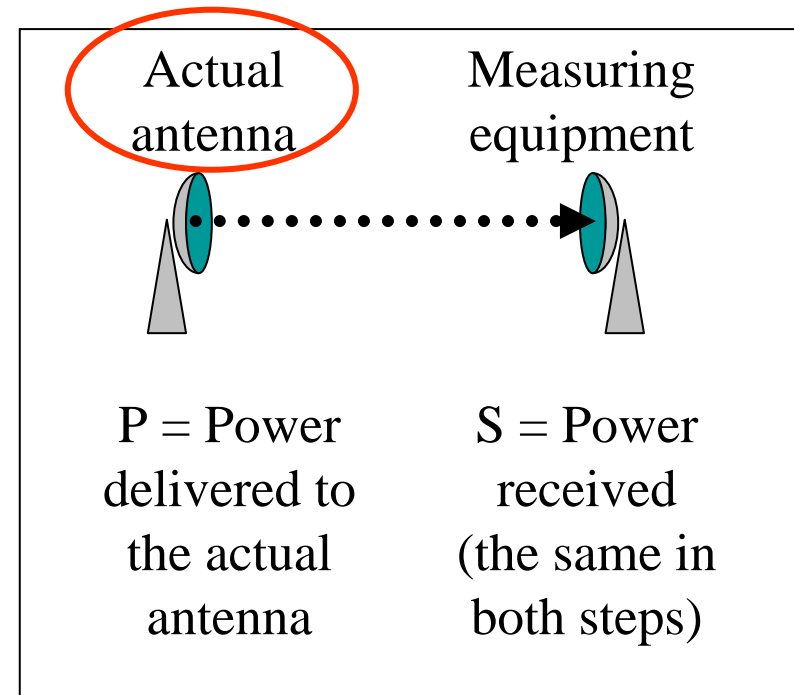

Step 2: substitution

$$\text{Antenna Gain} = (P/P_o)_{S=S_o}$$

# Antenna Gains $G_i$ , $G_d$

- Unless otherwise specified, the gain refers to the direction of maximum radiation.
- Gain is a dimension-less factor related to power and usually expressed in decibels
- $G_i$  “Isotropic Power Gain” – theoretical concept, the reference antenna is isotropic
- $G_d$  - the reference antenna is a half-wave dipole

# Typical Gain and Beamwidth

Type of antenna	$G_i$ [dB]	BeamW.
Isotropic	0	$360^0 \times 360^0$
Half-wave Dipole	2	$360^0 \times 120^0$
Helix (10 turn)	14	$35^0 \times 35^0$
Small dish	16	$30^0 \times 30^0$
Large dish	45	$1^0 \times 1^0$

# Gain, Directivity, Radiation Efficiency

- The radiation intensity, directivity and gain are measures of the ability of an antenna to concentrate power in a particular direction.
- Directivity relates to the power **radiated** by antenna ( $P_0$ )
- Gain relates to the power **delivered** to antenna ( $P_T$ )

$$G(\vartheta, \varphi) = \eta D(\vartheta, \varphi)$$

$$\eta = \frac{P_T}{P_0}$$

- $\eta$ : radiation efficiency (0.5 - 0.75)

# Antenna gain and effective area

- Effective area: Measure of the effective absorption area presented by an antenna to an incident plane wave.
- Depends on the antenna gain and wavelength

$$A_e = \eta \frac{\lambda^2}{4\pi} G(\theta, \varphi) \quad [\text{m}^2]$$

Aperture efficiency:  $\eta_a = A_e / A$

A: physical area of antenna's aperture, square meters

# Power Transfer in Free Space

$$\begin{aligned} P_R &= PFD \cdot A_e \\ &= \left( \frac{G_T P_T}{4\pi r^2} \right) \left( \frac{\lambda^2 G_R}{4\pi} \right) \\ &= P_T G_T G_R \left( \frac{\lambda}{4\pi r} \right)^2 \end{aligned}$$

- $\lambda$ : wavelength [m]
- $P_R$ : power available at the receiving antenna
- $P_T$ : power delivered to the transmitting antenna
- $G_R$ : gain of the transmitting antenna in the direction of the receiving antenna
- $G_T$ : gain of the receiving antenna in the direction of the transmitting antenna
- Matched polarizations



# e.i.r.p.

- Equivalent Isotropically Radiated Power (in a given direction):

$$e.i.r.p. = PG_i$$

- The product of the power supplied to the antenna and the antenna gain (relative to an isotropic antenna) in a given direction

# Linear Polarization

- In a linearly polarized plane wave the direction of the E (or H) vector is constant .

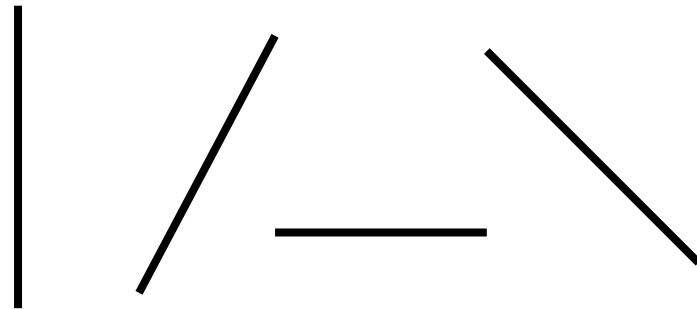

# Polarization ellipse

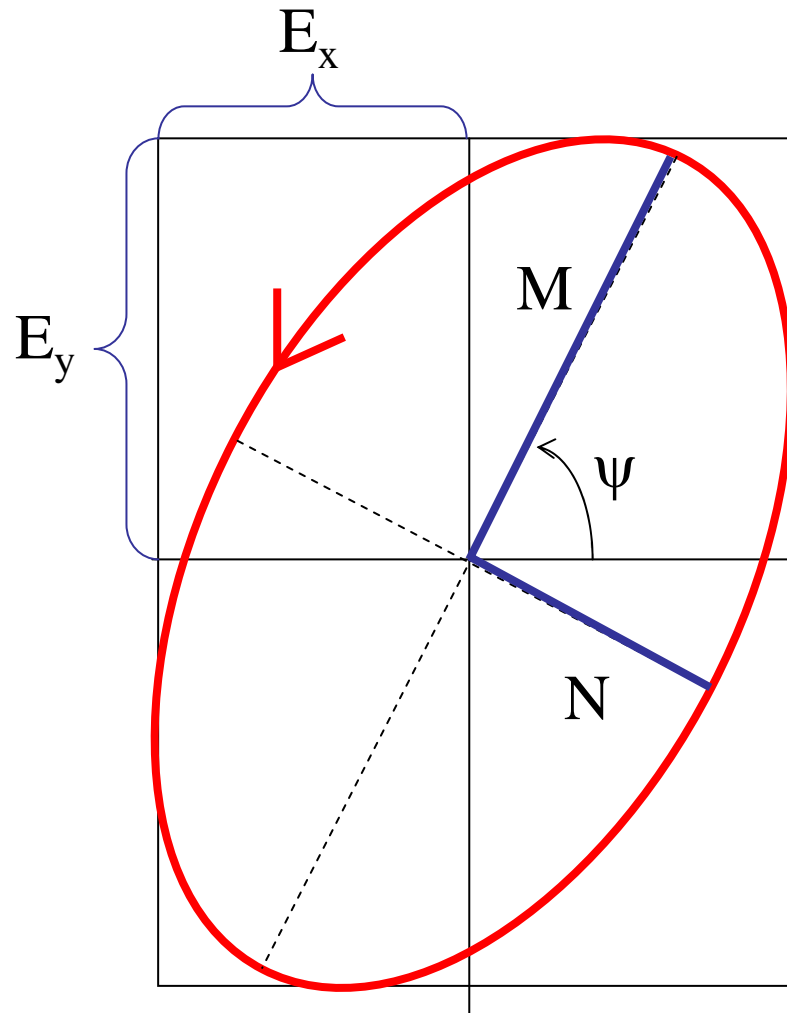

- The superposition of two coherent plane-wave components results in an elliptically polarized wave
- The polarization ellipse is defined by its axial ratio  $N/M$  (ellipticity), tilt angle  $\psi$  and sense of rotation
- Polarization (Java applet): <http://www.amanogawa.com/archive/wavesA.html>

# Elliptical Polarization

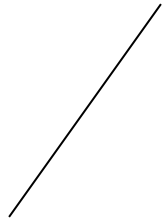

$$E_x = \cos(\omega t)$$

$$E_y = \cos(\omega t)$$

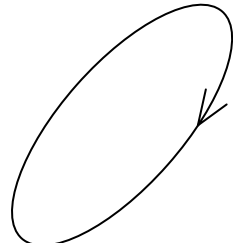

$$E_x = \cos(\omega t)$$

$$E_y = \cos(\omega t + \pi/4)$$

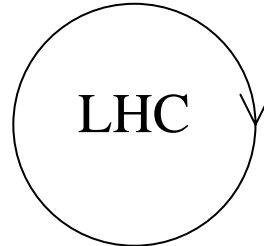

$$E_x = \cos(\omega t)$$

$$E_y = -\sin(\omega t)$$

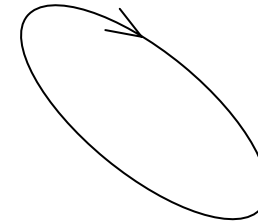

$$E_x = \cos(\omega t)$$

$$E_y = \cos(\omega t + 3\pi/4)$$

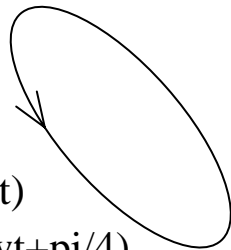

$$E_x = \cos(\omega t)$$

$$E_y = -\cos(\omega t + \pi/4)$$

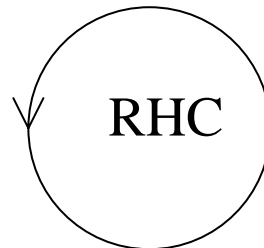

$$E_x = \cos(\omega t)$$

$$E_y = \sin(\omega t)$$

# Polarization states

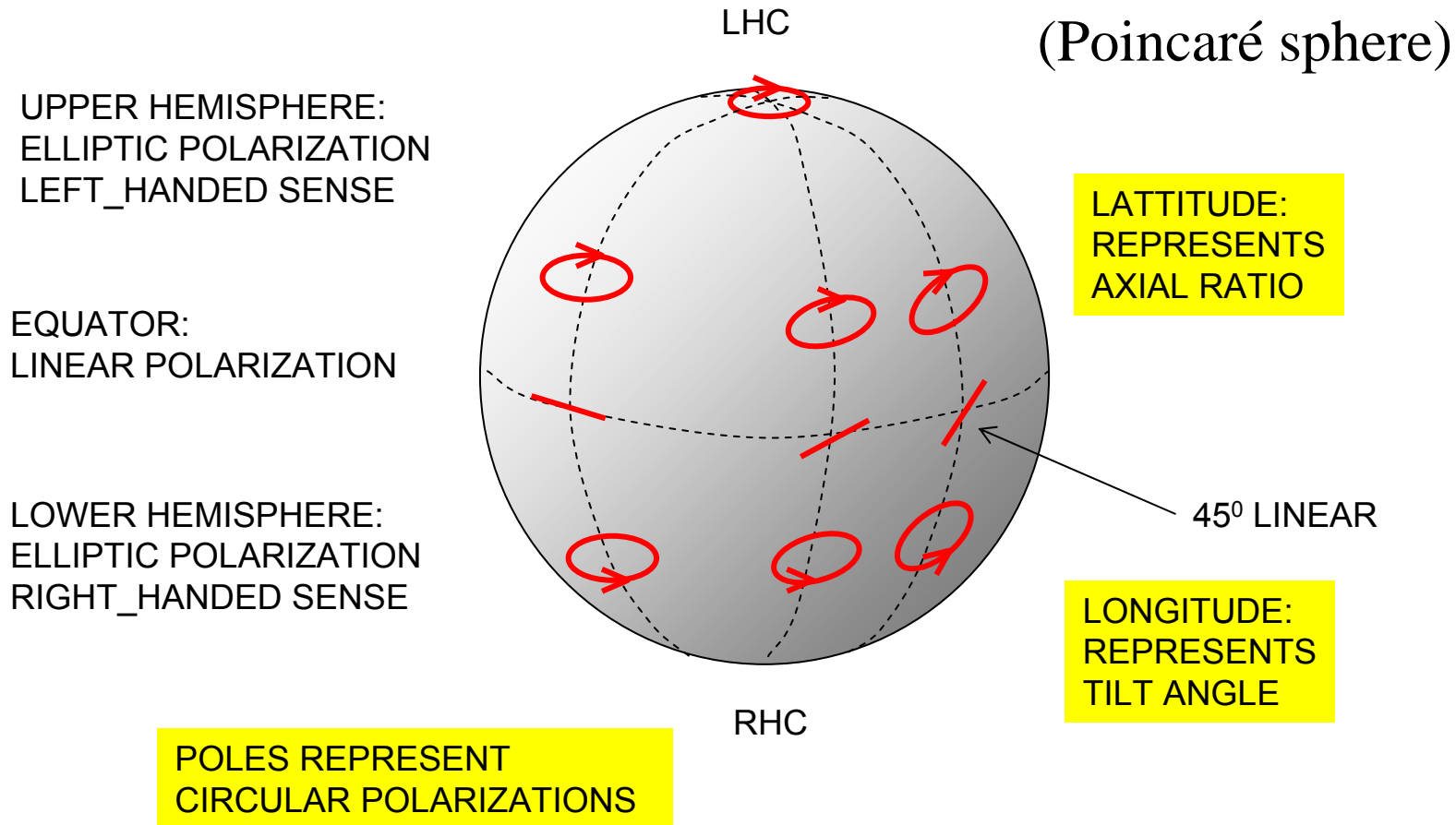

# Comments on Polarization

- At any moment in a chosen reference point in space, there is actually a single electric vector  $E$  (and associated magnetic vector  $H$ ).
- This is the result of superposition (addition) of the instantaneous fields  $E$  (and  $H$ ) produced by all radiation sources active at the moment.
- The separation of fields by their wavelength, polarization, or direction is the result of 'filtration'.

# Antenna Polarization

- The polarization of an antenna in a specific direction is defined to be the polarization of the wave produced by the antenna at a great distance at this direction

# Polarization Efficiency

- The power received by an antenna from a particular direction is maximal if the polarization of the incident wave and the polarization of the antenna in the wave arrival direction have:
  - the same axial ratio
  - the same sense of polarization
  - the same spatial orientation

▪



# Polarization filters/ reflectors

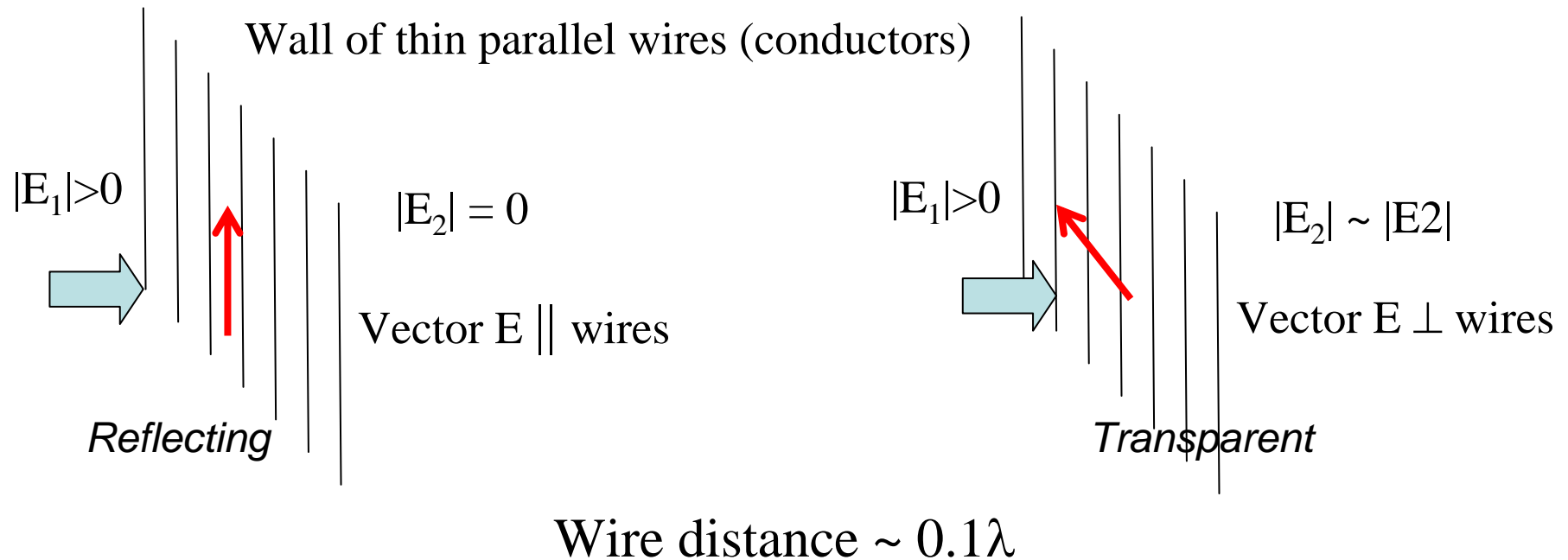

- At the surface of ideal conductor the tangential electrical field component = 0

# Outline

- Introduction
- Review of basic antenna types
- Radiation pattern, gain, polarization
- **Equivalent circuit & radiation efficiency**
- Smart antennas
- Some theory
- Summary

# Transmitting antenna equivalent circuit

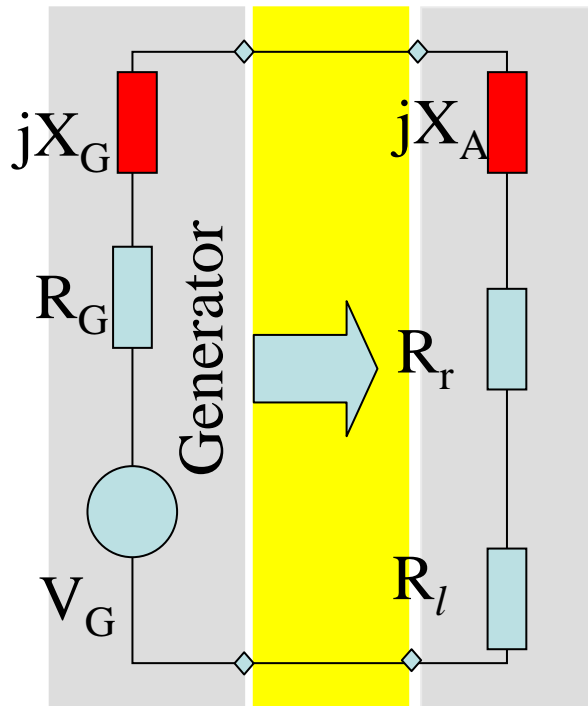
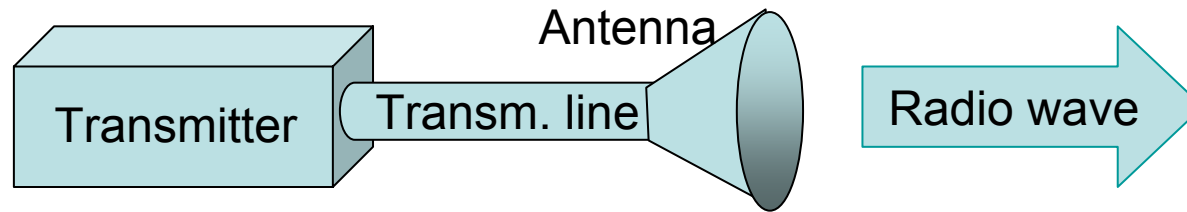

The transmitter with the transmission line is represented by an (Thevenin) equivalent generator

The antenna is represented by its input impedance (which is frequency-dependent and is influenced by objects nearby) as seen from the generator

$jX_A$  represents energy stored in electric ( $E_e$ ) and magnetic ( $E_m$ ) near-field components; if  $|E_e| = |E_m|$  then  $X_A = 0$  (antenna resonance)

$R_r$  represents energy radiated into space (far-field components)

$R_l$  represents energy lost, i.e. transformed into heat in the antenna structure

Note: Transmission-line model offers better approximation

# Power transfer: Tx antenna

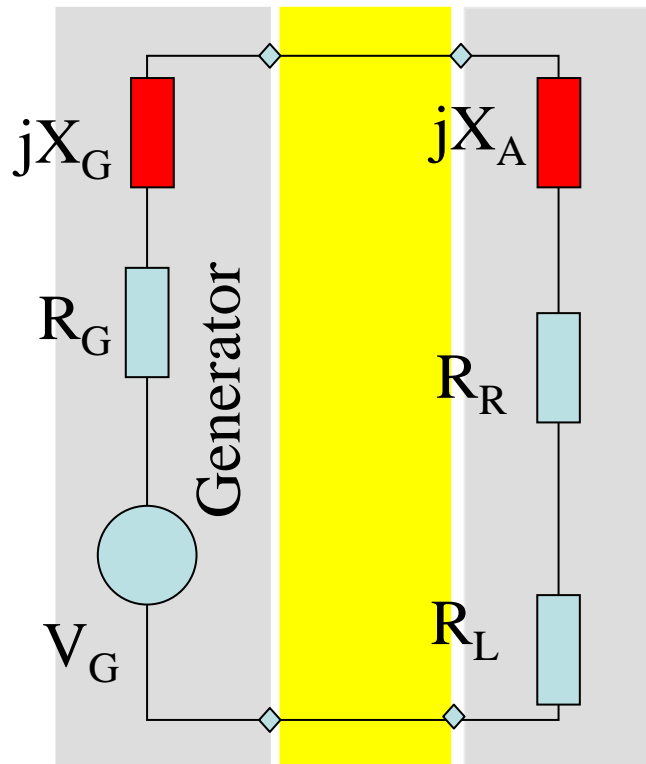

Transmitter is represented by an equivalent generator with  $V_G, R_G, X_G = \text{const.}$

Let  $R_A = R_R + R_L; R_A, X_A = \text{var.}$

The power absorbed by antenna  $P = I^2 R_A$

$$I^2 = \left[ \frac{V_G}{\sqrt{(R_G + R_A)^2 + (X_G + X_A)^2}} \right]^2$$

$$P = V_G^2 \frac{R_A}{(R_G + R_A)^2 + (X_G + X_A)^2}$$

$$P = \left( \frac{V_G^2}{R_G} \right) \frac{\frac{R_A}{R_G}}{\left( 1 + \frac{R_A}{R_G} \right)^2 + \left( \frac{X_G}{R_G} + \frac{X_A}{R_G} \right)^2}$$

$$P = V_G^2 \frac{R_A}{(R_G + R_A)^2 + X_G^2 + 2X_G X_A + X_A^2}$$

$$\frac{\partial P}{\partial X_A} = V_G^2 \left( -\frac{R_A (2X_G + 2X_A)}{\left[ (R_G + R_A)^2 + (X_G + X_A)^2 \right]^2} \right)$$

$$\frac{\partial P}{\partial X_A} = 0, \quad \text{when } X_A = -X_G$$

$$\text{Maximum: } \frac{\partial P}{\partial R_A} + \frac{\partial P}{\partial X_A} = 0$$

$$R_A = R_G, \quad X_A = -X_G$$

$$P = \frac{V_G^2}{4R_G}$$

$$\text{Let } X_G + X_A = 0. \text{ Then } P = V_G^2 \frac{R_A}{(R_G + R_A)^2}$$

$$\frac{\partial P}{\partial R_A} = V_G^2 \left( \frac{(R_G + R_A)^2 - R_A 2(R_G + R_A)}{\left[ (R_G + R_A)^2 \right]^2} \right) =$$

$$= V_G^2 \left( \frac{R_G^2 + 2R_G R_A + R_A^2 - 2R_G R_A - 2R_A^2}{\left[ (R_G + R_A)^2 \right]^2} \right)$$

$$\frac{\partial P}{\partial R_A} = 0, \quad \text{when } R_G = R_A$$

# Impedance matching

$$R_A = R_r + R_l = R_g$$

$$X_A = -X_g$$

$$P_A = \frac{|V_g|^2}{4R_A}$$

$$P_g = \frac{|V_g|^2}{4R_g} \quad (= P_A)$$

$$P_r = P_A \frac{R_r}{(R_r + R_l)}$$

$$P_l = P_A \frac{R_l}{(R_r + R_l)}$$

# Power vs. field strength

$$P_r = \frac{|E|^2}{Z_0} \rightarrow |E| = \sqrt{P_r Z_0}$$

$$|E| = \sqrt{E_\theta^2 + E_\phi^2}$$

$$|H| = \frac{|E|}{Z_0}$$

$$Z_0 = 377 \text{ ohms}$$

for plane wave  
in free space

# Receiving antenna equivalent circuit

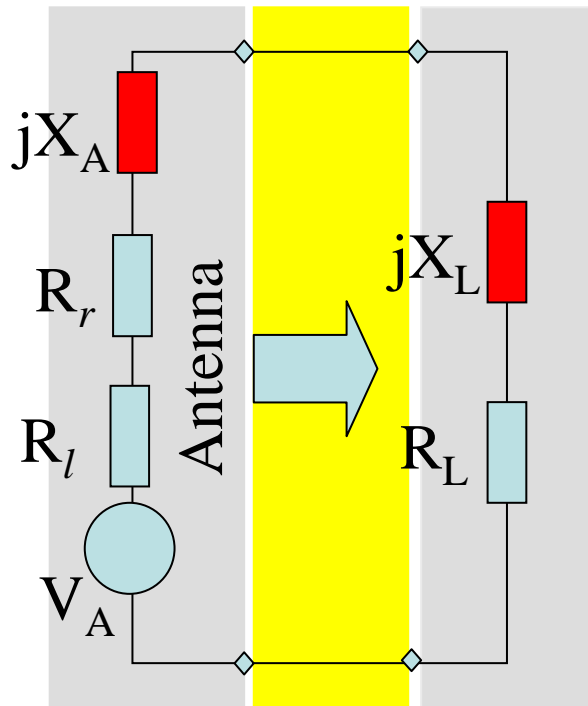
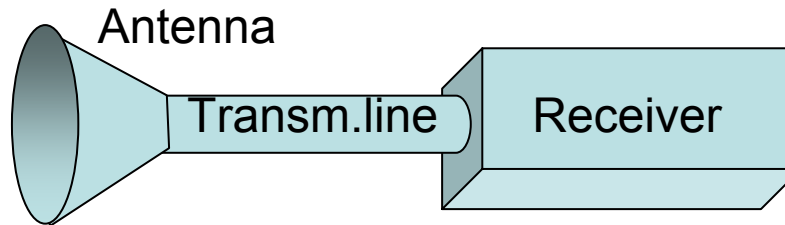
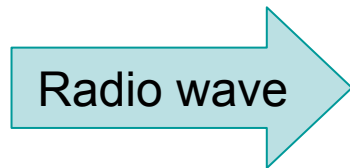

Thevenin equivalent

The antenna with the transmission line is represented by an (Thevenin) equivalent generator

The receiver is represented by its input impedance as seen from the antenna terminals (i.e. transformed by the transmission line)

$V_A$  is the (induced by the incident wave) voltage at the antenna terminals determined when the antenna is open circuited

Note1: The antenna impedance is the same when the antenna is used to radiate and when it is used to receive energy

Note 2: Transmission-line model offers better approximation



# Power transfer

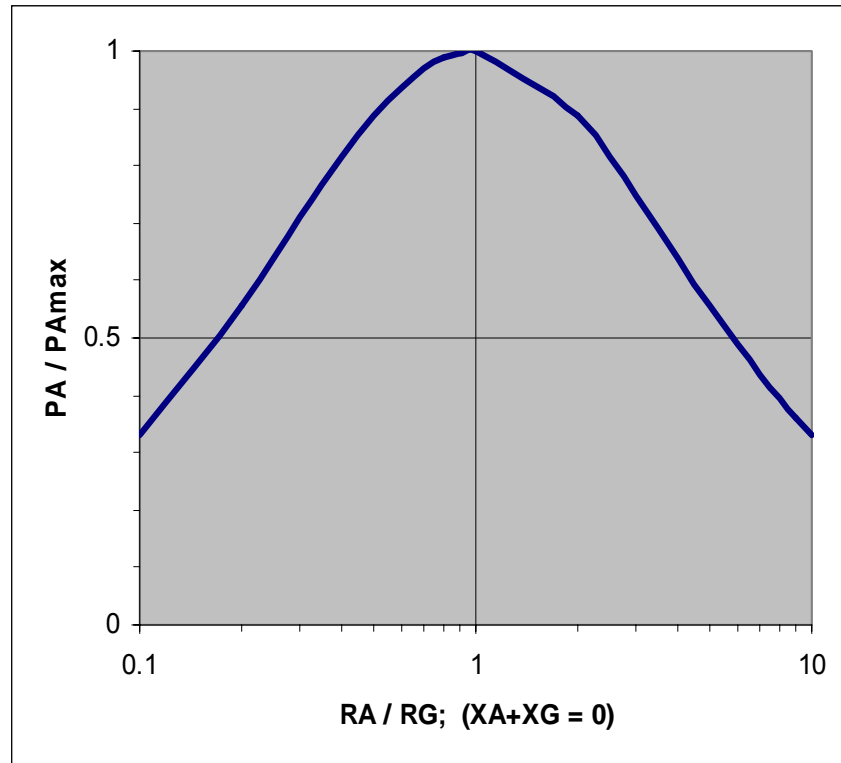

- The maximum power is delivered to (or from) the antenna when the antenna impedance and the impedance of the equivalent generator (or load) are matched

- When the impedances are matched
  - Half of the source power is delivered to the load and half is dissipated within the (equivalent) generator as heat
  - In the case of receiving antenna, a part ( $P_l$ ) of the power captured is lost as heat in the antenna elements, the other part being reradiated (scattered) back into space
    - Even when the antenna losses tend to zero, still only half of the power captured is delivered to the load (in the case of conjugate matching), the other half being scattered back into space

- The antenna impedance must be matched to the transmitter output impedance (or to the receiver input impedance) and to transmission line between them to assure effective power transfer
- Inexpensive impedance-matching devices are usually narrow-band

# Radiation efficiency

- The radiation efficiency  $e$  indicates how efficiently the antenna uses the RF power
- It is the ratio of the power radiated by the antenna and the total power delivered to the antenna terminals (in transmitting mode). In terms of equivalent circuit parameters:

$$e = \frac{R_r}{R_r + R_l}$$

# Outline

- Introduction
- Review of basic antenna types
- Radiation pattern, gain, polarization
- Equivalent circuit & radiation efficiency
- **Smart antennas**
- Some theory
- Summary

# Antenna arrays

- Consist of multiple (usually identical) antennas (elements) 'collaborating' to synthesize radiation characteristics not available with a single antenna. They are able
  - to match the radiation pattern to the desired coverage area
  - to change the radiation pattern electronically (electronic scanning) through the control of the phase and the amplitude of the signal fed to each element
  - to adapt to changing signal conditions
  - to increase transmission capacity by better use of the radio resources and reducing interference
- Complex & costly
  - Intensive research related to military, space, etc. activities
    - » Smart antennas, signal-processing antennas, tracking antennas, phased arrays, etc.

# Satellite antennas (TV)



- Not an array!

# Owens Valley Radio Observatory Array



The Earth's atmosphere is transparent in the narrow visible-light window (4000-7000 angstroms) and the radio band between 1 mm and 10 m.

[Sky & Telescope  
Feb 1997 p.26]



# New Mexico Very Large Array

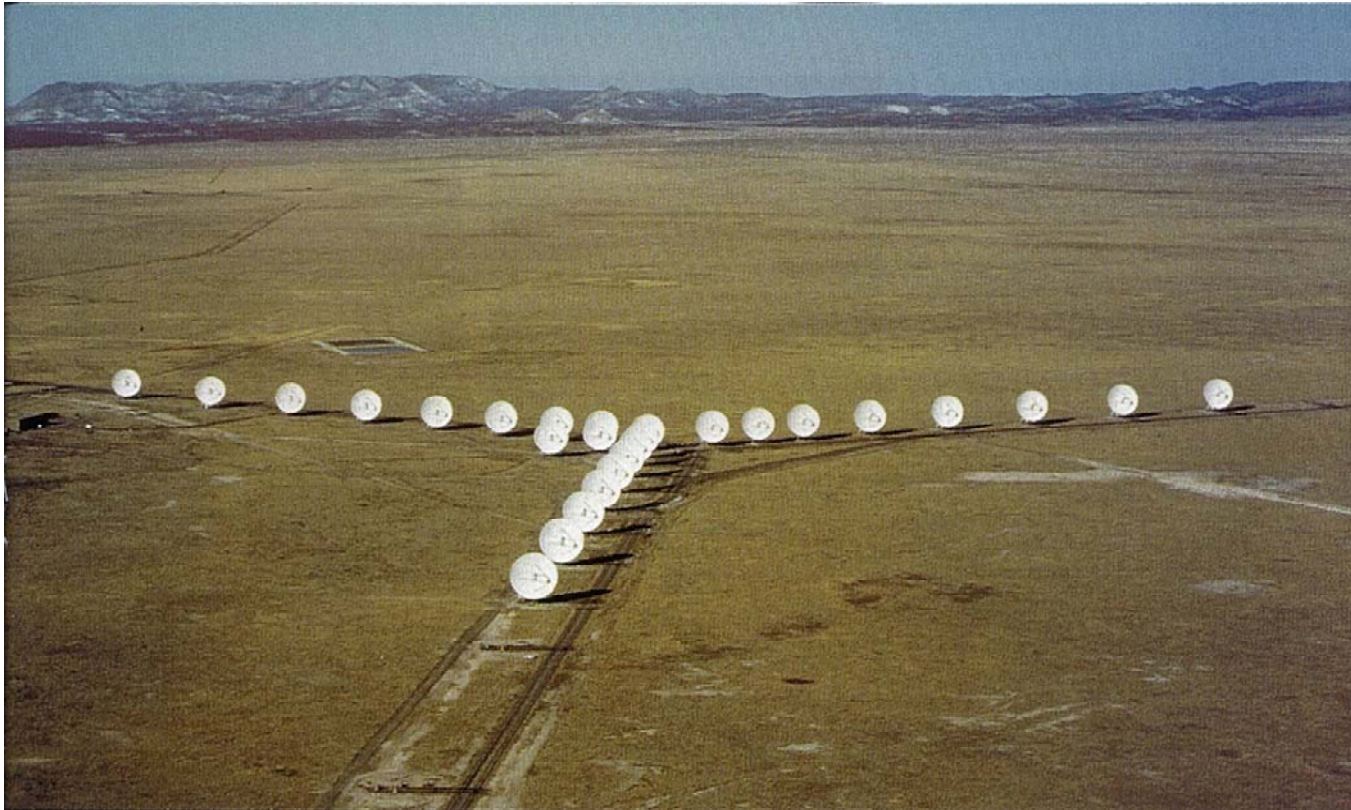

[Sky & Telescope  
Feb 1997 p. 30]

27 antennas along 3 railroad tracks provide baselines up to 35 km. Radio images are formed by correlating the signals garnered by each antenna.

R Struzak

89

# 2 GHz adaptive antenna array



- A set of 48  
2 GHz  
antennas
  - Source:  
Arraycomm

# Phased Arrays

- Array of N antennas in a linear or two-dimensional configuration + beam-forming & control device
- The amplitude and phase excitation of each individual antenna controlled electronically (“software-defined”)
  - Diode phase shifters
  - Ferrite phase shifters
- Inertia-less beam-forming and scanning ( $\mu\text{sec}$ ) with fixed physical structure

# Simulation

- 2 omnidirectional antennas (equal amplitudes)
  - Variables
    - distance increment
    - phase increment
- N omnidirectional antennas
  - Group factor (N omnidirectional antennas uniformly distributed along a straight line, equal amplitudes, equal phase increment)

# 2 omnidirectional antennas

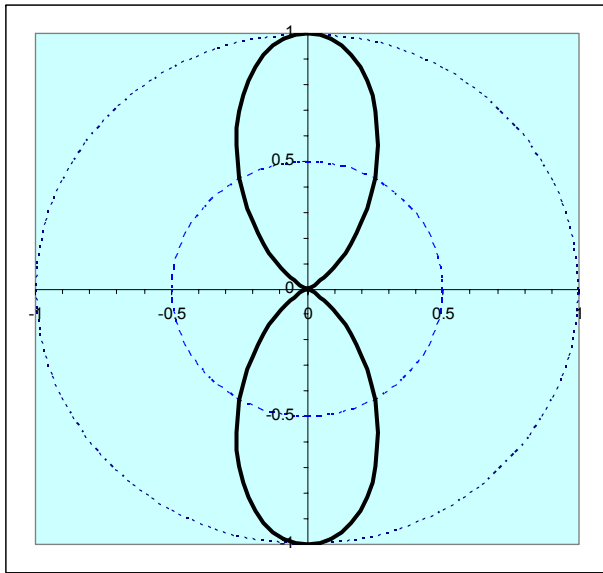

$$D = 0.5\lambda, \theta = 0^\circ$$

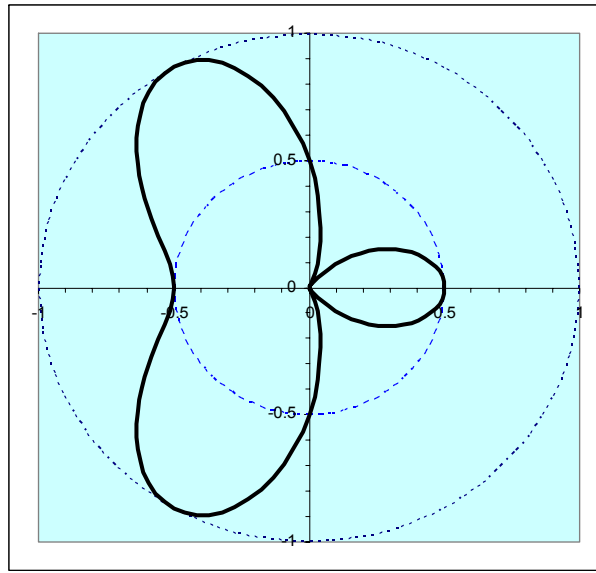

$$D = 0.5\lambda, \theta = 90^\circ$$

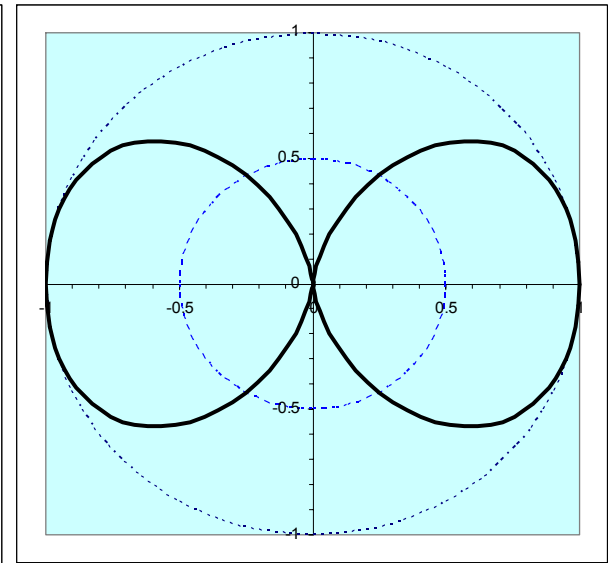

$$D = 0.5\lambda, \theta = 180^\circ$$

- Java applet 2 antennas:
- Simple demo: <http://www.amanogawa.com/archive/TwoDipole/Antenna2-2.html>
- Detailed analysis: <http://www.amanogawa.com/archive/Antenna2/Antenna2-2.html>

# N omnidirectional antennas

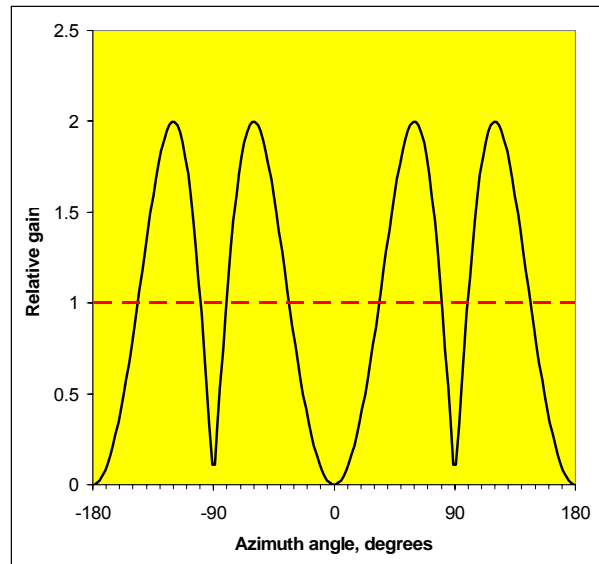

$N = 2, \theta = 90^\circ$

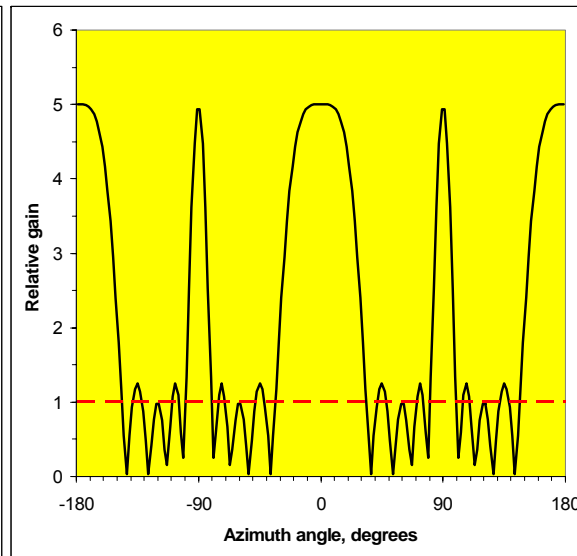

$N = 5, \theta = 180^\circ$

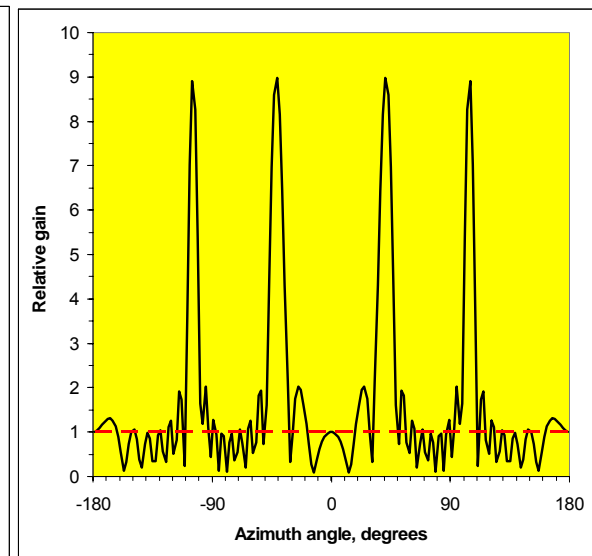

$N = 9, \theta = 45^\circ$

- Array gain (line, uniform, identical power)

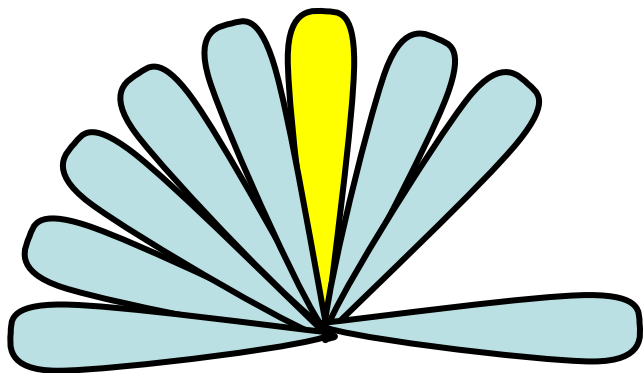

- *Switched beam antennas*
  - Based on switching function between separate directive antennas or predefined beams of an array
- *Space Division Multiple Access (SDMA)* = allocating an angle direction sector to each user
  - In a TDMA system, two users will be allocated to the same time slot and the same carrier frequency
  - They will be differentiated by different direction angles

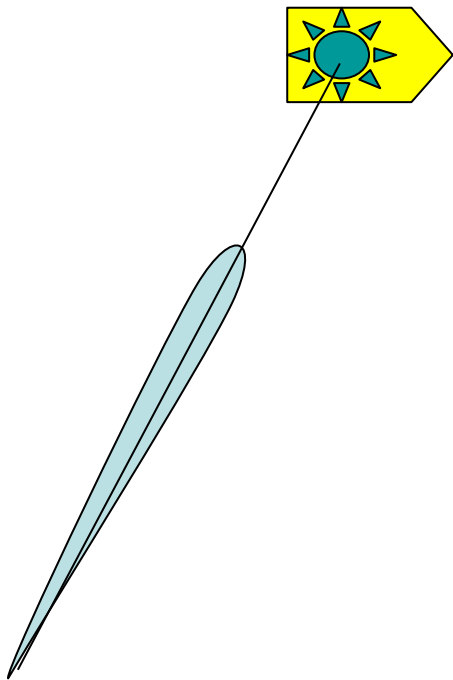

- *Dynamically phased array (PA):*
  - A generalization of the switched lobe concept
  - The radiation pattern continuously track the designated signal (user)
  - Include a *direction of arrival* (DoA) tracking algorithm



# Beam Steering

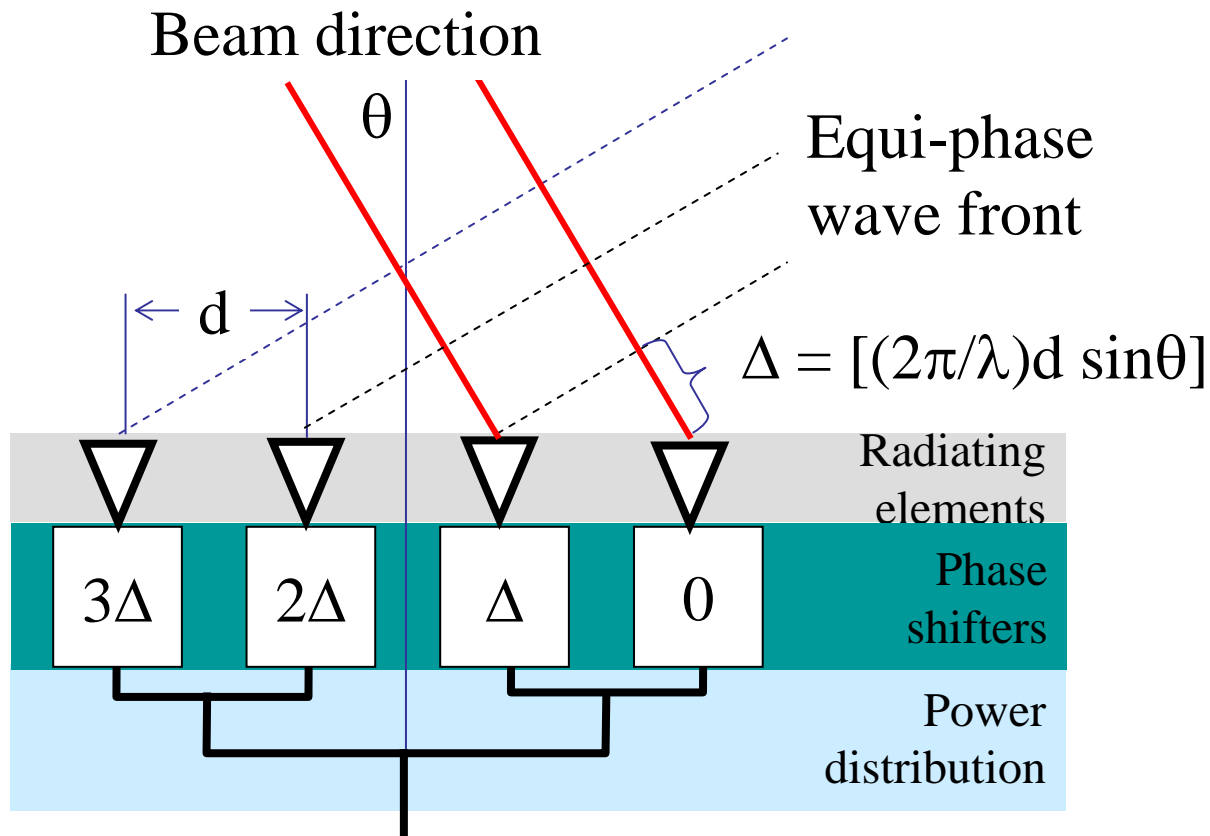

- Beam-steering using phase shifters at each radiating element

# 4-Bit Phase-Shifter (Example)

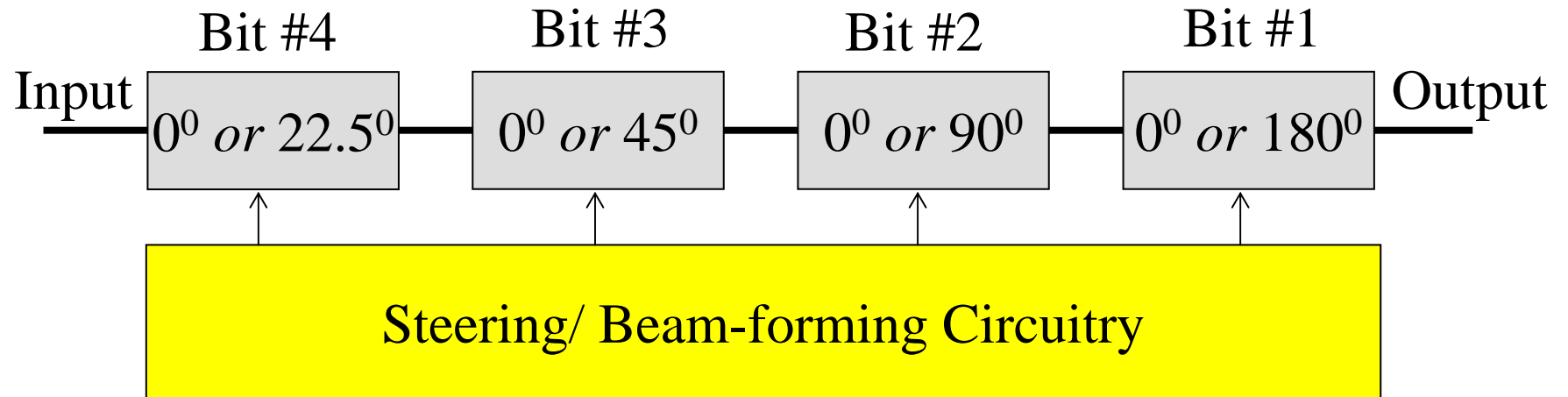

Alternative solution: Transmission line with controlled delay

# Switched-Line Phase Bit

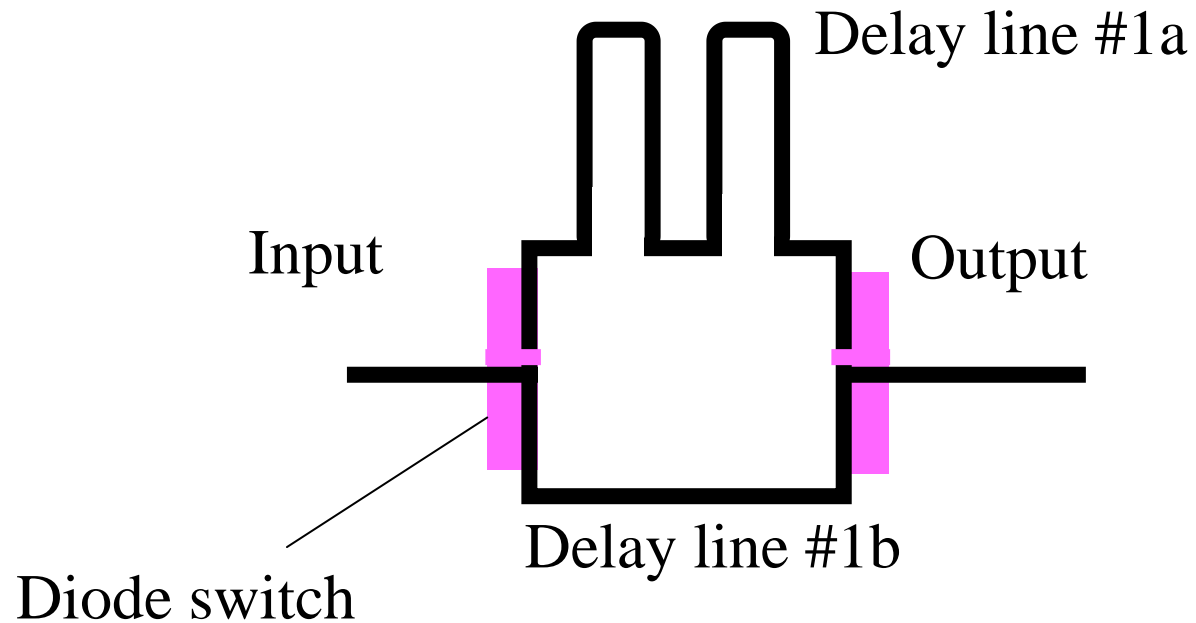

Phase bit = delay difference

# Antenna Arrays: Benefits

- Possibilities to control electronically
  - Direction of maximum radiation
  - Directions (positions) of nulls
  - Beam-width
  - Directivity
  - Levels of sidelobes

using standard antennas (or antenna collections)  
independently of their radiation patterns

- Antenna elements can be distributed along straight lines, arcs, squares, circles, etc.

# Adaptive (“Intelligent”)Antennas

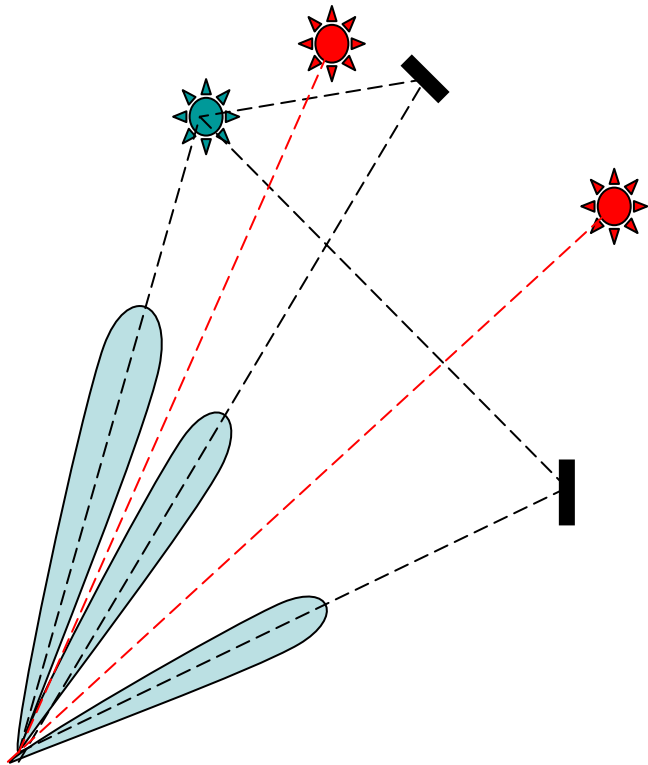

- Array of  $N$  antennas in a linear, circular, or planar configuration
- Used for selection signals from desired sources and suppress incident signals from undesired sources
- The antenna pattern track the sources
- It is then adjusted to null out the interferers and to maximize the signal to interference ratio (SIR)
- Able to receive and combine constructively multipath signals

- The amplitude/ phase excitation of each antenna controlled electronically (“software-defined”)
- The weight-determining algorithm uses a-priori and/ or measured information to adapt antenna to changing environment
- The weight and summing circuits can operate at the RF and/ or at an intermediate frequency

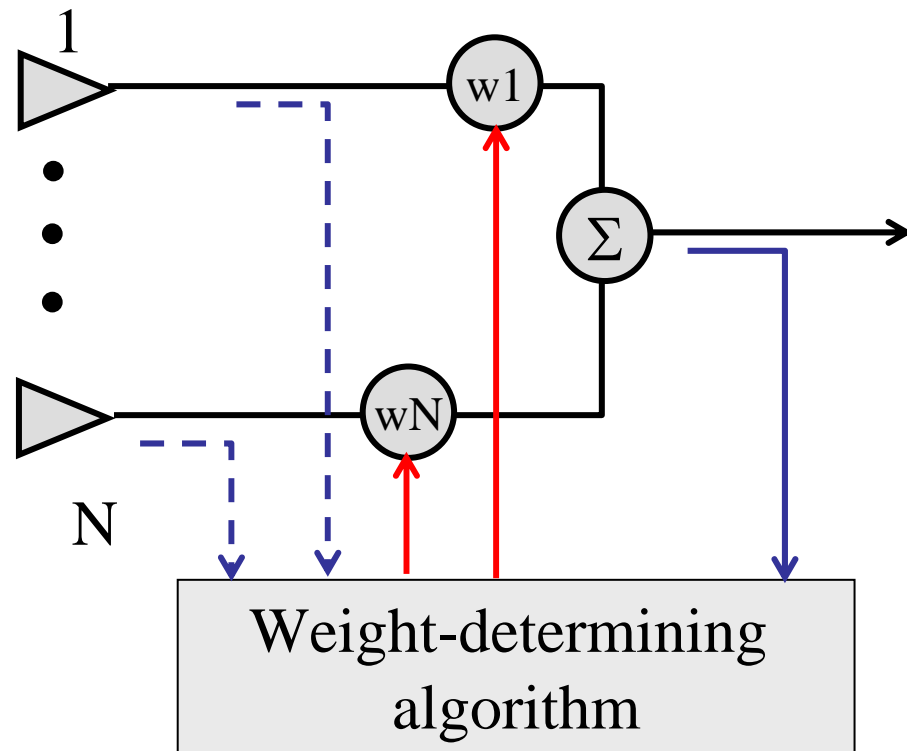

# Antenna sitting

- Radio horizon
- Effects of obstacles & structures nearby
- Safety
  - operating procedures
  - Grounding
    - lightning strikes
    - static charges
  - Surge protection
    - lightning searches for a second path to ground

# Outline

- Introduction
- Review of basic antenna types
- Radiation pattern, gain, polarization
- Equivalent circuit & radiation efficiency
- Smart antennas
- **Some theory**
- Summary



# Maxwell's Equations

- EM field interacting with the matter
  - 2 coupled vectors  $E$  and  $H$  (6 numbers!), varying with time and space and satisfying the boundary conditions  
(see <http://www.amanogawa.com/archive/docs/EM1.pdf>;  
<http://www.amanogawa.com/archive/docs/EM7.pdf>;  
<http://www.amanogawa.com/archive/docs/EM5.pdf>)
- Reciprocity Theorem
  - Antenna characteristics do not depend on the direction of energy flow. The impedance & radiation pattern are the same when the antenna radiates signal and when it receives it.
  - Note: This theorem is valid only for linear passive antennas (i.e. antennas that do not contain nonlinear and unilateral elements, e.g. amplifiers)
- Fourier transform

# EM Field of Current Element

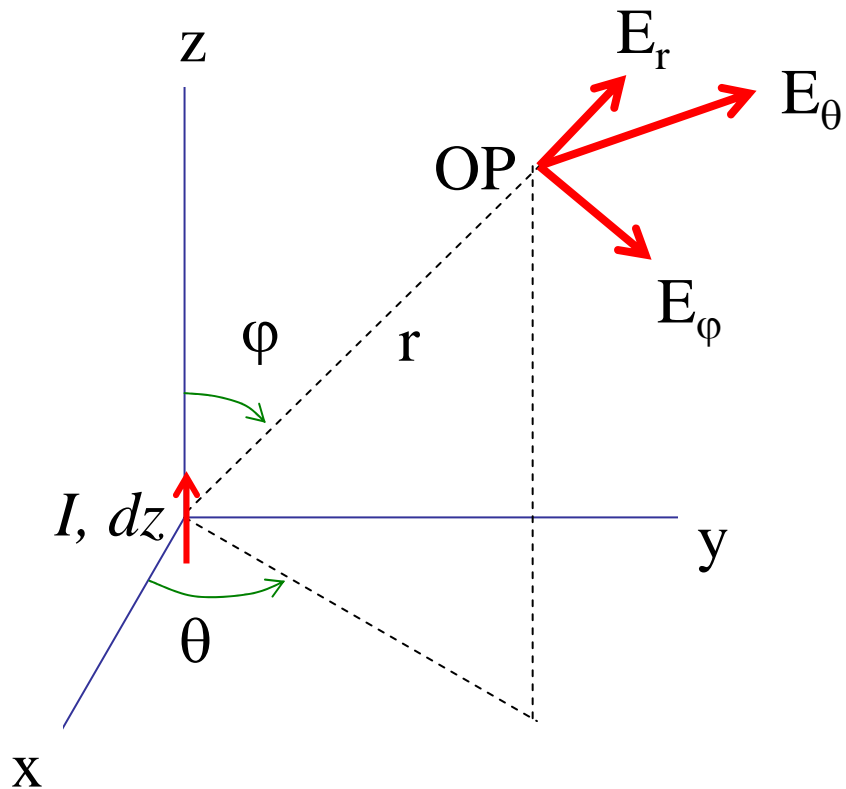

$$\vec{E} = \vec{E}_r + \vec{E}_\theta + \vec{E}_\phi$$

$$\vec{H} = \vec{H}_r + \vec{H}_\theta + \vec{H}_\phi$$

$$|E| = \sqrt{|E_r|^2 + |E_\theta|^2 + |E_\phi|^2}$$

$$|H| = \sqrt{|H_r|^2 + |H_\theta|^2 + |H_\phi|^2}$$

$I$ : current (monochromatic) [A];  $dz$ : antenna element (short) [m]

# Short dipole antenna: summary

- $E_\theta$  &  $H_\theta$  are maximal in the equatorial plane, zero along the antenna axis
- $E_r$  is maximal along the antenna axis  $dz$ , zero in the equatorial plane
- All show axial symmetry
- All are proportional to the current moment  $I dz$
- Have 3 components that decrease with the distance-to-wavelength ratio as
  - $(r/\lambda)^{-2}$  &  $(r/\lambda)^{-3}$ : near-field, or induction field. The energy oscillates from entirely electric to entirely magnetic and back, twice per cycle. Modeled as a resonant LC circuit or resonator;
  - $(r/\lambda)^{-1}$ : far-field or radiation field
  - These 3 component are all equal at  $(r/\lambda) = 1/(2\pi)$

$\beta$

# Field components

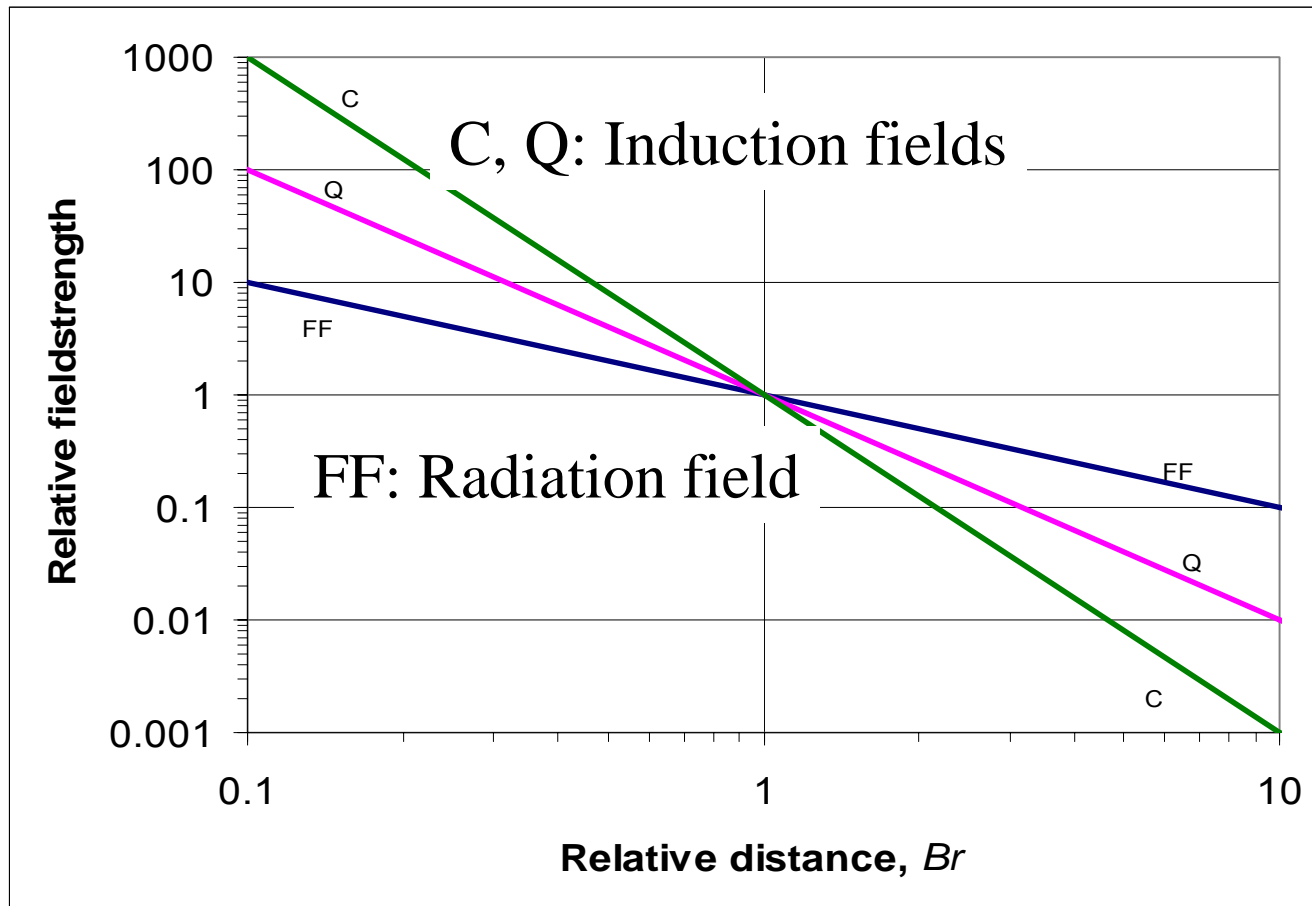

# Field impedance

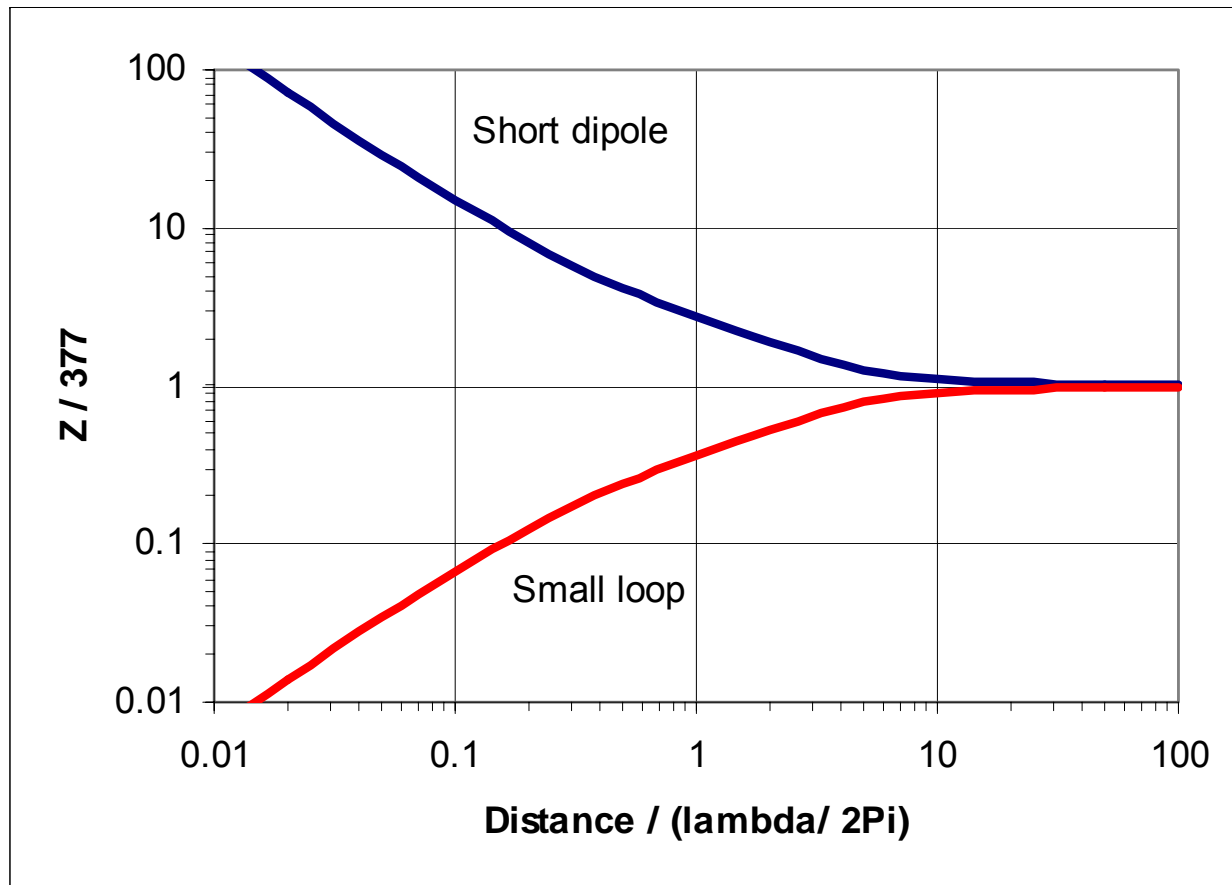

Field impedance  
 $Z = E/H$  depends on the antenna type and on distance

# Far-Field, Near-Field

- Near-field region:
  - Angular distribution of energy depends on distance from the antenna;
  - Reactive field components dominate (L, C)
- Far-field region:
  - Angular distribution of energy is independent on distance;
  - Radiating field component dominates (R)
  - The resultant EM field can locally be treated as uniform (TEM)

# Poynting vector

- The time-rate of EM energy flow per unit area in free space is the *Poynting vector* (see <http://www.amanogawa.com/archive/docs/EM8.pdf>).
- It is the cross-product (vector product, right-hand screw direction) of the electric field vector ( $E$ ) and the magnetic field vector ( $H$ ):  $P = E \times H$ .
- For the elementary dipole  $E_\theta \perp H_\theta$  and only  $E_\theta \times H_\theta$  carry energy into space with the speed of light.

# Power Flow

- In free space and at large distances, the radiated energy streams from the antenna in radial lines, i.e. the Poynting vector has only the radial component in spherical coordinates.
- A source that radiates uniformly in all directions is an *isotropic source (radiator, antenna)*. For such a source the radial component of the Poynting vector is independent of  $\theta$  and  $\varphi$ .



# Linear Antennas

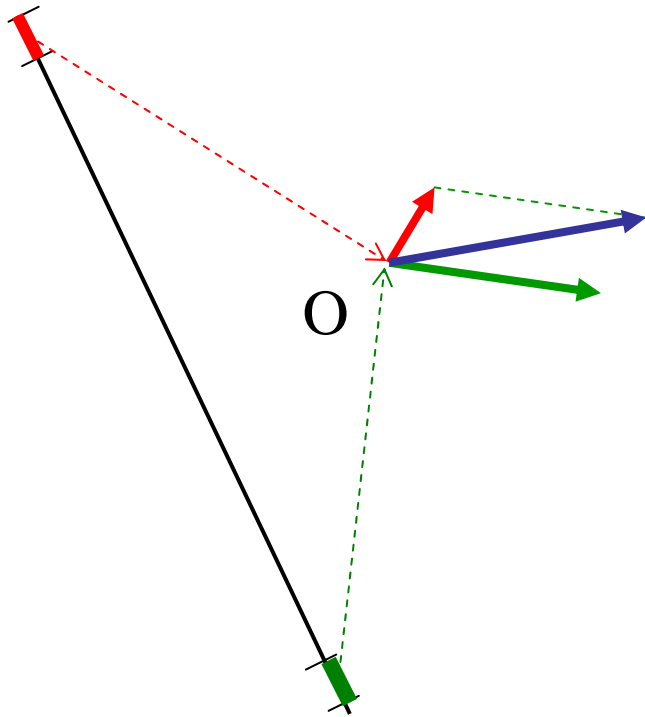

- Summation of all vector components  $E$  (or  $H$ ) produced by each antenna element

$$E = E_1 + E_2 + E_3 + \dots$$

$$H = H_1 + H_2 + H_3 + \dots$$

- In the far-field region, the vector components are parallel to each other
- Phase difference due to
  - Excitation phase difference
  - Path distance difference
- Method of moments - NEC

# Point Source

- For many purposes, it is sufficient to know the direction (angle) variation of the power radiated by antenna at large distances.
- For that purpose, any practical antenna, regardless of its size and complexity, can be represented as a point-source.
- The actual field near the antenna is then disregarded.

- The EM field at large distances from an antenna can be treated as originated at a point source - fictitious volume-less emitter.
- The EM field in a homogenous unlimited medium at large distances from an antenna can be approximated by a uniform plane TEM wave

# Summary

- Introduction
- Review of basic antenna types
- Radiation pattern, gain, polarization
- Equivalent circuit & radiation efficiency
- Smart antennas
- Some theory

# Selected References

- Nikolova N K: *Modern Antennas in Wireless Telecommunications EE753* (lecture notes) [talia@mcmaster.ca](mailto:talia@mcmaster.ca)
- Griffiths H & Smith BL (ed.): *Modern antennas*; Chapman & Hall, 1998
- Johnson RC: *Antenna Engineering Handbook* McGraw-Hill Book Co. 1993
- Kraus JD: *Antennas*, McGraw-Hill Book Co. 1998
- Scoughton TE: *Antenna Basics Tutorial*; Microwave Journal Jan. 1998, p. 186-191
- Stutzman WL, Thiele GA: *Antenna Theory and Design* JWiley & Sons, 1981
- <http://amanogawa.com>
- Software
  - [http://www.feko.co.za/apl\\_ant\\_pla.htm](http://www.feko.co.za/apl_ant_pla.htm)
  - Li et al., “*Microcomputer Tools for Communication Engineering*”
  - Pozar D. “*Antenna Design Using Personal Computers*”
  - NEC Archives [www.gsl.net/wb6tpu /swindex.html](http://www.gsl.net/wb6tpu/swindex.html) ()

# Java simulations

- Polarization:  
<http://www.amanogawa.com/archive/wavesA.html>
- Linear dipole antennas:  
<http://www.amanogawa.com/archive/DipoleAnt/DipoleAnt-2.html>
- Detailed analysis of dipole antennas:  
<http://www.amanogawa.com/archive/Antenna1/Antenna1-2.html>
- Java simulation 2 antennas:  
<http://www.amanogawa.com/archive/TwoDipole/Antenna2-2.html>
- [http://en.wikipedia.org/wiki/Antenna\\_%28radio%29](http://en.wikipedia.org/wiki/Antenna_%28radio%29)

# Any questions?

Thank you for your attention

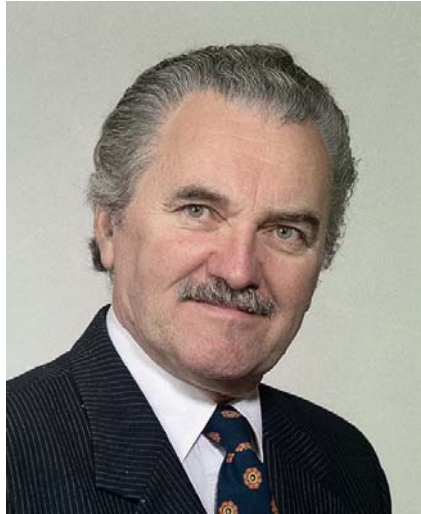

Ryszard STRUZAK *PhD., DSc.*  
Co-Director, ICTP-ITUD School on Wireless  
Networking, IT  
*Academician, International  
Telecommunication Academy  
Life Fellow IEEE*

[ryszard@struzak.com](mailto:ryszard@struzak.com)  
[www.ryszard.struzak.com](http://www.ryszard.struzak.com)

## Important notes

Copyright © 2006 Ryszard Struzak. This work is licensed under the Creative Commons Attribution License (<http://creativecommons.org/licenses/by/1.0>) and may be used freely for individual study, research, and education in not-for-profit applications. Any other use requires the written author's permission. These materials and any part of them may not be published, copied to or issued from another Web server without the author's written permission. If you cite these materials, please credit the author.

Beware of misprints!!! These materials are preliminary notes for my lectures and may contain misprints. If you notice some, or if you have comments, please send these to [r.struzak@ieee.org](mailto:r.struzak@ieee.org).



- Quiz

- For efficient radiation, the largest antenna dimension ( $d$ ) and the wavelength ( $\lambda$ ) should be related as follows:

- A)  $d \ll \lambda$
    - B)  $d \sim \lambda$
    - C)  $d \gg \lambda$

- Quiz

- Antenna's sidelobes and backlobes

- A) increase its gain
    - B) decrease its gain
    - C) have no effect on its gain

- 2 cochannel radio links can potentially interfere each other. In order to reduce the probability of interference they should operate
  - A) using the same polarization
  - B) using orthogonal polarizations
  - C) using random polarization

- Quiz

- In order to ensure an efficient power transport, the internal impedance of the transmitter ( $R_t + jX_t$ ) and antenna impedance ( $R_a + jX_a$ ) should be related as follows:

- A)  $R_t \gg R_a$  and  $X_t \gg X_a$
    - B)  $R_t = R_a$  and  $X_t = -X_a$
    - C)  $R_t \ll R_a$  and  $X_t \ll X_a$

- Quiz

- Antenna gain is the effect of

- A) signal amplification in the amplifier connected to the antenna
    - B) spatial redistribution of the radiated power
    - C) structure supporting the antenna

- Quiz

- Beamwidth of an antenna is

- A) frequency band within which antenna characteristics are within their nominal tolerances
    - B) range of angles within which antenna radiates a half of power
    - C) something else