

# Control (1A)

---

Copyright (c) 2010, 2011 Young W. Lim.

Permission is granted to copy, distribute and/or modify this document under the terms of the GNU Free Documentation License, Version 1.2 or any later version published by the Free Software Foundation; with no Invariant Sections, no Front-Cover Texts, and no Back-Cover Texts. A copy of the license is included in the section entitled "GNU Free Documentation License".

Please send corrections (or suggestions) to [youngwlim@hotmail.com](mailto:youngwlim@hotmail.com).

This document was produced by using OpenOffice.

# If Statement

```
if ( A ) B;  
else   C;
```

```
if ( A ) B;
```

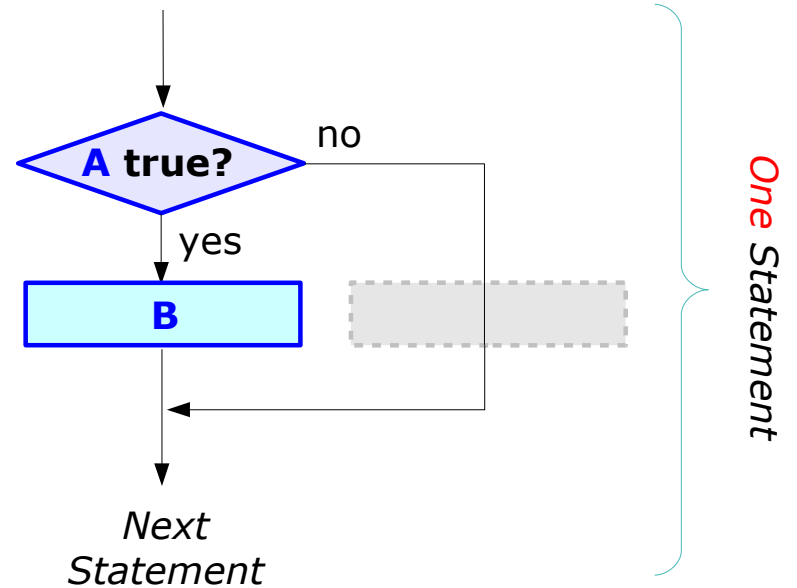
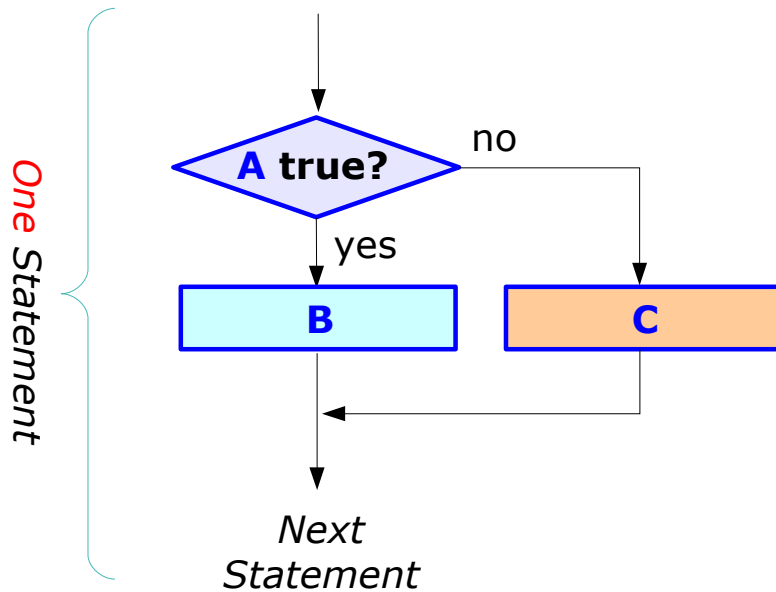

# If Compound Statement

```
if ( A ) { B1; B2; B3; }  
else { C1; C2; }
```

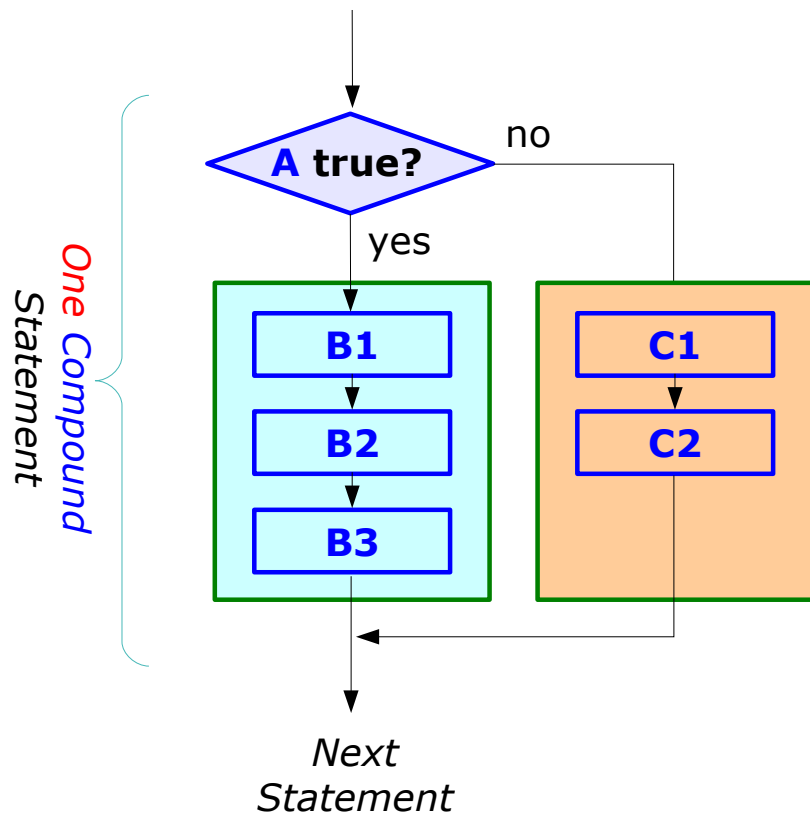

```
if ( A ) { B1; B2; B3; }
```

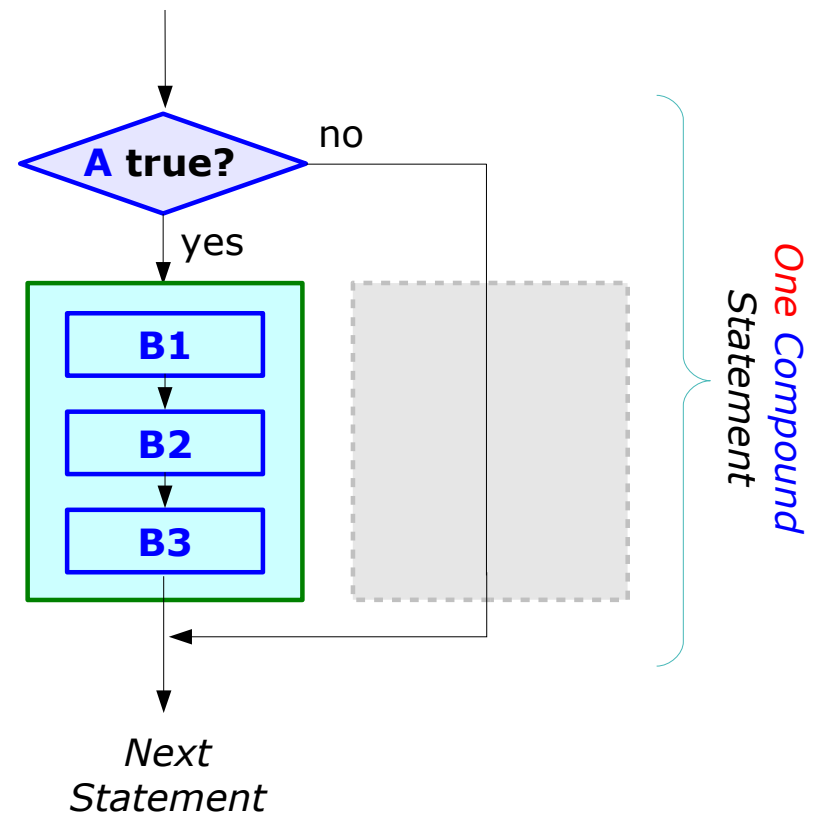

# Cases of **If** Statements

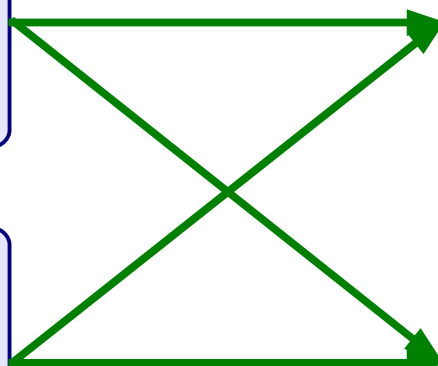
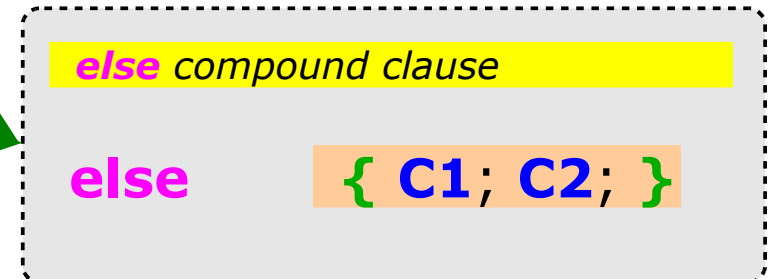
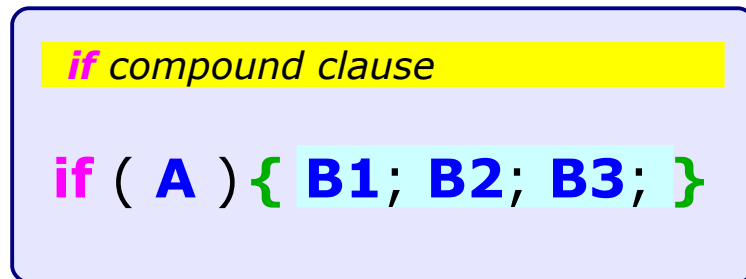
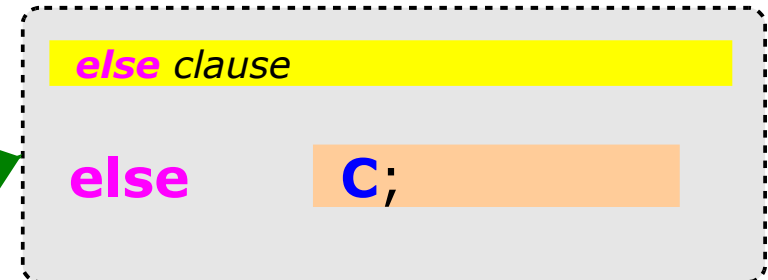
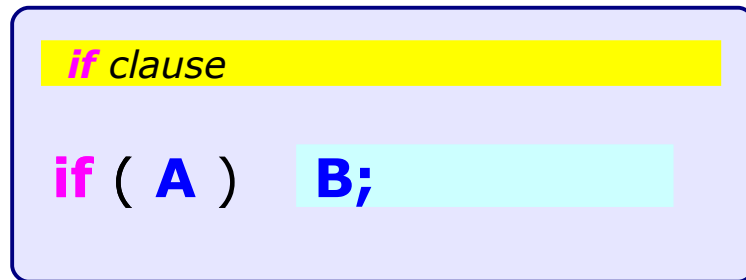
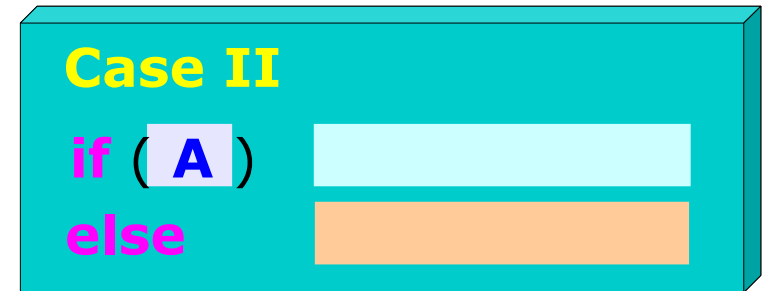

# Nested If Statement (1)

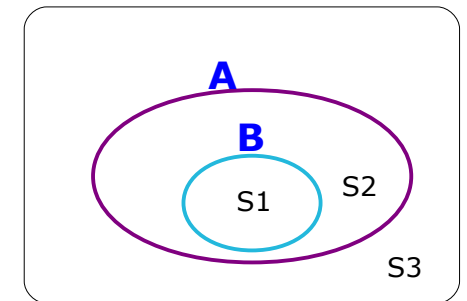
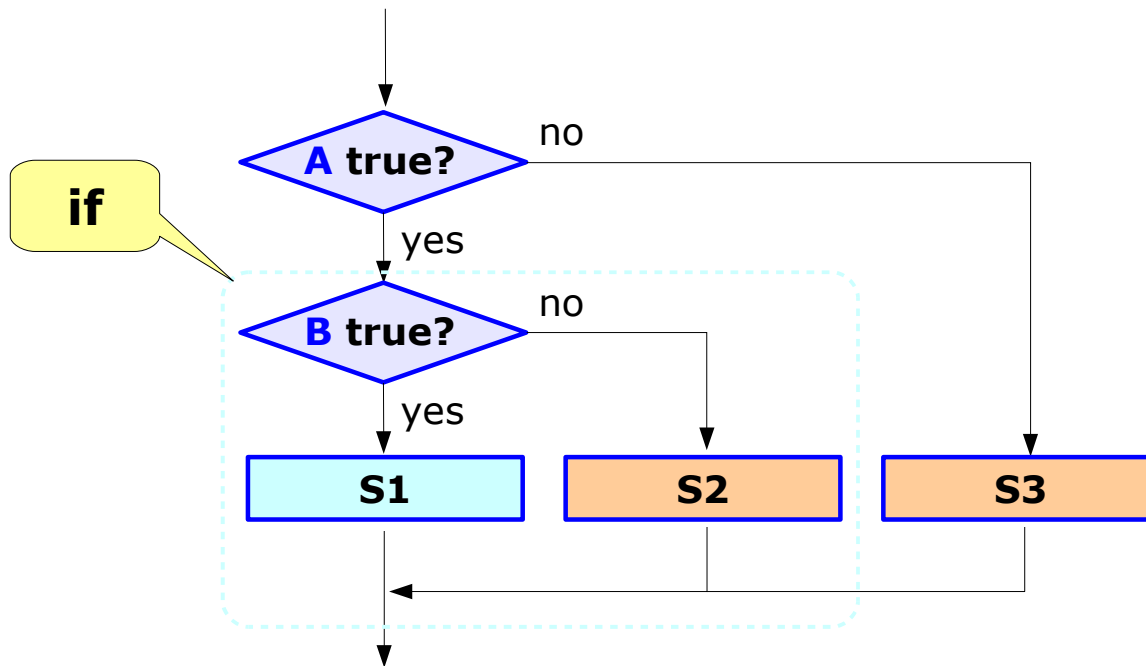
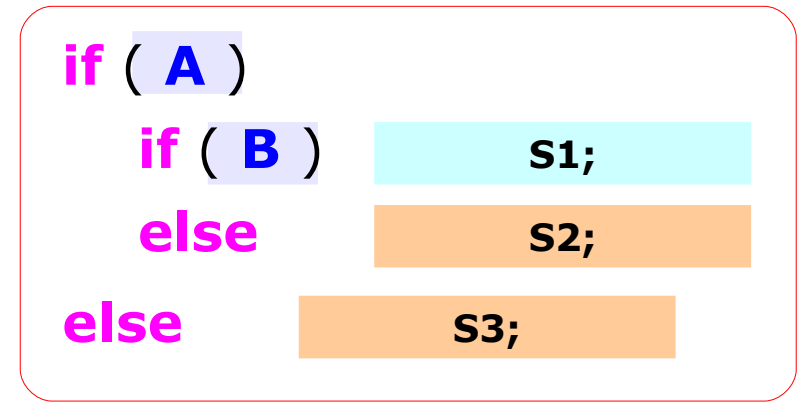
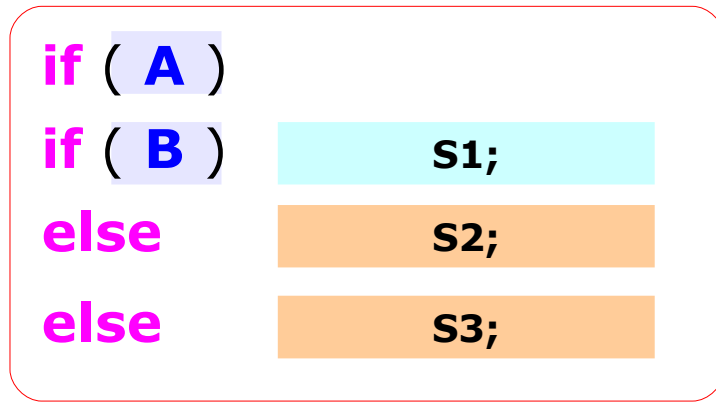

# Nested If Statement (2)

```
if ( A ) S1;  
else  
if ( B ) S2;  
else S3;
```



```
if ( A ) S1;  
else if ( B ) S2;  
else S3;
```

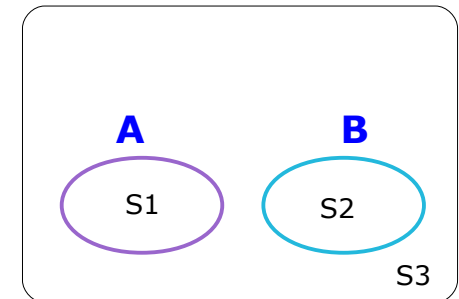
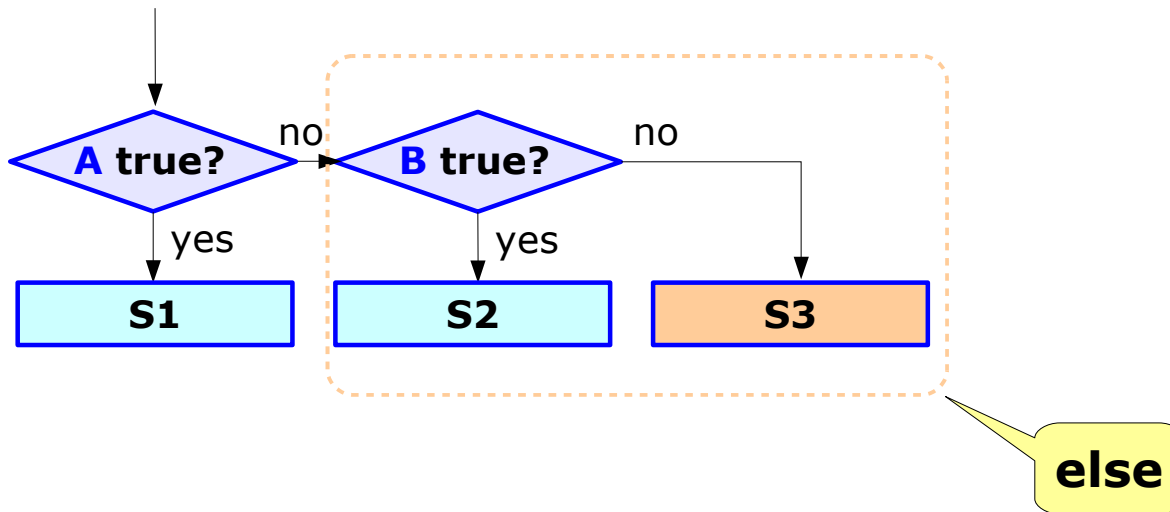

# Switch Statement (1)

```
switch ( A ) {  
case A1: S1;  
         break;  
case A2: S2;  
         break;  
default : S3;  
         break;  
}
```

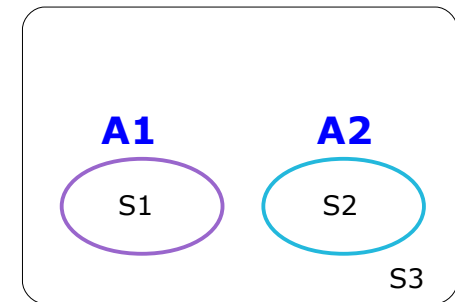
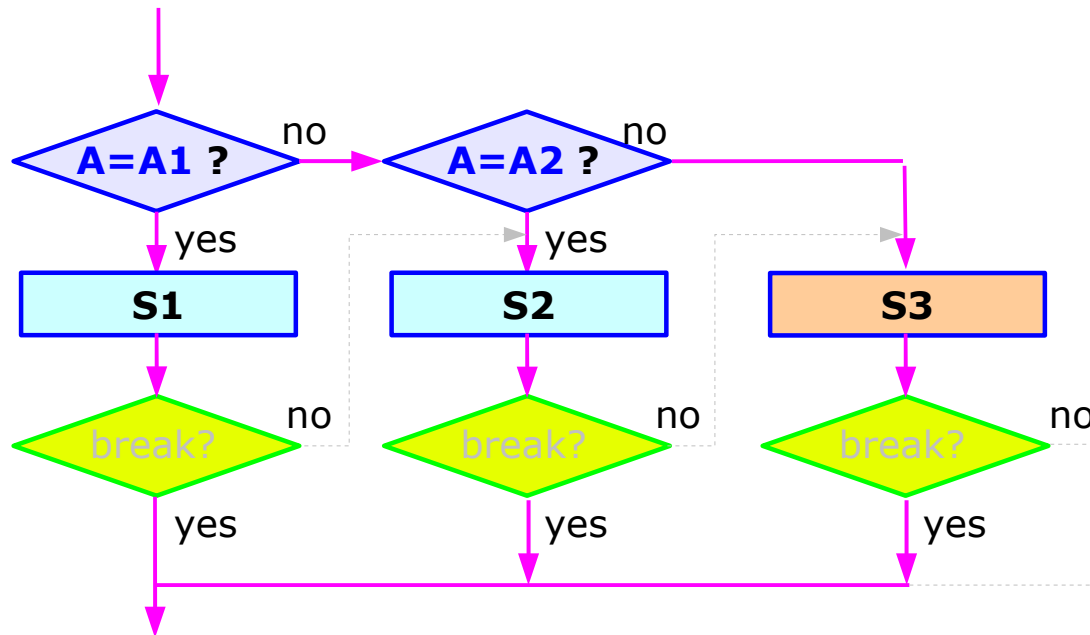



# Switch Statement (2)

```
switch ( A ) {  
case A1: S1;  
case A2: S2;  
        break;  
default : S3;  
        break;  
}
```

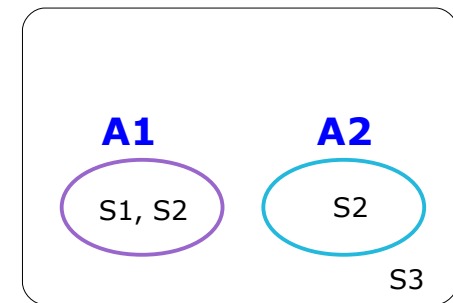
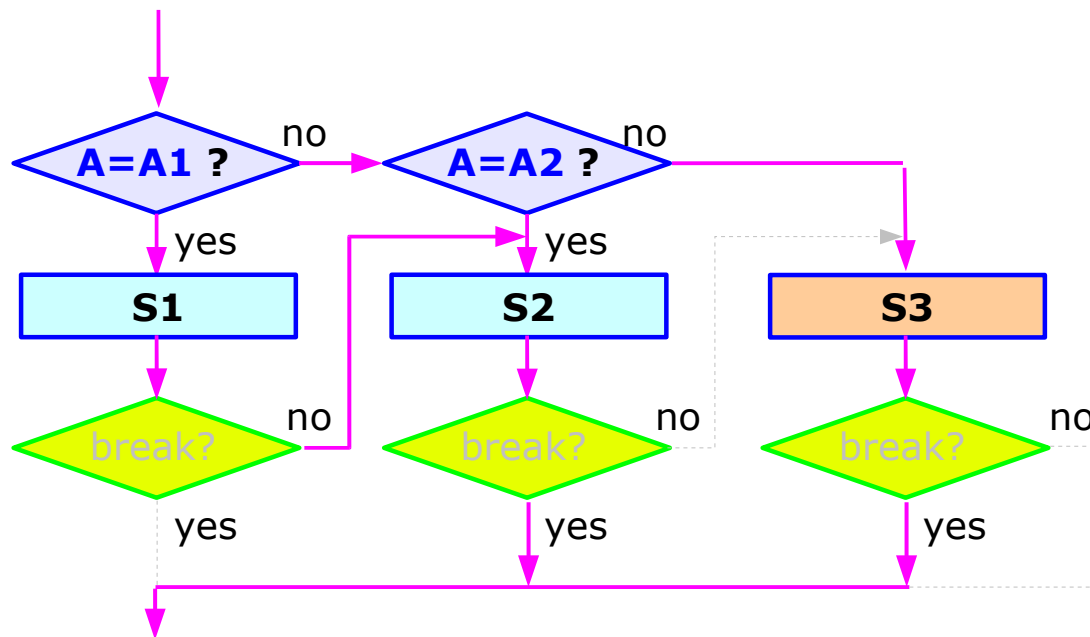

# Switch Statement (3)

```
switch ( A ) {  
  case A1:  
  case A2: S2;  
           break;  
  default : S3;  
           break;  
}
```

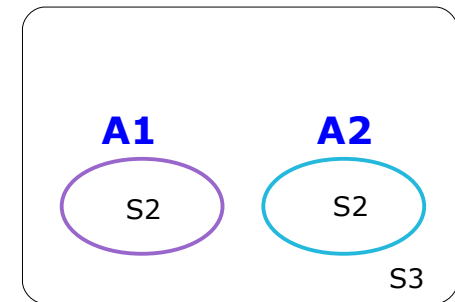
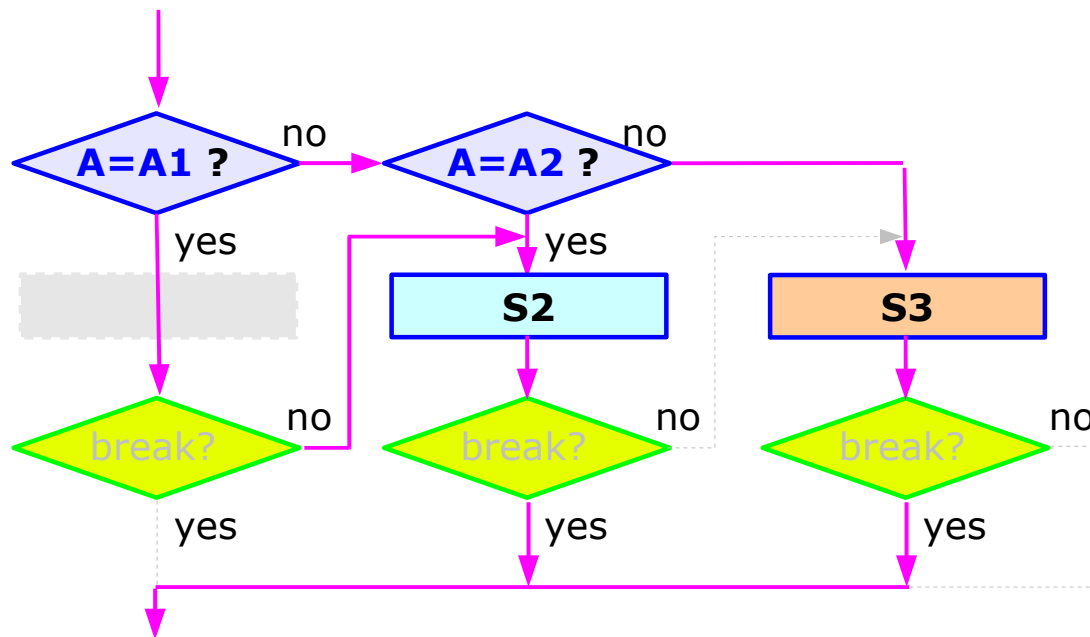

# 2-d Array

---

## References

- [1] Essential C, Nick Parlante
- [2] Efficient C Programming, Mark A. Weiss
- [3] C A Reference Manual, Samuel P. Harbison & Guy L. Steele Jr.
- [4] C Language Express, I. K. Chun