

BJT Bias

Copyright (c) 2012 Young W. Lim.

Permission is granted to copy, distribute and/or modify this document under the terms of the GNU Free Documentation License, Version 1.2 or any later version published by the Free Software Foundation; with no Invariant Sections, no Front-Cover Texts, and no Back-Cover Texts. A copy of the license is included in the section entitled "GNU Free Documentation License".

Please send corrections (or suggestions) to youngwlim@hotmail.com.

This document was produced by using OpenOffice and Octave.

Common Base (1)

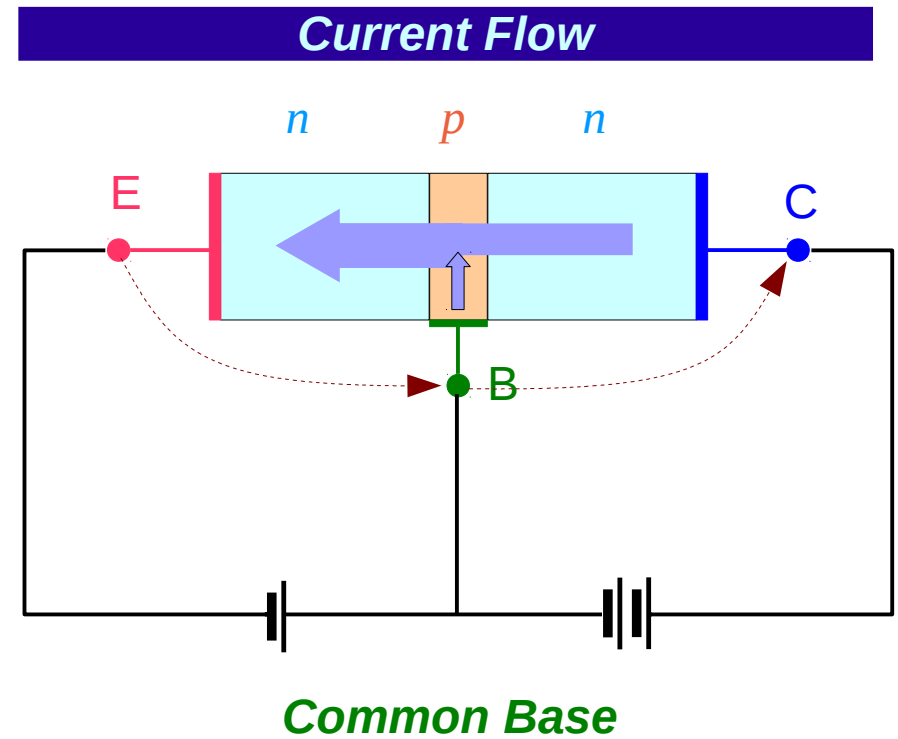
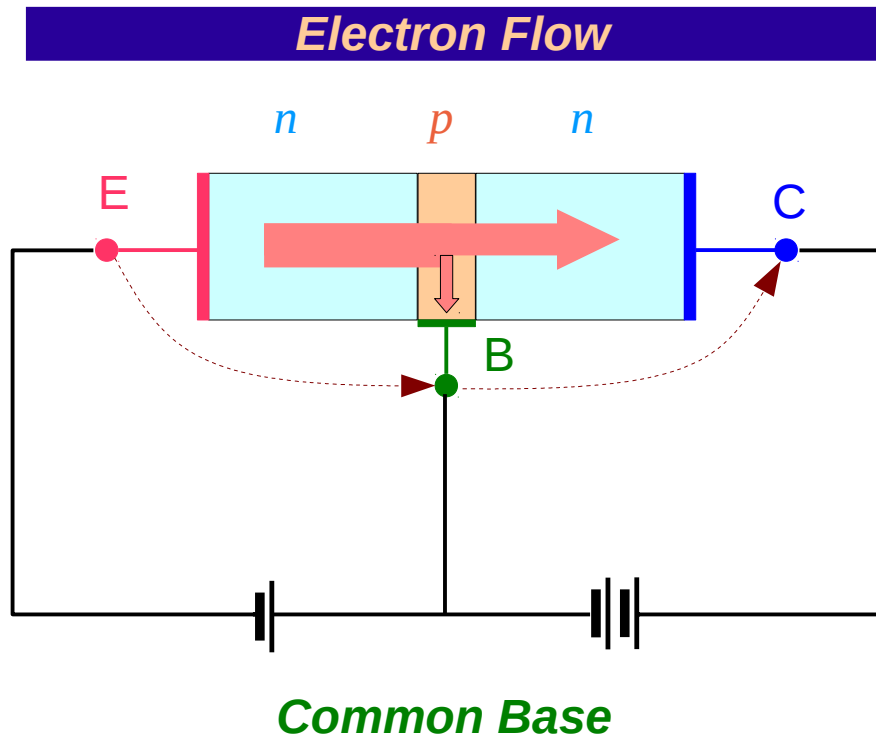

Common Base (2)

Electron Flow

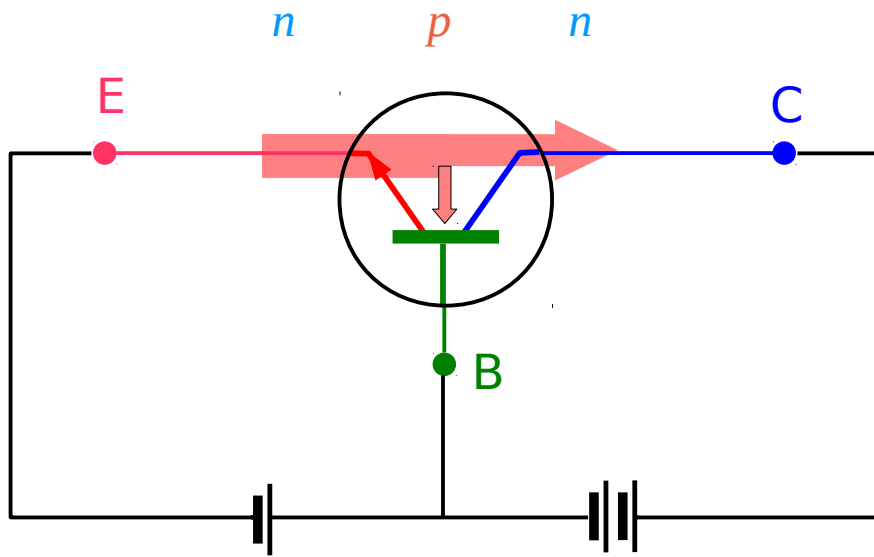

Common Base

Current Flow

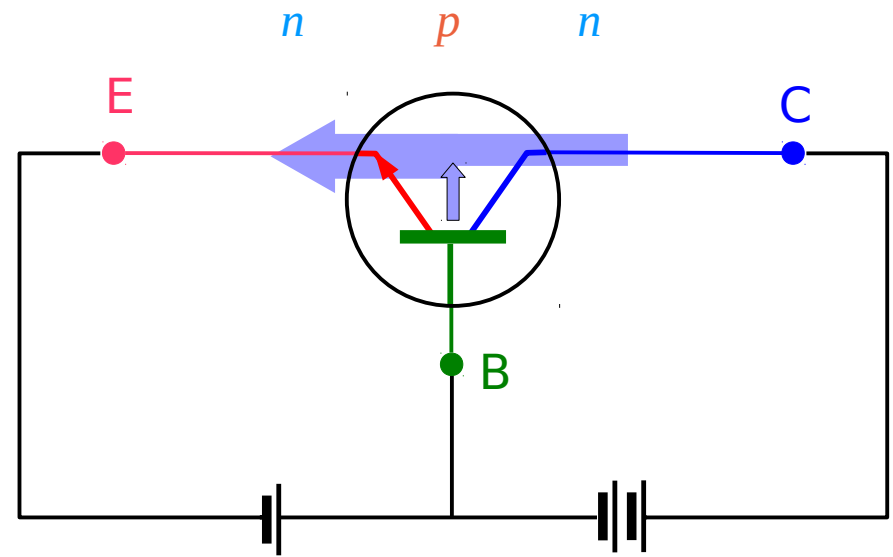

Common Base

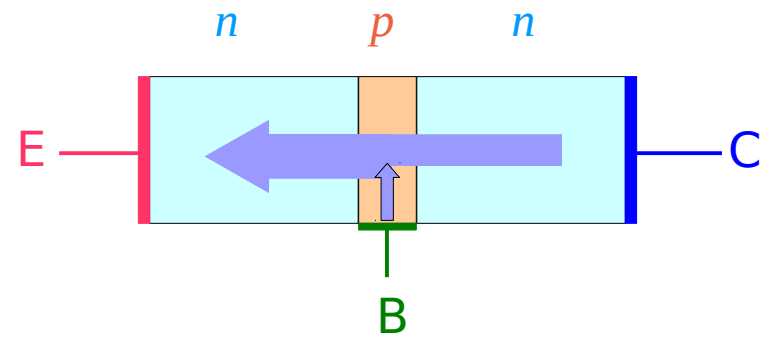
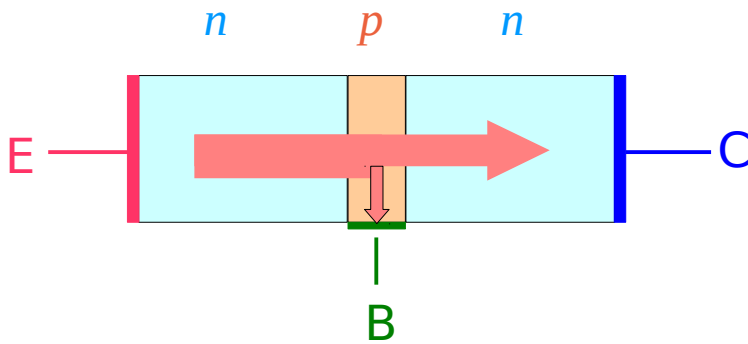

Common Emitter (1)

Electron Flow

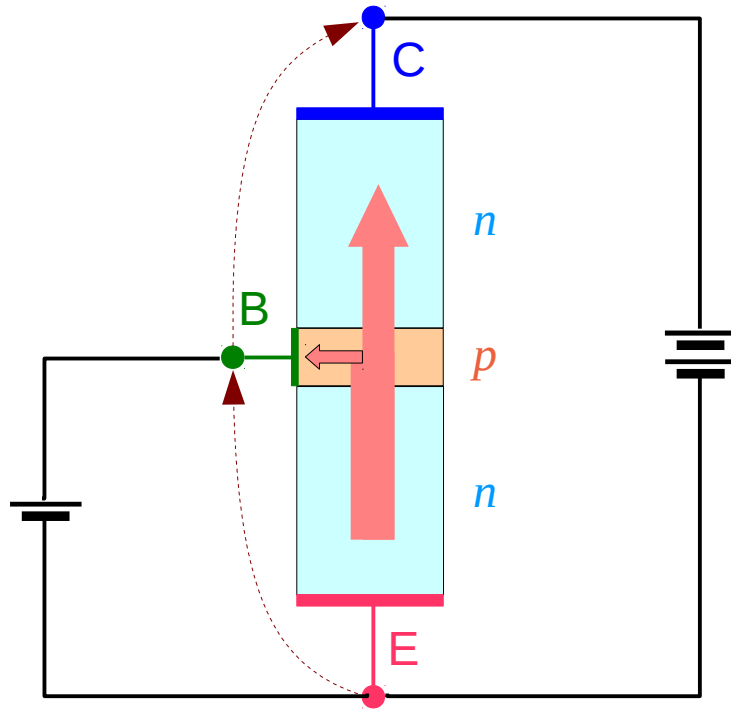

Common Emitter

Current Flow

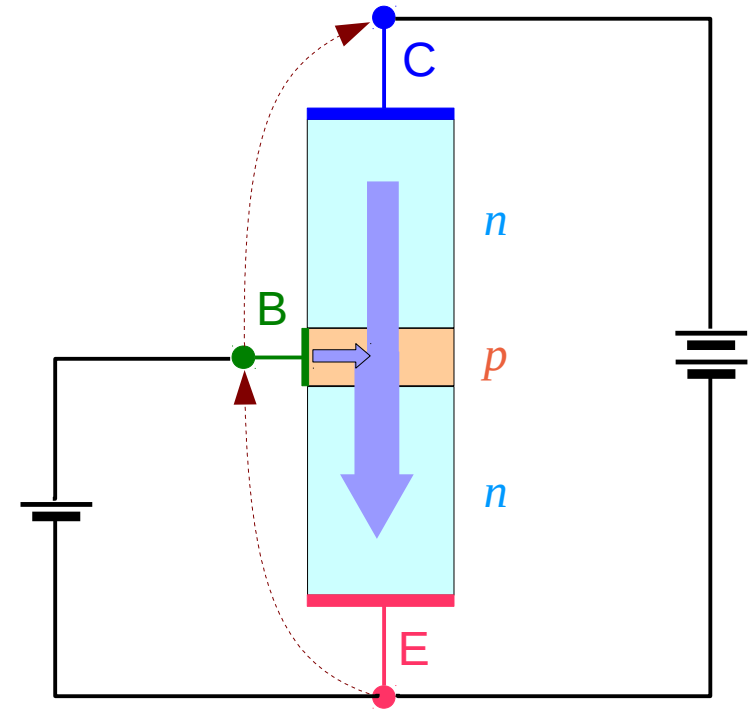

Common Emitter

Common Emitter (2)

Electron Flow

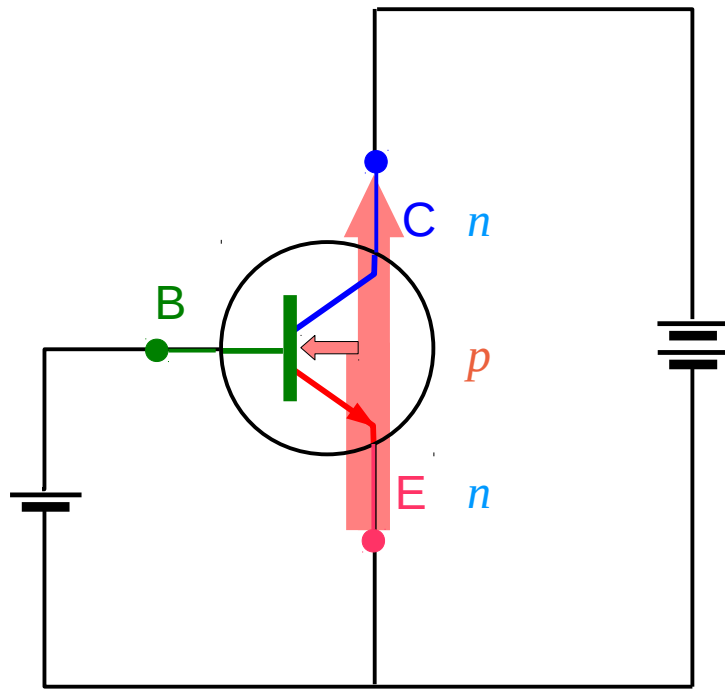

Common Emitter

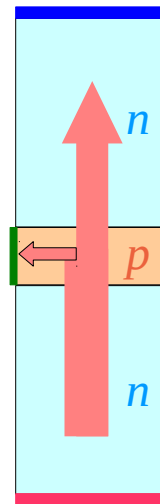

Current Flow

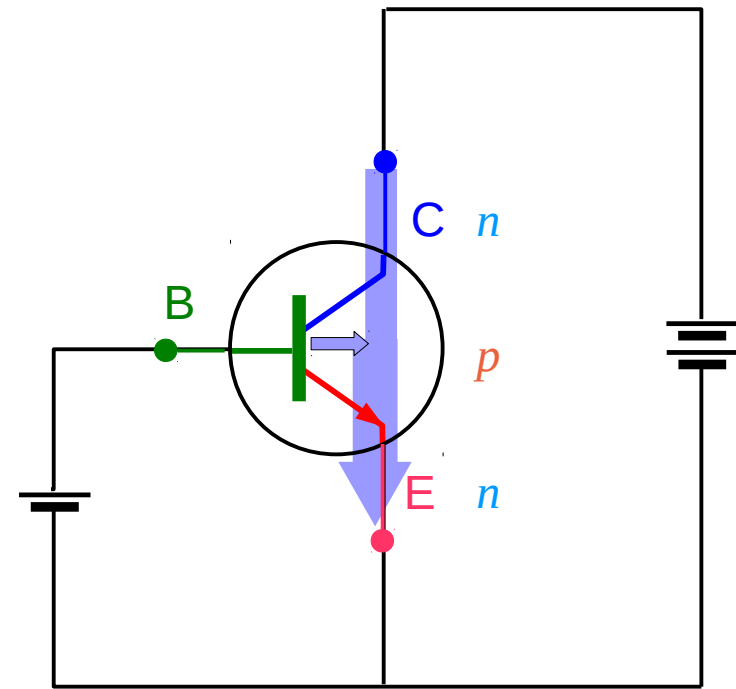

Common Emitter

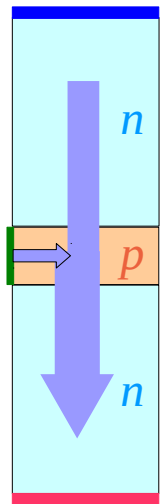

Common Collector (1)

Electron Flow

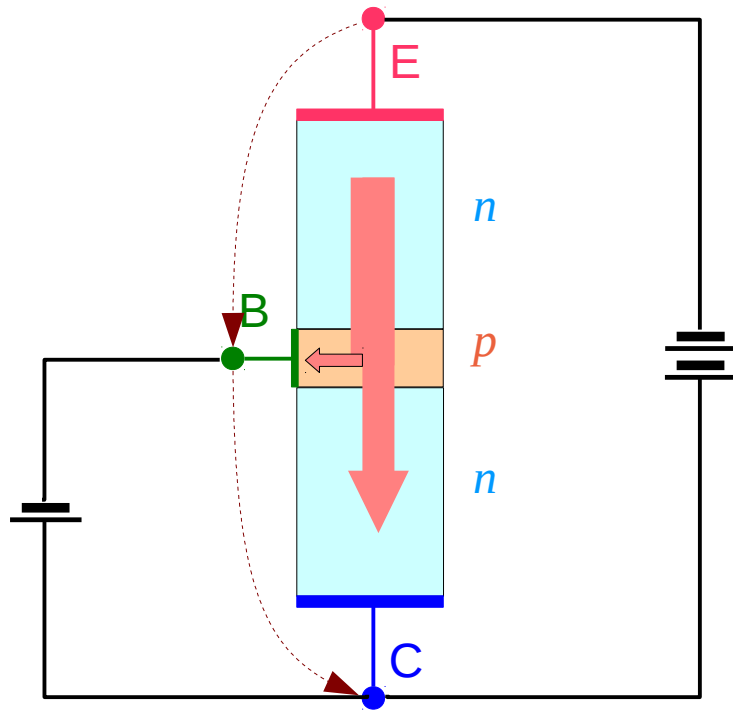

Common Collector

Current Flow

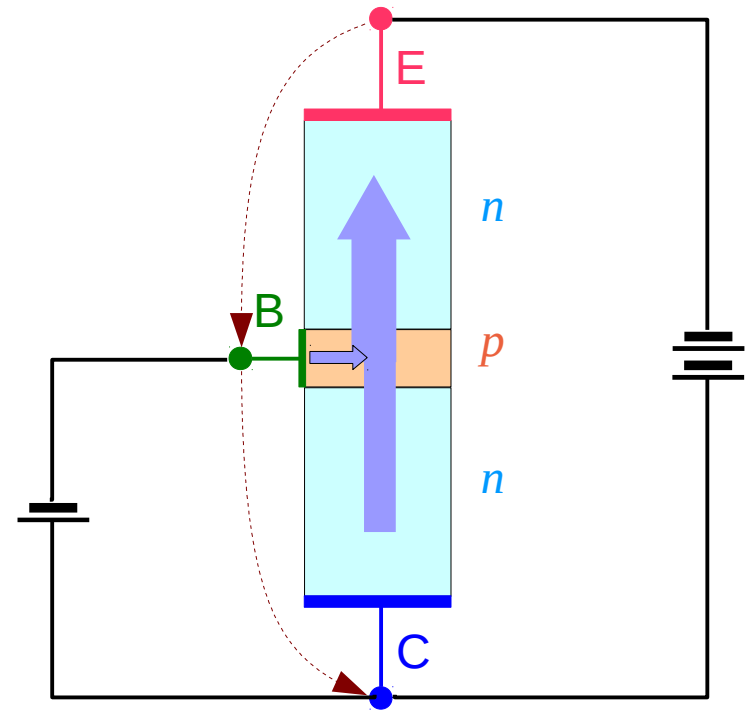

Common Collector

Common Collector (2)

Electron Flow

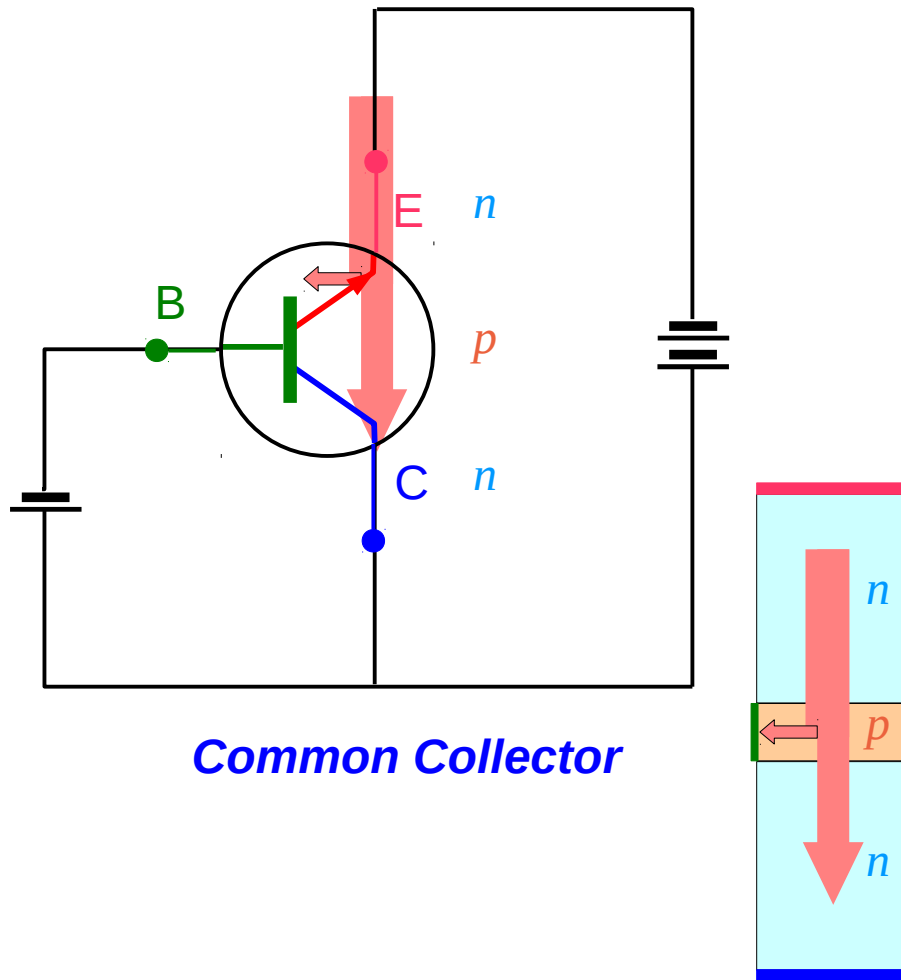

Current Flow

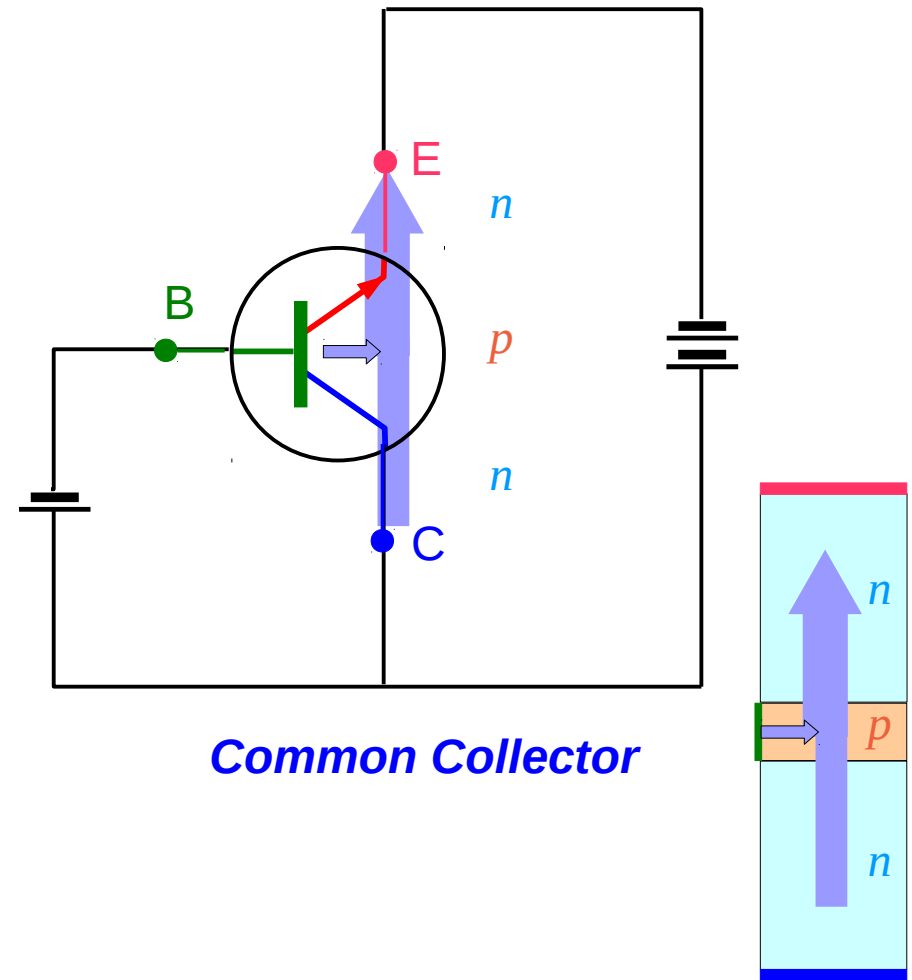

BJT Bias

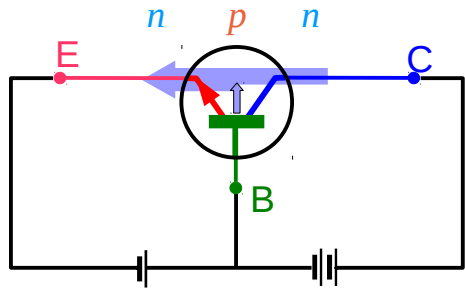

Common Base

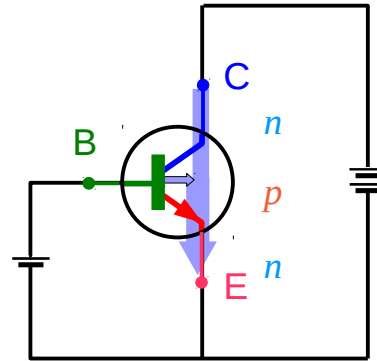

Common Emitter

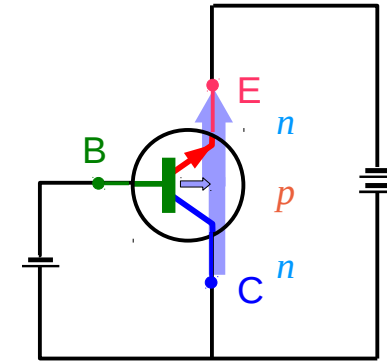

Common Collector

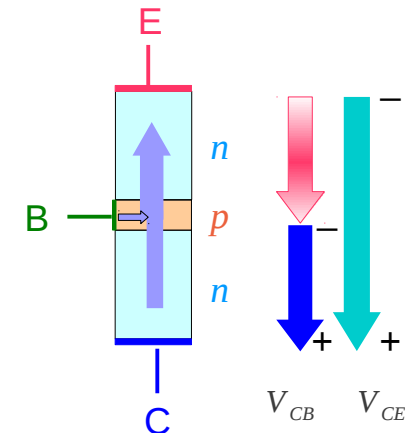
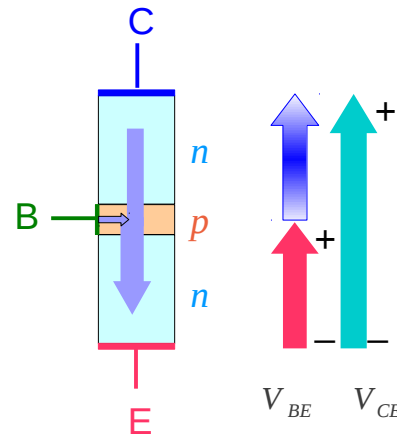
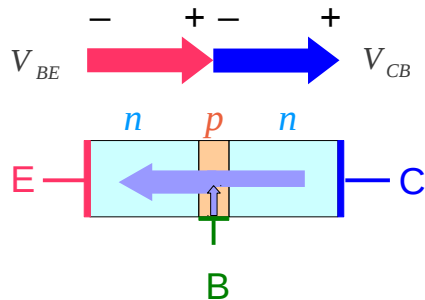

Common Emitter (2)

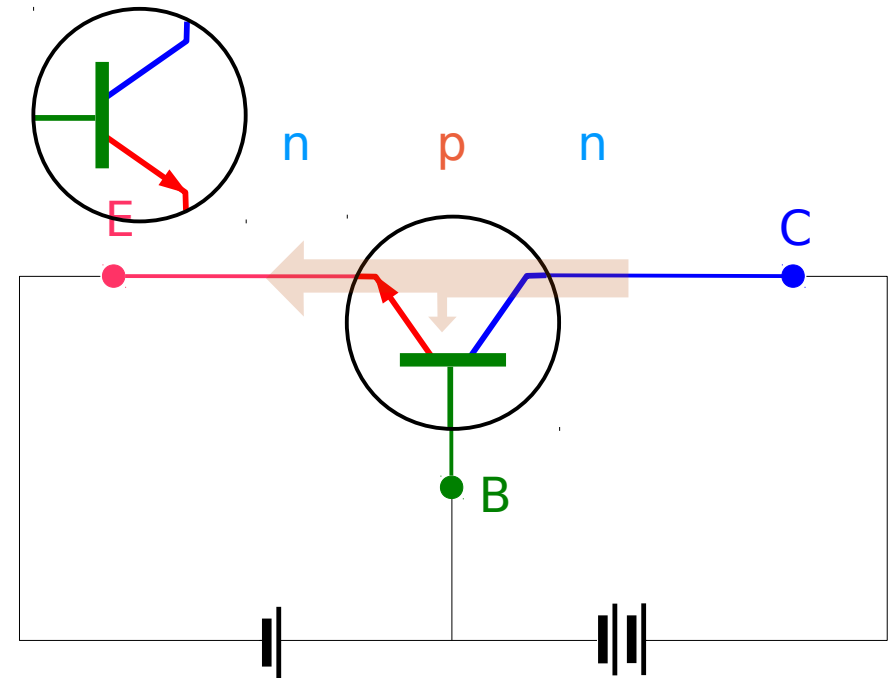

Electron Flow

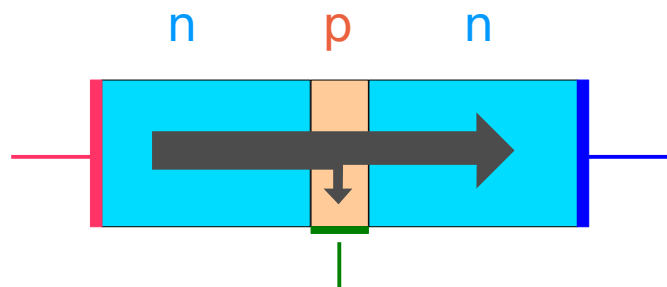

Current Flow

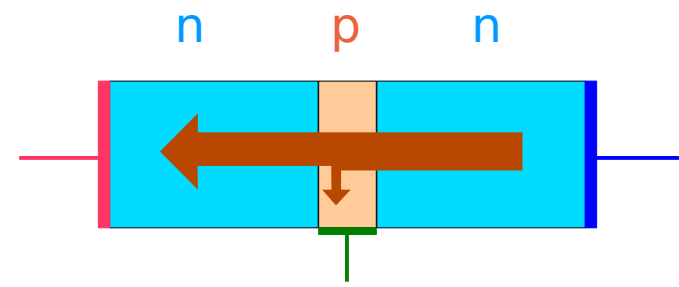

Maintain Magnetic Field

Before

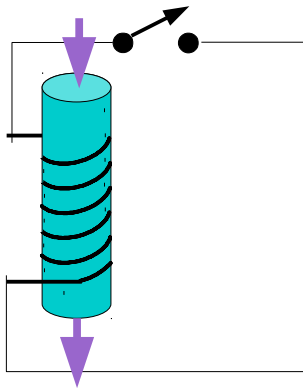

Initial

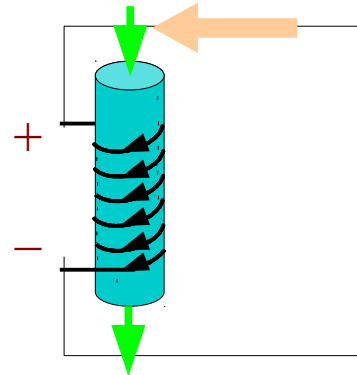

Induced EMF

Final

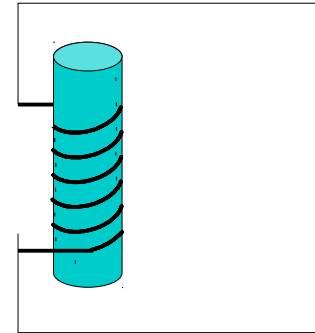

No Energy in magnetic field

Storing Magnetic Energy

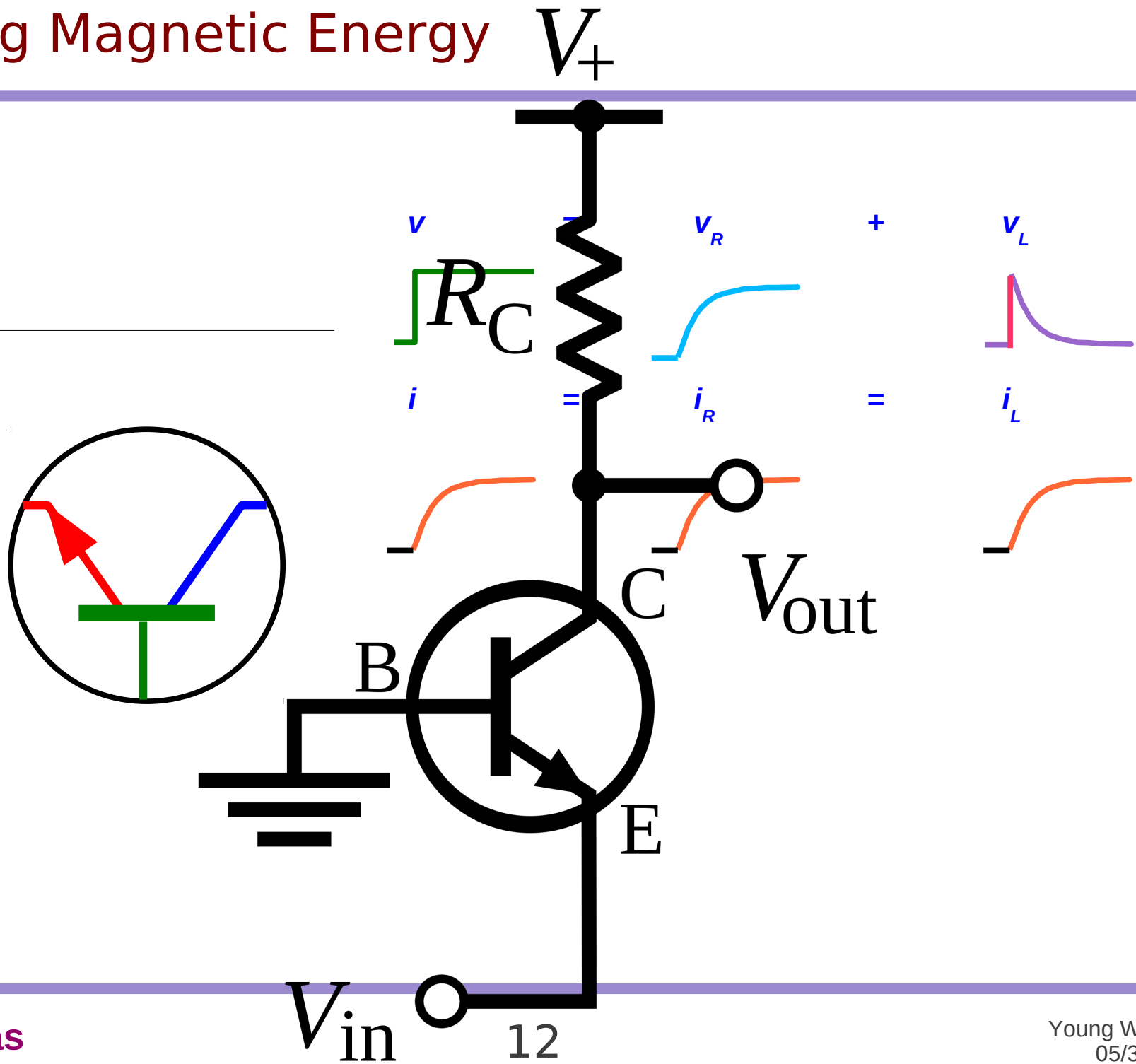

References

[1] <http://en.wikipedia.org/>

[2] J.H. McClellan, et al., Signal Processing First, Pearson Prentice Hall, 2003