

# Downsampling (4B)

---

- 
-

Copyright (c) 2009, 2010, 2011 Young W. Lim.

Permission is granted to copy, distribute and/or modify this document under the terms of the GNU Free Documentation License, Version 1.2 or any later version published by the Free Software Foundation; with no Invariant Sections, no Front-Cover Texts, and no Back-Cover Texts. A copy of the license is included in the section entitled "GNU Free Documentation License".

Please send corrections (or suggestions) to [youngwlim@hotmail.com](mailto:youngwlim@hotmail.com).

This document was produced by using OpenOffice and Octave.

# Band-limited Signal

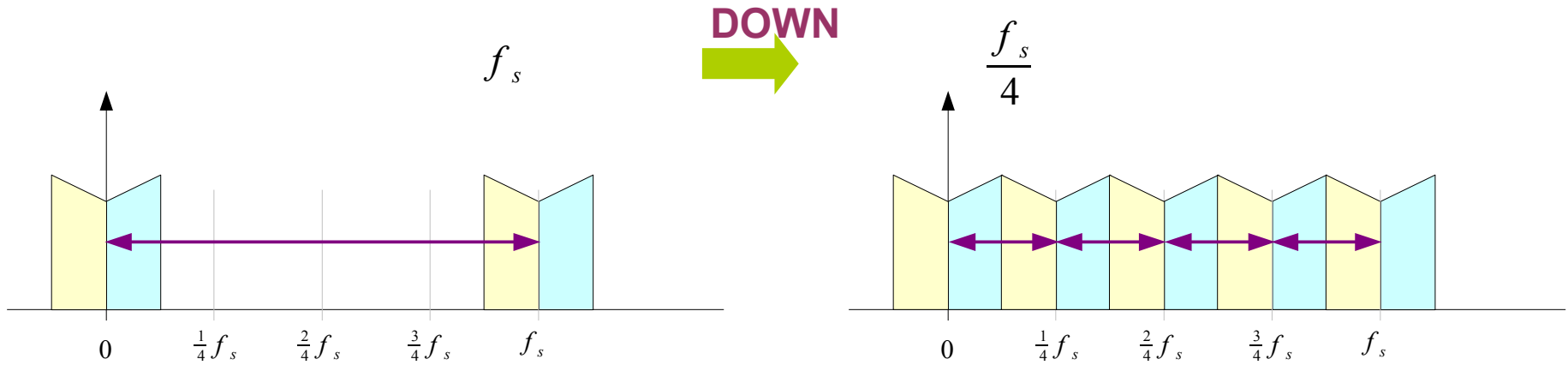

Sampling Frequency  $f_s$

Sampling Time  $T = \frac{1}{f_s}$

Sampling Frequency  $f'_s = \frac{1}{4}f_s$

Sampling Time  $T' = \frac{4}{f_s}$

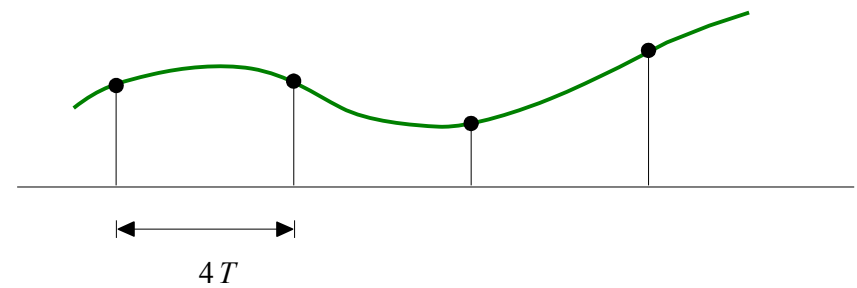
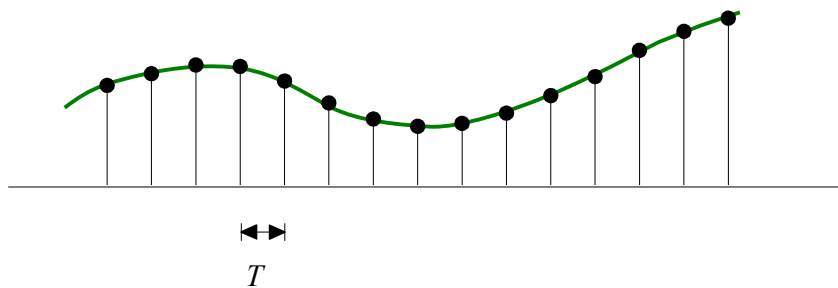

# Time Sequence

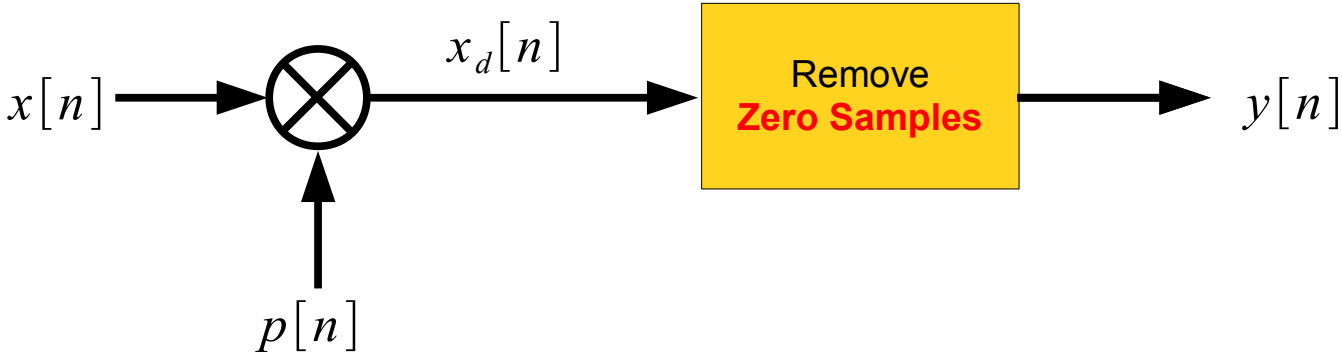
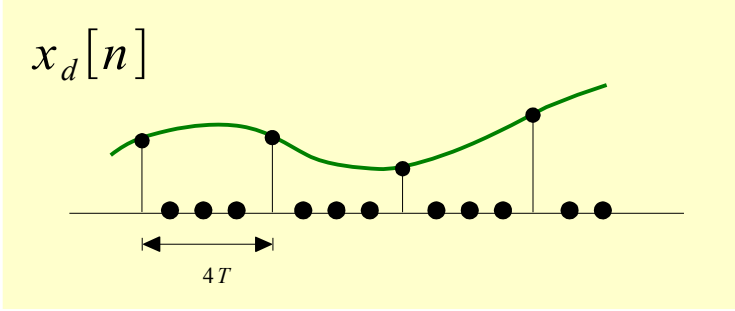
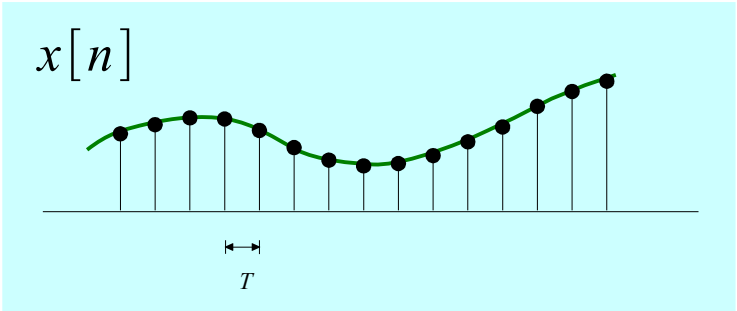

Ideal Sampling

$T$  Sampling Period

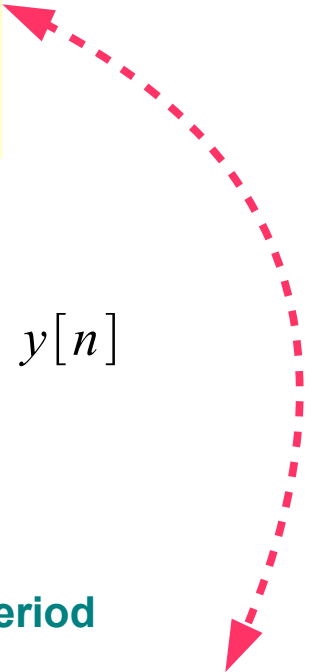
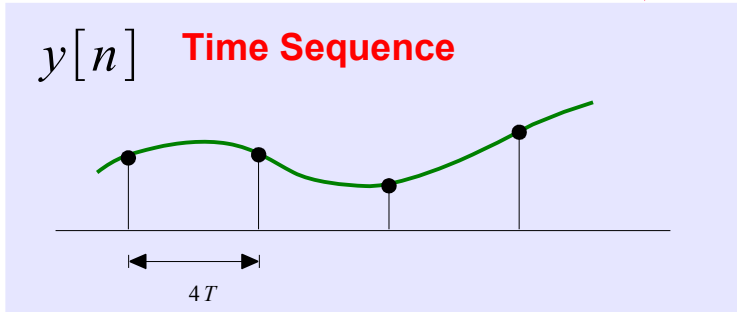
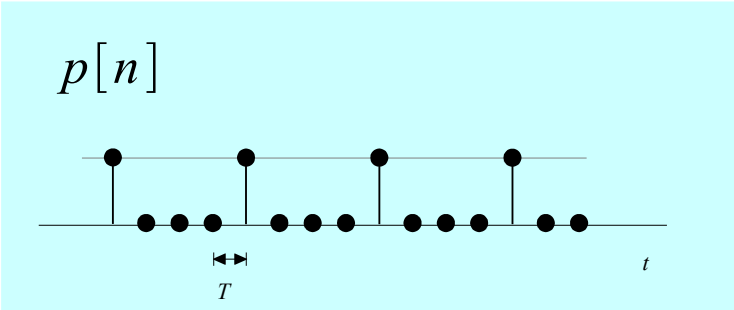

# Normalized Radian Frequency

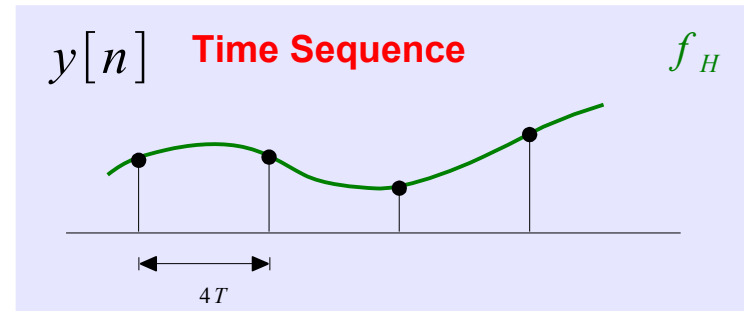
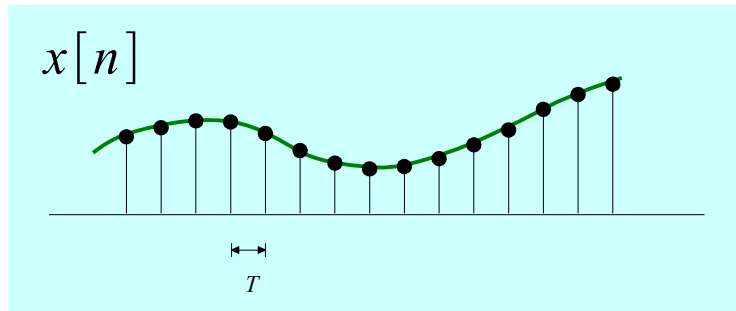

$$\hat{\omega} = \omega \cdot T_s = \frac{\omega}{1/T_s}$$

$$\hat{\omega} = \frac{\omega}{f_s} = 2\pi \frac{f}{f_s}$$

↑      ↑  
 Normalized to  $f_s$

Normalized Radian Frequency

|| The Same Time Sequence

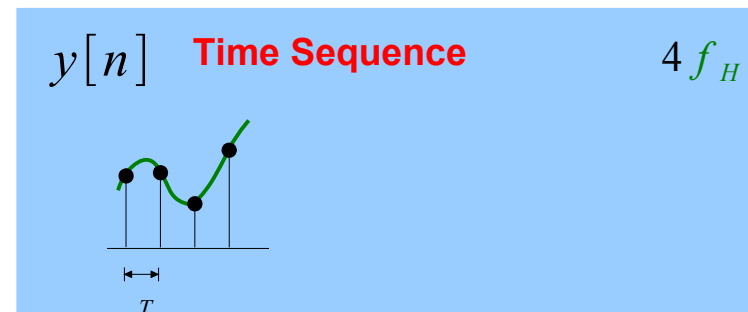

The Same Normalized Radian Frequency

The Highest Frequency:  $f_H, 4f_H$

$\frac{f_H}{1/4T} = f_H \cdot 4T$	$\frac{4f_H}{1/T} = f_H \cdot 4T$
-----------------------------------	-----------------------------------

# Time Sequence

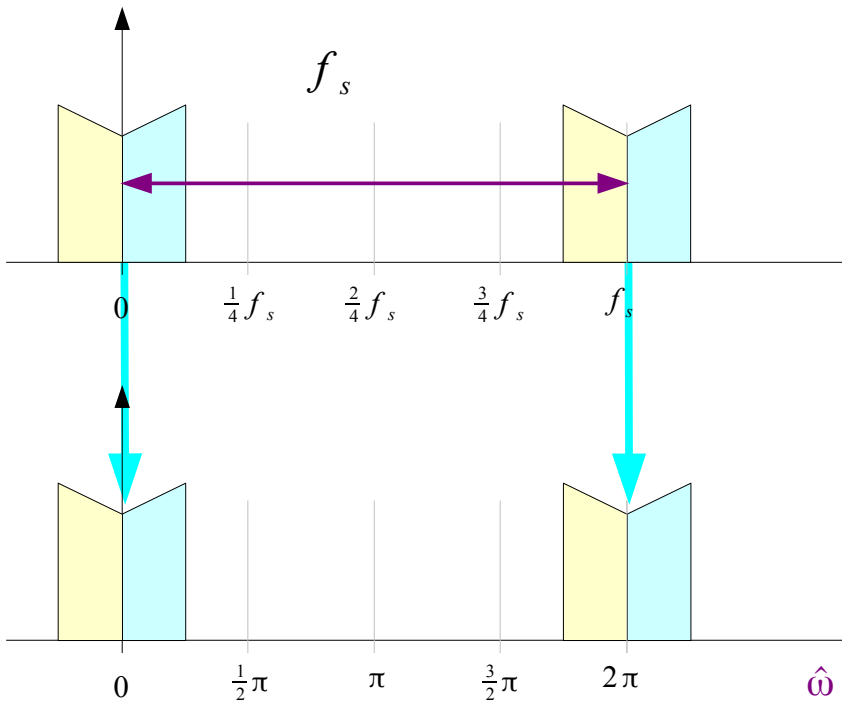
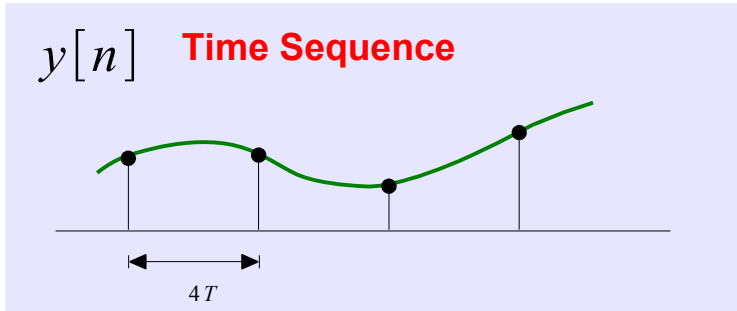
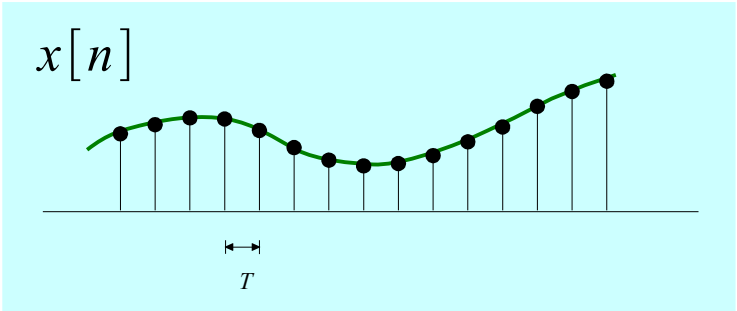

Normalized Radian Frequency

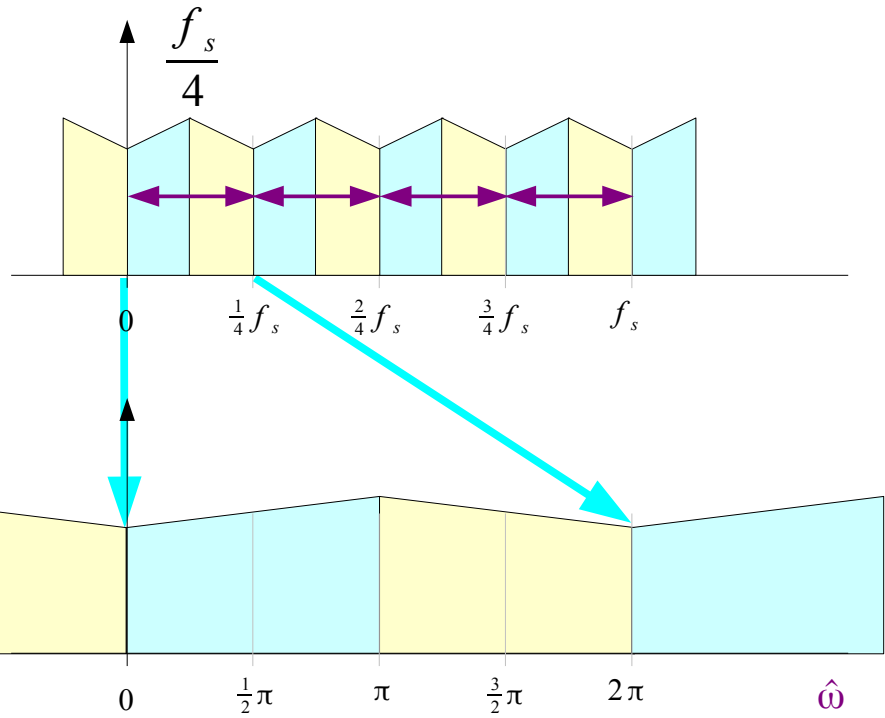

Normalized Radian Frequency

# Time Sequence Spectrum in Linear Frequency

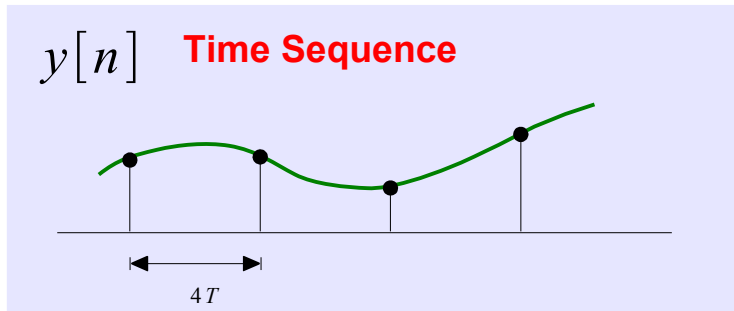
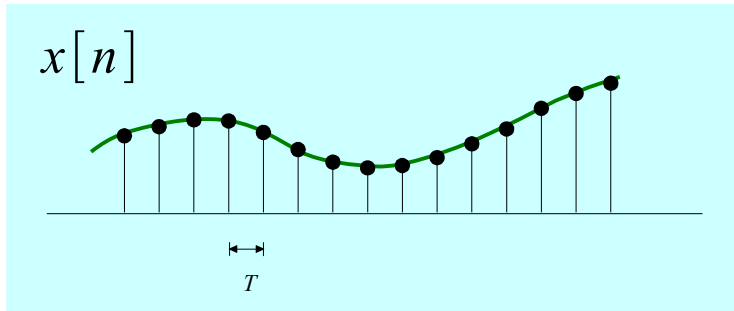

|| The Same Time Sequence

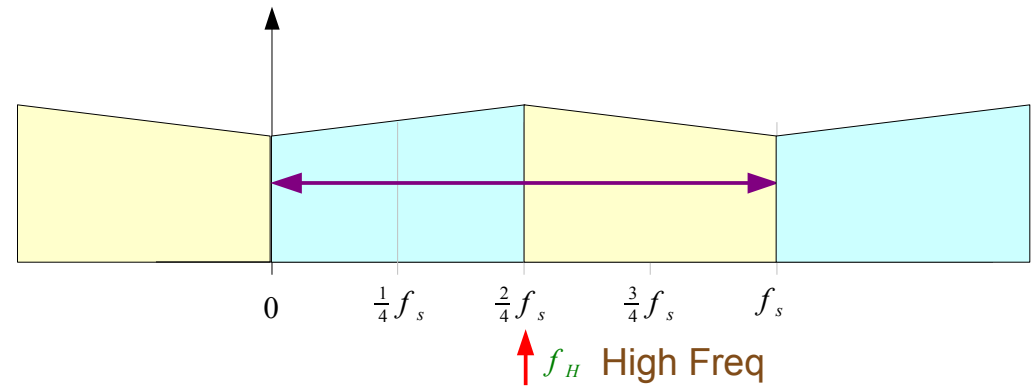
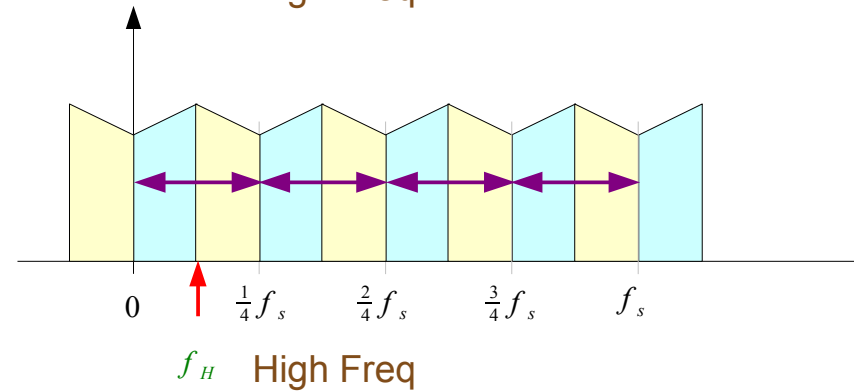
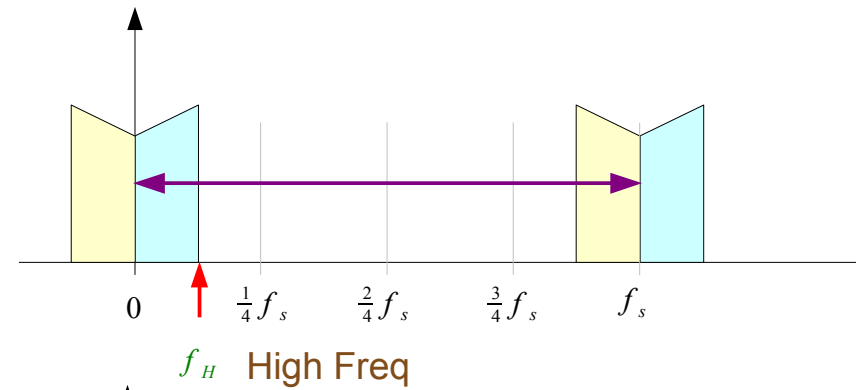
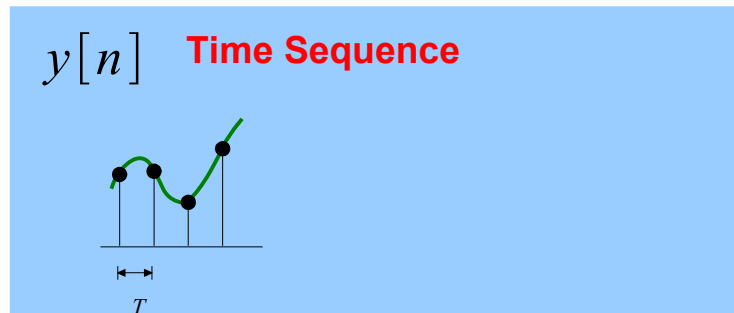

# Time Sequence Spectrum in Normalized Frequency

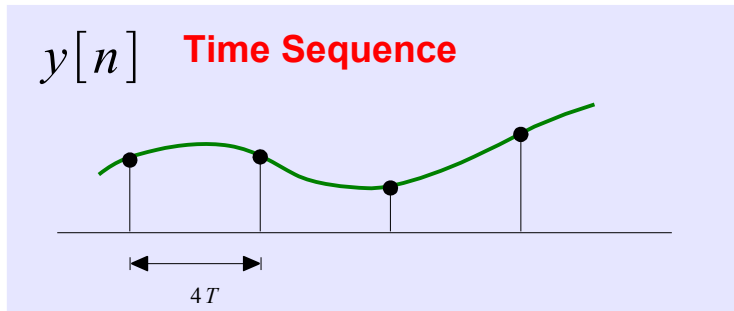
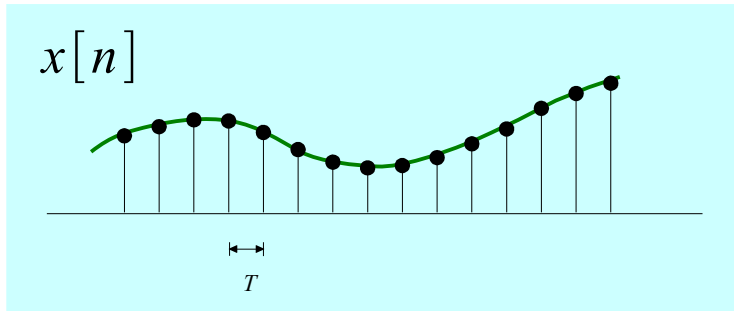

**||** The Same Time Sequence

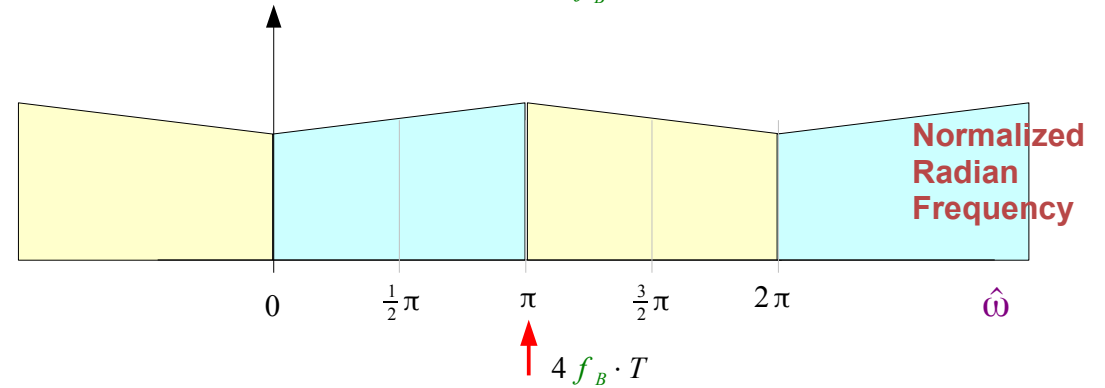
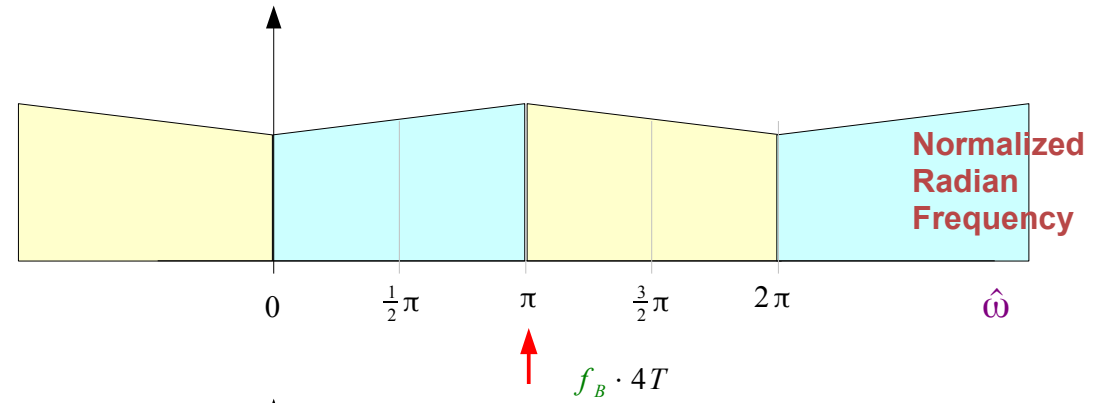
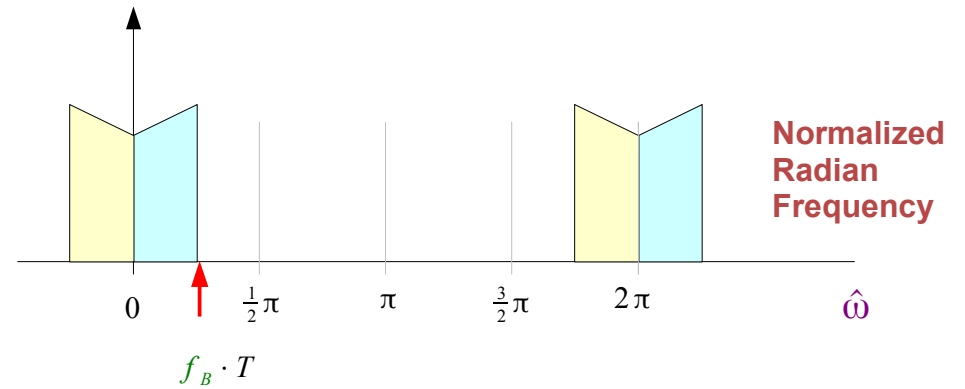
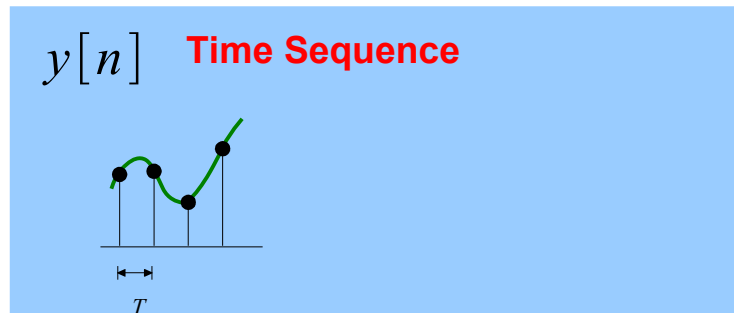



# Z-Transform and Down Sampling

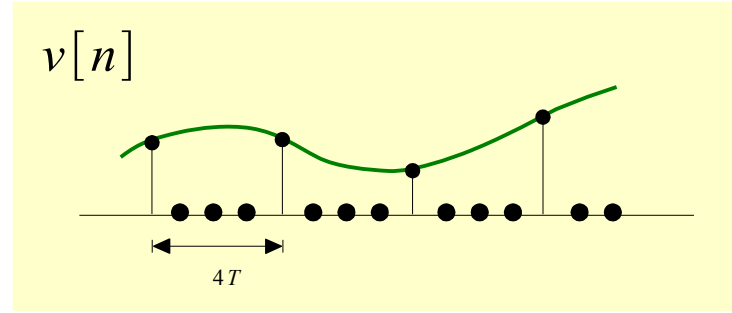
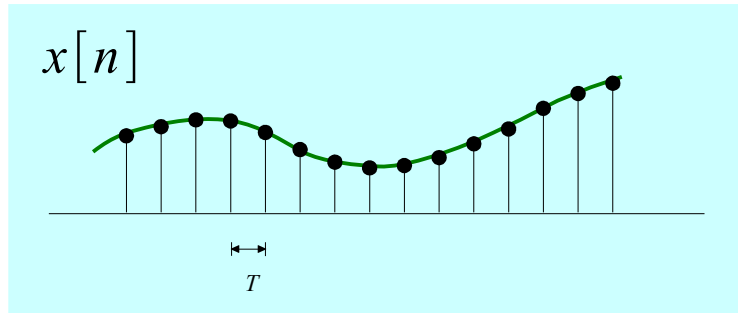

$T$  Sampling Period

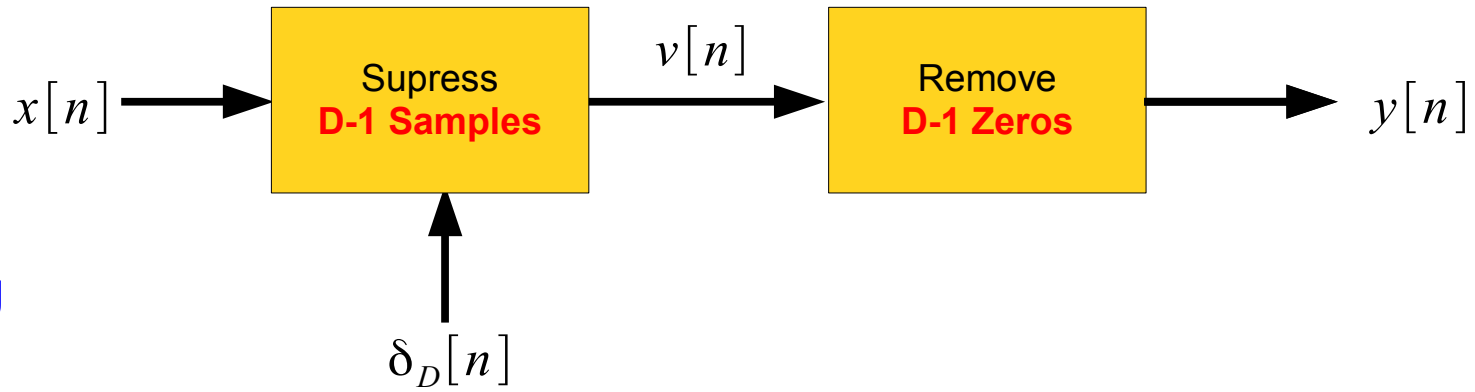

Ideal Sampling

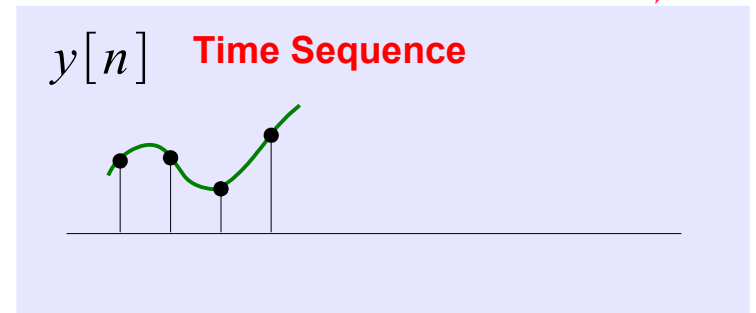
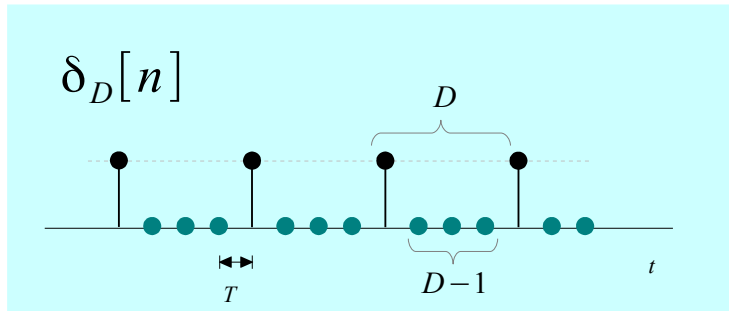

# Suppressing D-1 Samples

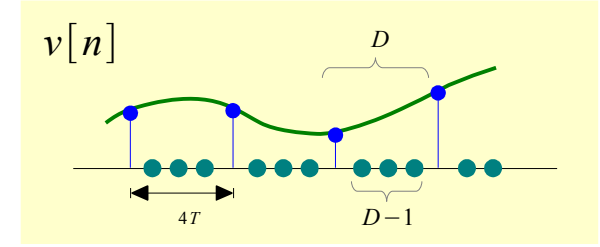
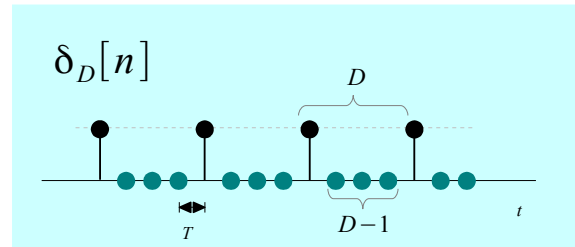
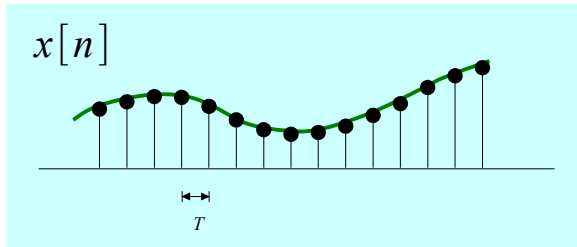

$$\delta_D[n] = \begin{cases} 1 & \text{if } \text{mod}(n, D) = 0 \\ 0 & \text{otherwise} \end{cases} \quad v[n] = \delta_D[n]x[n]$$

$$V[z] = \dots + v[0]z^0 + v[D]z^{-D} + v[2D]z^{-2D} + \dots$$

$$V[z] = \sum_{n=-\infty}^{+\infty} v[n]z^{-n} = \sum_{m=-\infty}^{+\infty} v[mD]z^{-Dm} = F(z^D)$$

# Example When D=2 (1)

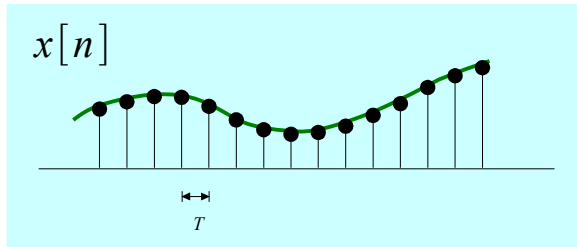

$$x[n] = e^{j\omega n}$$

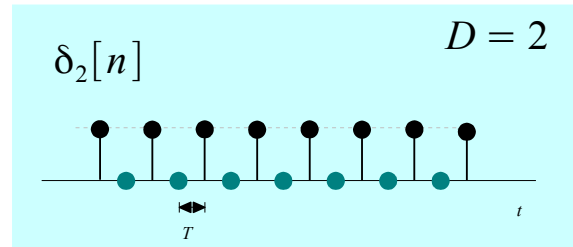

$$\begin{aligned} \delta_2[n] &= \frac{1}{2}(1 + (-1)^n) \\ &= \frac{1}{2}(1 + e^{-j\pi n}) \\ &\quad (e^{-j\pi} = -1) \end{aligned}$$

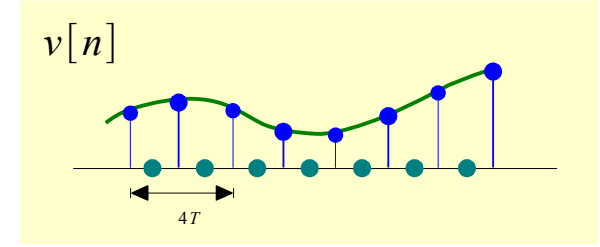

$$\begin{aligned} v[n] &= \frac{1}{2}x[n] + \frac{1}{2}e^{-j\pi n}x[n] \\ &= \frac{1}{2}e^{j\omega n} + \frac{1}{2}e^{-j\pi n}e^{j\omega n} \\ &= \frac{1}{2}e^{j\omega n} + \frac{1}{2}e^{+j(\omega-\pi)n} \end{aligned}$$

$$V(z) = \frac{1}{2} \sum_{n=-\infty}^{+\infty} (x[n]z^{-n} + x[n](-z)^{-n}) = \frac{1}{2}X(z) + \frac{1}{2}X(-z)$$

$$V(e^{j\omega}) = \frac{1}{2}X(e^{j\omega}) + \frac{1}{2}X(e^{-j\pi}e^{j\omega})$$

$$V(\omega) = \frac{1}{2}X(\omega) + \frac{1}{2}X(\omega - \pi)$$

# Example When D=2 (2)

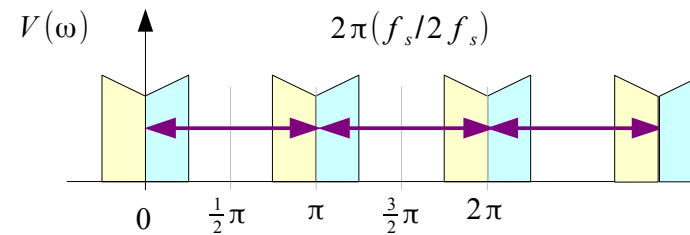
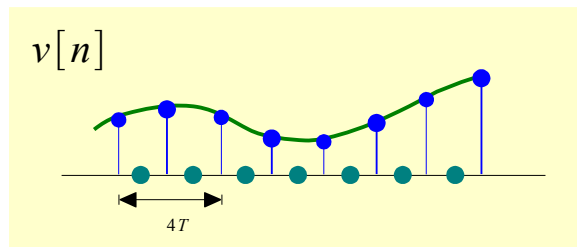
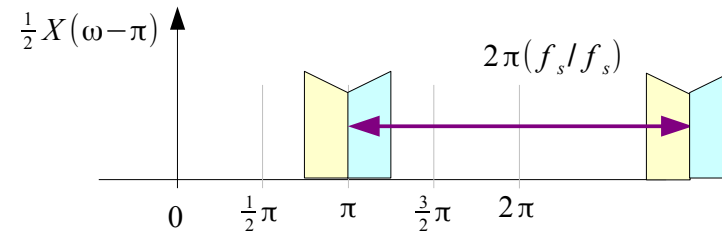
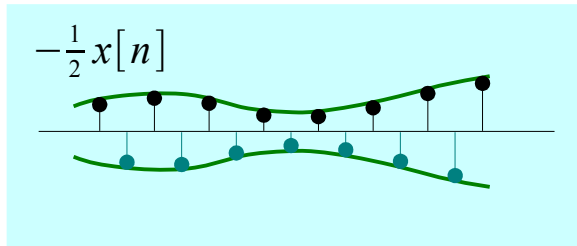
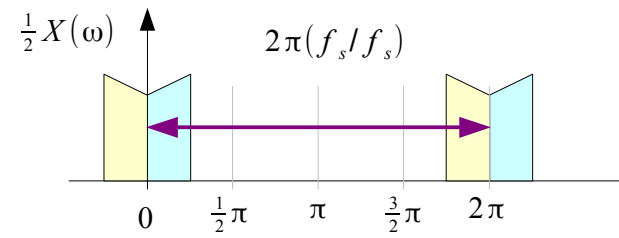
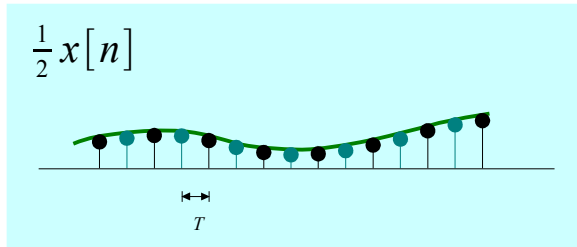

$$v[n] = \frac{1}{2}x[n] + \frac{1}{2}e^{-j\pi n}x[n]$$

$$V(z) = \frac{1}{2}X(z) + \frac{1}{2}X(-z)$$

$$V(e^{j\omega}) = \frac{1}{2}X(e^{j\omega}) + \frac{1}{2}X(e^{-j\pi}e^{j\omega})$$

$$V(\omega) = \frac{1}{2}X(\omega) + \frac{1}{2}X(\omega - \pi)$$

# Z-Transform & Suppressing D-1 Samples (1)

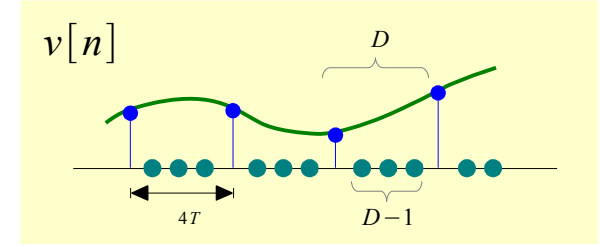
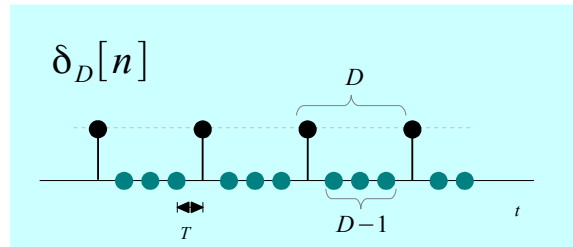
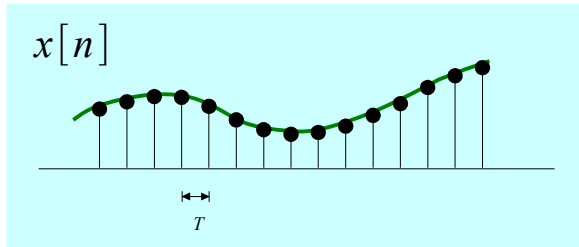

$$\delta_D[n] = \frac{1}{D} \sum_{k=0}^{D-1} e^{-j2\pi kn/D} = \begin{cases} \frac{1}{D} D = 1 & \text{if } \text{mod}(n, D) = 0 \\ \frac{1}{D} \frac{1 - e^{-j2\pi n}}{1 - e^{-j2\pi n/D}} = 0 & \text{otherwise} \end{cases} \quad v[n] = \delta_D[n]x[n]$$

$$v[n] = \delta_D[n]x[n] = \frac{1}{D} \sum_{k=0}^{D-1} x[n] e^{-j2\pi kn/D} \quad Z\{x[n] e^{-j\omega_k n}\} = \sum_{n=-\infty}^{+\infty} x[n] (e^{j\omega_k \cdot z})^{-n} = X(e^{j\omega_k \cdot z})$$

$$\omega_k = 2\pi k/D$$

$$e^{-j2\pi kn/D} \cdot z = e^{-j2\pi k/D} e^{j\omega} = e^{j(\omega - 2\pi k/D)}$$

$$V(\omega) = \frac{1}{D} \sum_{k=0}^{D-1} X(\omega - 2\pi k/D)$$

# Z-Transform & Suppressing D-1 Samples (2)

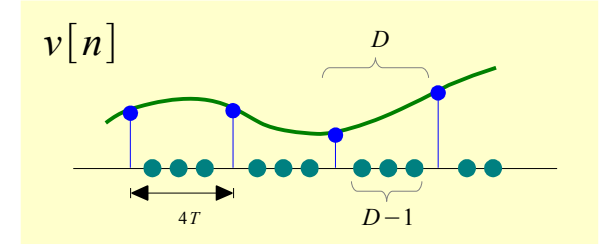
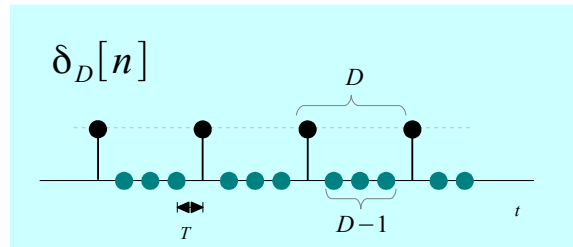
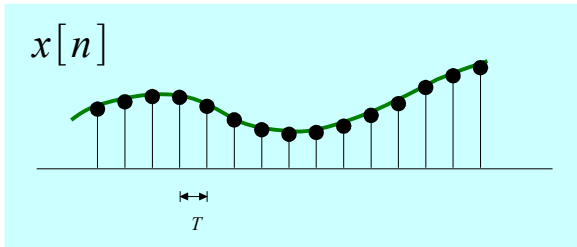

$$V(z) = \frac{1}{D} \sum_{k=0}^{D-1} X(e^{-j2\pi k/D} \cdot z)$$

$$V(\omega) = \frac{1}{D} \sum_{k=0}^{D-1} X(\omega - 2\pi k/D)$$

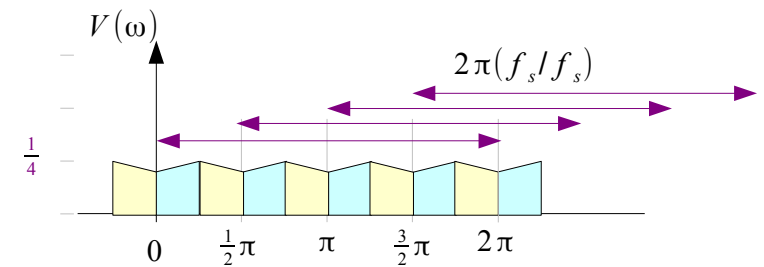
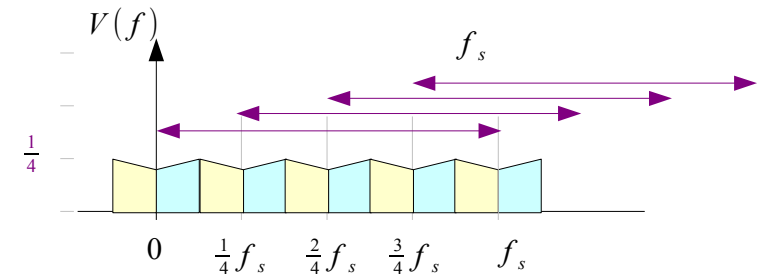
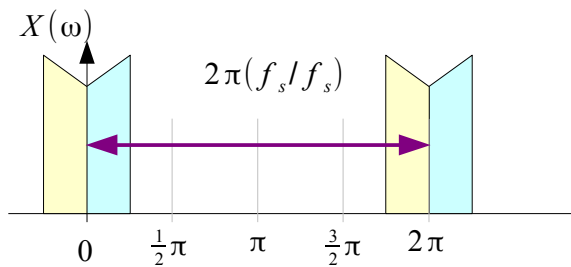
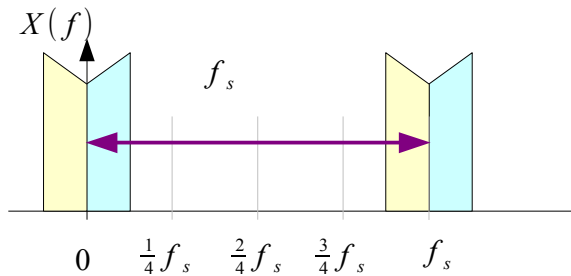

# Z-Transform & Removing D-1 Zeros (1)

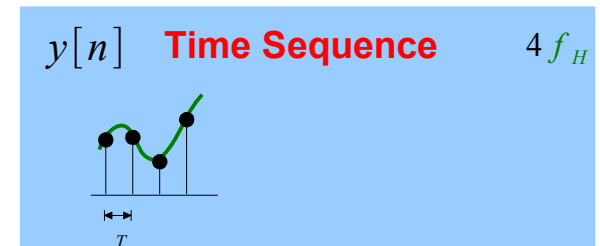
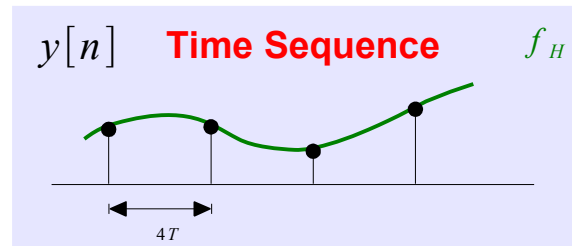
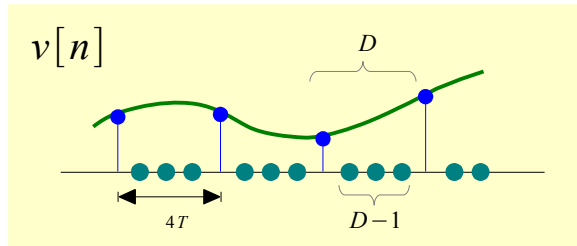

$$\begin{aligned}
 Y(z) &= \cdots + \underline{y[0]} + \underline{y[1]}z^{-1} + \underline{y[2]}z^{-2} + \cdots + \underline{y[n]}z^{-n} + \cdots \\
 &= \cdots + \underline{v[0]} + \underline{v[D]}z^{-1} + \underline{v[2D]}z^{-2} + \cdots + \underline{v[nD]}z^{-n} + \cdots
 \end{aligned}$$

$$Y(z) = V(z^{1/D})$$

$$V(z) = \frac{1}{D} \sum_{k=0}^{D-1} X(e^{-j2\pi k/D} \cdot z)$$

$$Y(z) = \frac{1}{D} \sum_{k=0}^{D-1} X(e^{-j2\pi k/D} \cdot z^{1/D})$$

$$V(\omega) = \frac{1}{D} \sum_{k=0}^{D-1} X(\omega - 2\pi k/D)$$

$$Y(\omega) = \frac{1}{D} \sum_{k=0}^{D-1} X(\omega/D - 2\pi k/D)$$

# Z-Transform & Removing D-1 Zeros (2)

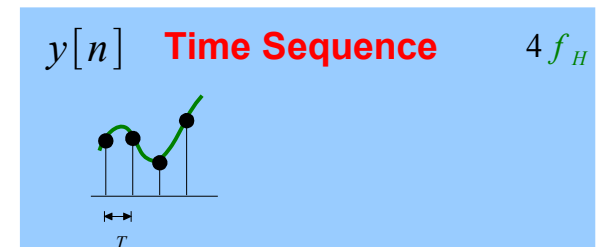
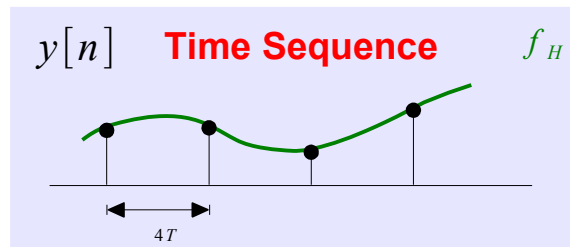
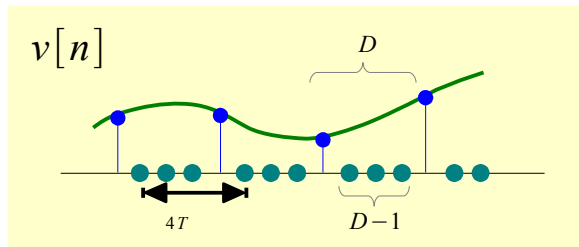

$$V(z) = \frac{1}{D} \sum_{k=0}^{D-1} X(e^{-j2\pi k/D} \cdot z)$$

$$Y(z) = \frac{1}{D} \sum_{k=0}^{D-1} X(e^{-j2\pi k/D} \cdot z^{1/D})$$

$$V(\omega) = \frac{1}{D} \sum_{k=0}^{D-1} X(\omega - 2\pi k/D)$$

$$Y(\omega) = \frac{1}{D} \sum_{k=0}^{D-1} X(\omega/D - 2\pi k/D)$$

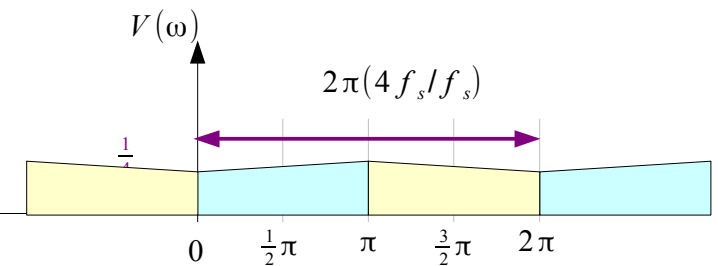
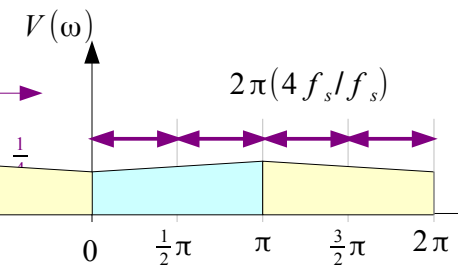
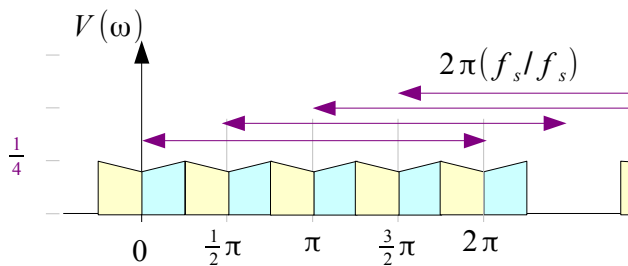
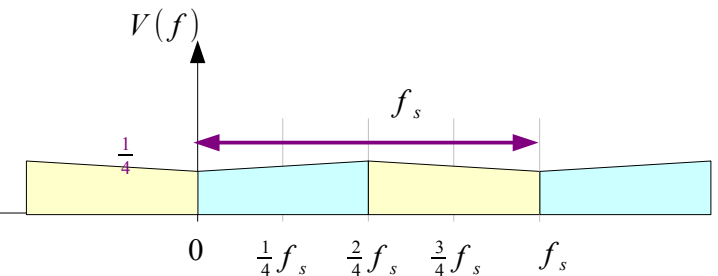
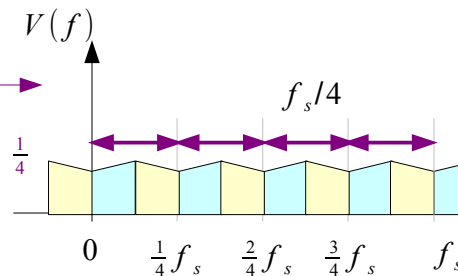
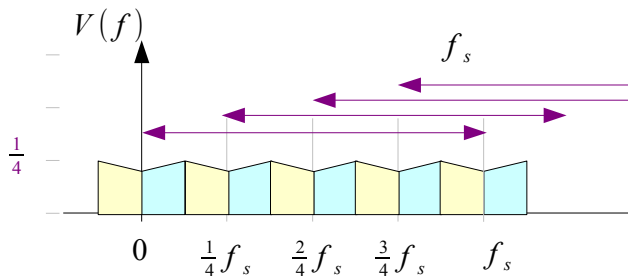



# Down Sampling

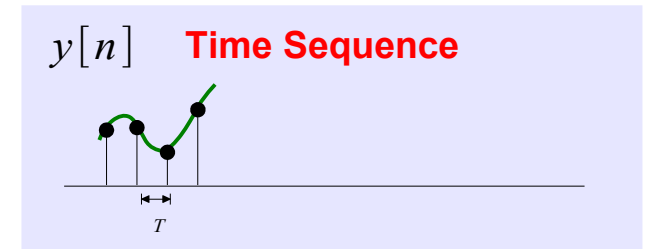
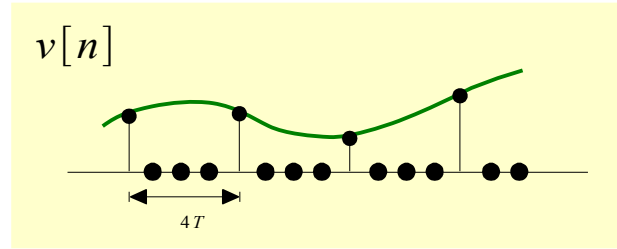
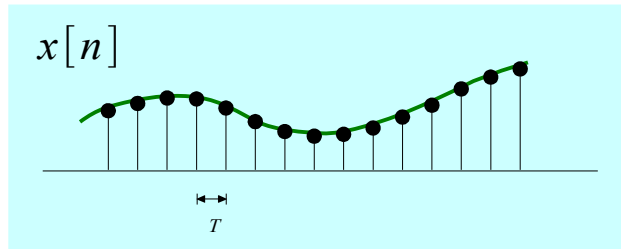

$T$  Sampling Period

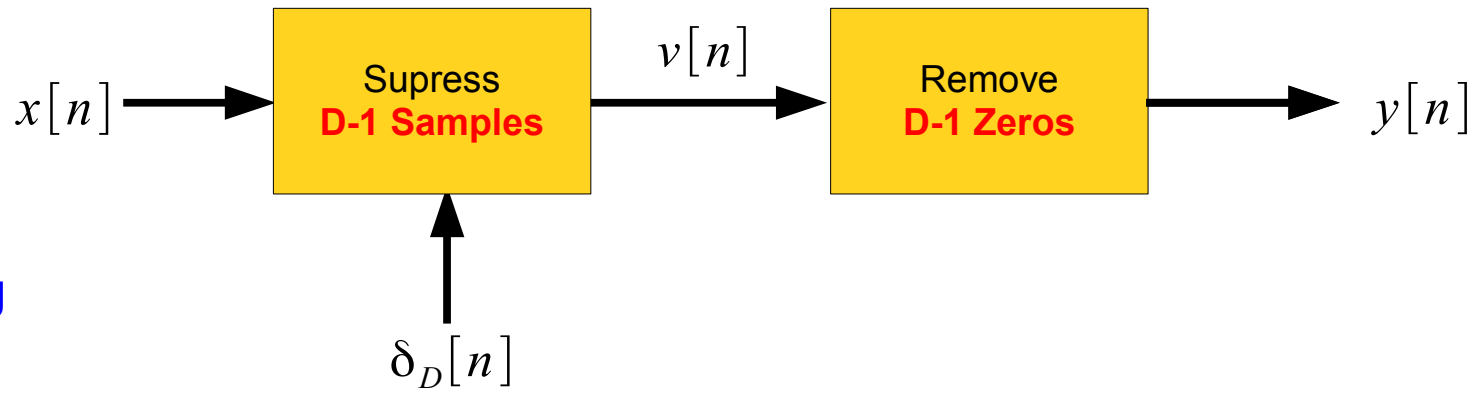

Ideal Sampling

Amplitude Axis Scaling  
 $1 / D$

Time Axis Scaling  
 $1 / D$

Spectrum Replication  
 $f_s / D$

Stretching Spectrum  
 $\omega / D$

# Measuring Rotation Rate

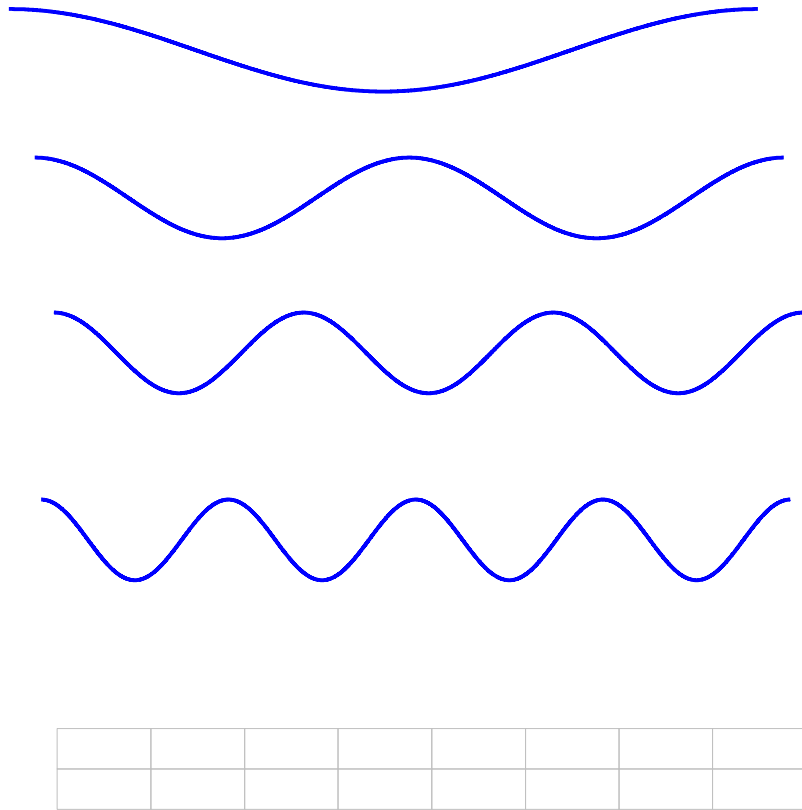

# Signals with Harmonic Frequencies (1)

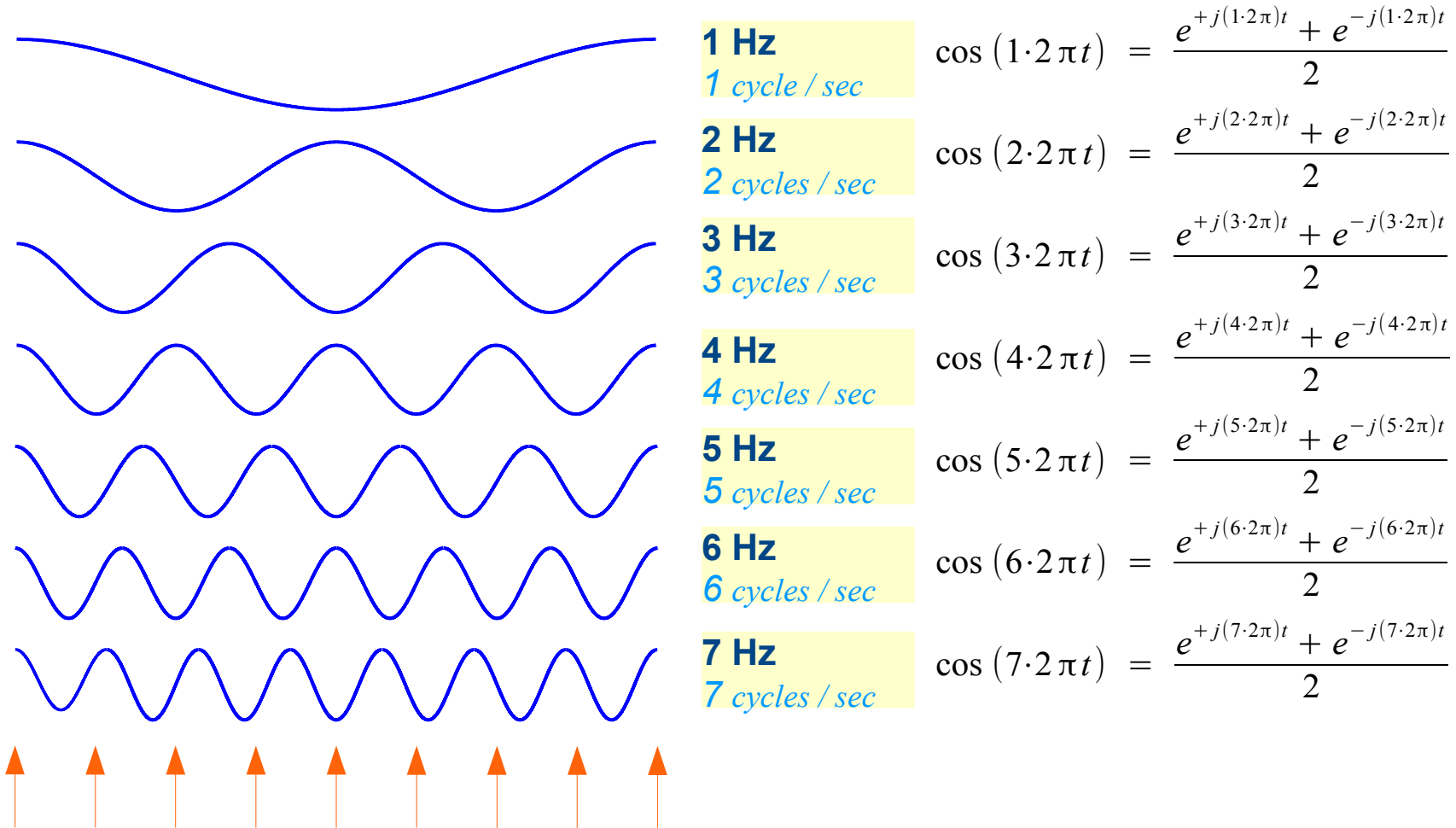

# Signals with Harmonic Frequencies (2)

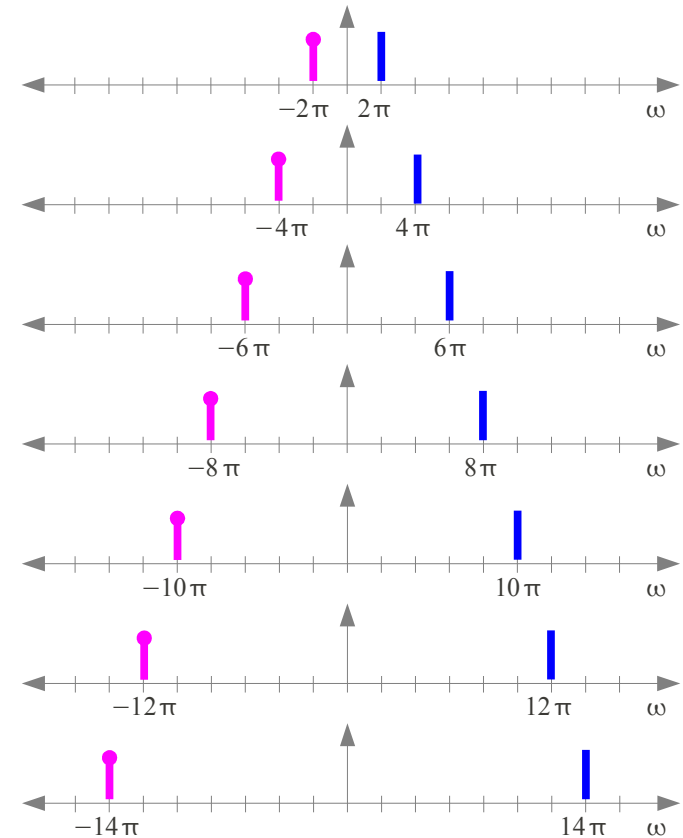
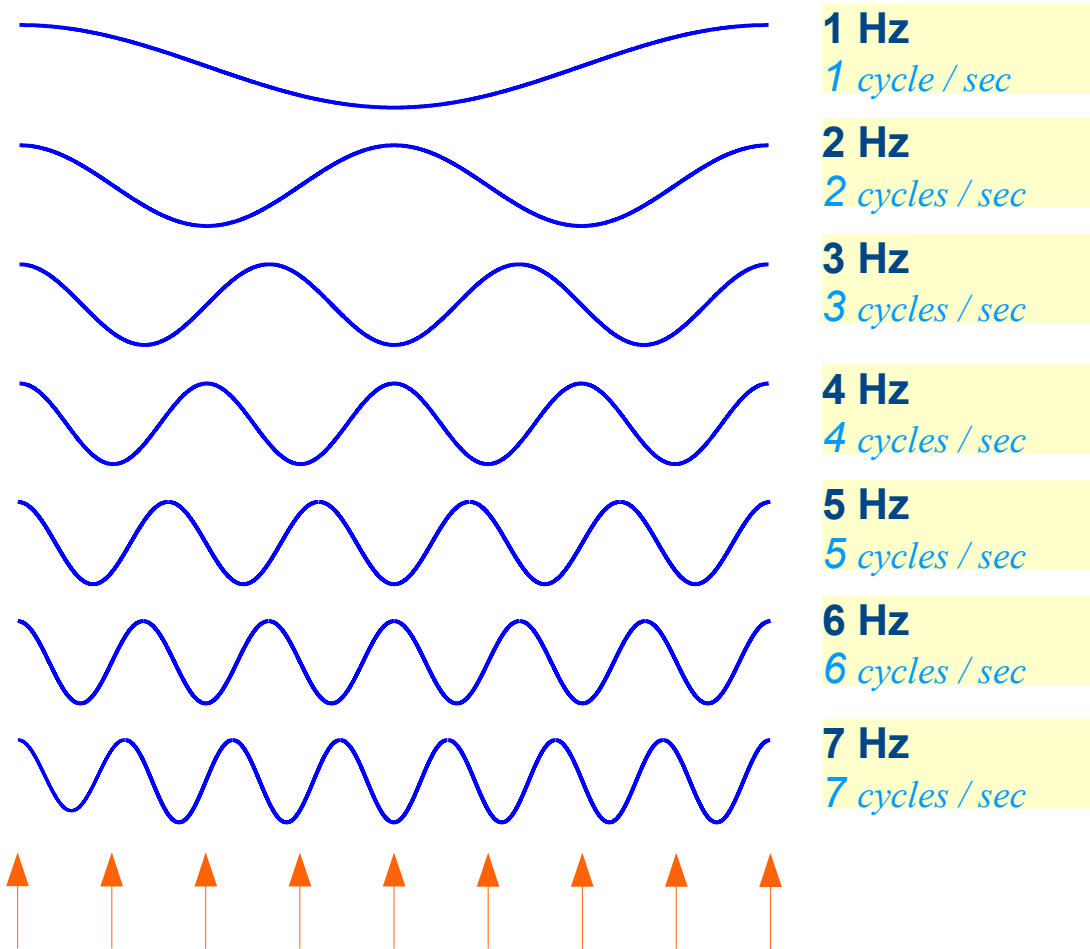

# Sampling Frequency

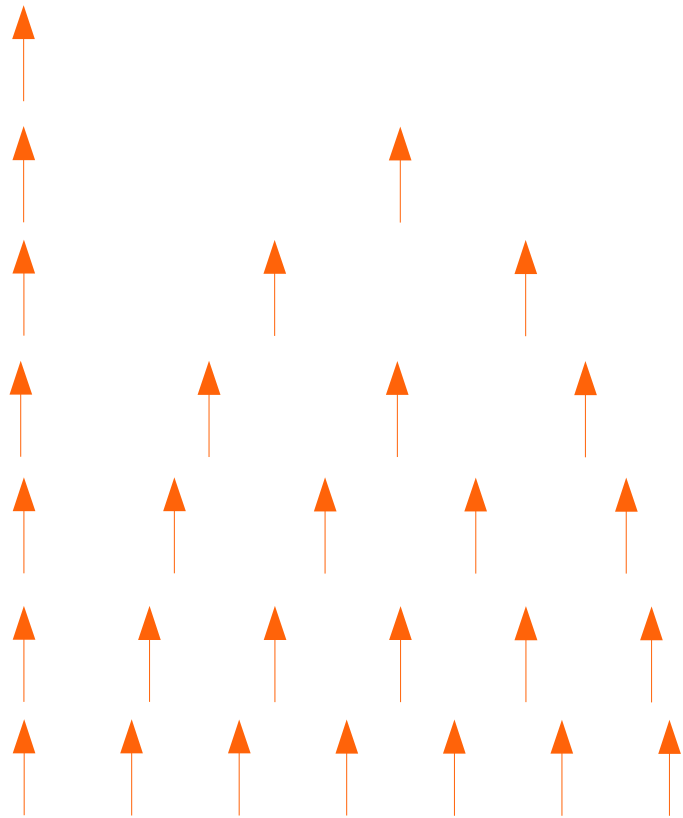

- 1 Hz  
*1 sample / sec*
- 2 Hz  
*2 samples / sec*
- 3 Hz  
*3 samples / sec*
- 4 Hz  
*4 samples / sec*
- 5 Hz  
*5 samples / sec*
- 6 Hz  
*6 samples / sec*
- 7 Hz  
*7 samples / sec*

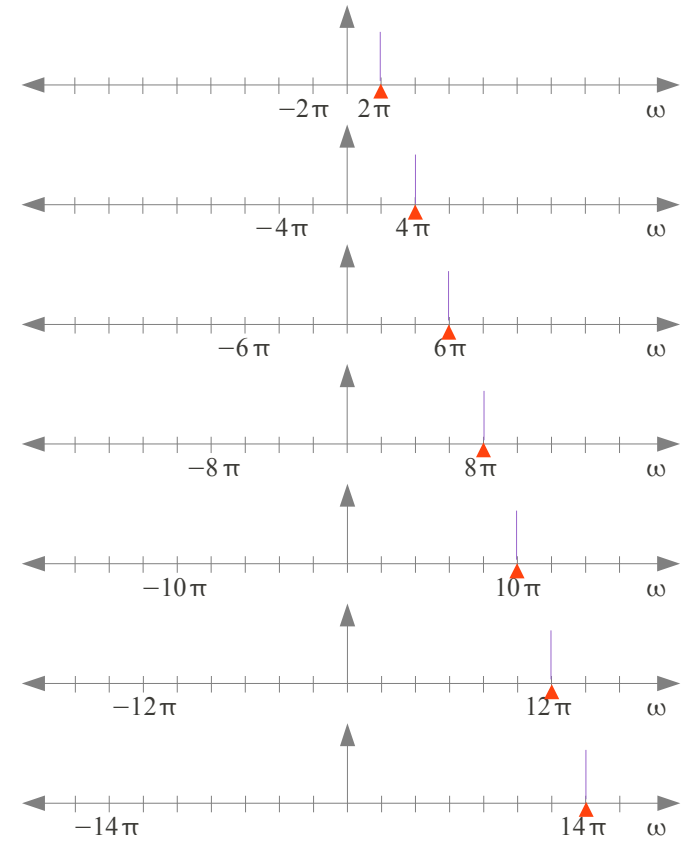

# Nyquist Frequency

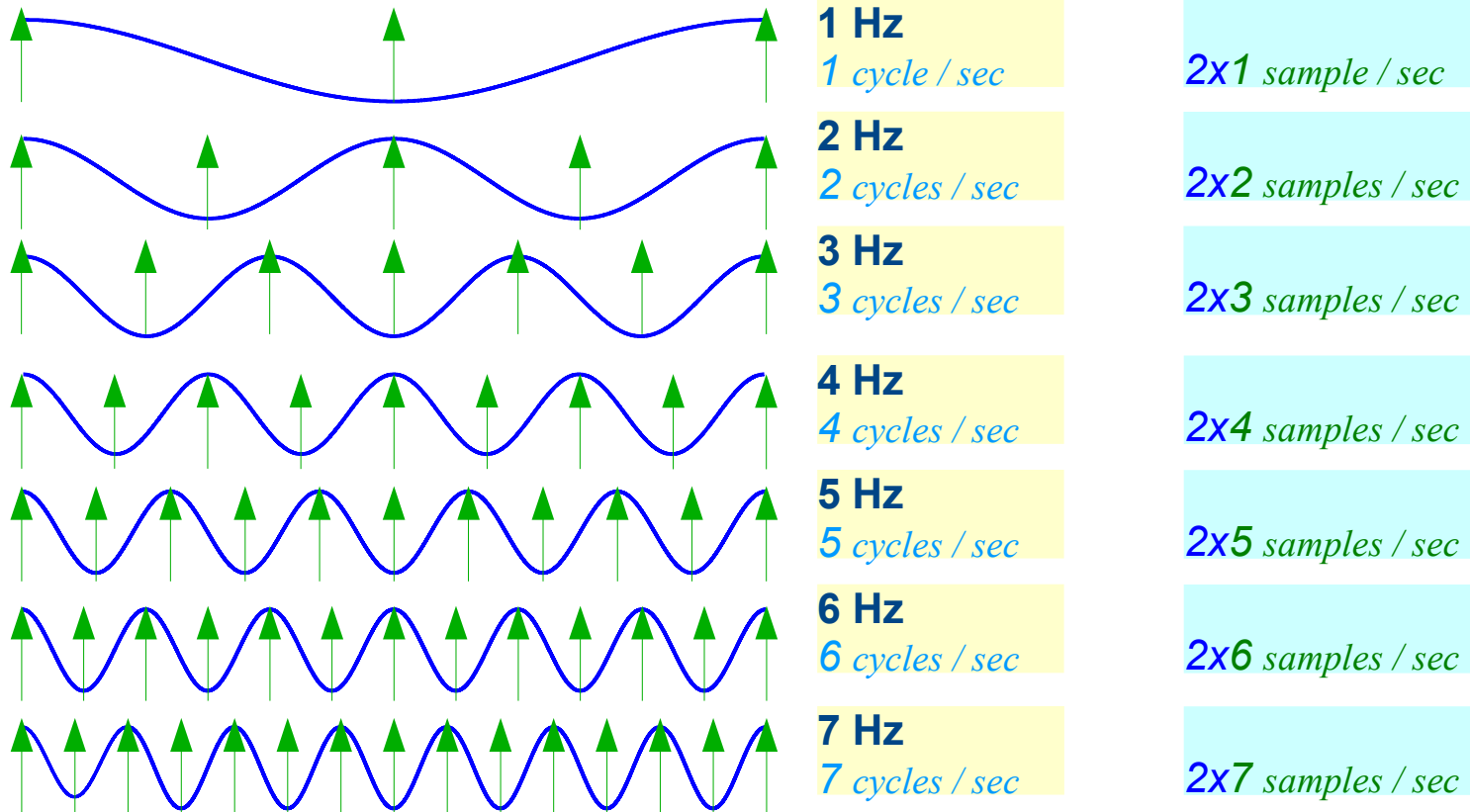

# Aliasing

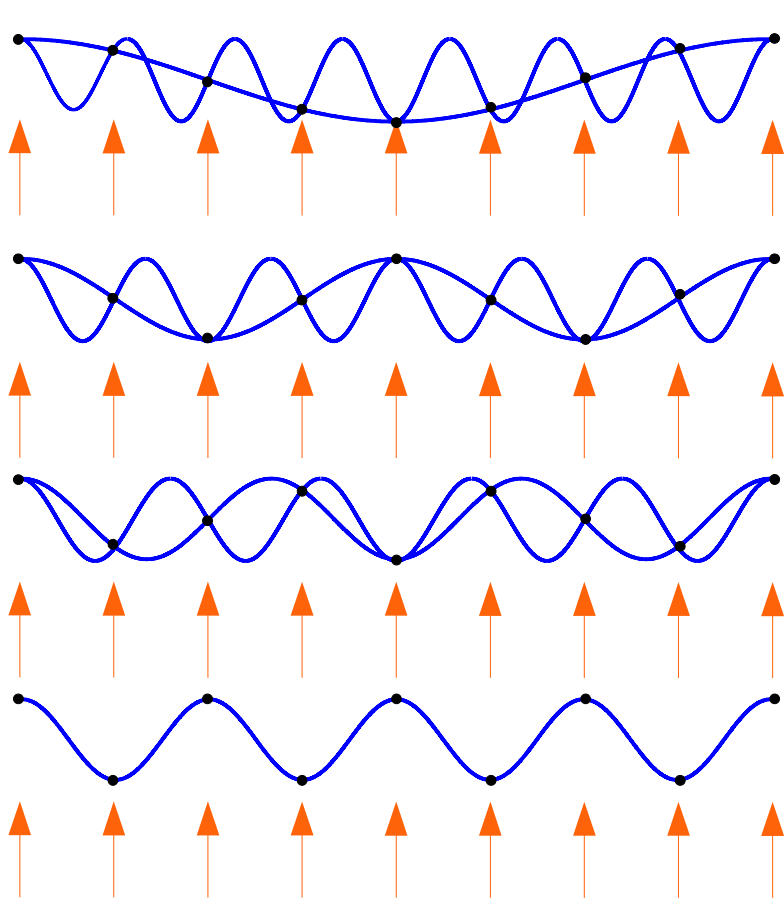

1 Hz  
7 Hz

2x4 samples / sec

2 Hz  
6 Hz

2x4 samples / sec

3 Hz  
5 Hz

2x4 samples / sec

4 Hz

2x4 samples / sec

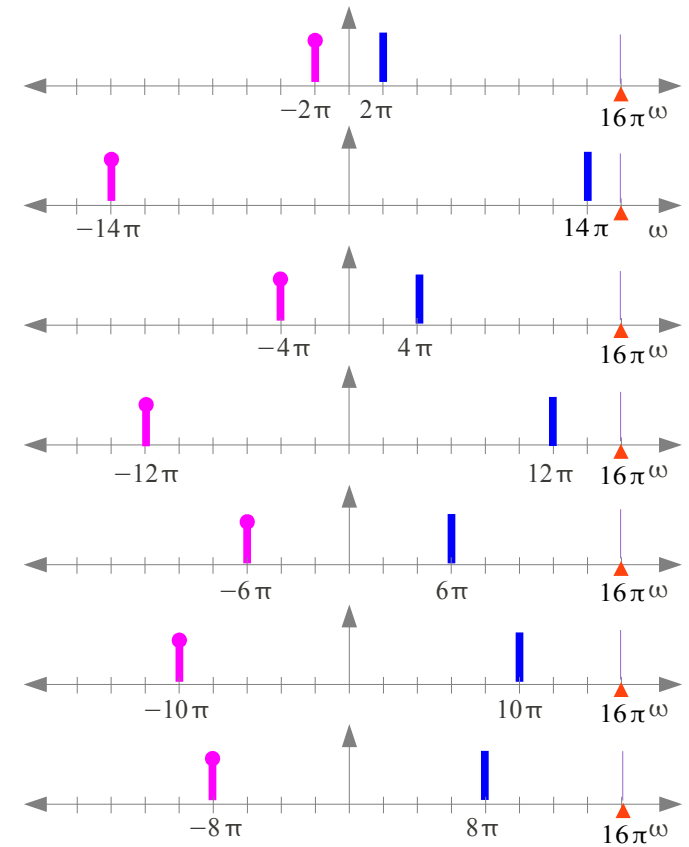

# Sampling

$$\omega_s = 2\pi f_s \text{ (rad/sec)}$$

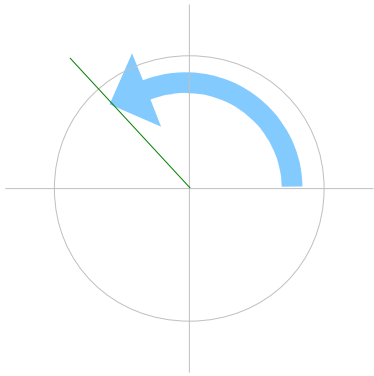

$$\omega_1 = 2\pi f_1$$

$$\omega_1 = \frac{\omega_s}{2} \text{ (rad/sec)}$$

$$f_1 = \frac{f_s}{2} \text{ (rad/sec)}$$

$$\omega_2 = 2\pi f_2$$

$$\omega_2 = -\frac{\omega_s}{2} \text{ (rad/sec)}$$

$$f_2 = -\frac{f_s}{2} \text{ (rad/sec)}$$

$$2\pi \text{ (rad)} / T_s \text{ (sec)}$$

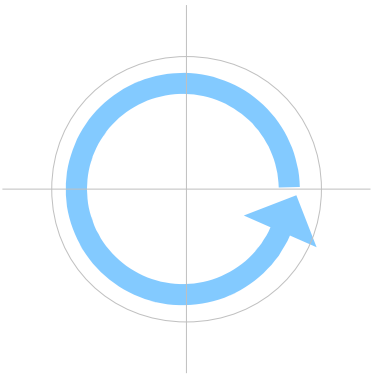

$$\pi \text{ (rad)} / T_s \text{ (sec)}$$

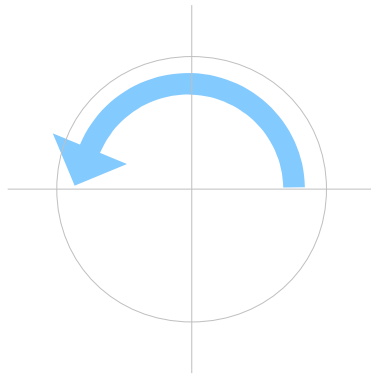

$$-\pi \text{ (rad)} / T_s \text{ (sec)}$$

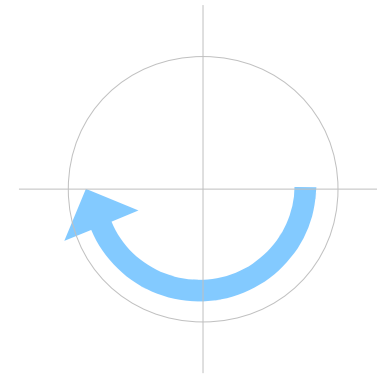



# Sampling

$$\omega_1 = 2\pi f_1 \text{ (rad/sec)}$$

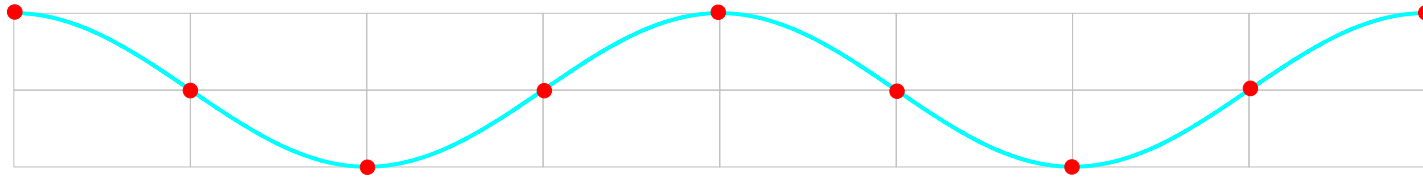

$$\omega_s = 2\pi f_s \text{ (rad/sec)}$$

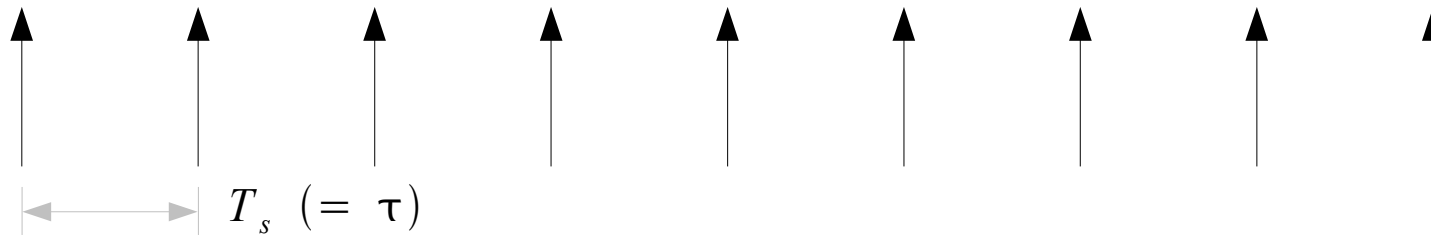

$$2\pi \text{ (rad)} / T_s \text{ (sec)}$$

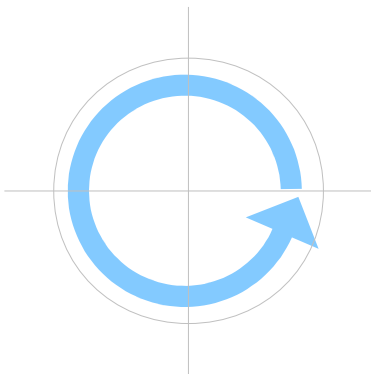

$$\frac{\pi}{2} \text{ (rad)} / T_s \text{ (sec)}$$

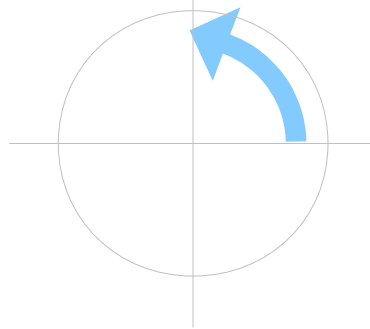

For the period of  $T_s$   
Angular displacement  $\frac{\pi}{2}$  (rad)

$$\begin{aligned} \hat{\omega} &= \omega \cdot T_s \text{ (rad)} \\ &= 2\pi f_1 \cdot T_s \text{ (rad)} \\ &= 2\pi \frac{f_s}{4} \cdot T_s \text{ (rad)} \\ &= \frac{\pi}{2} \text{ (rad)} \end{aligned}$$

# Angular Frequencies in Sampling

## continuous-time signals

Signal Frequency

$$f_0 = \frac{1}{T_0}$$

Signal Angular Frequency

$$\omega_0 = 2\pi f_0 \text{ (rad/sec)}$$

For 1 second  
 $2\pi f_0 \text{ (rad/sec)}$

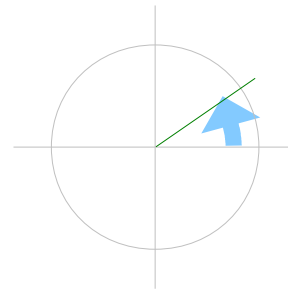

For 1 revolution  
 $2\pi \text{ (rad)}$   
 $T_0 \text{ (sec)}$

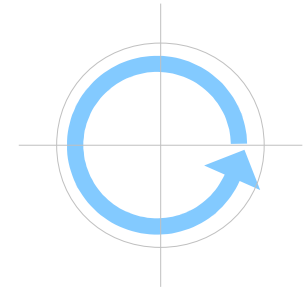

## sampling sequence

Sampling Frequency

$$f_s = \frac{1}{T_s}$$

Sampling Angular Frequency

$$\omega_s = 2\pi f_s \text{ (rad/sec)}$$

For 1 second  
 $2\pi f_s \text{ (rad/sec)}$

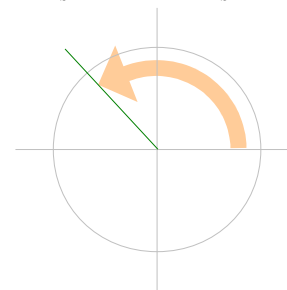

For 1 revolution  
 $2\pi \text{ (rad)}$   
 $T_s \text{ (sec)}$

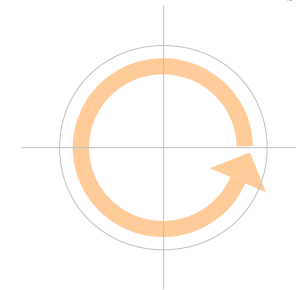







## References

- [1] <http://en.wikipedia.org/>
- [2] J.H. McClellan, et al., Signal Processing First, Pearson Prentice Hall, 2003
- [3] A "graphical interpretation" of the DFT and FFT, by Steve Mann
- [4] R. Cristi, "Modern Digital Signal Processing"