

# CTFT (2B)

---

- Continuous Time Fourier Transform

Copyright (c) 2009 Young W. Lim.

Permission is granted to copy, distribute and/or modify this document under the terms of the GNU Free Documentation License, Version 1.2 or any later version published by the Free Software Foundation; with no Invariant Sections, no Front-Cover Texts, and no Back-Cover Texts. A copy of the license is included in the section entitled "GNU Free Documentation License".

Please send corrections (or suggestions) to [youngwlim@hotmail.com](mailto:youngwlim@hotmail.com).

This document was produced by using OpenOffice and Octave.

# Impulse Response

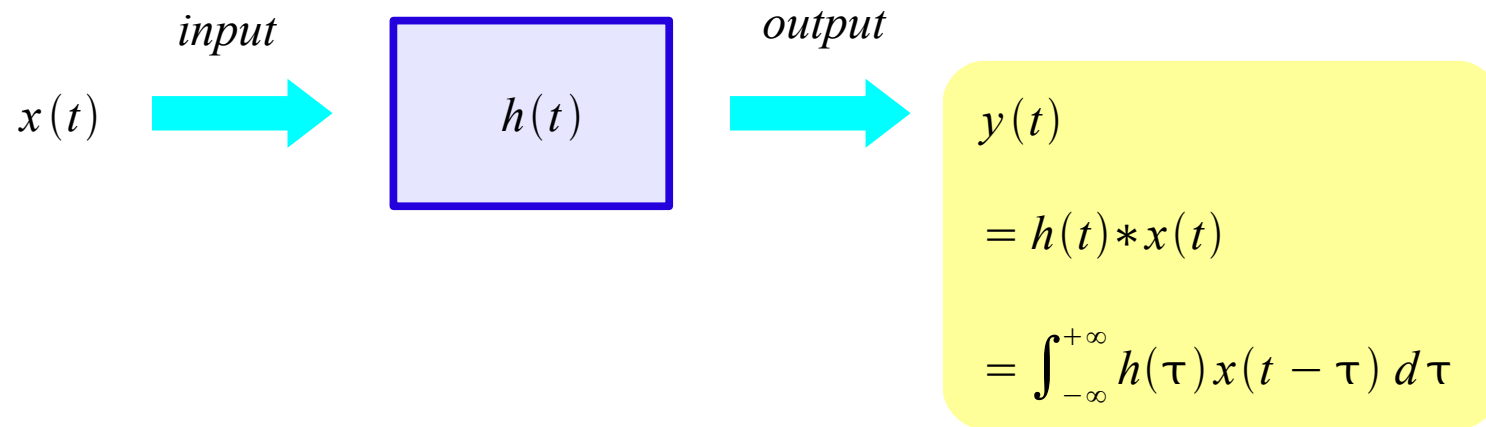
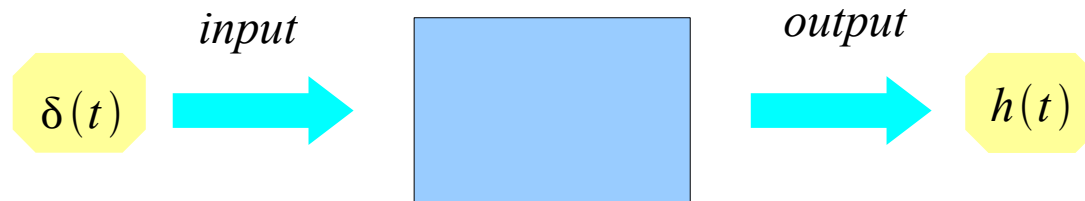
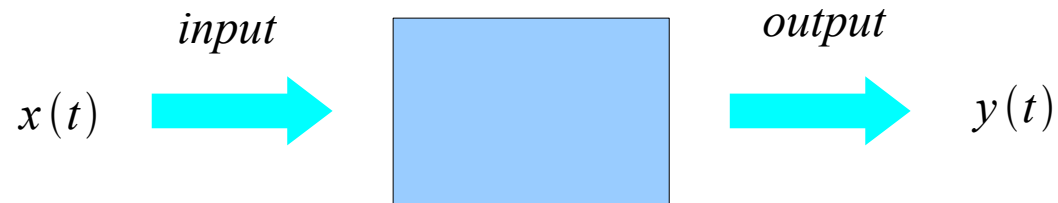

# Frequency Response

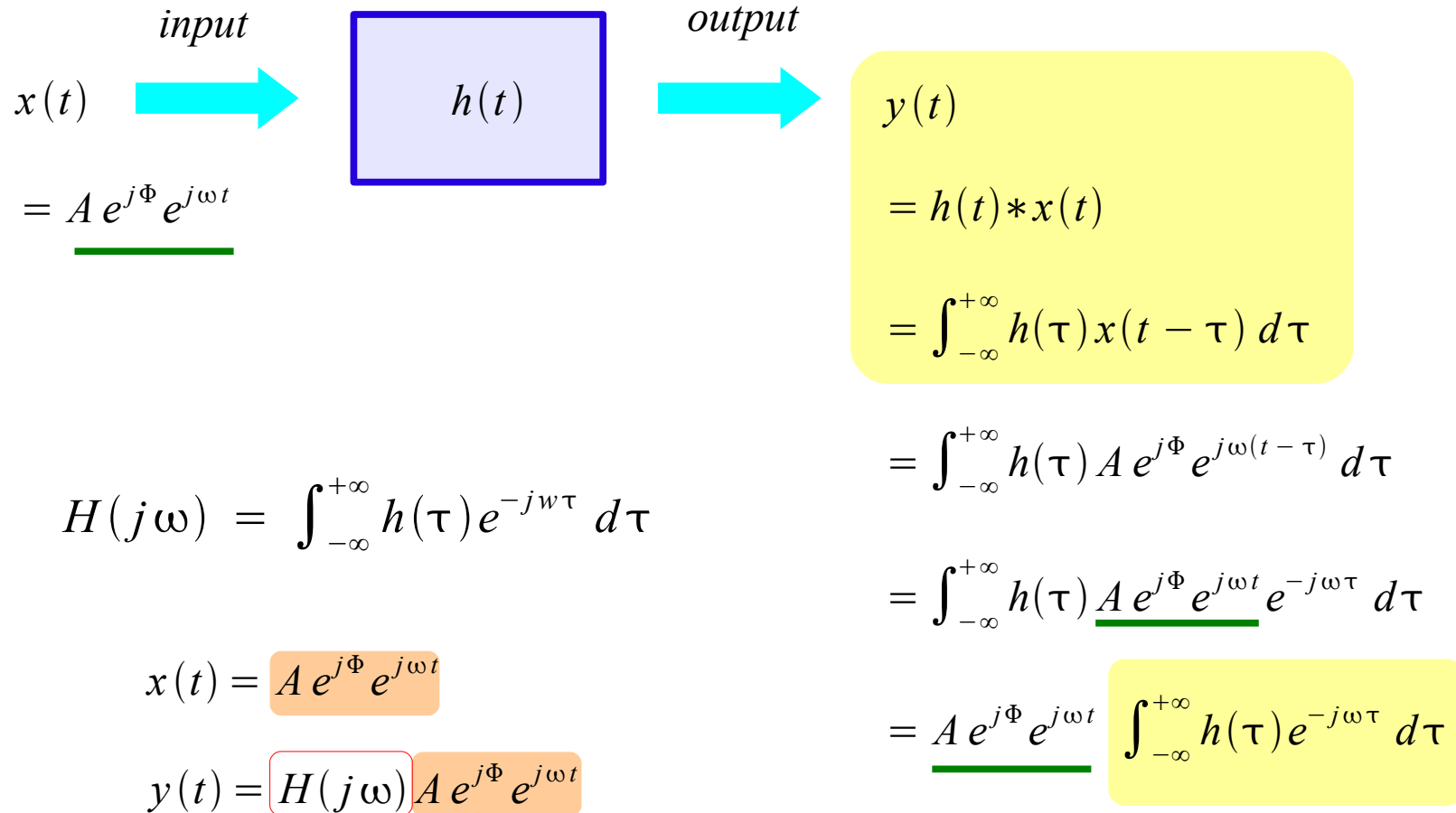

# CTFT of a Rect(t/T) function (1)

## Continuous Time Fourier Transform

## Aperiodic Continuous Time Signal

$$X(j\omega) = \int_{-\infty}^{+\infty} x(t) e^{-j\omega t} dt \quad \longleftrightarrow \quad x(t) = \frac{1}{2\pi} \int_{-\infty}^{+\infty} X(j\omega) e^{+j\omega t} d\omega$$

$$\begin{aligned} X(j\omega) &= \int_{-T/2}^{+T/2} e^{-j\omega t} dt \\ &= \left[ \frac{-1}{j\omega} e^{-j\omega t} \right]_{-T/2}^{+T/2} = -\frac{e^{-j\omega T/2} - e^{+j\omega T/2}}{j\omega} \\ &= \frac{\sin(\omega T/2)}{\omega/2} \end{aligned}$$

$$X(j0) = \lim_{\omega \rightarrow 0} \frac{\sin(\omega T/2)}{\omega/2} = \lim_{\omega \rightarrow 0} \frac{T \cos(\omega T/2)}{2 \cdot 1/2} = T$$

$$\sin(\omega T/2) = 0 \quad \rightarrow \quad \omega T/2 = \pi n$$

$$\rightarrow \quad \omega = \frac{2\pi}{T} n$$

$$\rightarrow \quad \omega = \pm \frac{2\pi}{T}, \pm \frac{4\pi}{T}, \pm \frac{6\pi}{T}, \dots$$

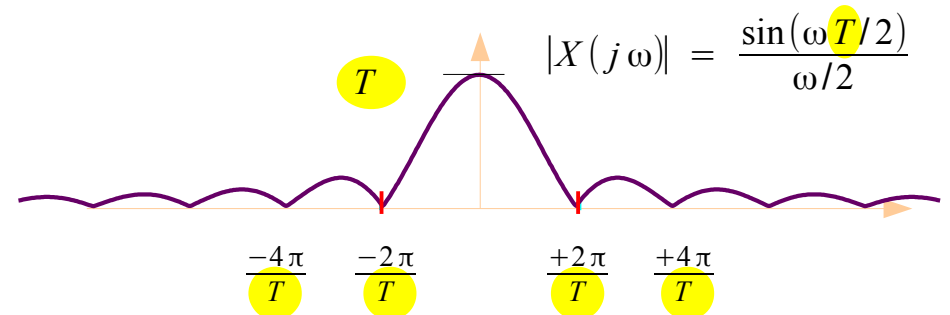
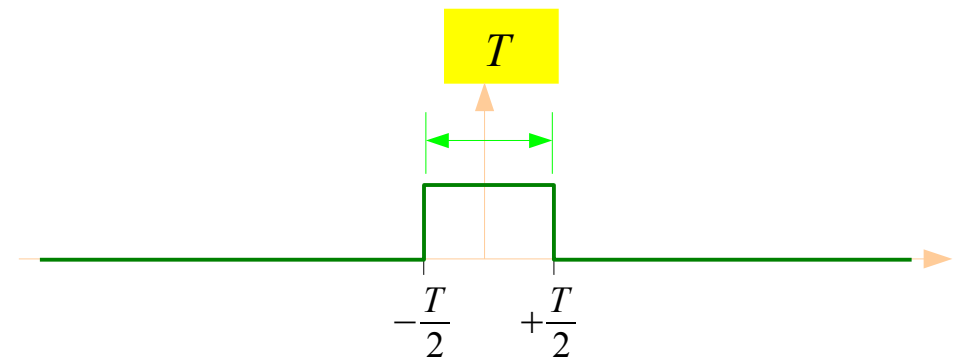

# CTFT of a Rect(t/T) function (2)

## Continuous Time Fourier Transform

## Aperiodic Continuous Time Signal

$$X(j\omega) = \int_{-\infty}^{+\infty} x(t) e^{-j\omega t} dt \quad \longleftrightarrow \quad x(t) = \frac{1}{2\pi} \int_{-\infty}^{+\infty} X(j\omega) e^{+j\omega t} d\omega$$

$$X(j\omega) = \int_{-T/2}^{+T/2} e^{-j\omega t} dt = \frac{\sin(\omega T/2)}{\omega/2}$$

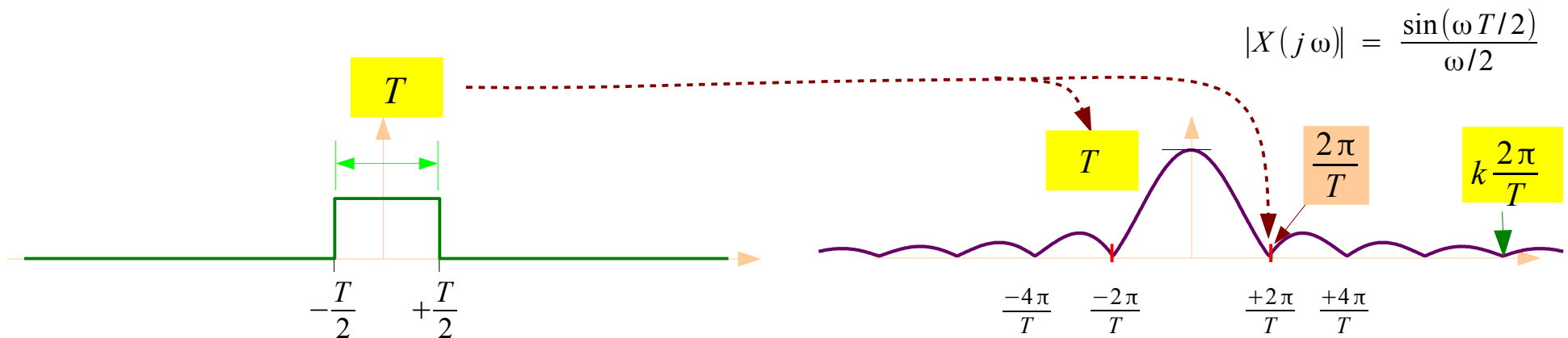

# CTFT and CTFS

## Continuous Time Fourier Transform

## Aperiodic Continuous Time Signal

$$X(j\omega) = \int_{-\infty}^{+\infty} x(t) e^{-j\omega t} dt \quad \longleftrightarrow \quad x(t) = \frac{1}{2\pi} \int_{-\infty}^{+\infty} X(j\omega) e^{+j\omega t} d\omega$$

$$X(j\omega) = \frac{\sin(\omega T/2)}{\omega/2}$$

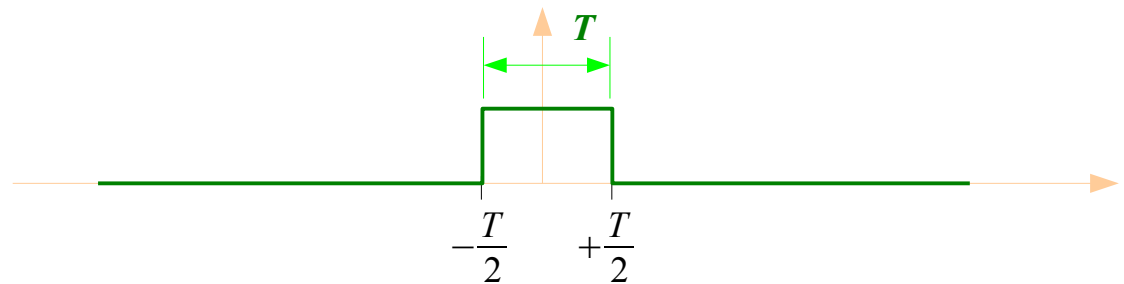

## Continuous Time Fourier Series

## Periodic Continuous Time Signal

$$C_k = \frac{1}{T} \int_0^T x(t) e^{-jk\omega_0 t} dt \quad \longleftrightarrow \quad x(t) = \sum_{n=-\infty}^{\infty} C_k e^{+jk\omega_0 t}$$

$$C_k = \frac{1}{T_0} \frac{\sin(k\omega_0 T/2)}{k\omega_0/2}$$



# CTFT ← CTFS

## Aperiodic Continuous Time Signal Continuous Time Fourier Transform

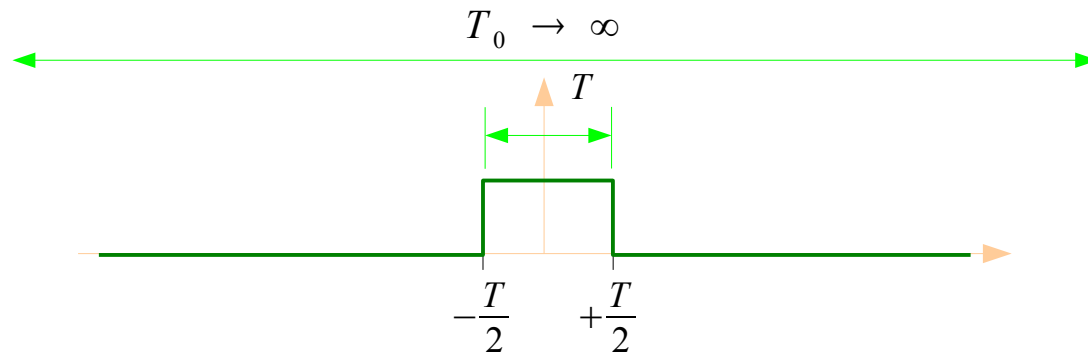

## Periodic Continuous Time Signal Continuous Time Fourier Series

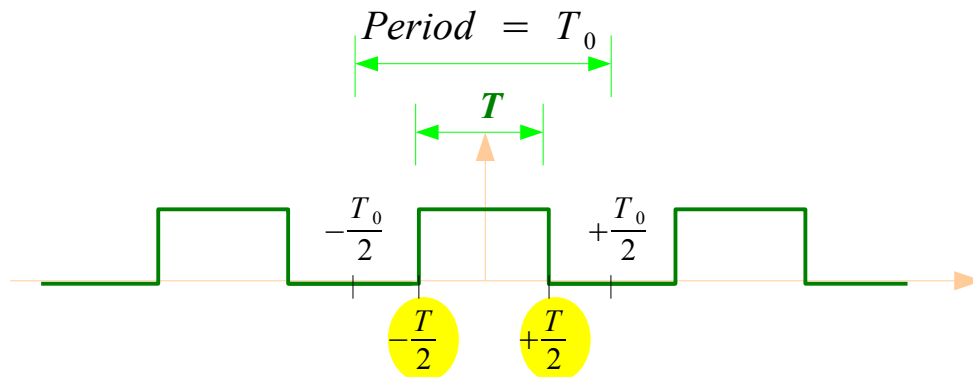

$$x(t)$$

$$\text{As } T_0 \rightarrow \infty, \\ x_{T_0}(t) \rightarrow x(t)$$

$$\omega_0 = \frac{2\pi}{T_0} \rightarrow 0$$

$$x_{T_0}(t) = \sum_{n=-\infty}^{+\infty} x(t - nT_0)$$



# CTFT and CTFS as $T_0 \rightarrow \infty$ (1)

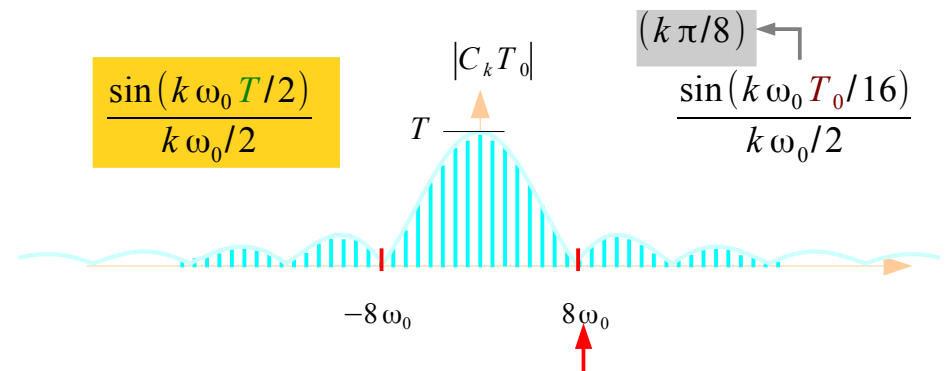
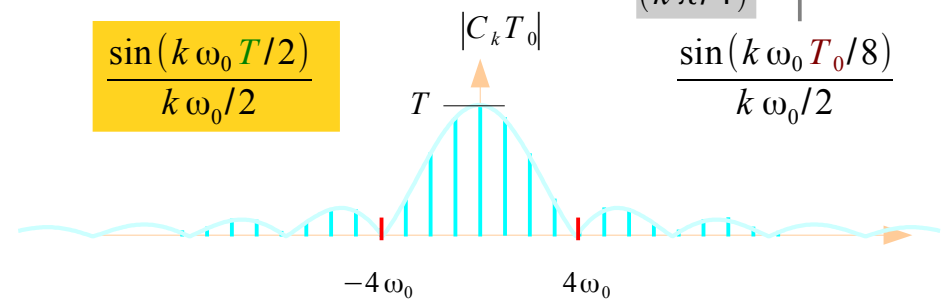
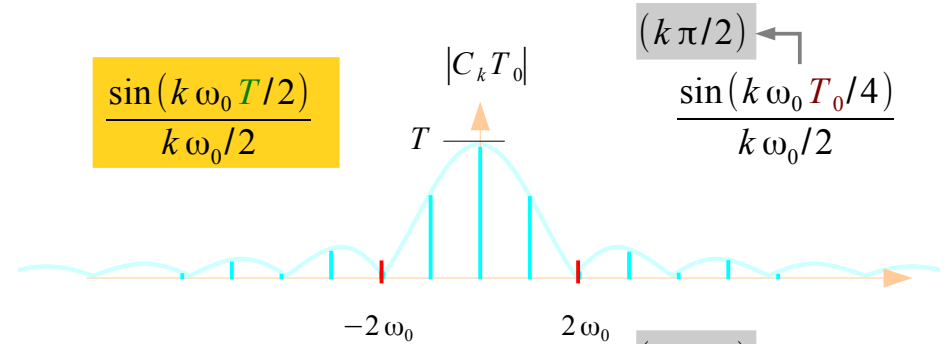
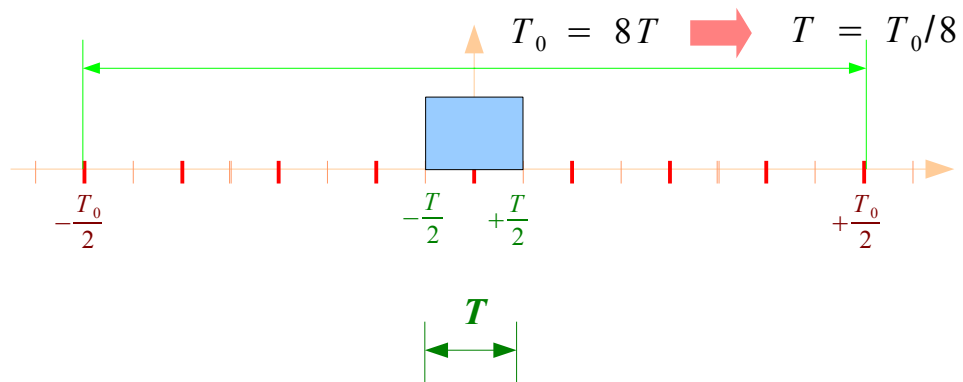
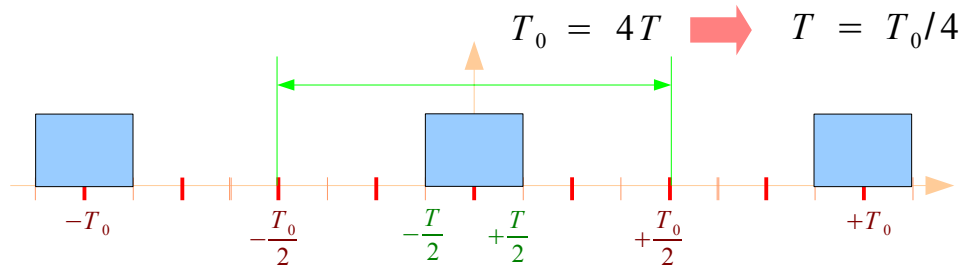
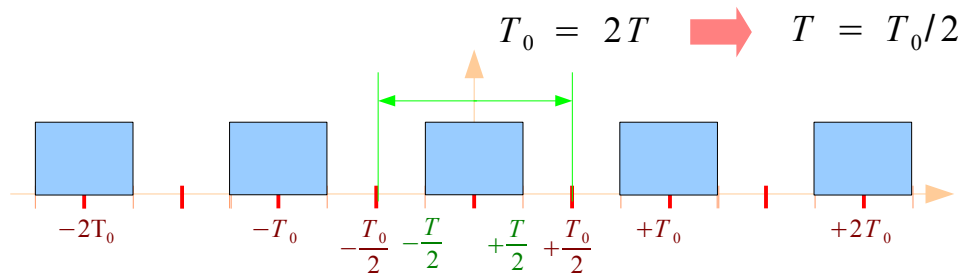

$\omega_0 = \frac{2\pi}{T_0} = \frac{2\pi}{8T} \rightarrow \frac{T_0}{T} \omega_0 = \frac{2\pi}{T}$

# CTFT and CTFS as $T_0 \rightarrow \infty$ (2)

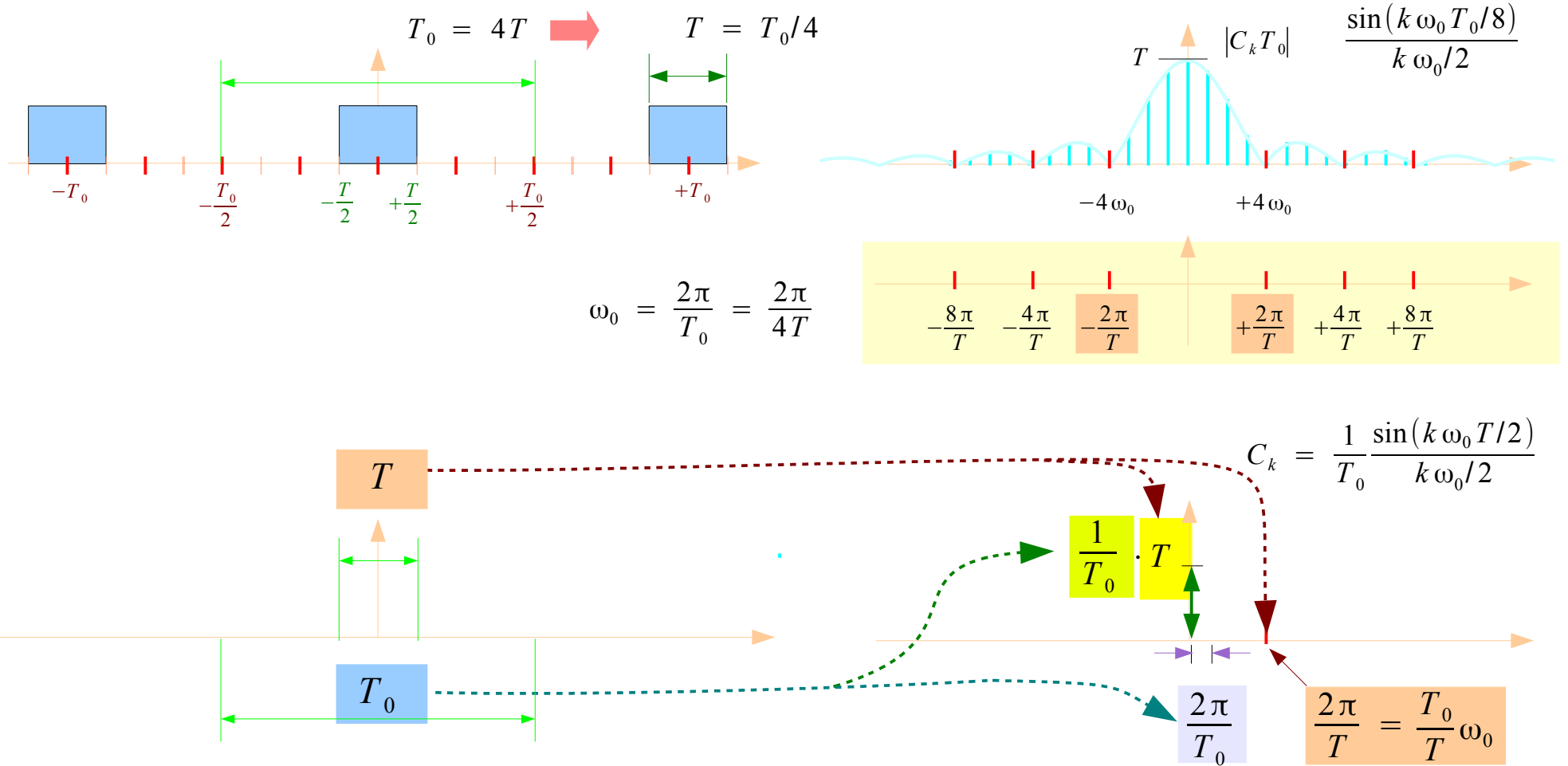

# CTFT of a Rect(t/T) function (3)

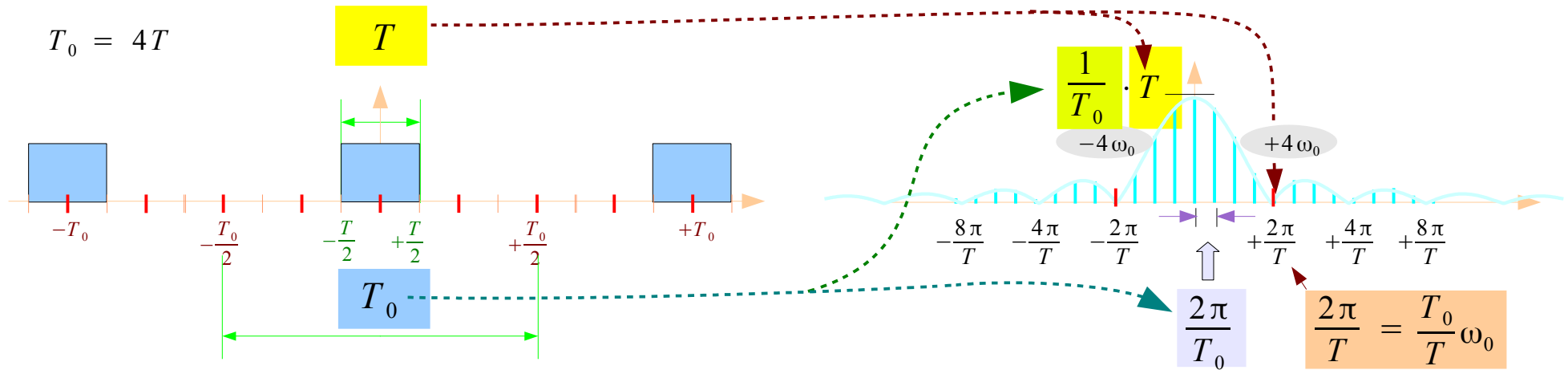

$$C_k T_0 = \frac{\sin(k \omega_0 T/2)}{k \omega_0/2}$$

$$C_k = \frac{1}{T_0} \frac{\sin(k \omega_0 T/2)}{k \omega_0/2}$$

$$X(j\omega) = \lim_{k \omega_0 \rightarrow \omega} \frac{\sin(k \omega_0 T/2)}{k \omega_0/2} = \frac{\sin(\omega T/2)}{\omega/2}$$

$$X(j\omega) = \frac{\sin(\omega T/2)}{\omega/2}$$

$$X(j\omega) = \frac{\sin(\omega T/2)}{\omega/2}$$

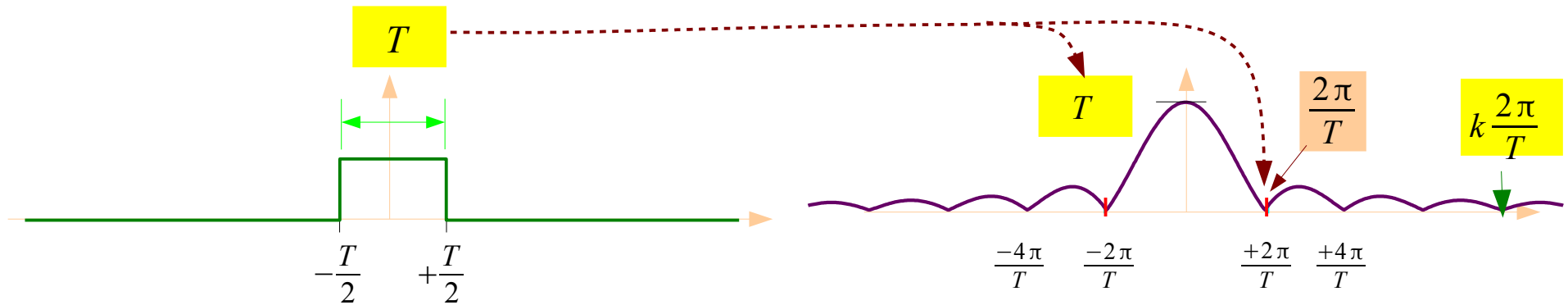

# From CTFS to CTFT

## Continuous Time Fourier Series

$$C_k = \frac{1}{T} \int_0^T x(t) e^{-jk\omega_0 t} dt \quad \longleftrightarrow \quad x(t) = \sum_{n=0}^{\infty} C_k e^{+jk\omega_0 t}$$

$$C_k = \frac{1}{T_0} \int_{-T_0/2}^{+T_0/2} x_{T_0}(t) e^{-jk\omega_0 t} dt$$

$$x_{T_0}(t) = \sum_{n=0}^{\infty} C_k e^{+jk\omega_0 t} \cdot \frac{2\pi}{2\pi} \cdot \frac{T_0}{T_0}$$

$$C_k T_0 = \int_{-T_0/2}^{+T_0/2} x_{T_0}(t) e^{-jk\omega_0 t} dt$$

$$x_{T_0}(t) = \frac{1}{2\pi} \sum_{k=0}^{\infty} C_k T_0 e^{+jk\omega_0 t} \cdot \frac{2\pi}{T_0}$$

$$T_0 \rightarrow \infty \quad \Rightarrow \quad C_k T_0 \rightarrow X(j\omega) \quad x_{T_0} \rightarrow x(t) \quad \omega_0 = \frac{2\pi}{T_0} \rightarrow d\omega$$

## Continuous Time Fourier Transform

$$X(j\omega) = \int_{-\infty}^{+\infty} x(t) e^{-j\omega t} dt \quad \longleftrightarrow \quad x(t) = \frac{1}{2\pi} \int_{-\infty}^{+\infty} X(j\omega) e^{+j\omega t} d\omega$$

# CTFT of Time Domain Impulse

## Continuous Time Fourier Transform

$$x(t) = A \delta(t) \quad \longleftrightarrow \quad X(j\omega) = A$$

$$X(j\omega) = \int_{-\infty}^{+\infty} x(t) e^{-j\omega t} dt$$

$$\begin{aligned} X(j\omega) &= \int_{-\infty}^{+\infty} A \delta(t) e^{-j\omega t} dt \\ &= \int_{-\infty}^{+\infty} A \delta(t) e^0 dt \\ &= A \int_{-\infty}^{+\infty} \delta(t) dt = A \end{aligned}$$

$$x(t) = \frac{1}{2\pi} \int_{-\infty}^{+\infty} X(j\omega) e^{+j\omega t} d\omega$$

$$\begin{aligned} x(t) &= \frac{1}{2\pi} \int_{-\infty}^{+\infty} A e^{+j\omega t} d\omega \\ &= \frac{A}{2\pi} \int_{-\infty}^{+\infty} e^{+j\omega t} d\omega = A \delta(t) \end{aligned}$$

# CTFT of Frequency Domain Impulse

## Continuous Time Fourier Transform

$$X(j\omega) = 2\pi \delta(\omega) \iff x(t) = 1$$

$$x(t) = \frac{1}{2\pi} \int_{-\infty}^{+\infty} X(j\omega) e^{+j\omega t} d\omega$$

$$\begin{aligned} x(t) &= \frac{1}{2\pi} \int_{-\infty}^{+\infty} 2\pi \delta(\omega) e^{+j\omega t} d\omega \\ &= \int_{-\infty}^{+\infty} \delta(\omega) e^0 d\omega = 1 \end{aligned}$$

$$X(j\omega) = \int_{-\infty}^{+\infty} x(t) e^{-j\omega t} dt$$

$$X(j\omega) = \int_{-\infty}^{+\infty} e^{-j\omega t} dt = 2\pi \delta(\omega)$$

# CTFS of Impulse Train

## Continuous Time Fourier Series

$$C_n = \frac{1}{T} \int_0^T x(t) e^{-jn\omega_0 t} dt$$

$$x(t) = \sum_{n=0}^{\infty} C_n e^{+jn\omega_0 t}$$

$$p(t) = \sum_{n=-\infty}^{+\infty} \delta(t - nT_s)$$

$$\begin{aligned} C_n &= \frac{1}{T_s} \int_{-T_s/2}^{+T_s/2} \delta(t) e^{-jn\omega_s t} dt \\ &= \frac{1}{T_s} \int_{-T_s/2}^{+T_s/2} \delta(t) dt = \frac{1}{T_s} \end{aligned}$$

$$\begin{aligned} p(t) &= \sum_{n=-\infty}^{+\infty} C_n e^{jn\omega_s t} \\ &= \sum_{n=-\infty}^{+\infty} \frac{1}{T_s} e^{jn\omega_s t} \end{aligned}$$

$$p(t) = \sum_{n=-\infty}^{+\infty} \delta(t - nT_s) = \sum_{n=-\infty}^{+\infty} \frac{1}{T_s} e^{jn\omega_s t}$$

# CTFT of Impulse Train

## Continuous Time Fourier Transform

$$p(t) = \sum_{n=-\infty}^{+\infty} \delta(t - nT_s)$$

$$P(j\omega) = \int_{-\infty}^{+\infty} \sum_{n=-\infty}^{+\infty} \delta(t - nT_s) e^{-jn\omega t} dt = \int_{-\infty}^{+\infty} \sum_{n=-\infty}^{+\infty} \frac{1}{T_s} e^{jn\omega_s t} e^{-jn\omega t} dt$$

$$= \sum_{n=-\infty}^{+\infty} \frac{1}{T_s} \int_{-\infty}^{+\infty} e^{-j(\omega - n\omega_s)t} dt$$

$$= \sum_{n=-\infty}^{+\infty} \left( \frac{2\pi}{T_s} \right) \delta(\omega - n\omega_s)$$

$$X(j\omega) = \int_{-\infty}^{+\infty} x(t) e^{-j\omega t} dt$$

$$p(t) = \frac{1}{2\pi} \int_{-\infty}^{+\infty} \sum_{n=-\infty}^{+\infty} \left( \frac{2\pi}{T_s} \right) \delta(\omega - n\omega_s) e^{+j\omega t} d\omega = \sum_{n=-\infty}^{+\infty} \frac{1}{T_s} \int_{-\infty}^{+\infty} \delta(\omega - n\omega_s) e^{+j\omega t} d\omega$$

$$= \sum_{n=-\infty}^{+\infty} \frac{1}{T_s} e^{jn\omega_s t} = \sum_{n=-\infty}^{+\infty} \delta(t - nT_s)$$

$$x(t) = \frac{1}{2\pi} \int_{-\infty}^{+\infty} X(j\omega) e^{+j\omega t} d\omega$$



# Other Convention

## Continuous Time Fourier Transform {unitary, angular frequency}

$$X(j\omega) = \frac{1}{\sqrt{2\pi}} \int_{-\infty}^{+\infty} x(t) e^{-j\omega t} dt \quad \longleftrightarrow$$

$$x(t) = \frac{1}{\sqrt{2\pi}} \int_{-\infty}^{+\infty} X(j\omega) e^{+j\omega t} d\omega$$

## Continuous Time Fourier Transform {non-unitary, angular frequency}

$$X(j\omega) = 1 \cdot \int_{-\infty}^{+\infty} x(t) e^{-j\omega t} dt \quad \longleftrightarrow$$

$$x(t) = \frac{1}{2\pi} \int_{-\infty}^{+\infty} X(j\omega) e^{+j\omega t} d\omega$$

# CTFT of Impulse

$$X(j\omega) = \int_{-\infty}^{+\infty} x(t) e^{-j\omega t} dt \quad \longleftrightarrow \quad x(t) = \frac{1}{2\pi} \int_{-\infty}^{+\infty} X(j\omega) e^{+j\omega t} d\omega$$

$$x(t) = A\delta(t)$$

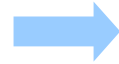
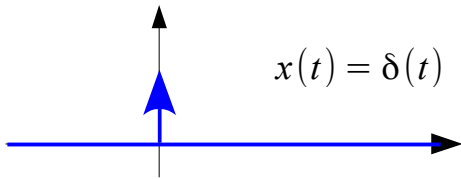

$$\begin{aligned} X(j\omega) &= \int_{-\infty}^{+\infty} \delta(t) e^{-j\omega t} dt \\ &= \int_{-\infty}^{+\infty} \delta(t) e^{-j\omega \cdot 0} dt \\ &= \int_{-\infty}^{+\infty} \delta(t) dt = 1 \end{aligned}$$

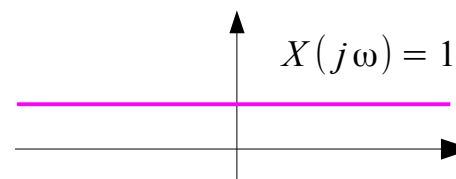

$$\begin{aligned} x(t) &= \frac{1}{2\pi} \int_{-\infty}^{+\infty} 2\pi \delta(\omega) e^{+j\omega t} d\omega \\ &= \int_{-\infty}^{+\infty} \delta(\omega) e^{+j\omega t} d\omega \\ &= \int_{-\infty}^{+\infty} \delta(\omega) d\omega = 1 \end{aligned}$$

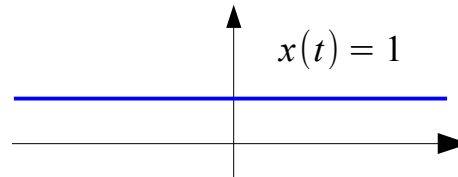

$$X(j\omega) = 2\pi\delta(\omega)$$

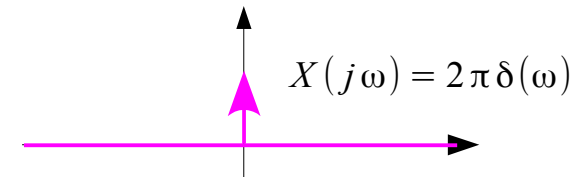

# CTFT of Sinusoid

$$X(j\omega) = \int_{-\infty}^{+\infty} x(t) e^{-j\omega t} dt \quad \longleftrightarrow \quad x(t) = \frac{1}{2\pi} \int_{-\infty}^{+\infty} X(j\omega) e^{+j\omega t} d\omega$$

$$\begin{aligned} x(t) &= \frac{1}{2\pi} \int_{-\infty}^{+\infty} 2\pi \delta(\omega - \omega_0) e^{+j\omega t} d\omega \\ &= \int_{-\infty}^{+\infty} \delta(\omega - \omega_0) e^{+j\omega_0 t} d\omega \\ &= e^{+j\omega_0 t} \int_{-\infty}^{+\infty} \delta(\omega) d\omega \\ &= e^{+j\omega_0 t} \\ &= \cos \omega_0 t + j \sin \omega_0 t \end{aligned}$$



$$X(j\omega) = 2\pi \delta(\omega - \omega_0)$$

$$\omega_0 = \frac{2\pi}{T_0}$$

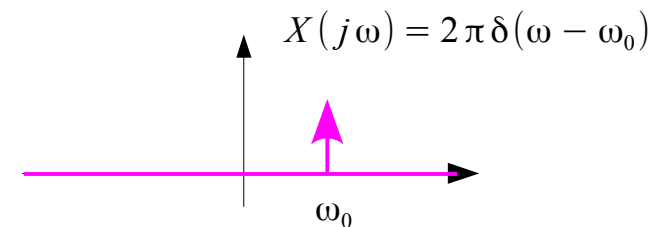
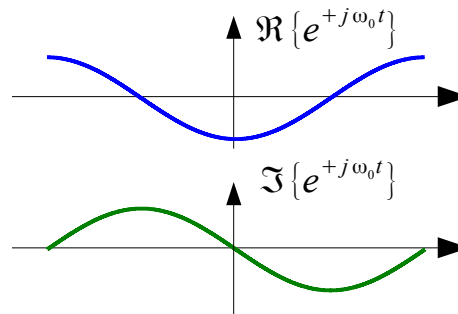

# CTFT of Periodic Signals

A general formula for the CTFT of any periodic function for which a CTFS exists

**Period**

$$T_s \rightarrow \omega_s = \frac{2\pi}{T_s}$$

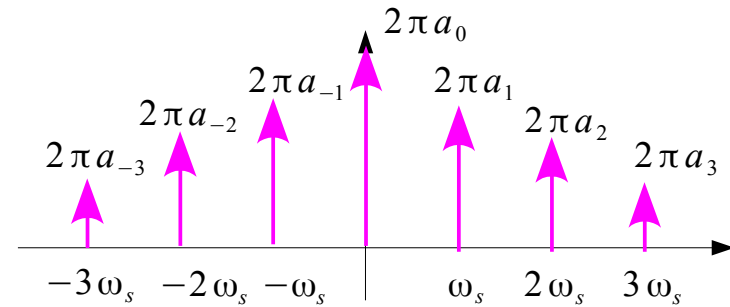

**Fourier Series Expansion**

$$x(t) = \sum_{k=-\infty}^{+\infty} a_k e^{jk\omega_s t}$$

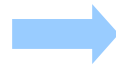

**Fourier Transform**

$$\begin{aligned} X(j\omega) &= \sum_{k=-\infty}^{\infty} a_k \int_{-\infty}^{+\infty} e^{jk\omega_s t} e^{-j\omega t} dt \\ &= \sum_{k=-\infty}^{\infty} a_k \int_{-\infty}^{+\infty} e^{-j(\omega - k\omega_s)t} dt \\ &= \sum_{k=-\infty}^{\infty} 2\pi a_k \delta(\omega - k\omega_s) \end{aligned}$$

**Fourier Series Coefficients**

$$a_k = \frac{1}{T_s} \int_{-T_s/2}^{+T_s/2} x(t) e^{-jk\omega_s t} dt$$

**Period Time Signal**

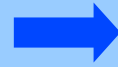

**CTFS**

**Sampling in Frequency**

# CTFT of Impulse Train

A general formula for the CTFT of any periodic function for which a CTFS exists

Period

$$T_s \rightarrow \omega_s = \frac{2\pi}{T_s}$$

Fourier Series Expansion

$$p(t) = \sum_{k=-\infty}^{+\infty} a_k e^{+jk\omega_s t}$$

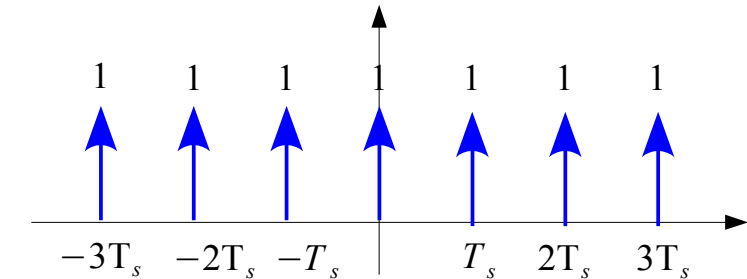
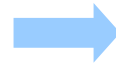

Fourier Transform

$$\begin{aligned} X(j\omega) &= \sum_{k=-\infty}^{\infty} 2\pi a_k \delta(\omega - k\omega_s) \\ &= \sum_{k=-\infty}^{\infty} \left(\frac{2\pi}{T_s}\right) \delta(\omega - k\omega_s) \end{aligned}$$

Fourier Series Coefficients

$$\begin{aligned} a_k &= \frac{1}{T_s} \int_{-T_s/2}^{+T_s/2} x(t) e^{-jk\omega_s t} dt \\ &= \frac{1}{T_s} \int_{-T_s/2}^{+T_s/2} \delta(t) dt = \frac{1}{T_s} \end{aligned}$$

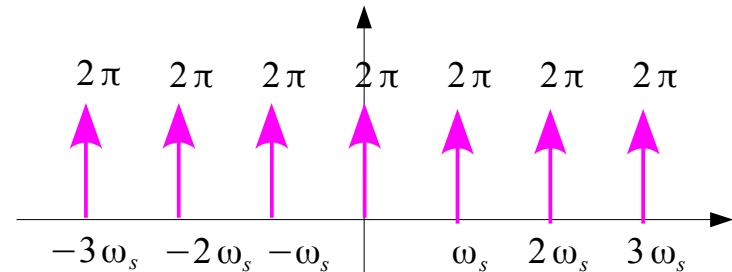

## References

- [1] <http://en.wikipedia.org/>
- [2] J.H. McClellan, et al., Signal Processing First, Pearson Prentice Hall, 2003