

Baseband (3A)

Copyright (c) 2012 Young W. Lim.

Permission is granted to copy, distribute and/or modify this document under the terms of the GNU Free Documentation License, Version 1.2 or any later version published by the Free Software Foundation; with no Invariant Sections, no Front-Cover Texts, and no Back-Cover Texts. A copy of the license is included in the section entitled "GNU Free Documentation License".

Please send corrections (or suggestions) to youngwlim@hotmail.com.

This document was produced by using OpenOffice and Octave.

Pulse & Waveform

Bit Time Slot

Codeword Time Slot

Bits / PCM Word

L : number of quantization levels $L = 2^l$

Bits / Symbol

M: size of a set of message symbols $M = 2^k$

M-ary Pulse Modulation Waveforms

PAM (Pulse Amplitude Modulation)

PPM (Pulse Position Modulation)

PDM (Pulse Duration Modulation)

PWM (Pulse Width Modulation)

M-ary Pulse Modulation M-ary alphabet set

M-ary PAM : M allowable amplitude levels are assigned to each of the M possible symbol values.

PAM

The amplitude of transmitted pulses is varied in a discrete manner in accordance with an input stream of digital data

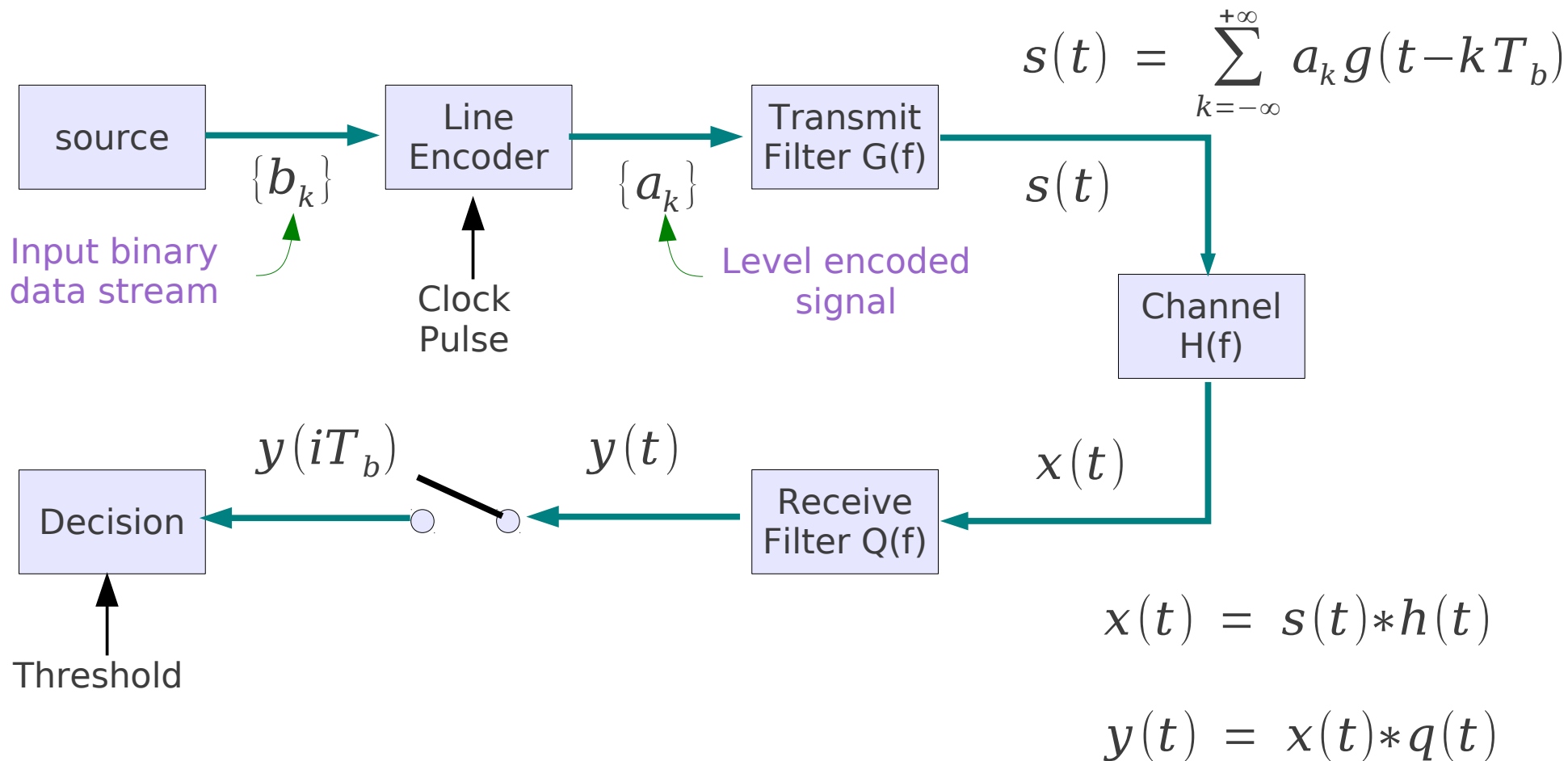

M-ary PAM

The amplitude of transmitted pulses is varied in a discrete manner in accordance with an input stream of digital data

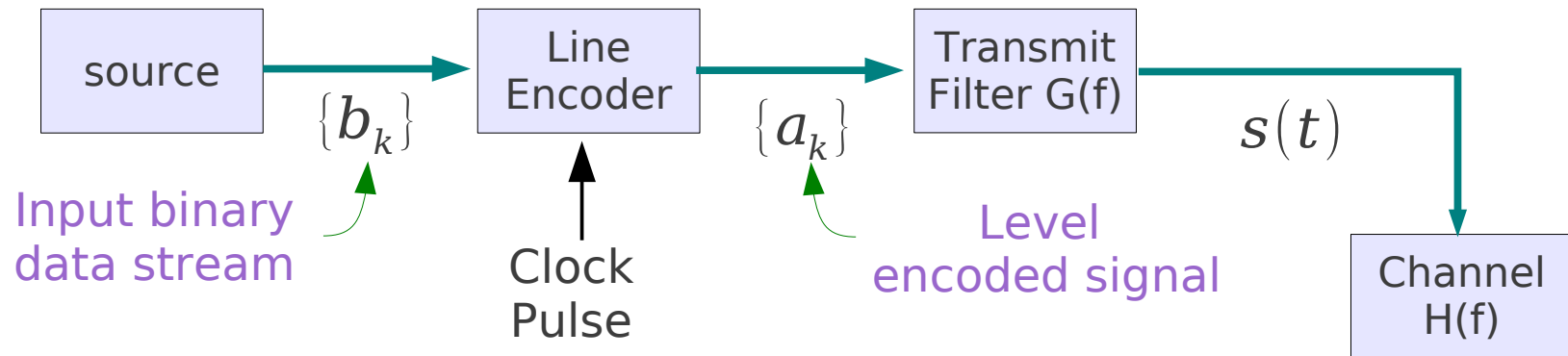

M-ary PAM Bit Rate

$$T = T_b \log_2 M$$

M possible amplitude level ($M > 2$)
M symbols
Transmits sequence of symbols

T: Symbol duration
 $1/T$: Symbol rate

Binary PAM
 T_b : Bit duration
 $1/T_b$: Bit rate

Sampling and Quantization

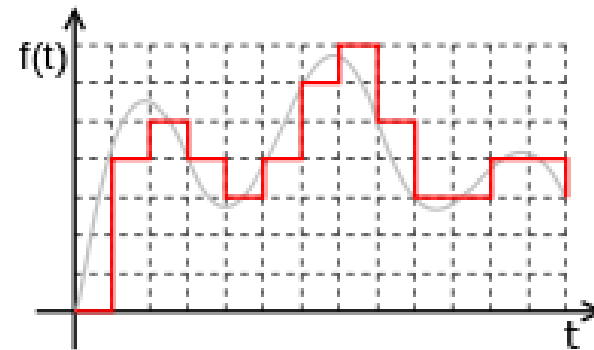
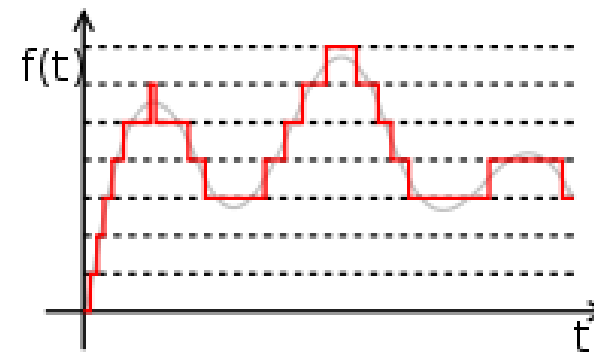
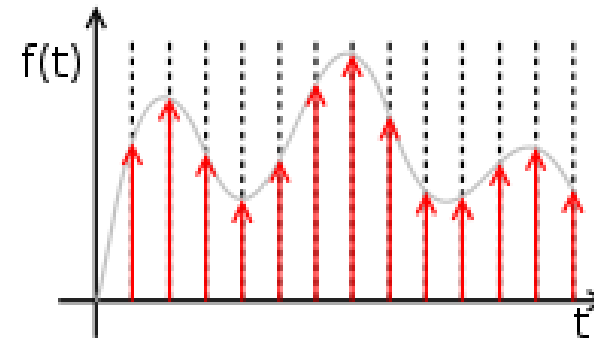
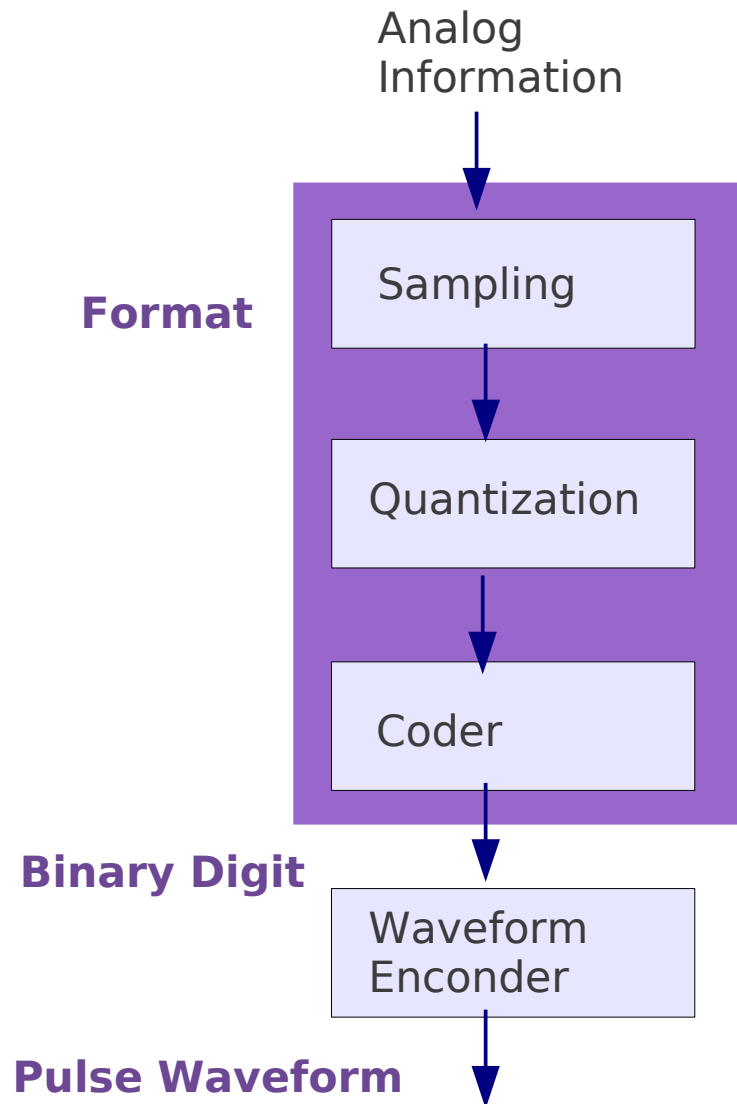

PAM (Pulse Amplitude Modulation)

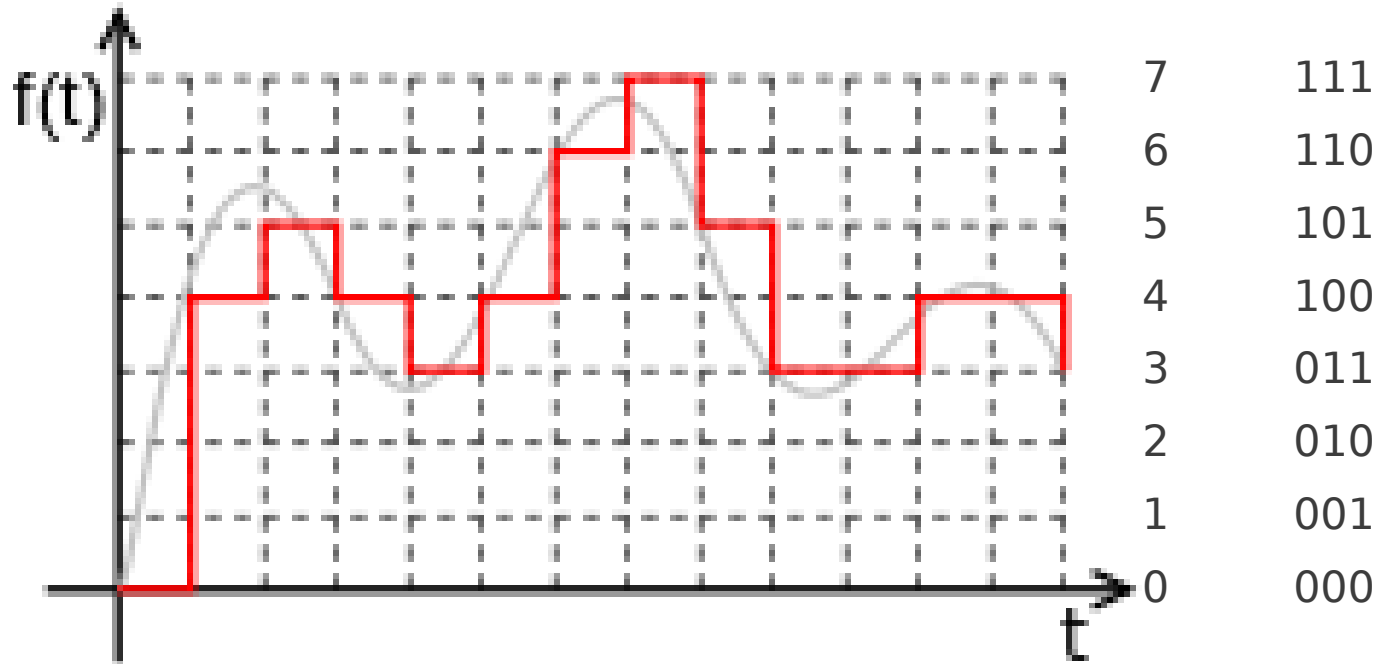

4-ary PAM

2-bit modulator

4 levels : -3, -1, +1, +3 volts

8-ary PAM

3-bit modulator

8 levels : -

PCM (Pulse Coded Modulation)

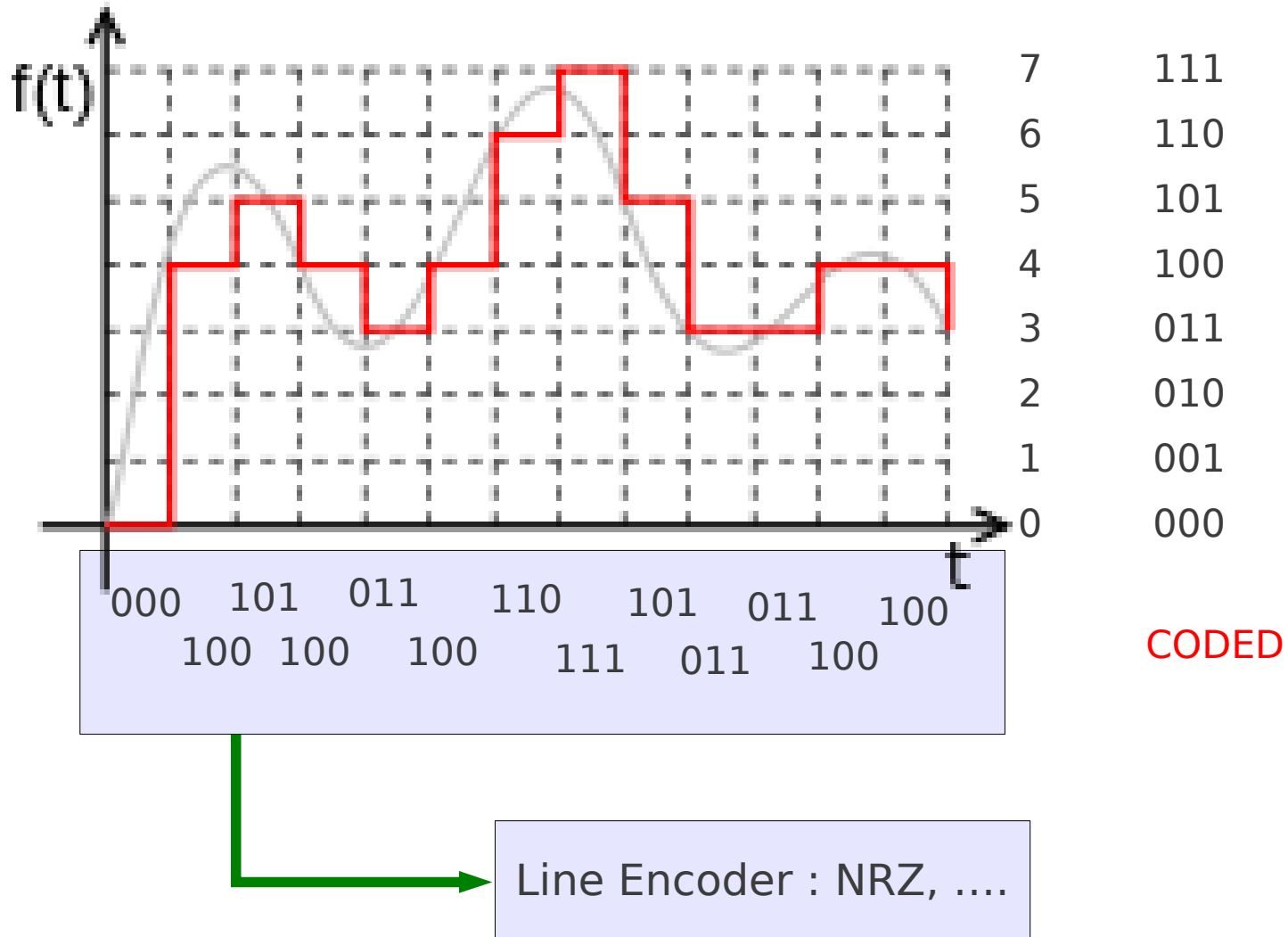

Line Encode

NRZ
RZ
...

Signal Space

Autocorrelation of Random and Power Signals

Time Averaging and Ergodicity

Autocorrelation of Random and Power Signals

Time Averaging and Ergodicity

References

- [1] <http://en.wikipedia.org/>
- [2] <http://planetmath.org/>
- [3] B. Sklar, “Digital Communications: Fundamentals and Applications”